



Command Reference



Command Reference

Note

Before using this information and the product it supports, read the general information under Appendix D, "Notices," on page 1185.

Edition Notice

This document contains proprietary information of IBM. It is provided under a license agreement and is protected by copyright law. The information contained in this publication does not include any product warranties, and any statements provided in this manual should not be interpreted as such.

You can order IBM publications online or through your local IBM representative.

- To order publications online, go to the IBM Publications Center at www.ibm.com/shop/publications/order
- To find your local IBM representative, go to the IBM Directory of Worldwide Contacts at www.ibm.com/planetwide

To order DB2 publications from DB2 Marketing and Sales in the United States or Canada, call 1-800-IBM-4YOU (426-4968).

When you send information to IBM, you grant IBM a nonexclusive right to use or distribute the information in any way it believes appropriate without incurring any obligation to you.

© Copyright International Business Machines Corporation 1993, 2009.

US Government Users Restricted Rights – Use, duplication or disclosure restricted by GSA ADP Schedule Contract with IBM Corp.

Contents

About this book	xi	Chapter 13. ATTACH	55
Who should use this book	xi	Chapter 14. AUTOCONFIGURE	57
How this book is structured	xi	Chapter 15. BACKUP DATABASE	61
Highlighting conventions.	xii	Chapter 16. BIND	71
How to read the syntax diagrams	xiii	Chapter 17. CATALOG DATABASE	91
<hr/>		Chapter 18. CATALOG DCS DATABASE	95
Part 1. Command line processor (CLP)	1	Chapter 19. CATALOG LDAP DATABASE	97
Chapter 1. Command line processor features	3	Chapter 20. CATALOG LDAP NODE	101
Chapter 2. db2 - Command line processor invocation	9	Chapter 21. CATALOG LOCAL NODE	103
Chapter 3. Command line processor options	11	Chapter 22. CATALOG NAMED PIPE NODE.	105
Chapter 4. Command line processor return codes	19	Chapter 23. CATALOG ODBC DATA SOURCE	107
Chapter 5. Invoking command help from the command line processor	21	Chapter 24. CATALOG TCPIP/TCPIP4/TCPIP6 NODE.	109
Chapter 6. Invoking message help from the command line processor	23	Chapter 25. CHANGE DATABASE COMMENT.	113
<hr/>		Chapter 26. CHANGE ISOLATION LEVEL	115
Part 2. Using command line SQL statements and XQuery statements.	25	Chapter 27. COMPLETE XMLSCHEMA	117
<hr/>		Chapter 28. CREATE DATABASE	119
Part 3. How to read command syntax help	33	Chapter 29. CREATE TOOLS CATALOG	139
<hr/>		Chapter 30. DEACTIVATE DATABASE	143
Part 4. CLP commands.	37	Chapter 31. DECOMPOSE XML DOCUMENT	145
Chapter 7. ACTIVATE DATABASE	39	Chapter 32. DECOMPOSE XML DOCUMENT	147
Chapter 8. ADD CONTACT	41		
Chapter 9. ADD CONTACTGROUP	43		
Chapter 10. ADD DBPARTITIONNUM	45		
Chapter 11. ADD XMLSCHEMA DOCUMENT	49		
Chapter 12. ARCHIVE LOG	51		

Chapter 33. DEREGISTER	149	Chapter 56. GET HEALTH NOTIFICATION CONTACT LIST	225
Chapter 34. DESCRIBE	151	Chapter 57. GET HEALTH SNAPSHOT	227
Chapter 35. DETACH	161	Chapter 58. GET INSTANCE	231
Chapter 36. DROP CONTACT.	163	Chapter 59. GET MONITOR SWITCHES	233
Chapter 37. DROP CONTACTGROUP	165	Chapter 60. GET RECOMMENDATIONS FOR HEALTH INDICATOR	237
Chapter 38. DROP DATABASE	167	Chapter 61. GET ROUTINE.	241
Chapter 39. DROP DBPARTITIONNUM VERIFY	169	Chapter 62. GET SNAPSHOT.	243
Chapter 40. DROP TOOLS CATALOG	171	Chapter 63. HELP	259
Chapter 41. ECHO	173	Chapter 64. HISTORY	261
Chapter 42. EDIT	175	Chapter 65. IMPORT	263
Chapter 43. EXPORT	177	Chapter 66. INITIALIZE TAPE.	291
Chapter 44. FORCE APPLICATION . .	187	Chapter 67. INSPECT	293
Chapter 45. GET ADMIN CONFIGURATION.	189	Chapter 68. LIST ACTIVE DATABASES	301
Chapter 46. GET ALERT CONFIGURATION.	191	Chapter 69. LIST APPLICATIONS . . .	303
Chapter 47. GET CLI CONFIGURATION	197	Chapter 70. LIST COMMAND OPTIONS	305
Chapter 48. GET CONNECTION STATE	199	Chapter 71. LIST DATABASE DIRECTORY	307
Chapter 49. GET CONTACTGROUP	201	Chapter 72. LIST DATABASE PARTITION GROUPS	311
Chapter 50. GET CONTACTGROUPS	203	Chapter 73. LIST DBPARTITIONNUMS	313
Chapter 51. GET CONTACTS	205	Chapter 74. LIST DCS APPLICATIONS	315
Chapter 52. GET DATABASE CONFIGURATION.	207	Chapter 75. LIST DCS DIRECTORY	317
Chapter 53. GET DATABASE MANAGER CONFIGURATION	213	Chapter 76. LIST DRDA INDOUBT TRANSACTIONS	319
Chapter 54. GET DATABASE MANAGER MONITOR SWITCHES . . .	219	Chapter 77. LIST HISTORY.	321
Chapter 55. GET DESCRIPTION FOR HEALTH INDICATOR	223	Chapter 78. LIST INDOUBT TRANSACTIONS	325

Chapter 79. LIST NODE DIRECTORY	329	Chapter 103. REORG INDEXES/TABLE	483
Chapter 80. LIST ODBC DATA SOURCES	333	Chapter 104. REORGCHK	497
Chapter 81. LIST PACKAGES/TABLES	335	Chapter 105. RESET ADMIN CONFIGURATION.	507
Chapter 82. LIST TABLESPACE CONTAINERS	339	Chapter 106. RESET ALERT CONFIGURATION.	509
Chapter 83. LIST TABLESPACES . . .	341	Chapter 107. RESET DATABASE CONFIGURATION.	511
Chapter 84. LIST UTILITIES	355	Chapter 108. RESET DATABASE MANAGER CONFIGURATION	513
Chapter 85. LOAD	357	Chapter 109. RESET MONITOR.	515
Chapter 86. LOAD QUERY	399	Chapter 110. RESTART DATABASE	517
Chapter 87. UPGRADE DATABASE	405	Chapter 111. RESTORE DATABASE	519
Chapter 88. PING	407	Chapter 112. REWIND TAPE	537
Chapter 89. PRECOMPILE	409	Chapter 113. ROLLFORWARD DATABASE	539
Chapter 90. PRUNE HISTORY/LOGFILE	435	Chapter 114. RUNCMD	549
Chapter 91. PUT ROUTINE.	437	Chapter 115. RUNSTATS.	551
Chapter 92. QUERY CLIENT	439	Chapter 116. SET CLIENT	567
Chapter 93. QUIESCE	441	Chapter 117. SET RUNTIME DEGREE	571
Chapter 94. QUIESCE TABLESPACES FOR TABLE	445	Chapter 118. SET SERVEROUTPUT command	573
Chapter 95. QUIT	449	Chapter 119. SET TABLESPACE CONTAINERS	575
Chapter 96. REBIND	451	Chapter 120. SET TAPE POSITION	579
Chapter 97. RECOVER DATABASE	455	Chapter 121. SET UTIL_IMPACT_PRIORITY	581
Chapter 98. REDISTRIBUTE DATABASE PARTITION GROUP . . .	461	Chapter 122. SET WORKLOAD command	583
Chapter 99. REFRESH LDAP	473	Chapter 123. SET WRITE	585
Chapter 100. REGISTER	475	Chapter 124. START DATABASE MANAGER	587
Chapter 101. REGISTER XMLSCHEMA	479		
Chapter 102. REGISTER XSROBJECT	481		

Chapter 125. START HADR	595	Chapter 145. UPDATE DATABASE CONFIGURATION.	643
Chapter 126. STOP DATABASE MANAGER	597	Chapter 146. UPDATE DATABASE MANAGER CONFIGURATION	647
Chapter 127. STOP HADR	601	Chapter 147. UPDATE HEALTH NOTIFICATION CONTACT LIST	649
Chapter 128. TAKEOVER HADR	603	Chapter 148. UPDATE HISTORY	651
Chapter 129. TERMINATE	607	Chapter 149. UPDATE LDAP NODE	653
Chapter 130. UNCATALOG DATABASE	609	Chapter 150. UPDATE MONITOR SWITCHES	655
Chapter 131. UNCATALOG DCS DATABASE	611	Chapter 151. UPDATE XMLSCHEMA	657
Chapter 132. UNCATALOG LDAP DATABASE	613	<hr/>	
Chapter 133. UNCATALOG LDAP NODE.	615	Part 5. System commands	659
Chapter 134. UNCATALOG NODE	617	Chapter 152. dasauto - Autostart DB2 administration server	661
Chapter 135. UNCATALOG ODBC DATA SOURCE.	619	Chapter 153. dasCRT - Create a DB2 administration server	663
Chapter 136. UNQUIESCE	621	Chapter 154. dasDROP - Remove a DB2 administration server	665
Chapter 137. UPDATE ADMIN CONFIGURATION.	623	Chapter 155. dasMIGR - Migrate the DB2 administration server	667
Chapter 138. UPDATE ALERT CONFIGURATION.	625	Chapter 156. dasUPDT - Update DAS	669
Chapter 139. UPDATE ALTERNATE SERVER FOR DATABASE	631	Chapter 157. db2_deinstall - Uninstall DB2 products, features, or languages	671
Chapter 140. UPDATE ALTERNATE SERVER FOR LDAP DATABASE	633	Chapter 158. db2_install - Install DB2 product	675
Chapter 141. UPDATE CLI CONFIGURATION.	635	Chapter 159. db2_local_ps - DB2 process status for Linux/UNIX	679
Chapter 142. UPDATE COMMAND OPTIONS	637	Chapter 160. db2addicons - Create main menu entries for DB2 tools command	681
Chapter 143. UPDATE CONTACT	639	Chapter 161. db2admin - DB2 administration server	683
Chapter 144. UPDATE CONTACTGROUP	641	Chapter 162. db2adutl - Managing DB2 objects within TSM	685

Chapter 163. db2advis - DB2 design advisor	693	Chapter 180. db2cmd - Open DB2 command window	755
Chapter 164. db2audit - Audit facility administrator tool	701	Chapter 181. db2cptsa - Install or update DB2 HA scripts command. . .	757
Chapter 165. db2batch - Benchmark tool.	711	Chapter 182. db2dart - Database analysis and reporting tool	759
Chapter 166. db2acsutil - Manage DB2 snapshot backup objects command .	721	Chapter 183. db2daslevel - Show DAS level	765
Chapter 167. db2bfd - Bind file description tool	725	Chapter 184. db2dclgn - Declaration generator	767
Chapter 168. db2ca - Start the Configuration Assistant	727	Chapter 185. db2diag - db2diag logs analysis tool.	771
Chapter 169. db2cap - CLI/ODBC static package binding tool	729	Chapter 186. db2drdat - DRDA trace	785
Chapter 170. db2cat - System catalog analysis.	731	Chapter 187. db2drvmp - DB2 database drive map.	787
Chapter 171. db2cc - Start control center	733	Chapter 188. db2empfa - Enable multipage file allocation.	789
Chapter 172. db2cfexp - Connectivity configuration export tool	735	Chapter 189. db2envar.bat - Set environment of the current command window	791
Chapter 173. db2cfimp - Connectivity configuration import tool	737	Chapter 190. db2eva - Event analyzer	793
Chapter 174. db2chglbpath - Modify the embedded runtime library search path	739	Chapter 191. db2evmon - Event monitor productivity tool	795
Chapter 175. db2chgpath - Change embedded runtime path	741	Chapter 192. db2evtbl - Generate event monitor target table definitions .	797
Chapter 176. db2ckbkp - Check backup	743	Chapter 193. db2exfmt - Explain table format	799
Chapter 177. db2ckupgrade - Check database for upgrade	747	Chapter 194. db2exmig - Migrate explain tables	803
Chapter 178. db2ckrst - Check incremental restore image sequence .	751	Chapter 195. db2expln - SQL and XQuery Explain	805
Chapter 179. db2cli - DB2 interactive CLI.	753	Chapter 196. db2extsec - Set permissions for DB2 objects.	815
		Chapter 197. db2flsn - Find log sequence number	817

Chapter 198. db2fm - DB2 fault monitor	819	Chapter 217. db2isetup - Start instance creation interface	871
Chapter 199. db2fmcu - DB2 fault monitor controller command.	821	Chapter 218. db2iupdt - Update instances	873
Chapter 200. db2fodc - DB2 first occurrence data collection command .	823	Chapter 219. db2jdbcbind - DB2 JDBC package binder	877
Chapter 201. db2fs - First steps . . .	829	Chapter 220. db2ldcfg - Configure LDAP environment	879
Chapter 202. db2gcf - Control DB2 instance	831	Chapter 221. db2level - Show DB2 service level.	881
Chapter 203. db2gov - DB2 governor	835	Chapter 222. db2licm - License management tool.	883
Chapter 204. db2govlg - DB2 governor log query	837	Chapter 223. db2listvolumes - Display GUIDs for all disk volumes	885
Chapter 205. db2gpm - Get distribution map	839	Chapter 224. db2logsforrwd - List logs required for rollforward recovery.	887
Chapter 206. db2hc - Start health center	841	Chapter 225. db2look - DB2 statistics and DDL extraction tool	889
Chapter 207. db2iauto - Auto-start instance	843	Chapter 226. db2ls - List installed DB2 products and features	899
Chapter 208. db2iclus - Microsoft cluster server	845	Chapter 227. db2move - Database movement tool.	903
Chapter 209. db2icrt - Create instance	849	Chapter 228. db2mqdsn - MQ listener	913
Chapter 210. db2idrop - Remove instance	853	Chapter 229. db2mscs - Set up Windows failover utility	917
Chapter 211. db2identifyType1 - Type-1 index identification tool.	855	Chapter 230. db2mtrk - Memory tracker	921
Chapter 212. db2ilist - List instances	859	Chapter 231. db2nchg - Change database partition server configuration	925
Chapter 213. db2iupgrade - Upgrade instance	861	Chapter 232. db2ncrt - Add database partition server to an instance	927
Chapter 214. db2inidb - Initialize a mirrored database	865	Chapter 233. db2ndrop - Drop database partition server from an instance	929
Chapter 215. db2inspf - Format inspect results	867		
Chapter 216. db2iprune - Reduce installation image size command . . .	869		

Chapter 234. db2nrcfg - Non-root install configuration tool command	931	Chapter 250. db2schex - Active Directory schema extension command	1039
Chapter 235. db2rfe - Enable root features for non-root install command	933	Chapter 251. db2set - DB2 profile registry	1041
Chapter 236. db2nrupdt - Non-root-installed instance update command	935	Chapter 252. db2setup - Install DB2	1045
Chapter 237. db2nrupgrade - Upgrade non-root instance command	937	Chapter 253. db2sqljbind - SQLJ profile binder	1047
Chapter 238. db2osconf - Utility for kernel parameter values.	939	Chapter 254. db2sqljcustomize - SQLJ profile customizer	1053
Chapter 239. db2pd - Monitor and troubleshoot DB2 database	943	Chapter 255. db2sqljprint - SQLJ profile printer	1065
Chapter 240. db2pdcfg - Configure DB2 database for problem determination behavior.	1009	Chapter 256. db2start - Start DB2	1067
Chapter 241. db2perfc - Reset database performance values	1015	Chapter 257. db2stat - DB2 process status for Windows	1069
Chapter 242. db2perfi - Performance counters registration utility	1017	Chapter 258. db2stop - Stop DB2	1071
Chapter 243. db2perfr - Performance monitor registration tool	1019	Chapter 259. db2support - Problem analysis and environment collection tool	1073
Chapter 244. db2rbind - Rebind all packages.	1021	Chapter 260. db2swtch - Switch default DB2 copy and database client interface copy	1079
Chapter 245. db2relocatedb - Relocate database.	1023	Chapter 261. db2sync - Start DB2 synchronizer	1081
Chapter 246. db2rfpen - Reset rollforward pending state.	1029	Chapter 262. db2systray - Start DB2 system tray.	1083
Chapter 247. db2rmicons - Remove DB2 tools from main menu command	1031	Chapter 263. db2tapemgr - Manage log files on tape.	1085
Chapter 248. db2rspgn - Response file generator	1033	Chapter 264. db2tbst - Get table space state.	1089
Chapter 249. db2sampl - Create sample database	1035	Chapter 265. db2tdbmgr - Migrate tools catalog database command	1091
		Chapter 266. db2trc - Trace	1093
		Chapter 267. db2unins - Uninstall DB2 database products, features, or languages	1101

Chapter 268. db2untag - Release container tag	1103
Chapter 269. db2updserv - Show product updates.	1105
Chapter 270. db2val - DB2 copy validation tool command	1107
Chapter 271. db2xdbmig - Migrate XSR objects command	1109
Chapter 272. db2xpvt - Format trap file.	1111
Chapter 273. disable_MQFunctions - Disable WebSphere MQ functions command	1113
Chapter 274. doce_deinstall - Uninstall DB2 Information Center . .	1115
Chapter 275. doce_install - Install DB2 Information Center	1117
Chapter 276. enable_MQFunctions - Enable WebSphere MQ functions command	1119
Chapter 277. installFixPack - Update installed DB2 products.	1123
Chapter 278. setup - Install DB2 . . .	1127
Chapter 279. sqlj - SQLJ translator	1129
<hr/>	
Part 6. DB2 Text Search commands	1133
Chapter 280. db2ts ALTER INDEX	1135
Chapter 281. db2ts CLEANUP FOR TEXT	1139
Chapter 282. db2ts CLEAR COMMAND LOCKS	1141
Chapter 283. db2ts CLEAR EVENTS FOR INDEX	1143

Chapter 284. db2ts CREATE INDEX	1145
Chapter 285. db2ts DISABLE DATABASE FOR TEXT	1151
Chapter 286. db2ts DROP INDEX	1155
Chapter 287. db2ts ENABLE DATABASE FOR TEXT	1157
Chapter 288. db2ts HELP	1159
Chapter 289. db2ts START FOR TEXT	1161
Chapter 290. db2ts STOP FOR TEXT	1163
Chapter 291. db2ts UPDATE INDEX	1165
<hr/>	
Part 7. Appendixes	1169
Appendix A. Naming conventions	1171
Naming conventions	1171
Appendix B. File type modifiers and delimiters	1173
File type modifiers for the export, import and load utilities	1173
Delimiter considerations for moving data.	1173
Appendix C. Overview of the DB2 technical information	1175
DB2 technical library in hardcopy or PDF format	1175
Ordering printed DB2 books	1178
Displaying SQL state help from the command line processor	1179
Accessing different versions of the DB2 Information Center	1179
Displaying topics in your preferred language in the DB2 Information Center	1179
Updating the DB2 Information Center installed on your computer or intranet server	1180
Manually updating the DB2 Information Center installed on your computer or intranet server . .	1181
DB2 tutorials	1183
DB2 troubleshooting information	1183
Terms and Conditions	1184
Appendix D. Notices	1185
Index	1189

About this book

This book provides information about the use of system commands and the IBM® DB2® command line processor (CLP) to execute database administrative functions.

Who should use this book

It is assumed that the reader has an understanding of database administration and a knowledge of Structured Query Language (SQL).

How this book is structured

This book provides the reference information needed to use the CLP, system, and DB2 Text Search commands.

The major subject areas discussed in the chapters of this book are as follows:

Using the command line processor (CLP)

- Chapter 1, “Command line processor (CLP),” explains how to invoke and use the command line processor, and describes the CLP options.
- Chapter 2, “Using command line SQL statements and XQuery statements,” provides information on how to use SQL statements from the command line.

Command usage help

- Chapter 3, “How to read command help screens,” describes how to invoke command help screens and explains the command help screen syntax conventions that are employed.

CLP commands

- Chapter 4, “CLP commands,” describes all of the database manager commands, listed alphabetically.

System commands

- Chapter 5, “System commands,” describes all of the commands, listed alphabetically, that can be entered at an operating system command prompt or in a shell script to access the database manager.

DB2 Text Search commands

- Chapter 6, “DB2 Text Search commands,” describes all of the Text Search commands, listed alphabetically, that can be entered at an operating system command prompt prefixed with db2ts.

Appendixes

- Appendix A, “Naming conventions,” describes the conventions used to name objects such as databases and tables.
- Appendix B, “File type modifiers and delimiters,” describes the file type modifiers for the load, import and export utilities. In addition, delimiter considerations for moving data is also presented.

Highlighting conventions

The following highlighting conventions are used in this book.

Bold	Indicates commands, keywords, and other items whose names are predefined by the system. Commands written in uppercase are CLP commands, whereas commands written in lowercase are system commands.
<i>Italics</i>	Indicates one of the following: <ul style="list-style-type: none">• Names or values (variables) that must be supplied by the user• General emphasis• The introduction of a new term• A reference to another source of information
Monospace	Indicates one of the following: <ul style="list-style-type: none">• Files and directories• Information that you are instructed to type at a command prompt or in a window• Examples of specific data values• Examples of text similar to what might be displayed by the system• Examples of system messages• Samples of programming code

How to read the syntax diagrams

SQL syntax is described using the structure defined as follows:

Read the syntax diagrams from left to right and top to bottom, following the path of the line.

The \blacktriangleright — symbol indicates the beginning of a syntax diagram.

The — \blacktriangleright symbol indicates that the syntax is continued on the next line.

The \blacktriangleright — symbol indicates that the syntax is continued from the previous line.

The — \blacktriangleleft symbol indicates the end of a syntax diagram.

Syntax fragments start with the |— symbol and end with the —| symbol.

Required items appear on the horizontal line (the main path).



Optional items appear below the main path.

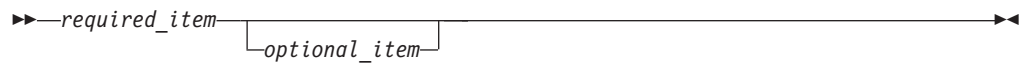

If an optional item appears above the main path, that item has no effect on execution, and is used only for readability.

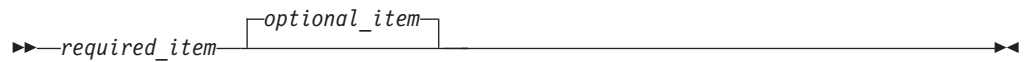

If you can choose from two or more items, they appear in a stack.

If you *must* choose one of the items, one item of the stack appears on the main path.

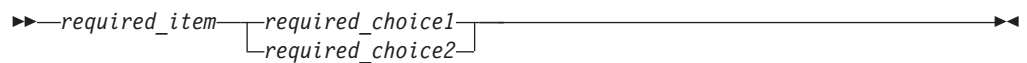

If choosing one of the items is optional, the entire stack appears below the main path.

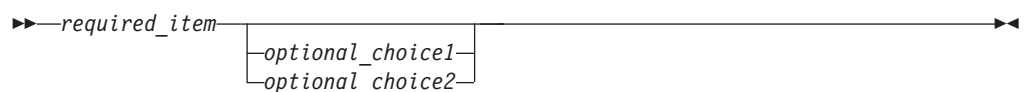

If one of the items is the default, it will appear above the main path, and the remaining choices will be shown below.

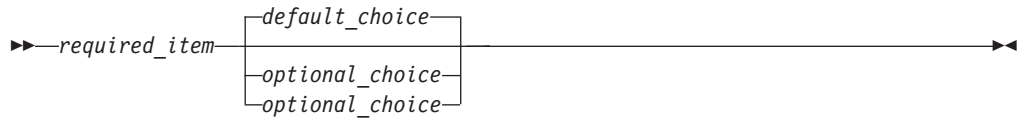

An arrow returning to the left, above the main line, indicates an item that can be repeated. In this case, repeated items must be separated by one or more blanks.



If the repeat arrow contains a comma, you must separate repeated items with a comma.



A repeat arrow above a stack indicates that you can make more than one choice from the stacked items or repeat a single choice.

Keywords appear in uppercase (for example, FROM). They must be spelled exactly as shown. Variables appear in lowercase (for example, column-name). They represent user-supplied names or values in the syntax.

If punctuation marks, parentheses, arithmetic operators, or other such symbols are shown, you must enter them as part of the syntax.

Sometimes a single variable represents a larger fragment of the syntax. For example, in the following diagram, the variable `parameter-block` represents the whole syntax fragment that is labeled **parameter-block**:



parameter-block:

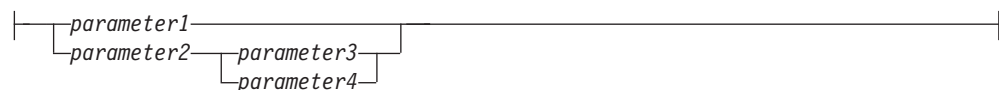

Adjacent segments occurring between “large bullets” (●) may be specified in any sequence.



The above diagram shows that item2 and item3 may be specified in either order.
Both of the following are valid:

```
required_item item1 item2 item3 item4  
required_item item1 item3 item2 item4
```

Part 1. Command line processor (CLP)

Chapter 1. Command line processor features

The command line processor operates as follows:

- The CLP command (in either case) is typed at the command prompt.
- The command is sent to the command shell by pressing the ENTER key.
- Output is automatically directed to the standard output device.
- Piping and redirection are supported.
- The user is notified of successful and unsuccessful completion.
- Following execution of the command, control returns to the operating system command prompt, and the user can enter more commands.
- When the CLP is called with a file input option, it will automatically set the CLIENT APPLNAME special register to CLP *filename*.

You can start the command line processor by either:

- typing the db2 command, or,
- on Linux[®] operating systems, click **Main Menu** and, select **IBM DB2 → Command Line Processor**.

Certain CLP commands and SQL statements require that the server instance is running and a database connection exists. Connect to a database by doing one of the following:

- Issue the SQL statement:
`db2 connect to database`
- Establish an implicit connection to the default database defined by the DB2 registry variable **DB2DBDFT**.

If a command exceeds the character limit allowed at the command prompt, a backslash (\) can be used as the line continuation character. When the command line processor encounters the line continuation character, it reads the next line and concatenates the characters contained on both lines. Alternatively, the **-t** option can be used to set a different line termination character.

The command line processor recognizes a string called NULL as a null string. Fields that have been set previously to some value can later be set to NULL. For example,

```
db2 update database manager configuration using tm_database NULL
```

sets the **tm_database** field to NULL. This operation is case sensitive. A lowercase null is not interpreted as a null string, but rather as a string containing the letters null.

Customizing the Command Line Processor

It is possible to customize the interactive input prompt by using the **DB2_CLPPROMPT** registry variable. This registry variable can be set to any text string of maximum length 100 and can contain the tokens %i, %ia, %d, %da and %n. Specific values will be substituted for these tokens at run-time.

Table 1. DB2_CLPPROMPT tokens and run-time values

DB2_CLPPROMPT token	Value at run-time
%ia	Authorization ID of the current instance attachment
%i	Local alias of the currently attached instance. If no instance attachment exists, the value of the DB2INSTANCE registry variable. On Windows® platforms only, if the DB2INSTANCE registry variable is not set, the value of the DB2INSTDEF registry variable.
%da	Authorization ID of the current database connection
%d	Local alias of the currently connected database. If no database connection exists, the value of the DB2DBDFT registry variable.
%n	New line

- If any token has no associated value at runtime, the empty string is substituted for that token.
- The interactive input prompt will always present the authorization IDs, database names, and instance names in uppercase, so as to be consistent with the connection and attachment information displayed at the prompt.
- If the **DB2_CLPPROMPT** registry variable is changed within CLP interactive mode, the new value of **DB2_CLPPROMPT** will not take effect until CLP interactive mode has been closed and reopened.

You can specify the number of commands to be stored in the command history by using the **DB2_CLPHISTSZ** registry variable. The **HISTORY** command lets you access the contents of the command history that you run within a CLP interactive mode session.

You can also specify the editor that is opened when you issue the **EDIT** command by using the **DB2_CLP_EDITOR** registry variable. From a CLP interactive session, the **EDIT** command opens an editor preloaded with a user-specified command which can then be edited and run.

Examples

If **DB2_CLPPROMPT** is defined as (%ia@%i, %da@d), the input prompt will have the following values:

- No instance attachment and no database connection. **DB2INSTANCE** set to DB2. **DB2DBDFT** is not set.
(@DB2, @)
- (Windows) No instance attachment and no database connection. **DB2INSTANCE** and **DB2DBDFT** not set. **DB2INSTDEF** set to DB2.
(@DB2, @)
- No instance attachment and no database connection. **DB2INSTANCE** set to DB2. **DB2DBDFT** set to "SAMPLE".
(@DB2, @SAMPLE)
- Instance attachment to instance "DB2" with authorization ID "keon14". **DB2INSTANCE** set to DB2. **DB2DBDFT** set to "SAMPLE".
(KEON14@DB2, @SAMPLE)
- Database connection to database "sample" with authorization ID "horton7". **DB2INSTANCE** set to DB2. **DB2DBDFT** set to SAMPLE.
(@DB2, HORTON7@SAMPLE)

- Instance attachment to instance "DB2" with authorization ID "keon14". Database connection to database "sample" with authorization ID "horton7".
DB2INSTANCE set to DB2. DB2DBDFT not set.
(KEON14@DB2, HORTON7@SAMPLE)

Using the Command Line Processor in command files

CLP requests to the database manager can be imbedded in a shell script command file. The following example shows how to enter the CREATE TABLE statement in a shell script command file:

```
db2 "create table mytable (name VARCHAR(20), color CHAR(10))"
```

For more information about commands and command files, see the appropriate operating system manual.

Command Line Processor design

The command line processor consists of two processes: the front-end process (the DB2 command), which acts as the user interface, and the back-end process (db2bp), which maintains a database connection.

Maintaining database connections

Each time that db2 is invoked, a new front-end process is started. The back-end process is started by the first db2 invocation, and can be explicitly terminated with TERMINATE. All front-end processes with the same parent are serviced by a single back-end process, and therefore share a single database connection.

For example, the following db2 calls from the same operating system command prompt result in separate front-end processes sharing a single back-end process, which holds a database connection throughout:

- db2 'connect to sample',
- db2 'select * from org',
- . foo (where foo is a shell script containing DB2 commands), and
- db2 -tf myfile.clp

The following invocations from the same operating system prompt result in separate database connections because each has a distinct parent process, and therefore a distinct back-end process:

- foo
- . foo &
- foo &
- sh foo

Communication between front-end and back-end processes

The front-end process and back-end processes communicate through three message queues: a request queue, an input queue, and an output queue.

Environment variables

The following environment variables offer a means of configuring communication between the two processes:

Table 2. Environment Variables

Variable	Minimum	Maximum	Default
DB2BQTIME	1 second	5294967295	1 second
DB2BQTRY	0 tries	5294967295	60 tries
DB2RQTIME	1 second	5294967295	5 seconds
DB2IQTIME	1 second	5294967295	5 seconds

DB2BQTIME

When the command line processor is invoked, the front-end process checks if the back-end process is already active. If it is active, the front-end process reestablishes a connection to it. If it is not active, the front-end process activates it. The front-end process then idles for the duration specified by the **DB2BQTIME** variable, and checks again. The front-end process continues to check for the number of times specified by the **DB2BQTRY** variable, after which, if the back-end process is still not active, it times out and returns an error message.

DB2BQTRY

Works in conjunction with the **DB2BQTIME** variable, and specifies the number of times the front-end process tries to determine whether the back-end process is active.

The values of **DB2BQTIME** and **DB2BQTRY** can be increased during peak periods to optimize query time.

DB2RQTIME

Once the back-end process has been started, it waits on its request queue for a request from the front-end. It also waits on the request queue between requests initiated from the command prompt.

The **DB2RQTIME** variable specifies the length of time the back-end process waits for a request from the front-end process. At the end of this time, if no request is present on the request queue, the back-end process checks whether the parent of the front-end process still exists, and terminates itself if it does not exist. Otherwise, it continues to wait on the request queue.

DB2IQTIME

When the back-end process receives a request from the front-end process, it sends an acknowledgment to the front-end process indicating that it is ready to receive input via the input queue. The back-end process then waits on its input queue. It also waits on the input queue while a batch file (specified with the **-f** option) is executing, and while the user is in interactive mode.

The **DB2IQTIME** variable specifies the length of time the back-end process waits on the input queue for the front-end process to pass the commands. After this time has elapsed, the back-end process checks whether the front-end process is active, and returns to wait on the request queue if the front-end process no longer exists. Otherwise, the back-end process continues to wait for input from the front-end process.

To view the values of these environment variables, use **LIST COMMAND OPTIONS**.

The back-end environment variables inherit the values set by the front-end process at the time the back-end process is initiated. However, if the front-end environment

variables are changed, the back-end process will not inherit these changes. The back-end process must first be terminated, and then restarted (by issuing the db2 command) to inherit the changed values.

An example of when the back-end process must be terminated is provided by the following scenario:

1. User A logs on, issues some CLP commands, and then logs off without issuing TERMINATE.
2. User B logs on using the same window.
3. When user B issues certain CLP commands, they fail with message DB21016 (system error).

The back-end process started by user A is still active when user B starts using the CLP, because the parent of user B's front-end process (the operating system window from which the commands are issued) is still active. The back-end process attempts to service the new commands issued by user B; however, user B's front-end process does not have enough authority to use the message queues of the back-end process, because it needs the authority of user A, who created that back-end process. A CLP session must end with a TERMINATE command before a user starts a new CLP session using the same operating system window. This creates a fresh back-end process for each new user, preventing authority problems, and setting the correct values of environment variables (such as **DB2INSTANCE**) in the new user's back-end process.

CLP usage notes

Commands can be entered either in uppercase or in lowercase from the command prompt. However, parameters that are case sensitive to DB2 must be entered in the exact case desired. For example, the *comment-string* in the **WITH** clause of the CHANGE DATABASE COMMENT command is a case sensitive parameter.

Delimited identifiers are allowed in SQL statements.

Special characters, or metacharacters (such as \$ & * () ; < > ? \ ' ") are allowed within CLP commands. If they are used outside the CLP interactive mode, or the CLP batch input mode, these characters are interpreted by the operating system shell. Quotation marks or an escape character are required if the shell is not to take any special action.

For example, when executed inside an AIX[®] Korn shell environment,

```
db2 select * from org where division > 'Eastern'
```

is interpreted as "select <the names of all files> from org where division". The result, an SQL syntax error, is redirected to the file Eastern. The following syntax produces the correct output:

```
db2 "select * from org where division > 'Eastern'"
```

Special characters vary from platform to platform. In the AIX Korn shell, the above example could be rewritten using an escape character (\), such as *, \>, or \'.

Most operating system environments allow input and output to be redirected. For example, if a connection to the SAMPLE database has been made, the following request queries the STAFF table, and sends the output to a file named staflist.txt in the mydata directory:

```
db2 "select * from staff" > mydata/staflist.txt
```

For environments where output redirection is not supported, CLP options can be used. For example, the request can be rewritten as

```
db2 -r mydata\staflist.txt "select * from staff"
```

```
db2 -z mydata\staflist.txt "select * from staff"
```

The command line processor is not a programming language. For example, it does not support host variables, and the statement,

```
db2 connect to :HostVar in share mode
```

is syntactically incorrect, because `:HostVar` is not a valid database name.

The command line processor represents SQL NULL values as hyphens (-). If the column is numeric, the hyphen is placed at the right of the column. If the column is not numeric, the hyphen is at the left.

To correctly display the national characters for single byte (SBCS) languages from the DB2 command line processor window, a True Type font must be selected. For example, in a Windows environment, open the command window properties notebook and select a font such as Lucinda Console.

The command line processor does not support national language support (NLS) characters in file path names. This particularly affects commands such as `IMPORT`, `EXPORT`, and `REGISTER XMLSCHEMA`, where problematic file path names would most frequently be encountered.

Chapter 2. db2 - Command line processor invocation

The db2 command starts the command line processor (CLP). The CLP is used to execute database utilities, SQL statements and online help. It offers a variety of command options, and can be started in:

- Interactive input mode, characterized by the **db2 =>** input prompt
- Command mode, where each command must be prefixed by db2
- Batch mode, which uses the -f file input option.

On Windows operating systems, db2cmd opens the CLP-enabled DB2 window, and initializes the DB2 command line environment. Issuing this command is equivalent to clicking on the *DB2 Command Window* icon.

QUIT stops the command line processor. TERMINATE also stops the command line processor, but removes the associated back-end process and frees any memory that is being used. It is recommended that a TERMINATE be issued prior to every STOP DATABASE MANAGER (db2stop) command. It might also be necessary for a TERMINATE to be issued after database configuration parameters have been changed, in order for these changes to take effect. Existing connections should be reset before terminating the CLP.

The shell command (!), allows operating system commands to be executed from the interactive or the batch mode on UNIX[®] based systems, and on Windows operating systems (!!s on UNIX, and !dir on Windows operating systems, for example).

Command Syntax

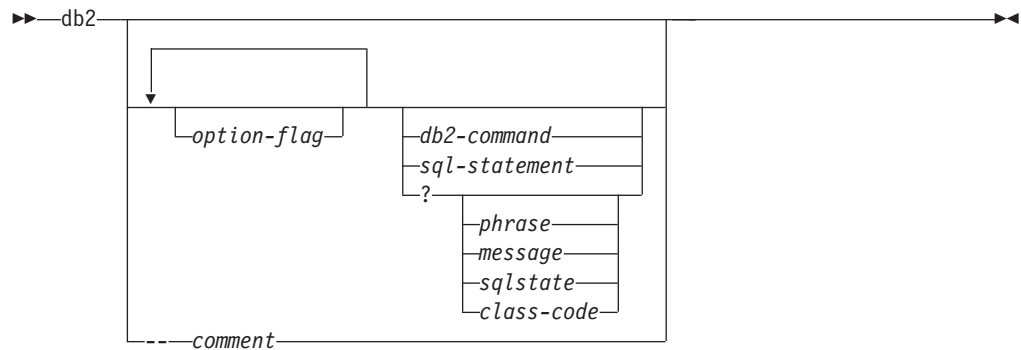

option-flag

Specifies a CLP option flag.

db2-command

Specifies a DB2 command.

sql-statement

Specifies an SQL statement.

? Requests CLP general help.

? phrase

Requests the help text associated with a specified command or topic. If the database manager cannot find the requested information, it displays the general help screen.

? options requests a description and the current settings of the CLP options. ? help requests information about reading the online help syntax diagrams.

? message

Requests help for a message specified by a valid SQLCODE (? sql10007n, for example).

? sqlstate

Requests help for a message specified by a valid SQLSTATE.

? class-code

Requests help for a message specified by a valid class-code.

-- comment

Input that begins with the comment characters -- is treated as a comment by the command line processor.

In each case, a blank space must separate the question mark (?) from the variable name.

Chapter 3. Command line processor options

The CLP command options can be specified by setting the command line processor DB2OPTIONS environment variable (which must be in uppercase), or with command line flags.

Users can set options for an entire session using DB2OPTIONS.

View the current settings for the option flags and the value of DB2OPTIONS using LIST COMMAND OPTIONS. Change an option setting from the interactive input mode or a command file using UPDATE COMMAND OPTIONS.

The command line processor sets options in the following order:

1. Sets up default options.
2. Reads DB2OPTIONS to override the defaults.
3. Reads the command line to override DB2OPTIONS.
4. Accepts input from UPDATE COMMAND OPTIONS as a final interactive override.

Table 3 summarizes the CLP option flags. These options can be specified in any sequence and combination. To turn an option on, prefix the corresponding option letter with a minus sign (-). To turn an option off, either prefix the option letter with a minus sign and follow the option letter with another minus sign, or prefix the option letter with a plus sign (+). For example, -c turns the auto-commit option on, and either -c- or +c turns it off. These option letters are not case sensitive, that is, -a and -A are equivalent.

Table 3. CLP Command Options

Option Flag	Description	Default Setting
-a	This option tells the command line processor to display SQLCA data.	OFF
-c	This option tells the command line processor to automatically commit SQL statements.	ON
-d	This option tells the command line processor to retrieve and display XML declarations of XML data.	OFF
-e{c s}	This option tells the command line processor to display SQLCODE or SQLSTATE. These options are mutually exclusive.	OFF
-f <i>filename</i>	This option tells the command line processor to read command input from a file instead of from standard input.	OFF
-i	This option tells the command line processor to 'pretty print' the XML data with proper indentation. This option will only affect the result set of XQuery statements.	OFF
-l <i>filename</i>	This option tells the command line processor to log commands in a history file.	OFF
-m	This option tells the command line processor to print the number of rows affected for INSERT/DELETE/UPDATE/MERGE.	OFF

Table 3. CLP Command Options (continued)

Option Flag	Description	Default Setting
-n	Removes the new line character within a single delimited token. If this option is not specified, the new line character is replaced with a space. This option must be used with the -t option.	OFF
-o	This option tells the command line processor to display output data and messages to standard output.	ON
-p	This option tells the command line processor to display a command line processor prompt when in interactive input mode.	ON
-q	This option tells the command line processor to preserve whitespaces and linefeeds in strings delimited with single or double quotation marks. When option q is ON, option n is ignored.	OFF
-r <i>filename</i>	This option tells the command line processor to write the report generated by a command to a file.	OFF
-s	This option tells the command line processor to stop execution if errors occur while executing commands in a batch file or in interactive mode.	OFF
-t	This option tells the command line processor to use a semicolon (;) as the statement termination character.	OFF
-tdx or -tdxx	This option tells the command line processor to define and to use x or xx as the statement termination character or characters (1 or 2 characters in length).	OFF
-v	This option tells the command line processor to echo command text to standard output.	OFF
-w	This option tells the command line processor to display FETCH/SELECT warning messages.	ON
-x	This option tells the command line processor to return data without any headers, including column names. This flag will not affect all commands. It applies to SQL statements and some commands that are based on SQL statements such as LIST TABLES.	OFF
-z <i>filename</i>	This option tells the command line processor to redirect all output to a file. It is similar to the -r option, but includes any messages or error codes with the output.	OFF

Example

The AIX command:

```
export DB2OPTIONS='+a -c +ec -o -p'
```

sets the following default settings for the session:

```
Display SQLCA - off
Auto Commit - on
Display SQLCODE - off
Display Output - on
Display Prompt - on
```

The following is a detailed description of these options:

Show SQLCA Data Option (-a):

Displays SQLCA data to standard output after executing a DB2 command or an SQL statement. The SQLCA data is displayed instead of an error or success message.

The default setting for this command option is OFF (+a or -a-).

The -o and the -r options affect the -a option; see the option descriptions for details.

Auto-commit Option (-c):

This option specifies whether each command or statement is to be treated independently. If set ON (-c), each command or statement is automatically committed or rolled back. If the command or statement is successful, it and all successful commands and statements that were issued before it with autocommit OFF (+c or -c-) are committed. If, however, the command or statement fails, it and all successful commands and statements that were issued before it with autocommit OFF are rolled back. If set OFF (+c or -c-), COMMIT or ROLLBACK must be issued explicitly, or one of these actions will occur when the next command with autocommit ON (-c) is issued.

The default setting for this command option is ON.

The auto-commit option does not affect any other command line processor option.

Example: Consider the following scenario:

1. db2 create database test
2. db2 connect to test
3. db2 +c "create table a (c1 int)"
4. db2 select c2 from a

The SQL statement in step 4 fails because there is no column named C2 in table A. Since that statement was issued with auto-commit ON (default), it rolls back not only the statement in step 4, but also the one in step 3, because the latter was issued with auto-commit OFF. The command:

```
db2 list tables
```

then returns an empty list.

XML Declaration Option (-d):

The -d option tells the command line processor whether to retrieve and display XML declarations of XML data.

If set ON (-d), the XML declarations will be retrieved and displayed. If set OFF (+d or -d-), the XML declarations will not be retrieved and displayed. The default setting for this command option is OFF.

The XML declaration option does not affect any other command line processor options.

Display SQLCODE/SQLSTATE Option (-e):

The -e{c|s} option tells the command line processor to display the SQLCODE (-ec) or the SQLSTATE (-es) to standard output. Options -ec and -es are not valid in CLP interactive mode.

The default setting for this command option is OFF (+e or -e-).

The -o and the -r options affect the -e option; see the option descriptions for details.

The display SQLCODE/SQLSTATE option does not affect any other command line processor option.

Example: To retrieve SQLCODE from the command line processor running on AIX, enter:

```
sqlcode=`db2 -ec +o db2-command`
```

Read from Input File Option (-f):

The `-f filename` option tells the command line processor to read input from a specified file, instead of from standard input. *Filename* is an absolute or relative file name which can include the directory path to the file. If the directory path is not specified, the current directory is used.

When the CLP is called with a file input option, it will automatically set the CLIENT APPLNAME special register to CLP *filename*.

When other options are combined with option `-f`, option `-f` must be specified last. For example:

```
db2 -tvf filename
```

This option cannot be changed from within the interactive mode.

The default setting for this command option is OFF (+f or -f-).

Commands are processed until the QUIT command or TERMINATE command is issued, or an end-of-file is encountered.

If both this option and a database command are specified, the command line processor does not process any commands, and an error message is returned.

Input file lines which begin with the comment characters `--` are treated as comments by the command line processor. Comment characters must be the first non-blank characters on a line.

Input file lines which begin with `(=` are treated as the beginning of a comment block. Lines which end with `=)` mark the end of a comment block. The block of input lines that begins at `(=` and ends at `=)` is treated as a continuous comment by the command line processor. Spaces before `(=` and after `=)` are allowed. Comments may be nested, and may be used nested in statements. The command termination character `(;` cannot be used after `=)`.

If the `-f filename` option is specified, the `-p` option is ignored.

The read from input file option does not affect any other command line processor option.

Pretty Print Option (-i):

The `-i` option tells the command line processor to 'pretty print' the XML data with proper indentation. This option will only affect the result set of XQuery statements.

The default setting for this command option is OFF (+i or -i-).

The pretty print option does not affect any other command line processor options.

Log Commands in History File Option (-l):

The `-l filename` option tells the command line processor to log commands to a specified file. This history file contains records of the commands executed and their completion status. *Filename* is an absolute or relative file name which can include the directory path to the file. If the directory path

is not specified, the current directory is used. If the specified file or default file already exists, the new log entry is appended to that file.

When other options are combined with option `-l`, option `-l` must be specified last. For example:

```
db2 -tv1 filename
```

The default setting for this command option is OFF (`+l` or `-l-`).

The log commands in history file option does not affect any other command line processor option.

Display Number of Rows Affected Option (-m):

The `-m` option tells the command line processor whether or not to print the number of rows affected for INSERT, DELETE, UPDATE, or MERGE.

If set ON (`-m`), the number of rows affected will be displayed for the statement of INSERT/DELETE/UPDATE/MERGE. If set OFF (`+m` or `-m-`), the number of rows affected will not be displayed. For other statements, this option will be ignored. The default setting for this command option is OFF.

The `-o` and the `-r` options affect the `-m` option; see the option descriptions for details.

Remove New Line Character Option (-n):

Removes the new line character within a single delimited token. If this option is not specified, the new line character is replaced with a space. This option cannot be changed from within the interactive mode.

The default setting for this command option is OFF (`+n` or `-n-`).

This option must be used with the `-t` option; see the option description for details.

Display Output Option (-o):

The `-o` option tells the command line processor to send output data and messages to standard output.

The default setting for this command option is ON.

The interactive mode start-up information is not affected by this option. Output data consists of report output from the execution of the user-specified command, and SQLCA data (if requested).

The following options might be affected by the `+o` option:

- `-r filename`: Interactive mode start-up information is not saved.
- `-e`: SQLCODE or SQLSTATE is displayed on standard output even if `+o` is specified.
- `-a`: No effect if `+o` is specified. If `-a`, `+o` and `-rfilename` are specified, SQLCA information is written to a file.

If both `-o` and `-e` options are specified, the data and either the SQLCODE or the SQLSTATE are displayed on the screen.

If both `-o` and `-v` options are specified, the data is displayed, and the text of each command issued is echoed to the screen.

The display output option does not affect any other command line processor option.

Display DB2 Interactive Prompt Option (-p):

The -p option tells the command line processor to display the command line processor prompt when the user is in interactive mode.

The default setting for this command option is ON.

Turning the prompt off is useful when commands are being piped to the command line processor. For example, a file containing CLP commands could be executed by issuing:

```
db2 +p < myfile.clp
```

The -p option is ignored if the -f *filename* option is specified.

The display DB2 interactive prompt option does not affect any other command line processor option.

Preserve Whitespaces and Linefeeds Option (-q):

The -q option tells the command line processor to preserve whitespaces and linefeeds in strings delimited with single or double quotation marks.

The default setting for this command option is OFF (+q or -q-).

If option -q is ON, option -n is ignored.

Save to Report File Option (-r):

The -r *filename* option causes any output data generated by a command to be written to a specified file, and is useful for capturing a report that would otherwise scroll off the screen. Messages or error codes are not written to the file. *Filename* is an absolute or relative file name which can include the directory path to the file. If the directory path is not specified, the current directory is used. New report entries are appended to the file.

The default setting for this command option is OFF (+r or -r-).

If the -a option is specified, SQLCA data is written to the file.

The -r option does not affect the -e option. If the -e option is specified, SQLCODE or SQLSTATE is written to standard output, not to a file.

If -r *filename* is set in DB2OPTIONS, the user can set the +r (or -r-) option from the command line to prevent output data for a particular command invocation from being written to the file.

The save to report file option does not affect any other command line processor option.

Stop Execution on Command Error Option (-s):

When commands are issued in interactive mode, or from an input file, and syntax or command errors occur, the -s option causes the command line processor to stop execution and to write error messages to standard output.

The default setting for this command option is OFF (+s or -s-). This setting causes the command line processor to display error messages, continue execution of the remaining commands, and to stop execution only if a system error occurs (return code 8).

The following table summarizes this behavior:

Table 4. CLP Return Codes and Command Execution

Return Code	-s Option Set	+s Option Set
0 (success)	execution continues	execution continues

Table 4. CLP Return Codes and Command Execution (continued)

Return Code	-s Option Set	+s Option Set
1 (0 rows selected)	execution continues	execution continues
2 (warning)	execution continues	execution continues
4 (DB2 or SQL error)	execution stops	execution continues
8 (System error)	execution stops	execution stops

Statement Termination Character Options (-t and -tdx or -tdxx):

The -t option tells the command line processor to use a semicolon (;) as the statement termination character, and disables the backslash (\) line continuation character. This option cannot be changed from within the interactive mode.

The default setting for this command option is OFF (+t or -t-).

Note: If you use the CLP to issue XQuery statements, it is best to choose a termination character other than the semicolon. This ensures that statements or queries that use namespace declarations are not misinterpreted, since namespace declarations are also terminated by a semicolon.

To define termination characters 1 or 2 characters in length, use -td followed by the chosen character or characters. For example, -td%% sets %% as the statement termination characters. Alternatively, use the --#SET TERMINATOR directive in an input file to set the statement termination characters. For example:

```
db2 -td%% -f file1.txt
```

or

```
db2 -f file2.txt
```

where file2.txt contains the following as the first statement in the file:

```
--#SET TERMINATOR %%
```

The default setting for this command option is OFF.

The termination character or characters cannot be used to concatenate multiple statements from the command line, since checks for a termination symbol are performed on only the last one or two non-blank characters of each input line.

The statement termination character options do not affect any other command line processor option.

Verbose Output Option (-v):

The -v option causes the command line processor to echo (to standard output) the command text entered by the user prior to displaying the output, and any messages from that command. ECHO is exempt from this option.

The default setting for this command option is OFF (+v or -v-).

The -v option has no effect if +o (or -o-) is specified.

The verbose output option does not affect any other command line processor option.

Show Warning Messages Option (-w):

The `-w` option instructs the command line processor on whether or not to display warning messages that may occur during a query (FETCH/SELECT). Warnings can occur during various stages of the query execution which may result in the messages being displayed before, during or after the data is returned. To ensure the data returned does not contain warning message text this flag can be used.

The default setting for this command option is ON.

Suppress Printing of Column Headings Option (-x):

The `-x` option tells the command line processor to return data without any headers, including column names. This flag will not affect all commands. It applies to SQL statements and some commands that are based on SQL statements such as LIST TABLES.

The default setting for this command option is OFF.

Save all Output to File Option (-z):

The `-z filename` option causes all output generated by a command to be written to a specified file, and is useful for capturing a report that would otherwise scroll off the screen. It is similar to the `-r` option; in this case, however, messages, error codes, and other informational output are also written to the file. *Filename* is an absolute or relative file name which can include the directory path to the file. If the directory path is not specified, the current directory is used. New report entries are appended to the file.

The default setting for this command option is OFF (+z or -z-).

If the `-a` option is specified, SQLCA data is written to the file.

The `-z` option does not affect the `-e` option. If the `-e` option is specified, SQLCODE or SQLSTATE is written to standard output, not to a file.

If `-z filename` is set in DB2OPTIONS, the user can set the `+z` (or `-z-`) option from the command line to prevent output data for a particular command invocation from being written to the file.

The save all output to file option does not affect any other command line processor option.

Chapter 4. Command line processor return codes

When the command line processor finishes processing a command or an SQL statement, it returns a return (or exit) code. These codes are transparent to users executing CLP functions from the command line, but they can be retrieved when those functions are executed from a shell script.

For example, the following Bourne shell script executes the GET DATABASE MANAGER CONFIGURATION command, then inspects the CLP return code:

```
db2 get database manager configuration
if [ "$?" = "0" ]
then echo "OK!"
fi
```

The return code can be one of the following:

Code	Description
0	DB2 command or SQL statement executed successfully
1	SELECT or FETCH statement returned no rows
2	DB2 command or SQL statement warning
4	DB2 command or SQL statement error
8	Command line processor system error

The command line processor does not provide a return code while a user is executing statements from interactive mode, or while input is being read from a file (using the -f option).

A return code is available only after the user quits interactive mode, or when processing of an input file ends. In these cases, the return code is the logical OR of the distinct codes returned from the individual commands or statements executed to that point.

For example, if a user in interactive mode issues commands resulting in return codes of 0, 1, and 2, a return code of 3 will be returned after the user quits interactive mode. The individual codes 0, 1, and 2 are not returned. Return code 3 tells the user that during interactive mode processing, one or more commands returned a 1, and one or more commands returned a 2.

A return code of 4 results from a negative SQLCODE returned by a DB2 command or an SQL statement. A return code of 8 results only if the command line processor encounters a system error.

If commands are issued from an input file or in interactive mode, and the command line processor experiences a system error (return code 8), command execution is halted immediately. If one or more DB2 commands or SQL statements end in error (return code 4), command execution stops if the -s (Stop Execution on Command Error) option is set; otherwise, execution continues.

Chapter 5. Invoking command help from the command line processor

Command help explains the syntax of commands in the command line processor.

To invoke command help, open the command line processor and enter:

```
? command
```

where *command* represents a keyword or the entire command.

For example, ? catalog displays help for all of the CATALOG commands, while ? catalog database displays help only for the CATALOG DATABASE command.

Chapter 6. Invoking message help from the command line processor

Message help describes the cause of a message and describes any action you should take in response to the error.

To invoke message help, open the command line processor and enter:

```
? XXXnnnnn
```

where *XXXnnnnn* represents a valid message identifier.

For example, ? SQL30081 displays help about the SQL30081 message.

Part 2. Using command line SQL statements and XQuery statements

This section provides information about using Structured Query Language (SQL) statements from the command line. These statements can be executed directly from an operating system command prompt, and can be used to define and manipulate information stored in a database table, index, or view in much the same way as if the commands were written into an application program. Information can be added, deleted, or updated, and reports can be generated from the contents of tables.

You can use SQL statements from the command line, and you can use a stored procedure (SYSPROC.ADMIN_CMD()) to run some CLP commands through SQL. For more information on how to use this stored procedure, refer to the SQL Administrative Routines.

To issue XQuery statements in CLP, prefix the statements with the XQUERY keyword.

Note: If you use the CLP to issue XQuery statements, it is best to choose a termination character other than the semicolon (-t option). This ensures that statements or queries that use namespace declarations are not misinterpreted, since namespace declarations are also terminated by a semicolon.

All SQL statements that can be executed through the command line processor are listed in the CLP column of Table 5 on page 29. The syntax of all the SQL statements, whether executed from the command line or embedded in a source program, is described in the SQL Reference. The syntax of many embedded SQL statements and CLP SQL statements is identical. However, host variables, parameter markers, descriptor names, and statement names are applicable only to embedded SQL. The syntax of CALL, CLOSE, CONNECT, DECLARE CURSOR, FETCH, and OPEN *does* depend on whether these statements are embedded or executed through the CLP. The CLP syntax of these statements is provided below:

CALL

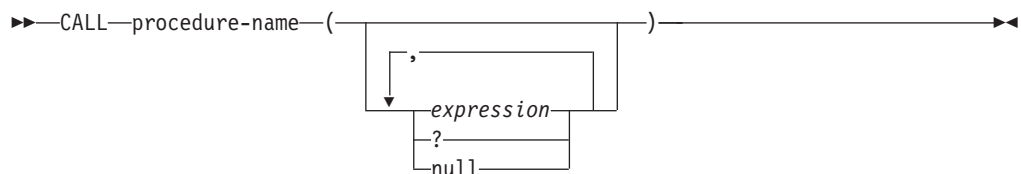

CLOSE



CONNECT

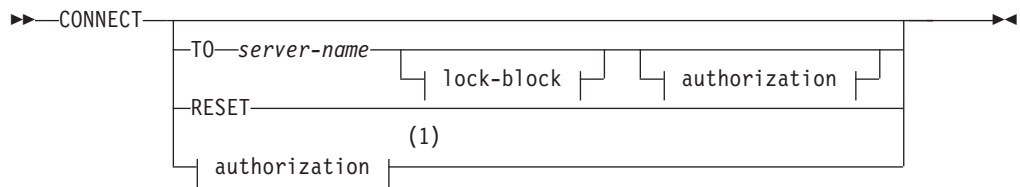

authorization:

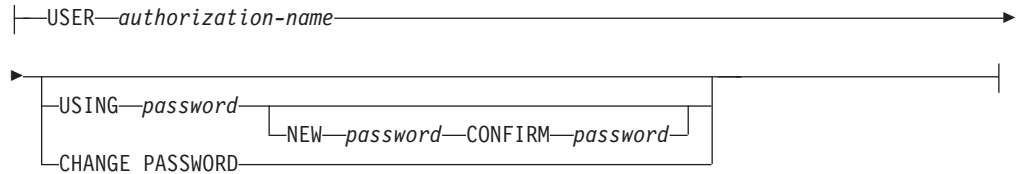

lock-block:

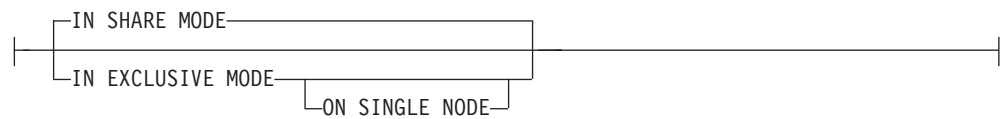

Notes:

- 1 This form is only valid if implicit connect is enabled.

DECLARE CURSOR

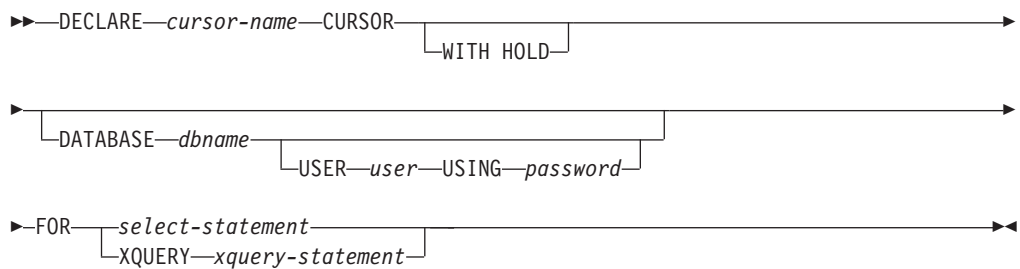

FETCH

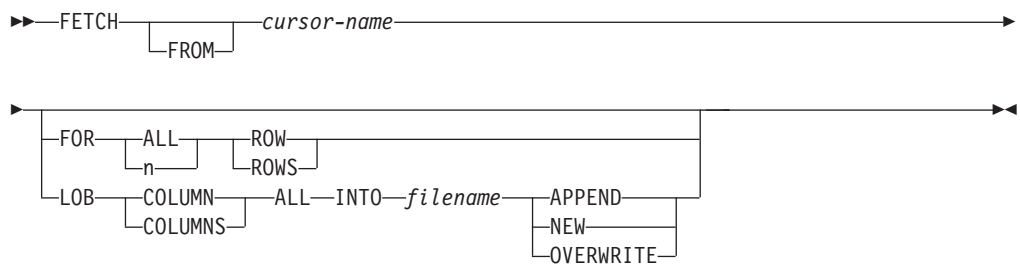

OPEN

Note:

1. When CALL is issued:

- An expression must be used for each IN or INOUT parameter of the procedure. For an INOUT parameter, the expression must be a single literal value. The INOUT XML parameters must be either NULL (if nullable) or in the following format: XMLPARSE(DOCUMENT *string*). Note that the *string* in the argument for XMLPARSE must be a string literal and is subject to the CURRENT IMPLICIT XMLPARSE OPTION special register. It cannot be an expression.
- A question mark (?) must be used for each OUT parameter of the procedure.
- The stored procedure must be cataloged. If an uncataloged procedure is called, a SQL0440N error message is returned.

The following CLP script creates a procedure called PROC4 after it creates a table with an XML column C1. It uses three XML parameters: IN (PARM1), INOUT (PARM2) and OUT (PARM3), and returns a result set with XML data.

```
CREATE TABLE TAB4(C1 XML)
CREATE PROCEDURE PROC4(IN PARM1 XML, INOUT PARM2 XML, OUT PARM3 XML)
LANGUAGE SQL
BEGIN
  DECLARE STMT CLOB(1M) DEFAULT '';
  DECLARE C1 CURSOR WITH RETURN FOR S1;
  SET STMT = 'SELECT C1 FROM TAB4';

  /* INSERT PARM1 */
  INSERT INTO TAB4 VALUES(PARM1);

  /* MANIPULATE PARM2 */

  /* SET PARM3 AND INSERT */
  SET PARM3 = XMLPARSE(DOCUMENT '<a>333</a>');
  INSERT INTO TAB4 VALUES(PARM3);

  /* RETURN A RESULT SET WITH XML DATA */
  PREPARE S1 FROM STMT;
  OPEN C1;
END
```

To call the procedure PROC4 from the command line processor, issue a CALL statement:

```
CALL PROC4(XMLPARSE(DOCUMENT '<a>111</a>'), XMLPARSE(DOCUMENT '<a>222</a>'), ?)
```

2. The CLP version of CONNECT permits the user to change the password, using the following parameters:

NEW *password*

Specifies the new password that is to be assigned to the user name. Passwords can be up to 18 characters in length. The system on which the password will be changed depends on how user authentication has been set up.

CONFIRM *password*

A string that must be identical to the new password. This parameter is used to catch entry errors.

CHANGE PASSWORD

If this option is specified, the user is prompted for the current

password, a new password, and for confirmation of the new password. Passwords are not displayed at entry.

3. The DATABASE clause in the DECLARE CURSOR statement is only applicable when the cursor is being used for a subsequent load from cursor operation.
4. To use the DECLARE CURSOR statement with an XQuery statement, users must prefix the XQuery statement with the keyword XQUERY explicitly.
5. When FETCH is issued through the command line processor, decimal and floating-point numbers are displayed with the territory's decimal delimiter, that is, a period (.) in the U.S., Canada, and the U.K.; a comma (,) in most other countries/regions. However, when INSERT, UPDATE, CALL, and other SQL statements are issued through the command line processor to update tables, a period must be used as the decimal delimiter, even in countries/regions that use a comma for that purpose.
6. When FETCH is issued through the command line processor, null values are typically displayed as a hyphen (-). For databases configured with DFT_SQLMATHWARN YES, expressions that result in an arithmetic error are processed as null values. Such arithmetic error nulls are displayed as a plus (+).

For example, create and populate table t1 as follows:

```
create table t1 (i1 int , i2 int);
insert into t1 values (1,1),(2,0),(3,null);
```

The statement: select i1/i2 from t1 generates the following result:

```
1
---
1
+
-
3 records selected
```

7. A new LOB option has been added to FETCH. If the LOB clause is specified, only the next row is fetched:
 - When SELECT is issued through the command line processor to query tables containing LOB columns, all columns are truncated to 8KB in the output.
 - Each LOB column value is fetched into a file with the name *filename.xxx*, where *filename* is specified in the LOB clause, and *xxx* is a file extension from 001 to 999 (001 is the first LOB column in the select list of the corresponding DECLARE CURSOR statement, 002 is the second LOB column, and 999 is the 999th column). The maximum number of LOB columns that can be fetched into files is 999.
 - Names of the files containing the data are displayed in the LOB columns.
8. The command line processor displays BLOB columns in hexadecimal representation.
9. SQL statements that contain references to structured type columns cannot be issued if an appropriate transform function is not available.
10. A CLP imposed limit of 64K for SQL statements and for CLP commands that contain SQL statement components has now been removed.
11. XML data, retrieved via SELECT, CALL or XQuery, is truncated to 4000 bytes in the output.

To change the way that the CLP displays data (when querying databases using SQL statements through the CLP), rebind the CLP bind files against the database being queried. For example, to display date and time in ISO format, do the following:

1. Create a text file containing the names of the CLP bind files. This file is used as the list file for binding multiple files with one BIND command. In this example the file is named `clp.lst`, and its contents are:

```
db2clpcs.bnd +
db2clpr.r.bnd +
db2clpur.bnd +
db2clprs.bnd +
db2clpns.bnd
```

2. Connect to the database.
3. Issue the following command:

```
db2 bind @clp.lst collection nullid datetime iso
```

Table 5. SQL Statements (DB2)

SQL Statement	Dynamic ¹	Command Line Processor (CLP)	Call Level Interface ³ (CLI)	SQL Procedure
ALLOCATE CURSOR				X
assignment statement				X
ASSOCIATE LOCATORS				X
ALTER { BUFFERPOOL, NICKNAME, ⁹ NODEGROUP, SERVER, ⁹ TABLE, TABLESPACE, USER MAPPING, ⁹ TYPE, VIEW }	X	X	X	
BEGIN DECLARE SECTION ²				
CALL	X	X	X	X
CASE statement				X
CLOSE		X	SQLCloseCursor(), SQLFreeStmt()	X
COMMENT ON	X	X	X	X
COMMIT	X	X	SQLEndTran(), SQLTransact()	X
Compound SQL (Embedded)			X ⁴	
compound statement				X
CONNECT (Type 1)		X	SQLBrowseConnect(), SQLConnect(), SQLDriverConnect()	
CONNECT (Type 2)		X	SQLBrowseConnect(), SQLConnect(), SQLDriverConnect()	
CREATE { ALIAS, BUFFERPOOL, DISTINCT TYPE, EVENT MONITOR, FUNCTION, FUNCTION MAPPING ⁹ , GLOBAL TEMPORARY TABLE, INDEX, INDEX EXTENSION, METHOD, NICKNAME, ⁹ NODEGROUP, PROCEDURE, SCHEMA, SERVER, TABLE, TABLESPACE, TRANSFORM, TYPE MAPPING, ⁹ TRIGGER, USER MAPPING, ⁹ TYPE, VIEW, WRAPPER ⁹ }	X	X	X	X ¹⁰
DECLARE CURSOR ²		X	SQLAllocStmt()	X
DECLARE GLOBAL TEMPORARY TABLE	X	X	X	X

Table 5. SQL Statements (DB2) (continued)

SQL Statement	Dynamic ¹	Command Line Processor (CLP)	Call Level Interface ³ (CLI)	SQL Procedure
DELETE	X	X	X	X
DESCRIBE ⁸		X	SQLColAttributes(), SQLDescribeCol(), SQLDescribeParam() ⁶	
DISCONNECT		X	SQLDisconnect()	
DROP	X	X	X	X ¹⁰
END DECLARE SECTION ²				
EXECUTE			SQLExecute()	X
EXECUTE IMMEDIATE			SQLExecDirect()	X
EXPLAIN	X	X	X	X
FETCH		X	SQLExtendedFetch(), SQLFetch(), SQLFetchScroll()	X
FLUSH EVENT MONITOR	X	X	X	
FOR statement				X
FREE LOCATOR			X ⁴	X
GET DIAGNOSTICS				X
GOTO statement				X
GRANT	X	X	X	X
IF statement				X
INCLUDE ²				
INSERT	X	X	X	X
ITERATE				X
LEAVE statement				X
LOCK TABLE	X	X	X	X
LOOP statement				X
OPEN		X	SQLExecute(), SQLExecDirect()	X
PREPARE			SQLPrepare()	X
REFRESH TABLE	X	X	X	
RELEASE		X		X
RELEASE SAVEPOINT	X	X	X	X
RENAME TABLE	X	X	X	
RENAME TABLESPACE	X	X	X	
REPEAT statement				X
RESIGNAL statement				X
RETURN statement				X
REVOKE	X	X	X	
ROLLBACK	X	X	SQLEndTran(), SQLTransact()	X
SAVEPOINT	X	X	X	X
select-statement	X	X	X	X

Table 5. SQL Statements (DB2) (continued)

SQL Statement	Dynamic ¹	Command Line Processor (CLP)	Call Level Interface ³ (CLI)	SQL Procedure
SELECT INTO				X
SET CONNECTION		X	SQLSetConnection()	
SET CURRENT DEFAULT TRANSFORM GROUP	X	X	X	X
SET CURRENT DEGREE	X	X	X	X
SET CURRENT EXPLAIN MODE	X	X	X, SQLSetConnectAttr()	X
SET CURRENT EXPLAIN SNAPSHOT	X	X	X, SQLSetConnectAttr()	X
SET CURRENT PACKAGESET				
SET CURRENT QUERY OPTIMIZATION	X	X	X	X
SET CURRENT REFRESH AGE	X	X	X	X
SET EVENT MONITOR STATE	X	X	X	X
SET INTEGRITY	X	X	X	
SET PASSTHRU ⁹	X	X	X	X
SET PATH	X	X	X	X
SET SCHEMA	X	X	X	X
SET SERVER OPTION ⁹	X	X	X	X
SET transition-variable ⁵	X	X	X	X
SIGNAL statement				X
SIGNAL SQLSTATE ⁵	X	X	X	
UPDATE	X	X	X	X
VALUES INTO				X
WHENEVER ²				
WHILE statement				X

Notes:

1. You can code all statements in this list as static SQL, but only those marked with X as dynamic SQL.
2. You cannot execute this statement.
3. An X indicates that you can execute this statement using either `SQLExecDirect()` or `SQLPrepare()` and `SQLExecute()`. If there is an equivalent DB2 CLI function, the function name is listed.
4. Although this statement is not dynamic, with DB2 CLI you can specify this statement when calling either `SQLExecDirect()`, or `SQLPrepare()` and `SQLExecute()`.
5. You can only use this within CREATE TRIGGER statements.
6. You can only use the SQL DESCRIBE statement to describe output, whereas with DB2 CLI you can also describe input (using the `SQLDescribeParam()` function).
7. You can only use the SQL FETCH statement to fetch one row at a time in one direction, whereas with the DB2 CLI `SQLExtendedFetch()` and `SQLFetchScroll()` functions, you can fetch into arrays. Furthermore, you can fetch in any direction, and at any position in the result set.
8. The DESCRIBE SQL statement has a different syntax than that of the CLP DESCRIBE command.
9. Statement is supported only for federated database servers.
10. SQL procedures can only issue CREATE and DROP statements for indexes, tables, and views.

Part 3. How to read command syntax help

There may be occasions in which you forget the options that are valid for a particular command. All Command Line Processor (CLP) commands can invoke a help screen at the CLP prompt by preceding the command keyword(s) with a question mark (?). For many of the system commands, a summarizing help screen can be displayed by issuing the command keyword followed by a *help* option. The useful command help screen output appearing in the command window uses a syntax convention which is explained here.

Invoking help

CLP commands

To display a CLP command help screen, preface the command keyword(s) with a question mark at the db2 interactive mode prompt (db2 =>), as shown in the example below for the BACKUP DATABASE command:

```
db2 => ? backup database
```

or, outside the 'db2' interactive mode, preface each command help screen invocation with db2, as shown below for the BACKUP DATABASE command:

```
=> db2 ? backup database
```

System commands

Most of the system commands can display a command help screen by entering the system command keyword followed by a *help* option. Many system commands use a common *help* option, while other system commands may use different and/or additional *help* options. For the first attempts, without having to search for a command's forgotten *help* option just yet, try the following most common options which are likely to result in successfully invoking the command help screen:

Help options

- -h
- -?
- -help
- nothing entered after the command keyword.

Note: When nothing is entered after the command keyword, in some cases this could actually execute the command if options are not required.

Help screen syntax conventions

[] Encloses optional parameters

{ } Encloses mandatory parameters

| Separates two or more items, only one of which may be chosen

... Indicates a repeatable parameter

() Repeatable parameter delimiter (not always used)

Command KEYWORDS appear in uppercase

variables, that require you to determine and enter the appropriate input, appear in lowercase

Example command help screen output

The following is the CLP command help screen for the UPDATE MONITOR SWITCHES command:

```
db2 => ? update monitor
UPDATE MONITOR SWITCHES USING {switch-name {ON | OFF} ...}
[AT DBPARTITIONNUM db-partition-number | GLOBAL]
```

```
switch-name:
BUFFERPOOL, LOCK, SORT, STATEMENT, TABLE, TIMESTAMP, UOW
```

The following is the system command help screen for the db2look command which, in this case, was not invoked by its specified -h help option:

```
C:\Program Files\IBM\SQLLIB\BIN>db2look
```

```
Syntax: db2look -d DBname [-e] [-xs] [-xdir Path] [-u Creator] [-z Schema]
        [-t Tname1 Tname2...TnameN] [-tw Tname] [-h]
        [-o Fname] [-a] [-m] [-c] [-r] [-l] [-x] [-xd] [-f]
        [-fd] [-td x] [-noview] [-i userID] [-w password]
        [-v Vname1 Vname2 ... VnameN] [-dp] [-ct]
        [-wrapper WrapperName] [-server ServerName] [-nofed]
        [-wlm] [-ap]

        [-wrapper WrapperName] [-server ServerName] [-fedonly] [-nofed]
```

```
db2look [-h]
```

-d: Database Name: This must be specified

-e: Extract DDL file needed to duplicate database

-xs: Export XSR objects and generate a script containing DDL statements

-xdir: Path name: the directory in which XSR objects will be placed

-u: Creator ID: If -u and -a are both not specified then \$USER will be used

-z: Schema name: If -z and -a are both specified then -z will be ignored

-t: Generate statistics for the specified tables

-tw: Generate DDLs for tables whose names match the pattern criteria (wildcard characters) of the table name

-ap: Generate AUDIT USING Statements

-wlm: Generate WLM specific DDL Statements

-h: More detailed help message

-o: Redirects the output to the given file name

-a: Generate statistics for all creators

-m: Run the db2look utility in mimic mode

-c: Do not generate COMMIT statements for mimic

-r: Do not generate RUNSTATS statements for mimic

-l: Generate Database Layout: Database partition groups, Bufferpools and Tablespace

-x: Generate Authorization statements DDL excluding the original definer of the object

-xd: Generate Authorization statements DDL including the original definer of the object

-f: Extract configuration parameters and environment variables

-td: Specifies x to be statement delimiter (default is semicolon(;))

-i: User ID to log on to the server where the database resides

-w: Password to log on to the server where the database resides

-noview: Do not generate CREATE VIEW ddl statements

-wrapper: Generates DDLs for federated objects that apply to this wrapper

-server: Generates DDLs for federated objects that apply to this server

-FEDONLY: Only created Federated DDL Statements

-nofed: Do not generate Federated DDL

-fd: Generates db2fopt statements for opt_buffpage and opt_sortheap along with other cfg and env parameters.

-v: Generate DDL for view only, this option is ignored when -t is specified

-dp: Generate DROP statement before CREATE statement

-ct: Generate DDL Statements by object creation time

Note: In general, a system command help screen tends to provide more detailed information than a CLP command help screen.

Example command inputs

Using the UPDATE MONITOR SWITCHES command help screen as an example,

```
db2 => ? update monitor
UPDATE MONITOR SWITCHES USING {switch-name {ON | OFF} ...}
[AT DBPARTITIONNUM db-partition-number | GLOBAL]
```

```
switch-name:
BUFFERPOOL, LOCK, SORT, STATEMENT, TABLE, TIMESTAMP, UOW
```

the following command inputs are valid,

```
UPDATE MONITOR SWITCHES USING LOCK OFF
UPDATE MONITOR SWITCHES USING LOCK OFF TIMESTAMP ON
UPDATE MONITOR SWITCHES USING STATEMENT ON AT DBPARTITIONNUM 1
UPDATE MONITOR SWITCHES USING SORT ON GLOBAL
```

while the following command inputs are invalid:

```
UPDATE MONITOR SWITCHES LOCK OFF
UPDATE MONITOR SWITCHES USING LOCK GLOBAL
UPDATE MONITOR SWITCHES USING STATEMENT ON AT DBPARTITIONNUM 1 GLOBAL
```

Reminder

To remind yourself about the command help screen syntax conventions without searching the online Information Center, issue the following command at the CLP prompt:

```
db2 => ? help
```

or, at the system command prompt, enter the following:

```
=> db2 ? help
```

Part 4. CLP commands

Chapter 7. ACTIVATE DATABASE

Activates the specified database and starts up all necessary database services, so that the database is available for connection and use by any application.

Scope

This command activates the specified database on all nodes within the system. If one or more of these nodes encounters an error during activation of the database, a warning is returned. The database remains activated on all nodes on which the command has succeeded.

Authorization

One of the following:

- *sysadm*
- *sysctrl*
- *sysmaint*

Required connection

None

Command syntax

```
▶▶ ACTIVATE { DATABASE database-alias | DB database-alias }
▶▶ [ USER username [ USING password ] ]
```

Command parameters

database-alias

Specifies the alias of the database to be started.

USER *username*

Specifies the user starting the database.

USING *password*

Specifies the password for the user name.

Usage notes

If a database has not been started, and a CONNECT TO (or an implicit connect) is issued in an application, the application must wait while the database manager starts the required database, before it can do any work with that database. However, once the database is started, other applications can simply connect and use it without spending time on its start up.

Database administrators can use ACTIVATE DATABASE to start up selected databases. This eliminates any application time spent on database initialization.

Databases initialized by `ACTIVATE DATABASE` can be shut down using the `DEACTIVATE DATABASE` command, or using the `db2stop` command.

If a database was started by a `CONNECT TO` (or an implicit connect) and subsequently an `ACTIVATE DATABASE` is issued for that same database, then `DEACTIVATE DATABASE` must be used to shut down that database. If `ACTIVATE DATABASE` was not used to start the database, the database will shut down when the last application disconnects.

`ACTIVATE DATABASE` behaves in a similar manner to a `CONNECT TO` (or an implicit connect) when working with a database requiring a restart (for example, database in an inconsistent state). The database will be restarted before it can be initialized by `ACTIVATE DATABASE`. Restart will only be performed if the database is configured to have `AUTORESTART ON`.

The application issuing the `ACTIVATE DATABASE` command cannot have an active database connection to any database.

Chapter 8. ADD CONTACT

The command adds a contact to the contact list which can be either defined locally on the system or in a global list. Contacts are users to whom processes such as the Scheduler and Health Monitor send messages. The setting of the Database Administration Server (DAS) **contact_host** configuration parameter determines whether the list is local or global.

Authorization

None

Required connection

None. Local execution only: this command cannot be used with a remote connection.

Command syntax

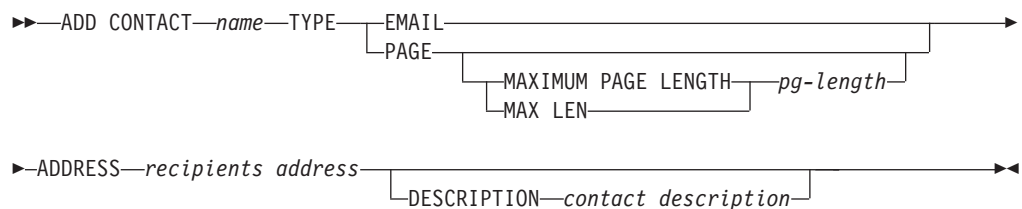

Command parameters

ADD CONTACT *name*

The name of the contact that will be added. By default the contact will be added in the local system, unless the DB2 administration server configuration parameter **contact_host** points to another system.

TYPE Method of contact, which must be one of the following two:

EMAIL

This contact wishes to be notified by e-mail at (ADDRESS).

PAGE This contact wishes to be notified by a page sent to ADDRESS.

MAXIMUM PAGE LENGTH *pg-length*

If the paging service has a message-length restriction, it is specified here in characters.

The notification system uses the SMTP protocol to send the notification to the mail server specified by the DB2 Administration Server configuration parameter **smtp_server**. It is the responsibility of the SMTP server to send the e-mail or call the pager.

ADDRESS *recipients-address*

The SMTP mailbox address of the recipient. For example, joe@somewhere.org. The **smtp_server** DAS configuration parameter must be set to the name of the SMTP server.

DESCRIPTION *contact description*

A textual description of the contact. This has a maximum length of 128 characters.

Chapter 9. ADD CONTACTGROUP

Adds a new contact group to the list of groups defined on the local system. A contact group is a list of users and groups to whom monitoring processes such as the Scheduler and Health Monitor can send messages. The setting of the Database Administration Server (DAS) `contact_host` configuration parameter determines whether the list is local or global.

Authorization

None

Required connection

None. Local execution only: this command cannot be used with a remote connection.

Command Syntax

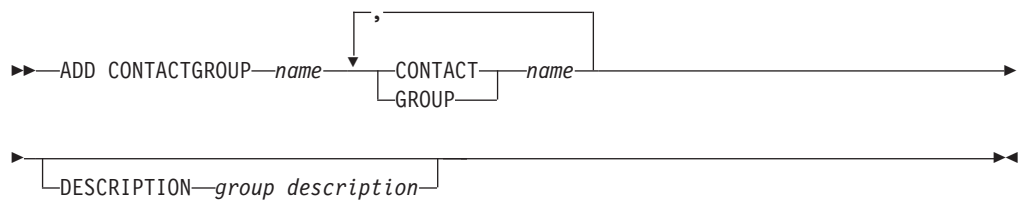

Command Parameters

ADD CONTACTGROUP *name*

Name of the new contact group, which must be unique among the set of groups on the system.

CONTACT *name*

Name of the contact which is a member of the group. A contact can be defined with the `ADD CONTACT` command after it has been added to a group.

GROUP *name*

Name of the contact group of which this group is a member.

DESCRIPTION *group description*

Optional. A textual description of the contact group.

Chapter 10. ADD DBPARTITIONNUM

Adds a database partition to a database partition server.

Scope

This command only affects the database partition server on which it is executed.

Authorization

One of the following:

- *sysadm*
- *sysctrl*

Required connection

None

Command syntax

```
▶▶—ADD DBPARTITIONNUM—  
└─LIKE DBPARTITIONNUM—db-partition-number—  
└─WITHOUT TABLESPACES—
```

Command parameters

LIKE DBPARTITIONNUM *db-partition-number*

Specifies that the containers for the new system temporary table spaces are the same as the containers of the database at the database partition server specified by *db-partition-number*. The database partition server specified must already be defined in the `db2nodes.cfg` file.

For system temporary table spaces that are defined to use automatic storage (in other words, system temporary table spaces that were created with the `MANAGED BY AUTOMATIC STORAGE` clause of the `CREATE TABLESPACE` statement or where no `MANAGED BY CLAUSE` was specified at all), the containers will not necessarily match those from the partition specified. Instead, containers will automatically be assigned by the database manager based on the storage paths that are associated with the database. This may or may not result in the same containers being used on these two partitions.

WITHOUT TABLESPACES

Specifies that containers for the system temporary table spaces are not created for any of the database partitions. The `ALTER TABLESPACE` statement must be used to add system temporary table space containers to each database partition before the database can be used.

If no option is specified, containers for the system temporary table spaces will be the same as the containers on the catalog partition for each database. The catalog partition can be a different database partition for each database in the partitioned database environment. This option is ignored for system temporary table spaces that are defined to use

automatic storage (in other words, system temporary table spaces that were created with the `MANAGED BY AUTOMATIC STORAGE` clause of the `CREATE TABLESPACE` statement or where no `MANAGED BY CLAUSE` was specified at all). For these table spaces, there is no way to defer container creation. Containers will automatically be assigned by the database manager based on the storage paths that are associated with the database.

Usage notes

This command should only be used if a database partition server is added to an environment that has one database and that database is not cataloged at the time of the add partition operation. In this situation, because the database is not cataloged, the add partition operation does not recognize the database, and does not create a database partition for the database on the new database partition server. Any attempt to connect to the database partition on the new database partition server results in an error. The database must first be cataloged before the `ADD DBPARTITIONNUM` command can be used to create the database partition for the database on the new database partition server.

This command should not be used if the environment has more than one database and at least one of the databases is cataloged at the time of the add partition operation. In this situation, use the `AT DBPARTITIONNUM` parameter of the `CREATE DATABASE` command to create a database partition for each database that was not cataloged at the time of the add partition operation. Each uncataloged database must first be cataloged before the `CREATE DATABASE` command can be used to create the database partition for the database on the new database partition server.

Before adding a new database partition, ensure that there is sufficient storage for the containers that must be created.

The add database partition server operation creates an empty database partition for every database that exists in the instance. The configuration parameters for the new database partitions are set to the default values.

Note: Any uncataloged database is not recognized when adding a new database partition. The uncataloged database will not be present on the new database partition. An attempt to connect to the database on the new database partition returns the error message `SQL1013N`.

If an add database partition server operation fails while creating a database partition locally, it enters a clean-up phase, in which it locally drops all databases that have been created. This means that the database partitions are removed only from the database partition server being added. Existing database partitions remain unaffected on all other database partition servers. If the clean-up phase fails, no further clean up is done, and an error is returned.

The database partitions on the new database partition cannot contain user data until after the `ALTER DATABASE PARTITION GROUP` statement has been used to add the database partition to a database partition group.

This command will fail if a create database or a drop database operation is in progress. The command can be reissued once the competing operation has completed.

To determine whether or not a database is enabled for automatic storage, ADD DBPARTITIONNUM has to communicate with the catalog partition for each of the databases in the instance. If automatic storage is enabled then the storage path definitions are retrieved as part of that communication. Likewise, if system temporary table spaces are to be created with the database partitions, ADD DBPARTITIONNUM might have to communicate with another database partition server to retrieve the table space definitions for the database partitions that reside on that server. The **start_stop_time** database manager configuration parameter is used to specify the time, in minutes, by which the other database partition server must respond with the automatic storage and table space definitions. If this time is exceeded, the command fails. If this situation occurs, increase the value of **start_stop_time**, and reissue the command.

Compatibilities

For compatibility with versions earlier than Version 8:

- The keyword NODE can be substituted for DBPARTITIONNUM.

Chapter 11. ADD XMLSCHEMA DOCUMENT

Adds one or more XML schema documents to an existing but incomplete XML schema before completing registration.

Authorization

The following authority is required:

- The user ID must be the owner of the XSR object as recorded in the catalog view SYSCAT.XSROBJECTS.

Required connection

Database

Command syntax

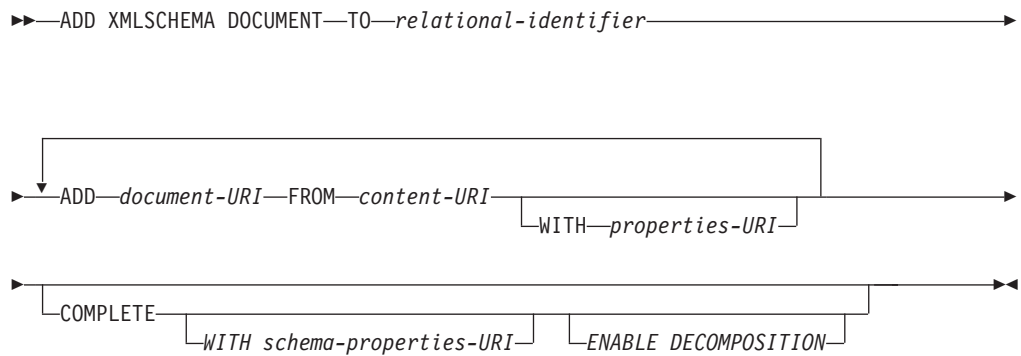

Description

TO *relational-identifier*

Specifies the relational name of a registered but incomplete XML schema to which additional schema documents are added.

ADD *document-URI*

Specifies the uniform resource identifier (URI) of an XML schema document to be added to this schema, as the document would be referenced from another XML document.

FROM *content-URI*

Specifies the URI where the XML schema document is located. Only a file scheme URI is supported.

WITH *properties-URI*

Specifies the URI of a properties document for the XML schema. Only a file scheme URI is supported.

COMPLETE

Indicates that there are no more XML schema documents to be added. If specified, the schema is validated and marked as usable if no errors are found.

WITH *schema-properties-URI*

Specifies the URI of a properties document for the XML schema. Only a file scheme URI is supported.

ENABLE DECOMPOSITION

Specifies that this schema is to be used for decomposing XML documents.

Example

```
ADD XMLSCHEMA DOCUMENT TO JOHNDOE.PRODSHEMA
  ADD 'http://myPOschema/address.xsd'
  FROM 'file:///c:/TEMP/address.xsd'
```

Chapter 12. ARCHIVE LOG

Closes and truncates the active log file for a recoverable database.

Authorization

One of the following:

- *sysadm*
- *sysctrl*
- *sysmaint*
- *dbadm*

Required connection

None. This command establishes a database connection for the duration of the command.

Command syntax

```
➤➤ ARCHIVE LOG FOR DATABASE database-alias
   DB
➤➤ USER username USING password
➤➤ On Database Partition Number Clause
```

On Database Partition Number Clause:

```
ON ALL DBPARTITIONNUMS Database Partition Number List Clause
  EXCEPT Database Partition Number List Clause
```

Database Partition Number List Clause:

```
DBPARTITIONNUM
DBPARTITIONNUMS
➤➤ ( db-partition-number TO db-partition-number )
```

Command parameters

DATABASE *database-alias*

Specifies the alias of the database whose active log is to be archived.

USER *username*

Identifies the user name under which a connection will be attempted.

USING *password*

Specifies the password to authenticate the user name.

ON ALL DBPARTITIONNUMS

Specifies that the command should be issued on all database partitions in the `db2nodes.cfg` file. This is the default if a database partition number clause is not specified.

EXCEPT

Specifies that the command should be issued on all database partitions in the `db2nodes.cfg` file, except those specified in the database partition number list.

ON DBPARTITIONNUM | ON DBPARTITIONNUMS

Specifies that the logs should be archived for the specified database on a set of database partitions.

db-partition-number

Specifies a database partition number in the database partition number list.

TO *db-partition-number*

Used when specifying a range of database partitions for which the logs should be archived. All database partitions from the first database partition number specified up to and including the second database partition number specified are included in the database partition number list.

Usage notes

This command can be used to collect a complete set of log files up to a known point. The log files can then be used to update a standby database.

This command can only be executed when the invoking application or shell does not have a database connection to the specified database. This prevents a user from executing the command with uncommitted transactions. As such, the ARCHIVE LOG command will not forcibly commit the user's incomplete transactions. If the invoking application or shell already has a database connection to the specified database, the command will terminate and return an error. If another application has transactions in progress with the specified database when this command is executed, there will be a slight performance degradation since the command flushes the log buffer to disk. Any other transactions attempting to write log records to the buffer will have to wait until the flush is complete.

If used in a partitioned database environment, a subset of database partitions can be specified by using a database partition number clause. If the database partition number clause is not specified, the default behavior for this command is to close and archive the active log on all database partitions.

Using this command will use up a portion of the active log space due to the truncation of the active log file. The active log space will resume its previous size when the truncated log becomes inactive. Frequent use of this command can drastically reduce the amount of the active log space available for transactions.

Compatibilities

For compatibility with versions earlier than Version 8:

- The keyword `NODE` can be substituted for `DBPARTITIONNUM`.

- The keyword `NODES` can be substituted for `DBPARTITIONNUMS`.

Chapter 13. ATTACH

Enables an application to specify the instance at which instance-level commands (CREATE DATABASE and FORCE APPLICATION, for example) are to be executed. This instance can be the current instance, another instance on the same workstation, or an instance on a remote workstation.

Authorization

None

Required connection

None. This command establishes an instance attachment.

Command syntax

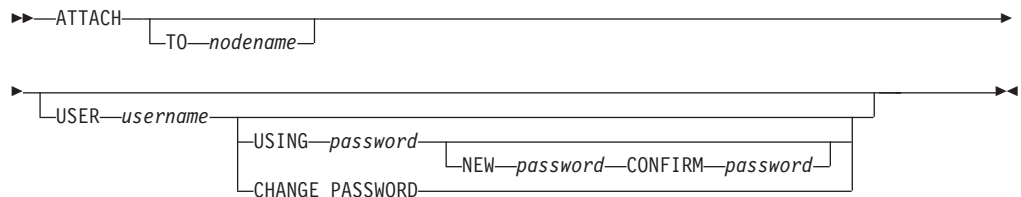

Command parameters

TO *nodename*

Alias of the instance to which the user wants to attach. This instance must have a matching entry in the local node directory. The only exception to this is the local instance (as specified by the **DB2INSTANCE** environment variable) which can be specified as the object of an attach, but which cannot be used as a node name in the node directory.

USER *username*

Specifies the authentication identifier. When attaching to a DB2 database instance on a Windows operating system, the user name can be specified in a format compatible with Microsoft® Security Account Manager (SAM). The qualifier must be a flat-style (NetBIOS-like) name, which has a maximum length of 15 characters. For example, *domainname\username*.

USING *password*

Specifies the password for the user name. If a user name is specified, but a password is *not* specified, the user is prompted for the current password. The password is not displayed at entry.

NEW *password*

Specifies the new password that is to be assigned to the user name. The system on which the password will be changed depends on how user authentication has been set up. The DB2 database system provides support for changing passwords on AIX, Linux and Windows operating systems, and supports up to 255 characters for your own written plugins. See *Password rules* for additional information about passwords.

CONFIRM *password*

A string that must be identical to the new password. This parameter is used to catch entry errors.

CHANGE PASSWORD

If this option is specified, the user is prompted for the current password, a new password, and for confirmation of the new password. Passwords are not displayed at entry.

Examples

Catalog two remote nodes:

```
db2 catalog tcpip node node1 remote freedom server server1
db2 catalog tcpip node node2 remote flash server server1
```

Attach to the first node, force all users, and then detach:

```
db2 attach to node1
db2 force application all
db2 detach
```

Attach to the second node, and see who is on:

```
db2 attach to node2
db2 list applications
```

After the command returns agent IDs 1, 2 and 3, force 1 and 3, and then detach:

```
db2 force application (1, 3)
db2 detach
```

Attach to the current instance (not necessary, will be implicit), force all users, then detach (AIX only):

```
db2 attach to $DB2INSTANCE
db2 force application all
db2 detach
```

Usage notes

If *nodename* is omitted from the command, information about the current state of attachment is returned.

If ATTACH has not been executed, instance-level commands are executed against the current instance, specified by the **DB2INSTANCE** environment variable.

Chapter 14. AUTOCONFIGURE

Calculates and displays initial values for the buffer pool size, database configuration and database manager configuration parameters, with the option of applying these recommended values.

Authorization

sysadm

Required connection

Database

Command syntax

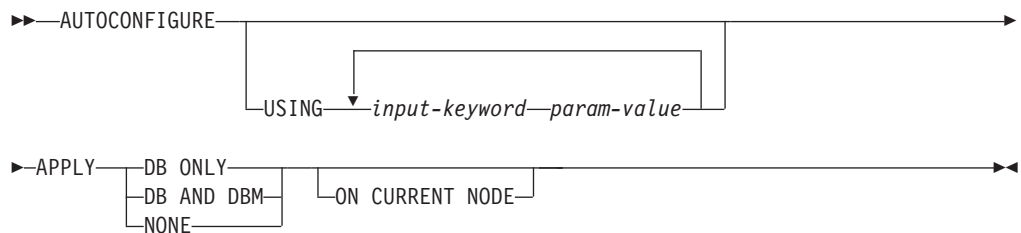

Command parameters

USING *input-keyword param-value*

Table 6. Valid input keywords and parameter values

Keyword	Valid values	Default value	Explanation
mem_percent	1-100	25	Initial percentage of instance memory to dedicate. Configuration advisor will adjust this value for subsequent databases depending on the current memory usage on the system.
workload_type	simple, mixed, complex	mixed	Simple workloads tend to be I/O intensive and mostly transactions, whereas complex workloads tend to be CPU intensive and mostly queries.
num_stmts	1-1 000 000	10	Number of statements per unit of work

Table 6. Valid input keywords and parameter values (continued)

Keyword	Valid values	Default value	Explanation
tpm	1–200 000	60	Transactions per minute
admin_priority	performance, recovery, both	both	Optimize for better performance (more transactions per minute) or better recovery time
is_populated	yes, no	yes	Is the database populated with data?
num_local_apps	0–5 000	0	Number of connected local applications
num_remote_apps	0–5 000	10	Number of connected remote applications
isolation	RR, RS, CS, UR	RR	Maximum isolation level of applications connecting to this database (Repeatable Read, Read Stability, Cursor Stability, Uncommitted Read). It is only used to determine values of other configuration parameters. Nothing is set to restrict the applications to a particular isolation level and it is safe to use the default value.
bp_resizeable	yes, no	yes	Are buffer pools resizeable?

APPLY

DB ONLY

Displays the recommended values for the database configuration and the buffer pool settings based on the current database manager configuration. Applies the recommended changes to the database configuration and the buffer pool settings.

DB AND DBM

Displays and applies the recommended changes to the database manager configuration, the database configuration, and the buffer pool settings.

NONE

Displays the recommended changes, but does not apply them.

ON CURRENT NODE

In the Database Partitioning Feature (DPF), the Configuration Advisor updates the database configuration on all nodes by default. Running with the ON CURRENT NODE option makes the advisor apply the recommended database configuration to the coordinator (connection) node only.

The bufferpool changes are always applied to the system catalogs. Thus, all nodes are affected. The ON CURRENT NODE option does not matter for bufferpool recommendations.

Usage notes

- On systems with multiple logical partitions, the **mem_percent** parameter refers to the percentage of memory that is to be used by all logical partitions. For example, if DB2 uses 25% of the memory on the system, specify 25% regardless of the number of logical partitions. The database configuration recommendations made, however, will be adjusted for one logical partition.
- This command makes configuration recommendations for the currently connected database, assuming that the database is the only active database on the system. If more than one database is active on the system, adjust the **mem_percent** parameter to reflect the current database's share of memory. For example, if the DB2 database uses 80% of the system's memory and there are two active databases on the system that should share the resources equally, specify 40% (80% divided by 2 databases) for the parameter **mem_percent**.
- When explicitly invoking the Configuration Advisor with the AUTOCONFIGURE command, the setting of the DB2_ENABLE_AUTOCONFIG_DEFAULT registry variable will be ignored.
- Running the AUTOCONFIGURE command on a database will recommend enablement of the Self Tuning Memory Manager. However, if you run the AUTOCONFIGURE command on a database in an instance where SHEAPTHRES is not zero, sort memory tuning (SORTHEAP) will not be enabled automatically. To enable sort memory tuning (SORTHEAP), you must set SHEAPTHRES equal to zero using the UPDATE DATABASE MANAGER CONFIGURATION command. Note that changing the value of SHEAPTHRES may affect the sort memory usage in your previously existing databases.

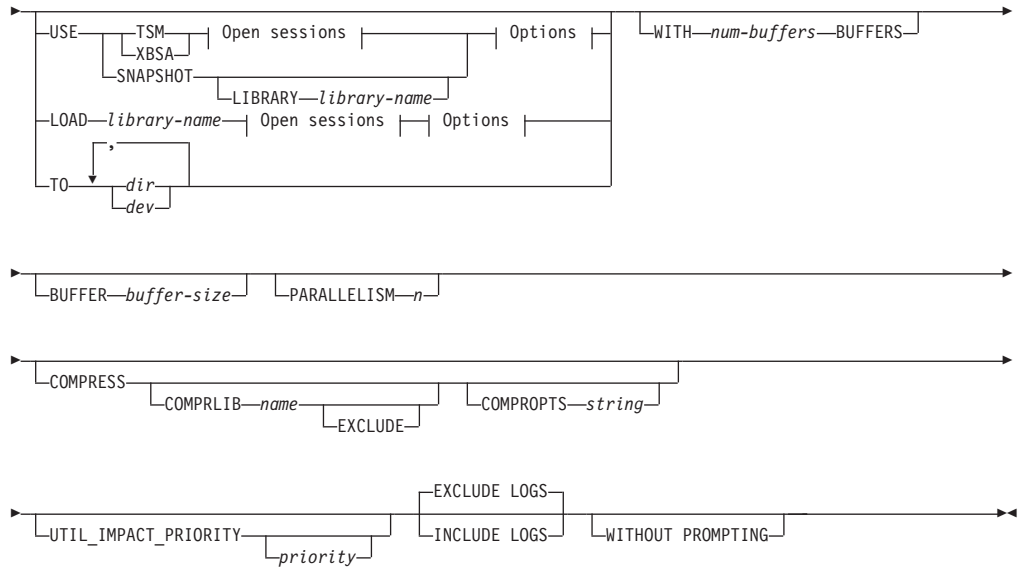

Partition number(s):

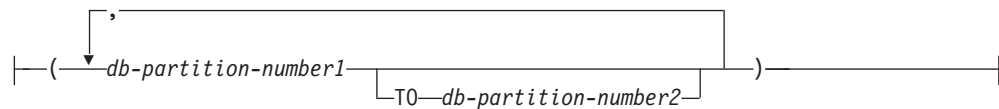

Open sessions:



Options:

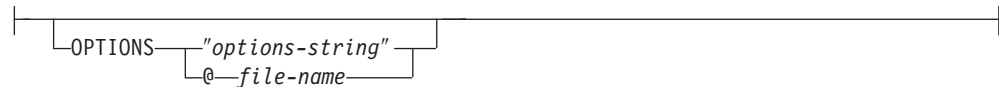

Command parameters

DATABASE | DB *database-alias*

Specifies the alias of the database to back up.

USER *username*

Identifies the user name under which to back up the database.

USING *password*

The password used to authenticate the user name. If the password is omitted, the user is prompted to enter it.

ON Backup the database on a set of database partitions.

DBPARTITIONNUM *db-partition-number1*

Specifies a database partition number in the database partition list.

DBPARTITIONNUMS *db-partition-number1 TO db-partition-number2*

Specifies a range of database partition numbers, so that all

partitions from *db-partition-number1* up to and including *db-partition-number2* are included in the database partition list.

ALL DBPARTITIONNUMS

Specifies that the database is to be backed up on all partitions specified in the `db2nodes.cfg` file.

EXCEPT

Specifies that the database is to be backed up on all partitions specified in the `db2nodes.cfg` file, except those specified in the database partition list.

DBPARTITIONNUM *db-partition-number1*

Specifies a database partition number in the database partition list.

DBPARTITIONNUMS *db-partition-number1 TO db-partition-number2*

Specifies a range of database partition numbers, so that all partitions from *db-partition-number1* up to and including *db-partition-number2* are included in the database partition list.

TABLESPACE *tablespace-name*

A list of names used to specify the table spaces to be backed up.

ONLINE

Specifies online backup. The default is offline backup. Online backups are only available for databases configured with *logretain* or *userexit* enabled. During an online backup, DB2 obtains IN (Intent None) locks on all tables existing in SMS table spaces as they are processed. S (share locks) are no longer held on LOB data in SMS table spaces during online backup.

INCREMENTAL

Specifies a cumulative (incremental) backup image. An incremental backup image is a copy of all database data that has changed since the most recent successful, full backup operation.

DELTA

Specifies a non-cumulative (delta) backup image. A delta backup image is a copy of all database data that has changed since the most recent successful backup operation of any type.

USE

TSM Specifies that the backup is to use Tivoli® Storage Manager (TSM) output.

XBSA Specifies that the XBSA interface is to be used. Backup Services APIs (XBSA) are an open application programming interface for applications or facilities needing data storage management for backup or archiving purposes.

SNAPSHOT

Specifies that a snapshot backup is to be taken.

You cannot use the SNAPSHOT parameter with any of the following parameters:

- TABLESPACE
- INCREMENTAL
- WITH *num-buffers* BUFFERS

- BUFFER
- PARALLELISM
- COMPRESS
- UTIL_IMPACT_PRIORITY
- SESSIONS

The default behavior for a snapshot backup is a FULL DATABASE OFFLINE backup of all paths that make up the database including all containers, local volume directory, database path (DBPATH), and primary log and mirror log paths (INCLUDE LOGS is the default for all snapshot backups unless EXCLUDE LOGS is explicitly stated).

LIBRARY *library-name*

Integrated into IBM Data Server is a DB2 ACS API driver for the following storage hardware:

- IBM TotalStorage SAN Volume Controller
- IBM Enterprise Storage Server Model 800
- IBM System Storage DS6000
- IBM System Storage DS8000
- IBM System Storage N Series
- NetApp V-series
- NetApp FAS

If you have other storage hardware, and a DB2 ACS API driver for that storage hardware, you can use the LIBRARY parameter to specify the DB2 ACS API driver.

The value of the LIBRARY parameter is a fully-qualified library file name.

OPTIONS

"options-string"

Specifies options to be used for the backup operation. The string will be passed to the DB2 ACS API driver exactly as it was entered, without the double quotation marks. You cannot use the **VENDOROPT** database configuration parameter to specify vendor-specific options for snapshot backup operations. You must use the OPTIONS parameter of the backup utilities instead.

@ file-name

Specifies that the options to be used for the backup operation are contained in a file located on the DB2 server. The string will be passed to the vendor support library. The file must be a fully qualified file name.

OPEN *num-sessions* **SESSIONS**

The number of I/O sessions to be created between DB2 and TSM or another backup vendor product. This parameter has no effect when backing up to tape, disk, or other local device.

TO *dir* | *dev*

A list of directory or tape device names. The full path on which the directory resides must be specified. If USE TSM, TO, and LOAD are omitted, the default target directory for the backup image is the current working directory of the client computer. This target directory or device must exist on the database server.

In a partitioned database, the target directory or device must exist on all database partitions, and can optionally be a shared path. The directory or device name may be specified using a database partition expression. For more information about database partition expressions, see *Automatic storage databases*.

This parameter can be repeated to specify the target directories and devices that the backup image will span. If more than one target is specified (target1, target2, and target3, for example), target1 will be opened first. The media header and special files (including the configuration file, table space table, and history file) are placed in target1. All remaining targets are opened, and are then used in parallel during the backup operation. Because there is no general tape support on Windows operating systems, each type of tape device requires a unique device driver.

Use of tape devices or floppy disks might generate messages and prompts for user input. Valid response options are:

- c** Continue. Continue using the device that generated the warning message (for example, when a new tape has been mounted)
- d** Device terminate. Stop using *only* the device that generated the warning message (for example, when there are no more tapes)
- t** Terminate. Abort the backup operation.

If the tape system does not support the ability to uniquely reference a backup image, it is recommended that multiple backup copies of the same database not be kept on the same tape.

LOAD *library-name*

The name of the shared library (DLL on Windows operating systems) containing the vendor backup and restore I/O functions to be used. It can contain the full path. If the full path is not given, it will default to the path on which the user exit program resides.

WITH *num-buffers* **BUFFERS**

The number of buffers to be used. DB2 will automatically choose an optimal value for this parameter unless you explicitly enter a value. However, when creating a backup to multiple locations, a larger number of buffers can be used to improve performance.

BUFFER *buffer-size*

The size, in 4 KB pages, of the buffer used when building the backup image. DB2 will automatically choose an optimal value for this parameter unless you explicitly enter a value. The minimum value for this parameter is 8 pages.

If using tape with variable block size, reduce the buffer size to within the range that the tape device supports. Otherwise, the backup operation might succeed, but the resulting image might not be recoverable.

With most versions of Linux, using DB2's default buffer size for backup operations to a SCSI tape device results in error SQL2025N, reason code 75. To prevent the overflow of Linux internal SCSI buffers, use this formula:

$$\text{bufferpages} \leq \text{ST_MAX_BUFFERS} * \text{ST_BUFFER_BLOCKS} / 4$$

where *bufferpages* is the value you want to use with the BUFFER parameter, and ST_MAX_BUFFERS and ST_BUFFER_BLOCKS are defined in the Linux kernel under the drivers/scsi directory.

PARALLELISM *n*

Determines the number of table spaces which can be read in parallel by the backup utility. DB2 will automatically choose an optimal value for this parameter unless you explicitly enter a value.

UTIL_IMPACT_PRIORITY *priority*

Specifies that the backup will run in throttled mode, with the priority specified. Throttling allows you to regulate the performance impact of the backup operation. Priority can be any number between 1 and 100, with 1 representing the lowest priority, and 100 representing the highest priority. If the UTIL_IMPACT_PRIORITY keyword is specified with no priority, the backup will run with the default priority of 50. If UTIL_IMPACT_PRIORITY is not specified, the backup will run in unthrottled mode. An impact policy must be defined by setting the *util_impact_lim* configuration parameter for a backup to run in throttled mode.

COMPRESS

Indicates that the backup is to be compressed.

COMPRLIB *name*

Indicates the name of the library to be used to perform the compression (e.g., db2compr.dll for Windows; libdb2compr.so for Linux/UNIX systems). The name must be a fully qualified path referring to a file on the server. If this parameter is not specified, the default DB2 compression library will be used. If the specified library cannot be loaded, the backup will fail.

EXCLUDE

Indicates that the compression library will not be stored in the backup image.

COMPROPTS *string*

Describes a block of binary data that will be passed to the initialization routine in the compression library. DB2 will pass this string directly from the client to the server, so any issues of byte reversal or code page conversion will have to be handled by the compression library. If the first character of the data block is '@', the remainder of the data will be interpreted by DB2 as the name of a file residing on the server. DB2 will then replace the contents of string with the contents of this file and will pass this new value to the initialization routine instead. The maximum length for *string* is 1024 bytes.

EXCLUDE LOGS

Specifies that the backup image should not include any log files. When performing an offline backup operation, logs are excluded whether or not this option is specified, with the exception of snapshot backups.

INCLUDE LOGS

Specifies that the backup image should include the range of log files required to restore and roll forward this image to some consistent point in time. This option is not valid for an offline backup, with the exception of snapshot backups where this option is the default unless explicitly told to exclude.

WITHOUT PROMPTING

Specifies that the backup will run unattended, and that any actions which normally require user intervention will return an error message.

Note:

1. If the backup command indicates which partitions in a partitioned database are to be backed up, the backup operation is implicitly performed WITHOUT PROMPTING.
2. Options that are specified on the BACKUP DATABASE command in a partitioned database environment will be applied on each partition individually. For example, if a backup operation is specified to USE TSM OPEN 3 SESSIONS, DB2 will open three TSM sessions on each partition.

Examples

1. In the following example, the database WSDB is defined on all 4 database partitions, numbered 0 through 3. The path /dev3/backup is accessible from all database partitions. Database partition 0 is the catalog partition. To perform an offline backup of all the WSDB database partitions to /dev3/backup, issue the following command from database partition 0:

```
db2 BACKUP DATABASE wsdb ON ALL DBPARTITIONNUMS TO /dev3/backup
```

The backup is performed simultaneously on all partitions. All four database partition backup images will be stored in the /dev3/backup directory, which can be a shared directory accessible from more than one partition, or a locally-mounted directory accessible from each partition individually, or a combination of both.

2. In the following example database SAMPLE is backed up to a TSM server using two concurrent TSM client sessions. DB2 calculates the optimal buffer size for this environment.

```
db2 backup database sample use tsm open 2 sessions with 4 buffers
```

3. In the following example, a table space-level backup of table spaces (syscatspace, userspace1) of database payroll is done to tapes.

```
db2 backup database payroll tablespace (syscatspace, userspace1) to /dev/rmt0, /dev/rmt1 with 8 buffers without prompting
```

4. The USE TSM OPTIONS keywords can be used to specify the TSM information to use for the backup operation. The following example shows how to use the USE TSM OPTIONS keywords to specify a fully qualified file name:

```
db2 backup db sample use TSM options @/u/dmcinnis/myoptions.txt
```

The file myoptions.txt contains the following information: -fromnode=bar -fromowner=dmcinnis

5. Following is a sample weekly incremental backup strategy for a recoverable database. It includes a weekly full database backup operation, a daily non-cumulative (delta) backup operation, and a mid-week cumulative (incremental) backup operation:

```
(Sun) db2 backup db sample use tsm
(Mon) db2 backup db sample online incremental delta use tsm
(Tue) db2 backup db sample online incremental delta use tsm
(Wed) db2 backup db sample online incremental use tsm
(Thu) db2 backup db sample online incremental delta use tsm
(Fri) db2 backup db sample online incremental delta use tsm
(Sat) db2 backup db sample online incremental use tsm
```

6. In the following example, three identical target directories are specified for a backup operation on database SAMPLE. You might want to do this if the target file system is made up of multiple physical disks.

```
db2 backup database sample to /dev3/backup, /dev3/backup, /dev3/backup
```

The data will be concurrently backed up to the three target directories, and three backup images will be generated with extensions .001, .002, and .003.

7. In the following example, the database WSDB is defined on all 4 database partitions, numbered 0 through 3. Database partition 0 is the catalog partition. To perform an online backup of table space USERSPACE1 on database partitions 1 and 2, with the backup image to be stored on a TSM server, issue the following command from partition 0:

```
db2 BACKUP DATABASE wsdb ON DBPARTITIONNUMS (1, 2) TABLESPACE (USERSPACE1)
  ONLINE USE TSM
```

8. Sample output generated to indicate the sqlcode returned by each partition.

Example 1

All partitions are successful (sqlcode >= 0)

```
$ db2 backup db foo on all dbpartitionnums tablespace(T1)
```

Part Result

```
0    DB20000I The BACKUP DATABASE command completed successfully.
1    SQL2430W The database backup succeeded, but the following
      table spaces do not exist on this database partition: "T1".
```

```
Backup successful. The timestamp for this backup image is :
                                           20040908010203
```

Example 2

One or more partitions fail (sqlcode < 0)

```
$ db2 backup db foo on all dbpartitionnums to /backups
```

Part Result

```
0    DB20000I The BACKUP DATABASE command completed successfully.
1    SQL2419N The target disk "/backups" has become full.
```

```
SQL2429N The database backup failed. The following database
      partitions returned errors: "1".
```

9. The following backups will include the log directories in the image created:

```
db2 backup db sample use snapshot
```

```
db2 backup db sample online use snapshot
```

```
db2 backup db sample use snapshot INCLUDE LOGS
```

```
db2 backup db sample online use snapshot INCLUDE LOGS
```

10. The following backups will NOT include the log directories in the image created:

```
db2 backup db sample use snapshot EXCLUDE LOGS
```

```
db2 backup db sample online use snapshot EXCLUDE LOGS
```

Usage notes

The data in a backup cannot be protected by the database server. Make sure that backups are properly safeguarded, particularly if the backup contains LBAC-protected data.

When backing up to tape, use of a variable block size is currently not supported. If you must use this option, ensure that you have well tested procedures in place that enable you to recover successfully, using backup images that were created with a variable block size.

When using a variable block size, you must specify a backup buffer size that is less than or equal to the maximum limit for the tape devices that you are using. For optimal performance, the buffer size must be equal to the maximum block size limit of the device being used.

Snapshot backups should be complemented with regular disk backups in case of failure in the filer/storage system.

As you regularly backup your database, you might accumulate very large database backup images, many database logs and load copy images, all of which might be taking up a large amount of disk space. Refer to "Managing recovery objects" for information on how to manage these recovery objects.

Chapter 16. BIND

Invokes the bind utility, which prepares SQL statements stored in the bind file generated by the precompiler, and creates a package that is stored in the database.

Scope

This command can be issued from any database partition in `db2nodes.cfg`. It updates the database catalogs on the catalog database partition. Its effects are visible to all database partitions.

Authorization

One of the following authorizations:

- `dbadm` authority
- If `SQLERROR CHECK` or `EXPLAIN ONLY` is specified, either `EXPLAIN` or `SQLADM` authority is sufficient.
- If a package does not exist, `BINDADD` authority and:
 - If the schema name of the package does not exist, `IMPLICIT_SCHEMA` authority on the database.
 - If the schema name of the package does exist, `CREATEIN` privilege on the schema.
- If the package exists, one of the following privileges:
 - `ALTERIN` privilege on the schema
 - `BIND` privilege on the package

The user also needs all privileges required to compile any static SQL statements in the application. Privileges granted to groups are not used for authorization checking of static statements.

Required connection

Database. If implicit connect is enabled, a connection to the default database is established.

Command syntax

For DB2 for Linux, Windows and UNIX

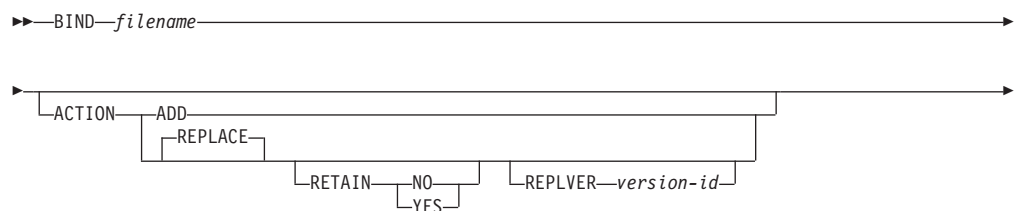

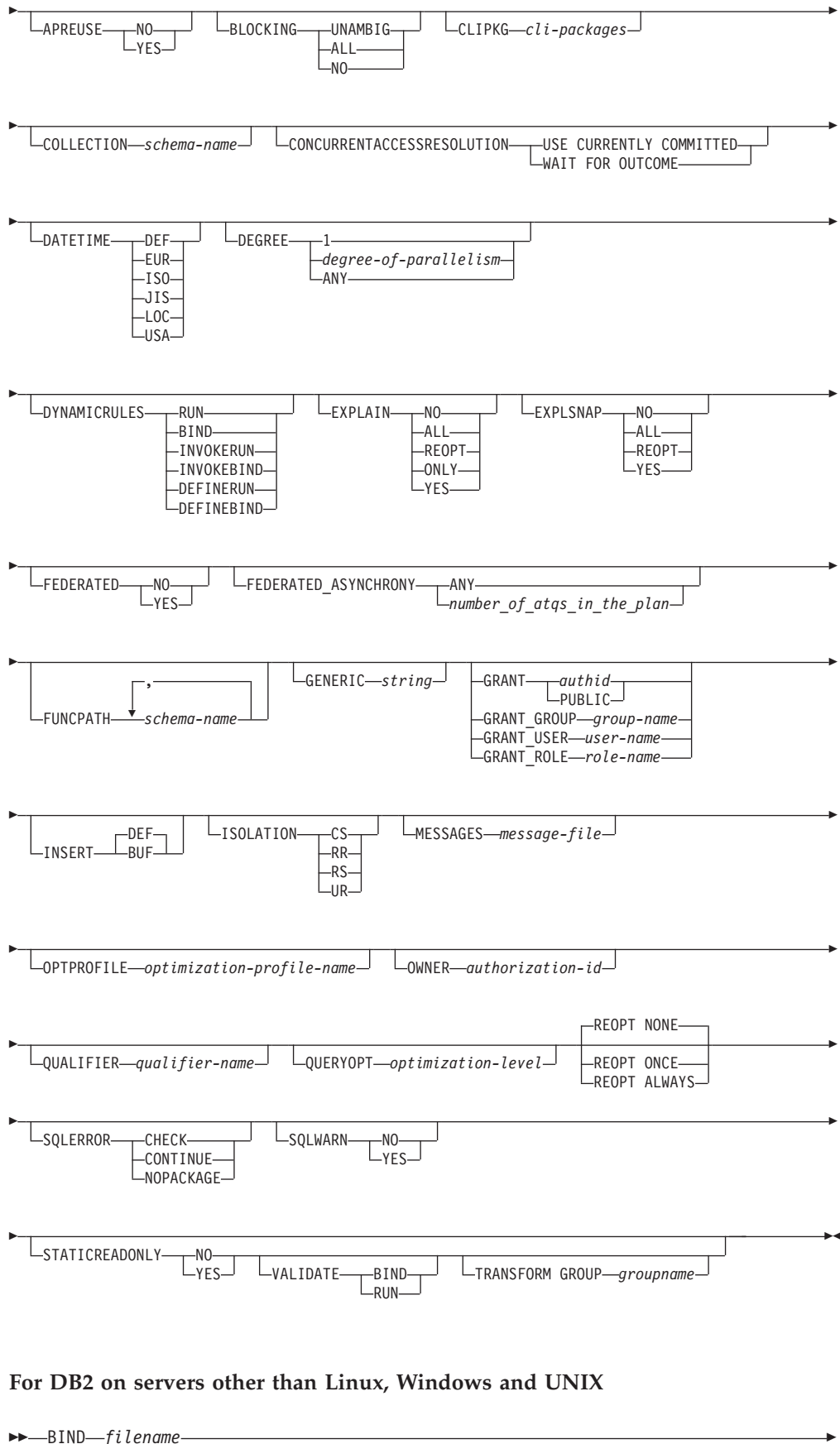

For DB2 on servers other than Linux, Windows and UNIX

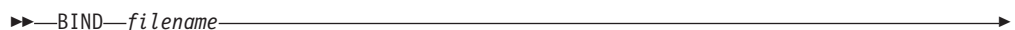

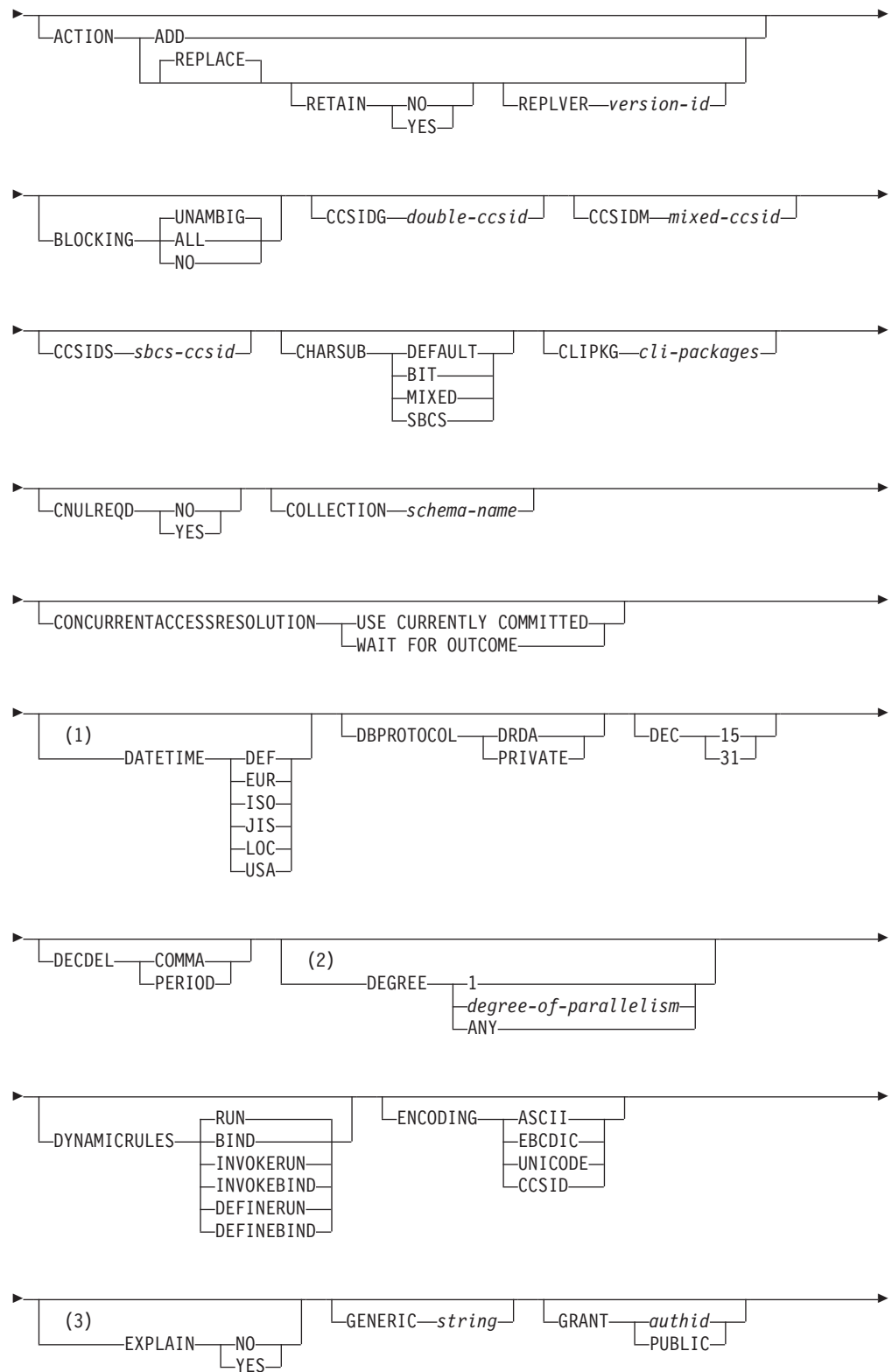

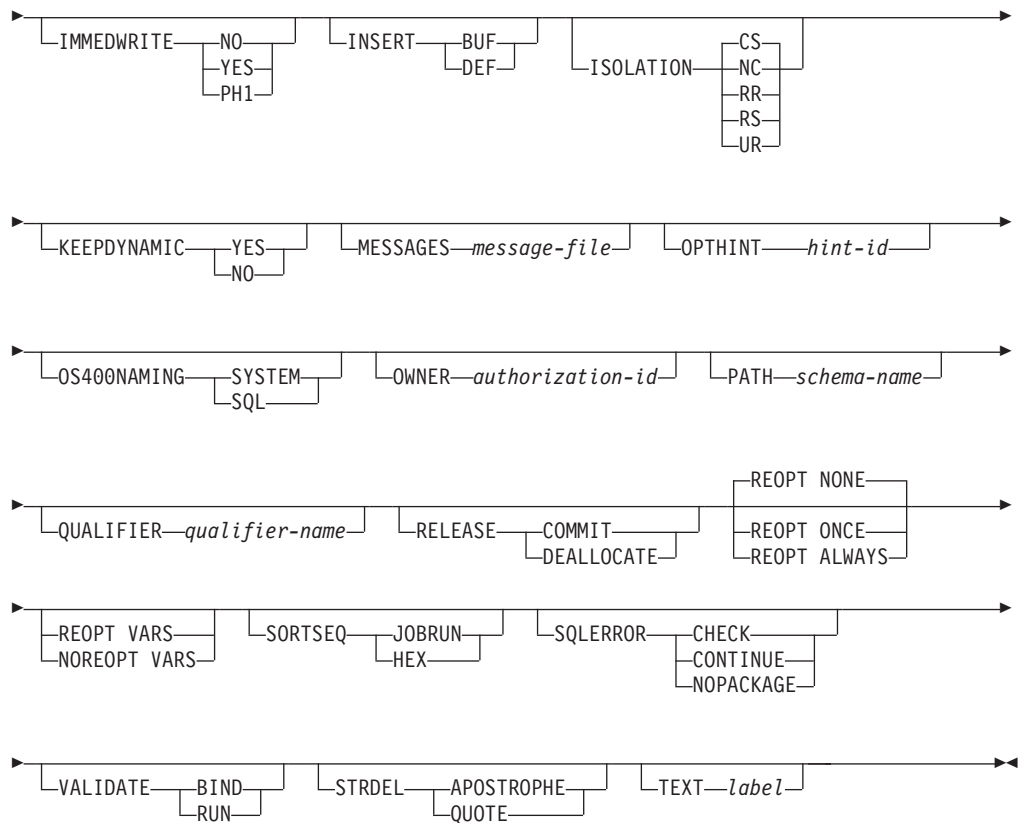

Notes:

- 1 If the server does not support the DATETIME DEF option, it is mapped to DATETIME ISO.
- 2 The DEGREE option is only supported by DRDA® Level 2 Application Servers.
- 3 DRDA defines the EXPLAIN option to have the value YES or NO. If the server does not support the EXPLAIN YES option, the value is mapped to EXPLAIN ALL.

Command parameters

filename

Specifies the name of the bind file that was generated when the application program was precompiled, or a list file containing the names of several bind files. Bind files have the extension .bnd. The full path name can be specified.

If a list file is specified, the @ character must be the first character of the list file name. The list file can contain several lines of bind file names. Bind files listed on the same line must be separated by plus (+) characters, but a + cannot appear in front of the first file listed on each line, or after the last bind file listed. For example,

```
/u/smith/sql1ib/bnd/@all.lst
```

is a list file that contains the following bind files:

```
mybind1.bnd+mybind.bnd2+mybind3.bnd+
mybind4.bnd+mybind5.bnd+
mybind6.bnd+
mybind7.bnd
```

ACTION

Indicates whether the package can be added or replaced.

ADD Indicates that the named package does not exist, and that a new package is to be created. If the package already exists, execution stops, and a diagnostic error message is returned.

REPLACE

Indicates that the existing package is to be replaced by a new one with the same package name and creator. This is the default value for the ACTION option.

RETAIN

Indicates whether BIND and EXECUTE authorities are to be preserved when a package is replaced. If ownership of the package changes, the new owner grants the BIND and EXECUTE authority to the previous package owner.

NO Does not preserve BIND and EXECUTE authorities when a package is replaced. This value is not supported by DB2.

YES Preserves BIND and EXECUTE authorities when a package is replaced. This is the default value.

REPLVER *version-id*

Replaces a specific version of a package. The version identifier specifies which version of the package is to be replaced. If the specified version does not exist, an error is returned. If the REPLVER option of REPLACE is not specified, and a package already exists that matches the package name, creator, and version of the package being bound, that package will be replaced; if not, a new package will be added.

APREUSE

Specifies whether static SQL access plans are to be reused. When this option is enabled, the query compiler will attempt to reuse the access plans for the statement in any existing packages during the bind and during future implicit and explicit rebinds.

YES The query compiler will attempt to reuse the access plans for the statements in the package. If there is an existing package, the query compiler will attempt to reuse the access plan for every statement that can be matched with a statement in the new bind file. For a statement to match, the statement text must be identical and the section number for the statement in the existing package must match what the section number will be for the statement in the new package.

NO The query compiler will not attempt to reuse access plans for the statements in the package. This is the default setting.

BLOCKING

Specifies the type of row blocking for cursors. The blocking of row data that contains references to LOB column data types is also supported in environments where the Database Partitioning Feature (DPF) is enabled.

ALL For cursors that are specified with the FOR READ ONLY clause or cursors not specified as FOR UPDATE, blocking occurs.

Ambiguous cursors are treated as read-only.

NO Blocking does not occur for any cursor.

For the definition of a read-only cursor and an ambiguous cursor, refer to *DECLARE CURSOR statement*.

Ambiguous cursors are treated as updatable.

UNAMBIG

For cursors that are specified with the FOR READ ONLY clause, blocking occurs.

Cursors that are not declared with the FOR READ ONLY or FOR UPDATE clause which are not ambiguous and are read-only will be blocked. Ambiguous cursors will not be blocked.

Ambiguous cursors are treated as updatable.

CCSIDG *double-ccsid*

An integer specifying the coded character set identifier (CCSID) to be used for double byte characters in character column definitions (without a specific CCSID clause) in CREATE and ALTER TABLE SQL statements. This option is not supported by DB2 Database for Linux, UNIX, and Windows. The DRDA server will use a system defined default value if this option is not specified.

CCSIDM *mixed-ccsid*

An integer specifying the coded character set identifier (CCSID) to be used for mixed byte characters in character column definitions (without a specific CCSID clause) in CREATE and ALTER TABLE SQL statements. This option is not supported by DB2 Database for Linux, UNIX, and Windows. The DRDA server will use a system defined default value if this option is not specified.

CCSIDS *sbc-ccsid*

An integer specifying the coded character set identifier (CCSID) to be used for single byte characters in character column definitions (without a specific CCSID clause) in CREATE and ALTER TABLE SQL statements. This option is not supported by DB2 Database for Linux, UNIX, and Windows. The DRDA server will use a system defined default value if this option is not specified.

CHARSUB

Designates the default character sub-type that is to be used for column definitions in CREATE and ALTER TABLE SQL statements. This DRDA precompile/bind option is not supported by DB2 Database for Linux, UNIX, and Windows.

BIT Use the FOR BIT DATA SQL character sub-type in all new character columns for which an explicit sub-type is not specified.

DEFAULT

Use the target system defined default in all new character columns for which an explicit sub-type is not specified.

MIXED

Use the FOR MIXED DATA SQL character sub-type in all new character columns for which an explicit sub-type is not specified.

SBCS Use the FOR SBCS DATA SQL character sub-type in all new character columns for which an explicit sub-type is not specified.

CLIPKG *cli-packages*

An integer between 3 and 30 specifying the number of CLI large packages to be created when binding CLI bind files against a database.

CNULREQD

This option is related to the LANGLEVEL precompile option, which is not supported by DRDA. It is valid only if the bind file is created from a C or a C++ application. This DRDA bind option is not supported by DB2 Database for Linux, UNIX, and Windows.

NO The application was coded on the basis of the LANGLEVEL SAA1 precompile option with respect to the null terminator in C string host variables.

YES The application was coded on the basis of the LANGLEVEL MIA precompile option with respect to the null terminator in C string host variables.

COLLECTION *schema-name*

Specifies a 128-byte collection identifier for the package. If not specified, the authorization identifier for the user processing the package is used.

CONCURRENTACCESSRESOLUTION

Specifies the concurrent access resolution to use for statements in the package.

USE CURRENTLY COMMITTED

Specifies that the database manager can use the currently committed version of the data for applicable scans when it is in the process of being updated or deleted. Rows in the process of being inserted can be skipped. This clause applies when the isolation level in effect is Cursor Stability or Read Stability (for Read Stability it skips uncommitted inserts only) and is ignored otherwise. Applicable scans include read-only scans that can be part of a read-only statement as well as a non read-only statement. The settings for the registry variables **DB2_EVALUNCOMMITTED**, **DB2_SKIPDELETED**, and **DB2_SKIPINSERTED** no longer apply.

WAIT FOR OUTCOME

Specifies Cursor Stability and higher scans to wait for the commit or rollback when encountering data in the process of being updated. Rows in the process of being inserted or deleted rows are not skipped. The settings for the registry variables **DB2_EVALUNCOMMITTED**, **DB2_SKIPDELETED**, and **DB2_SKIPINSERTED** no longer apply.

DATETIME

Specifies the date and time format to be used.

DEF Use a date and time format associated with the territory code of the database.

EUR Use the IBM standard for Europe date and time format.

ISO Use the date and time format of the International Standards Organization.

JIS Use the date and time format of the Japanese Industrial Standard.

LOC Use the date and time format in local form associated with the territory code of the database.

USA Use the IBM standard for U.S. date and time format.

DBPROTOCOL

Specifies what protocol to use when connecting to a remote site that is identified by a three-part name statement. Supported by DB2 for OS/390® only. For a list of supported option values, refer to the documentation for DB2 for OS/390.

DEC Specifies the maximum precision to be used in decimal arithmetic operations. This DRDA precompile/bind option is not supported by DB2 Database for Linux, UNIX, and Windows. The DRDA server will use a system defined default value if this option is not specified.

15 15-digit precision is used in decimal arithmetic operations.

31 31-digit precision is used in decimal arithmetic operations.

DECDEL

Designates whether a period (.) or a comma (,) will be used as the decimal point indicator in decimal and floating point literals. This DRDA precompile/bind option is not supported by DB2 Database for Linux, UNIX, and Windows. The DRDA server will use a system defined default value if this option is not specified.

COMMA

Use a comma (,) as the decimal point indicator.

PERIOD

Use a period (.) as the decimal point indicator.

DEGREE

Specifies the degree of parallelism for the execution of static SQL statements in an SMP system. This option does not affect CREATE INDEX parallelism.

1 The execution of the statement will not use parallelism.

degree-of-parallelism

Specifies the degree of parallelism with which the statement can be executed, a value between 2 and 32 767 (inclusive).

ANY Specifies that the execution of the statement can involve parallelism using a degree determined by the database manager.

DYNAMICRULES

Defines which rules apply to dynamic SQL at run time for the initial setting of the values used for authorization ID and for the implicit qualification of unqualified object references.

RUN Specifies that the authorization ID of the user executing the package is to be used for authorization checking of dynamic SQL statements. The authorization ID will also be used as the default package qualifier for implicit qualification of unqualified object references within dynamic SQL statements. This is the default value.

BIND Specifies that all of the rules that apply to static SQL for authorization and qualification are to be used at run time. That is, the authorization ID of the package owner is to be used for authorization checking of dynamic SQL statements, and the default

package qualifier is to be used for implicit qualification of unqualified object references within dynamic SQL statements.

DEFINERUN

If the package is used within a routine context, the authorization ID of the routine definer is to be used for authorization checking and for implicit qualification of unqualified object references within dynamic SQL statements within the routine.

If the package is used as a standalone application, dynamic SQL statements are processed as if the package were bound with DYNAMICRULES RUN.

DEFINEBIND

If the package is used within a routine context, the authorization ID of the routine definer is to be used for authorization checking and for implicit qualification of unqualified object references within dynamic SQL statements within the routine.

If the package is used as a standalone application, dynamic SQL statements are processed as if the package were bound with DYNAMICRULES BIND.

INVOKERUN

If the package is used within a routine context, the current statement authorization ID in effect when the routine is invoked is to be used for authorization checking of dynamic SQL statements and for implicit qualification of unqualified object references within dynamic SQL statements within that routine.

If the package is used as a standalone application, dynamic SQL statements are processed as if the package were bound with DYNAMICRULES RUN.

INVOKEBIND

If the package is used within a routine context, the current statement authorization ID in effect when the routine is invoked is to be used for authorization checking of dynamic SQL statements and for implicit qualification of unqualified object references within dynamic SQL statements within that routine.

If the package is used as a standalone application, dynamic SQL statements are processed as if the package were bound with DYNAMICRULES BIND.

Because dynamic SQL statements will be using the authorization ID of the package owner in a package exhibiting bind behavior, the binder of the package should not have any authorities granted to them that the user of the package should not receive. Similarly, when defining a routine that will exhibit define behavior, the definer of the routine should not have any authorities granted to them that the user of the package should not receive since a dynamic statement will be using the authorization ID of the routine's definer.

The following dynamically prepared SQL statements cannot be used within a package that was not bound with DYNAMICRULES RUN: GRANT, REVOKE, ALTER, CREATE, DROP, COMMENT ON, RENAME, SET INTEGRITY, and SET EVENT MONITOR STATE.

ENCODING

Specifies the encoding for all host variables in static statements in the plan

or package. Supported by DB2 for OS/390 only. For a list of supported option values, refer to the documentation for DB2 for OS/390.

EXPLAIN

Stores information in the Explain tables about the access plans chosen for each SQL statement in the package. DRDA does not support the ALL value for this option.

NO Explain information will not be captured.

YES Explain tables will be populated with information about the chosen access plan at prep/bind time for static statements and at run time for incremental bind statements.

If the package is to be used for a routine and the package contains incremental bind statements, then the routine must be defined as MODIFIES SQL DATA. If this is not done, incremental bind statements in the package will cause a run time error (SQLSTATE 42985).

REOPT

Explain information for each reoptimizable incremental bind SQL statement is placed in the explain tables at run time. In addition, explain information is gathered for reoptimizable dynamic SQL statements at run time, even if the CURRENT EXPLAIN MODE register is set to NO.

If the package is to be used for a routine, the routine must be defined as MODIFIES SQL DATA, otherwise incremental bind and dynamic statements in the package will cause a run time error (SQLSTATE 42985).

ONLY The ONLY option allows you to explain statements without having the privilege to execute them. The explain tables are populated but no persistent package is created. If an existing package with the same name and version is encountered during the bind process, the existing package is neither dropped nor replaced even if you specified ACTION REPLACE. If an error occurs during population of the explain tables, explain information is not added for the statement that returned the error and for any statements that follow it.

ALL Explain information for each eligible static SQL statement will be placed in the Explain tables at prep/bind time. Explain information for each eligible incremental bind SQL statement will be placed in the Explain tables at run time. In addition, Explain information will be gathered for eligible dynamic SQL statements at run time, even if the CURRENT EXPLAIN MODE register is set to NO.

If the package is to be used for a routine, the routine must be defined as MODIFIES SQL DATA, otherwise incremental bind and dynamic statements in the package will cause a run time error (SQLSTATE 42985). This value for EXPLAIN is not supported by DRDA.

EXPLSNAP

Stores Explain Snapshot information in the Explain tables. This DB2 precompile/bind option is not supported by DRDA.

NO An Explain Snapshot will not be captured.

YES An Explain Snapshot for each eligible static SQL statement will be

placed in the Explain tables at prep/bind time for static statements and at run time for incremental bind statements.

If the package is to be used for a routine and the package contains incremental bind statements, then the routine must be defined as MODIFIES SQL DATA or incremental bind statements in the package will cause a run time error (SQLSTATE 42985).

REOPT

Explain snapshot information for each reoptimizable incremental bind SQL statement is placed in the explain tables at run time. In addition, explain snapshot information is gathered for reoptimizable dynamic SQL statements at run time, even if the CURRENT EXPLAIN SNAPSHOT register is set to NO.

If the package is to be used for a routine, the routine must be defined as MODIFIES SQL DATA, otherwise incremental bind and dynamic statements in the package will cause a run time error (SQLSTATE 42985).

ALL An Explain Snapshot for each eligible static SQL statement will be placed in the Explain tables at prep/bind time. Explain snapshot information for each eligible incremental bind SQL statement will be placed in the Explain tables at run time. In addition, explain snapshot information will be gathered for eligible dynamic SQL statements at run time, even if the CURRENT EXPLAIN SNAPSHOT register is set to NO.

If the package is to be used for a routine, then the routine must be defined as MODIFIES SQL DATA, otherwise incremental bind and dynamic statements in the package will cause a run time error (SQLSTATE 42985).

FEDERATED

Specifies whether a static SQL statement in a package references a nickname or a federated view. If this option is not specified and a static SQL statement in the package references a nickname or a federated view, a warning is returned and the package is created. This option is not supported for DRDA.

NO A nickname or federated view is not referenced in the static SQL statements of the package. If a nickname or federated view is encountered in a static SQL statement during the prepare or bind phase of this package, an error is returned and the package is *not* created.

YES A nickname or federated view can be referenced in the static SQL statements of the package. If no nicknames or federated views are encountered in static SQL statements during the prepare or bind of the package, no errors or warnings are returned and the package is created.

FEDERATED_ASYNCRONY

Specifies the maximum number of asynchrony table queues (ATQs) that the federated server supports in the access plan for programs that use embedded SQL.

ANY The optimizer determines the number of ATQs for the access plan. The optimizer assigns an ATQ to all eligible SHIP or remote pushdown operators in the plan. The value that is specified for

DB2_MAX_ASYNC_REQUESTS_PER_QUERY server option limits the number of asynchronous requests.

number_of_atqs_in_the_plan

The number of ATQs in the plan. You specify a number in the range 0 to 32767.

FUNCPATH

Specifies the function path to be used in resolving user-defined distinct types and functions in static SQL. If this option is not specified, the default function path is "SYSIBM","SYSFUN",USER where USER is the value of the USER special register. This DB2 precompile/bind option is not supported by DRDA.

schema-name

An SQL identifier, either ordinary or delimited, which identifies a schema that exists at the application server. No validation that the schema exists is made at precompile or at bind time. The same schema cannot appear more than once in the function path. The schema name SYSPUBLIC cannot be specified for the function path. The number of schemas that can be specified is limited by the length of the resulting function path, which cannot exceed 2048 bytes. The schema SYSIBM does not need to be explicitly specified; it is implicitly assumed to be the first schema if it is not included in the function path.

GENERIC *string*

Supports the binding of new options that are defined in the target database, but are not supported by DRDA. Do not use this option to pass bind options that *are* defined in BIND or PRECOMPILE. This option can substantially improve dynamic SQL performance. The syntax is as follows:

```
generic "option1 value1 option2 value2 ..."
```

Each option and value must be separated by one or more blank spaces. For example, if the target DRDA database is DB2 Universal Database, Version 8, one could use:

```
generic "explsnap all queryopt 3 federated yes"
```

to bind each of the EXPLSNAP, QUERYOPT, and FEDERATED options.

The maximum length of the string is 32768 bytes.

GRANT

Note: If more than one of the GRANT, GRANT_GROUP, GRANT_USER, and GRANT_ROLE options are specified, only the last option specified is executed.

authid Grants EXECUTE and BIND privileges to a specified user name, role name or group ID. The SQL GRANT statement and its rules are used to determine the type of authid when none of USER, GROUP, or ROLE is provided to specify the type of the grantee on a GRANT statement. For the rules, see *GRANT (Role) statement*.

PUBLIC

Grants EXECUTE and BIND privileges to PUBLIC.

GRANT_GROUP *group-name*

Grants EXECUTE and BIND privileges to a specified group name.

GRANT_USER *user-name*

Grants EXECUTE and BIND privileges to a specified user name.

GRANT_ROLE *role-name*

Grants EXECUTE and BIND privileges to a specified role name.

INSERT

Allows a program being precompiled or bound against a DB2 Enterprise Server Edition server to request that data inserts be buffered to increase performance.

BUF Specifies that inserts from an application should be buffered.

DEF Specifies that inserts from an application should not be buffered.

ISOLATION

Determines how far a program bound to this package can be isolated from the effect of other executing programs.

CS Specifies Cursor Stability as the isolation level.

NC No Commit. Specifies that commitment control is not to be used. This isolation level is not supported by DB2 Database for Linux, UNIX, and Windows.

RR Specifies Repeatable Read as the isolation level.

RS Specifies Read Stability as the isolation level. Read Stability ensures that the execution of SQL statements in the package is isolated from other application processes for rows read and changed by the application.

UR Specifies Uncommitted Read as the isolation level.

IMMEDWRITE

Indicates whether immediate writes will be done for updates made to group buffer pool dependent pagesets or database partitions. Supported by DB2 for OS/390 only. For a list of supported option values, refer to the documentation for DB2 for OS/390.

KEEPDYNAMIC

Specifies whether dynamic SQL statements are to be kept after commit points. Supported by DB2 for OS/390 only. For a list of supported option values, refer to the documentation for DB2 for OS/390.

MESSAGES *message-file*

Specifies the destination for warning, error, and completion status messages. A message file is created whether the bind is successful or not. If a message file name is not specified, the messages are written to standard output. If the complete path to the file is not specified, the current directory is used. If the name of an existing file is specified, the contents of the file are overwritten.

OPTHINT

Controls whether query optimization hints are used for static SQL. Supported by DB2 for OS/390 only. For a list of supported option values, refer to the documentation for DB2 for OS/390.

OPTPROFILE *optimization-profile-name*

Specifies the name of an existing optimization profile to be used for all static statements in the package. The default value of the option is an empty string. The value also applies as the default for dynamic preparation of DML statements for which the CURRENT OPTIMIZATION PROFILE

special register is null. If the specified name is unqualified, it is an SQL identifier, which is implicitly qualified by the QUALIFIER bind option.

The BIND command does not process the optimization file, but only validates that the name is syntactically valid. Therefore if the optimization profile does not exist or is invalid, an SQL0437W warning with reason code 13 will not occur until a DML statement is optimized using that optimization profile.

OS400NAMING

Specifies which naming option is to be used when accessing DB2 for System i® data. Supported by DB2 for System i only. For a list of supported option values, refer to the documentation for DB2 for System i.

Because of the slashes used as separators, a DB2 utility can still report a syntax error at execution time on certain SQL statements which use the System i system naming convention, even though the utility might have been precompiled or bound with the OS400NAMING SYSTEM option. For example, the Command Line Processor will report a syntax error on an SQL CALL statement if the System i system naming convention is used, whether or not it has been precompiled or bound using the OS400NAMING SYSTEM option.

OWNER *authorization-id*

Designates a 128-byte authorization identifier for the package owner. The owner must have the privileges required to execute the SQL statements contained in the package. Only a user with DBADM authority can specify an authorization identifier other than the user ID. The default value is the authorization ID of the invoker of the precompile/bind process. SYSIBM, SYSCAT, and SYSSTAT are not valid values for this option. The *authorization-id* must be a user. A role or a group cannot be specified using the OWNER option.

PATH Specifies the function path to be used in resolving user-defined distinct types and functions in static SQL. If this option is not specified, the default function path is "SYSIBM","SYSFUN",USER where USER is the value of the USER special register.

schema-name

An SQL identifier, either ordinary or delimited, which identifies a schema that exists at the application server. No validation that the schema exists is made at precompile or at bind time.

QUALIFIER *qualifier-name*

Provides a 128-byte implicit qualifier for unqualified objects contained in the package. The default is the owner's authorization ID, whether or not **owner** is explicitly specified.

QUERYOPT *optimization-level*

Indicates the desired level of optimization for all static SQL statements contained in the package. The default value is 5. The SET CURRENT QUERY OPTIMIZATION statement describes the complete range of optimization levels available. This DB2 precompile/bind option is not supported by DRDA.

RELEASE

Indicates whether resources are released at each COMMIT point, or when the application terminates. This DRDA precompile/bind option is not supported by DB2 Database for Linux, UNIX, and Windows.

COMMIT

Release resources at each COMMIT point. Used for dynamic SQL statements.

DEALLOCATE

Release resources only when the application terminates.

SORTSEQ

Specifies which sort sequence table to use on System i. Supported by DB2 for System i only. For a list of supported option values, refer to the documentation for DB2 for System i.

SQLERROR

Indicates whether to create a package or a bind file if an error is encountered.

CHECK

Specifies that the target system performs all syntax and semantic checks on the SQL statements being bound. A package will not be created as part of this process. If, while binding, an existing package with the same name and version is encountered, the existing package is neither dropped nor replaced even if ACTION REPLACE was specified.

CONTINUE

Creates a package, even if errors occur when binding SQL statements. Those statements that failed to bind for authorization or existence reasons can be incrementally bound at execution time if VALIDATE RUN is also specified. Any attempt to execute them at run time generates an error (SQLCODE -525, SQLSTATE 51015).

NOPACKAGE

A package or a bind file is not created if an error is encountered.

REOPT

Specifies whether to have DB2 determine an access path at run time using values for host variables, parameter markers, global variables, and special registers. Valid values are:

NONE

The access path for a given SQL statement containing host variables, parameter markers, global variables, or special registers will not be optimized using real values. The default estimates for these variables is used, and the plan is cached and will be used subsequently. This is the default value.

ONCE The access path for a given SQL statement will be optimized using the real values of the host variables, parameter markers, global variables, or special registers when the query is first executed. This plan is cached and used subsequently.

ALWAYS

The access path for a given SQL statement will always be compiled and reoptimized using the values of the host variables, parameter markers, global variables, or special registers that are known each time the query is executed.

REOPT | NOREOPT VARS

These options have been replaced by REOPT ALWAYS and REOPT NONE; however, they are still supported for previous compatibility. Specifies whether to have DB2 determine an access path at run time using values for

host variables, global variables, parameter markers, and special registers. Supported by DB2 for OS/390 only. For a list of supported option values, refer to the documentation for DB2 for OS/390.

SQLWARN

Indicates whether warnings will be returned from the compilation of dynamic SQL statements (via PREPARE or EXECUTE IMMEDIATE), or from describe processing (via PREPARE...INTO or DESCRIBE).

NO Warnings will not be returned from the SQL compiler.

YES Warnings will be returned from the SQL compiler.

SQLCODE +236, +237 and +238 are exceptions. They are returned regardless of the SQLWARN option value.

STATICREADONLY

Determines whether static cursors will be treated as being READ ONLY. This DB2 precompile/bind option is not supported by DRDA.

NO All static cursors will take on the attributes as would normally be generated given the statement text and the setting of the LANGLEVEL precompile option. This is the default value.

YES Any static cursor that does not contain the FOR UPDATE or FOR READ ONLY clause will be considered READ ONLY.

STRDEL

Designates whether an apostrophe (') or double quotation marks (") will be used as the string delimiter within SQL statements. This DRDA precompile/bind option is not supported by DB2 Database for Linux, UNIX, and Windows. The DRDA server will use a system defined default value if this option is not specified.

APOSTROPHE

Use an apostrophe (') as the string delimiter.

QUOTE

Use double quotation marks (") as the string delimiter.

TEXT *label*

The description of a package. Maximum length is 255 characters. The default value is blanks. This DRDA precompile/bind option is not supported by DB2 Database for Linux, UNIX, and Windows.

TRANSFORM GROUP

Specifies the transform group name to be used by static SQL statements for exchanging user-defined structured type values with host programs. This transform group is not used for dynamic SQL statements or for the exchange of parameters and results with external functions or methods. This option is not supported by DRDA.

groupname

An SQL identifier of up to 18 bytes in length. A group name cannot include a qualifier prefix and cannot begin with the prefix SYS since this is reserved for database use. In a static SQL statement that interacts with host variables, the name of the transform group to be used for exchanging values of a structured type is as follows:

- The group name in the TRANSFORM GROUP bind option, if any

- The group name in the TRANSFORM GROUP prep option as specified at the original precompilation time, if any
- The DB2_PROGRAM group, if a transform exists for the given type whose group name is DB2_PROGRAM
- No transform group is used if none of the above conditions exist.

The following errors are possible during the bind of a static SQL statement:

- SQLCODE yyyyyy, SQLSTATE xxxxx: A transform is needed, but no static transform group has been selected.
- SQLCODE yyyyyy, SQLSTATE xxxxx: The selected transform group does not include a necessary transform (TO SQL for input variables, FROM SQL for output variables) for the data type that needs to be exchanged.
- SQLCODE yyyyyy, SQLSTATE xxxxx: The result type of the FROM SQL transform is not compatible with the type of the output variable, or the parameter type of the TO SQL transform is not compatible with the type of the input variable.

In these error messages, *yyyyyy* is replaced by the SQL error code, and *xxxxx* by the SQL state code.

VALIDATE

Determines when the database manager checks for authorization errors and object not found errors. The package owner authorization ID is used for validity checking.

BIND Validation is performed at precompile/bind time. If all objects do not exist, or all authority is not held, error messages are produced. If `SQLERROR CONTINUE` is specified, a package/bind file is produced despite the error message, but the statements in error are not executable.

RUN Validation is attempted at bind time. If all objects exist, and all authority is held, no further checking is performed at execution time.

If all objects do not exist, or all authority is not held at precompile/bind time, warning messages are produced, and the package is successfully bound, regardless of the `SQLERROR CONTINUE` option setting. However, authority checking and existence checking for SQL statements that failed these checks during the precompile/bind process can be redone at execution time.

Examples

The following example binds `myapp.bnd` (the bind file generated when the `myapp.sqc` program was precompiled) to the database to which a connection has been established:

```
db2 bind myapp.bnd
```

Any messages resulting from the bind process are sent to standard output.

Usage notes

Binding a package using the REOPT option with the ONCE or ALWAYS value specified might change the static and dynamic statement compilation and performance.

Binding can be done as part of the precompile process for an application program source file, or as a separate step at a later time. Use BIND when binding is performed as a separate process.

The name used to create the package is stored in the bind file, and is based on the source file name from which it was generated (existing paths or extensions are discarded). For example, a precompiled source file called `myapp.sql` generates a default bind file called `myapp.bnd` and a default package name of `MYAPP`. However, the bind file name and the package name can be overridden at precompile time by using the `BINDFILE` and the `PACKAGE` options.

Binding a package with a schema name that does not already exist results in the implicit creation of that schema. The schema owner is `SYSIBM`. The `CREATEIN` privilege on the schema is granted to `PUBLIC`.

`BIND` executes under the transaction that was started. After performing the bind, `BIND` issues a `COMMIT` or a `ROLLBACK` to terminate the current transaction and start another one.

Binding stops if a fatal error or more than 100 errors occur. If a fatal error occurs, the utility stops binding, attempts to close all files, and discards the package.

When a package exhibits bind behavior, the following will be true:

1. The implicit or explicit value of the `BIND` option `OWNER` will be used for authorization checking of dynamic SQL statements.
2. The implicit or explicit value of the `BIND` option `QUALIFIER` will be used as the implicit qualifier for qualification of unqualified objects within dynamic SQL statements.
3. The value of the special register `CURRENT SCHEMA` has no effect on qualification.

In the event that multiple packages are referenced during a single connection, all dynamic SQL statements prepared by those packages will exhibit the behavior as specified by the `DYNAMICRULES` option for that specific package and the environment they are used in.

Parameters displayed in the `SQL0020W` message are correctly noted as errors, and will be ignored as indicated by the message.

If an SQL statement is found to be in error and the `BIND` option `SQLERROR CONTINUE` was specified, the statement will be marked as invalid. In order to change the state of the SQL statement, another `BIND` must be issued. Implicit and explicit rebind will not change the state of an invalid statement. In a package bound with `VALIDATE RUN`, a statement can change from static to incremental bind or incremental bind to static across implicit and explicit rebinds depending on whether or not object existence or authority problems exist during the rebind.

The privileges from the roles granted to the authorization identifier used to bind the package (the value of the `OWNER` bind option) or to `PUBLIC`, are taken into

account when binding a package. Roles acquired through groups, in which the authorization identifier used to bind the package is a member, will not be used.

For an embedded SQL program, if the bind option is not explicitly specified the static statements in the package are bound using the `FEDERATED_ASYNC` configuration parameter. If the `FEDERATED_ASYNC` bind option is specified explicitly, that value is used for binding the packages and is also the initial value of the special register. Otherwise, the value of the database manager configuration parameter is used as the initial value of the special register. The `FEDERATED_ASYNC` bind option influences dynamic SQL only when it is explicitly set.

The value of the `FEDERATED_ASYNC` bind option is recorded in the `FEDERATED_ASYNC` column in the `SYSCAT.PACKAGES` catalog table. When the bind option is not explicitly specified, the value of `FEDERATED_ASYNC` configuration parameter is used and the catalog shows a value of -2 for the `FEDERATED_ASYNC` column.

If the `FEDERATED_ASYNC` bind option is not explicitly specified when a package is bound, and if this package is implicitly or explicitly rebound, the package is rebound using the current value of the `FEDERATED_ASYNC` configuration parameter.

Chapter 17. CATALOG DATABASE

Stores database location information in the system database directory. The database can be located either on the local workstation or on a remote database partition server.

Scope

In a partitioned database environment, when cataloging a local database into the system database directory, this command must be issued from a database partition on the server where the database resides.

Authorization

One of the following:

- SYSADM
- SYSCTRL

Required connection

None. Directory operations affect the local directory only.

Command syntax

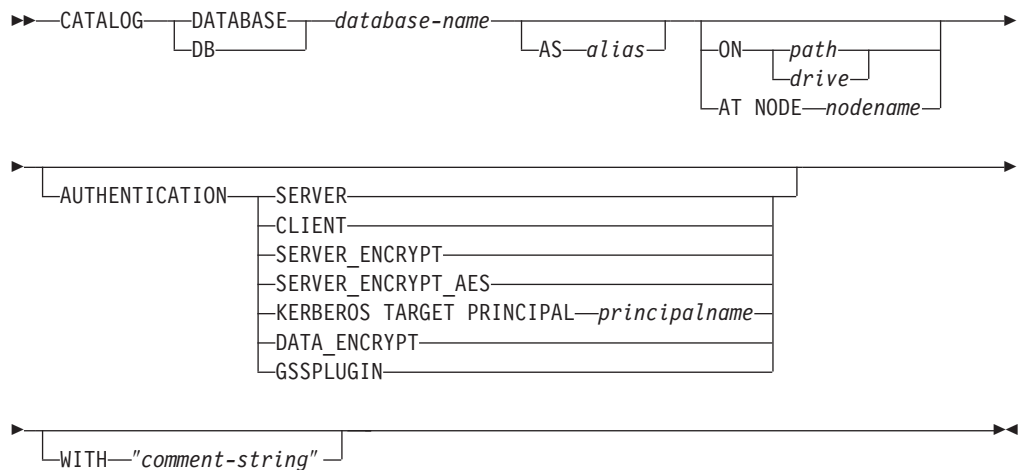

Command parameters

DATABASE *database-name*

Specifies the name of the database to catalog.

AS *alias*

Specifies an alias as an alternate name for the database being cataloged. If an alias is not specified, the database manager uses *database-name* as the alias.

ON *path | drive*

Specifies the path on which the database being cataloged resides. On

Windows operating systems, may instead specify the letter of the drive on which the database being cataloged resides (if it was created on a drive, not on a specific path).

AT NODE *nodename*

Specifies the name of the database partition server where the database being cataloged resides. This name should match the name of an entry in the node directory. If the node name specified does not exist in the node directory, a warning is returned, but the database is cataloged in the system database directory. The node name should be cataloged in the node directory if a connection to the cataloged database is desired.

AUTHENTICATION

The authentication value is stored for remote databases (it appears in the output from the LIST DATABASE DIRECTORY command) but it is not stored for local databases.

Specifying an authentication type can result in a performance benefit.

SERVER

Specifies that authentication takes place on the database partition server containing the target database.

CLIENT

Specifies that authentication takes place on the database partition server where the application is invoked.

SERVER_ENCRYPT

Specifies that authentication takes place on the database partition server containing the target database, and that user IDs and passwords are encrypted at the source. User IDs and passwords are decrypted at the target, as specified by the authentication type cataloged at the source.

KERBEROS

Specifies that authentication takes place using Kerberos Security Mechanism.

TARGET PRINCIPAL *principalname*

Fully qualified Kerberos principal name for the target server; that is, the fully qualified Kerberos principal of the DB2 instance owner in the form of name/instance@REALM. For Windows 2000, Windows XP, and Windows Server 2003, this is the logon account of the DB2 server service in the form of *userid@DOMAIN*, *userid@xxx.xxx.xxx.com* or *domain\userid*.

DATA_ENCRYPT

Specifies that authentication takes place on the database partition server containing the target database, and that connections must use data encryption.

GSSPLUGIN

Specifies that authentication takes place using an external GSS API-based plug-in security mechanism.

SERVER_ENCRYPT_AES

Specifies that authentication takes place on the database partition server containing the target database, and that user IDs and

passwords are encrypted with an Advanced Encryption Standard (AES) encryption algorithm at the source and decrypted at the target.

WITH *"comment-string"*

Describes the database or the database entry in the system database directory. The maximum length of a comment string is 30 characters. A carriage return or a line feed character is not permitted. The comment text must be enclosed by double quotation marks.

Examples

```
db2 catalog database sample on /databases/sample
with "Sample Database"
```

Usage notes

Use CATALOG DATABASE to catalog databases located on local or remote database partition servers, recatalog databases that were uncataloged previously, or maintain multiple aliases for one database (regardless of database location).

DB2 automatically catalogs databases when they are created. It catalogs an entry for the database in the local database directory and another entry in the system database directory. If the database is created from a remote client (or a client which is executing from a different instance on the same machine), an entry is also made in the system database directory at the client instance.

If neither path nor database partition server name is specified, the database is assumed to be local, and the location of the database is assumed to be that specified in the database manager configuration parameter **dftdbpath**.

Databases on the same database partition server as the database manager instance are cataloged as *indirect* entries. Databases on other database partition servers are cataloged as *remote* entries.

CATALOG DATABASE automatically creates a system database directory if one does not exist. The system database directory is stored on the path that contains the database manager instance that is being used, and is maintained outside of the database.

List the contents of the system database directory using the LIST DATABASE DIRECTORY command. To list the contents of the local database directory use the LIST DATABASE DIRECTORY **ON** *path*, where *path* is where the database was created.

If directory caching is enabled, database, node and DCS directory files are cached in memory. To see if directory caching is enabled, check the value for the *dir_cache* directory cache support configuration parameter in the output from the GET DATABASE MANAGER CONFIGURATION command. An application's directory cache is created during its first directory lookup. Since the cache is only refreshed when the application modifies any of the directory files, directory changes made by other applications might not be effective until the application has restarted.

To refresh the CLP's directory cache, use the TERMINATE command. To refresh the database manager's shared cache, stop (db2stop) and then restart (db2start) the database manager. To refresh the directory cache for another application, stop and then restart that application.

Chapter 18. CATALOG DCS DATABASE

Stores information about remote host or System i databases in the Database Connection Services (DCS) directory. These databases are accessed through an Application Requester (AR), such as DB2® Connect™. Having a DCS directory entry with a database name matching a database name in the system database directory invokes the specified AR to forward SQL requests to the remote server where the database resides.

Authorization

One of the following:

- *sysadm*
- *sysctrl*

Required connection

None

Command syntax

```
▶▶ CATALOG DCS DATABASE database-name AS target-database-name
    DB
    AR library-name PARS "parameter-string"
    WITH "comment-string" ▶▶
```

Command parameters

DATABASE *database-name*

Specifies the alias of the target database to catalog. This name should match the name of an entry in the database directory that is associated with the remote database partition server.

AS *target-database-name*

Specifies the name of the target host or System i database to catalog.

AR *library-name*

Specifies the name of the Application Requester library that is loaded and used to access a remote database listed in the DCS directory.

If using the DB2 Connect AR, do not specify a library name. The default value will cause DB2 Connect to be invoked.

If not using DB2 Connect, specify the library name of the AR, and place that library on the same path as the database manager libraries. On Windows operating systems, the path is drive:\sql11b\bin. On UNIX based systems, the path is \$HOME/sql11b/lib of the instance owner.

PARMS "*parameter-string*"

Specifies a parameter string that is to be passed to the AR when it is invoked. The parameter string must be enclosed by double quotation

marks. For more information on the parameter string, refer to the "DCS directory values" topic through the **Related concepts** section.

WITH *"comment-string"*

Describes the DCS directory entry. Any comment that helps to describe the database cataloged in this directory can be entered. Maximum length is 30 characters. A carriage return or a line feed character is not permitted. The comment text must be enclosed by double quotation marks.

Examples

The following example catalogs information about the DB1 database, which is a DB2 for z/OS® database, into the DCS directory:

```
db2 catalog dcs database db1 as dsn_db_1
with "DB2/z/OS location name DSN_DB_1"
```

Usage notes

The DB2 Connect program provides connections to DRDA Application Servers such as:

- DB2 for OS/390 or z/OS databases on System/370™ and System/390® architecture host computers.
- DB2 for VM and VSE databases on System/370 and System/390 architecture host computers.
- System i databases on Application System/400® (System i) and System i computers.

The database manager creates a Database Connection Services directory if one does not exist. This directory is stored on the path that contains the database manager instance that is being used. The DCS directory is maintained outside of the database.

The database must also be cataloged as a remote database in the system database directory .

List the contents of the DCS directory using the LIST DCS DIRECTORY command.

If directory caching is enabled, database, node, and DCS directory files are cached in memory. An application's directory cache is created during its first directory lookup. Since the cache is only refreshed when the application modifies any of the directory files, directory changes made by other applications might not be effective until the application has restarted.

To refresh the CLP's directory cache, use the TERMINATE command. To refresh DB2's shared cache, stop (db2stop) and then restart (db2start) the database manager. To refresh the directory cache for another application, stop and then restart that application.

Chapter 19. CATALOG LDAP DATABASE

Registers the database in Lightweight Directory Access Protocol (LDAP).

Authorization

None

Required connection

None

Command syntax

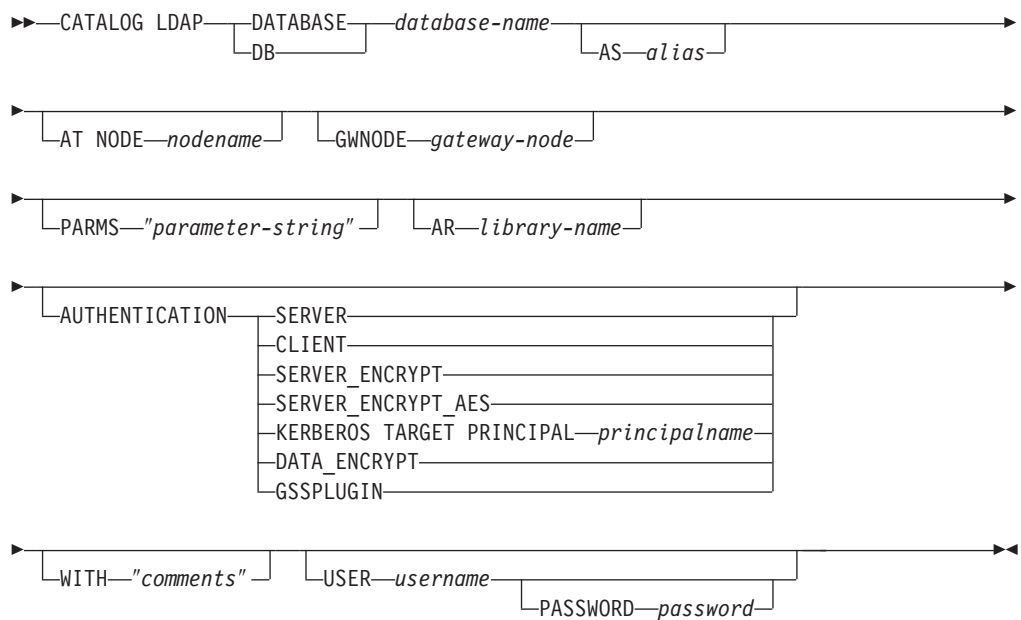

Command parameters

DATABASE *database-name*

Specifies the name of the database to catalog.

AS *alias*

Specifies an alias as an alternate name for the database being cataloged. If an alias is not specified, the database name is used as the alias.

AT NODE *nodename*

Specifies the LDAP node name for the database server on which the database resides. This parameter must be specified when registering a database on a remote server.

GWNODE *gateway-node*

Specifies the LDAP node name for the gateway server.

PARMS *"parameter-string"*

Specifies a parameter string that is passed to the Application Requester (AR) when accessing DCS databases. The change password *sym_dest_name*

should not be specified in the parameter string. Use the keyword **CHGPWDLU** to specify the change password LU name when registering the DB2 server in LDAP.

AR *library-name*

Specifies the name of the Application Requester library that is loaded and used to access a remote database listed in the DCS directory.

If using the DB2 Connect AR, do not specify a library name. The default value will cause DB2 Connect to be invoked.

If not using DB2 Connect, specify the library name of the AR, and place that library on the same path as the database manager libraries. On Windows operating systems, the path is drive:\sqlib\ddl. On UNIX operating systems, the path is \$HOME/sqlib/lib of the instance owner.

AUTHENTICATION

Specifies the authentication level. Valid values are:

SERVER

Specifies that authentication takes place on the node containing the target database.

CLIENT

Specifies that authentication takes place on the node from which the application is invoked.

SERVER_ENCRYPT

Specifies that authentication takes place on the database partition server containing the target database, and that user IDs and passwords are encrypted at the source. User IDs and passwords are decrypted at the target, as specified by the authentication type cataloged at the source.

SERVER_ENCRYPT_AES

Specifies that authentication takes place on the database partition server containing the target database, and that user IDs and passwords are encrypted with an Advanced Encryption Standard (AES) encryption algorithm at the source and decrypted at the target.

KERBEROS

Specifies that authentication takes place using Kerberos Security Mechanism.

TARGET PRINCIPAL *principalname*

Fully qualified Kerberos principal name for the target server; that is, the logon account of the DB2 server service in the form of *userid@xxx.xxx.xxx.com* or *domain\userid*.

DATA_ENCRYPT

Specifies that authentication takes place on the node containing the target database, and that connections must use data encryption.

GSSPLUGIN

Specifies that authentication takes place using an external GSS API-based plug-in security mechanism.

WITH *"comments"*

Describes the DB2 server. Any comment that helps to describe the server registered in the network directory can be entered. Maximum length is 30

characters. A carriage return or a line feed character is not permitted. The comment text must be enclosed by double quotation marks.

USER *username*

Specifies the user's LDAP distinguished name (DN). The LDAP user DN must have sufficient authority to create the object in the LDAP directory. If the user's LDAP DN is not specified, the credentials of the current logon user will be used. If the user's LDAP DN and password have been specified using `db2ldcfg`, the user name and password do not have to be specified here.

PASSWORD *password*

Account password. If the user's LDAP DN and password have been specified using `db2ldcfg`, the user name and password do not have to be specified here.

Usage notes

If the node name is not specified, DB2 will use the first node in LDAP that represents the DB2 server on the current machine.

It might be necessary to manually register (catalog) the database in LDAP if:

- The database server does not support LDAP. The administrator must manually register each database in LDAP to allow clients that support LDAP to access the database without having to catalog the database locally on each client machine.
- The application wants to use a different name to connect to the database. In this case, the administrator can catalog the database using a different alias name.
- The database resides at the host or System i database server. In this case, the administrator can register the database in LDAP and specify the gateway node through the **GWNODE** parameter.
- During `CREATE DATABASE IN LDAP` the database name already exists in LDAP. The database is still created on the local machine (and can be accessed by local applications), but the existing entry in LDAP will not be modified to reflect the new database. In this case, the administrator can:
 - Remove the existing database entry in LDAP and manually register the new database in LDAP.
 - Register the new database in LDAP using a different alias name.

Chapter 20. CATALOG LDAP NODE

Catalogs a new node entry in Lightweight Directory Access Protocol (LDAP).

Authorization

None

Required connection

None

Command syntax

```
▶▶ CATALOG LDAP NODE nodename AS nodealias
└──┬── USER username ───┬── PASSWORD password ───┘
```

Command parameters

NODE *nodename*

Specifies the LDAP node name of the DB2 server.

AS *nodealias*

Specifies a new alias name for the LDAP node entry.

USER *username*

Specifies the user's LDAP distinguished name (DN). The LDAP user DN must have sufficient authority to create the object in the LDAP directory. If the user's LDAP DN is not specified, the credentials of the current logon user will be used.

PASSWORD *password*

Account password.

Usage notes

The CATALOG LDAP NODE command is used to specify a different alias name for the node that represents the DB2 server.

Chapter 21. CATALOG LOCAL NODE

Creates a local alias for an instance that resides on the same machine. A local node should be cataloged when there is more than one instance on the same workstation to be accessed from the user's client. Interprocess Communications (IPC) is used to access the local node.

Authorization

One of the following:

- *sysadm*
- *sysctrl*

Required connection

None

Command syntax

```
➤➤ CATALOG [ADMIN] LOCAL NODE nodename [INSTANCE instancename]  
[SYSTEM system-name] [OSTYPE operating-system-type]  
[WITH "comment-string"]
```

Command parameters

ADMIN

Specifies that a local administration server node is to be cataloged.

INSTANCE *instancename*

Name of the local instance to be accessed.

SYSTEM *system-name*

Specifies the DB2 system name that is used to identify the server machine.

OSTYPE *operating-system-type*

Specifies the operating system type of the server machine. Valid values are: AIX, WIN, HPUX, SUN, OS390, OS400, VM, VSE, SNI, SCO, LINUX and DYNIX.

Examples

Workstation A has two server instances, *inst1* and *inst2*. To create databases at both instances from a single CLP session, issue the following sequence of commands (assume the DB2INSTANCE environment variable is set to *inst1*):

1. Create a local database at *inst1*:
db2 create database mydb1
2. Catalog another server instance on this workstation:
db2 catalog local node mynode2 instance inst2

3. Create a database at mynode2:

```
db2 attach to mynode2
db2 create database mydb2
```

Usage notes

If directory caching is enabled, database, node, and DCS directory files are cached in memory. An application's directory cache is created during its first directory lookup. Since the cache is only refreshed when the application modifies any of the directory files, directory changes made by other applications might not be effective until the application has restarted.

To refresh the CLP's directory cache, use TERMINATE. To refresh DB2's shared cache, stop (db2stop) and then restart (db2start) the database manager. To refresh the directory cache for another application, stop and then restart that application.

Chapter 22. CATALOG NAMED PIPE NODE

Adds a named pipe node entry to the node directory. The named pipe is used to access the remote node.

This command is available on Windows only.

Authorization

One of the following:

- *sysadm*
- *sysctrl*

Required connection

None

Command syntax

```
▶▶ CATALOG [ADMIN] NPIPE NODE nodename REMOTE computername
▶▶ INSTANCE instancename [SYSTEM system-name]
▶▶ [OSTYPE operating-system-type] [WITH "comment-string"]
```

Command parameters

ADMIN

Specifies that an NPIPE administration server node is to be cataloged.

REMOTE *computername*

The computer name of the node on which the target database resides.
Maximum length is 15 characters.

INSTANCE *instancename*

Name of the server instance on which the target database resides. Identical to the name of the remote named pipe, which is used to communicate with the remote node.

SYSTEM *system-name*

Specifies the DB2 system name that is used to identify the server machine.

OSTYPE *operating-system-type*

Specifies the operating system type of the server machine. Valid values are: AIX, WIN, HPUX, SUN, OS390, OS400, VM, VSE, SNI, SCO, and LINUX.

Examples

```
db2 catalog npipe node db2np1 remote nphost instance db2inst1
with "A remote named pipe node."
```

Usage notes

The database manager creates the node directory when the first node is cataloged (that is, when the first CATALOG...NODE command is issued). On a Windows client, it stores and maintains the node directory in the instance subdirectory where the client is installed. On an AIX client, it creates the node directory in the DB2 installation directory.

List the contents of the local node directory using the LIST NODE DIRECTORY command.

If directory caching is enabled (see the configuration parameter **dir_cache** in the GET DATABASE MANAGER CONFIGURATION command), database, node, and DCS directory files are cached in memory. An application's directory cache is created during its first directory lookup. Since the cache is only refreshed when the application modifies any of the directory files, directory changes made by other applications might not be effective until the application has restarted.

To refresh the CLP's directory cache, use the TERMINATE command. To refresh DB2's shared cache, stop (db2stop) and then restart (db2start) the database manager. To refresh the directory cache for another application, stop and then restart that application.

Chapter 23. CATALOG ODBC DATA SOURCE

Catalogs a user or system ODBC data source.

A *data source*, in ODBC (Open Database Connectivity) terminology, is a user-defined name for a specific database or file system. That name is used to access the database or file system through ODBC APIs. Either user or system data sources can be cataloged. A user data source is only visible to the user who cataloged it, whereas a system data source is visible to and can be used by all other users.

This command is available on Windows platforms only.

Authorization

None

Required connection

None

Command syntax



Command parameters

USER Catalog a user data source. This is the default if no keyword is specified.

SYSTEM

Catalog a system data source.

ODBC DATA SOURCE *data-source-name*

Specifies the name of the data source to be cataloged. The name of the data source and the name of the database must be the same. Therefore, the name of the data source is limited to the maximum length for a database name.

ALL DATA SOURCES

Specifies to catalog all local database aliases as ODBC data sources (DSNs).

Usage notes

On Microsoft Windows Vista or later versions, you must execute the `CATALOG SYSTEM ODBC DATA SOURCE` command from a DB2 command window running with full administrator privileges.

Specifying the `ALL DATA SOURCES` parameter will not update an existing ODBC DSN that has set its `dbalias` parameter to a value that matches the alias of a database in the local database directory

Example 1

Assume there is an existing ODBC DSN named "MyProdDatabase". The dbalias parameter is set to "PRODDB". Assume there is also a database in the local directory with the alias "PRODDB". Executing the CATALOG ODBC DATA SOURCE myproddatabase command or the CATALOG ALL DATA SOURCES command will not alter the "MyProdDatabase" DSN because the DSN does not match the database alias. Instead, an ODBC DSN entry is created for "PRODDB" with the dbalias set to "PRODDB". If there is an existing ODBC DSN with the same name as the database alias, the existing ODBC DSN's dbalias parameter will be updated with the database alias. All associated CLI parameters and values will remain unchanged.

Example 2

Assume there is an existing DSN called "MYDB" that has the dbalias parameter set to "salesdb". If there is a database in the local directory named "MYDB" then executing the CATALOG ODBC DATA SOURCE mydb command or the CATALOG ALL DATA SOURCES command will change the DSN's dbalias parameter to "MYDB".

Chapter 24. CATALOG TCPIP/TCPIP4/TCPIP6 NODE

Adds a Transmission Control Protocol/Internet Protocol (TCP/IP) database partition server entry to the node directory. The TCP/IP communications protocol is used to access the remote database partition server. The CATALOG TCPIP/TCPIP4/TCPIP6 NODE command is run on a client.

Authorization

One of the following:

- *sysadm*
- *sysctrl*

Required connection

None. Directory operations affect the local directory only.

Command syntax

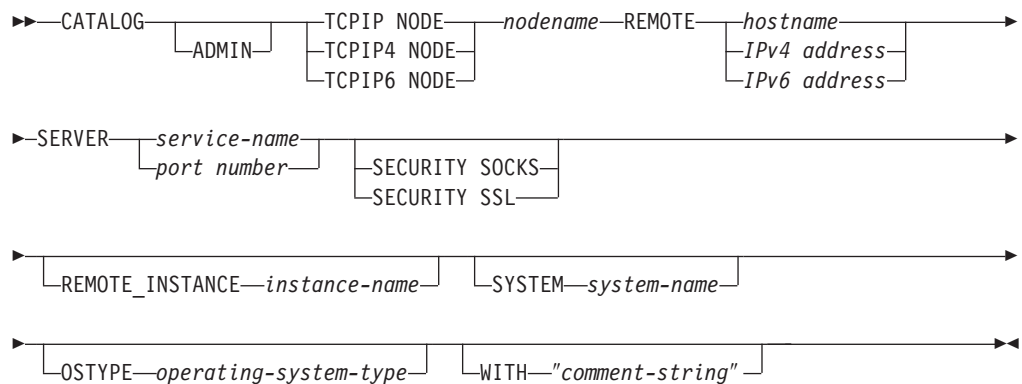

Command parameters

ADMIN

Specifies that a TCP/IP administration server node is to be cataloged. This parameter cannot be specified if the SECURITY SOCKS parameter is specified.

TCPIP NODE *nodename*

The *nodename* of the TCPIP, TCPIP4, or TCPIP6 database partition server represents a local nickname you can set for the machine that contains the database you want to catalog. Only specify TCPIP4 when specifying an IPv4 IP address, and only specify TCPIP6 when specifying an IPv6 IP address.

REMOTE *hostname* | *IPv4 address* | *IPv6 address*

The *hostname* or the IP address of the node where the target database resides. *IP address* can be an IPv4 or IPv6 address. The *hostname* is the name of the database partition server that is known to the TCP/IP network. The maximum length of the *hostname* is 255 characters.

SERVER *service-name* | *port number*

Specifies the service name or the port number of the server database manager instance. The maximum length is 14 characters. This parameter is case sensitive.

If a service name is specified, the *services* file on the client is used to map the service name to a port number. A service name is specified in the server's database manager configuration file, and the *services* file on the server is used to map this service name to a port number. The port number on the client and the server must match.

A port number, instead of a service name, can be specified in the database manager configuration file on the server, but this is not recommended. If a port number is specified, no service name needs to be specified in the local *services* file.

This parameter must not be specified for ADMIN nodes, but is mandatory for non-ADMIN nodes. The value on ADMIN nodes is always 523.

SECURITY SOCKS

Specifies that the node will be SOCKS-enabled. This parameter is only supported for IPv4. If CATALOG TCP/IP NODE is used and SECURITY SOCKS is specified, the DB2 database product will use IPv4 to establish the connection. This parameter cannot be specified if the ADMIN parameter is specified.

The following environment variables are mandatory and *must* be set to enable SOCKS:

SOCKS_NS

The Domain Name Server for resolving the host address of the SOCKS server. This should be a hostname or IPv4 address.

SOCKS_SERVER

The fully qualified hostname or IPv4 address of the SOCKS server. If the SOCKSified IBM Data Server Client is unable to resolve the fully qualified hostname, it assumes that an IPv4 address has been entered.

One of the following conditions should be true:

- The SOCKS server is reachable via the domain name server.
- The hostname is listed in the hosts file. The location of this file is described in the TCP/IP documentation.
- An IPv4 address is specified.

If this command is issued after a db2start, it is necessary to issue a TERMINATE command to have the command take effect.

SECURITY SSL

Specifies that the node is SSL enabled. You cannot specify the SECURITY SSL clause if you also specify the ADMIN parameter.

REMOTE_INSTANCE *instance-name*

Specifies the name of the server instance where the database resides, and to which an attachment or connection is being made.

SYSTEM *system-name*

Specifies the DB2 system name that is used to identify the server machine. This is the name of the physical machine, server system, or workstation.

OSTYPE *operating-system-type*

Specifies the operating system type of the server machine. Valid values are: AIX, WIN, HPUX, SUN, OS390, OS400, VM, VSE, and LINUX.

Examples

To specify a hostname using the CATALOG TCPIP NODE command, issue:

```
db2 catalog tcpip node db2tcp1 remote hostname server db2inst1
with "Look up IPv4 or IPv6 address from hostname"
```

To specify an IPv4 address using the CATALOG TCPIP4 NODE command, issue:

```
db2 catalog tcpip4 node db2tcp2 remote 192.0.32.67 server db2inst1
with "Look up IPv4 address from 192.0.32.67"
```

This example specifies an IPv4 address. You should not specify an IPv6 address in the CATALOG TCPIP4 NODE command. The catalog will not fail if you do, but a subsequent attach or connect will fail because an invalid address was specified during cataloging.

To specify an IPv6 address using the CATALOG TCPIP6 NODE command, issue:

```
db2 catalog tcpip6 node db2tcp3 1080:0:0:0:8:800:200C:417A server 50000
with "Look up IPv6 address from 1080:0:0:0:8:800:200C:417A"
```

This example specifies an IPv6 address and a port number for server. You should not specify an IPv6 address in the CATALOG TCPIP4 NODE command. The catalog will not fail if you do, but a subsequent attach or connect will fail because an invalid address was specified during cataloging.

The following example catalogs a node for an SSL connection (the server hostname is *hostname*, and *ssl_port* is the port number at which this database server waits for communication from remote client nodes using the SSL protocol):

```
db2 catalog tcpip node db2tcp4 remote hostname server ssl_port
```

Usage notes

The database manager creates the node directory when the first node is cataloged (that is, when the first CATALOG...NODE command is issued). On a Windows client, it stores and maintains the node directory in the instance subdirectory where the client is installed. On an AIX client, it creates the node directory in the DB2 installation directory.

List the contents of the local node directory using the LIST NODE DIRECTORY command.

If directory caching is enabled, database, node, and DCS directory files are cached in memory. An application's directory cache is created during its first directory lookup. Since the cache is only refreshed when the application modifies any of the directory files, directory changes made by other applications might not be effective until the application has restarted.

To refresh the CLP's directory cache, use the TERMINATE command. To refresh DB2's shared cache, stop (db2stop) and then restart (db2start) the database manager. To refresh the directory cache for another application, stop and then restart that application.

To get DB2 to listen on IPv6, the operating system and server must first be configured for IPv6. Speak to your system administrator to ensure this configuration has been done before cataloging an IPv6 TCPIP node. Follow [Upgrading to IPv6 with IPv4 configured](#) to see how this can be done on AIX 5.3.

Chapter 25. CHANGE DATABASE COMMENT

Changes a database comment in the system database directory or the local database directory. New comment text can be substituted for text currently associated with a comment.

Scope

This command only affects the database partition on which it is executed.

Authorization

One of the following:

- *sysadm*
- *sysctrl*

Required connection

None

Command syntax

```
▶▶ CHANGE DATABASE database-alias COMMENT ON path | drive  
      DB  
▶ WITH "comment-string" ▶▶
```

Command parameters

DATABASE *database-alias*

Specifies the alias of the database whose comment is to be changed. To change the comment in the system database directory, specify the alias for the database. To change the comment in the local database directory, specify the path where the database resides (with the *path* parameter), and enter the name (not the alias) of the database.

ON *path* | *drive*

Specifies the path on which the database resides, and changes the comment in the local database directory. If a path is not specified, the database comment for the entry in the system database directory is changed. On Windows operating systems, may instead specify the letter of the drive on which the database resides (if it was created on a drive, not on a specific path).

WITH "*comment-string*"

Describes the entry in the system database directory or the local database directory. Any comment that helps to describe the cataloged database can be entered. The maximum length of a comment string is 30 characters. A carriage return or a line feed character is not permitted. The comment text must be enclosed by double quotation marks.

Examples

The following example changes the text in the system database directory comment for the SAMPLE database from "Test 2 - Holding" to "Test 2 - Add employee inf rows":

```
db2 change database sample comment  
with "Test 2 - Add employee inf rows"
```

Usage notes

New comment text replaces existing text. To append information, enter the old comment text, followed by the new text.

Only the comment for an entry associated with the database alias is modified. Other entries with the same database name, but with different aliases, are not affected.

If the path is specified, the database alias must be cataloged in the local database directory. If the path is not specified, the database alias must be cataloged in the system database directory.

Chapter 26. CHANGE ISOLATION LEVEL

Changes the way that DB2 isolates data from other processes while a database is being accessed.

Authorization

None

Required connection

None

Command syntax

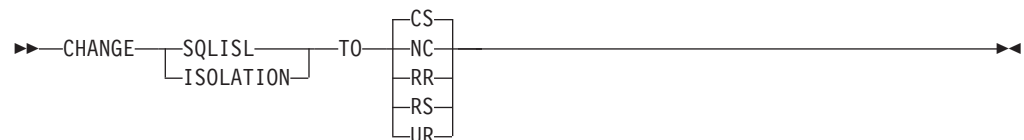

Command parameters

TO

- CS Specifies cursor stability as the isolation level.
- NC Specifies no commit as the isolation level. Not supported by DB2.
- RR Specifies repeatable read as the isolation level.
- RS Specifies read stability as the isolation level.
- UR Specifies uncommitted read as the isolation level.

Usage notes

DB2 uses isolation levels to maintain data integrity in a database. The isolation level defines the degree to which an application process is isolated (shielded) from changes made by other concurrently executing application processes.

If a selected isolation level is not supported by a database, it is automatically escalated to a supported level at connect time.

Isolation level changes are not permitted while connected to a database with a type 1 connection. The back end process must be terminated before isolation level can be changed:

```
db2 terminate
db2 change isolation to ur
db2 connect to sample
```

Changes are permitted using a type 2 connection, but should be made with caution, because the changes will apply to every connection made from the same command line processor back-end process. The user assumes responsibility for remembering which isolation level applies to which connected database.

In the following example, a user is in DB2 interactive mode following creation of the SAMPLE database:

```
update command options using c off
catalog db sample as sample2

set client connect 2

connect to sample
connect to sample2

change isolation to cs
set connection sample
declare c1 cursor for select * from org
open c1
fetch c1 for 3 rows

change isolation to rr
fetch c1 for 2 rows
```

An SQL0514N error occurs because c1 is not in a prepared state for this isolation level.

```
change isolation to cs
set connection sample2
fetch c1 for 2 rows
```

An SQL0514N error occurs because c1 is not in a prepared state for this database.

```
declare c1 cursor for select division from org
```

A DB21029E error occurs because cursor c1 has already been declared and opened.

```
set connection sample
fetch c1 for 2 rows
```

This works because the original database (SAMPLE) was used with the original isolation level (CS).

Chapter 27. COMPLETE XMLSCHEMA

This command completes the process of registering an XML schema in the XML schema repository (XSR).

Authorization

- The user ID must be the owner of the XSR object as recorded in the catalog view SYSCAT.XSROBJECTS.

Required connection

Database

Command syntax

```
→ COMPLETE XMLSCHEMA relational-identifier →  
└── WITH schema-properties-URI ┘  
→  
└── ENABLE DECOMPOSITION ┘ →
```

Description

relational-identifier

Specifies the relational name of an XML schema previously registered with the REGISTER XMLSCHEMA command. The relational name can be specified as a two-part SQL identifier, consisting of the SQL schema and the XML schema name, having the following format: *SQLschema.name*. The default SQL schema, as defined in the CURRENT SCHEMA special register, is used if no schema is specified.

WITH *schema-properties-URI*

Specifies the uniform resource identifier (URI) of a properties document for the XML schema. Only a local file, specified by a file scheme URI, is supported. A schema property document can only be specified during the completion stage of XML schema registration.

ENABLE DECOMPOSITION

Indicates that the schema can be used for decomposing XML instance documents.

Example

```
COMPLETE XMLSCHEMA user1.POschema WITH 'file:///c:/TEMP/schemaProp.xml'
```

Usage notes

An XML schema cannot be referenced or used for validation or annotation until the XML schema registration process has been completed. This command completes the XML schema registration process for an XML schema that was begun with the REGISTER XMLSCHEMA command.

Chapter 28. CREATE DATABASE

The CREATE DATABASE command initializes a new database with an optional user-defined collating sequence, creates the three initial table spaces, creates the system tables, and allocates the recovery log file. When you initialize a new database, the AUTOCONFIGURE command is issued by default.

Note: When the instance and database directories are created by the DB2 database manager, the permissions are accurate and should not be changed.

When the CREATE DATABASE command is issued, the Configuration Advisor also runs automatically. This means that the database configuration parameters are automatically tuned for you according to your system resources. In addition, Automated Runstats is enabled. To disable the Configuration Advisor from running at database creation, refer to the *db2_enable_autoconfig_default* registry variable. To disable Automated Runstats, refer to *auto_runstats* database configuration parameter.

Adaptive Self Tuning Memory is also enabled by default for single partition databases. To disable Adaptive Self Tuning Memory by default, refer to the *self_tuning_mem* database configuration parameter (see *self_tuning_mem - Self-tuning memory configuration parameter*). For multi-partition databases, Adaptive Self Tuning Memory is disabled by default.

If no code set is specified on the CREATE DATABASE command, then the collations allowed are: SYSTEM, IDENTITY_16BIT, UCA400_NO, UCA400_LSK, UCA400_LTH, *language-aware-collation*, and *locale-aware-collation* (SQLCODE -1083). The default code set for a database is UTF-8. If a particular code set and territory is needed for a database, the desired code set and territory should be specified in the CREATE DATABASE command.

This command is not valid on a client.

Scope

In a partitioned database environment, this command affects all database partitions that are listed in the *db2nodes.cfg* file.

The database partition from which this command is issued becomes the catalog database partition for the new database.

Authorization

You must have one of the following:

- *sysadm*
- *sysctrl*

Required connection

Instance. To create a database at another (remote) database partition server, you must first attach to that server. A database connection is temporarily established by this command during processing.

Command syntax

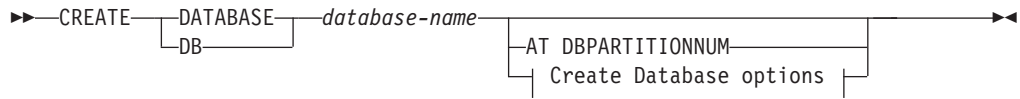

Create Database options:

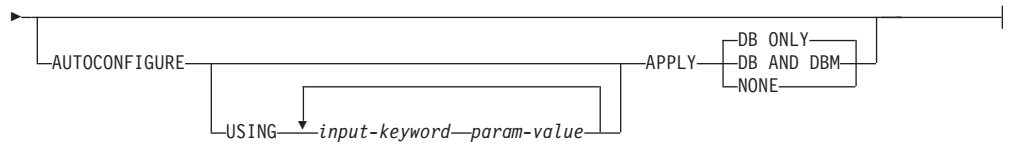
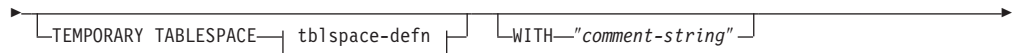
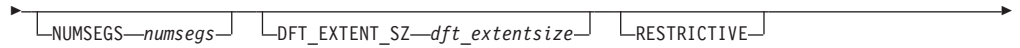
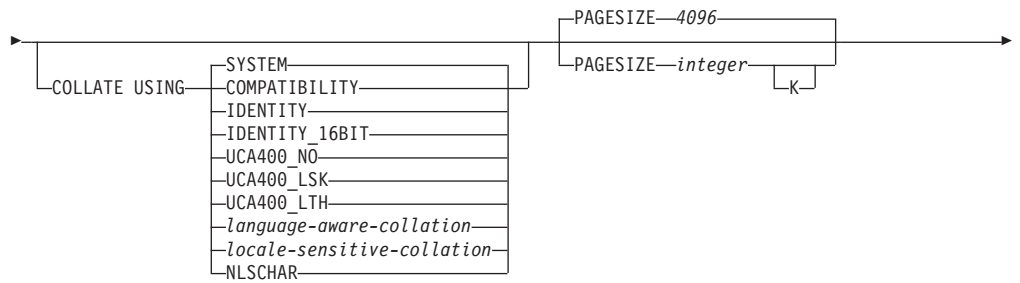
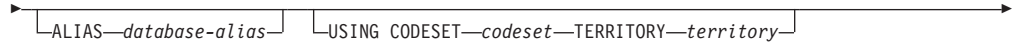
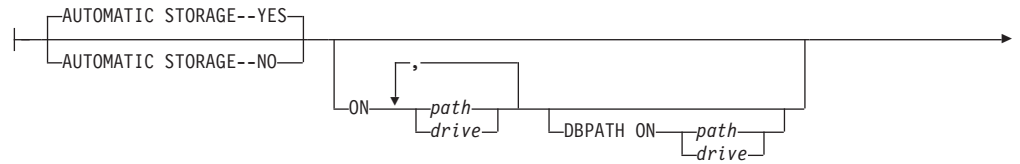

tblspace-defn:

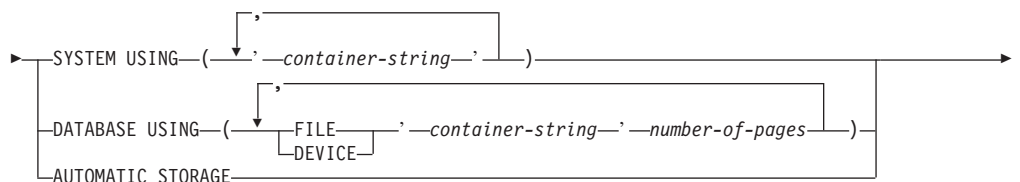

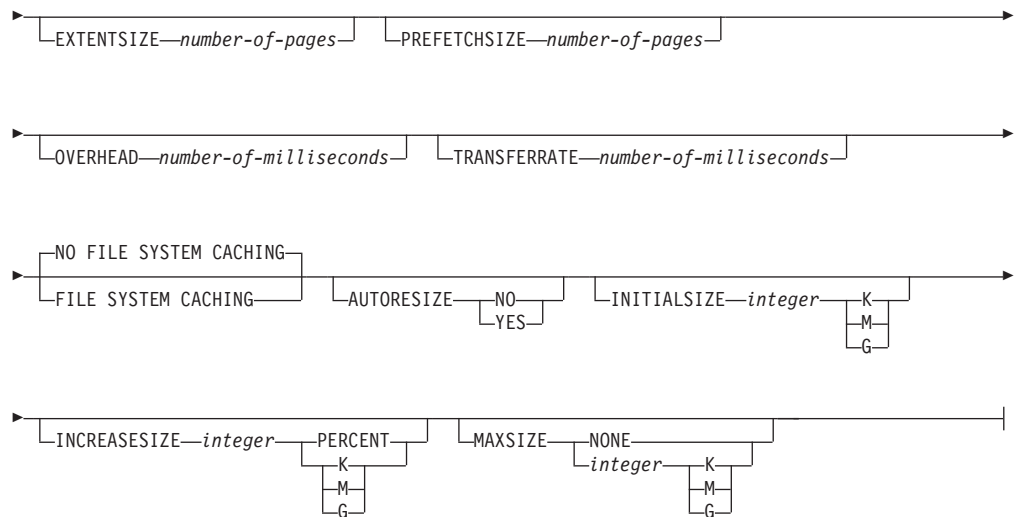

Note:

1. The combination of the code set and territory values must be valid.
2. Not all collating sequences are valid with every code set and territory combination.
3. The table space definitions specified on CREATE DATABASE apply to all database partitions on which the database is being created. They cannot be specified separately for each database partition. If the table space definitions are to be created differently on particular database partitions, the CREATE TABLESPACE statement must be used.

When defining containers for table spaces, \$N can be used. \$N will be replaced by the database partition number when the container is actually created. This is required if the user wants to specify containers in a multiple logical partition database.

4. The AUTOCONFIGURE option requires *sysadm* authority.

Command parameters

DATABASE *database-name*

A name to be assigned to the new database. This must be a unique name that differentiates the database from any other database in either the local database directory or the system database directory. The name must conform to naming conventions for databases. Specifically, the name must not contain any space characters.

AT DBPARTITIONNUM

Specifies that the database is to be created only on the database partition that issues the command. You do not specify this option when you create a new database. You can use it to recreate a database partition that you dropped because it was damaged. After you use the CREATE DATABASE command with the AT DBPARTITIONNUM option, the database at this database partition is in the restore-pending state. You must immediately restore the database on this database partition server. This parameter is not intended for general use. For example, it should be used with RESTORE DATABASE command if the database partition at a database partition

server was damaged and must be recreated. Improper use of this parameter can cause inconsistencies in the system, so it should only be used with caution.

If this parameter is used to recreate a database partition that was dropped (because it was damaged), the database at this database partition will be in the restore-pending state. After recreating the database partition, the database must immediately be restored on this database partition.

AUTOMATIC STORAGE NO | YES

Specifies that automatic storage is being explicitly disabled or enabled for the database. The default value is YES. If the AUTOMATIC STORAGE clause is not specified, automatic storage is implicitly enabled by default.

NO Automatic storage is not being enabled for the database.

YES Automatic storage is being enabled for the database.

ON *path* or *drive*

The meaning of this option depends on the value of the AUTOMATIC STORAGE option.

- If AUTOMATIC STORAGE NO is specified, automatic storage is disabled for the database. In this case, only one path can be included as part of the ON option, and it specifies the path on which to create the database. If a path is not specified, the database is created on the default database path that is specified in the database manager configuration file (**dftdbpath** parameter). This behavior matches that of DB2[®] Universal Database[™] Version 8.2 and earlier.
- Otherwise, automatic storage is enabled for the database by default. In this case, multiple paths may be listed here, each separated by a comma. These are referred to as storage paths and are used to hold table space containers for automatic storage table spaces. For multi-partition databases the same storage paths will be used on all partitions.

The DBPATH ON option specifies on which paths to create the database. If the DBPATH ON option is not specified, the database is created on the first path listed in the ON option. If no paths are specified with the ON option, the database is created on the default database path that is specified in the database manager configuration file (**dftdbpath** parameter). This will also be used as the location for the single storage path associated with the database.

The database path is the location where a hierarchical directory structure is created. The structure holds the following files needed for the operation of the database:

- Buffer pool information
- Table space information
- Storage path information
- Database configuration information
- History file information regarding backups, restores, loading of tables, reorganization of tables, altering of table spaces, and other database changes
- Log control files with information about active logs

The DBPATH ON option can be used to place these files and information in a directory that is separate from the storage paths where the database data is kept. It is suggested that the DBPATH ON option be

used when automatic storage is enabled to keep the database information separate from the database data.

The maximum length of a path is 175 characters.

For MPP systems, a database should not be created in an NFS-mounted directory. If a path is not specified, ensure that the *dftdbpath* database manager configuration parameter is not set to an NFS-mounted path (for example, on UNIX based systems, it should not specify the \$HOME directory of the instance owner). The path specified for this command in an MPP system cannot be a relative path. Also, all paths specified as part of the ON option must exist on all database partitions.

A given database path or storage path must exist and be accessible on each database partition.

DBPATH ON *path or drive*

If automatic storage is enabled, the DBPATH ON option specifies the path on which to create the database. If automatic storage is enabled and the DBPATH ON option is not specified, the database is created on the first path listed with the ON option.

The maximum length of a database path is 215 characters and the maximum length of a storage path is 175 characters.

ALIAS *database-alias*

An alias for the database in the system database directory. If no alias is provided, the specified database name is used.

USING CODESET *codeset*

Specifies the code set to be used for data entered into this database. After you create the database, you cannot change the specified code set.

TERRITORY *territory*

Specifies the territory identifier or locale identifier to be used for data entered into this database. After you create the database, you cannot change the specified territory. The combination of the code set and territory or locale values must be valid.

COLLATE USING

Identifies the type of collating sequence to be used for the database. Once the database has been created, the collating sequence cannot be changed.

In a Unicode database, the catalog tables and views are always created with the IDENTITY collation, regardless of the collation specified in the COLLATE USING clause. In non-Unicode databases, the catalog tables and views are created with the database collation.

COMPATIBILITY

The DB2 Version 2 collating sequence. Some collation tables have been enhanced. This option specifies that the previous version of these tables is to be used.

IDENTITY

Identity collating sequence, in which strings are compared byte for byte. This is the default for Unicode databases.

IDENTITY_16BIT

CESU-8 (Compatibility Encoding Scheme for UTF-16: 8-Bit) collation sequence as specified by the Unicode Technical Report

#26, which is available at the Unicode Consortium Web site (www.unicode.org). This option can only be specified when creating a Unicode database.

UCA400_NO

The UCA (Unicode Collation Algorithm) collation sequence that is based on the Unicode Standard version 4.0.0 with normalization implicitly set to ON. Details of the UCA can be found in the Unicode Technical Standard #10, which is available at the Unicode Consortium Web site (www.unicode.org). This option can only be used when creating a Unicode database.

UCA400_LSK

The UCA (Unicode Collation Algorithm) collation sequence based on the Unicode Standard version 4.0.0 but will sort Slovak characters in the appropriate order. Details of the UCA can be found in the Unicode Technical Standard #10, which is available at the Unicode Consortium Web site (www.unicode.org). This option can only be used when creating a Unicode database.

UCA400_LTH

The UCA (Unicode Collation Algorithm) collation sequence that is based on the Unicode Standard version 4.0.0 but will sort all Thai characters according to the Royal Thai Dictionary order. Details of the UCA can be found in the Unicode Technical Standard #10 available at the Unicode Consortium Web site (www.unicode.org). This option can only be used when creating a Unicode database. This collator might order Thai data differently from the NLSCHAR collator option.

language-aware-collation

This option can only be used for Unicode databases. The database collating sequence is based on the SYSTEM collation for a non-Unicode database. This string must be of the format *SYSTEM_codepage_territory*. If the string supplied is invalid, the create database will fail (SQLCODE -204; object not found). See *Language-aware collations for Unicode data* for more information and for the naming of system based collations.

Note: When the CREATE DATABASE command is performed against a Version 9.0 server, this option cannot be used. By default, a Unicode database on such a server will be created with SYSTEM collation.

locale-sensitive-collation

This option can only be used for Unicode databases. See *Unicode Collation Algorithm based collations* for more information and for the naming of locale-sensitive UCA-based collations. If the collation name provided is invalid, the CREATE DATABASE command execution will fail (SQLCODE -204).

NLSCHAR

System-defined collating sequence using the unique collation rules for the specific code set/territory.

This option can only be used with the Thai code page (CP874). If this option is specified in non-Thai environments, the command will fail and return the error SQL1083N with Reason Code 4.

SYSTEM

This is the default option when creating a database. For non-Unicode databases, the collating sequence is based on the database territory. For Unicode databases, this option maps to a language-aware collation, based on the client code set and territory. If an appropriate language-aware collation is unavailable, then the IDENTITY collation is used.

PAGESIZE *integer*

Specifies the page size of the default buffer pool along with the initial table spaces (SYSCATSPACE, TEMPSPACE1, USERSPACE1) when the database is created. This also represents the default page size for all future CREATE BUFFERPOOL and CREATE TABLESPACE statements. The valid values for integer without the suffix K are 4 096, 8 192, 16 384, or 32 768. The valid values for integer with the suffix K are 4, 8, 16, or 32. At least one space is required between the integer and the suffix K. The default is a page size of 4 096 bytes (4 K).

NUMSEGS *numsegs*

Specifies the number of directories (table space containers) that will be created and used to store the database table files for any default SMS table spaces. This parameter does not affect automatic storage table spaces, DMS table spaces, any SMS table spaces with explicit creation characteristics (created when the database is created), or any SMS table spaces explicitly created after the database is created.

DFT_EXTENT_SZ *dft_extentsize*

Specifies the default extent size of table spaces in the database.

RESTRICTIVE

If the RESTRICTIVE option is present it causes the RESTRICT_ACCESS database configuration parameter to be set to YES and no privileges or authorities are automatically granted to PUBLIC. If the RESTRICTIVE option is not present then the RESTRICT_ACCESS database configuration parameter is set to NO and all of the following privileges are automatically granted to PUBLIC.

- BIND on all packages created in the NULLID schema
- BINDADD
- CONNECT
- CREATEIN on schema SQLJ
- CREATEIN on schema NULLID
- CREATETAB
- EXECUTE with GRANT on all procedures in schema SQLJ
- EXECUTE with GRANT on all functions and procedures in schema SYSFUN
- EXECUTE with GRANT on all functions and procedures in schema SYSPROC (except audit routines)
- EXECUTE on all table functions in schema SYSIBM
- EXECUTE on all other procedures in schema SYSIBM
- EXECUTE on all packages created in the NULLID schema
- IMPLICIT_SCHEMA
- SELECT access to the SYSIBM catalog tables
- SELECT access to the SYSCAT catalog views
- SELECT access to the SYSSTAT catalog views

- UPDATE access to the SYSSTAT catalog views
- USAGE on the SYSDEFAULTUSERWORKLOAD workload
- USE on table space USERSPACE1

CATALOG TABLESPACE tblspace-defn

Specifies the definition of the table space that will hold the catalog tables, SYSCATSPACE. If not specified and automatic storage is not enabled for the database, SYSCATSPACE is created as a System Managed Space (SMS) table space with *numsegs* number of directories as containers, and with an extent size of *dft_extentsize*. For example, the following containers would be created if *numsegs* were specified to be 5:

```
/u/smith/smith/NODE0000/SQL00001/SQLT0000.0
/u/smith/smith/NODE0000/SQL00001/SQLT0000.1
/u/smith/smith/NODE0000/SQL00001/SQLT0000.2
/u/smith/smith/NODE0000/SQL00001/SQLT0000.3
/u/smith/smith/NODE0000/SQL00001/SQLT0000.4
```

If not specified and automatic storage is enabled for the database, SYSCATSPACE is created as an automatic storage table space with its containers created on the defined storage paths. The extent size of this table space is 4. Appropriate values for AUTORESIZE, INITIALSIZE, INCREASESIZE, and MAXSIZE are set automatically.

See *CREATE TABLESPACE statement* for more information on the table space definition fields.

In a partitioned database environment, the catalog table space is only created on the catalog database partition, the database partition on which the CREATE DATABASE command is issued.

USER TABLESPACE tblspace-defn

Specifies the definition of the initial user table space, USERSPACE1. If not specified and automatic storage is not enabled for the database, USERSPACE1 is created as an SMS table space with *numsegs* number of directories as containers and with an extent size of *dft_extentsize*. For example, the following containers would be created if *numsegs* were specified to be 5:

```
/u/smith/smith/NODE0000/SQL00001/SQLT0001.0
/u/smith/smith/NODE0000/SQL00001/SQLT0002.1
/u/smith/smith/NODE0000/SQL00001/SQLT0002.2
/u/smith/smith/NODE0000/SQL00001/SQLT0002.3
/u/smith/smith/NODE0000/SQL00001/SQLT0002.4
```

If not specified and automatic storage is enabled for the database, USERSPACE1 is created as an automatic storage table space with its containers created on the defined storage paths. The extent size of this table space will be *dft_extentsize*. Appropriate values for AUTORESIZE, INITIALSIZE, INCREASESIZE, and MAXSIZE are set automatically.

See *CREATE TABLESPACE statement* for more information on the table space definition fields.

TEMPORARY TABLESPACE tblspace-defn

Specifies the definition of the initial system temporary table space, TEMPSPACE1. If not specified and automatic storage is not enabled for the database, TEMPSPACE1 is created as an SMS table space with *numsegs* number of directories as containers and with an extent size of *dft_extentsize*. For example, the following containers would be created if *numsegs* were specified to be 5:

```
/u/smith/smith/NODE0000/SQL00001/SQLT0002.0
/u/smith/smith/NODE0000/SQL00001/SQLT0001.1
/u/smith/smith/NODE0000/SQL00001/SQLT0001.2
/u/smith/smith/NODE0000/SQL00001/SQLT0001.3
/u/smith/smith/NODE0000/SQL00001/SQLT0001.4
```

If not specified and automatic storage is enabled for the database, TEMPSPACE1 is created as an automatic storage table space with its containers created on the defined storage paths. The extent size of this table space is *dft_extentsize*.

See *CREATE TABLESPACE statement* for more information on the table space definition fields.

tblspace-defn

Various table space definitions can be specified through the following command parameters.

MANAGED BY

SYSTEM USING *container-string*

Specifies that the table space is to be an SMS table space. When the type of table space is not specified, the default behavior is to create a regular table space.

For an SMS table space, identifies one or more containers that will belong to the table space and in which the table space data will be stored. The *container-string* cannot exceed 240 bytes in length.

Each *container-string* can be an absolute or relative directory name.

The directory name, if not absolute, is relative to the database directory, and can be a path name alias (a symbolic link on UNIX systems) to storage that is not physically associated with the database directory. For example, *dbdir/work/c1* could be a symbolic link to a separate file system.

If any component of the directory name does not exist, it is created by the database manager. When a table space is dropped, all components created by the database manager are deleted. If the directory identified by *container-string* exists, it must not contain any files or subdirectories (SQLSTATE 428B2).

The format of *container-string* is dependent on the operating system. On Windows operating systems, an absolute directory path name begins with a drive letter and a colon (:); on UNIX systems, an absolute path name begins with a forward slash (/). A relative path name on any platform does not begin with an operating system-dependent character.

Remote resources (such as LAN-redirection drives or NFS-mounted file systems) are currently only supported when using Network Appliance Filers, IBM iSCSI, IBM Network Attached Storage, Network Appliance iSCSI, NEC iStorage S2100, S2200, or S4100, or NEC Storage NS Series with a Windows DB2 server. Note that NEC Storage NS Series is only supported with the use of an uninterrupted

power supply (UPS); continuous UPS (rather than standby) is recommended. An NFS-mounted file system on AIX must be mounted in uninterruptible mode using the `-o nointr` option.

DATABASE USING

Specifies that the table space is to be a DMS table space. When the type of table space is not specified, the default behavior is to create a large table space.

For a DMS table space, identifies one or more containers that will belong to the table space and in which the table space data will be stored. The type of the container (either FILE or DEVICE) and its size (in PAGESIZE pages) are specified. A mixture of FILE and DEVICE containers can be specified. The *container-string* cannot exceed 254 bytes in length.

Remote resources (such as LAN-redirection drives or NFS-mounted file systems) are currently only supported when using Network Appliance Filers, IBM iSCSI, IBM Network Attached Storage, Network Appliance iSCSI, NEC iStorage S2100, S2200, or S4100, or NEC Storage NS Series with a Windows DB2 server. Note that NEC Storage NS Series is only supported with the use of an uninterrupted power supply (UPS); continuous UPS (rather than standby) is recommended..

All containers must be unique across all databases. A container can belong to only one table space. The size of the containers can differ; however, optimal performance is achieved when all containers are the same size. The exact format of *container-string* is dependent on the operating system.

FILE *container-string number-of-pages*

For a FILE container, *container-string* must be an absolute or relative file name. The file name, if not absolute, is relative to the database directory. If any component of the directory name does not exist, it is created by the database manager. If the file does not exist, it will be created and initialized to the specified size by the database manager. When a table space is dropped, all components created by the database manager are deleted.

Note: If the file exists, it is overwritten, and if it is smaller than specified, it is extended. The file will not be truncated if it is larger than specified.

DEVICE *container-string number-of-pages*

For a DEVICE container, *container-string* must be a device name. The device must already exist.

AUTOMATIC STORAGE

Specifies that the table space is to be an automatic storage table space. If automatic storage is not defined for the database, an error is returned (SQLSTATE 55060).

An automatic storage table space is created as either a system managed space (SMS) table space or a database managed space (DMS) table space. When DMS is chosen and the type of table space is not specified, the default behavior is to create a large table space. With an automatic storage table space, the database manager determines which containers are to be assigned to the table space, based upon the storage paths that are associated with the database.

EXTENTSIZE *number-of-pages*

Specifies the number of PAGESIZE pages that will be written to a container before skipping to the next container. The extent size value can also be specified as an integer value followed by K (for kilobytes) or M (for megabytes). If specified in this way, the floor of the number of bytes divided by the page size is used to determine the value for the extent size. The database manager cycles repeatedly through the containers as data is stored.

The default value is provided by the DFT_EXTENT_SZ database configuration parameter, which has a valid range of 2-256 pages.

PREFETCHSIZE *number-of-pages*

Specifies the number of PAGESIZE pages that will be read from the table space when data prefetching is being performed. The prefetch size value can also be specified as an integer value followed by K (for kilobytes), M (for megabytes), or G (for gigabytes). If specified in this way, the floor of the number of bytes divided by the page size is used to determine the number of pages value for prefetch size.

OVERHEAD *number-of-milliseconds*

Specifies the I/O controller overhead and disk seek and latency time. This value is used to determine the cost of I/O during query optimization. The value of *number-of-milliseconds* is any numeric literal (integer, decimal, or floating point). If this value is not the same for all containers, the number should be the average for all containers that belong to the table space.

For a database that was created in Version 9 or later, the default I/O controller overhead and disk seek and latency time is 7.5 milliseconds. For a database that was upgraded from a previous version of DB2 to Version 9 or later, the default is 12.67 milliseconds.

TRANSFERRATE *number-of-milliseconds*

Specifies the time to read one page into memory. This value is used to determine the cost of I/O during query optimization. The value of *number-of-milliseconds* is any numeric literal (integer, decimal, or floating point). If this value is not the same for all containers, the number should be the average for all containers that belong to the table space.

For a database that was created in Version 9 or later, the default time to read one page into memory is 0.06 milliseconds. For a database that was upgraded from a previous version of DB2 to Version 9 or later, the default is 0.18 milliseconds.

NO FILE SYSTEM CACHING

Specifies that all I/O operations are to bypass the file system-level cache. See *Table spaces without file system caching* for more details. This is the default option on most configurations. See *File system caching configurations* for details.

FILE SYSTEM CACHING

Specifies that all I/O operations in the target table space are to be cached at the file system level. See *Table spaces without file system caching* for more details. This is the default option on some configurations. See *File system caching configurations* for details.

AUTORESIZE

Specifies whether or not the auto-resize capability of a DMS table space or an automatic storage table space is to be enabled. Auto-resizable table spaces automatically increase in size when they become full. The default is NO for DMS table spaces and YES for automatic storage table spaces.

NO Specifies that the auto-resize capability of a DMS table space or an automatic storage table space is to be disabled.

YES Specifies that the auto-resize capability of a DMS table space or an automatic storage table space is to be enabled.

INITIALSIZE *integer*

Specifies the initial size, per database partition, of an automatic storage table space. This option is only valid for automatic storage table spaces. The integer value must be followed by K (for kilobytes), M (for megabytes), or G (for gigabytes). Note that the actual value used might be slightly smaller than what was specified, because the database manager strives to maintain a consistent size across containers in the table space. Moreover, if the table space is auto-resizable and the initial size is not large enough to contain meta-data that must be added to the new table space, the database manager will continue to extend the table space by the value of **INCREASESIZE** until there is enough space. If the **INITIALSIZE** clause is not specified, the database manager determines an appropriate value. The value for *integer* must be at least 48 K.

K K (for kilobytes).

M M (for megabytes).

G G (for gigabytes).

INCREASESIZE *integer*

Specifies the amount, per database partition, by which a table space that is enabled for auto-resize will automatically be increased when the table space is full, and a request for space has been made. The integer value must be followed by either:

- PERCENT to specify the amount as a percentage of the table space size at the time that a request for space is made. When PERCENT is specified, the integer value must be between 0 and 100 (SQLSTATE 42615).
- K (for kilobytes), M (for megabytes), or G (for gigabytes) to specify the amount in bytes

Note that the actual value used might be slightly smaller or larger than what was specified, because the database manager strives to maintain consistent growth across containers in the table space. If the table space is auto-resizable, but the INCREASESIZE clause is not specified, the database manager determines an appropriate value.

PERCENT

Percent from 0 to 100.

K K (for kilobytes).

M M (for megabytes).

G G (for gigabytes).

MAXSIZE

Specifies the maximum size to which a table space that is enabled for auto-resize can automatically be increased. If the table space is auto-resizable, but the MAXSIZE clause is not specified, the default is NONE.

NONE

Specifies that the table space is to be allowed to grow to file system capacity, or to the maximum table space size.

integer Specifies a hard limit on the size, per database partition, to which a DMS table space or an automatic storage table space can automatically be increased. The integer value must be followed by K (for kilobytes), M (for megabytes), or G (for gigabytes). Note that the actual value used might be slightly smaller than what was specified, because the database manager strives to maintain consistent growth across containers in the table space.

K K (for kilobytes).

M M (for megabytes).

G G (for gigabytes).

WITH *comment-string*

Describes the database entry in the database directory. Any comment that helps to describe the database can be entered. Maximum length is 30

characters. A carriage return or a line feed character is not permitted. The comment text must be enclosed by single or double quotation marks.

AUTOCONFIGURE

Based on user input, calculates the recommended settings for buffer pool size, database configuration, and database manager configuration and optionally applies them. The Configuration Advisor is run by default when the CREATE DATABASE command is issued. The AUTOCONFIGURE option is needed only if you want to tweaks the recommendations.

USING *input-keyword param-value*

Table 7. Valid input keywords and parameter values

Keyword	Valid values	Default value	Explanation
mem_percent	1–100	25	Initial percentage of instance memory to dedicate. Configuration advisor will adjust this value for subsequent databases depending on the current memory usage on the system.
workload_type	simple, mixed, complex	mixed	Simple workloads tend to be I/O intensive and mostly transactions, whereas complex workloads tend to be CPU intensive and mostly queries.
num_stmts	1–1 000 000	25	Number of statements per unit of work
tpm	1–200 000	60	Transactions per minute
admin_priority	performance, recovery, both	both	Optimize for better performance (more transactions per minute) or better recovery time
num_local_apps	0–5 000	0	Number of connected local applications
num_remote_apps	0–5 000	100	Number of connected remote applications
isolation	RR, RS, CS, UR	RR	Isolation level of applications connecting to this database (Repeatable Read, Read Stability, Cursor Stability, Uncommitted Read)
bp_resizeable	yes, no	yes	Are buffer pools resizeable?

APPLY

DB ONLY

Displays the recommended values for the database configuration and the buffer pool settings based on the current database manager configuration. Applies the recommended changes to the database configuration and the buffer pool settings.

DB AND DBM

Displays and applies the recommended changes to the database manager configuration, the database configuration, and the buffer pool settings.

NONE

Disables the Configuration Advisor (it is enabled by default).

- If the AUTOCONFIGURE keyword is specified with the CREATE DATABASE command, the DB2_ENABLE_AUTOCONFIG_DEFAULT variable value is not considered. Adaptive Self Tuning Memory and Auto Runstats will be enabled and the Configuration Advisor will tune the database configuration and database manager configuration parameters as indicated by the APPLY DB or APPLY DBM options.
- Specifying the AUTOCONFIGURE option with the CREATE DATABASE command on a database will recommend enablement of the Self Tuning Memory Manager. However, if you run the AUTOCONFIGURE command on a database in an instance where SHEAPTHRES is not zero, sort memory tuning (SORTHEAP) will not be enabled automatically. To enable sort memory tuning (SORTHEAP), you must set SHEAPTHRES equal to zero using the UPDATE DATABASE MANAGER CONFIGURATION command. Note that changing the value of SHEAPTHRES may affect the sort memory usage in your previously existing databases.

Examples

Here are several examples of the CREATE DATABASE command:

Example 1:

```
CREATE DATABASE TESTDB3
  AUTOMATIC STORAGE YES
```

Database TESTDB3 is created on the drive that is the value of database manager configuration parameter *dftdbpath*. Automatic storage is enabled with a single storage path that also has the value of *dftdbpath*.

Example 2:

```
CREATE DATABASE TESTDB7 ON C:.,D:
```

Database TESTDB7 is created on drive C: (first drive in storage path list). Automatic storage is implicitly enabled and the storage paths are C: and D:.

Example 3:

```
CREATE DATABASE TESTDB15
  AUTOMATIC STORAGE YES
  ON C:.,D: DBPATH ON E:
```

Database TESTDB15 is created on drive E: (explicitly listed as DBPATH). Automatic storage is explicitly enabled and the storage paths are C: and D:.

Usage notes

The CREATE DATABASE command:

- Creates a database in the specified subdirectory. In a partitioned database environment, creates the database on all database partitions listed in `db2nodes.cfg`, and creates a `$DB2INSTANCE/NODExxxx` directory under the specified subdirectory at each database partition. In a single partition database environment, creates a `$DB2INSTANCE/NODE0000` directory under the specified subdirectory.
- Creates the system catalog tables and recovery log.
- Catalogs the database in the following database directories:
 - Server's local database directory on the path indicated by *path* or, if the path is not specified, the default database path defined in the database manager system configuration file by the *dftdbpath* parameter. A local database directory resides on each file system that contains a database.
 - Server's system database directory for the attached instance. The resulting directory entry will contain the database name and a database alias.
If the command was issued from a remote client, the client's system database directory is also updated with the database name and an alias.

Creates a system or a local database directory if neither exists. If specified, the comment and code set values are placed in both directories.

Note: If the change the database by path configuration parameter **newlogpath** is not set, the default for the location of log files configuration parameter **logpath** is the path shown by the DBPATH ON option. It is suggested that the DBPATH ON option be used when automatic storage is enabled to keep the database information separate from the database data.

- Stores the specified code set, territory, and collating sequence. A flag is set in the database configuration file if the collating sequence consists of unique weights, or if it is the identity sequence.
- Creates the schemas called SYSCAT, SYSFUN, SYSIBM, and SYSSTAT with SYSIBM as the owner. The database partition server on which this command is issued becomes the catalog database partition for the new database. Two database partition groups are created automatically: IBMDEFAULTGROUP and IBMCATGROUP.
- Binds the previously defined database manager bind files to the database (these are listed in the utilities bind file list, `db2ubind.lst`). If one or more of these files do not bind successfully, CREATE DATABASE returns a warning in the SQLCA, and provides information about the binds that failed. If a bind fails, the user can take corrective action and manually bind the failing file. The database is created in any case. A schema called NULLID is implicitly created when performing the binds with CREATEIN privilege granted to PUBLIC, if the RESTRICTIVE option is not selected.

The utilities bind file list contains two bind files that cannot be bound against previous version of the server:

- `db2ugtpi.bnd` cannot be bound against DB2 Version 2 servers.
- `db2dropv.bnd` cannot be bound against DB2 Parallel Edition Version 1 servers.

If `db2ubind.lst` is bound against a server which is not at the latest level, warnings pertaining to these two files are returned, and can be disregarded.

- Creates SYSCATSPACE, TEMPSPACE1, and USERSPACE1 table spaces. The SYSCATSPACE table space is only created on the catalog database partition.
- Grants the following:
 - EXECUTE WITH GRANT privilege to PUBLIC on all functions in the SYSFUN schema
 - EXECUTE privilege to PUBLIC on all procedures in SYSIBM schema
 - DBADM, CONNECT, CREATETAB, BINDADD, CREATE_NOT_FENCED, IMPLICIT_SCHEMA and LOAD authorities to the database creator
 - CONNECT, CREATETAB, BINDADD, and IMPLICIT_SCHEMA authorities to PUBLIC
 - USE privilege on the USERSPACE1 table space to PUBLIC
 - SELECT privilege on each system catalog to PUBLIC
 - BIND and EXECUTE privilege to PUBLIC for each successfully bound utility.
 - EXECUTE WITH GRANT privilege to PUBLIC on all functions in the SYSFUN schema.
 - EXECUTE privilege to PUBLIC on all procedures in SYSIBM schema.

Note: If the RESTRICTIVE option is present it causes the RESTRICT_ACCESS database configuration parameter to be set to YES and no privileges or authorities are automatically granted to PUBLIC. For additional information, see the RESTRICTIVE option of the CREATE DATABASE command.

Automatic storage is a collection of storage paths associated with a database on which table spaces can be created without having to explicitly specify container definitions (see the *CREATE TABLESPACE statement* for more information). Automatic storage is enabled by default, but can be explicitly disabled for a database when it is created. Automatic storage can be disabled at database creation time by specifying the AUTOMATIC STORAGE NO option.

It is important to note that automatic storage can only be enabled at database creation time, it cannot be enabled after the database has been created. Also, automatic storage cannot be disabled once a database has been defined to use it.

When free space is calculated for an automatic storage path for a given database partition, the database manager will check for the existence of the following directories or mount points within the storage path and will use the first one that is found. In doing this, file systems can be mounted at a point beneath the storage path and the database manager will recognize that the actual amount of free space available for table space containers may not be the same amount that is associated with the storage path directory itself.

1. <storage path>/<instance name>/NODE####/<database name>
2. <storage path>/<instance name>/NODE####
3. <storage path>/<instance name>
4. <storage path>/<

Where

- <storage path> is a storage path associated with the database.
- <instance name> is the instance under which the database resides.
- NODE#### corresponds to the database partition number (for example NODE0000 or NODE0001).
- <database name> is the name of the database.

Consider the example where two logical database partitions exist on one physical machine and the database is being created with a single storage path: /db2data. Each database partition will use this storage path but the user may want to isolate the data from each partition within its own file system. In this case, a separate file system can be created for each partition and be mounted at /db2data/<instance>/NODE####. When creating containers on the storage path and determining free space, the database manager will know not to retrieve free space information for /db2data, but instead retrieve it for the corresponding /db2data/<instance>/NODE#### directory.

In general, the same storage paths must be used for each partition in a multi-partition database and they must all exist prior to executing the CREATE DATABASE command. One exception to this is where database partition expressions are used within the storage path. Doing this allows the database partition number to be reflected in the storage path such that the resulting path name is different on each partition.

You use the argument " \$N" ([blank]\$N) to indicate a database partition expression. A database partition expression can be used anywhere in the storage path, and multiple database partition expressions can be specified. Terminate the database partition expression with a space character; whatever follows the space is appended to the storage path after the database partition expression is evaluated. If there is no space character in the storage path after the database partition expression, it is assumed that the rest of the string is part of the expression. The argument can only be used in one of the following forms:

Operators are evaluated from left to right. % represents the modulus operator. The database partition number in the examples is assumed to be 10.

Syntax	Example	Value
[blank]\$N	" \$N"	10
[blank]\$N+[number]	" \$N+100"	110
[blank]\$N%[number]	" \$N%5"	0
[blank]\$N+[number]%[number]	" \$N+1%5"	1
[blank]\$N%[number]+[number]	" \$N%4+2"	4
^a % is modulus.		

With *dbadm* authority, one can grant these privileges to (and revoke them from) other users or PUBLIC. If another administrator with *sysadm* or *dbadm* authority over the database revokes these privileges, the database creator nevertheless retains them.

In an MPP environment, the database manager creates a subdirectory, \$DB2INSTANCE/NODExxxx, under the specified or default path on all database partitions. The xxxx is the database partition number as defined in the db2nodes.cfg file (that is, database partition 0 becomes NODE0000). Subdirectories SQL00001 through SQLnnnnn will reside on this path. This ensures that the database objects associated with different database partitions are stored in different directories (even if the subdirectory \$DB2INSTANCE under the specified or default path is shared by all database partitions).

If LDAP (Lightweight Directory Access Protocol) support is enabled on the current machine, the database will be automatically registered in the LDAP directory. If a

database object of the same name already exists in the LDAP directory, the database is still created on the local machine, but a warning message is returned, indicating that there is a naming conflict. In this case, the user can manually catalog an LDAP database entry by using the CATALOG LDAP DATABASE command.

CREATE DATABASE will fail if the application is already connected to a database.

When a database is created, a detailed deadlocks event monitor is created. As with any monitor, there is some overhead associated with this event monitor. You can drop the deadlocks event monitor by issuing the DROP EVENT MONITOR command.

Use CATALOG DATABASE to define different alias names for the new database.

The combination of the code set and territory values must be valid. For a list of the supported combinations, see *Supported territory codes and code pages*.

To specify a database path (instead of a drive) on a Windows system, you need to set the DB2 registry variable: DB2_CREATE_DB_ON_PATH=YES.

Compatibilities

For compatibility with versions earlier than Version 8:

- The keyword NODE can be substituted for DBPARTITIONNUM.

Chapter 29. CREATE TOOLS CATALOG

Creates the DB2 tools catalog tables in a new or existing database. The database must be local.

The tools catalog contains information about the administrative tasks that you configure with such tools as the Task Center and Control Center.

This command will optionally force all applications and stop and restart the database manager if new table spaces are created for the tools catalog. It will also update the DB2 Administration Server (DAS) configuration and activate the scheduler.

This command is not valid on a IBM Data Server Client.

Scope

The node from which this command is issued becomes the catalog node for the new database.

Authorization

One of the following:

- *sysadm*
- *sysctrl*

The user must also have DASADM authority to update the DB2 administration server configuration parameters.

Required connection

A database connection is temporarily established by this command during processing. This command will optionally stop and restart the database manager if new table spaces are created.

Command syntax

```
▶▶ CREATE TOOLS CATALOG catalog-name
▶ CREATE NEW DATABASE database-name
  USE EXISTING [TABLESPACE tablespace-name IN] DATABASE database-name
▶ [FORCE] [KEEP INACTIVE]
```

Command parameters

CATALOG *catalog-name*

A name to be used to uniquely identify the DB2 tools catalog. The catalog tables are created under this schema name.

NEW DATABASE *database-name*

A name to be assigned to the new database. This must be a unique name that differentiates the database from any other database in either the local

database directory or the system database directory. The name must conform to naming conventions for databases.

EXISTING DATABASE *database-name*

The name of an existing database to host the tools catalog. It must be a local database.

EXISTING TABLESPACE *tablespace-name*

A name to be used to specify the existing 32K page table space used to create the DB2 tools catalog tables. A 32K page size temporary table space must also exist for the tables to be created successfully.

FORCE

When you create a tools catalog in a new table space, the database manager must be restarted, which requires that no applications be connected. Use the FORCE option to ensure that no applications are connected to the database. If applications are connected, the tools catalog creation will fail unless you specify an existing table space.

KEEP INACTIVE

This option will not update the DB2 administration server configuration parameters or enable the scheduler.

Examples

```
db2 create tools catalog cc create new database toolsdb
```

```
db2 create tools catalog catalog1 use existing database toolsdb force
```

```
db2 create tools catalog foobar use existing tablespace user32ksp  
in database toolsdb
```

```
db2 create tools catalog toolscat use existing database toolsdb keep inactive
```

Usage notes

- The tools catalog tables require two 32K page table spaces (regular and temporary). In addition, unless you specify existing table spaces, a new 32K buffer pool is created for the table spaces. This requires a restart of the database manager. If the database manager must be restarted, all existing applications must be forced off. The new table spaces are created with a single container each in the default database directory path.
- If an active catalog with this name exists before you execute this command, it is deactivated and the new catalog becomes the active catalog.
- Multiple DB2 tools catalogs can be created in the same database and are uniquely identified by the catalog name.
- The **jdk_path** configuration parameter must be set in the DB2 administration server (DAS) configuration to the minimum supported level of the SDK for Java™.
- Updating the DAS configuration parameters requires *dasadm* authority on the DB2 administration server.
- Unless you specify the KEEP INACTIVE option, this command updates the local DAS configuration parameters related to the DB2 tools catalog database configuration and enables the scheduler at the local DAS server.
- The **jdk_64_path** configuration parameter must be set if you are creating a tools catalog against a 64-bit instance on one of the platforms that supports both 32- and 64-bit instances (AIX, HP-UX, and Solaris).

- In multipartition environments, with the Database Partitioning Feature (DPF) enabled, the 32KB REGULAR tablespace must exist on the catalog partition, otherwise the command (such as the one shown below) will fail when a tablespace is specified:

```
db2 create tools catalog foobar use existing tablespace user32Ksp
in database toolsdb
```

Chapter 30. DEACTIVATE DATABASE

Stops the specified database.

Scope

In an MPP system, this command deactivates the specified database on all database partitions in the system. If one or more of these database partitions encounters an error, a warning is returned. The database will be successfully deactivated on some database partitions, but might continue to be active on the nodes encountering the error.

Authorization

One of the following:

- *sysadm*
- *sysctrl*
- *sysmaint*

Required connection

None

Command syntax

```
▶▶ DEACTIVATE DATABASE database-alias
      DB
▶
USER username USING password
```

Command parameters

DATABASE *database-alias*

Specifies the alias of the database to be stopped.

USER *username*

Specifies the user stopping the database.

USING *password*

Specifies the password for the user ID.

Usage notes

Databases initialized by **ACTIVATE DATABASE** can be shut down by **DEACTIVATE DATABASE** or by **db2stop**. If a database was initialized by **ACTIVATE DATABASE**, the last application disconnecting from the database will not shut down the database, and **DEACTIVATE DATABASE** must be used. (In this case, **db2stop** will also shut down the database.)

The application issuing the **DEACTIVATE DATABASE** command cannot have an active database connection to any database.

Chapter 31. DECOMPOSE XML DOCUMENT

This command invokes a stored procedure to decompose a single XML document using a registered and decomposition-enabled XML schema..

Authorization

One of the following groups of privileges or authorities is required:

- One of the following authorizations:
 - CONTROL privilege on all target tables referenced in the set of annotated schema documents
 - DATAACCESS authority
- All of the following privileges:
 - INSERT privileges on the target table, as required for the operation specified in the action file
 - SELECT, INSERT, UPDATE, or DELETE privilege, as applicable, on any table referenced by the db2-xdb:expression or db2-xdb:condition annotation

If the VALIDATE option is specified, USAGE privilege on the XML schema is also required.

Required connection

Database

Command syntax

```
▶▶—DECOMPOSE XML DOCUMENT—xml-document-name—XMLSCHEMA—xml-schema-name————▶▶  
▶▶—VALIDATE—▶▶
```

Command parameters

DECOMPOSE XML DOCUMENT *xml-document-name*

xml-document-name is the file path and file name of the input XML document to be decomposed.

XMLSCHEMA *xml-schema-name*

xml-schema-name is the name of an existing XML schema registered with the XML schema repository to be used for document decomposition.

xml-schema-name is a qualified SQL identifier consisting of an optional SQL schema name followed by a period and the XML schema name. If the SQL schema name is not specified, it is assumed to be the value of the DB2 special register CURRENT SCHEMA.

VALIDATE

This parameter indicates that the input XML document is to be validated first, then decomposed only if the document is valid. If VALIDATE is not specified, the input XML document will not be validated before decomposition.

Examples

The following example specifies that the XML document `./gb/document1.xml` is to be validated and decomposed with the registered XML schema `DB2INST1.GENBANKSCHEMA`.

```
DECOMPOSE XML DOCUMENT ./gb/document1.xml
           XMLSCHEMA DB2INST1.GENBANKSCHEMA
           VALIDATE
```

The following example specifies that the XML document `./gb/document2.xml` is to be decomposed without validation with the registered XML schema `DB2INST2."GENBANK SCHEMA1"`, on the assumption that the value of the DB2 special register `CURRENT SCHEMA` is set to `DB2INST2`.

```
DECOMPOSE XML DOCUMENT ./gb/document2.xml
           XMLSCHEMA "GENBANK SCHEMA1"
```

Chapter 32. DECOMPOSE XML DOCUMENT

This command invokes a stored procedure to decompose a single XML document using a registered and decomposition-enabled XML schema..

Authorization

One of the following groups of privileges or authorities is required:

- One of the following authorizations:
 - CONTROL privilege on all target tables referenced in the set of annotated schema documents
 - DATAACCESS authority
- All of the following privileges:
 - INSERT privileges on the target table, as required for the operation specified in the action file
 - SELECT, INSERT, UPDATE, or DELETE privilege, as applicable, on any table referenced by the db2-xdb:expression or db2-xdb:condition annotation

If the VALIDATE option is specified, USAGE privilege on the XML schema is also required.

Required connection

Database

Command syntax

```
▶▶—DECOMPOSE XML DOCUMENT—xml-document-name—XMLSCHEMA—xml-schema-name————▶▶  
▶———▶▶  
└──VALIDATE──┘
```

Command parameters

DECOMPOSE XML DOCUMENT *xml-document-name*

xml-document-name is the file path and file name of the input XML document to be decomposed.

XMLSCHEMA *xml-schema-name*

xml-schema-name is the name of an existing XML schema registered with the XML schema repository to be used for document decomposition.

xml-schema-name is a qualified SQL identifier consisting of an optional SQL schema name followed by a period and the XML schema name. If the SQL schema name is not specified, it is assumed to be the value of the DB2 special register CURRENT SCHEMA.

VALIDATE

This parameter indicates that the input XML document is to be validated first, then decomposed only if the document is valid. If VALIDATE is not specified, the input XML document will not be validated before decomposition.

Examples

The following example specifies that the XML document `./gb/document1.xml` is to be validated and decomposed with the registered XML schema `DB2INST1.GENBANKSCHEMA`.

```
DECOMPOSE XML DOCUMENT ./gb/document1.xml
           XMLSCHEMA DB2INST1.GENBANKSCHEMA
           VALIDATE
```

The following example specifies that the XML document `./gb/document2.xml` is to be decomposed without validation with the registered XML schema `DB2INST2."GENBANK SCHEMA1"`, on the assumption that the value of the DB2 special register `CURRENT SCHEMA` is set to `DB2INST2`.

```
DECOMPOSE XML DOCUMENT ./gb/document2.xml
           XMLSCHEMA "GENBANK SCHEMA1"
```

Chapter 33. DEREGISTER

Deregisters the DB2 server from the network directory server.

Authorization

None

Required connection

None

Command syntax

```
►► DEREGISTER [DB2 SERVER] [IN]
► LDAP NODE nodename [USER username] [PASSWORD password]
```

Command parameters

IN Specifies the network directory server from which to deregister the DB2 server. The valid value is LDAP for an LDAP (Lightweight Directory Access Protocol) directory server.

USER *username*

This is the user's LDAP distinguished name (DN). The LDAP user DN must have sufficient authority to delete the object from the LDAP directory. The user name is optional when deregistering in LDAP. If the user's LDAP DN is not specified, the credentials of the current logon user will be used.

PASSWORD *password*

Account password.

NODE *nodename*

The node name is the value that was specified when the DB2 server was registered in LDAP.

Usage notes

This command can only be issued for a remote machine when in the LDAP environment. When issued for a remote machine, the node name of the remote server must be specified.

The DB2 server is automatically deregistered when the instance is dropped.

Chapter 34. DESCRIBE

Use the DESCRIBE command to display information about any of the following items:

- Output of a SELECT, CALL, or XQuery statement
- Columns of a table or a view
- Indexes of a table or a view
- Data partitions of a table or view

Authorization

The authorization required depends on the type of information you want to display using the DESCRIBE command.

- If the SYSTOOLSTMPSPACE table space exists, one of the authorities shown in the following table is required.

Object to display information about	Privileges or authorities required
Output of a SELECT statement or XQuery statement	Any of the following privileges or authorities for each table or view referenced in the SELECT statement: <ul style="list-style-type: none">• SELECT privilege• DATAACCESS authority• DBADM authority• SQLADM authority• EXPLAIN authority
Output of a CALL statement	Any of the following privileges or authorities: <ul style="list-style-type: none">• DATAACCESS authority• EXECUTE privilege on the stored procedure

Object to display information about	Privileges or authorities required
Columns of a table or a view	<p>Any of the following privileges or authorities for the SYSCAT.COLUMNS system catalog table:</p> <ul style="list-style-type: none"> • SELECT privilege • ACCESSCTRL authority • DATAACCESS authority • DBADM authority • SECADM authority • SQLADM authority <p>If you want to use the SHOW DETAIL parameter, you also require any of these privileges or authorities on the SYSCAT.DATAPARTITIONEXPRESSION system catalog table.</p> <p>Because PUBLIC has all the privileges over declared temporary tables, you can use the command to display information about any declared temporary table that exists within your connection.</p>
Indexes of a table or a view	<p>Any of the following privileges or authorities on the SYSCAT.INDEXES system catalog table:</p> <ul style="list-style-type: none"> • SELECT privilege • ACCESSCTRL authority • DATAACCESS authority • DBADM authority • SECADM authority • SQLADM authority <p>If you want to use the SHOW DETAIL parameter, you also require EXECUTE privilege on the GET_INDEX_COLNAMES() UDF.</p> <p>Because PUBLIC has all the privileges over declared temporary tables, you can use the command to display information about any declared temporary table that exists within your connection.</p>

Object to display information about	Privileges or authorities required
Data partitions of a table or view	<p>Any of the following privileges or authorities on the SYSCAT.DATAPARTITIONS system catalog table:</p> <ul style="list-style-type: none"> • SELECT privilege • ACCESSCTRL authority • DATAACCESS authority • DBADM authority • SECADM authority • SQLADM authority <p>Because PUBLIC has all the privileges over declared temporary tables, you can use the command to display information about any declared temporary table that exists within your connection.</p>

- If the SYSTOOLSTMPSPACE table space does not exist, SYSADM or SYSCtrl authority is also required in addition to the one of the above authorities.

Required connection

Database. If implicit connect is enabled, a connection to the default database is established.

Command syntax

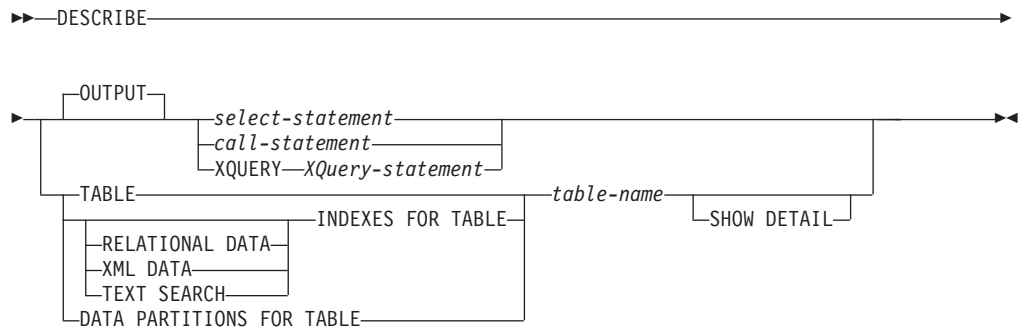

Command parameters

OUTPUT

Indicates that the output of the statement should be described. This keyword is optional.

select-statement | *call-statement* | **XQUERY** *XQuery-statement*

Identifies the statement about which information is wanted. The statement is automatically prepared by CLP. To identify an XQuery statement, precede the statement with the keyword XQUERY. A DESCRIBE OUTPUT statement only returns information about an implicitly hidden column if the column is explicitly specified as part of the SELECT list of the final result table of the query described.

TABLE *table-name*

Specifies the table or view to be described. The fully qualified name in the form *schema.table-name* must be used. An alias for the table cannot be used in place of the actual table. Information about implicitly hidden columns is returned.

The DESCRIBE TABLE command lists the following information about each column:

- Column name
- Type schema
- Type name
- Length
- Scale
- Nulls (yes/no)

INDEXES FOR TABLE *table-name*

Specifies the table or view for which indexes need to be described. You can use the fully qualified name in the form *schema.table-name* or you can just specify the *table-name* and default schema will be used automatically. An alias for the table cannot be used in place of the actual table.

The DESCRIBE INDEXES FOR TABLE command lists the following information about each index of the table or view:

- Index schema
- Index name
- Unique rule
- Number of columns
- Index type

If the DESCRIBE INDEXES FOR TABLE command is specified with the SHOW DETAIL option, the index name is truncated when the index name is greater than 18 bytes. If no index type option is specified, information for all index types is listed: relational data index, index over XML data, and Text Search index. The output includes the following additional information:

- Index ID for a relational data index, an XML path index, an XML regions index, or an index over XML data
- Data Type for an index over XML data
- Hashed for an index over XML data
- Max VARCHAR Length for an index over XML data
- XML Pattern specified for an index over XML data
- Codepage for a text search index
- Language for a text search index
- Format specified for a text search index
- Update minimum for a text search index
- Update frequency for a text search index
- Collection directory for a text search index
- Column names

Specify an index type to list information for only a specific index type. Specifying multiple index types is not supported.

RELATIONAL DATA

If the RELATIONAL DATA index type option is specified without the SHOW DETAIL option, only the following information is listed:

- Index schema
- Index name
- Unique rule
- Number of columns

If SHOW DETAIL is specified, the column names information is also listed.

XML DATA

If the XML DATA index type option is specified without the SHOW DETAIL option, only the following information is listed:

- Index schema
- Index name
- Unique rule
- Number of columns
- Index type

If SHOW DETAIL is specified, the following information for an index over XML data is also listed:

- Index ID
- Data type
- Hashed
- Max Varchar length
- XML Pattern
- Column names

TEXT SEARCH

If the TEXT SEARCH index type option is specified without the SHOW DETAIL option, only the following information is listed:

- Index schema
- Index name

If SHOW DETAIL is specified, the following text search index information is also listed:

- Column name
- Codepage
- Language
- Format
- Update minimum
- Update frequency
- Collection directory

If the TEXT SEARCH option is specified and a text search option is not installed or not properly configured, an error (SQLSTATE 42724) is returned.

See DB2 Text Search for information listed in the columns.

DATA PARTITIONS FOR TABLE *table-name*

Specifies the table or view for which data partitions need to be described. The information displayed for each data partition in the table includes; the

partition identifier and the partitioning intervals. Results are ordered according to the partition identifier sequence. The fully qualified name in the form *schema.table-name* must be used. An alias for the table cannot be used in place of the actual table. The *schema* is the user name under which the table or view was created.

For the DESCRIBE DATA PARTITIONS FOR TABLE command, specifies that output include a second table with the following additional information:

- Data partition sequence identifier
- Data partition expression in SQL

SHOW DETAIL

For the DESCRIBE TABLE command, specifies that output include the following additional information

- Whether a CHARACTER, VARCHAR or LONG VARCHAR column was defined as FOR BIT DATA
- Column number
- Distribution key sequence
- Code page
- Default
- Table partitioning type (for tables partitioned by range this output appears below the original output)
- Partitioning key columns (for tables partitioned by range this output appears below the original output)
- Identifier of table space used for the index

Examples

Describing the output of a SELECT Statement

The following example shows how to describe a SELECT statement:

```
db2 describe output select * from staff
Column Information
```

Number of columns: 7

Data Type	Length	Column Name	Name Length
500 SMALLINT	2	ID	2
449 VARCHAR	9	NAME	4
501 SMALLINT	2	DEPT	4
453 CHARACTER	5	JOB	3
501 SMALLINT	2	YEARS	5
485 DECIMAL	7,2	SALARY	6
485 DECIMAL	7,2	COMM	4

Describing the output of a CALL Statement

Given a stored procedure created with the statement:

```
CREATE PROCEDURE GIVE_BONUS (IN EMPNO INTEGER,
                             IN DEPTNO INTEGER,
                             OUT CHEQUE INTEGER,
                             INOUT BONUS DEC(6,0))
...
```

The following example shows how to describe the output of a CALL statement:

```
db2 describe output call give_bonus(123456, 987, ?, 15000.)
```

Column Information

Number of Columns: 2

Data Type	Length	Column Name	Name Length
497 INTEGER	4	CHEQUE	6
485 DECIMAL	6, 0	BONUS	5

If the procedure has one or more parameters of an array type, the output from the DESCRIBE command has one additional column, that indicates the maximum cardinality of array parameters. An empty value indicates that the parameter is not an array.

Given the array type and procedure created with the statements:

```
CREATE TYPE PRODUCT_LIST AS INTEGER ARRAY[100]
CREATE TYPE CUSTOMER_LIST AS INTEGER ARRAY[1000]
```

```
CREATE PROCEDURE DISCONTINUE_PROD (IN PROD_LIST PRODUCT_LIST,
                                   IN EFFECTIVE_DATE DATE,
                                   OUT NUM_PENDING_ORDERS INTEGER,
                                   OUT CUST_LIST CUSTOMER_LIST)
...

```

The following example shows how to describe the output of a CALL statement with array parameters. The only format difference with the previous example is the Max cardinality column.

```
db2 describe output call discontinue_prod(ARRAY[12, 34, 26], '04/13/2006',?)
```

Column Information

Number of Columns: 2

SQL type	Type length	Column name	Name length	Max cardinality
497 INTEGER	4	NUM_PENDING_ORDERS	17	
497 INTEGER	10	CUSTOMER_LIST	13	1000

Describing the output of an XQuery Statement

Given a table named CUSTOMER that has a column named INFO of the XML data type, the following example shows how to describe an XQuery statement:

```
db2 describe xquery for $cust in db2-fn:xmlcolumn("CUSTOMER.INFO") return $cust
```

Column Information

Number of Columns: 1

SQL type	Type length	Column name	Name length
998 XML	0	1	1

If the keyword XQUERY is not specified, SQL0104N is returned.

```
db2 describe for $cust in db2-fn:xmlcolumn("CUSTOMER.INFO") return $cust
SQL0104N An unexpected token "for" was found following "DESCRIBE". Expected
tokens may include: "OUTPUT". SQLSTATE=42601
```

If the DESCRIBE XQUERY command is issued against a downlevel server that does not support the XQUERY option, the message DB21108E is returned to indicate that the functionality is not supported by the downlevel server.

Describing a Table

The following example shows how to describe a table:

```
db2 describe table user1.department
```

Table: USER1.DEPARTMENT

Column name	Type schema	Type name	Length	Scale	Nulls
AREA	SYSIBM	SMALLINT	2		0 No
DEPT	SYSIBM	CHARACTER	3		0 No
DEPTNAME	SYSIBM	CHARACTER	20		0 Yes

The following example shows how to describe a table with details. If the table is partitioned, as in this example, additional details appear below the existing output. For a non-partitioned table, the additional table heading is not displayed:

```
db2 describe table user1.employee show detail
```

Column name	Type schema	Column number	Type name	Length
FIRST	SYSIBM	0	CHARACTER	10
LAST	SYSIBM	1	CHARACTER	10

Table is partitioned by range (ordered on the following column/s):

```
-----
LAST
FIRST
```

Describing a Table Index

The following examples shows how to describe a table index. This command lists two relational data indexes, six xml data indexes, two text search indexes, and the system indexes:

```
db2 describe indexes for table user1.department
```

Index schema	Index name	Unique rule	Number of columns	Index type
SYSIBM	SQL070531145253450	D	-	XML DATA - REGIONS
SYSIBM	SQL070531145253620	U	1	XML DATA - PATH
USER1	RELIDX1	D	1	RELATIONAL DATA
USER1	RELIDX2	D	2	RELATIONAL DATA
SYSIBM	SQL070531145253650	P	1	RELATIONAL DATA
USER1	XMLIDX1	D	1	XML DATA - VALUES LOGICAL
SYSIBM	SQL070531154625650	D	1	XML DATA - VALUES PHYSICAL
USER1	XMLIDX2	D	1	XML DATA - VALUES LOGICAL
SYSIBM	SQL070531154626000	D	1	XML DATA - VALUES PHYSICAL
USER1	XMLIDX3	D	1	XML DATA - VALUES LOGICAL
SYSIBM	SQL070531154626090	D	1	XML DATA - VALUES PHYSICAL
USER1	XMLIDX4	D	1	XML DATA - VALUES LOGICAL
SYSIBM	SQL070531154626190	D	1	XML DATA - VALUES PHYSICAL
USER1	XMLIDX5	D	1	XML DATA - VALUES LOGICAL
SYSIBM	SQL070531154626290	D	1	XML DATA - VALUES PHYSICAL
USER1	XMLIDX6	D	1	XML DATA - VALUES LOGICAL
SYSIBM	SQL070531154626400	D	1	XML DATA - VALUES PHYSICAL
USER1	TXTIDX1	-	1	TEXT SEARCH
USER1	TXTIDX2	-	1	TEXT SEARCH

The following command lists the relational data indexes for table USER1.DEPARTMENT:

```
db2 describe relational data indexes for table user1.department
```

Index schema	Index name	Unique rule	Number of columns
SYSIBM	SQL070531145253650	P	1
USER1	RELIDX1	D	1
USER1	RELIDX2	D	2

The following command lists the indexes over XML data for table USER1.DEPARTMENT:

```
db2 describe xml data indexes for table user1.department
```

Index schema	Index name	Unique rule	Number of columns	Index type
SYSIBM	SQL070531145253450	D	-	XML DATA - REGIONS
SYSIBM	SQL070531145253620	U	1	XML DATA - PATH
USER1	XMLIDX1	D	1	XML DATA - VALUES LOGICAL
SYSIBM	SQL070531154625650	D	1	XML DATA - VALUES PHYSICAL
USER1	XMLIDX2	D	1	XML DATA - VALUES LOGICAL
SYSIBM	SQL070531154626000	D	1	XML DATA - VALUES PHYSICAL
USER1	XMLIDX3	D	1	XML DATA - VALUES LOGICAL
SYSIBM	SQL070531154626090	D	1	XML DATA - VALUES PHYSICAL
USER1	XMLIDX4	D	1	XML DATA - VALUES LOGICAL
SYSIBM	SQL070531154626190	D	1	XML DATA - VALUES PHYSICAL
USER1	XMLIDX5	D	1	XML DATA - VALUES LOGICAL
SYSIBM	SQL070531154626290	D	1	XML DATA - VALUES PHYSICAL
USER1	XMLIDX6	D	1	XML DATA - VALUES LOGICAL
SYSIBM	SQL070531154626400	D	1	XML DATA - VALUES PHYSICAL

The following command lists the text search index information for table USER1.DEPARTMENT:

```
db2 describe text search indexes for table user1.department
```

Index schema	Index name
USER1	TXTIDX1
USER1	TXTIDX2

The following command lists information about both partitioned and nonpartitioned indexes on the partitioned table myDpartT:

```
db2 describe indexes for table myDPartT
```

Index schema	Index name	Unique rule	Number of columns	Index Partitioning
NEWTON	IDXNDP	D	1	N
NEWTON	IDXDP	D	1	P

Describing Data Partitions

The following example shows how to describe data partitions:

```
db2 describe data partitions for table user1.sales
```

PartitionId	Inclusive (y/n) Low Value	Inclusive (y/n) High Value
0	Y 2001,1	Y 2001,3
1	N 2001,3	Y 2001,6
3	N 2001,6	Y 2001,9

Describing the data partitions with details returns the same output, as in the previous example, and includes an additional table showing the Partition ID and table space where the data for the data partition is stored, and the ID of the table space where the index is stored:

```
db2 describe data partitions for table user1.employee show detail
```

PartitionId	Inclusive (y/n) Low Value	Inclusive (y/n) High Value				
0	Y MINVALUE,MINVALUE	Y 'beck','kevin'				
1	N 'beck','kevin'	N 'treece','jeff'				
2	Y 'treece','jeff'	Y 'zhang','liping'				
3	Y 'zyzyck',MINVALUE	Y MAXVALUE,MAXVALUE				

PartitionId	PartitionName	TableSpId	LongTblSpId	IndexTblSpId	AccessMode	Status
0	PARTx	3	43	50	F	
1	PARTNew	13	13	13	N	A
2	PART3	31	33	35	F	
3	PART4	23	34	23	N	A

Chapter 35. DETACH

Removes the logical DBMS instance attachment, and terminates the physical communication connection if there are no other logical connections using this layer.

Authorization

None

Required connection

None. Removes an existing instance attachment.

Command syntax

▶▶—DETACH—◀◀

Command parameters

None

Chapter 36. DROP CONTACT

Removes a contact from the list of contacts defined on the local system. A contact is a user to whom the Scheduler and Health Monitor send messages. The setting of the Database Administration Server (DAS) **contact_host** configuration parameter determines whether the list is local or global.

Authorization

None

Required connection

None. Local execution only: this command cannot be used with a remote connection.

Command syntax

```
»»—DROP CONTACT—name—————»»
```

Command parameters

CONTACT *name*

The name of the contact that will be dropped from the local system.

Chapter 37. DROP CONTACTGROUP

Removes a contact group from the list of contacts defined on the local system. A contact group contains a list of users to whom the Scheduler and Health Monitor send messages. The setting of the Database Administration Server (DAS) `contact_host` configuration parameter determines whether the list is local or global.

Authorization

None

Required Connection

None

Command Syntax

```
►►—DROP CONTACTGROUP—name—————►◄
```

Command Parameters

CONTACTGROUP *name*

The name of the contact group that will be dropped from the local system.

Chapter 38. DROP DATABASE

Deletes the database contents and all log files for the database, uncatalogs the database, and deletes the database subdirectory.

Scope

By default, this command affects all database partitions that are listed in the `db2nodes.cfg` file.

Authorization

One of the following:

- `sysadm`
- `sysctrl`

Required connection

Instance. An explicit attachment is not required. If the database is listed as remote, an instance attachment to the remote database partition server is established for the duration of the command.

Command syntax

```
➤➤ DROP DATABASE database-alias AT DBPARTITIONNUM ➤➤
```

The diagram shows the command syntax for the DROP DATABASE command. It starts with a double arrow pointing right, followed by the keyword 'DROP'. A bracket connects 'DROP' to 'DATABASE', which is followed by the placeholder 'database-alias'. Another bracket connects 'DATABASE' to 'AT DBPARTITIONNUM', which is followed by a double arrow pointing right.

Command parameters

DATABASE *database-alias*

Specifies the alias of the database to be dropped. The database must be cataloged in the system database directory.

AT DBPARTITIONNUM

Specifies that the database is to be deleted only on the database partition that issued the DROP DATABASE command. This parameter is used by utilities supplied with DB2 Warehouse Edition and the Database Partitioning Feature (DPF), and is not intended for general use. Improper use of this parameter can cause inconsistencies in the system, so it should only be used with caution.

Examples

The following example deletes the database referenced by the database alias `SAMPLE`:

```
db2 drop database sample
```

Usage notes

DROP DATABASE deletes all user data and log files, as well as any backup and restore history for the database. If the log files are needed for a roll-forward

recovery after a restore operation, or the backup history required to restore the database, these files should be saved prior to issuing this command.

The database must not be in use; all users must be disconnected from the database before the database can be dropped.

To be dropped, a database must be cataloged in the system database directory. Only the specified database alias is removed from the system database directory. If other aliases with the same database name exist, their entries remain. If the database being dropped is the last entry in the local database directory, the local database directory is deleted automatically.

If DROP DATABASE is issued from a remote client (or from a different instance on the same machine), the specified alias is removed from the client's system database directory. The corresponding database name is removed from the server's system database directory.

Compatibilities

For compatibility with versions earlier than Version 8:

- The keyword NODE can be substituted for DBPARTITIONNUM.

Chapter 39. DROP DBPARTITIONNUM VERIFY

Verifies if a database partition exists in the database partition groups of any databases, and if an event monitor is defined on the database partition. This command should be used prior to dropping a database partition from a partitioned database environment.

Scope

This command only affects the database partition on which it is issued.

Authorization

sysadm

Command syntax

►►—DROP DBPARTITIONNUM VERIFY—◄◄

Command parameters

None

Usage notes

If a message is returned, indicating that the database partition is not in use, use the STOP DATABASE MANAGER command with DROP DBPARTITIONNUM to remove the entry for the database partition from the db2nodes.cfg file, which removes the database partition from the database system.

If a message is returned, indicating that the database partition is in use, the following actions should be taken:

1. If the database partition contains data, redistribute the data to remove it from the database partition using REDISTRIBUTE DATABASE PARTITION GROUP. Use either the DROP DBPARTITIONNUM option on the REDISTRIBUTE DATABASE PARTITION GROUP command or on the ALTER DATABASE PARTITION GROUP statement to remove the database partition from any database partition groups for the database. This must be done for each database that contains the database partition in a database partition group.
2. Drop any event monitors that are defined on the database partition.
3. Rerun DROP DBPARTITIONNUM VERIFY to ensure that the database is no longer in use.

Compatibilities

For compatibility with versions earlier than Version 8:

- The keyword NODE can be substituted for DBPARTITIONNUM.

Chapter 40. DROP TOOLS CATALOG

Drops the DB2 tools catalog tables for the specified catalog in the given database. This command is not valid on a IBM Data Server Client.

Warning: If you drop the active tools catalog, you can no longer schedule tasks and scheduled tasks are not executed. To activate the scheduler, you must activate a previous tools catalog or create a new one.

Scope

This command affects the database.

Authorization

One of the following:

- *sysadm*
- *sysctrl*

The user must also have DASADM authority to update the DB2 administration server (DAS) configuration parameters.

Required connection

A database connection is temporarily established by this command during processing.

Command syntax

```
►► DROP TOOLS CATALOG—catalog-name—IN DATABASE—database-name—[FORCE]—►►
```

Command parameters

CATALOG *catalog-name*

A name to be used to uniquely identify the DB2 tools catalog. The catalog tables are dropped from this schema.

DATABASE *database-name*

A name to be used to connect to the local database containing the catalog tables.

FORCE

The force option is used to force the DB2 administration server's scheduler to stop. If this is not specified, the tools catalog will not be dropped if the scheduler cannot be stopped.

Examples

```
db2 drop tools catalog cc in database toolsdb
```

```
db2 drop tools catalog in database toolsdb force
```

Usage notes

- The **jdk_path** configuration parameter must be set in the DB2 administration server (DAS) configuration to the minimum supported level of the SDK for Java.
- This command will disable the scheduler at the local DAS and reset the DAS configuration parameters related to the DB2 tools catalog database configuration.

Chapter 41. ECHO

Permits the user to write character strings to standard output.

Authorization

None

Required connection

None

Command syntax

▶▶ ECHO character-string ▶▶

Command parameters

character-string
Any character string.

Usage notes

If an input file is used as standard input, or comments are to be printed without being interpreted by the command shell, the ECHO command will print character strings directly to standard output.

One line is printed each time that ECHO is issued.

The ECHO command is not affected by the verbose (-v) option.

Chapter 42. EDIT

Launches a user-specified editor with a specified command for editing. When the user finishes editing, saves the contents of the editor and exits the editor, permits the user to execute the command in CLP interactive mode.

Scope

This command can only be run within CLP interactive mode. Specifically, it cannot be run from the CLP command mode or the CLP batch mode.

Authorization

None

Required connection

None

Command syntax

→ EDIT [E] [EDITOR=*editor*] [*num*] →

Command parameters

EDITOR

Launch the editor specified for editing. If this parameter is not specified, the editor to be used is determined in the following order:

1. the editor specified by the DB2_CLP_EDITOR registry variable
2. the editor specified by the VISUAL environment variable
3. the editor specified by the EDITOR environment variable
4. On Windows operating systems, the Notepad editor; on UNIX operating systems, the vi editor

num If *num* is positive, launches the editor with the command corresponding to *num*. If *num* is negative, launches the editor with the command corresponding to *num*, counting backwards from the most recent command in the command history. Zero is not a valid value for *num*. If this parameter is not specified, launches the editor with the most recently run command. (This is equivalent to specifying a value of -1 for *num*.)

Usage notes

1. The editor specified must be a valid editor contained in the PATH of the operating system.
2. You can view a list of the most recently run commands available for editing by executing the HISTORY command.
3. The EDIT command will never be recorded in the command history. However, if you choose to run a command that was edited using the EDIT command, this command will be recorded in the command history.

Chapter 43. EXPORT

Exports data from a database to one of several external file formats. The user specifies the data to be exported by supplying an SQL SELECT statement, or by providing hierarchical information for typed tables.

Quick link to “File type modifiers for the export utility” on page 182.

Authorization

One of the following:

- *dataaccess* authority
- CONTROL or SELECT privilege on each participating table or view

Required connection

Database. If implicit connect is enabled, a connection to the default database is established. Utility access to Linux, UNIX, or Windows database servers from Linux, UNIX, or Windows clients must be a direct connection through the engine and not through a DB2 Connect gateway or loop back environment.

Command syntax

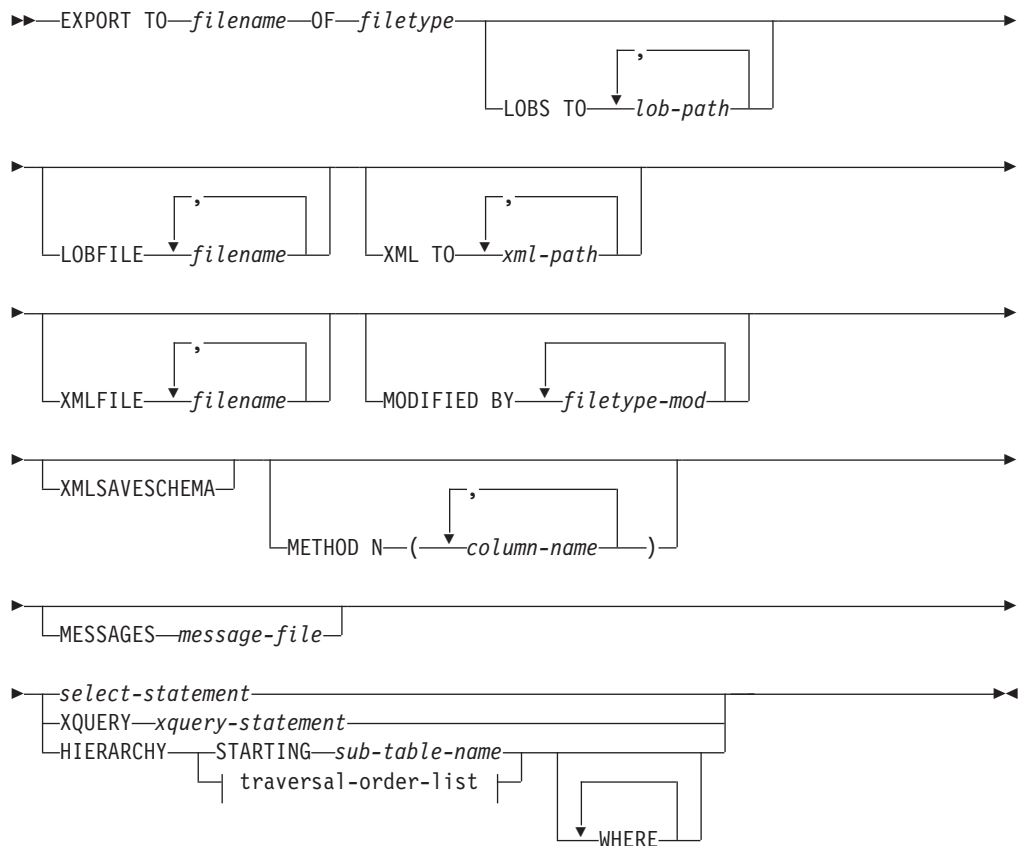

traversal-order-list:



Command parameters

HIERARCHY *traversal-order-list*

Export a sub-hierarchy using the specified traverse order. All sub-tables must be listed in PRE-ORDER fashion. The first sub-table name is used as the target table name for the SELECT statement.

HIERARCHY STARTING *sub-table-name*

Using the default traverse order (OUTER order for ASC, DEL, or WSF files, or the order stored in PC/IXF data files), export a sub-hierarchy starting from *sub-table-name*.

LOBFILE *filename*

Specifies one or more base file names for the LOB files. When name space is exhausted for the first name, the second name is used, and so on. This will implicitly activate the LOBSINFILE behavior.

When creating LOB files during an export operation, file names are constructed by appending the current base name from this list to the current path (from *lob-path*), and then appending a 3-digit sequence number to start and the three character identifier *lob*. For example, if the current LOB path is the directory `/u/foo/lob/path/`, and the current LOB file name is `bar`, the LOB files created will be `/u/foo/lob/path/bar.001.lob`, `/u/foo/lob/path/bar.002.lob`, and so on. The 3-digit sequence number in the LOB file name will grow to 4-digits once 999 is used, 4-digits will grow to 5-digits once 9999 is used, and so on.

LOBS TO *lob-path*

Specifies one or more paths to directories in which the LOB files are to be stored. There will be at least one file per LOB path, and each file will contain at least one LOB. The maximum number of paths that can be specified is 999. This will implicitly activate the LOBSINFILE behavior.

MESSAGES *message-file*

Specifies the destination for warning and error messages that occur during an export operation. If the file already exists, the export utility appends the information. If *message-file* is omitted, the messages are written to standard output.

METHOD N *column-name*

Specifies one or more column names to be used in the output file. If this parameter is not specified, the column names in the table are used. This parameter is valid only for WSF and IXF files, but is not valid when exporting hierarchical data.

MODIFIED BY *filetype-mod*

Specifies file type modifier options. See “File type modifiers for the export utility” on page 182.

OF *filetype*

Specifies the format of the data in the output file:

- DEL (delimited ASCII format), which is used by a variety of database manager and file manager programs.

- WSF (work sheet format), which is used by programs such as:
 - Lotus® 1-2-3®
 - Lotus Symphony

When exporting BIGINT or DECIMAL data, only values that fall within the range of type DOUBLE can be exported accurately. Although values that do not fall within this range are also exported, importing or loading these values back might result in incorrect data, depending on the operating system.

Note: Support for the WSF file format is deprecated and might be removed in a future release. It is recommended that you start using a supported file format instead of WSF files before support is removed.

- IXF (Integration Exchange Format, PC version) is a proprietary binary format.

select-statement

Specifies the SELECT or XQUERY statement that will return the data to be exported. If the statement causes an error, a message is written to the message file (or to standard output). If the error code is one of SQL0012W, SQL0347W, SQL0360W, SQL0437W, or SQL1824W, the export operation continues; otherwise, it stops.

TO *filename*

Specifies the name of the file to which data is to be exported. If the complete path to the file is not specified, the export utility uses the current directory and the default drive as the destination.

If the name of a file that already exists is specified, the export utility overwrites the contents of the file; it does not append the information.

XMLFILE *filename*

Specifies one or more base file names for the XML files. When name space is exhausted for the first name, the second name is used, and so on.

When creating XML files during an export operation, file names are constructed by appending the current base name from this list to the current path (from *xml-path*), appending a 3-digit sequence number, and appending the three character identifier xml. For example, if the current XML path is the directory /u/foo/xml/path/, and the current XML file name is bar, the XML files created will be /u/foo/xml/path/bar.001.xml, /u/foo/xml/path/bar.002.xml, and so on.

XML TO *xml-path*

Specifies one or more paths to directories in which the XML files are to be stored. There will be at least one file per XML path, and each file will contain at least one XQuery Data Model (XDM) instance. If more than one path is specified, then XDM instances are distributed evenly among the paths.

XMLSAVESCHEMA

Specifies that XML schema information should be saved for all XML columns. For each exported XML document that was validated against an XML schema when it was inserted, the fully qualified SQL identifier of that schema will be stored as an (SCH) attribute inside the corresponding XML Data Specifier (XDS). If the exported document was not validated against an XML schema or the schema object no longer exists in the database, an SCH attribute will not be included in the corresponding XDS.

The schema and name portions of the SQL identifier are stored as the "OBJECTSCHEMA" and "OBJECTNAME" values in the row of the SYSCAT.XSROBJECTS catalog table corresponding to the XML schema.

The XMLSAVESHEMA option is not compatible with XQuery sequences that do not produce well-formed XML documents.

Examples

The following example shows how to export information from the STAFF table in the SAMPLE database to the file myfile.ixf. The output will be in IXF format. You must be connected to the SAMPLE database before issuing the command. The index definitions (if any) will be stored in the output file except when the database connection is made through DB2 Connect.

```
db2 export to myfile.ixf of ixf messages msgs.txt select * from staff
```

The following example shows how to export the information about employees in Department 20 from the STAFF table in the SAMPLE database. The output will be in IXF format and will go into the awards.ixf file. You must first connect to the SAMPLE database before issuing the command. Also, the actual column name in the table is 'dept' instead of 'department'.

```
db2 export to awards.ixf of ixf messages msgs.txt select * from staff
where dept = 20
```

The following example shows how to export LOBs to a DEL file:

```
db2 export to myfile.del of del lobs to mylobs/
lobfile lobs1, lobs2 modified by lobsinfile
select * from emp_photo
```

The following example shows how to export LOBs to a DEL file, specifying a second directory for files that might not fit into the first directory:

```
db2 export to myfile.del of del
lobs to /db2exp1/, /db2exp2/ modified by lobsinfile
select * from emp_photo
```

The following example shows how to export data to a DEL file, using a single quotation mark as the string delimiter, a semicolon as the column delimiter, and a comma as the decimal point. The same convention should be used when importing data back into the database:

```
db2 export to myfile.del of del
modified by chardel'' coldel; decpt,
select * from staff
```

Usage notes

- Be sure to complete all table operations and release all locks before starting an export operation. This can be done by issuing a COMMIT after closing all cursors opened WITH HOLD, or by issuing a ROLLBACK.
- Table aliases can be used in the SELECT statement.
- The messages placed in the message file include the information returned from the message retrieval service. Each message begins on a new line.
- The export utility produces a warning message whenever a character column with a length greater than 254 is selected for export to DEL format files.
- PC/IXF import should be used to move data between databases. If character data containing row separators is exported to a delimited ASCII (DEL) file and processed by a text transfer program, fields containing the row separators will shrink or expand.

- The file copying step is not necessary if the source and the target databases are both accessible from the same client.
- DB2 Connect can be used to export tables from DRDA servers such as DB2 for OS/390, DB2 for VM and VSE, and DB2 for OS/400®. Only PC/IXF export is supported.
- When exporting to the IXF format, if identifiers exceed the maximum size supported by the IXF format, the export will succeed but the resulting datafile cannot be used by a subsequent import operation using the CREATE mode. SQL27984W will be returned.
- When exporting to a diskette on Windows, and the table that has more data than the capacity of a single diskette, the system will prompt for another diskette, and multiple-part PC/IXF files (also known as multi-volume PC/IXF files, or logically split PC/IXF files), are generated and stored in separate diskettes. In each file, with the exception of the last, there is a DB2 CONTINUATION RECORD (or "AC" Record in short) written to indicate the files are logically split and where to look for the next file. The files can then be transferred to an AIX system, to be read by the import and load utilities. The export utility will not create multiple-part PC/IXF files when invoked from an AIX system. For detailed usage, see the IMPORT command or LOAD command.
- The export utility will store the NOT NULL WITH DEFAULT attribute of the table in an IXF file if the SELECT statement provided is in the form SELECT * FROM tablename.
- When exporting typed tables, subselect statements can only be expressed by specifying the target table name and the WHERE clause. Fullselect and *select-statement* cannot be specified when exporting a hierarchy.
- For file formats other than IXF, it is recommended that the traversal order list be specified, because it tells DB2 how to traverse the hierarchy, and what sub-tables to export. If this list is not specified, all tables in the hierarchy are exported, and the default order is the OUTER order. The alternative is to use the default order, which is the order given by the OUTER function.
- Use the same traverse order during an import operation. The load utility does not support loading hierarchies or sub-hierarchies.
- When exporting data from a table that has protected rows, the LBAC credentials held by the session authorization id might limit the rows that are exported. Rows that the session authorization ID does not have read access to will not be exported. No error or warning is given.
- If the LBAC credentials held by the session authorization id do not allow reading from one or more protected columns included in the export then the export fails and an error (SQLSTATE 42512) is returned.
- Export packages are bound using DATETIME ISO format, thus, all date/time/timestamp values are converted into ISO format when cast to a string representation. Since the CLP packages are bound using DATETIME LOC format (locale specific format), you may see inconsistent behavior between CLP and export if the CLP DATETIME format is different from ISO. For instance, the following SELECT statement may return expected results:

```

db2 select col2 from tab1 where char(col2)='05/10/2005';
COL2
-----
05/10/2005
05/10/2005
05/10/2005
3 record(s) selected.

```

But an export command using the same select clause will not:

```

db2 export to test.del of del select col2 from test
where char(col2)='05/10/2005';
Number of rows exported: 0

```

Now, replacing the LOCALE date format with ISO format gives the expected results:

```

db2 export to test.del of del select col2 from test
where char(col2)='2005-05-10';
Number of rows exported: 3

```

File type modifiers for the export utility

Table 8. Valid file type modifiers for the export utility: All file formats

Modifier	Description
lobsinfile	<p><i>lob-path</i> specifies the path to the files containing LOB data.</p> <p>Each path contains at least one file that contains at least one LOB pointed to by a Lob Location Specifier (LLS) in the data file. The LLS is a string representation of the location of a LOB in a file stored in the LOB file path. The format of an LLS is <i>filename.ext.nnn.mmm/</i>, where <i>filename.ext</i> is the name of the file that contains the LOB, <i>nnn</i> is the offset in bytes of the LOB within the file, and <i>mmm</i> is the length of the LOB in bytes. For example, if the string <i>db2exp.001.123.456/</i> is stored in the data file, the LOB is located at offset 123 in the file <i>db2exp.001</i>, and is 456 bytes long.</p> <p>If you specify the “lobsinfile” modifier when using EXPORT, the LOB data is placed in the locations specified by the LOBS TO clause. Otherwise the LOB data is sent to the data file directory. The LOBS TO clause specifies one or more paths to directories in which the LOB files are to be stored. There will be at least one file per LOB path, and each file will contain at least one LOB. The LOBS TO or LOBFILE options will implicitly activate the LOBSINFILE behavior.</p> <p>To indicate a null LOB, enter the size as -1. If the size is specified as 0, it is treated as a 0 length LOB. For null LOBS with length of -1, the offset and the file name are ignored. For example, the LLS of a null LOB might be <i>db2exp.001.7.-1/</i>.</p>
xmlinsefiles	Each XQuery Data Model (XDM) instance is written to a separate file. By default, multiple values are concatenated together in the same file.
lobsinsefiles	Each LOB value is written to a separate file. By default, multiple values are concatenated together in the same file.
xmlnodeclaration	XDM instances are written without an XML declaration tag. By default, XDM instances are exported with an XML declaration tag at the beginning that includes an encoding attribute.
xmlchar	XDM instances are written in the character codepage. Note that the character codepage is the value specified by the codepage file type modifier, or the application codepage if it is not specified. By default, XDM instances are written out in Unicode.
xmlgraphic	If the <i>xmlgraphic</i> modifier is specified with the EXPORT command, the exported XML document will be encoded in the UTF-16 code page regardless of the application code page or the codepage file type modifier.

Table 9. Valid file type modifiers for the export utility: DEL (delimited ASCII) file format (continued)

Modifier	Description
timestampformat="x"	<p>x is the format of the time stamp in the source file.⁴ Valid time stamp elements are:</p> <ul style="list-style-type: none"> YYYY - Year (four digits ranging from 0000 - 9999) M - Month (one or two digits ranging from 1 - 12) MM - Month (two digits ranging from 01 - 12; mutually exclusive with M and MMM) MMM - Month (three-letter case-insensitive abbreviation for the month name; mutually exclusive with M and MM) D - Day (one or two digits ranging from 1 - 31) DD - Day (two digits ranging from 1 - 31; mutually exclusive with D) DDD - Day of the year (three digits ranging from 001 - 366; mutually exclusive with other day or month elements) H - Hour (one or two digits ranging from 0 - 12 for a 12 hour system, and 0 - 24 for a 24 hour system) HH - Hour (two digits ranging from 0 - 12 for a 12 hour system, and 0 - 24 for a 24 hour system; mutually exclusive with H) M - Minute (one or two digits ranging from 0 - 59) MM - Minute (two digits ranging from 0 - 59; mutually exclusive with M, minute) S - Second (one or two digits ranging from 0 - 59) SS - Second (two digits ranging from 0 - 59; mutually exclusive with S) SSSSS - Second of the day after midnight (5 digits ranging from 00000 - 86399; mutually exclusive with other time elements) U (1 to 12 times) <ul style="list-style-type: none"> - Fractional seconds(number of occurrences of U represent the number of digits with each digit ranging from 0 to 9) TT - Meridian indicator (AM or PM) <p>Following is an example of a time stamp format:</p> <pre>"YYYY/MM/DD HH:MM:SS.UUUUUU"</pre> <p>The MMM element will produce the following values: 'Jan', 'Feb', 'Mar', 'Apr', 'May', 'Jun', 'Jul', 'Aug', 'Sep', 'Oct', 'Nov', and 'Dec'. 'Jan' is equal to month 1, and 'Dec' is equal to month 12.</p> <p>The following example illustrates how to export data containing user-defined time stamp formats from a table called 'schedule':</p> <pre>db2 export to delfile2 of del modified by timestampformat="yyyy.mm.dd hh:mm tt" select * from schedule</pre>

Table 10. Valid file type modifiers for the export utility: IXF file format

Modifier	Description
codepage=x	<p>x is an ASCII character string. The value is interpreted as the code page of the data in the output data set. Converts character data from this code page to the application code page during the export operation.</p> <p>For pure DBCS (graphic), mixed DBCS, and EUC, delimiters are restricted to the range of x00 to x3F, inclusive. The codepage modifier cannot be used with the lobsinfile modifier.</p>

Table 11. Valid file type modifiers for the export utility: WSF file format⁶

Modifier	Description
1	Creates a WSF file that is compatible with Lotus 1-2-3 Release 1, or Lotus 1-2-3 Release 1a. ⁵ This is the default.
2	Creates a WSF file that is compatible with Lotus Symphony Release 1.0. ⁵
3	Creates a WSF file that is compatible with Lotus 1-2-3 Version 2, or Lotus Symphony Release 1.1. ⁵
4	Creates a WSF file containing DBCS characters.

Note:

1. The export utility does not issue a warning if an attempt is made to use unsupported file types with the MODIFIED BY option. If this is attempted, the export operation fails, and an error code is returned.
2. *Delimiter considerations for moving data* lists restrictions that apply to the characters that can be used as delimiter overrides.
3. The export utility normally writes
 - date data in YYYYMMDD format
 - char(date) data in "YYYY-MM-DD" format
 - time data in "HH.MM.SS" format
 - time stamp data in "YYYY-MM-DD-HH. MM.SS. uuuuuu" format

Data contained in any datetime columns specified in the SELECT statement for the export operation will also be in these formats.

4. For time stamp formats, care must be taken to avoid ambiguity between the month and the minute descriptors, since they both use the letter M. A month field must be adjacent to other date fields. A minute field must be adjacent to other time fields. Following are some ambiguous time stamp formats:

"M" (could be a month, or a minute)
 "M:M" (Which is which?)
 "M:YYYY:M" (Both are interpreted as month.)
 "S:M:YYYY" (adjacent to both a time value and a date value)

In ambiguous cases, the utility will report an error message, and the operation will fail.

Following are some unambiguous time stamp formats:

"M:YYYY" (Month)
 "S:M" (Minute)
 "M:YYYY:S:M" (Month...Minute)
 "M:H:YYYY:M:D" (Minute...Month)

5. These files can also be directed to a specific product by specifying an L for Lotus 1-2-3, or an S for Symphony in the *filetype-mod* parameter string. Only one value or product designator can be specified. Support for the WSF file format is deprecated and might be removed in a future release. It is recommended that you start using a supported file format instead of WSF files before support is removed.
6. The WSF file format is not supported for XML columns. Support for this file format is deprecated and might be removed in a future release. It is recommended that you start using a supported file format instead of WSF files before support is removed.
7. All XDM instances are written to XML files that are separate from the main data file, even if neither the XMLFILE nor the XML TO clause is specified. By

default, XML files are written to the path of the exported data file. The default base name for XML files is the name of the exported data file with the extension ".xml" appended to it.

8. All XDM instances are written with an XML declaration at the beginning that includes an encoding attribute, unless the XMLNODEDECLARATION file type modifier is specified.
9. By default, all XDM instances are written in Unicode unless the XMLCHAR or XMLGRAPHIC file type modifier is specified.
10. The default path for XML data and LOB data is the path of the main data file. The default XML file base name is the main data file. The default LOB file base name is the main data file. For example, if the main data file is:
/mypath/myfile.del

the default path for XML data and LOB data is:

/mypath"

the default XML file base name is:

myfile.del

and the default LOB file base name is:

myfile.del

The LOBSINFILE file type modifier must be specified in order to have LOB files generated.

11. The export utility appends a numeric identifier to each LOB file or XML file. The identifier starts as a 3 digit, 0 padded sequence value, starting at:
.001

After the 999th LOB file or XML file, the identifier will no longer be padded with zeroes (for example, the 1000th LOG file or XML file will have an extension of:

.1000

Following the numeric identifier is a three character type identifier representing the data type, either:

.lob

or

.xml

For example, a generated LOB file would have a name in the format:

myfile.del.001.lob

and a generated XML file would be have a name in the format:

myfile.del.001.xml

12. It is possible to have the export utility export XDM instances that are not well-formed documents by specifying an XQuery. However, you will not be able to import or load these exported documents directly into an XML column, since XML columns can only contain complete documents.

Chapter 44. FORCE APPLICATION

Forces local or remote users or applications off the system to allow for maintenance on a server.

Attention: If an operation that cannot be interrupted (RESTORE DATABASE, for example) is forced, the operation must be successfully re-executed before the database becomes available.

Scope

This command affects all database partitions that are listed in the `$HOME/sql1lib/db2nodes.cfg` file.

In a partitioned database environment, this command does not have to be issued from the coordinator database partition of the application being forced. It can be issued from any node (database partition server) in the partitioned database environment.

Authorization

One of the following:

- `sysadm`
- `sysctrl`
- `sysmaint`

Required connection

Instance. To force users off a remote server, it is first necessary to attach to that server. If no attachment exists, this command is executed locally.

Command syntax

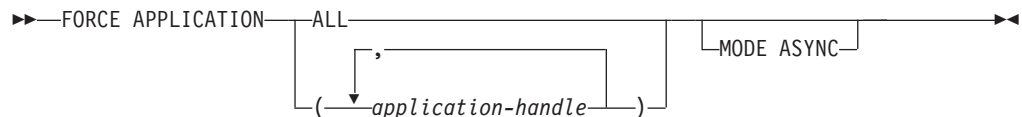

Command parameters

FORCE APPLICATION

ALL All applications will be disconnected from the database.

application-handle

Specifies the agent to be terminated. List the values using the LIST APPLICATIONS command.

MODE ASYNC

The command does not wait for all specified users to be terminated before returning; it returns as soon as the function has been successfully issued or an error (such as invalid syntax) is discovered.

This is the only mode that is currently supported.

Examples

The following example forces two users, with *application-handle* values of 41408 and 55458, to disconnect from the database:

```
db2 force application ( 41408, 55458 )
```

Usage notes

The database manager remains active so that subsequent database manager operations can be handled without the need for db2start.

To preserve database integrity, only users who are idling or executing interruptible database operations can be terminated.

The following types of users and applications cannot be forced:

- users creating a database
- system applications

In order to successfully force these types of users and applications, the database must be deactivated and/or the instance restarted.

After a FORCE APPLICATION has been issued, the database will still accept requests to connect. Additional forces might be required to completely force all users off.

Chapter 45. GET ADMIN CONFIGURATION

Returns the values of individual DB2 Administration Server (DAS) configuration parameter values on the administration node of the system. The DAS is a special administrative tool that enables remote administration of DB2 servers. For a list of the DAS configuration parameters, see the description of the UPDATE ADMIN CONFIGURATION command.

Scope

This command returns information about DAS configuration parameters on the administration node of the system to which you are attached or that you specify in the FOR NODE option.

Authorization

None

Required connection

Node. To display the DAS configuration for a remote system, first connect to that system or use the FOR NODE option to specify the administration node of the system.

Command syntax

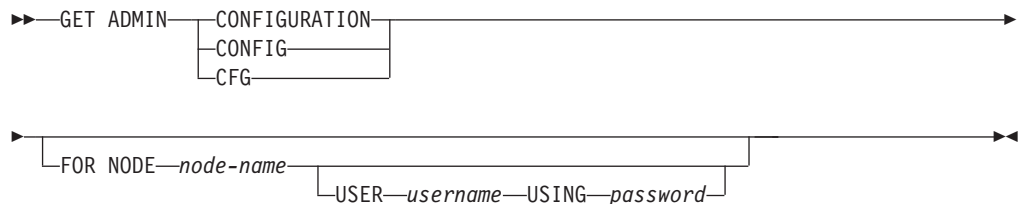

Command parameters

FOR NODE *node-name*

Enter the name of the administration node to view DAS configuration parameters there.

USER *username* USING *password*

If connection to the node requires user name and password, enter this information.

Examples

The following is sample output from GET ADMIN CONFIGURATION:

Admin Server Configuration

Authentication Type DAS (AUTHENTICATION) = SERVER_ENCRYPT

DAS Administration Authority Group Name (DASADM_GROUP) = ADMINISTRATORS

DAS Discovery Mode (DISCOVER) = SEARCH

Name of the DB2 Server System (DB2SYSTEM) = swalkty

```

Java Development Kit Installation Path DAS (JDK_PATH) = e:\sql1lib\java\jdk

DAS Code Page (DAS_CODEPAGE) = 0
DAS Territory (DAS_TERRITORY) = 0

Location of Contact List (CONTACT_HOST) = hostA.ibm.ca
Execute Expired Tasks (EXEC_EXP_TASK) = NO
Scheduler Mode (SCHED_ENABLE) = ON
SMTP Server (SMTP_SERVER) = smtp1.ibm.ca
Tools Catalog Database (TOOLSCAT_DB) = CCMD
Tools Catalog Database Instance (TOOLSCAT_INST) = DB2
Tools Catalog Database Schema (TOOLSCAT_SCHEMA) = TOOLSCAT
Scheduler User ID = db2admin

```

Usage notes

If an error occurs, the information returned is not valid. If the configuration file is invalid, an error message is returned. The user must install the DAS again to recover.

To set the configuration parameters to the default values shipped with the DAS, use the RESET ADMIN CONFIGURATION command.

Chapter 46. GET ALERT CONFIGURATION

Returns the alert configuration settings for health indicators for a particular instance.

Important: This command or API has been deprecated and might be removed in a future release because the health monitor has been deprecated in Version 9.7. For more information, see the “Health monitor has been deprecated” topic in the *What’s New for DB2 Version 9.7* book.

Authorization

None

Required connection

Instance. An explicit attachment is not required.

Command syntax

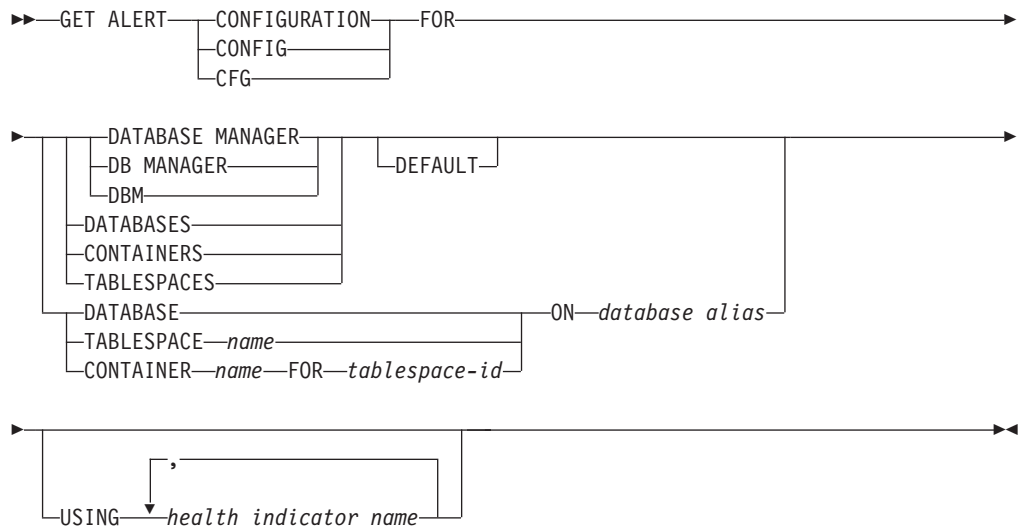

Command parameters

DATABASE MANAGER

Retrieves alert settings for the database manager.

DATABAS

Retrieves alert settings for all databases managed by the database manager. These are the settings that apply to all databases that do not have custom settings. Custom settings are defined using the `DATABASE ON database alias` clause.

CONTAINERS

Retrieves alert settings for all table space containers managed by the database manager. These are the settings that apply to all table space containers that do not have custom settings. Custom settings are defined using the `CONTAINER name ON database alias` clause.

TABLESPACES

Retrieves alert settings for all table spaces managed by the database manager. These are the settings that apply to all table spaces that do not have custom settings. Custom settings are defined using the `TABLESPACE name ON database alias` clause.

DEFAULT

Specifies that the install defaults are to be retrieved.

DATABASE ON *database alias*

Retrieves the alert settings for the database specified using the `ON database alias` clause. If this database does not have custom settings, then the settings for all databases for the instance will be returned, which is equivalent to using the `DATABASES` parameter.

CONTAINER *name* FOR *tablespace-id* ON *database alias*

Retrieves the alert settings for the table space container called *name*, for the table space specified using the `FOR tablespace-id` clause, on the database specified using the `ON database alias` clause. If this table space container does not have custom settings, then the settings for all table space containers for the database will be returned, which is equivalent to using the `CONTAINERS` parameter.

TABLESPACE *name* ON *database alias*

Retrieves the alert settings for the table space called *name*, on the database specified using the `ON database alias` clause. If this table space does not have custom settings, then the settings for all table spaces for the database will be returned, which is equivalent to using the `TABLESPACES` parameter.

USING *health indicator name*

Specifies the set of health indicators for which alert configuration information will be returned. Health indicator names consist of a two-letter object identifier followed by a name that describes what the indicator measures. For example: `db.sort_privmem_util`. This is an optional clause, meaning that if it is not used, all health indicators for the specified object or object type will be returned.

Examples

The following is typical output resulting from a request for database manager information:

```
DB2 GET ALERT CFG FOR DBM
```

```
Alert Configuration
Indicator Name      = db2.db2_op_status
Default            = Yes
Type               = State-based
Sensitivity        = 0
Formula            = db2.db2_status;
Actions            = Disabled
Threshold or State checking = Enabled

Indicator Name      = db2.sort_privmem_util
Default            = Yes
Type               = Threshold-based
Warning            = 90
Alarm              = 100
Unit               = %
Sensitivity        = 0
Formula            = ((db2.sort_heap_allocated/sheapthres)
```

```

        *100);
    Actions = Disabled
    Threshold or State checking = Enabled

Indicator Name = db2.mon_heap_util
    Default = Yes
    Type = Threshold-based
    Warning = 85
    Alarm = 95
    Unit = %
    Sensitivity = 0
    Formula = ((db2.mon_heap_cur_size/
        db2.mon_heap_max_size)*100);
    Actions = Disabled
    Threshold or State checking = Enabled

```

The following is typical output resulting from a request for configuration information:

DB2 GET ALERT CFG FOR DATABASES

```

        Alert Configuration
Indicator Name = db.db_op_status
    Default = Yes
    Type = State-based
    Sensitivity = 0
    Formula = db.db_status;
    Actions = Disabled
    Threshold or State checking = Enabled

Indicator Name = db.sort_shrmem_util
    Default = Yes
    Type = Threshold-based
    Warning = 70
    Alarm = 85
    Unit = %
    Sensitivity = 0
    Formula = ((db.sort_shrheap_allocated/sheapthres_shr)
        *100);
    Actions = Disabled
    Threshold or State checking = Enabled

Indicator Name = db.spilled_sorts
    Default = Yes
    Type = Threshold-based
    Warning = 30
    Alarm = 50
    Unit = %
    Sensitivity = 0
    Formula = ((delta(db.sort_overflows,10))/
        (delta(db.total_sorts,10)+1)*100);
    Actions = Disabled
    Threshold or State checking = Enabled

Indicator Name = db.max_sort_shrmem_util
    Default = Yes
    Type = Threshold-based
    Warning = 60
    Alarm = 30
    Unit = %
    Sensitivity = 0
    Formula = ((db.max_shr_sort_mem/
        sheapthres_shr)*100);
    Actions = Disabled
    Threshold or State checking = Enabled

Indicator Name = db.log_util

```

Default	= Yes
Type	= Threshold-based
Warning	= 75
Alarm	= 85
Unit	= %
Sensitivity	= 0
Formula	= (db.total_log_used/ (db.total_log_used+db.total_log_available)) *100;
Actions	= Disabled
Threshold or State checking	= Enabled
Indicator Name	= db.log_fs_util
Default	= Yes
Type	= Threshold-based
Warning	= 75
Alarm	= 85
Unit	= %
Sensitivity	= 0
Formula	= ((os.fs_used/os.fs_total)*100);
Actions	= Disabled
Threshold or State checking	= Enabled
Indicator Name	= db.deadlock_rate
Default	= Yes
Type	= Threshold-based
Warning	= 5
Alarm	= 10
Unit	= Deadlocks per hour
Sensitivity	= 0
Formula	= delta(db.deadlocks);
Actions	= Disabled
Threshold or State checking	= Enabled
Indicator Name	= db.locklist_util
Default	= Yes
Type	= Threshold-based
Warning	= 75
Alarm	= 85
Unit	= %
Sensitivity	= 0
Formula	= (db.lock_list_in_use/(locklist*4096)) *100;
Actions	= Disabled
Threshold or State checking	= Enabled
Indicator Name	= db.lock_escal_rate
Default	= Yes
Type	= Threshold-based
Warning	= 5
Alarm	= 10
Unit	= Lock escalations per hour
Sensitivity	= 0
Formula	= delta(db.lock_escal);
Actions	= Disabled
Threshold or State checking	= Enabled
Indicator Name	= db.apps_waiting_locks
Default	= Yes
Type	= Threshold-based
Warning	= 50
Alarm	= 70
Unit	= %
Sensitivity	= 0
Formula	= (db.locks_waiting/db.appls_cur_cons)*100;
Actions	= Disabled

```

Threshold or State checking = Enabled

Indicator Name = db.pkgcache_hitratio
Default = Yes
Type = Threshold-based
Warning = 80
Alarm = 70
Unit = %
Sensitivity = 0
Formula = (1-
           (db.pkg_cache_inserts/db.pkg_cache_lookups)
           )*100;
Actions = Disabled
Threshold or State checking = Disabled

Indicator Name = db.catcache_hitratio
Default = Yes
Type = Threshold-based
Warning = 80
Alarm = 70
Unit = %
Sensitivity = 0
Formula = (1-
           (db.cat_cache_inserts/db.cat_cache_lookups)
           )*100;
Actions = Disabled
Threshold or State checking = Disabled

Indicator Name = db.shrworkspace_hitratio
Default = Yes
Type = Threshold-based
Warning = 80
Alarm = 70
Unit = %
Sensitivity = 0
Formula = ((1-
           (db.shr_workspace_section_inserts/
            db.shr_workspace_section_lookups))
           *100);
Actions = Disabled
Threshold or State checking = Disabled

Indicator Name = db.db_heap_util
Default = Yes
Type = Threshold-based
Warning = 85
Alarm = 95
Unit = %
Sensitivity = 0
Formula = ((db.db_heap_cur_size/
            db.db_heap_max_size)*100);
Actions = Disabled
Threshold or State checking = Enabled

Indicator Name = db.tb_reorg_req
Default = Yes
Type = Collection state-based
Sensitivity = 0
Actions = Disabled
Threshold or State checking = Disabled

Indicator Name = db.hadr_op_status
Default = Yes
Type = State-based
Sensitivity = 0
Formula = db.hadr_connect_status;
Actions = Disabled

```

```

Threshold or State checking = Enabled

Indicator Name = db.hadr_delay
Default = Yes
Type = Threshold-based
Warning = 10
Alarm = 15
Unit = Minutes
Sensitivity = 0
Formula = (db.hadr_log_gap*var.refresh_rate/60)
          DIV(delta(db.hadr_secondary_log_pos));
Actions = Disabled
Threshold or State checking = Enabled

Indicator Name = db.db_backup_req
Default = Yes
Type = State-based
Sensitivity = 0
Actions = Disabled
Threshold or State checking = Disabled

Indicator Name = db.fed_nicknames_op_status
Default = Yes
Type = Collection state-based
Sensitivity = 0
Actions = Disabled
Threshold or State checking = Disabled

Indicator Name = db.fed_servers_op_status
Default = Yes
Type = Collection state-based
Sensitivity = 0
Actions = Disabled
Threshold or State checking = Disabled

Indicator Name = db.tb_runstats_req
Default = Yes
Type = Collection state-based
Sensitivity = 0
Actions = Disabled
Threshold or State checking = Disabled

```

Chapter 47. GET CLI CONFIGURATION

Lists the contents of the `db2cli.ini` file. This command can list the entire file, or a specified section.

The `db2cli.ini` file is used as the DB2 call level interface (CLI) configuration file. It contains various keywords and values that can be used to modify the behavior of the DB2 CLI and the applications using it. The file is divided into sections, each section corresponding to a database alias name.

Authorization

None

Required connection

None

Command syntax



Command parameters

AT GLOBAL LEVEL

Displays the default CLI configuration parameters in the LDAP directory. This parameter is only valid on Windows operating systems.

FOR SECTION *section-name*

Name of the section whose keywords are to be listed. If not specified, all sections are listed.

Examples

The following sample output represents the contents of a `db2cli.ini` file that has two sections:

```
[tstcli1x]
uid=userid
pwd=password
autocommit=0
TableType="'TABLE', 'VIEW', 'SYSTEM TABLE'"

[tstcli2x]
SchemaList="'OWNER1', 'OWNER2', 'CURRENT SQLID'"
```

Usage notes

The section name specified on this command is not case sensitive. For example, if the section name in the `db2cli.ini` file (delimited by square brackets) is in lowercase, and the section name specified on the command is in uppercase, the correct section will be listed.

The value of the PWD (password) keyword is never listed; instead, five asterisks (*****) are listed.

When LDAP (Lightweight Directory Access Protocol) is enabled, the CLI configuration parameters can be set at the user level, in addition to the machine level. The CLI configuration at the user level is maintained in the LDAP directory. If the specified section exists at the user level, the CLI configuration for that section at the user level is returned; otherwise, the CLI configuration at the machine level is returned.

The CLI configuration at the user level is maintained in the LDAP directory and cached on the local machine. When reading the CLI configuration at the user level, DB2 always reads from the cache. The cache is refreshed when:

- The user updates the CLI configuration.
- The user explicitly forces a refresh of the CLI configuration using the REFRESH LDAP command.

In an LDAP environment, users can configure a set of default CLI settings for a database catalogued in the LDAP directory. When an LDAP catalogued database is added as a Data Source Name (DSN), either by using the Configuration Assistant (CA) or the CLI/ODBC configuration utility, any default CLI settings, if they exist in the LDAP directory, will be configured for that DSN on the local machine. The AT GLOBAL LEVEL clause must be specified to display the default CLI settings.

Chapter 48. GET CONNECTION STATE

Displays the connection state. Possible states are:

- Connectable and connected
- Connectable and unconnected
- Unconnectable and connected
- Implicitly connectable (if implicit connect is available).

This command also returns information about:

- the database connection mode (SHARE or EXCLUSIVE)
- the alias and name of the database to which a connection exists (if one exists)
- the host name and service name of the connection if the connection is using TCP/IP

Authorization

None

Required connection

None

Command syntax

▶▶—GET CONNECTION STATE—◀◀

Command parameters

None

Examples

The following is sample output from GET CONNECTION STATE:

```
Database Connection State

Connection state      = Connectable and Connected
Connection mode      = SHARE
Local database alias = SAMPLE
Database name        = SAMPLE
Hostname              = montero
Service name          = 29384
```

Usage notes

This command does not apply to type 2 connections.

Chapter 49. GET CONTACTGROUP

Returns the contacts included in a single contact group that is defined on the local system. A contact is a user to whom the Scheduler and Health Monitor send messages. You create named groups of contacts with the ADD CONTACTGROUP command.

Authorization

None

Required connection

None. Local execution only: this command cannot be used with a remote connection.

Command syntax

▶▶ GET CONTACTGROUP *name* ◀◀

Command parameters

CONTACTGROUP *name*

The name of the group for which you would like to retrieve the contacts.

Examples

```
GET CONTACTGROUP support
```

```
Description
```

```
-----
```

```
Foo Widgets broadloom support unit
```

Name	Type
-----	-----
joe	contact
support	contact group
joline	contact

Chapter 50. GET CONTACTGROUPS

The command provides a list of contact groups, which can be either defined locally on the system or in a global list. A contact group is a list of addresses to which monitoring processes such as the Scheduler and Health Monitor can send messages. The setting of the Database Administration Server (DAS) **contact_host** configuration parameter determines whether the list is local or global. You create named groups of contacts with the ADD CONTACTGROUP command.

Authorization

None

Required Connection

None

Command Syntax

▶▶ GET CONTACTGROUPS ◀◀

Command Parameters

None

Examples

In the following example, the command GET CONTACTGROUPS is issued. The result is as follows:

Name	Description
support	Foo Widgets broadloom support unit
service	Foo Widgets service and support unit

Chapter 51. GET CONTACTS

Returns the list of contacts defined on the local system. Contacts are users to whom the monitoring processes such as the Scheduler and Health Monitor send notifications or messages.

To create a contact, use the ADD CONTACT command.

Authorization

None

Required connection

None

Command syntax

▶▶ GET CONTACTS ◀◀

Command parameters

None

Examples

GET CONTACTS

Name	Type	Address	Max Page Length	Description
joe	e-mail	joe@somewhere.com	-	-
joline	e-mail	joline@ somewhereelse.com	-	-
john	page	john@relay.org	50	Support 24x7

Chapter 52. GET DATABASE CONFIGURATION

Returns the values of individual entries in a specific database configuration file.

Scope

This command returns information only for the database partition on which it is executed.

Authorization

None

Required connection

Instance. An explicit attachment is not required, but a connection to the database is required when using the SHOW DETAIL clause. If the database is listed as remote, an instance attachment to the remote node is established for the duration of the command.

Command syntax

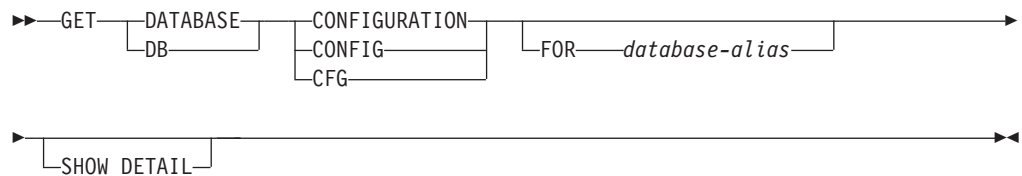

Command parameters

FOR *database-alias*

Specifies the alias of the database whose configuration is to be displayed. You do not need to specify the alias if a connection to the database already exists.

SHOW DETAIL

Displays detailed information showing the current value of database configuration parameters as well as the value of the parameters the next time you activate the database. This option lets you see the result of dynamic changes to configuration parameters.

This is a default clause when operating in the CLPPlus interface. SHOW DETAIL need not be called when using CLPPlus processor.

Examples

Note:

1. Output on different platforms might show small variations reflecting platform-specific parameters.
2. Parameters with keywords enclosed by parentheses can be changed by the UPDATE DATABASE CONFIGURATION command.

- Fields that do not contain keywords are maintained by the database manager and cannot be updated.

The following is sample output from GET DATABASE CONFIGURATION (issued on Windows):

Database Configuration for Database

```

Database configuration release level          = 0x0c00
Database release level                      = 0x0c00

Database territory                          = US
Database code page                          = 1252
Database code set                           = IBM-1252
Database country/region code                = 1
Database collating sequence                 = UNIQUE
Alternate collating sequence                (ALT_COLLATE) =
Database page size                          = 8192

Dynamic SQL Query management                (DYN_QUERY_MGMT) = DISABLE

Discovery support for this database          (DISCOVER_DB) = ENABLE

Restrict access                             = NO
Default query optimization class            (DFT_QUERYOPT) = 5
Degree of parallelism                       (DFT_DEGREE) = 1
Continue upon arithmetic exceptions         (DFT_SQLMATHWARN) = NO
Default refresh age                         (DFT_REFRESH_AGE) = 0
Default maintained table types for opt     (DFT_MTTB_TYPES) = SYSTEM
Number of frequent values retained         (NUM_FREQVALUES) = 10
Number of quantiles retained               (NUM_QUANTILES) = 20

Decimal floating point rounding mode        (DECFLT_ROUNDING) = ROUND_HALF_EVEN

Backup pending                             = NO

All committed transactions have been written to disk = YES|NO
Rollforward pending                         = NO
Restore pending                             = NO

Multi-page file allocation enabled          = YES

Log retain for recovery status              = NO
User exit for logging status                = NO

Self tuning memory                         (SELF_TUNING_MEM) = OFF
Size of database shared memory (4KB)       (DATABASE_MEMORY) = AUTOMATIC
Database memory threshold                  (DB_MEM_THRESH) = 10
Max storage for lock list (4KB)            (LOCKLIST) = 50
Percent. of lock lists per application     (MAXLOCKS) = 22
Package cache size (4KB)                   (PCKCACHESZ) = (MAXAPPLS*8)
Sort heap thres for shared sorts (4KB)     (SHEAPTHRES_SHR) = 5000
Sort list heap (4KB)                       (SORTHEAP) = 256

Database heap (4KB)                        (DBHEAP) = AUTOMATIC
Catalog cache size (4KB)                   (CATALOGCACHE_SZ) = (MAXAPPLS*4)
Log buffer size (4KB)                       (LOGBUFFSZ) = 8
Utilities heap size (4KB)                   (UTIL_HEAP_SZ) = 5000
Buffer pool size (pages)                    (BUFFPAGE) = 250
SQL statement heap (4KB)                    (STMHEAP) = AUTOMATIC
Default application heap (4KB)              (APPLHEAPSZ) = AUTOMATIC
Application Memory Size (4KB)               (APPL_MEMORY) = AUTOMATIC
Statistics heap size (4KB)                  (STAT_HEAP_SZ) = AUTOMATIC

Interval for checking deadlock (ms)         (DLCHKTIME) = 10000
Lock timeout (sec)                          (LOCKTIMEOUT) = -1

```

```

Changed pages threshold          (CHNGPGS_THRESH) = 60
Number of asynchronous page cleaners (NUM_IOCLEANERS) = AUTOMATIC
Number of I/O servers           (NUM_IOSERVERS) = AUTOMATIC
Index sort flag                 (INDEXSORT) = YES
Sequential detect flag          (SEQDETECT) = YES
Default prefetch size (pages)   (DFT_PREFETCH_SZ) = AUTOMATIC

Track modified pages            (TRACKMOD) = OFF

Default number of containers    = 1
Default tablespace extentsize (pages) (DFT_EXTENT_SZ) = 32

Max number of active applications (MAXAPPLS) = AUTOMATIC
Average number of active applications (AVG_APPLS) = AUTOMATIC
Max DB files open per application (MAXFILOP) = 32768

Log file size (4KB)            (LOGFILSIZ) = 1000
Number of primary log files     (LOGPRIMARY) = 3
Number of secondary log files   (LOGSECOND) = 2
Changed path to log files       (NEWLOGPATH) =
Path to log files                = D:\DB2\NODE0000\SQL00001\SQLLOGDIR\
Overflow log path               (OVERFLOWLOGPATH) =
Mirror log path                 (MIRRORLOGPATH) =
First active log file           =
Block log on disk full          (BLK_LOG_DSK_FUL) = NO
Percent max primary log space by transaction (MAX_LOG) = 0
Num. of active log files for 1 active UOW (NUM_LOG_SPAN) = 0

Group commit count              (MINCOMMIT) = 1
Percent log file reclaimed before soft ckcpt (SOFTMAX) = 100
Log retain for recovery enabled (LOGRETAIN) = OFF
User exit for logging enabled    (USEREXIT) = OFF

HADR database role              = STANDARD
HADR local host name            (HADR_LOCAL_HOST) =
HADR local service name         (HADR_LOCAL_SVC) =
HADR remote host name          (HADR_REMOTE_HOST) =
HADR remote service name       (HADR_REMOTE_SVC) =
HADR instance name of remote server (HADR_REMOTE_INST) =
HADR timeout value              (HADR_TIMEOUT) = 120
HADR log write synchronization mode (HADR_SYNCMODE) = NEARSYNC
HADR peer window duration (seconds) (HADR_PEER_WINDOW) = 0

First log archive method        (LOGARCHMETH1) = OFF
Options for logarchmeth1        (LOGARCHOPT1) =
Second log archive method       (LOGARCHMETH2) = OFF
Options for logarchmeth2        (LOGARCHOPT2) =
Failover log archive path        (FAILARCHPATH) =
Number of log archive retries on error (NUMARCHRETRY) = 5
Log archive retry Delay (secs)   (ARCHRETRYDELAY) = 20
Vendor options                   (VENDOROPT) =

Auto restart enabled            (AUTORESTART) = ON
Index re-creation time and redo index build (INDEXREC) = SYSTEM (RESTART)
Log pages during index build     (LOGINDEXBUILD) = OFF
Default number of loadrec sessions (DFT_LOADREC_SES) = 1
Number of database backups to retain (NUM_DB_BACKUPS) = 12
Recovery history retention (days) (REC_HIS_RETENTN) = 366
Auto deletion of recovery objects (AUTO_DEL_REC_OBJ) = OFF

TSM management class            (TSM_MGMTCLASS) =
TSM node name                   (TSM_NODENAME) =
TSM owner                       (TSM_OWNER) =
TSM password                    (TSM_PASSWORD) =

Automatic maintenance           (AUTO_MAINT) = ON
Automatic database backup        (AUTO_DB_BACKUP) = OFF

```

```

Automatic table maintenance      (AUTO_TBL_MAINT) = ON
Automatic runstats              (AUTO_RUNSTATS) = ON
Automatic statistics profiling   (AUTO_STATS_PROF) = OFF
Automatic profile updates       (AUTO_PROF_UPD) = OFF
Automatic reorganization        (AUTO_REORG) = OFF

Auto-Revalidation               (AUTO_REVAL) = DISABLED
Currently Committed             (CUR_COMMIT) = ON
CHAR output with DECIMAL input  (DEC_TO_CHAR_FMT) = NEW
Enable XML Character operations  (ENABLE_XMLCHAR) = YES
WLM Collection Interval         (WLM_COLLECT_INT) = 0

```

The following example shows a portion of the output of the command when you specify the SHOW DETAIL option. The value in the Delayed Value column is the value that will be applied the next time you start the instance.

Database Configuration for Database

Description	Parameter	Current Value	Delayed Value
Database configuration release level		= 0x0c00	
Database release level		= 0x0c00	
Database territory		= US	
Database code page		= 1252	
Database code set		= IBM-1252	
Database country/region code		= 1	
Database collating sequence		= UNIQUE	UNIQUE
Alternate collating sequence	(ALT_COLLATE)	=	
Database page size		= 8192	8192
Dynamic SQL Query management	(DYN_QUERY_MGMT)	= DISABLE	DISABLE
Discovery support for this database	(DISCOVER_DB)	= ENABLE	ENABLE
Restrict access		= NO	
Default query optimization class	(DFT_QUERYOPT)	= 5	5
Degree of parallelism	(DFT_DEGREE)	= 1	1
Continue upon arithmetic exceptions	(DFT_SQLMATHWARN)	= NO	NO
Default refresh age	(DFT_REFRESH_AGE)	= 0	0
Default maintained table types for opt	(DFT_MTTB_TYPES)	= SYSTEM	SYSTEM
Number of frequent values retained	(NUM_FREQVALUES)	= 10	10
Number of quantiles retained	(NUM_QUANTILES)	= 20	20
Decimal floating point rounding mode	(DECFLT_ROUNDING)	= ROUND_HALF_EVEN	ROUND_HALF_EVEN
Backup pending		= NO	
Database is consistent		= NO	
Rollforward pending		= NO	
Restore pending		= NO	
Multi-page file allocation enabled		= YES	
Log retain for recovery status		= NO	
User exit for logging status		= NO	
Self tuning memory	(SELF_TUNING_MEM)	= OFF	OFF
Size of database shared memory (4KB)	(DATABASE_MEMORY)	= AUTOMATIC(18096)	AUTOMATIC(18096)
Database memory threshold	(DB_MEM_THRES)	= 10	10
Max storage for lock list (4KB)	(LOCKLIST)	= 50	50
Percent. of lock lists per application	(MAXLOCKS)	= 22	22
Package cache size (4KB)	(PCKCACHESZ)	= (MAXAPPLS*8)	(MAXAPPLS*8)
Sort heap thres for shared sorts (4KB)	(SHEAPTHRES_SHR)	= 5000	5000
Sort list heap (4KB)	(SORTHEAP)	= 256	256
Database heap (4KB)	(DBHEAP)	= AUTOMATIC(600)	AUTOMATIC(600)

Catalog cache size (4KB)	(CATALOGCACHE_SZ) = (MAXAPPLS*4)	(MAXAPPLS*4)
Log buffer size (4KB)	(LOGBUFFSZ) = 8	8
Utilities heap size (4KB)	(UTIL_HEAP_SZ) = 5000	5000
Buffer pool size (pages)	(BUFFPAGE) = 250	250
SQL statement heap (4KB)	(STMTHEAP) = AUTOMATIC(2048)	AUTOMATIC(2048)
Default application heap (4KB)	(APPLHEAPSZ) = AUTOMATIC(256)	AUTOMATIC(256)
Application Memory Size (4KB)	(APPL_MEMORY) = AUTOMATIC(496)	AUTOMATIC(10000)
Statistics heap size (4KB)	(STAT_HEAP_SZ) = AUTOMATIC(4384)	AUTOMATIC(4384)
Interval for checking deadlock (ms)	(DLCHKTIME) = 10000	10000
Lock timeout (sec)	(LOCKTIMEOUT) = -1	-1
Changed pages threshold	(CHNGPGS_THRESH) = 60	60
Number of asynchronous page cleaners	(NUM_IOCLEANERS) = AUTOMATIC(1)	AUTOMATIC(1)
Number of I/O servers	(NUM_IOSERVERS) = AUTOMATIC(3)	AUTOMATIC(3)
Index sort flag	(INDEXSORT) = YES	YES
Sequential detect flag	(SEQDETECT) = YES	YES
Default prefetch size (pages)	(DFT_PREFETCH_SZ) = AUTOMATIC	AUTOMATIC
Track modified pages	(TRACKMOD) = NO	NO
Default number of containers	= 1	1
Default tablespace extentsize (pages)	(DFT_EXTENT_SZ) = 32	32
Max number of active applications	(MAXAPPLS) = AUTOMATIC(40)	AUTOMATIC(40)
Average number of active applications	(AVG_APPLS) = AUTOMATIC(1)	AUTOMATIC(1)
Max DB files open per application	(MAXFILOP) = 32768	32768
Log file size (4KB)	(LOGFILSIZ) = 1000	1000
Number of primary log files	(LOGPRIMARY) = 3	3
Number of secondary log files	(LOGSECOND) = 2	2
Changed path to log files	(NEWLOGPATH) =	
Path to log files	= D:\DB2\NODE0000	D:\DB2\NODE0000
	\SQL00001\SQLLOGDIR\	\SQL00001\SQLLOGDIR\
Overflow log path	(OVERFLOWLOGPATH) =	
Mirror log path	(MIRRORLOGPATH) =	
First active log file	=	
Block log on disk full	(BLK_LOG_DSK_FUL) = NO	NO
Percent max primary log space by transaction	(MAX_LOG) = 0	0
Num. of active log files for 1 active UOW	(NUM_LOG_SPAN) = 0	0
Group commit count	(MINCOMMIT) = 1	1
Percent log file reclaimed before soft ckcpt	(SOFTMAX) = 100	100
Log retain for recovery enabled	(LOGRETAIN) = OFF	OFF
User exit for logging enabled	(USEREXIT) = OFF	OFF
HADR database role	= STANDARD	STANDARD
HADR local host name	(HADR_LOCAL_HOST) =	
HADR local service name	(HADR_LOCAL_SVC) =	
HADR remote host name	(HADR_REMOTE_HOST) =	
HADR remote service name	(HADR_REMOTE_SVC) =	
HADR instance name of remote server	(HADR_REMOTE_INST) =	
HADR timeout value	(HADR_TIMEOUT) = 120	120
HADR log write synchronization mode	(HADR_SYNCMODE) = NEARSYNC	NEARSYNC
HADR peer window duration (seconds)	(HADR_PEER_WINDOW) = 0	0
First log archive method	(LOGARCHMETH1) = OFF	OFF
Options for logarchmeth1	(LOGARCHOPT1) =	
Second log archive method	(LOGARCHMETH2) = OFF	OFF
Options for logarchmeth2	(LOGARCHOPT2) =	
Failover log archive path	(FAILARCHPATH) =	
Number of log archive retries on error	(NUMARCHRETRY) = 5	5
Log archive retry Delay (secs)	(ARCHRETRYDELAY) = 20	20
Vendor options	(VENDOROPT) =	
Auto restart enabled	(AUTORESTART) = ON	ON
Index re-creation time and redo index build	(INDEXREC) = SYSTEM	SYSTEM (RESTART)
Log pages during index build	(LOGINDEXBUILD) = OFF	OFF

Default number of loadrec sessions	(DFT_LOADREC_SES) = 1	1
Number of database backups to retain	(NUM_DB_BACKUPS) = 12	12
Recovery history retention (days)	(REC_HIS_RETENTN) = 366	366
Auto deletion of recovery objects	(AUTO_DEL_REC_OBJ) = OFF	OFF
TSM management class	(TSM_MGMTCLASS) =	
TSM node name	(TSM_NODENAME) =	
TSM owner	(TSM_OWNER) =	
TSM password	(TSM_PASSWORD) =	
Automatic maintenance	(AUTO_MAINT) = ON	ON
Automatic database backup	(AUTO_DB_BACKUP) = OFF	OFF
Automatic table maintenance	(AUTO_TBL_MAINT) = ON	ON
Automatic runstats	(AUTO_RUNSTATS) = ON	ON
Automatic statistics profiling	(AUTO_STATS_PROF) = OFF	OFF
Automatic profile updates	(AUTO_PROF_UPD) = OFF	OFF
Automatic reorganization	(AUTO_REORG) = OFF	OFF
Auto-Revalidation	(AUTO_REVAL) = DISABLED	DISABLED
Currently Committed	(CUR_COMMIT) = ON	ON
CHAR output with DECIMAL input	(DEC_TO_CHAR_FMT) = NEW	NEW
Enable XML Character operations	(ENABLE_XMLCHAR) = ON	ON
WLM Collection Interval	(WLM_COLLECT_INT) = 0	0

Usage notes

If an error occurs, the information returned is not valid. If the configuration file is invalid, an error message is returned. The database must be restored from a backup version.

To set the database configuration parameters to the database manager defaults, use the RESET DATABASE CONFIGURATION command.

To retrieve information from all database partitions, use the SYSIBMADM.DBCFG administrative view.

Chapter 53. GET DATABASE MANAGER CONFIGURATION

Returns the values of individual entries in the database manager configuration file.

Authorization

None

Required connection

None or instance. An instance attachment is not required to perform local DBM configuration operations, but is required to perform remote DBM configuration operations. To display the database manager configuration for a remote instance, it is necessary to first attach to that instance. The SHOW DETAIL clause requires an instance attachment.

Command syntax

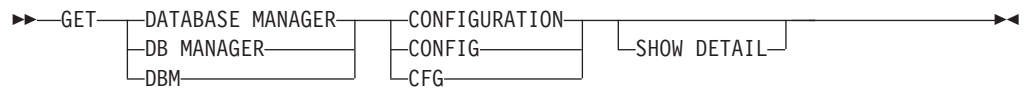

Command parameters

SHOW DETAIL

Displays detailed information showing the current value of database manager configuration parameters as well as the value of the parameters the next time you start the database manager. This option lets you see the result of dynamic changes to configuration parameters.

This is a default clause when operating in the CLPPlus interface. SHOW DETAIL need not be called when using CLPPlus processor.

Examples

Both node type and platform determine which configuration parameters are listed.

The following is sample output from GET DATABASE MANAGER CONFIGURATION (issued on Windows):

```

Database Manager Configuration

Node type = Enterprise Server Edition with local and remote clients

Database manager configuration release level          = 0x0c00

Maximum total of files open              (MAXTOTFILOP) = 16000
CPU speed (millisec/instruction)         (CPUSPEED)    = 4.251098e-007
Communications bandwidth (MB/sec)        (COMM_BANDWIDTH) = 1.0000000e+002

Max number of concurrently active databases (NUMDB)    = 8
Federated Database System Support         (FEDERATED)   = NO
Transaction processor monitor name        (TP_MON_NAME) =

Default charge-back account              (DFT_ACCOUNT_STR) =

Java Development Kit installation path     (JDK_PATH)    =
```

```

Diagnostic error capture level          (DIAGLEVEL) = 3
Notify Level                           (NOTIFYLEVEL) = 3
Diagnostic data directory path          (DIAGPATH) =

Default database monitor switches
  Buffer pool                           (DFT_MON_BUFPOOL) = OFF
  Lock                                 (DFT_MON_LOCK) = OFF
  Sort                                 (DFT_MON_SORT) = OFF
  Statement                            (DFT_MON_STMT) = OFF
  Table                                (DFT_MON_TABLE) = OFF
  Timestamp                            (DFT_MON_TIMESTAMP) = ON
  Unit of work                          (DFT_MON_UOW) = OFF
Monitor health of instance and databases (HEALTH_MON) = ON

SYSADM group name                      (SYSADM_GROUP) =
SYSCTRL group name                    (SYSCTRL_GROUP) =
SYSMAINT group name                   (SYSMAINT_GROUP) =
SYSMON group name                     (SYSMON_GROUP) =

Client Userid-Password Plugin          (CLNT_PW_PLUGIN) =
Client Kerberos Plugin                 (CLNT_KRB_PLUGIN) = IBMkrb5
Group Plugin                           (GROUP_PLUGIN) =
GSS Plugin for Local Authorization     (LOCAL_GSSPLUGIN) =
Server Plugin Mode                     (SRV_PLUGIN_MODE) = UNFENCED
Server List of GSS Plugins             (SRVCON_GSSPLUGIN_LIST) =
Server Userid-Password Plugin         (SRVCON_PW_PLUGIN) =
Server Connection Authentication       (SRVCON_AUTH) = NOT_SPECIFIED
Cluster manager                       (CLUSTER_MGR) =

Database manager authentication        (AUTHENTICATION) = SERVER
Cataloging allowed without authority   (CATALOG_NOAUTH) = NO
Trust all clients                      (TRUST_ALLCLNTS) = YES
Trusted client authentication         (TRUST_CLNTAUTH) = CLIENT
Bypass federated authentication       (FED_NOAUTH) = NO

Default database path                  (DFTDBPATH) = C:

Database monitor heap size (4KB)       (MON_HEAP_SZ) = AUTOMATIC
Java Virtual Machine heap size (4KB)   (JAVA_HEAP_SZ) = 2048
Audit buffer size (4KB)                (AUDIT_BUF_SZ) = 0
Size of instance shared memory (4KB)   (INSTANCE_MEMORY) = AUTOMATIC
Backup buffer default size (4KB)       (BACKBUFSZ) = 1024
Restore buffer default size (4KB)      (RESTBUFSZ) = 1024

Agent stack size                       (AGENT_STACK_SZ) = 16
Minimum committed private memory (4KB) (MIN_PRIV_MEM) = 32
Private memory threshold (4KB)         (PRIV_MEM_THRESH) = 20000

Sort heap threshold (4KB)              (SHEAPTHRES) = 0

Directory cache support                 (DIR_CACHE) = YES

Application support layer heap size (4KB) (ASLHEAPSZ) = 15
Max requester I/O block size (bytes)   (RQRIOBLK) = 32767
Query heap size (4KB)                  (QUERY_HEAP_SZ) = 1000

Workload impact by throttled utilities (UTIL_IMPACT_LIM) = 10

Priority of agents                      (AGENTPRI) = SYSTEM
Agent pool size                        (NUM_POOLAGENTS) = AUTOMATIC
Initial number of agents in pool       (NUM_INITAGENTS) = 0
Max number of coordinating agents      (MAX_COORDAGENTS) = AUTOMATIC
Max number of client connections       (MAX_CONNECTIONS) = AUTOMATIC

Keep fenced process                    (KEEPFENCED) = YES
Number of pooled fenced processes       (FENCED_POOL) = AUTOMATIC

```



```

Initial number of fenced processes      (NUM_INITFENCED) = 0

Index re-creation time and redo index build (INDEXREC) = RESTART

Transaction manager database name      (TM_DATABASE) = 1ST_CONN
Transaction resync interval (sec)      (RESYNC_INTERVAL) = 180

SPM name                               (SPM_NAME) = KEON14
SPM log size                           (SPM_LOG_FILE_SZ) = 256
SPM resync agent limit                 (SPM_MAX_RESYNC) = 20
SPM log path                           (SPM_LOG_PATH) =

NetBIOS Workstation name               (NNAME) =

TCP/IP Service name                   (SVCENAME) = db2c_DB2
Discovery mode                        (DISCOVER) = SEARCH
Discover server instance               (DISCOVER_INST) = ENABLE

Maximum query degree of parallelism    (MAX_QUERYDEGREE) = ANY
Enable intra-partition parallelism     (INTRA_PARALLEL) = NO

Maximum Asynchronous TQs per query    (FEDERATED_ASYNC) = 0

No. of int. communication buffers(4KB) (FCM_NUM_BUFFERS) = AUTOMATIC
No. of int. communication channels     (FCM_NUM_CHANNELS) = AUTOMATIC
Node connection elapse time (sec)      (CONN_ELAPSE) = 10
Max number of node connection retries  (MAX_CONNRETRIES) = 5
Max time difference between nodes (min) (MAX_TIME_DIFF) = 60

db2start/db2stop timeout (min)        (START_STOP_TIME) = 10

```

The following output sample shows the information displayed when you specify the SHOW DETAIL option. The value that appears in the Delayed Value column is the value that will be in effect the next time you start the database manager instance.

```
db2 => get dbm cfg show detail
```

Database Manager Configuration

Node type = Enterprise Server Edition with local and remote clients

Description	Parameter	Current Value	Delayed Value

Database manager configuration release level		= 0x0c00	
Maximum total of files open	(MAXTOTFILOP)	= 16000	16000
CPU speed (millisec/instruction)	(CPUSPEED)	= 4.251098e-007	4.251098e-007
Communications bandwidth (MB/sec)	(COMM_BANDWIDTH)	= 1.000000e+002	1.000000e+002
Max number of concurrently active databases	(NUMDB)	= 8	8
Federated Database System Support	(FEDERATED)	= NO	NO
Transaction processor monitor name	(TP_MON_NAME)	=	
Default charge-back account	(DFT_ACCOUNT_STR)	=	
Java Development Kit installation path	(JDK_PATH)	=	
Diagnostic error capture level	(DIAGLEVEL)	= 3	3
Notify Level	(NOTIFYLEVEL)	= 3	3
Diagnostic data directory path	(DIAGPATH)	=	
Default database monitor switches			
Buffer pool	(DFT_MON_BUFPOOL)	= OFF	OFF
Lock	(DFT_MON_LOCK)	= OFF	OFF
Sort	(DFT_MON_SORT)	= OFF	OFF
Statement	(DFT_MON_STMT)	= OFF	OFF

Table	(DFT_MON_TABLE) = OFF	OFF
Timestamp	(DFT_MON_TIMESTAMP) = ON	ON
Unit of work	(DFT_MON_UOW) = OFF	OFF
Monitor health of instance and databases	(HEALTH_MON) = ON	ON
SYSADM group name	(SYSADM_GROUP) =	
SYSCTRL group name	(SYSCTRL_GROUP) =	
SYSMAINT group name	(SYSMAINT_GROUP) =	
SYSMON group name	(SYSMON_GROUP) =	
Client Userid-Password Plugin	(CLNT_PW_PLUGIN) =	
Client Kerberos Plugin	(CLNT_KRB_PLUGIN) = IBMkrb5	IBMkrb5
Group Plugin	(GROUP_PLUGIN) =	
GSS Plugin for Local Authorization	(LOCAL_GSSPLUGIN) =	
Server Plugin Mode	(SRV_PLUGIN_MODE) = UNFENCED	UNFENCED
Server List of GSS Plugins	(SRVCON_GSSPLUGIN_LIST) =	
Server Userid-Password Plugin	(SRVCON_PW_PLUGIN) =	
Server Connection Authentication	(SRVCON_AUTH) = NOT_SPECIFIED	NOT_SPECIFIED
Cluster manager	(CLUSTER_MGR) =	
Database manager authentication	(AUTHENTICATION) = SERVER	SERVER
Cataloging allowed without authority	(CATALOG_NOAUTH) = NO	NO
Trust all clients	(TRUST_ALLCLNTS) = YES	YES
Trusted client authentication	(TRUST_CLNTAUTH) = CLIENT	CLIENT
Bypass federated authentication	(FED_NOAUTH) = NO	NO
Default database path	(DFTDBPATH) = C:	C:
Database monitor heap size (4KB)	(MON_HEAP_SZ) = AUTOMATIC(66)	AUTOMATIC(66)
Java Virtual Machine heap size (4KB)	(JAVA_HEAP_SZ) = 2048	2048
Audit buffer size (4KB)	(AUDIT_BUF_SZ) = 0	0
Size of instance shared memory (4KB)	(INSTANCE_MEMORY) = AUTOMATIC(73728)	AUTOMATIC(73728)
Backup buffer default size (4KB)	(BACKBUFSZ) = 1024	1024
Restore buffer default size (4KB)	(RESTBUFSZ) = 1024	1024
Agent stack size	(AGENT_STACK_SZ) = 16	16
Sort heap threshold (4KB)	(SHEAPTHRES) = 0	0
Directory cache support	(DIR_CACHE) = YES	YES
Application support layer heap size (4KB)	(ASLHEAPSZ) = 15	15
Max requester I/O block size (bytes)	(RQRIOBLK) = 32767	32767
Query heap size (4KB)	(QUERY_HEAP_SZ) = 1000	1000
Workload impact by throttled utilities	(UTIL_IMPACT_LIM) = 10	10
Priority of agents	(AGENTPRI) = SYSTEM	SYSTEM
Agent pool size	(NUM_POOLAGENTS) = AUTOMATIC(100)	AUTOMATIC(100)
Initial number of agents in pool	(NUM_INITAGENTS) = 0	0
Max number of coordinating agents	(MAX_COORDAGENTS) = AUTOMATIC(200)	AUTOMATIC(200)
Max number of client connections	(MAX_CONNECTIONS) = AUTOMATIC(MAX_COORDAGENTS)	AUTOMATIC(MAX_COORDAGENTS)
Keep fenced process	(KEEPFENCED) = YES	YES
Number of pooled fenced processes	(FENCED_POOL) = AUTOMATIC(MAX_COORDAGENTS)	AUTOMATIC(MAX_COORDAGENTS)
Initial number of fenced processes	(NUM_INITFENCED) = 0	0
Index re-creation time and redo index build	(INDEXREC) = RESTART	RESTART

Transaction manager database name	(TM_DATABASE) = 1ST_CONN	1ST_CONN
Transaction resync interval (sec)	(RESYNC_INTERVAL) = 180	180
SPM name	(SPM_NAME) = KEON14	KEON14
SPM log size	(SPM_LOG_FILE_SZ) = 256	256
SPM resync agent limit	(SPM_MAX_RESYNC) = 20	20
SPM log path	(SPM_LOG_PATH) =	
NetBIOS Workstation name	(NNAME) =	
TCP/IP Service name	(SVCENAME) = db2c_DB2	db2c_DB2
Discovery mode	(DISCOVER) = SEARCH	SEARCH
Discover server instance	(DISCOVER_INST) = ENABLE	ENABLE
Maximum query degree of parallelism	(MAX_QUERYDEGREE) = ANY	ANY
Enable intra-partition parallelism	(INTRA_PARALLEL) = NO	NO
Maximum Asynchronous TQs per query	(FEDERATED_ASYNC) = 0	0
No. of int. communication buffers(4KB)	(FCM_NUM_BUFFERS) = AUTOMATIC(4096)	AUTOMATIC(4096)
No. of int. communication channels	(FCM_NUM_CHANNELS) = AUTOMATIC(2048)	AUTOMATIC(2048)
Node connection elapse time (sec)	(CONN_ELAPSE) = 10	10
Max number of node connection retries	(MAX_CONNRETRIES) = 5	5
Max time difference between nodes (min)	(MAX_TIME_DIFF) = 60	60
db2start/db2stop timeout (min)	(START_STOP_TIME) = 10	10

Usage notes

- If an attachment to a remote instance or a different local instance exists, the database manager configuration parameters for the attached server are returned; otherwise, the local database manager configuration parameters are returned.
- If an error occurs, the information returned is invalid. If the configuration file is invalid, an error message is returned. The user must drop and recreate the instance to recover.
- To set the configuration parameters to the default values shipped with the database manager, use the RESET DATABASE MANAGER CONFIGURATION command.
- The AUTOMATIC values indicated on GET DATABASE MANAGER CONFIGURATION SHOW DETAIL for FCM_NUM_BUFFERS and FCM_NUM_CHANNELS are the initial values at instance startup time and do not reflect any automatic increasing/decreasing that might have occurred during runtime.
- Configuration parameters **max_connections**, **max_coordagents** and **num_poolagents** are set to AUTOMATIC.
- Configuration parameters **maxagents** and **maxcagents** are deprecated. The following deprecated functions are the result:
 - CLP and the db2CfgSet API will tolerate updates to these parameters, however these updates will be ignored by DB2.
 - CLP will no longer display these database configuration parameters when the client and server are on the DB2 v9.5 code base. If the server is DB2 v9.5, earlier version clients will see a value of 0 output for these parameters. If the client is DB2 v9.5, but the server is prior to DB2 v9.5, these parameters will be displayed with the assigned values.
 - db2CfgGet API will tolerate requests for SQLF_KTN_MAXAGENTS and SQLF_KTN_MAXCAGENTS, but they will return 0 if the server is DB2 v9.5.
 - The behavior of the db2AutoConfig API will depend on the db2VersionNumber passed in to the API. If the version is DB2 v9.5 or beyond, **maxagents** will not be returned, but for versions prior to this it will.

- The AUTOCONFIGURE CLP command will display a value for **maxagents** with requests from an earlier version client (current and recommended value of 0). For current version client requests, **maxagents** will be displayed with an appropriate value.
- The AUTOCONFIGURE ADMIN_CMD will not return information about **maxagents** when the server is DB2 v9.5 and beyond.
- Updates to **maxagents** or **maxcagents** through the ADMIN_CMD will return successfully but have no effect on the server if the server is DB2 v9.5 or later.
- Queries of database manager configuration parameters using the DBMCFG administrative view will not return rows for **maxagents** or **maxcagents** if the server is DB2 v9.5 or beyond.

In a future release, these configuration parameters may be removed completely.

Chapter 54. GET DATABASE MANAGER MONITOR SWITCHES

Displays the status of the database system monitor switches. Monitor switches instruct the database system manager to collect database activity information. Each application using the database system monitor interface has its own set of monitor switches. A database manager-level switch is on when any of the monitoring applications has turned it on. This command is used to determine if the database system monitor is currently collecting data for any monitoring application.

Authorization

One of the following:

- *sysadm*
- *sysctrl*
- *sysmaint*
- *sysmon*

Required connection

Instance or database:

- If there is neither an attachment to an instance, nor a connection to a database, a default instance attachment is created.
- If there is both an attachment to an instance, and a database connection, the instance attachment is used.

To display the settings for a remote instance, or for a different local instance, it is necessary to first attach to that instance.

Command syntax

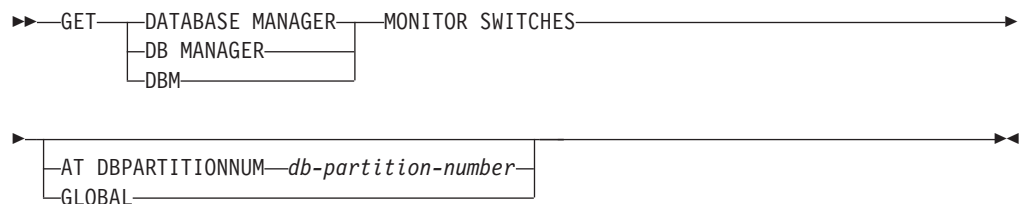

Command parameters

AT DBPARTITIONNUM *db-partition-number*

Specifies the database partition for which the status of the database manager monitor switches is to be displayed.

GLOBAL

Returns an aggregate result for all database partitions in a partitioned database environment.

Examples

The following is sample output from GET DATABASE MANAGER MONITOR SWITCHES:

DBM System Monitor Information Collected

Switch list for db partition number 1

```
Buffer Pool Activity Information (BUFFERPOOL) = ON    06-11-2003 10:11:01.738377
Lock Information                 (LOCK) = OFF
Sorting Information              (SORT) = ON    06-11-2003 10:11:01.738400
SQL Statement Information        (STATEMENT) = OFF
Table Activity Information       (TABLE) = OFF
Take Timestamp Information       (TIMESTAMP) = ON    06-11-2003 10:11:01.738525
Unit of Work Information         (UOW) = ON    06-11-2003 10:11:01.738353
```

Usage notes

The recording switches BUFFERPOOL, LOCK, SORT, STATEMENT, TABLE, and UOW are off by default, but can be switched on using the UPDATE MONITOR SWITCHES command. If any of these switches are on, this command also displays the time stamp for when the switch was turned on.

The recording switch TIMESTAMP is on by default, but can be switched off using UPDATE MONITOR SWITCHES. When this switch is on the system issues timestamp calls when collecting information for timestamp monitor elements. Examples of these elements are:

- agent_sys_cpu_time
- agent_usr_cpu_time
- appl_con_time
- con_elapsed_time
- con_response_time
- conn_complete_time
- db_conn_time
- elapsed_exec_time
- gw_comm_error_time
- gw_con_time
- gw_exec_time
- host_response_time
- last_backup
- last_reset
- lock_wait_start_time
- network_time_bottom
- network_time_top
- prev_uow_stop_time
- rf_timestamp
- ss_sys_cpu_time
- ss_usr_cpu_time
- status_change_time
- stmt_elapsed_time
- stmt_start
- stmt_stop
- stmt_sys_cpu_time
- stmt_usr_cpu_time
- uow_elapsed_time

- uow_start_time
- uow_stop_time

If the `TIMESTAMP` switch is off, timestamp operating system calls are not issued to determine these elements and these elements will contain zero. Turning this switch off becomes important as CPU utilization approaches 100%; when this occurs, the CPU time required for issuing timestamps increases dramatically.

Compatibilities

For compatibility with versions earlier than Version 8:

- The keyword `NODE` can be substituted for `DBPARTITIONNUM`.

Chapter 55. GET DESCRIPTION FOR HEALTH INDICATOR

Returns a description for the specified health indicator. A Health Indicator measures the healthiness of a particular state, capacity, or behavior of the database system. The state defines whether or not the database object or resource is operating normally.

Authorization

None

Required connection

Instance. If there is no instance attachment, a default instance attachment is created.

To obtain a snapshot of a remote instance, it is necessary to first attach to that instance.

Command syntax

```
▶▶—GET DESCRIPTION FOR HEALTH INDICATOR—shortname————▶▶
```

Command parameters

HEALTH INDICATOR *shortname*

The name of the health indicator for which you would like to retrieve the description. Health indicator names consist of a two- or three-letter object identifier followed by a name which describes what the indicator measures. For example:

```
db.sort_privmem_util
```

Examples

The following is sample output from the GET DESCRIPTION FOR HEALTH INDICATOR command.

```
GET DESCRIPTION FOR HEALTH INDICATOR db2.sort_privmem_util
```

```
DESCRIPTION FOR db2.sort_privmem_util
```

Sorting is considered healthy if there is sufficient heap space in which to perform sorting and sorts do not overflow unnecessarily. This indicator tracks the utilization of the private sort memory. If `db2.sort_heap_allocated` (system monitor data element) \geq `SHEAPTHRES` (DBM configuration parameter), sorts may not be getting full sort heap as defined by the `SORTHEAP` parameter and an alert may be generated. The indicator is calculated using the formula: $(\text{db2.sort_heap_allocated} / \text{SHEAPTHRES}) * 100$. The Post Threshold Sorts snapshot monitor element measures the number of sorts that have requested heaps after the sort heap threshold has been exceeded. The value of this indicator, shown in the Additional Details, indicates the degree of severity of the problem for this health indicator. The Maximum Private Sort Memory Used snapshot monitor element maintains a private sort memory high-water mark for the instance. The value of

this indicator, shown in the Additional Information, indicates the maximum amount of private sort memory that has been in use at any one point in time since the instance was last recycled. This value can be used to help determine an appropriate value for SHEAPTHRES.

Chapter 56. GET HEALTH NOTIFICATION CONTACT LIST

Returns the list of contacts and contact groups that are notified about the health of an instance. A contact list consists of e-mail addresses or pager Internet addresses of individuals who are to be notified when non-normal health conditions are present for an instance or any of its database objects.

Authorization

None

Required Connection

Instance. An explicit attachment is not required.

Command Syntax

```
»» GET HEALTH NOTIFICATION CONTACT LIST
```

Command Parameters

None

Examples

Issuing the command GET NOTIFICATION LIST results in a report similar to the following:

Name	Type
Joe Brown	Contact
Support	Contact group

Chapter 57. GET HEALTH SNAPSHOT

Retrieves the health status information for the database manager and its databases. The information returned represents a snapshot of the health state at the time the command was issued.

Important: This command or API has been deprecated and might be removed in a future release because the health monitor has been deprecated in Version 9.7. For more information, see the “Health monitor has been deprecated” topic in the *What’s New for DB2 Version 9.7* book.

Scope

In a partitioned database environment, this command can be invoked from any database partition defined in the `db2nodes.cfg` file. By default it acts on the database partition from which it was invoked. If you use the `GLOBAL` option, it will extract consolidated information from all of the database partitions.

Authorization

None

Required connection

Instance. If there is no instance attachment, a default instance attachment is created.

To obtain a snapshot of a remote instance, it is necessary to first attach to that instance.

Command syntax

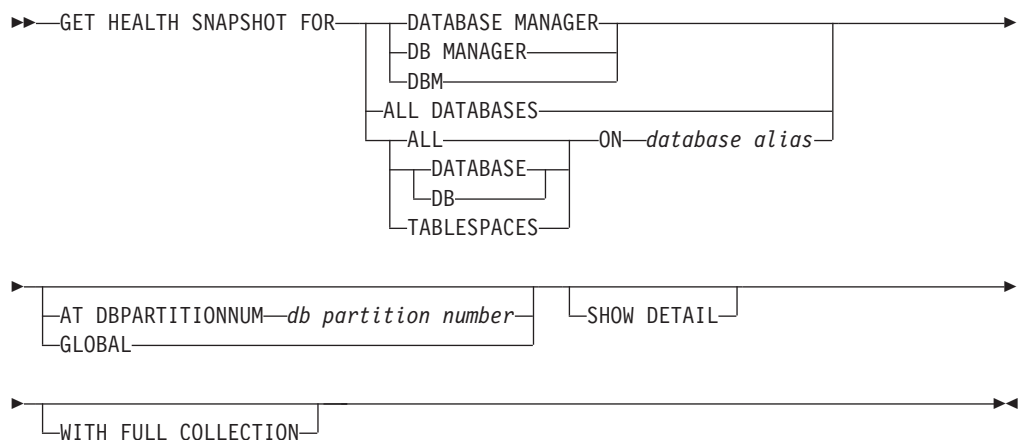

Command parameters

DATABASE MANAGER

Provides statistics for the active database manager instance.

ALL DATABASES

Provides health states for all active databases on the current database partition.

ALL ON *database-alias*

Provides health states and information about all table spaces and buffer pools for a specified database.

DATABASE ON *database-alias*

TABLESPACES ON *database-alias*

Provides information about table spaces for a specified database.

AT DBPARTITIONNUM *db-partition-number*

Returns results for the database partition specified.

GLOBAL

Returns an aggregate result for all database partitions in a partitioned database environment.

SHOW DETAIL

Specifies that the output should include the historical data for each health monitor data element in the form of {(Timestamp, Value, Formula)}, where the bracketed parameters (Timestamp, Value, Formula), will be repeated for each history record that is returned. For example,

```
(03-19-2002 13:40:24.138865,50,((1-(4/8))*100)),  
(03-19-2002 13:40:13.1386300,50,((1-(4/8))*100)),  
(03-19-2002 13:40:03.1988858,0,((1-(3/3))*100))
```

Collection object history is returned for all collection objects in ATTENTION or AUTOMATE FAILED state.

The SHOW DETAIL option also provides additional contextual information that can be useful to understanding the value and alert state of the associated Health Indicator. For example, if the table space storage utilization Health Indicator is being used to determine how full the table space is, the rate at which the table space is growing will also be provided by SHOW DETAIL.

WITH FULL COLLECTION

Specifies that full collection information for all collection state-based health indicators is to be returned. This option considers both the name and size filter criteria. If a user requests a health snapshot with full collection, the report will show all tables that meet the name and size criteria in the policy. This can be used to validate which tables will be evaluated in a given refresh cycle. The output returned when this option is specified is for collection objects in NORMAL, AUTOMATED, ATTENTION, or AUTOMATE FAILED state. This option can be specified in conjunction with the SHOW DETAIL option.

Without this option, only tables that have been evaluated for automatic reorganization and require manual intervention (that is, manual reorg or automation failed) will be displayed in a get health snapshot report.

Examples

The following is typical output resulting from a request for database manager information:

```
D:\>DB2 GET HEALTH SNAPSHOT FOR DBM
```

```
Database Manager Health Snapshot
```

```

Node name                =
Node type                = Enterprise Server Edition
                        with local and remote clients
Instance name            = DB2
Snapshot timestamp       = 02/17/2004 12:39:44.818949

Number of database partitions in DB2 instance = 1
Start Database Manager timestamp = 02/17/2004 12:17:21.000119
Instance highest severity alert state = Normal

```

Health Indicators:

```

Indicator Name           = db2.db2_op_status
Value                    = 0
Evaluation timestamp     = 02/17/2004 12:37:23.393000
Alert state              = Normal

```

```

Indicator Name           = db2.sort_privmem_util
Value                    = 0
Unit                     = %
Evaluation timestamp     = 02/17/2004 12:37:23.393000
Alert state              = Normal

```

```

Indicator Name           = db2.mon_heap_util
Value                    = 6
Unit                     = %
Evaluation timestamp     = 02/17/2004 12:37:23.393000
Alert state              = Normal

```

Chapter 58. GET INSTANCE

Returns the value of the **DB2INSTANCE** environment variable.

Authorization

None

Required connection

None

Command syntax

▶▶ GET INSTANCE ◀◀

Command parameters

None

Examples

The following is sample output from GET INSTANCE:

The current database manager instance is: smith

Chapter 59. GET MONITOR SWITCHES

Displays the status of the database system monitor switches for the current session. Monitor switches instruct the database system manager to collect database activity information. Each application using the database system monitor interface has its own set of monitor switches. This command displays them. To display the database manager-level switches, use the GET DBM MONITOR SWITCHES command.

Authorization

One of the following:

- *sysadm*
- *sysctrl*
- *sysmaint*
- *sysmon*

Required connection

Instance. If there is no instance attachment, a default instance attachment is created.

To display the settings for a remote instance, or for a different local instance, it is necessary to first attach to that instance.

Command syntax

```
➤➤ GET MONITOR SWITCHES [AT DBPARTITIONNUM db-partition-number] GLOBAL
```

Command parameters

AT DBPARTITIONNUM *db-partition-number*

Specifies the database partition for which the status of the monitor switches is to be displayed.

GLOBAL

Returns an aggregate result for all database partitions in a partitioned database environment.

Examples

The following is sample output from GET MONITOR SWITCHES:

Monitor Recording Switches

```
Switch list for db partition number 1
Buffer Pool Activity Information (BUFFERPOOL) = ON 02-20-2003 16:04:30.070073
Lock Information (LOCK) = OFF
Sorting Information (SORT) = OFF
SQL Statement Information (STATEMENT) = ON 02-20-2003 16:04:30.070073
Table Activity Information (TABLE) = OFF
Take Timestamp Information (TIMESTAMP) = ON 02-20-2003 16:04:30.070073
Unit of Work Information (UOW) = ON 02-20-2003 16:04:30.070073
```

Usage notes

The recording switch `TIMESTAMP` is on by default, but can be switched off using `UPDATE MONITOR SWITCHES`. When this switch is on the system issues timestamp calls when collecting information for timestamp monitor elements.

The recording switch `TIMESTAMP` is on by default, but can be switched off using `UPDATE MONITOR SWITCHES`. If this switch is off, this command also displays the time stamp for when the switch was turned off. When this switch is on the system issues timestamp calls when collecting information for timestamp monitor elements. Examples of these elements are:

- `agent_sys_cpu_time`
- `agent_usr_cpu_time`
- `appl_con_time`
- `con_elapsed_time`
- `con_response_time`
- `conn_complete_time`
- `db_conn_time`
- `elapsed_exec_time`
- `gw_comm_error_time`
- `gw_con_time`
- `gw_exec_time`
- `host_response_time`
- `last_backup`
- `last_reset`
- `lock_wait_start_time`
- `network_time_bottom`
- `network_time_top`
- `prev_uow_stop_time`
- `rf_timestamp`
- `ss_sys_cpu_time`
- `ss_usr_cpu_time`
- `status_change_time`
- `stmt_elapsed_time`
- `stmt_start`
- `stmt_stop`
- `stmt_sys_cpu_time`
- `stmt_usr_cpu_time`
- `uow_elapsed_time`
- `uow_start_time`
- `uow_stop_time`

If the `TIMESTAMP` switch is off, timestamp operating system calls are not issued to determine these elements and these elements will contain zero. Turning this switch off becomes important as CPU utilization approaches 100%; when this occurs, the CPU time required for issuing timestamps increases dramatically.

Compatibilities

For compatibility with versions earlier than Version 8:

- The keyword `NODE` can be substituted for `DBPARTITIONNUM`.

Chapter 60. GET RECOMMENDATIONS FOR HEALTH INDICATOR

Returns descriptions of recommendations for improving the health of the aspect of the database system that is monitored by the specified health indicator. Recommendations can be returned for a health indicator that is in an alert state on a specific object, or the full set of recommendations for a given health indicator can be queried.

Important: This command or API has been deprecated and might be removed in a future release because the health monitor has been deprecated in Version 9.7. For more information, see the “Health monitor has been deprecated” topic in the *What’s New for DB2 Version 9.7* book.

Scope

In a partitioned database environment, this command can be invoked from any database partition defined in the `db2nodes.cfg` file. It acts only on that database partition unless the `GLOBAL` parameter is specified.

Authorization

None

Required connection

Instance. If there is no instance attachment, a default instance attachment is created. To retrieve recommendations for a remote instance, it is necessary to first attach to that instance.

Command syntax

```
▶▶ GET RECOMMENDATIONS FOR HEALTH INDICATOR health-indicator-name ▶▶
▶
├── FOR DBM
│   ├── TABLESPACE tblspacename ON database-alias
│   ├── CONTAINER containername FOR TABLESPACE tblspacename
│   └── DATABASE
└── AT DBPARTITIONNUM db-partition-number
    └── GLOBAL
```

Command parameters

HEALTH INDICATOR *health-indicator-name*

The name of the health indicator for which you would like to retrieve the recommendations. Health indicator names consist of a two- or three-letter object identifier followed by a name that describes what the indicator measures.

DBM Returns recommendations for a database manager health indicator that has entered an alert state.

TABLESPACE *tblspacename*

Returns recommendation for a health indicator that has entered an alert state on the specified table space and database.

CONTAINER *containername*

Returns recommendation for a health indicator that has entered an alert state on the specified container in the specified table space and database.

DATABASE

Returns recommendations for a health indicator that has entered an alert state on the specified database.

ON *database-alias*

Specifies a database.

AT DBPARTITIONNUM

Specifies the database partition number at which the health indicator has entered an alert state. If a database partition number is not specified and GLOBAL is not specified, the command will return information for the currently connected database partition.

GLOBAL

Retrieves recommendations for the specified health indicator across all database partitions. In cases where the recommendations are the same on different database partitions, those recommendations are returned as a single set of recommendations that solve the health indicator on the affected database partitions.

Examples

```
db2 get recommendations for health indicator db.db_heap_util
for database on sample
```

Problem:

Indicator Name	= db.db_heap_util
Value	= 42
Evaluation timestamp	= 11/25/2003 19:04:54
Alert state	= Alarm
Additional information	=

Recommendations:

Recommendation: Increase the database heap size.
Rank: 1

Increase the database configuration parameter dbheap sufficiently to move utilization to normal operating levels. To increase the value, set the new value of dbheap to be equal to $(\text{pool_cur_size} / (4096 * U))$ where U is the desired utilization rate. For example, if your desired utilization rate is 60% of the warning threshold level, which you have set at 75%, then $U = 0.6 * 0.75 = 0.45$ (or 45%).

Take one of the following actions:

Execute the following scripts at the DB2 server:

```
CONNECT TO SAMPLE;
UPDATE DB CFG USING DBHEAP 149333;
CONNECT_RESET;
```

Launch DB2 tool: Database Configuration Window

The Database Configuration window can be used to view and update database configuration parameters.

To open the Database Configuration window:

1. From the Control Center, expand the object tree until you find the databases folder.
2. Click the databases folder. Any existing database are displayed in the contents pane on the right side of the window.
3. Right-click the database that you want in the contents pane, and click Configure Parameters in the pop-up menu. The Database Configuration window opens.

On the Performance tab, update the database heap size parameter as suggested and click OK to apply the update.

Recommendation: Investigate memory usage of database heap.

Rank: 2

There is one database heap per database and the database manager uses it on behalf of all applications connected to the database. The data area is expanded as needed up to the maximum specified by dbheap.

For more information on the database heap, refer to the DB2 Information Center.

Investigate the amount of memory that was used for the database heap over time to determine the most appropriate value for the database heap configuration parameter. The database system monitor tracks the highest amount of memory that was used for the database heap.

Take one of the following actions:

Launch DB2 tool: Memory Visualizer

The Memory Visualizer is used to monitor memory allocation within a DB2 instance. It can be used to monitor overall memory usage, and to update configuration parameters for individual memory components.

To open the Memory Visualizer:

1. From the Control Center, expand the object tree until you find the instances folder.
2. Click the instances folder. Any existing instances are displayed in the contents pane on the right side of the window.
3. Right-click the instance that you want in the contents pane, and click View Memory Usage in the pop-up menu. The Memory Visualizer opens.

To start the Memory Visualizer from the command line issue the db2memvis command.

The Memory Visualizer displays a hierarchical list of memory pools for the database manager. Database Heap is listed under the Database Manager Memory group for each database. On Windows, it is listed under the Database Manager Shared Memory group.

Click the check box on the Show Plot column for the Database Heap row to add the element to the plot.

Usage notes

The GET RECOMMENDATIONS FOR HEALTH INDICATOR command can be used in two different ways:

- Specify only the health indicator to get an informational list of all possible recommendations. If no object is specified, the command will return a full listing of all recommendations that can be used to resolve an alert on the given health indicator.
- Specify an object to resolve a specific alert on that object. If an object (for example, a database or a table space) is specified, the recommendations returned will be specific to an alert on the object identified. In this case, the recommendations will be more specific and will contain more information about resolving the alert. If the health indicator identified is not in an alert state on the specified object, no recommendations will be returned.

Chapter 61. GET ROUTINE

Retrieves a routine SQL Archive (SAR) file for a specified SQL routine.

Authorization

SELECT privilege on the SYSCAT.ROUTINES.

Required connection

Database. If implicit connect is enabled, a connection to the default database is established.

Command syntax

```
➤➤ GET ROUTINE INTO file_name FROM [SPECIFIC] PROCEDURE routine_name ➤➤  
➤ [HIDE BODY] ➤➤
```

Command parameters

INTO *file_name*

Names the file where routine SQL archive (SAR) is stored.

FROM

Indicates the start of the specification of the routine to be retrieved.

SPECIFIC

The specified routine name is given as a specific name.

PROCEDURE

The routine is an SQL procedure.

routine_name

The name of the procedure. If SPECIFIC is specified then it is the specific name of the procedure. If the name is not qualified with a schema name, the CURRENT SCHEMA is used as the schema name of the routine. The *routine-name* must be an existing procedure that is defined as an SQL procedure.

HIDE BODY

Specifies that the body of the routine must be replaced by an empty body when the routine text is extracted from the catalogs.

This does not affect the compiled code; it only affects the text.

Examples

```
GET ROUTINE INTO procs/proc1.sar FROM PROCEDURE myappl.proc1;
```

Usage notes

If a GET ROUTINE or a PUT ROUTINE operation (or their corresponding procedure) fails to execute successfully, it will always return an error (SQLSTATE 38000), along with diagnostic text providing information about the cause of the

failure. For example, if the procedure name provided to GET ROUTINE does not identify an SQL procedure, diagnostic "-204, 42704" text will be returned, where "-204" and "42704" are the SQLCODE and SQLSTATE, respectively, that identify the cause of the problem. The SQLCODE and SQLSTATE in this example indicate that the procedure name provided in the GET ROUTINE command is undefined.

Chapter 62. GET SNAPSHOT

Collects status information and formats the output for the user. The information returned represents a *snapshot* of the database manager operational status at the time the command was issued.

Scope

In a partitioned database environment, this command can be invoked from any database partition defined in the db2nodes.cfg file. It acts only on that database partition.

Authorization

One of the following:

- SYSADM
- SYSCTRL
- SYSMANT
- SYSMON

Required connection

Instance. If there is no instance attachment, a default instance attachment is created.

To obtain a snapshot of a remote instance, it is necessary to first attach to that instance.

Command syntax

▶▶—GET SNAPSHOT FOR—————▶

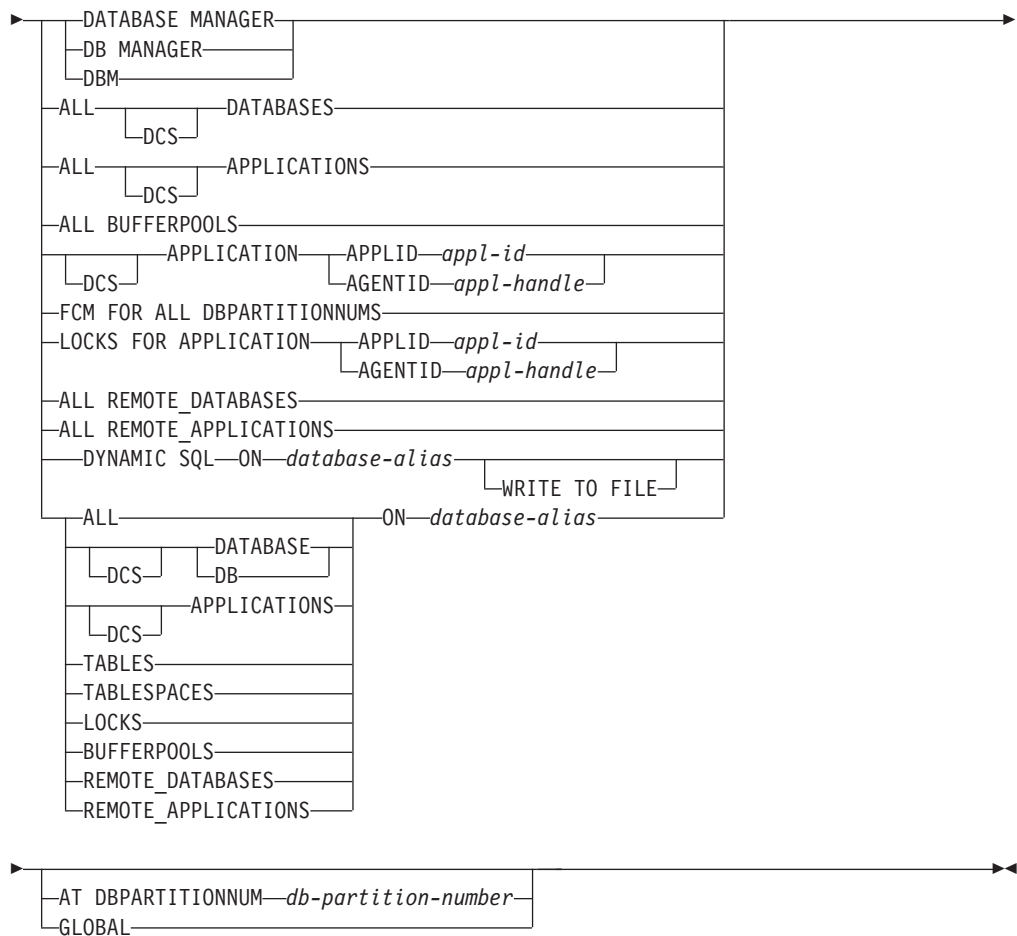

The monitor switches must be turned on in order to collect some statistics.

Command parameters

DATABASE MANAGER

Provides statistics for the active database manager instance.

ALL DATABASES

Provides general statistics for all active databases on the current database partition.

ALL APPLICATIONS

Provides information about all active applications that are connected to a database on the current database partition.

ALL BUFFERPOOLS

Provides information about buffer pool activity for all active databases.

APPLICATION APPLID *appl-id*

Provides information only about the application whose ID is specified. To get a specific application ID, use the LIST APPLICATIONS command.

APPLICATION AGENTID *appl-handle*

Provides information only about the application whose application handle is specified. The application handle is a 32-bit number that uniquely identifies an application that is currently running. Use the LIST APPLICATIONS command to get a specific application handle.

FCM FOR ALL DBPARTITIONNUMS

Provides Fast Communication Manager (FCM) statistics between the database partition against which the GET SNAPSHOT command was issued and the other database partitions in the partitioned database environment.

LOCKS FOR APPLICATION APPLID *appl-id*

Provides information about all locks held by the specified application, identified by application ID.

LOCKS FOR APPLICATION AGENTID *appl-handle*

Provides information about all locks held by the specified application, identified by application handle.

ALL REMOTE_DATABASES

Provides general statistics about all active remote databases on the current database partition.

ALL REMOTE_APPLICATIONS

Provides information about all active remote applications that are connected to the current database partition.

ALL ON *database-alias*

Provides general statistics and information about all applications, tables, table spaces, buffer pools, and locks for a specified database.

DATABASE ON *database-alias*

Provides general statistics for a specified database.

APPLICATIONS ON *database-alias*

Provides information about all applications connected to a specified database.

TABLES ON *database-alias*

Provides information about tables in a specified database. This will include only those tables that have been accessed since the TABLE recording switch was turned on.

TABLESPACES ON *database-alias*

Provides information about table spaces for a specified database.

LOCKS ON *database-alias*

Provides information about every lock held by each application connected to a specified database.

BUFFERPOOLS ON *database-alias*

Provides information about buffer pool activity for the specified database.

REMOTE_DATABASES ON *database-alias*

Provides general statistics about all active remote databases for a specified database.

REMOTE_APPLICATIONS ON *database-alias*

Provides information about remote applications for a specified database.

DYNAMIC SQL ON *database-alias*

Returns a point-in-time picture of the contents of the SQL statement cache for the database.

WRITE TO FILE

Specifies that snapshot results are to be stored in a file at the server, as well as being passed back to the client. This command is valid only over a

database connection. The snapshot data can then be queried through the table function SYSFUN.SQLCACHE_SNAPSHOT over the same connection on which the call was made.

DCS Depending on which clause it is specified, this keyword requests statistics about:

- A specific DCS application currently running on the DB2 Connect Gateway
- All DCS applications
- All DCS applications currently connected to a specific DCS database
- A specific DCS database
- All DCS databases.

AT DBPARTITIONNUM *db-partition-number*

Returns results for the database partition specified.

GLOBAL

Returns an aggregate result for all database partitions in a partitioned database environment.

Examples

- To request snapshot information about the database manager, issue:
get snapshot for database manager

The following is a sample output listing from the above command:

Database Manager Snapshot

```

Node name                =
Node type                = Enterprise Server Edition with local and remote clients
Instance name           = DB2
Number of database partitions in DB2 instance = 1
Database manager status = Active

Product name            = DB2 v9.5.0.535
Service level           = s070101 (NT32)

Private Sort heap allocated = 0
Private Sort heap high water mark = 0
Post threshold sorts     = Not Collected
Piped sorts requested    = 0
Piped sorts accepted     = 0

Start Database Manager timestamp = 01/10/2007 15:18:36.241035
Last reset timestamp      =
Snapshot timestamp       = 01/10/2007 15:28:26.989789

Remote connections to db manager = 3
Remote connections executing in db manager = 0
Local connections         = 1
Local connections executing in db manager = 0
Active local databases    = 1

High water mark for agents registered = 0
Agents registered         = 8
Idle agents               = 0

Committed private Memory (Bytes) = 8912896

Switch list for db partition number 0
Buffer Pool Activity Information (BUFFERPOOL) = OFF
Lock Information (LOCK) = ON 01/10/2007 15:22:43.145437
Sorting Information (SORT) = OFF

```



```

SQL Statement Information      (STATEMENT) = OFF
Table Activity Information    (TABLE) = OFF
Take Timestamp Information    (TIMESTAMP) = ON 01/10/2007 15:18:36.241035
Unit of Work Information      (UOW) = OFF

```

```

Agents assigned from pool      = 3
Agents created from empty pool = 11
Agents stolen from another application = 0
High water mark for coordinating agents = 9
Hash joins after heap threshold exceeded = 0
OLAP functions after heap threshold exceeded = 0

```

```

Total number of gateway connections = 0
Current number of gateway connections = 0
Gateway connections waiting for host reply = 0
Gateway connections waiting for client request = 0
Gateway connection pool agents stolen = 0

```

```

Node FCM information corresponds to = 0
Free FCM buffers = 128
Free FCM buffers low water mark = 128
Free FCM channels = 128
Free FCM channels low water mark = 128

```

Memory usage for database manager:

```

Node number = 0
  Memory Pool Type = Other Memory
    Current size (bytes) = 11534336
    High water mark (bytes) = 11599872
    Configured size (bytes) = 34275328

Node number = 0
  Memory Pool Type = Database Monitor Heap
    Current size (bytes) = 65536
    High water mark (bytes) = 65536
    Configured size (bytes) = 327680

Node number = 0
  Memory Pool Type = FCMBP Heap
    Current size (bytes) = 655360
    High water mark (bytes) = 655360
    Configured size (bytes) = 851968

```

- To request snapshot information about an application with agent ID 29:
get snapshot for application agentid 29

The following is a sample output listing from the above command, assuming the lock and statement monitor switches are ON:

Application Snapshot

```

Application handle = 29
Application status = Lock-wait
Status change time = Not Collected
Application code page = 819
Application country/region code = 1
DUOW correlation token = *LOCAL.jwr.070222182152
Application name = db2bp
Application ID = *LOCAL.jwr.070222182152
Sequence number = 00001
TP Monitor client user ID =
TP Monitor client workstation name =
TP Monitor client application name =
TP Monitor client accounting string =

```

```

Connection request start timestamp           = 02/22/2007 13:21:52.587168
Connect request completion timestamp        = 02/22/2007 13:21:53.291779
Application idle time                       =
CONNECT Authorization ID                   = JWR
Client login ID                            = jwr
Configuration NNAME of client               = gilera
Client database manager product ID          = SQL09050
Process ID of client application            = 843852
Platform of client application              = AIX 64BIT
Communication protocol of client            = Local Client

Inbound communication address                = *LOCAL.jwr

Database name                               = SAMPLE
Database path                               = /home/jwr/jwr/NODE0000/SQL00001/
Client database alias                       = SAMPLE
Input database alias                        =
Last reset timestamp                       =
Snapshot timestamp                         = 02/22/2007 13:22:39.766300
Authorization level granted                 =
  User authority:
    DBADM authority
    CREATETAB authority
    BINDADD authority
    CONNECT authority
    CREATE_NOT_FENC authority
    LOAD authority
    IMPLICIT_SCHEMA authority
    CREATE_EXT_RT authority
    QUIESCE_CONN authority
  Group authority:
    SYSADM authority
    CREATETAB authority
    BINDADD authority
    CONNECT authority
    IMPLICIT_SCHEMA authority
Coordinating database partition number      = 0
Current database partition number           = 0
Coordinator agent process or thread ID      = 1801
Current Workload ID                         = 1
Agents stolen                              = 0
Agents waiting on locks                    = 1
Maximum associated agents                   = 1
Priority at which application agents work    = 0
Priority type                               = Dynamic

Lock timeout (seconds)                     = -1
Locks held by application                   = 4
Lock waits since connect                   = 1
Time application waited on locks (ms)     = 20268
Deadlocks detected                         = 0
Lock escalations                           = 0
Exclusive lock escalations                  = 0
Number of Lock Timeouts since connected    = 0
Total time UOW waited on locks (ms)       = Not Collected

Total sorts                                = 0
Total sort time (ms)                       = Not Collected
Total sort overflows                       = 0

Buffer pool data logical reads              = Not Collected
Buffer pool data physical reads            = Not Collected
Buffer pool temporary data logical reads   = Not Collected
Buffer pool temporary data physical reads  = Not Collected
Buffer pool data writes                    = Not Collected
Buffer pool index logical reads            = Not Collected
Buffer pool index physical reads           = Not Collected

```

Buffer pool temporary index logical reads	= Not Collected
Buffer pool temporary index physical reads	= Not Collected
Buffer pool index writes	= Not Collected
Buffer pool xda logical reads	= Not Collected
Buffer pool xda physical reads	= Not Collected
Buffer pool temporary xda logical reads	= Not Collected
Buffer pool temporary xda physical reads	= Not Collected
Buffer pool xda writes	= Not Collected
Total buffer pool read time (milliseconds)	= Not Collected
Total buffer pool write time (milliseconds)	= Not Collected
Time waited for prefetch (ms)	= Not Collected
Unread prefetch pages	= Not Collected
Direct reads	= Not Collected
Direct writes	= Not Collected
Direct read requests	= Not Collected
Direct write requests	= Not Collected
Direct reads elapsed time (ms)	= Not Collected
Direct write elapsed time (ms)	= Not Collected
Number of SQL requests since last commit	= 3
Commit statements	= 0
Rollback statements	= 0
Dynamic SQL statements attempted	= 3
Static SQL statements attempted	= 0
Failed statement operations	= 0
Select SQL statements executed	= 1
Xquery statements executed	= 0
Update/Insert/Delete statements executed	= 0
DDL statements executed	= 0
Inactive stmt history memory usage (bytes)	= 0
Internal automatic rebinds	= 0
Internal rows deleted	= 0
Internal rows inserted	= 0
Internal rows updated	= 0
Internal commits	= 1
Internal rollbacks	= 0
Internal rollbacks due to deadlock	= 0
Binds/precompiles attempted	= 0
Rows deleted	= 0
Rows inserted	= 0
Rows updated	= 0
Rows selected	= 0
Rows read	= 95
Rows written	= 0
UOW log space used (Bytes)	= Not Collected
Previous UOW completion timestamp	= Not Collected
Elapsed time of last completed uow (sec.ms)	= Not Collected
UOW start timestamp	= Not Collected
UOW stop timestamp	= Not Collected
UOW completion status	= Not Collected
Open remote cursors	= 0
Open remote cursors with blocking	= 0
Rejected Block Remote Cursor requests	= 0
Accepted Block Remote Cursor requests	= 1
Open local cursors	= 1
Open local cursors with blocking	= 1
Total User CPU Time used by agent (s)	= 0.019150
Total System CPU Time used by agent (s)	= 0.001795
Host execution elapsed time	= 0.012850
Package cache lookups	= 2
Package cache inserts	= 1
Application section lookups	= 3
Application section inserts	= 1
Catalog cache lookups	= 11

Catalog cache inserts	= 8
Catalog cache overflows	= 0
Catalog cache high water mark	= 0

Workspace Information

Shared high water mark	= 0
Total shared overflows	= 0
Total shared section inserts	= 0
Total shared section lookups	= 0
Private high water mark	= 0
Total private overflows	= 0
Total private section inserts	= 0
Total private section lookups	= 0

Most recent operation	= Fetch
Cursor name	= SQLCUR201
Most recent operation start timestamp	= 02/22/2007 13:22:19.497439
Most recent operation stop timestamp	=
Agents associated with the application	= 1
Number of hash joins	= 0
Number of hash loops	= 0
Number of hash join overflows	= 0
Number of small hash join overflows	= 0
Number of OLAP functions	= 0
Number of OLAP function overflows	= 0

Statement type	= Dynamic SQL Statement
Statement	= Fetch
Section number	= 201
Application creator	= NULLID
Package name	= SQLC2G11
Consistency Token	= AAAANBX
Package Version ID	=
Cursor name	= SQLCUR201
Statement database partition number	= 0
Statement start timestamp	= 02/22/2007 13:22:19.497439
Statement stop timestamp	=
Elapsed time of last completed stmt(sec.ms)	= 0.000289
Total Statement user CPU time	= 0.002172
Total Statement system CPU time	= 0.001348
SQL compiler cost estimate in timerons	= 14
SQL compiler cardinality estimate	= 57
Degree of parallelism requested	= 1
Number of agents working on statement	= 1
Number of subagents created for statement	= 1
Statement sorts	= 0
Total sort time	= 0
Sort overflows	= 0
Rows read	= 0
Rows written	= 0
Rows deleted	= 0
Rows updated	= 0
Rows inserted	= 0
Rows fetched	= 0
Buffer pool data logical reads	= Not Collected
Buffer pool data physical reads	= Not Collected
Buffer pool temporary data logical reads	= Not Collected
Buffer pool temporary data physical reads	= Not Collected
Buffer pool index logical reads	= Not Collected
Buffer pool index logical reads	= Not Collected
Buffer pool temporary index logical reads	= Not Collected
Buffer pool temporary index physical reads	= Not Collected
Buffer pool xda logical reads	= Not Collected
Buffer pool xda physical reads	= Not Collected
Buffer pool temporary xda logical reads	= Not Collected

```

Buffer pool temporary xda physical reads = Not Collected
Blocking cursor                          = YES
Dynamic SQL statement text:
select * from org

Agent process/thread ID                   = 1801

Memory usage for application:

    Memory Pool Type                      = Application Heap
    Current size (bytes)                  = 65536
    High water mark (bytes)               = 65536
    Configured size (bytes)               = 1048576

Agent process/thread ID                   = 1801
Agent Lock timeout (seconds)              = -1
Memory usage for agent:

    Memory Pool Type                      = Other Memory
    Current size (bytes)                  = 589824
    High water mark (bytes)               = 786432
    Configured size (bytes)               = 34359738368

ID of agent holding lock                  = 34
Application ID holding lock                = *LOCAL.jwr.070222182158
Lock name                                 = 0x0002000E00000000000000000054
Lock attributes                           = 0x00000000
Release flags                              = 0x00000001
Lock object type                           = Table
Lock mode                                  = Exclusive Lock (X)
Lock mode requested                        = Intention Share Lock (IS)
Name of tablespace holding lock            = USERSPACE1
Schema of table holding lock                = JWR
Name of table holding lock                 = ORG
Data Partition Id of table holding lock    = 0
Lock wait start timestamp                  = 02/22/2007 13:22:19.497833

```

- To request snapshot information about all of the databases:

get snapshot for all databases

The following is a sample output listing from the above command:

Database Snapshot

```

Database name                             = SAMPLE
Database path                             = C:\DB2\NODE0000\SQL00001\
Input database alias                       =
Database status                           = Active
Catalog database partition number          = 0
Catalog network node name                 =
Operating system running at database server= NT
Location of the database                   = Local
First database connect timestamp           = 06/21/2007 14:46:49.771064
Last reset timestamp                       =
Last backup timestamp                     =
Snapshot timestamp                         = 06/21/2007 14:51:50.235993

Number of automatic storage paths          = 1
Automatic storage path                     = C:
    Node number                            = 0

High water mark for connections            = 6
Application connects                       = 4
Secondary connects total                   = 4
Applications connected currently           = 1
Appls. executing in db manager currently   = 0
Agents associated with applications         = 5
Maximum agents associated with applications= 6

```

Maximum coordinating agents	= 6
Number of Threshold Violations	= 0
Locks held currently	= 0
Lock waits	= 0
Time database waited on locks (ms)	= Not Collected
Lock list memory in use (Bytes)	= 2256
Deadlocks detected	= 0
Lock escalations	= 0
Exclusive lock escalations	= 0
Agents currently waiting on locks	= 0
Lock Timeouts	= 0
Number of indoubt transactions	= 0
Total Private Sort heap allocated	= 0
Total Shared Sort heap allocated	= 0
Shared Sort heap high water mark	= 0
Post threshold sorts (shared memory)	= Not Collected
Total sorts	= 0
Total sort time (ms)	= Not Collected
Sort overflows	= 0
Active sorts	= 0
Buffer pool data logical reads	= Not Collected
Buffer pool data physical reads	= Not Collected
Buffer pool temporary data logical reads	= Not Collected
Buffer pool temporary data physical reads	= Not Collected
Asynchronous pool data page reads	= Not Collected
Buffer pool data writes	= Not Collected
Asynchronous pool data page writes	= Not Collected
Buffer pool index logical reads	= Not Collected
Buffer pool index physical reads	= Not Collected
Buffer pool temporary index logical reads	= Not Collected
Buffer pool temporary index physical reads	= Not Collected
Asynchronous pool index page reads	= Not Collected
Buffer pool index writes	= Not Collected
Asynchronous pool index page writes	= Not Collected
Buffer pool xda logical reads	= Not Collected
Buffer pool xda physical reads	= Not Collected
Buffer pool temporary xda logical reads	= Not Collected
Buffer pool temporary xda physical reads	= Not Collected
Buffer pool xda writes	= Not Collected
Asynchronous pool xda page reads	= Not Collected
Asynchronous pool xda page writes	= Not Collected
Total buffer pool read time (milliseconds)	= Not Collected
Total buffer pool write time (milliseconds)	= Not Collected
Total elapsed asynchronous read time	= Not Collected
Total elapsed asynchronous write time	= Not Collected
Asynchronous data read requests	= Not Collected
Asynchronous index read requests	= Not Collected
Asynchronous xda read requests	= Not Collected
No victim buffers available	= Not Collected
LSN Gap cleaner triggers	= Not Collected
Dirty page steal cleaner triggers	= Not Collected
Dirty page threshold cleaner triggers	= Not Collected
Time waited for prefetch (ms)	= Not Collected
Unread prefetch pages	= Not Collected
Direct reads	= Not Collected
Direct writes	= Not Collected
Direct read requests	= Not Collected
Direct write requests	= Not Collected
Direct reads elapsed time (ms)	= Not Collected
Direct write elapsed time (ms)	= Not Collected
Database files closed	= Not Collected
Vectored IOs	= Not Collected
Pages from vectored IOs	= Not Collected
Block IOs	= Not Collected

```

Pages from block IOs                = Not Collected

Host execution elapsed time          = Not Collected

Commit statements attempted          = 0
Rollback statements attempted        = 0
Dynamic statements attempted         = 6
Static statements attempted          = 3
Failed statement operations          = 0
Select SQL statements executed        = 0
Xquery statements executed           = 0
Update/Insert/Delete statements executed = 0
DDL statements executed               = 0
Inactive stmt history memory usage (bytes) = 0

Internal automatic rebinds           = 0
Internal rows deleted                = 0
Internal rows inserted               = 0
Internal rows updated                = 0
Internal commits                     = 6
Internal rollbacks                   = 0
Internal rollbacks due to deadlock   = 0
Number of MDC table blocks pending cleanup = 0

Rows deleted                         = 0
Rows inserted                        = 0
Rows updated                         = 0
Rows selected                        = 0
Rows read                            = 98
Binds/precompiles attempted         = 0

Log space available to the database (Bytes)= 20400000
Log space used by the database (Bytes) = 0
Maximum secondary log space used (Bytes) = 0
Maximum total log space used (Bytes)   = 0
Secondary logs allocated currently     = 0
Log pages read                        = 0
Log read time (sec.ns)                = 0.000000004
Log pages written                     = 0
Log write time (sec.ns)               = 0.000000004
Number write log IOs                  = 0
Number read log IOs                   = 0
Number partial page log IOs           = 0
Number log buffer full                 = 0
Log data found in buffer               = 0
Appl id holding the oldest transaction = 93
Log to be redone for recovery (Bytes)  = 0
Log accounted for by dirty pages (Bytes) = 0

Node number                           = 0
File number of first active log        = 0
File number of last active log         = 2
File number of current active log      = 0
File number of log being archived      = Not applicable

Package cache lookups                 = 6
Package cache inserts                  = 0
Package cache overflows                = 0
Package cache high water mark (Bytes)  = 196608
Application section lookups            = 6
Application section inserts            = 0

Catalog cache lookups                 = 37
Catalog cache inserts                  = 10
Catalog cache overflows                = 0
Catalog cache high water mark         = 65536
Catalog cache statistics size          = 0

```

Workspace Information

Shared high water mark	= 0
Corresponding shared overflows	= 0
Total shared section inserts	= 0
Total shared section lookups	= 0
Private high water mark	= 0
Corresponding private overflows	= 0
Total private section inserts	= 0
Total private section lookups	= 0
Number of hash joins	= 0
Number of hash loops	= 0
Number of hash join overflows	= 0
Number of small hash join overflows	= 0
Post threshold hash joins (shared memory)	= 0
Active hash joins	= 0
Number of OLAP functions	= 0
Number of OLAP function overflows	= 0
Active OLAP functions	= 0
Statistic fabrications	= Not Collected
Synchronous runstats	= Not Collected
Asynchronous runstats	= Not Collected
Total statistic fabrication time (milliseconds)	= Not Collected
Total synchronous runstats time (milliseconds)	= Not Collected

Memory usage for database:

Node number	= 0
Memory Pool Type	= Backup/Restore/Util Heap
Current size (bytes)	= 65536
High water mark (bytes)	= 65536
Configured size (bytes)	= 20512768
Node number	= 0
Memory Pool Type	= Package Cache Heap
Current size (bytes)	= 196608
High water mark (bytes)	= 196608
Configured size (bytes)	= 402653184
Node number	= 0
Memory Pool Type	= Other Memory
Current size (bytes)	= 131072
High water mark (bytes)	= 131072
Configured size (bytes)	= 20971520
Node number	= 0
Memory Pool Type	= Catalog Cache Heap
Current size (bytes)	= 65536
High water mark (bytes)	= 65536
Configured size (bytes)	= 402653184
Node number	= 0
Memory Pool Type	= Buffer Pool Heap
Secondary ID	= 1
Current size (bytes)	= 2424832
High water mark (bytes)	= 2424832
Configured size (bytes)	= 402653184
Node number	= 0
Memory Pool Type	= Buffer Pool Heap
Secondary ID	= System 32k buffer pool
Current size (bytes)	= 851968

High water mark (bytes)	= 851968
Configured size (bytes)	= 402653184
Node number	= 0
Memory Pool Type	= Buffer Pool Heap
Secondary ID	= System 16k buffer pool
Current size (bytes)	= 589824
High water mark (bytes)	= 589824
Configured size (bytes)	= 402653184
Node number	= 0
Memory Pool Type	= Buffer Pool Heap
Secondary ID	= System 8k buffer pool
Current size (bytes)	= 458752
High water mark (bytes)	= 458752
Configured size (bytes)	= 402653184
Node number	= 0
Memory Pool Type	= Buffer Pool Heap
Secondary ID	= System 4k buffer pool
Current size (bytes)	= 393216
High water mark (bytes)	= 393216
Configured size (bytes)	= 402653184
Node number	= 0
Memory Pool Type	= Shared Sort Heap
Current size (bytes)	= 0
High water mark (bytes)	= 0
Configured size (bytes)	= 20512768
Node number	= 0
Memory Pool Type	= Lock Manager Heap
Current size (bytes)	= 327680
High water mark (bytes)	= 327680
Configured size (bytes)	= 393216
Node number	= 0
Memory Pool Type	= Database Heap
Current size (bytes)	= 10551296
High water mark (bytes)	= 10551296
Configured size (bytes)	= 12582912
Node number	= 0
Memory Pool Type	= Application Heap
Secondary ID	= 97
Current size (bytes)	= 65536
High water mark (bytes)	= 65536
Configured size (bytes)	= 1048576
Node number	= 0
Memory Pool Type	= Application Heap
Secondary ID	= 96
Current size (bytes)	= 65536
High water mark (bytes)	= 65536
Configured size (bytes)	= 1048576
Node number	= 0
Memory Pool Type	= Application Heap
Secondary ID	= 95
Current size (bytes)	= 65536
High water mark (bytes)	= 65536
Configured size (bytes)	= 1048576
Node number	= 0
Memory Pool Type	= Application Heap
Secondary ID	= 94
Current size (bytes)	= 65536

High water mark (bytes)	= 65536
Configured size (bytes)	= 1048576
Node number	= 0
Memory Pool Type	= Application Heap
Secondary ID	= 93
Current size (bytes)	= 65536
High water mark (bytes)	= 65536
Configured size (bytes)	= 1048576
Node number	= 0
Memory Pool Type	= Applications Shared Heap
Current size (bytes)	= 65536
High water mark (bytes)	= 65536
Configured size (bytes)	= 20512768

User authority represents all authorizations and roles granted to the user, and Group authority represents all authorizations and roles granted to the group.

- To request snapshot information about a specific application with application handle 765 connected to the SAMPLE database, issue:

```
get snapshot for application agentid 765
```

- To request dynamic SQL snapshot information about the SAMPLE database, issue:

```
get snapshot for dynamic sql on sample
```

Usage notes

- When write suspend is ON against a database, snapshots cannot be issued against that database until write suspend is turned OFF. When a snapshot is issued against a database for which write suspend was turned ON, a diagnostic probe is written to the db2diag log file and that database is skipped.
- To obtain a snapshot from a remote instance (or a different local instance), it is necessary to first attach to that instance. If an alias for a database residing at a different instance is specified, an error message is returned.
- To obtain some statistics, it is necessary that the database system monitor switches are turned on. If the recording switch **TIMESTAMP** has been set to OFF, timestamp related elements will report "Not Collected".
- No data is returned following a request for table information if any of the following is true:
 - The **TABLE** recording switch is turned off.
 - No tables have been accessed since the switch was turned on.
 - No tables have been accessed since the last **RESET MONITOR** command was issued.

However, if a **REORG TABLE** is being performed or has been performed during this period, some information is returned although some fields are not displayed.

- To obtain snapshot information from all database partitions (which is different than the aggregate result of all partitions), the snapshot administrative views should be used.
- In a partitioned database environment, specifying the command with the **GLOBAL** option will return a value for the High water mark for connections parameter which represents the greatest high water mark for connections among all the nodes and not the sum of the individual high water marks of all the nodes. For example:
 - Node A has 5 applications connected currently and the high water mark for connections is 5.

- Node B has 4 applications connected currently and the high water mark for connections is 6.

In the above example, the High water mark for connections value is 6, and the Applications connected currently value is 9.

Compatibilities

For compatibility with versions earlier than Version 8:

- The keyword **NODE** can be substituted for **DBPARTITIONNUM**.
- The keyword **NODES** can be substituted for **DBPARTITIONNUMS**.
- The new registry variable in Version 9.5, **DB2_SYSTEM_MONITOR_SETTINGS** impacts the behavior of monitoring the CPU usage on Linux. If you need to use the method of reading CPU usage that returns both system and user CPU usage times on Linux, perform one of the following actions.

On Linux on RHEL4 and SLES9:

```
db2set DB2_SYSTEM_MONITOR_SETTINGS=DISABLE_CPU_USAGE:TRUE
```

On Linux on RHEL5 and SLES10:

```
db2set DB2_SYSTEM_MONITOR_SETTINGS=OLD_CPU_USAGE:TRUE
```

Chapter 63. HELP

Permits the user to invoke help from the Information Center.

This command is not available on UNIX based systems.

Authorization

None

Required connection

None

Command syntax

▶▶—HELP—▶▶

Examples

The following example shows how to use the HELP command:

- db2 help

This command opens the DB2 Information Center, which contains information about DB2 divided into categories, such as tasks, reference, books, and so on.

This is equivalent to invoking the db2ic command with no parameters.

Usage notes

The command line processor will not know if the command succeeds or fails, and cannot report error conditions.

Chapter 64. HISTORY

Displays the history of commands run within a CLP interactive mode session.

Scope

This command can only be run within CLP interactive mode. Specifically, it cannot be run from the CLP command mode or the CLP batch mode.

Authorization

None

Required connection

None

Command syntax



Command parameters

REVERSE | R

Displays the command history in reverse order, with the most-recently run command listed first. If this parameter is not specified, the commands are listed in chronological order, with the most recently run command listed last.

num Displays only the most recent *num* commands. If this parameter is not specified, a maximum of 20 commands are displayed. However, the number of commands that are displayed is also restricted by the number of commands that are stored in the command history.

Usage notes

1. The value of the DB2_CLP_HISTSIZE registry variable specifies the maximum number of commands to be stored in the command history. This registry variable can be set to any value between 1 and 500 inclusive. If this registry variable is not set or is set to a value outside the valid range, a maximum of 20 commands is stored in the command history.
2. Since the HISTORY command will always be listed in the command history, the maximum number of commands displayed will always be one greater than the user-specified maximum.
3. The command history is not persistent across CLP interactive mode sessions, which means that the command history is not saved at the end of an interactive mode session.
4. The command histories of multiple concurrently running CLP interactive mode sessions are independent of one another.

Chapter 65. IMPORT

Inserts data from an external file with a supported file format into a table, hierarchy, view or nickname. LOAD is a faster alternative, but the load utility does not support loading data at the hierarchy level.

Quick link to “File type modifiers for the import utility” on page 280.

Authorization

- IMPORT using the **INSERT** option requires one of the following:
 - *dataaccess* authority
 - CONTROL privilege on each participating table, view, or nickname
 - INSERT and SELECT privilege on each participating table or view
- IMPORT to an existing table using the **INSERT_UPDATE** option, requires one of the following:
 - *dataaccess* authority
 - CONTROL privilege on each participating table, view, or nickname
 - INSERT, SELECT, UPDATE and DELETE privilege on each participating table or view
- IMPORT to an existing table using the **REPLACE** or **REPLACE_CREATE** option, requires one of the following:
 - *dataaccess* authority
 - CONTROL privilege on the table or view
 - INSERT, SELECT, and DELETE privilege on the table or view
- IMPORT to a new table using the **CREATE** or **REPLACE_CREATE** option, requires one of the following:
 - *dbadm* authority
 - CREATETAB authority on the database and USE privilege on the table space, as well as one of:
 - IMPLICIT_SCHEMA authority on the database, if the implicit or explicit schema name of the table does not exist
 - CREATEIN privilege on the schema, if the schema name of the table refers to an existing schema
- IMPORT to a hierarchy that does not exist using the **CREATE**, or the **REPLACE_CREATE** option, requires one of the following:
 - *dbadm* authority
 - CREATETAB authority on the database and USE privilege on the table space and one of:
 - IMPLICIT_SCHEMA authority on the database, if the schema name of the table does not exist
 - CREATEIN privilege on the schema, if the schema of the table exists
 - CONTROL privilege on every sub-table in the hierarchy, if the **REPLACE_CREATE** option on the entire hierarchy is used
- IMPORT to an existing hierarchy using the **REPLACE** option requires one of the following:
 - *dataaccess* authority
 - CONTROL privilege on every sub-table in the hierarchy

- To import data into a table that has protected columns, the session authorization ID must have LBAC credentials that allow write access to all protected columns in the table. Otherwise the import fails and an error (SQLSTATE 42512) is returned.
- To import data into a table that has protected rows, the session authorization ID must hold LBAC credentials that meet these criteria:
 - It is part of the security policy protecting the table
 - It was granted to the session authorization ID for write access

The label on the row to insert, the user’s LBAC credentials, the security policy definition, and the LBAC rules determine the label on the row.

- If the **REPLACE** or **REPLACE_CREATE** option is specified, the session authorization ID must have the authority to drop the table.
- To import data into a nickname, the session authorization ID must have the privilege to access and use a specified data source in pass-through mode.

Required connection

Database. If implicit connect is enabled, a connection to the default database is established. Utility access to Linux, UNIX, or Windows database servers from Linux, UNIX, or Windows clients must be a direct connection through the engine and not through a DB2 Connect gateway or loop back environment.

Command syntax

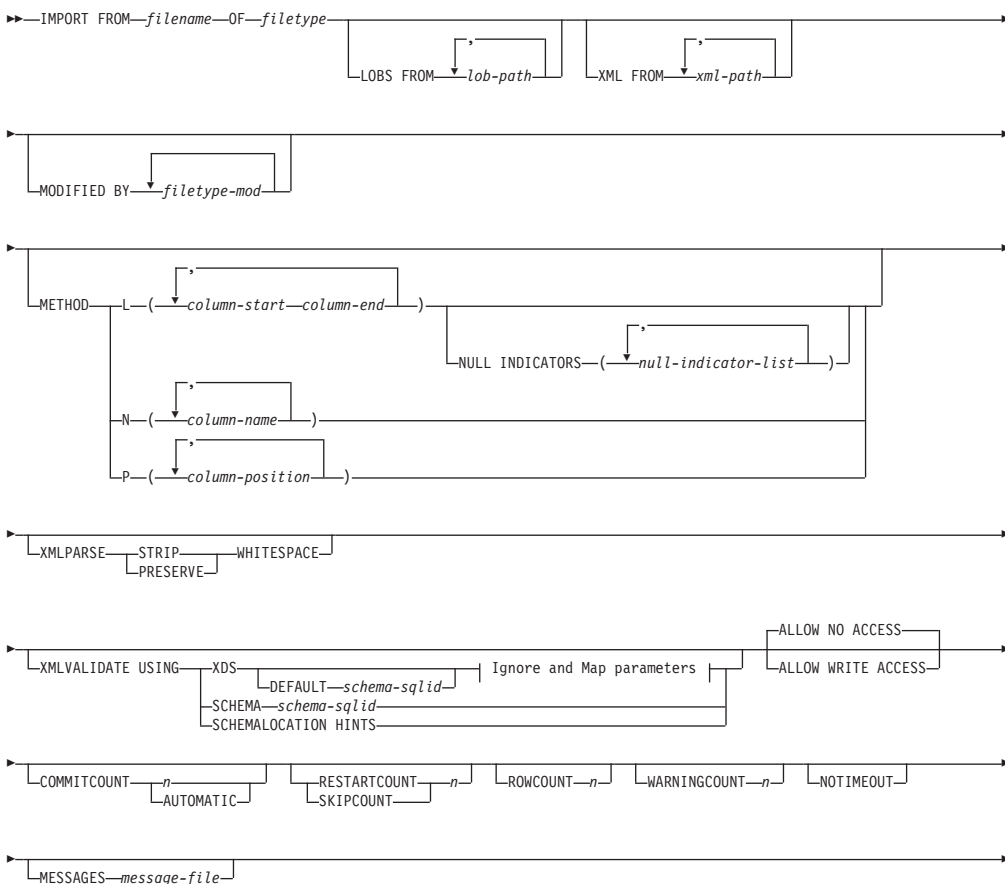

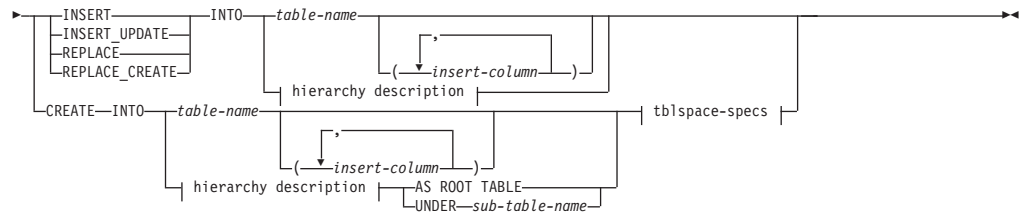

Ignore and Map parameters:

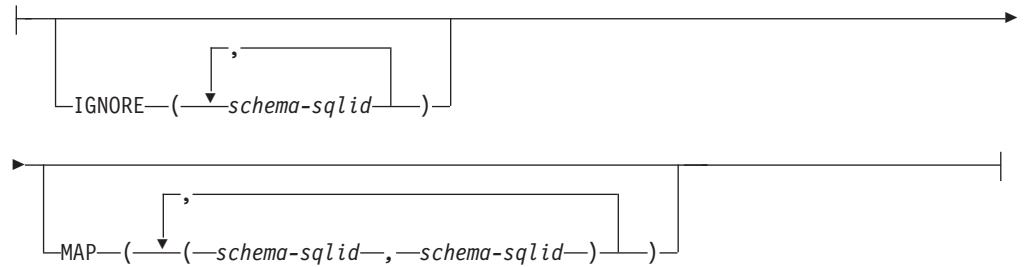

hierarchy description:



sub-table-list:

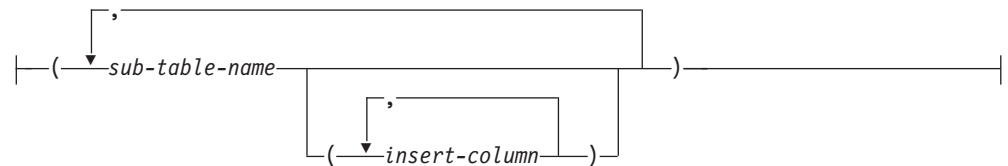

traversal-order-list:



tblspace-specs:

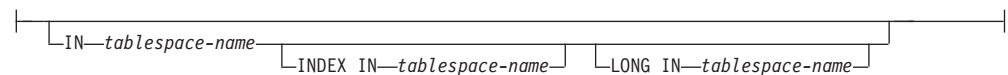

Command parameters

ALL TABLES

An implicit keyword for hierarchy only. When importing a hierarchy, the default is to import all tables specified in the traversal order.

ALLOW NO ACCESS

Runs import in the offline mode. An exclusive (X) lock on the target table is acquired before any rows are inserted. This prevents concurrent applications from accessing table data. This is the default import behavior.

ALLOW WRITE ACCESS

Runs import in the online mode. An intent exclusive (IX) lock on the target table is acquired when the first row is inserted. This allows concurrent readers and writers to access table data. Online mode is not compatible with the **REPLACE**, **CREATE**, or **REPLACE_CREATE** import options. Online mode is not supported in conjunction with buffered inserts. The import operation will periodically commit inserted data to prevent lock escalation to a table lock and to avoid running out of active log space. These commits will be performed even if the **COMMITCOUNT** option was not used. During each commit, import will lose its IX table lock, and will attempt to reacquire it after the commit. This parameter is required when you import to a nickname and **COMMITCOUNT** must be specified with a valid number (AUTOMATIC is not considered a valid option).

AS ROOT TABLE

Creates one or more sub-tables as a stand-alone table hierarchy.

COMMITCOUNT *n* | AUTOMATIC

Performs a COMMIT after every *n* records are imported. When a number *n* is specified, import performs a COMMIT after every *n* records are imported. When compound inserts are used, a user-specified commit frequency of *n* is rounded up to the first integer multiple of the compound count value. When AUTOMATIC is specified, import internally determines when a commit needs to be performed. The utility will commit for either one of two reasons:

- to avoid running out of active log space
- to avoid lock escalation from row level to table level

If the **ALLOW WRITE ACCESS** option is specified, and the **COMMITCOUNT** option is not specified, the import utility will perform commits as if **COMMITCOUNT AUTOMATIC** had been specified.

The ability of the import operation to avoid running out of active log space is affected by the DB2 registry variable

DB2_FORCE_APP_ON_MAX_LOG:

- If **DB2_FORCE_APP_ON_MAX_LOG** is set to FALSE and the **COMMITCOUNT AUTOMATIC** command option is specified, the import utility will be able to automatically avoid running out of active log space.
- If **DB2_FORCE_APP_ON_MAX_LOG** is set to FALSE and the **COMMITCOUNT *n*** command option is specified, the import utility will attempt to resolve the log full condition if it encounters an SQL0964C (Transaction Log Full) while inserting or updating a record. It will perform an unconditional commit and then will reattempt to insert or update the record. If this does not help resolve the issue (which would be the case when the log full is attributed to other activity on the database), then the IMPORT command will fail as expected, however the number of rows committed may not be a multiple of the **COMMITCOUNT *n*** value. To avoid processing the rows that were already committed when you retry the import operation, use the **RESTARTCOUNT** or **SKIPCOUNT** command parameters.

- If **DB2_FORCE_APP_ON_MAX_LOG** is set to **TRUE** (which is the default), the import operation will fail if it encounters an **SQL0964C** while inserting or updating a record. This can occur irrespective of whether you specify **COMMITCOUNT AUTOMATIC** or **COMMITCOUNT *n***.

The application is forced off the database and the current unit of work is rolled back. To avoid processing the rows that were already committed when you retry the import operation, use the **RESTARTCOUNT** or **SKIPCOUNT** command parameters.

CREATE

Note: The **CREATE** parameter is deprecated and may be removed in a future release. For additional details, see “IMPORT command options **CREATE** and **REPLACE_CREATE** are deprecated”.

Creates the table definition and row contents in the code page of the database. If the data was exported from a DB2 table, sub-table, or hierarchy, indexes are created. If this option operates on a hierarchy, and data was exported from DB2, a type hierarchy will also be created. This option can only be used with IXF files.

This parameter is not valid when you import to a nickname.

Note: If the data was exported from an MVS™ host database, and it contains **LONGVAR** fields whose lengths, calculated on the page size, are more than 254, **CREATE** might fail because the rows are too long. See “Imported table re-creation” for a list of restrictions. In this case, the table should be created manually, and **IMPORT** with **INSERT** should be invoked, or, alternatively, the **LOAD** command should be used.

DEFAULT *schema-sqlid*

This option can only be used when the **USING XDS** parameter is specified. The schema specified through the **DEFAULT** clause identifies a schema to use for validation when the XML Data Specifier (XDS) of an imported XML document does not contain an **SCH** attribute identifying an XML Schema.

The **DEFAULT** clause takes precedence over the **IGNORE** and **MAP** clauses. If an XDS satisfies the **DEFAULT** clause, the **IGNORE** and **MAP** specifications will be ignored.

FROM *filename*

Specifies the file that contains the data to be imported. If the path is omitted, the current working directory is used.

HIERARCHY

Specifies that hierarchical data is to be imported.

IGNORE *schema-sqlid*

This option can only be used when the **USING XDS** parameter is specified. The **IGNORE** clause specifies a list of one or more schemas to ignore if they are identified by an **SCH** attribute. If an **SCH** attribute exists in the XML Data Specifier for an imported XML document, and the schema identified by the **SCH** attribute is included in the list of schemas to ignore, then no schema validation will occur for the imported XML document.

If a schema is specified in the **IGNORE** clause, it cannot also be present in the left side of a schema pair in the **MAP** clause.

The **IGNORE** clause applies only to the XDS. A schema that is mapped by the **MAP** clause will not be subsequently ignored if specified by the **IGNORE** clause.

IN *tablespace-name*

Identifies the table space in which the table will be created. The table space must exist, and must be a REGULAR table space. If no other table space is specified, all table parts are stored in this table space. If this clause is not specified, the table is created in a table space created by the authorization ID. If none is found, the table is placed into the default table space USERSPACE1. If USERSPACE1 has been dropped, table creation fails.

INDEX IN *tablespace-name*

Identifies the table space in which any indexes on the table will be created. This option is allowed only when the primary table space specified in the **IN** clause is a DMS table space. The specified table space must exist, and must be a REGULAR or LARGE DMS table space.

Note: Specifying which table space will contain an index can only be done when the table is created.

insert-column

Specifies the name of a column in the table or the view into which data is to be inserted.

INSERT

Adds the imported data to the table without changing the existing table data.

INSERT_UPDATE

Adds rows of imported data to the target table, or updates existing rows (of the target table) with matching primary keys.

INTO *table-name*

Specifies the database table into which the data is to be imported. This table cannot be a system table, a created temporary table, a declared temporary table, or a summary table.

One can use an alias for **INSERT**, **INSERT_UPDATE**, or **REPLACE**, except in the case of an earlier server, when the fully qualified or the unqualified table name should be used. A qualified table name is in the form: *schema.tablename*. The *schema* is the user name under which the table was created.

LOBS FROM *lob-path*

Specifies one or more paths that store LOB files. The names of the LOB data files are stored in the main data file (ASC, DEL, or IXF), in the column that will be loaded into the LOB column. The maximum number of paths that can be specified is 999. This will implicitly activate the LOBSINFILE behavior.

This parameter is not valid when you import to a nickname.

LONG IN *tablespace-name*

Identifies the table space in which the values of any long columns (LONG VARCHAR, LONG VARGRAPHIC, LOB data types, or distinct types with any of these as source types) will be stored. This option is allowed only if the primary table space specified in the **IN** clause is a DMS table space. The table space must exist, and must be a LARGE DMS table space.

MAP *schema-sqlid*

This option can only be used when the **USING XDS** parameter is specified. Use the **MAP** clause to specify alternate schemas to use in place of those specified by the **SCH** attribute of an XML Data Specifier (XDS) for each imported XML document. The **MAP** clause specifies a list of one or more schema pairs, where each pair represents a mapping of one schema to another. The first schema in the pair represents a schema that is referred to by an **SCH** attribute in an XDS. The second schema in the pair represents the schema that should be used to perform schema validation.

If a schema is present in the left side of a schema pair in the **MAP** clause, it cannot also be specified in the **IGNORE** clause.

Once a schema pair mapping is applied, the result is final. The mapping operation is non-transitive, and therefore the schema chosen will not be subsequently applied to another schema pair mapping.

A schema cannot be mapped more than once, meaning that it cannot appear on the left side of more than one pair.

MESSAGES *message-file*

Specifies the destination for warning and error messages that occur during an import operation. If the file already exists, the import utility appends the information. If the complete path to the file is not specified, the utility uses the current directory and the default drive as the destination. If *message-file* is omitted, the messages are written to standard output.

METHOD

L Specifies the start and end column numbers from which to import data. A column number is a byte offset from the beginning of a row of data. It is numbered starting from 1.

Note: This method can only be used with ASC files, and is the only valid option for that file type.

N Specifies the names of the columns in the data file to be imported. The case of these column names must match the case of the corresponding names in the system catalogs. Each table column that is not nullable should have a corresponding entry in the **METHOD N** list. For example, given data fields F1, F2, F3, F4, F5, and F6, and table columns C1 INT, C2 INT NOT NULL, C3 INT NOT NULL, and C4 INT, method N (F2, F1, F4, F3) is a valid request, while method N (F2, F1) is not valid.

Note: This method can only be used with IXF files.

P Specifies the field numbers of the input data fields to be imported.

Note: This method can only be used with IXF or DEL files, and is the only valid option for the DEL file type.

MODIFIED BY *filetype-mod*

Specifies file type modifier options. See "File type modifiers for the import utility" on page 280.

NOTIMEOUT

Specifies that the import utility will not time out while waiting for locks. This option supersedes the **locktimeout** database configuration parameter. Other applications are not affected.

NULL INDICATORS *null-indicator-list*

This option can only be used when the **METHOD L** parameter is specified. That is, the input file is an ASC file. The null indicator list is a comma-separated list of positive integers specifying the column number of each null indicator field. The column number is the byte offset of the null indicator field from the beginning of a row of data. There must be one entry in the null indicator list for each data field defined in the **METHOD L** parameter. A column number of zero indicates that the corresponding data field always contains data.

A value of Y in the NULL indicator column specifies that the column data is NULL. Any character *other than* Y in the NULL indicator column specifies that the column data is not NULL, and that column data specified by the **METHOD L** option will be imported.

The NULL indicator character can be changed using the **MODIFIED BY** option, with the `nullindchar` file type modifier.

OF *filetype*

Specifies the format of the data in the input file:

- ASC (non-delimited ASCII format)
- DEL (delimited ASCII format), which is used by a variety of database manager and file manager programs
- WSF (work sheet format), which is used by programs such as:
 - Lotus 1-2-3
 - Lotus Symphony
- IXF (Integration Exchange Format, PC version) is a binary format that is used exclusively by DB2.

Important: Support for the WSF file format is deprecated and might be removed in a future release. It is recommended that you start using a supported file format instead of WSF files before support is removed.

The WSF file type is not supported when you import to a nickname.

REPLACE

Deletes all existing data from the table by truncating the data object, and inserts the imported data. The table definition and the index definitions are not changed. This option can only be used if the table exists. If this option is used when moving data between hierarchies, only the data for an entire hierarchy, not individual subtables, can be replaced.

This parameter is not valid when you import to a nickname.

This option does not honor the CREATE TABLE statement's NOT LOGGED INITIALLY (NLI) clause or the ALTER TABLE statement's ACTIVE NOT LOGGED INITIALLY clause.

If an import with the **REPLACE** option is performed within the same transaction as a CREATE TABLE or ALTER TABLE statement where the NLI clause is invoked, the import will not honor the NLI clause. All inserts will be logged.

Workaround 1

Delete the contents of the table using the DELETE statement, then invoke the import with INSERT statement

Workaround 2

Drop the table and recreate it, then invoke the import with INSERT statement.

This limitation applies to DB2 Universal Database Version 7 and DB2 UDB Version 8

REPLACE_CREATE

Note: The **REPLACE_CREATE** parameter is deprecated and may be removed in a future release. For additional details, see “IMPORT command options CREATE and REPLACE_CREATE are deprecated”.

If the table exists, deletes all existing data from the table by truncating the data object, and inserts the imported data without changing the table definition or the index definitions.

If the table does not exist, creates the table and index definitions, as well as the row contents, in the code page of the database. See *Imported table re-creation* for a list of restrictions.

This option can only be used with IXF files. If this option is used when moving data between hierarchies, only the data for an entire hierarchy, not individual subtables, can be replaced.

This parameter is not valid when you import to a nickname.

RESTARTCOUNT *n*

Specifies that an import operation is to be started at record *n*+1. The first *n* records are skipped. This option is functionally equivalent to **SKIPCOUNT**. **RESTARTCOUNT** and **SKIPCOUNT** are mutually exclusive.

ROWCOUNT *n*

Specifies the number *n* of physical records in the file to be imported (inserted or updated). Allows a user to import only *n* rows from a file, starting from the record determined by the **SKIPCOUNT** or **RESTARTCOUNT** options. If the **SKIPCOUNT** or **RESTARTCOUNT** options are not specified, the first *n* rows are imported. If **SKIPCOUNT** *m* or **RESTARTCOUNT** *m* is specified, rows *m*+1 to *m*+*n* are imported. When compound inserts are used, user specified **ROWCOUNT** *n* is rounded up to the first integer multiple of the compound count value.

SKIPCOUNT *n*

Specifies that an import operation is to be started at record *n*+1. The first *n* records are skipped. This option is functionally equivalent to **RESTARTCOUNT**. **SKIPCOUNT** and **RESTARTCOUNT** are mutually exclusive.

STARTING *sub-table-name*

A keyword for hierarchy only, requesting the default order, starting from *sub-table-name*. For PC/IXF files, the default order is the order stored in the input file. The default order is the only valid order for the PC/IXF file format.

sub-table-list

For typed tables with the **INSERT** or the **INSERT_UPDATE** option, a list of sub-table names is used to indicate the sub-tables into which data is to be imported.

traversal-order-list

For typed tables with the **INSERT**, **INSERT_UPDATE**, or the **REPLACE**

option, a list of sub-table names is used to indicate the traversal order of the importing sub-tables in the hierarchy.

UNDER *sub-table-name*

Specifies a parent table for creating one or more sub-tables.

WARNINGCOUNT *n*

Stops the import operation after *n* warnings. Set this parameter if no warnings are expected, but verification that the correct file and table are being used is desired. If the import file or the target table is specified incorrectly, the import utility will generate a warning for each row that it attempts to import, which will cause the import to fail. If *n* is zero, or this option is not specified, the import operation will continue regardless of the number of warnings issued.

XML FROM *xml-path*

Specifies one or more paths that contain the XML files.

XMLPARSE

Specifies how XML documents are parsed. If this option is not specified, the parsing behavior for XML documents will be determined by the value of the CURRENT XMLPARSE OPTION special register.

STRIP WHITESPACE

Specifies to remove whitespace when the XML document is parsed.

PRESERVE WHITESPACE

Specifies not to remove whitespace when the XML document is parsed.

XMLVALIDATE

Specifies that XML documents are validated against a schema, when applicable.

USING XDS

XML documents are validated against the XML schema identified by the XML Data Specifier (XDS) in the main data file. By default, if the **XMLVALIDATE** option is invoked with the **USING XDS** clause, the schema used to perform validation will be determined by the SCH attribute of the XDS. If an SCH attribute is not present in the XDS, no schema validation will occur unless a default schema is specified by the **DEFAULT** clause.

The **DEFAULT**, **IGNORE**, and **MAP** clauses can be used to modify the schema determination behavior. These three optional clauses apply directly to the specifications of the XDS, and not to each other. For example, if a schema is selected because it is specified by the **DEFAULT** clause, it will not be ignored if also specified by the **IGNORE** clause. Similarly, if a schema is selected because it is specified as the first part of a pair in the **MAP** clause, it will not be re-mapped if also specified in the second part of another **MAP** clause pair.

USING SCHEMA *schema-sqlid*

XML documents are validated against the XML schema with the specified SQL identifier. In this case, the SCH attribute of the XML Data Specifier (XDS) will be ignored for all XML columns.

USING SCHEMALOCATION HINTS

XML documents are validated against the schemas identified by XML schema location hints in the source XML documents. If a

schemaLocation attribute is not found in the XML document, no validation will occur. When the **USING SCHEMALOCATION HINTS** clause is specified, the SCH attribute of the XML Data Specifier (XDS) will be ignored for all XML columns.

See examples of the **XMLVALIDATE** option below.

Examples

Example 1

The following example shows how to import information from myfile.ixf to the STAFF table:

```
db2 import from myfile.ixf of ixf messages msg.txt insert into staff

SQL3150N The H record in the PC/IXF file has product "DB2 01.00", date
"19970220", and time "140848".

SQL3153N The T record in the PC/IXF file has name "myfile",
qualifier " ", and source " ".

SQL3109N The utility is beginning to load data from file "myfile".

SQL3110N The utility has completed processing. "58" rows were read
from the input file.

SQL3221W ...Begin COMMIT WORK. Input Record Count = "58".

SQL3222W ...COMMIT of any database changes was successful.

SQL3149N "58" rows were processed from the input file. "58" rows were
successfully inserted into the table. "0" rows were rejected.
```

Example 2 (Importing into a table with an identity column)

TABLE1 has 4 columns:

- C1 VARCHAR(30)
- C2 INT GENERATED BY DEFAULT AS IDENTITY
- C3 DECIMAL(7,2)
- C4 CHAR(1)

TABLE2 is the same as TABLE1, except that C2 is a GENERATED ALWAYS identity column.

Data records in DATAFILE1 (DEL format):

```
"Liszt"
"Hummel",,187.43, H
"Grieg",100, 66.34, G
"Satie",101, 818.23, I
```

Data records in DATAFILE2 (DEL format):

```
"Liszt", 74.49, A
"Hummel", 0.01, H
"Grieg", 66.34, G
"Satie", 818.23, I
```

The following command generates identity values for rows 1 and 2, since no identity values are supplied in DATAFILE1 for those rows. Rows 3 and 4, however, are assigned the user-supplied identity values of 100 and 101, respectively.

```
db2 import from datafile1.del of del replace into table1
```

To import DATAFILE1 into TABLE1 so that identity values are generated for all rows, issue one of the following commands:

```
db2 import from datafile1.del of del method P(1, 3, 4)
  replace into table1 (c1, c3, c4)
db2 import from datafile1.del of del modified by identityignore
  replace into table1
```

To import DATAFILE2 into TABLE1 so that identity values are generated for each row, issue one of the following commands:

```
db2 import from datafile2.del of del replace into table1 (c1, c3, c4)
db2 import from datafile2.del of del modified by identitymissing
  replace into table1
```

If DATAFILE1 is imported into TABLE2 without using any of the identity-related file type modifiers, rows 1 and 2 will be inserted, but rows 3 and 4 will be rejected, because they supply their own non-NULL values, and the identity column is GENERATED ALWAYS.

Examples of using the XMLVALIDATE clause

Example 1 (XMLVALIDATE USING XDS)

For the following XMLVALIDATE clause:

```
XMLVALIDATE USING XDS
  IGNORE (S1.SCHEMA_A)
  MAP ((S1.SCHEMA_A, S2.SCHEMA_B))
```

The import would fail due to invalid syntax, since the IGNORE of S1.SCHEMA_A would conflict with the MAP of S1.SCHEMA_A to S2.SCHEMA_B.

Example 2 (XMLVALIDATE USING XDS)

For the following XMLVALIDATE clause:

```
XMLVALIDATE USING XDS
  DEFAULT S8.SCHEMA_H
  IGNORE (S9.SCHEMA_I, S10.SCHEMA_J)
  MAP ((S1.SCHEMA_A, S2.SCHEMA_B), (S3.SCHEMA_C, S5.SCHEMA_E),
      (S6.SCHEMA_F, S3.SCHEMA_C), (S4.SCHEMA_D, S7.SCHEMA_G))
```

For an XML column that contains the following XDS:

```
<XDS FIL='xmlfile.001.xml' />
```

The XML schema with SQL identifier "S8.SCHEMA_H" is used to validate the document in file "xmlfile.001.xml", since "S8.SCHEMA_H" was specified as the default schema to use.

For an XML column that contains the following XDS:

```
<XDS FIL='xmlfile.002.xml' OFF='10' LEN='500' SCH='S10.SCHEMA_J' />
```

No schema validation occurs for the document in file "xmlfile.002.xml", since although the XDS specifies "S10.SCHEMA_J" as the schema to use, that schema is

part of the **IGNORE** clause. The document contents can be found at byte offset 10 in the file (meaning the 11th byte), and is 500 bytes long.

For an XML column that contains the following XDS:

```
<XDS FIL='xmlfile.003.xml' SCH='S6.SCHEMA_F' />
```

The XML schema with SQL identifier "S3.SCHEMA_C" is used to validate the document in file "xmlfile.003.xml". This is because the **MAP** clause specifies that schema "S6.SCHEMA_F" should be mapped to schema "S3.SCHEMA_C". Note that further mapping does not take place, therefore the mapping of schema "S3.SCHEMA_C" to schema "S5.SCHEMA_E" does not apply in this case.

For an XML column that contains the following XDS:

```
<XDS FIL='xmlfile.004.xml' SCH='S11.SCHEMA_K' />
```

The XML schema with SQL identifier "S11.SCHEMA_K" is used to validate the document in file "xmlfile.004.xml". Note that none of the **DEFAULT**, **IGNORE**, or **MAP** specifications apply in this case.

Example 3 (XMLVALIDATE USING XDS)

For the following **XMLVALIDATE** clause:

```
XMLVALIDATE USING XDS
  DEFAULT S1.SCHEMA_A
  IGNORE (S1.SCHEMA_A)
```

For an XML column that contains the following XDS:

```
<XDS FIL='xmlfile.001.xml' />
```

The XML schema with SQL identifier "S1.SCHEMA_A" is used to validate the document in file "xmlfile.001.xml", since "S1.SCHEMA_1" was specified as the default schema to use.

For an XML column that contains the following XDS:

```
<XDS FIL='xmlfile.002.xml' SCH='S1.SCHEMA_A' />
```

No schema validation occurs for the document in file "xmlfile.002", since although the XDS specifies "S1.SCHEMA_A" as the schema to use, that schema is part of the **IGNORE** clause.

Example 4 (XMLVALIDATE USING XDS)

For the following **XMLVALIDATE** clause:

```
XMLVALIDATE USING XDS
  DEFAULT S1.SCHEMA_A
  MAP ((S1.SCHEMA_A, S2.SCHEMA_B), (S2.SCHEMA_B, S1.SCHEMA_A))
```

For an XML column that contains the following XDS:

```
<XDS FIL='xmlfile.001.xml' />
```

The XML schema with SQL identifier "S1.SCHEMA_A" is used to validate the document in file "xmlfile.001.xml", since "S1.SCHEMA_1" was specified as the default schema to use. Note that since the **DEFAULT** clause was applied, the **MAP** clause is not subsequently applied. Therefore the mapping of schema "S1.SCHEMA_A" to schema "S2.SCHEMA_B" does not apply in this case.

For an XML column that contains the following XDS:

```
<XDS FIL='xmlfile.002.xml' SCH='S1.SCHEMA_A' />
```

The XML schema with SQL identifier "S2.SCHEMA_B" is used to validate the document in file "xmlfile.002.xml". This is because the **MAP** clause specifies that schema "S1.SCHEMA_A" should be mapped to schema "S2.SCHEMA_B". Note that further mapping does not take place, therefore the mapping of schema "S2.SCHEMA_B" to schema "S1.SCHEMA_A" does not apply in this case.

For an XML column that contains the following XDS:

```
<XDS FIL='xmlfile.003.xml' SCH='S2.SCHEMA_B' />
```

The XML schema with SQL identifier "S1.SCHEMA_A" is used to validate the document in file "xmlfile.003.xml". This is because the **MAP** clause specifies that schema "S2.SCHEMA_B" should be mapped to schema "S1.SCHEMA_A". Note that further mapping does not take place, therefore the mapping of schema "S1.SCHEMA_A" to schema "S2.SCHEMA_B" does not apply in this case.

Example 5 (XMLVALIDATE USING SCHEMA)

For the following **XMLVALIDATE** clause:

```
XMLVALIDATE USING SCHEMA S2.SCHEMA_B
```

For an XML column that contains the following XDS:

```
<XDS FIL='xmlfile.001.xml' />
```

The document in file xmlfile.001.xml is validated using the XML schema with SQL identifier "S2.SCHEMA_B".

For an XML column that contains the following XDS:

```
<XDS FIL='xmlfile.002.xml' SCH='S1.SCHEMA_A' />
```

The document in file "xmlfile.002.xml" is validated using the XML schema with SQL identifier "S2.SCHEMA_B". Note that the SCH attribute is ignored, since validation is being performed using a schema specified by the **USING SCHEMA** clause.

Example 6 (XMLVALIDATE USING SCHEMALOCATION HINTS)

For an XML column that contains the following XDS:

```
<XDS FIL='xmlfile.001.xml' />
```

The XML schema used is determined by the schemaLocation attribute in the document contents, and no validation would occur if one is not present.

For an XML column that contains the following XDS:

```
<XDS FIL='xmlfile.002.xml' SCH='S1.SCHEMA_A' />
```

The XML schema used is determined by the schemaLocation attribute in the document contents, and no validation would occur if one is not present. Note that the SCH attribute is ignored, since validation is being performed using **SCHEMALOCATION HINTS**.

Usage notes

Be sure to complete all table operations and release all locks before starting an import operation. This can be done by issuing a **COMMIT** after closing all cursors opened **WITH HOLD**, or by issuing a **ROLLBACK**.

The import utility adds rows to the target table using the SQL **INSERT** statement. The utility issues one **INSERT** statement for each row of data in the input file. If an **INSERT** statement fails, one of two actions result:

- If it is likely that subsequent **INSERT** statements can be successful, a warning message is written to the message file, and processing continues.
- If it is likely that subsequent **INSERT** statements will fail, and there is potential for database damage, an error message is written to the message file, and processing halts.

The utility performs an automatic **COMMIT** after the old rows are deleted during a **REPLACE** or a **REPLACE_CREATE** operation. Therefore, if the system fails, or the application interrupts the database manager after the table object is truncated, all of the old data is lost. Ensure that the old data is no longer needed before using these options.

If the log becomes full during a **CREATE**, **REPLACE**, or **REPLACE_CREATE** operation, the utility performs an automatic **COMMIT** on inserted records. If the system fails, or the application interrupts the database manager after an automatic **COMMIT**, a table with partial data remains in the database. Use the **REPLACE** or the **REPLACE_CREATE** option to rerun the whole import operation, or use **INSERT** with the **RESTARTCOUNT** parameter set to the number of rows successfully imported.

By default, automatic **COMMIT**s are not performed for the **INSERT** or the **INSERT_UPDATE** option. They are, however, performed if the **COMMITCOUNT** parameter is not zero. If automatic **COMMIT**s are not performed, a full log results in a **ROLLBACK**.

Offline import does not perform automatic **COMMIT**s if any of the following conditions is true:

- the target is a view, not a table
- compound inserts are used
- buffered inserts are used

By default, online import performs automatic **COMMIT**s to free both the active log space and the lock list. Automatic **COMMIT**s are not performed only if a **COMMITCOUNT** value of zero is specified.

Whenever the import utility performs a **COMMIT**, two messages are written to the message file: one indicates the number of records to be committed, and the other is written after a successful **COMMIT**. When restarting the import operation after a failure, specify the number of records to skip, as determined from the last successful **COMMIT**.

The import utility accepts input data with minor incompatibility problems (for example, character data can be imported using padding or truncation, and numeric data can be imported with a different numeric data type), but data with major incompatibility problems is not accepted.

You cannot **REPLACE** or **REPLACE_CREATE** an object table if it has any dependents other than itself, or an object view if its base table has any dependents (including itself). To replace such a table or a view, do the following:

1. Drop all foreign keys in which the table is a parent.
2. Run the import utility.
3. Alter the table to recreate the foreign keys.

If an error occurs while recreating the foreign keys, modify the data to maintain referential integrity.

Referential constraints and foreign key definitions are not preserved when recreating tables from PC/IXF files. (Primary key definitions *are* preserved if the data was previously exported using **SELECT ***.)

Importing to a remote database requires enough disk space on the server for a copy of the input data file, the output message file, and potential growth in the size of the database.

If an import operation is run against a remote database, and the output message file is very long (more than 60 KB), the message file returned to the user on the client might be missing messages from the middle of the import operation. The first 30 KB of message information and the last 30 KB of message information are always retained.

Importing PC/IXF files to a remote database is much faster if the PC/IXF file is on a hard drive rather than on diskettes.

The database table or hierarchy must exist before data in the **ASC**, **DEL**, or **WSF** file formats can be imported; however, if the table does not already exist, **IMPORT CREATE** or **IMPORT REPLACE_CREATE** creates the table when it imports data from a PC/IXF file. For typed tables, **IMPORT CREATE** can create the type hierarchy and the table hierarchy as well.

PC/IXF import should be used to move data (including hierarchical data) between databases. If character data containing row separators is exported to a delimited ASCII (DEL) file and processed by a text transfer program, fields containing the row separators will shrink or expand. The file copying step is not necessary if the source and the target databases are both accessible from the same client.

The data in ASC and DEL files is assumed to be in the code page of the client application performing the import. PC/IXF files, which allow for different code pages, are recommended when importing data in different code pages. If the PC/IXF file and the import utility are in the same code page, processing occurs as for a regular application. If the two differ, and the **FORCEIN** option is specified, the import utility assumes that data in the PC/IXF file has the same code page as the application performing the import. This occurs even if there is a conversion table for the two code pages. If the two differ, the **FORCEIN** option is not specified, and there is a conversion table, all data in the PC/IXF file will be converted from the file code page to the application code page. If the two differ, the **FORCEIN** option is not specified, and there is no conversion table, the import operation will fail. This applies only to PC/IXF files on DB2 clients on the AIX operating system.

For table objects on an 8 KB page that are close to the limit of 1012 columns, import of PC/IXF data files might cause DB2 to return an error, because the

maximum size of an SQL statement was exceeded. This situation can occur only if the columns are of type CHAR, VARCHAR, or CLOB. The restriction does not apply to import of DEL or ASC files. If PC/IXF files are being used to create a new table, an alternative is use db2look to dump the DDL statement that created the table, and then to issue that statement through the CLP.

DB2 Connect can be used to import data to DRDA servers such as DB2 for OS/390, DB2 for VM and VSE, and DB2 for OS/400. Only PC/IXF import (INSERT option) is supported. The RESTARTCOUNT parameter, but not the COMMITCOUNT parameter, is also supported.

When using the CREATE option with typed tables, create every sub-table defined in the PC/IXF file; sub-table definitions cannot be altered. When using options other than CREATE with typed tables, the traversal order list enables one to specify the traverse order; therefore, the traversal order list must match the one used during the export operation. For the PC/IXF file format, one need only specify the target sub-table name, and use the traverse order stored in the file.

The import utility can be used to recover a table previously exported to a PC/IXF file. The table returns to the state it was in when exported.

Data cannot be imported to a system table, a created temporary table, a declared temporary table, or a summary table.

Views cannot be created through the import utility.

Importing a multiple-part PC/IXF file whose individual parts are copied from a Windows system to an AIX system is supported. Only the name of the first file must be specified in the IMPORT command. For example, IMPORT FROM data.ixf OF IXF INSERT INTO TABLE1. The file data.002, etc should be available in the same directory as data.ixf.

On the Windows operating system:

- Importing logically split PC/IXF files is not supported.
- Importing bad format PC/IXF or WSF files is not supported.

Security labels in their internal format might contain newline characters. If you import the file using the DEL file format, those newline characters can be mistaken for delimiters. If you have this problem use the older default priority for delimiters by specifying the delprioritychar file type modifier in the IMPORT command.

Federated considerations

When using the IMPORT command and the INSERT, UPDATE, or INSERT_UPDATE command parameters, you must ensure that you have CONTROL privilege on the participating nickname. You must ensure that the nickname you want to use when doing an import operation already exists. There are also several restrictions you should be aware of as shown in the IMPORT command parameters section.

Some data sources, such as ODBC, do not support importing into nicknames.

File type modifiers for the import utility

Table 12. Valid file type modifiers for the import utility: All file formats

Modifier	Description
compound= <i>x</i>	<p><i>x</i> is a number between 1 and 100 inclusive. Uses nonatomic compound SQL to insert the data, and <i>x</i> statements will be attempted each time.</p> <p>If this modifier is specified, and the transaction log is not sufficiently large, the import operation will fail. The transaction log must be large enough to accommodate either the number of rows specified by COMMITCOUNT, or the number of rows in the data file if COMMITCOUNT is not specified. It is therefore recommended that the COMMITCOUNT option be specified to avoid transaction log overflow.</p> <p>This modifier is incompatible with INSERT_UPDATE mode, hierarchical tables, and the following modifiers: usedefaults, identitymissing, identityignore, generatedmissing, and generatedignore.</p>
generatedignore	This modifier informs the import utility that data for all generated columns is present in the data file but should be ignored. This results in all values for the generated columns being generated by the utility. This modifier cannot be used with the generatedmissing modifier.
generatedmissing	If this modifier is specified, the utility assumes that the input data file contains no data for the generated columns (not even NULLs), and will therefore generate a value for each row. This modifier cannot be used with the generatedignore modifier.
identityignore	This modifier informs the import utility that data for the identity column is present in the data file but should be ignored. This results in all identity values being generated by the utility. The behavior will be the same for both GENERATED ALWAYS and GENERATED BY DEFAULT identity columns. This means that for GENERATED ALWAYS columns, no rows will be rejected. This modifier cannot be used with the identitymissing modifier.
identitymissing	If this modifier is specified, the utility assumes that the input data file contains no data for the identity column (not even NULLs), and will therefore generate a value for each row. The behavior will be the same for both GENERATED ALWAYS and GENERATED BY DEFAULT identity columns. This modifier cannot be used with the identityignore modifier.
lobsinfile	<p><i>lob-path</i> specifies the path to the files containing LOB data.</p> <p>Each path contains at least one file that contains at least one LOB pointed to by a Lob Location Specifier (LLS) in the data file. The LLS is a string representation of the location of a LOB in a file stored in the LOB file path. The format of an LLS is <i>filename.ext.nnn.mmm/</i>, where <i>filename.ext</i> is the name of the file that contains the LOB, <i>nnn</i> is the offset in bytes of the LOB within the file, and <i>mmm</i> is the length of the LOB in bytes. For example, if the string <i>db2exp.001.123.456/</i> is stored in the data file, the LOB is located at offset 123 in the file <i>db2exp.001</i>, and is 456 bytes long.</p> <p>The LOBS FROM clause specifies where the LOB files are located when the "lobsinfile" modifier is used. The LOBS FROM clause will implicitly activate the LOBSINFILE behavior. The LOBS FROM clause conveys to the IMPORT utility the list of paths to search for the LOB files while importing the data.</p> <p>To indicate a null LOB, enter the size as -1. If the size is specified as 0, it is treated as a 0 length LOB. For null LOBS with length of -1, the offset and the file name are ignored. For example, the LLS of a null LOB might be <i>db2exp.001.7.-1/</i>.</p>
no_type_id	Valid only when importing into a single sub-table. Typical usage is to export data from a regular table, and then to invoke an import operation (using this modifier) to convert the data into a single sub-table.

Table 12. Valid file type modifiers for the import utility: All file formats (continued)

Modifier	Description
nodefaults	<p>If a source column for a target table column is not explicitly specified, and the table column is not nullable, default values are not loaded. Without this option, if a source column for one of the target table columns is not explicitly specified, one of the following occurs:</p> <ul style="list-style-type: none"> • If a default value can be specified for a column, the default value is loaded • If the column is nullable, and a default value cannot be specified for that column, a NULL is loaded • If the column is not nullable, and a default value cannot be specified, an error is returned, and the utility stops processing.
norowwarnings	<p>Suppresses all warnings about rejected rows.</p>
rowchangetimestampignore	<p>This modifier informs the import utility that data for the row change timestamp column is present in the data file but should be ignored. This results in all ROW CHANGE TIMESTAMP being generated by the utility. The behavior will be the same for both GENERATED ALWAYS and GENERATED BY DEFAULT columns. This means that for GENERATED ALWAYS columns, no rows will be rejected. This modifier cannot be used with the rowchangetimestamppmissing modifier.</p>
rowchangetimestamppmissing	<p>If this modifier is specified, the utility assumes that the input data file contains no data for the row change timestamp column (not even NULLs), and will therefore generate a value for each row. The behavior will be the same for both GENERATED ALWAYS and GENERATED BY DEFAULT columns. This modifier cannot be used with the rowchangetimestampignore modifier.</p>
seclabelchar	<p>Indicates that security labels in the input source file are in the string format for security label values rather than in the default encoded numeric format. IMPORT converts each security label into the internal format as it is loaded. If a string is not in the proper format the row is not loaded and a warning (SQLSTATE 01H53) is returned. If the string does not represent a valid security label that is part of the security policy protecting the table then the row is not loaded and a warning (SQLSTATE 01H53, SQLCODE SQL3243W) is returned.</p> <p>This modifier cannot be specified if the seclabelname modifier is specified, otherwise the import fails and an error (SQLCODE SQL3525N) is returned.</p>
seclabelname	<p>Indicates that security labels in the input source file are indicated by their name rather than the default encoded numeric format. IMPORT will convert the name to the appropriate security label if it exists. If no security label exists with the indicated name for the security policy protecting the table the row is not loaded and a warning (SQLSTATE 01H53, SQLCODE SQL3244W) is returned.</p> <p>This modifier cannot be specified if the seclabelchar modifier is specified, otherwise the import fails and an error (SQLCODE SQL3525N) is returned.</p> <p>Note: If the file type is ASC, any spaces following the name of the security label will be interpreted as being part of the name. To avoid this use the striptblanks file type modifier to make sure the spaces are removed.</p>

Table 12. Valid file type modifiers for the import utility: All file formats (continued)

Modifier	Description
usedefaults	<p>If a source column for a target table column has been specified, but it contains no data for one or more row instances, default values are loaded. Examples of missing data are:</p> <ul style="list-style-type: none"> • For DEL files: two adjacent column delimiters (",,") or two adjacent column delimiters separated by an arbitrary number of spaces (" , ") are specified for a column value. • For DEL/ASC/WSF files: A row that does not have enough columns, or is not long enough for the original specification. <p>Note: For ASC files, NULL column values are not considered explicitly missing, and a default will not be substituted for NULL column values. NULL column values are represented by all space characters for numeric, date, time, and /timestamp columns, or by using the NULL INDICATOR for a column of any type to indicate the column is NULL.</p> <p>Without this option, if a source column contains no data for a row instance, one of the following occurs:</p> <ul style="list-style-type: none"> • For DEL/ASC/WSF files: If the column is nullable, a NULL is loaded. If the column is not nullable, the utility rejects the row.

Table 13. Valid file type modifiers for the import utility: ASCII file formats (ASC/DEL)

Modifier	Description
codepage=x	<p>x is an ASCII character string. The value is interpreted as the code page of the data in the input data set. Converts character data from this code page to the application code page during the import operation.</p> <p>The following rules apply:</p> <ul style="list-style-type: none"> • For pure DBCS (graphic) mixed DBCS, and EUC, delimiters are restricted to the range of x00 to x3F, inclusive. • nullindchar must specify symbols included in the standard ASCII set between code points x20 and x7F, inclusive. This refers to ASCII symbols and code points. <p>Note:</p> <ol style="list-style-type: none"> 1. The codepage modifier cannot be used with the lobsinfile modifier. 2. If data expansion occurs when the code page is converted from the application code page to the database code page, the data might be truncated and loss of data can occur.
dateformat="x"	<p>x is the format of the date in the source file.² Valid date elements are:</p> <p>YYYY - Year (four digits ranging from 0000 - 9999) M - Month (one or two digits ranging from 1 - 12) MM - Month (two digits ranging from 1 - 12; mutually exclusive with M) D - Day (one or two digits ranging from 1 - 31) DD - Day (two digits ranging from 1 - 31; mutually exclusive with D) DDD - Day of the year (three digits ranging from 001 - 366; mutually exclusive with other day or month elements)</p> <p>A default value of 1 is assigned for each element that is not specified. Some examples of date formats are:</p> <p>"D-M-YYYY" "MM.DD.YYYY" "YYYYDDD"</p>

Table 13. Valid file type modifiers for the import utility: ASCII file formats (ASC/DEL) (continued)

Modifier	Description
implieddecimal	The location of an implied decimal point is determined by the column definition; it is no longer assumed to be at the end of the value. For example, the value 12345 is loaded into a DECIMAL(8,2) column as 123.45, <i>not</i> 12345.00.
timeformat="x"	<p>x is the format of the time in the source file.² Valid time elements are:</p> <ul style="list-style-type: none"> H - Hour (one or two digits ranging from 0 - 12 for a 12 hour system, and 0 - 24 for a 24 hour system) HH - Hour (two digits ranging from 0 - 12 for a 12 hour system, and 0 - 24 for a 24 hour system; mutually exclusive with H) M - Minute (one or two digits ranging from 0 - 59) MM - Minute (two digits ranging from 0 - 59; mutually exclusive with M) S - Second (one or two digits ranging from 0 - 59) SS - Second (two digits ranging from 0 - 59; mutually exclusive with S) SSSSS - Second of the day after midnight (5 digits ranging from 00000 - 86399; mutually exclusive with other time elements) TT - Meridian indicator (AM or PM) <p>A default value of 0 is assigned for each element that is not specified. Some examples of time formats are:</p> <pre> "HH:MM:SS" "HH.MM TT" "SSSSS" </pre>

Table 13. Valid file type modifiers for the import utility: ASCII file formats (ASC/DEL) (continued)

Modifier	Description
timestampformat="x"	<p>x is the format of the time stamp in the source file.² Valid time stamp elements are:</p> <ul style="list-style-type: none"> YYYY - Year (four digits ranging from 0000 - 9999) M - Month (one or two digits ranging from 1 - 12) MM - Month (two digits ranging from 01 - 12; mutually exclusive with M and MMM) MMM - Month (three-letter case-insensitive abbreviation for the month name; mutually exclusive with M and MM) D - Day (one or two digits ranging from 1 - 31) DD - Day (two digits ranging from 1 - 31; mutually exclusive with D) DDD - Day of the year (three digits ranging from 001 - 366; mutually exclusive with other day or month elements) H - Hour (one or two digits ranging from 0 - 12 for a 12 hour system, and 0 - 24 for a 24 hour system) HH - Hour (two digits ranging from 0 - 12 for a 12 hour system, and 0 - 24 for a 24 hour system; mutually exclusive with H) M - Minute (one or two digits ranging from 0 - 59) MM - Minute (two digits ranging from 0 - 59; mutually exclusive with M, minute) S - Second (one or two digits ranging from 0 - 59) SS - Second (two digits ranging from 0 - 59; mutually exclusive with S) SSSSS - Second of the day after midnight (5 digits ranging from 00000 - 86399; mutually exclusive with other time elements) U (1 to 12 times) <ul style="list-style-type: none"> - Fractional seconds(number of occurrences of U represent the number of digits with each digit ranging from 0 to 9) TT - Meridian indicator (AM or PM) <p>A default value of 1 is assigned for unspecified YYYY, M, MM, D, DD, or DDD elements. A default value of 'Jan' is assigned to an unspecified MMM element. A default value of 0 is assigned for all other unspecified elements. Following is an example of a time stamp format:</p> <pre style="margin-left: 40px;">"YYYY/MM/DD HH:MM:SS.UUUUUU"</pre> <p>The valid values for the MMM element include: 'jan', 'feb', 'mar', 'apr', 'may', 'jun', 'jul', 'aug', 'sep', 'oct', 'nov' and 'dec'. These values are case insensitive.</p> <p>The following example illustrates how to import data containing user defined date and time formats into a table called schedule:</p> <pre style="margin-left: 40px;">db2 import from delfile2 of del modified by timestampformat="yyyy.mm.dd hh:mm tt" insert into schedule</pre>

Table 13. Valid file type modifiers for the import utility: ASCII file formats (ASC/DEL) (continued)

Modifier	Description
usegraphiccodepage	<p>If usegraphiccodepage is given, the assumption is made that data being imported into graphic or double-byte character large object (DBCLOB) data fields is in the graphic code page. The rest of the data is assumed to be in the character code page. The graphic code page is associated with the character code page. IMPORT determines the character code page through either the codepage modifier, if it is specified, or through the code page of the application if the codepage modifier is not specified.</p> <p>This modifier should be used in conjunction with the delimited data file generated by drop table recovery only if the table being recovered has graphic data.</p> <p>Restrictions</p> <p>The usegraphiccodepage modifier MUST NOT be specified with DEL files created by the EXPORT utility, as these files contain data encoded in only one code page. The usegraphiccodepage modifier is also ignored by the double-byte character large objects (DBCLOBs) in files.</p>
xmlchar	<p>Specifies that XML documents are encoded in the character code page.</p> <p>This option is useful for processing XML documents that are encoded in the specified character code page but do not contain an encoding declaration.</p> <p>For each document, if a declaration tag exists and contains an encoding attribute, the encoding must match the character code page, otherwise the row containing the document will be rejected. Note that the character codepage is the value specified by the codepage file type modifier, or the application codepage if it is not specified. By default, either the documents are encoded in Unicode, or they contain a declaration tag with an encoding attribute.</p>
xmlgraphic	<p>Specifies that XML documents are encoded in the specified graphic code page.</p> <p>This option is useful for processing XML documents that are encoded in a specific graphic code page but do not contain an encoding declaration.</p> <p>For each document, if a declaration tag exists and contains an encoding attribute, the encoding must match the graphic code page, otherwise the row containing the document will be rejected. Note that the graphic code page is the graphic component of the value specified by the codepage file type modifier, or the graphic component of the application code page if it is not specified. By default, documents are either encoded in Unicode, or they contain a declaration tag with an encoding attribute.</p> <p>Note: If the xmlgraphic modifier is specified with the IMPORT command, the XML document to be imported must be encoded in the UTF-16 code page. Otherwise, the XML document may be rejected with a parsing error, or it may be imported into the table with data corruption.</p>

Table 14. Valid file type modifiers for the import utility: ASC (non-delimited ASCII) file format

Modifier	Description
nochecklengths	<p>If nochecklengths is specified, an attempt is made to import each row, even if the source data has a column definition that exceeds the size of the target table column. Such rows can be successfully imported if code page conversion causes the source data to shrink; for example, 4-byte EUC data in the source could shrink to 2-byte DBCS data in the target, and require half the space. This option is particularly useful if it is known that the source data will fit in all cases despite mismatched column definitions.</p>

Table 14. Valid file type modifiers for the import utility: ASC (non-delimited ASCII) file format (continued)

Modifier	Description
nullindchar= <i>x</i>	<p><i>x</i> is a single character. Changes the character denoting a null value to <i>x</i>. The default value of <i>x</i> is Y.³</p> <p>This modifier is case sensitive for EBCDIC data files, except when the character is an English letter. For example, if the null indicator character is specified to be the letter N, then n is also recognized as a null indicator.</p>
reclen= <i>x</i>	<p><i>x</i> is an integer with a maximum value of 32 767. <i>x</i> characters are read for each row, and a new-line character is not used to indicate the end of the row.</p>
striptblanks	<p>Truncates any trailing blank spaces when loading data into a variable-length field. If this option is not specified, blank spaces are kept.</p> <p>In the following example, <code>striptblanks</code> causes the import utility to truncate trailing blank spaces:</p> <pre>db2 import from myfile.asc of asc modified by striptblanks method 1 (1 10, 12 15) messages msgs.txt insert into staff</pre> <p>This option cannot be specified together with <code>striptnulls</code>. These are mutually exclusive options. This option replaces the obsolete <code>t</code> option, which is supported for earlier compatibility only.</p>
striptnulls	<p>Truncates any trailing NULLs (0x00 characters) when loading data into a variable-length field. If this option is not specified, NULLs are kept.</p> <p>This option cannot be specified together with <code>striptblanks</code>. These are mutually exclusive options. This option replaces the obsolete <code>padwithzero</code> option, which is supported for earlier compatibility only.</p>

Table 15. Valid file type modifiers for the import utility: DEL (delimited ASCII) file format

Modifier	Description
chardel <i>x</i>	<p><i>x</i> is a single character string delimiter. The default value is a double quotation mark ("). The specified character is used in place of double quotation marks to enclose a character string.³⁴ If you want to explicitly specify the double quotation mark as the character string delimiter, it should be specified as follows:</p> <pre>modified by chardel'"</pre> <p>The single quotation mark (') can also be specified as a character string delimiter. In the following example, <code>chardel'</code> causes the import utility to interpret any single quotation mark (') it encounters as a character string delimiter:</p> <pre>db2 "import from myfile.del of del modified by chardel'" method p (1, 4) insert into staff (id, years)"</pre>
coldel <i>x</i>	<p><i>x</i> is a single character column delimiter. The default value is a comma (.). The specified character is used in place of a comma to signal the end of a column.³⁴</p> <p>In the following example, <code>coldel;</code> causes the import utility to interpret any semicolon (;) it encounters as a column delimiter:</p> <pre>db2 import from myfile.del of del modified by coldel; messages msgs.txt insert into staff</pre>
decplusblank	<p>Plus sign character. Causes positive decimal values to be prefixed with a blank space instead of a plus sign (+). The default action is to prefix positive decimal values with a plus sign.</p>

Table 15. Valid file type modifiers for the import utility: DEL (delimited ASCII) file format (continued)

Modifier	Description
decptx	<p><i>x</i> is a single character substitute for the period as a decimal point character. The default value is a period (.). The specified character is used in place of a period as a decimal point character.³⁴</p> <p>In the following example, decpt; causes the import utility to interpret any semicolon (;) it encounters as a decimal point:</p> <pre>db2 "import from myfile.del of del modified by chardel'" decpt; messages msgs.txt insert into staff"</pre>
delprioritychar	<p>The current default priority for delimiters is: record delimiter, character delimiter, column delimiter. This modifier protects existing applications that depend on the older priority by reverting the delimiter priorities to: character delimiter, record delimiter, column delimiter. Syntax:</p> <pre>db2 import ... modified by delprioritychar ...</pre> <p>For example, given the following DEL data file:</p> <pre>"Smith, Joshua",4000,34.98<row delimiter> "Vincent,<row delimiter>, is a manager", 4005,44.37<row delimiter></pre> <p>With the delprioritychar modifier specified, there will be only two rows in this data file. The second <row delimiter> will be interpreted as part of the first data column of the second row, while the first and the third <row delimiter> are interpreted as actual record delimiters. If this modifier is <i>not</i> specified, there will be three rows in this data file, each delimited by a <row delimiter>.</p>
keepblanks	<p>Preserves the leading and trailing blanks in each field of type CHAR, VARCHAR, LONG VARCHAR, or CLOB. Without this option, all leading and trailing blanks that are not inside character delimiters are removed, and a NULL is inserted into the table for all blank fields.</p>
nochardel	<p>The import utility will assume all bytes found between the column delimiters to be part of the column's data. Character delimiters will be parsed as part of column data. This option should not be specified if the data was exported using DB2 (unless nochardel was specified at export time). It is provided to support vendor data files that do not have character delimiters. Improper usage might result in data loss or corruption.</p> <p>This option cannot be specified with chardelx, delprioritychar or nodoubledel. These are mutually exclusive options.</p>
nodoubledel	<p>Suppresses recognition of double character delimiters.</p>

Table 16. Valid file type modifiers for the import utility: IXF file format

Modifier	Description
forcein	<p>Directs the utility to accept data despite code page mismatches, and to suppress translation between code pages.</p> <p>Fixed length target fields are checked to verify that they are large enough for the data. If nochecklengths is specified, no checking is done, and an attempt is made to import each row.</p>
indexixf	<p>Directs the utility to drop all indexes currently defined on the existing table, and to create new ones from the index definitions in the PC/IXF file. This option can only be used when the contents of a table are being replaced. It cannot be used with a view, or when a <i>insert-column</i> is specified.</p>

Table 16. Valid file type modifiers for the import utility: IXF file format (continued)

Modifier	Description
indexschema= <i>schema</i>	Uses the specified <i>schema</i> for the index name during index creation. If <i>schema</i> is not specified (but the keyword <i>indexschema</i> is specified), uses the connection user ID. If the keyword is not specified, uses the schema in the IXF file.
nochecklengths	If <i>nochecklengths</i> is specified, an attempt is made to import each row, even if the source data has a column definition that exceeds the size of the target table column. Such rows can be successfully imported if code page conversion causes the source data to shrink; for example, 4-byte EUC data in the source could shrink to 2-byte DBCS data in the target, and require half the space. This option is particularly useful if it is known that the source data will fit in all cases despite mismatched column definitions.
forcecreate	Specifies that the table should be created with possible missing or limited information after returning SQL3311N during an import operation.

Table 17. IMPORT behavior when using codepage and usegraphiccodepage

codepage=N	usegraphiccodepage	IMPORT behavior
Absent	Absent	All data in the file is assumed to be in the application code page.
Present	Absent	All data in the file is assumed to be in code page N. Warning: Graphic data will be corrupted when imported into the database if N is a single-byte code page.
Absent	Present	Character data in the file is assumed to be in the application code page. Graphic data is assumed to be in the code page of the application graphic data. If the application code page is single-byte, then all data is assumed to be in the application code page. Warning: If the application code page is single-byte, graphic data will be corrupted when imported into the database, even if the database contains graphic columns.
Present	Present	Character data is assumed to be in code page N. Graphic data is assumed to be in the graphic code page of N. If N is a single-byte or double-byte code page, then all data is assumed to be in code page N. Warning: Graphic data will be corrupted when imported into the database if N is a single-byte code page.

Note:

1. The import utility does not issue a warning if an attempt is made to use unsupported file types with the **MODIFIED BY** option. If this is attempted, the import operation fails, and an error code is returned.
2. Double quotation marks around the date format string are mandatory. Field separators cannot contain any of the following: a-z, A-Z, and 0-9. The field separator should not be the same as the character delimiter or field delimiter in the DEL file format. A field separator is optional if the start and end

positions of an element are unambiguous. Ambiguity can exist if (depending on the modifier) elements such as D, H, M, or S are used, because of the variable length of the entries.

For time stamp formats, care must be taken to avoid ambiguity between the month and the minute descriptors, since they both use the letter M. A month field must be adjacent to other date fields. A minute field must be adjacent to other time fields. Following are some ambiguous time stamp formats:

```
"M" (could be a month, or a minute)
"M:M" (Which is which?)
"M:YYYY:M" (Both are interpreted as month.)
"S:M:YYYY" (adjacent to both a time value and a date value)
```

In ambiguous cases, the utility will report an error message, and the operation will fail.

Following are some unambiguous time stamp formats:

```
"M:YYYY" (Month)
"S:M" (Minute)
"M:YYYY:S:M" (Month...Minute)
"M:H:YYYY:M:D" (Minute...Month)
```

Some characters, such as double quotation marks and back slashes, must be preceded by an escape character (for example, \).

3. Character values provided for the `chardel`, `coldel`, or `decpt` file type modifiers must be specified in the code page of the source data.

The character code point (instead of the character symbol), can be specified using the syntax `xJJ` or `0xJJ`, where JJ is the hexadecimal representation of the code point. For example, to specify the # character as a column delimiter, use one of the following:

```
... modified by coldel# ...
... modified by coldel0x23 ...
... modified by coldelX23 ...
```

4. *Delimiter considerations for moving data* lists restrictions that apply to the characters that can be used as delimiter overrides.
5. The following file type modifiers are not allowed when importing into a nickname:
 - `indexixf`
 - `indexschema`
 - `dldelfiletype`
 - `nodefaults`
 - `usedefaults`
 - `no_type_idfiletype`
 - `generatedignore`
 - `generatedmissing`
 - `identityignore`
 - `identitymissing`
 - `lobsinfile`
6. The **WSF** file format is not supported for XML columns. Support for this file format is also deprecated and might be removed in a future release. It is recommended that you start using a supported file format instead of WSF files before support is removed
7. The **CREATE** mode is not supported for XML columns.

8. All XML data must reside in XML files that are separate from the main data file. An XML Data Specifier (XDS) (or a NULL value) must exist for each XML column in the main data file.
9. XML documents are assumed to be in Unicode format or to contain a declaration tag that includes an encoding attribute, unless the XMLCHAR or XMLGRAPHIC file type modifier is specified.
10. Rows containing documents that are not well-formed will be rejected.
11. If the **XMLVALIDATE** option is specified, documents that successfully validate against their matching schema will be annotated with the schema information as they are inserted. Rows containing documents that fail to validate against their matching schema will be rejected. To successfully perform the validation, the privileges held by the user invoking the import must include at least one of the following:
 - DBADM authority
 - USAGE privilege on the XML schema to be used in the validation
12. When importing into a table containing an implicitly hidden row change timestamp column, the implicitly hidden property of the column is not honoured. Therefore, the rowchangetimestampmissing file type modifier *must* be specified in the import command if data for the column is not present in the data to be imported and there is no explicit column list present.

Chapter 66. INITIALIZE TAPE

Initializes tapes for backup and restore operations to streaming tape devices. This command is only supported on Windows operating systems.

Authorization

One of the following:

- *sysadm*
- *sysctrl*
- *sysmaint*

Required connection

None

Command syntax

►►—INITIALIZE TAPE—┐┐
└ON—*device*┘ └USING—*blksize*┘

Command parameters

ON *device*

Specifies a valid tape device name. The default value is \\.\TAPE0.

USING *blksize*

Specifies the block size for the device, in bytes. The device is initialized to use the block size specified, if the value is within the supported range of block sizes for the device.

The buffer size specified for the BACKUP DATABASE command and for RESTORE DATABASE must be divisible by the block size specified here.

If a value for this parameter is not specified, the device is initialized to use its default block size. If a value of zero is specified, the device is initialized to use a variable length block size; if the device does not support variable length block mode, an error is returned.

When backing up to tape, use of a variable block size is currently not supported. If you must use this option, ensure that you have well tested procedures in place that enable you to recover successfully, using backup images that were created with a variable block size.

When using a variable block size, you must specify a backup buffer size that is less than or equal to the maximum limit for the tape devices that you are using. For optimal performance, the buffer size must be equal to the maximum block size limit of the device being used.

Chapter 67. INSPECT

Inspect database for architectural integrity, checking the pages of the database for page consistency. The INSPECT command checks that the structures of table objects and structures of table spaces are valid. Cross object validation conducts an online index to data consistency check.

Scope

In a single partition database environment, the scope is that single partition only. In a partitioned database environment, it is the collection of all logical partitions defined in `db2nodes.cfg`. For partitioned tables, the CHECK DATABASE and CHECK TABLESPACE options include individual data partitions and non-partitioned indexes. The CHECK TABLE option is also available for a partitioned table, however it will check all data partitions and indexes in a table, rather than checking a single data partition or index.

Authorization

For INSPECT CHECK, one of the following:

- *sysadm*
- *dbadm*
- *sysctrl*
- *sysmaint*
- CONTROL privilege if single table.

Required Connection

Database

Command Syntax

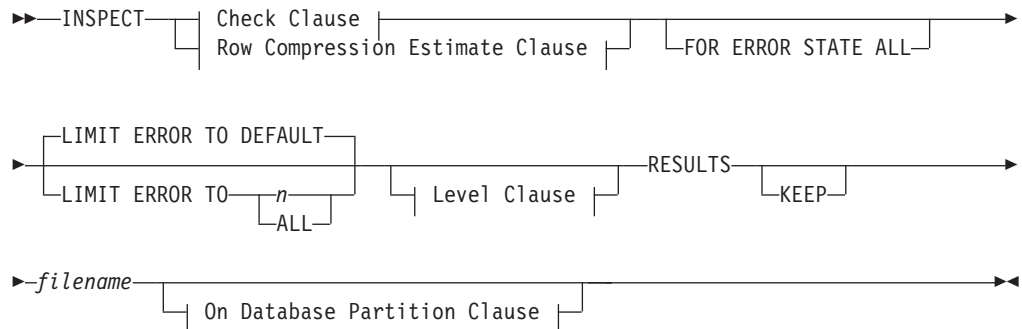

Check Clause:

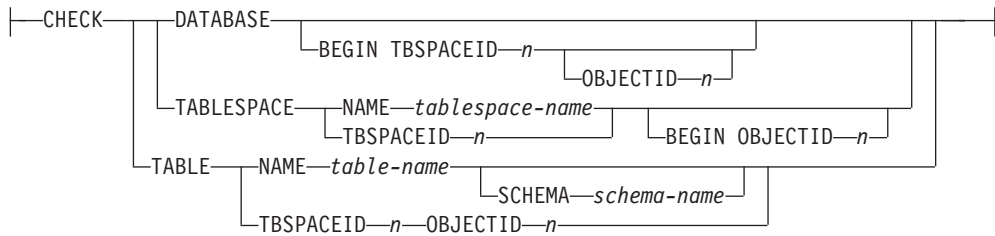

Row Compression Estimate Clause:

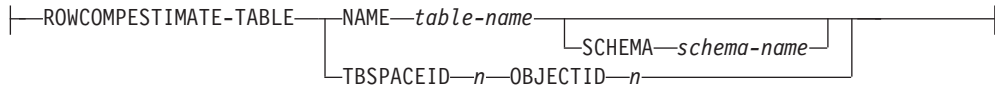

Level Clause:

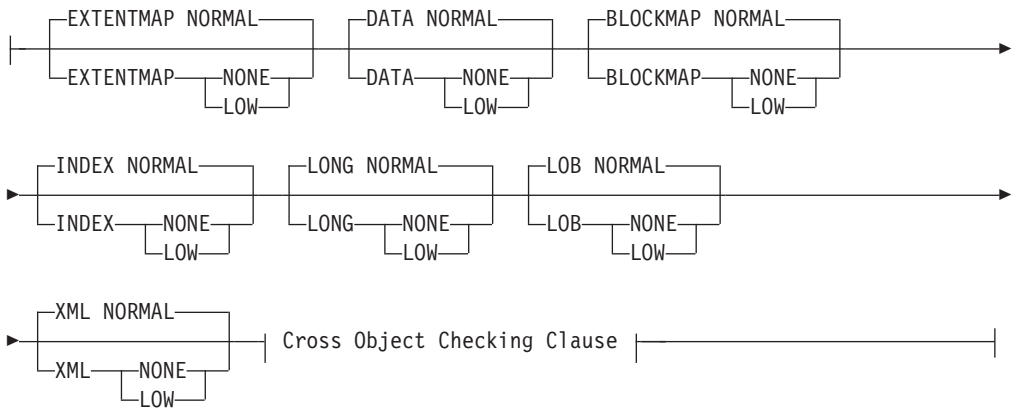

Cross Object Checking Clause:

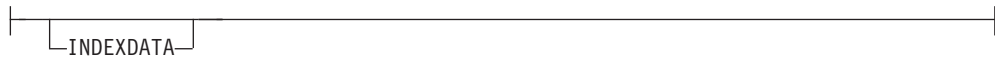

On Database Partition Clause:

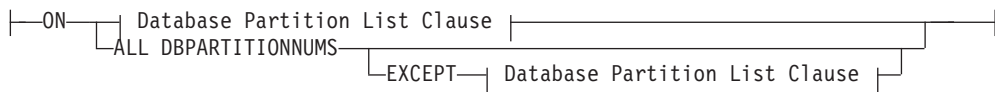

Database Partition List Clause:

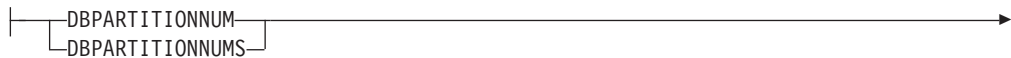

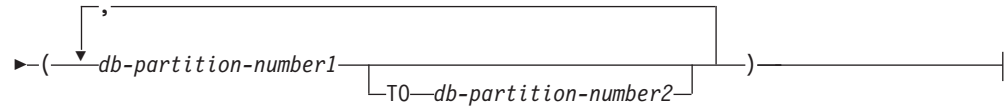

Command Parameters

CHECK

Specifies check processing.

DATABASE

Specifies whole database.

BEGIN TBSpaceID *n*

Specifies processing to begin from table space with given table space ID number.

OBJECTID *n*

Specifies processing to begin from table with given table space ID number and object ID number.

TABLESPACE

NAME *tablespace-name*

Specifies single table space with given table space name.

TBSpaceID *n*

Specifies single table space with given table space ID number.

BEGIN OBJECTID *n*

Specifies processing to begin from table with given object ID number.

TABLE

NAME *table-name*

Specifies table with given table name.

SCHEMA *schema-name*

Specifies schema name for specified table name for single table operation.

TBSpaceID *n* OBJECTID *n*

Specifies table with given table space ID number and object ID number.

ROWCOMPESTIMATE

Estimates the effectiveness of row compression for a table. You can also specify which database partition(s) this operation is to be done on.

This tool is capable of taking a sample of the table data, and building a dictionary from it. This dictionary can then be used to test compression against the records contained in the sample. From this test compression, data is gathered from which the following estimates are made:

- Percentage of bytes saved from compression
- Percentage of pages saved from compression
- Compression dictionary size
- Expansion dictionary size

INSPECT will insert the dictionary built for gathering these compression estimates if the COMPRESS YES attribute is set for this table, and a dictionary does not already exist for this table. INSPECT will attempt to insert the

dictionary concurrent to other applications accessing the table. Dictionary insert requires an Exclusive Table Alter lock and an Intent on Exclusive Table lock. INSPECT will only insert a dictionary into tables that support data row compression. For partitioned tables, a separate dictionary is built and inserted on each partition.

When sampling table row data and building a compression dictionary for a table, the INSPECT command supports only the table row data in the table object. If the table contains XML columns, data is not sampled and a compression dictionary is not built for the XML data in the XML storage object of the table.

The ROWCOMPESTIMATE option does not provide an index compression estimate. Use the table function instead.

RESULTS

Specifies the result output file. The file will be written out to the diagnostic data directory path. If there is no error found by the check processing, this result output file will be erased at the end of the INSPECT operation. If there are errors found by the check processing, this result output file will not be erased at the end of the INSPECT operation.

KEEP Specifies to always keep the result output file.

file-name

Specifies the name for the result output file. The file has to be created in the diagnostic data directory path.

ALL DBPARTITIONNUMS

Specifies that operation is to be done on all database partitions specified in the db2nodes.cfg file. This is the default if a node clause is not specified.

EXCEPT

Specifies that operation is to be done on all database partitions specified in the db2nodes.cfg file, except those specified in the node list.

ON DBPARTITIONNUM | ON DBPARTITIONNUMS

Perform operation on a set of database partitions.

db-partition-number1

Specifies a database partition number in the database partition list.

db-partition-number2

Specifies the second database partition number, so that all database partitions from *db-partition-number1* up to and including *db-partition-number2* are included in the database partition list.

FOR ERROR STATE ALL

For table object with internal state already indicating error state, the check will just report this status and not scan through the object. Specifying this option will have the processing scan through the object even if internal state already lists error state.

When used with the INDEXDATA option, as long as the index or data object is in an error state, the online index to data consistency checking will not be performed.

LIMIT ERROR TO *n*

Number of pages in error for an object to which reporting is limited. When this limit of the number of pages in error for an object is reached, the processing will discontinue the check on the rest of the object.

When used with the INDEXDATA option, *n* represents the number of errors to which reporting is limited during the online index to data consistency checking.

LIMIT ERROR TO DEFAULT

Default number of pages to limit error reporting for an object. This value is the extent size of the object. This parameter is the default.

When used with the INDEXDATA option, DEFAULT represents the default number of errors to which reporting is limited during the online index to data consistency checking.

LIMIT ERROR TO ALL

No limit on number of pages in error reported.

When used with the INDEXDATA option, ALL represents no limit on the number of errors reported during the online index to data consistency checking.

EXTENTMAP

NORMAL

Specifies processing level is normal for extent map. Default.

NONE

Specifies processing level is none for extent map.

LOW Specifies processing level is low for extent map.

DATA

NORMAL

Specifies processing level is normal for data object. Default.

NONE

Specifies processing level is none for data object.

LOW Specifies processing level is low for data object.

BLOCKMAP

NORMAL

Specifies processing level is normal for block map object. Default.

NONE

Specifies processing level is none for block map object.

LOW Specifies processing level is low for block map object.

INDEX

NORMAL

Specifies processing level is normal for index object. Default.

NONE

Specifies processing level is none for index object.

LOW Specifies processing level is low for index object.

LONG

NORMAL

Specifies processing level is normal for long object. Default.

NONE

Specifies processing level is none for long object.

LOW Specifies processing level is low for long object.

LOB

NORMAL

Specifies processing level is normal for LOB object. Default.

NONE

Specifies processing level is none for LOB object.

LOW

Specifies processing level is low for LOB object.

XML

NORMAL

Specifies processing level is normal for XML column object. Default. Pages of XML object will be checked for most inconsistencies. Actual XML data will not be inspected.

NONE

Specifies processing level is none for XML column object. XML object will not be inspected at all.

LOW

Specifies processing level is low for XML column object. Pages of XML object will be checked for some inconsistencies. Actual XML data will not be inspected.

INDEXDATA

Specified in order to perform an index to data consistency check. INDEXDATA checking is not performed by default.

Examples

- To perform an index to data consistency check that allows read/write access to all objects, even the object inspected at the moment, issue the following command:

```
inspect check table name fea3 indexdata results keep fea3high.out
```
- To perform an index to data consistency check that allows read or write access to all objects, including the object that is being currently inspected, issue:

```
INSPECT CHECK TABLE NAME car SCHEMA vps INDEXDATA RESULTS KEEP table1.out
```
- To estimate how much storage space will be saved if the data in a table named EMPLOYEE is compressed, issue:

```
INSPECT ROWCOMPESTIMATE TABLE NAME car SCHEMA vps RESULTS table2.out
```

Usage Notes

1. For CHECK operations on table objects, the level of processing can be specified for the objects. The default is NORMAL level, specifying NONE for an object excludes it. Specifying LOW will do subset of checks that are done for NORMAL.
2. The CHECK DATABASE option can be specified to start from a specific table space or from a specific table by specifying the ID value to identify the table space or the table.
3. The CHECK TABLESPACE option can be specified to start from a specific table by specifying the ID value to identify the table.
4. The processing of table spaces will affect only the objects that reside in the table space. The exception is when the INDEXDATA option is used. INDEXDATA will check index to data consistency as long as the index object resides in the table space. This means:

- If the data object resides in a different table space than the specified table space to be inspected where the index object resides, it can still benefit from the INDEXDATA checking.
 - For a partitioned table, each index can reside in a different table space. Only those indexes that reside in the specified table space will benefit from the index to data checking. If you want to inspect all the indexes against one table, please use the CHECK TABLE option or the CHECK DATABASE option.
5. The online inspect processing will access database objects using isolation level uncommitted read. COMMIT processing will be done during INSPECT processing. It is advisable to end the unit of work by issuing a COMMIT or ROLLBACK before invoking INSPECT.
 6. The online inspect check processing will write out unformatted inspection data results to the results file specified. The file will be written out to the diagnostic data directory path. If there is no error found by the check processing, this result output file will be erased at the end of INSPECT operation. If there are errors found by the check processing, this result output file will not be erased at the end of INSPECT operation. After check processing completes, to see inspection details, the inspection result data will require to be formatted out with the utility db2inspf. The results file will have file extension of the database partition number.
 7. In a partitioned database environment, each database partition will generate its own results output file with extension corresponding to its database partition number. The output location for the results output file will be the database manager diagnostic data directory path. If the name of a file that already exists is specified, the operation will not be processed, the file will have to be removed before that file name can be specified.
 8. Normal online inspect processing will access database objects using isolation level uncommitted read. Inserting a compression dictionary into the table will attempt to acquire write locks. Please refer to the ROWCOMPESTIMATE option for details on dictionary insert locking. Commit processing will be done during the inspect processing. It is advisable to end the unit of work by issuing a COMMIT or ROLLBACK before starting the inspect operation.
 9. The INDEXDATA option only examines the logical inconsistency between index and data. Therefore, it is recommended that you first run INDEX and DATA checking separately, to rule out any physical corruption, before running INDEXDATA checking.
 10. The INSPECT command, specified with the INDEXDATA parameter, performs an index to data consistency check while allowing read/write access to all objects/tables, even the one being inspected at the moment. The INSPECT INDEXDATA option includes the following inspections:
 - the existence of the data row for a given index entry.
 - a key to data value verification.
 When the INDEXDATA option is specified:
 - by default, only the values of explicitly specified level clause options will be used. For any level clause options which are not explicitly specified, the default levels will be overwritten from NORMAL to NONE. For instance, when INDEXDATA is the only level clause option specified, by default, only index to data checking will be performed.
 11. The BLOCKMAP option returns information that includes whether a block has been reclaimed for use by the table space following a reorganization to reclaim multidimensional clustering (MDC) table blocks that were empty.

Chapter 68. LIST ACTIVE DATABASES

Displays a subset of the information listed by the GET SNAPSHOT FOR ALL DATABASES command. An active database is available for connection and use by any application. For each active database, this command displays the following:

- Database name
- Number of applications currently connected to the database
- Database path.

Scope

This command can be issued from any database partition that is listed in \$HOME/sql1lib/db2nodes.cfg. It returns the same information from any of these database partitions.

Authorization

One of the following:

- *sysadm*
- *sysctrl*
- *sysmaint*
- *sysmon*

Command syntax

```
▶▶—LIST ACTIVE DATABASES—▶▶  
└─AT DBPARTITIONNUM—db-partition-number—┘  
└─GLOBAL—┘
```

Command parameters

AT DBPARTITIONNUM *db-partition-number*

Specifies the database partition for which the status of the monitor switches is to be displayed.

GLOBAL

Returns an aggregate result for all nodes in a partitioned database environment.

Examples

Following is sample output from the LIST ACTIVE DATABASES command:

Active Databases

```
Database name           = TEST  
Applications connected  = 0  
Database path           = /home/smith/smith/NODE0000/SQL00002/  
  
Database name           = SAMPLE  
Applications connected  = 1  
Database path           = /home/smith/smith/NODE0000/SQL00001/
```

Compatibilities

For compatibility with versions earlier than Version 8:

- The keyword `NODE` can be substituted for `DBPARTITIONNUM`.

Chapter 69. LIST APPLICATIONS

Displays to standard output the application program name, authorization ID (user name), application handle, application ID, and database name of all active database applications. This command can also optionally display an application's sequence number, status, status change time, and database path.

Scope

This command only returns information for the database partition on which it is issued.

Authorization

One of the following:

- *sysadm*
- *sysctrl*
- *sysmaint*
- *sysmon*

Required connection

Instance. To list applications for a remote instance, it is necessary to first attach to that instance.

Command syntax

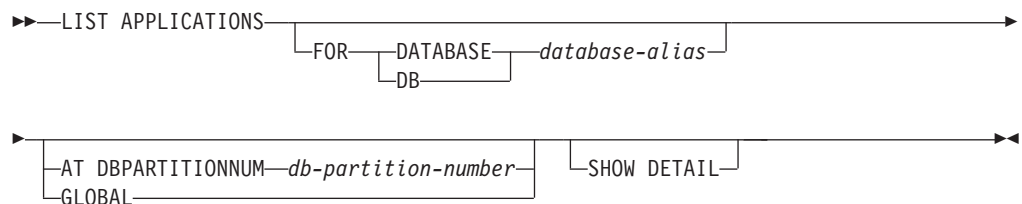

Command parameters

FOR DATABASE *database-alias*

Information for each application that is connected to the specified database is to be displayed. Database name information is not displayed. If this option is not specified, the command displays the information for each application that is currently connected to any database at the database partition to which the user is currently attached.

The default application information is comprised of the following:

- Authorization ID
- Application name
- Application handle
- Application ID
- Database name
- Number of agents

AT DBPARTITIONNUM *db-partition-number*

Specifies the database partition for which the status of the monitor switches is to be displayed.

GLOBAL

Returns an aggregate result for all database partitions in a partitioned database environment.

SHOW DETAIL

Some of the additional output information will include:

- CONNECT Auth ID
- Sequence number
- Coordinating DB partition number
- Coordinator pid/thread
- Status
- Status change time
- Node
- Database path

If this option is specified, it is recommended that the output be redirected to a file, and that the report be viewed with the help of an editor. The output lines might wrap around when displayed on the screen.

Examples

To list detailed information about the applications connected to the SAMPLE database, issue:

```
list applications for database sample show detail
```

Usage notes

The database administrator can use the output from this command as an aid to problem determination. In addition, this information is required if the database administrator wants to use the GET SNAPSHOT command or the FORCE APPLICATION command in an application.

To list applications at a remote instance (or a different local instance), it is necessary to first attach to that instance. If FOR DATABASE is specified when an attachment exists, and the database resides at an instance which differs from the current attachment, the command will fail.

LIST APPLICATIONS only shows user applications while LIST APPLICATIONS SHOW DETAIL shows all applications including the system applications. Event monitors are an example of system applications. System applications usually appear in snapshot output with application names beginning "db2" (e.g., db2stmm, db2taskd). For additional information, see the *Related links* section about the is_system_appl monitor element.

Compatibilities

For compatibility with versions earlier than Version 8:

- The keyword NODE can be substituted for DBPARTITIONNUM.

Chapter 70. LIST COMMAND OPTIONS

Lists the current settings for the environment variables:

- DB2BQTIME
- DB2DQTRY
- DB2RQTIME
- DB2IQTIME
- DB2OPTIONS.

Authorization

None

Required connection

None

Command syntax

▶—LIST COMMAND OPTIONS—▶

Command parameters

None

Examples

The following is sample output from LIST COMMAND OPTIONS:

Command Line Processor Option Settings

```
Backend process wait time (seconds)      (DB2BQTIME) = 1
No. of retries to connect to backend      (DB2BQTRY) = 60
Request queue wait time (seconds)        (DB2RQTIME) = 5
Input queue wait time (seconds)          (DB2IQTIME) = 5
Command options                          (DB2OPTIONS) =
```

Option	Description	Current Setting
-a	Display SQLCA	OFF
-c	Auto-Commit	ON
-d	XML declarations	OFF
-e	Display SQLCODE/SQLSTATE	OFF
-f	Read from input file	OFF
-l	Log commands in history file	OFF
-n	Remove new line character	OFF
-o	Display output	ON
-p	Display interactive input prompt	ON
-r	Save output to report file	OFF
-s	Stop execution on command error	OFF
-t	Set statement termination character	OFF
-v	Echo current command	OFF
-w	Display FETCH/SELECT warning messages	ON
-z	Save all output to output file	OFF

Chapter 71. LIST DATABASE DIRECTORY

Lists the contents of the system database directory. If a path is specified, the contents of the local database directory are listed.

Scope

If this command is issued without the ON *path* parameter, the system database directory is returned. This information is the same at all database partitions.

If the ON *path* parameter is specified, the local database directory on that path is returned. This information is not the same at all database partitions.

Authorization

None

Required connection

None. Directory operations affect the local directory only.

Command syntax

```

▶▶ LIST DATABASE DIRECTORY
      |         |
      |         └─ DB
      |
      └─ ON path
         |
         └─ drive
    
```

Command parameters

ON *path* | *drive*

Specifies the local database directory from which to list information. If not specified, the contents of the system database directory are listed. Note that the instance name is implied in the path. Please do not specify the instance name as part of the path.

Examples

The following shows sample output for a system database directory:

System Database Directory

Number of entries in the directory = 2

Database 1 entry:

Database alias	= SAMPLE
Database name	= SAMPLE
Local database directory	= /home/smith
Database release level	= 8.00
Comment	=
Directory entry type	= Indirect
Catalog database partition number	= 0
Alternate server hostname	= montero
Alternate server port number	= 29384

Database 2 entry:

Database alias	= TC004000
----------------	------------

```

Database name           = TC004000
Node name               = PRINODE
Database release level  = a.00
Comment                 =
Directory entry type    = LDAP
Catalog database partition number = -1
Gateway node name       = PRIGW
Alternate server node name =
Alternate server gateway node name = ALTGW

```

The following shows sample output for a local database directory:

```
Local Database Directory on /u/smith
```

```
Number of entries in the directory = 1
```

```
Database 1 entry:
```

```

Database alias          = SAMPLE
Database name           = SAMPLE
Database directory      = SQL00001
Database release level  = 8.00
Comment                 =
Directory entry type    = Home
Catalog database partition number = 0
Database partition number = 0

```

These fields are identified as follows:

Database alias

The value of the *alias* parameter when the database was created or cataloged. If an alias was not entered when the database was cataloged, the database manager uses the value of the *database-name* parameter when the database was cataloged.

Database name

The value of the *database-name* parameter when the database was cataloged. This name is usually the name under which the database was created.

Local database directory

The path on which the database resides. This field is filled in only if the system database directory has been scanned.

Database directory

The name of the directory where the database resides. This field is filled in only if the local database directory has been scanned.

Node name

The name of the remote node. This name corresponds to the value entered for the *nodename* parameter when the database and the node were cataloged.

Database release level

The release level of the database manager that can operate on the database.

Comment

Any comments associated with the database that were entered when it was cataloged.

Directory entry type

The location of the database:

- A *Remote* entry describes a database that resides on another node.

- An *Indirect* entry describes a database that is local. Databases that reside on the same node as the system database directory are thought to indirectly reference the home entry (to a local database directory), and are considered indirect entries.
- A *Home* entry indicates that the database directory is on the same path as the local database directory.
- An *LDAP* entry indicates that the database location information is stored on an LDAP server.

All entries in the system database directory are either remote or indirect. All entries in local database directories are identified in the system database directory as indirect entries.

Authentication

The authentication type cataloged at the client.

Principal name

Specifies a fully qualified Kerberos principal name.

Catalog database partition number

Specifies which node is the catalog database partition. This is the database partition on which the CREATE DATABASE command was issued.

Database partition number

Specifies the number that is assigned in db2nodes.cfg to the node where the command was issued.

Alternate server hostname

Specifies the host name or the IP address for the alternate server to be used when there is communication failure on the connection to the database. This field is displayed only for the system database directory.

Alternate server port number

Specifies the port number for the alternate server to be used when there is communication failure on the connection to the database. This field is displayed only for the system database directory.

Alternate server node name

If the directory entry type is LDAP, specifies the node name for the alternate server to be used when there is communication failure on the connection to the database.

Alternate server gateway node name

If the directory entry type is LDAP, specifies the gateway node name for the alternate gateway to be used when there is communication failure on the connection to the database.

Usage notes

There can be a maximum of eight opened database directory scans per process. To overcome this restriction for a batch file that issues more than eight LIST DATABASE DIRECTORY commands within a single DB2 session, convert the batch file into a shell script. The "db2" prefix generates a new DB2 session for each command.

Chapter 72. LIST DATABASE PARTITION GROUPS

Lists all database partition groups associated with the current database.

Scope

This command can be issued from any database partition that is listed in `$HOME/sql11ib/db2nodes.cfg`. It returns the same information from any of these database partitions.

Authorization

For the system catalogs `SYSCAT.DBPARTITIONGROUPS` and `SYSCAT.DBPARTITIONGROUPDEF`, one of the following is required:

- *sysadm*
- *sysctrl*
- *sysmaint*
- *sysmon*
- *dbadm*
- CONTROL privilege
- SELECT privilege.

Required connection

Database

Command syntax

```
▶▶—LIST DATABASE PARTITION GROUPS—┐—┘  
└SHOW DETAIL┘
```

Command parameters

SHOW DETAIL

Specifies that the output should include the following information:

- Distribution map ID
- Database partition number
- In-use flag

Examples

Following is sample output from the LIST DATABASE PARTITION GROUPS command:

```
DATABASE PARTITION GROUP NAME  
-----  
IBMCATGROUP  
IBMDEFAULTGROUP
```

2 record(s) selected.

Following is sample output from the LIST DATABASE PARTITION GROUPS SHOW DETAIL command:

DATABASE PARTITION GROUP NAME	PMAP_ID	DATABASE PARTITION NUMBER	IN_USE
IBMCATGROUP	0	0	Y
IBMDEFAULTGROUP	1	0	Y

2 record(s) selected.

The fields are identified as follows:

DATABASE PARTITION GROUP NAME

The name of the database partition group. The name is repeated for each database partition in the database partition group.

PMAP_ID

The ID of the distribution map. The ID is repeated for each database partition in the database partition group.

DATABASE PARTITION NUMBER

The number of the database partition.

IN_USE

One of four values:

- Y** The database partition is being used by the database partition group.
- D** The database partition is going to be dropped from the database partition group as a result of a REDISTRIBUTE DATABASE PARTITION GROUP operation. When the operation completes, the database partition will not be included in reports from LIST DATABASE PARTITION GROUPS.
- A** The database partition has been added to the database partition group but is not yet added to the distribution map. The containers for the table spaces in the database partition group have been added on this database partition. The value is changed to Y when the REDISTRIBUTE DATABASE PARTITION GROUP operation completes successfully.
- T** The database partition has been added to the database partition group, but is not yet added to the distribution map. The containers for the table spaces in the database partition group have not been added on this database partition. Table space containers must be added on the new database partition for each table space in the database partition group. The value is changed to A when containers have successfully been added.

Compatibilities

For compatibility with versions earlier than Version 8:

- The keyword NODEGROUPS can be substituted for DATABASE PARTITION GROUPS.

Chapter 73. LIST DBPARTITIONNUMS

Lists all database partitions associated with the current database.

Scope

This command can be issued from any database partition that is listed in `$HOME/sql1lib/db2nodes.cfg`. It returns the same information from any of these database partitions.

Authorization

None

Required connection

Database

Command syntax

```
▶▶—LIST DBPARTITIONNUMS—▶▶
```

Command parameters

None

Examples

Following is sample output from the LIST DBPARTITIONNUMS command:

```
DATABASE PARTITION NUMBER
-----
                                0
                                2
                                5
                                7
                                9
```

5 record(s) selected.

Compatibilities

For compatibility with versions earlier than Version 8:

- The keyword `NODES` can be substituted for `DBPARTITIONNUMS`.

Chapter 74. LIST DCS APPLICATIONS

Displays to standard output information about applications that are connected to host databases via DB2 Connect Enterprise Edition.

Authorization

One of the following:

- *sysadm*
- *sysctrl*
- *sysmaint*
- *sysmon*

Required connection

Instance. To list the DCS applications at a remote instance, it is necessary to first attach to that instance.

Command syntax

```
▶▶—LIST DCS APPLICATIONS—▶▶  
    —SHOW DETAIL—  
    —EXTENDED—
```

Command parameters

LIST DCS APPLICATIONS

The default application information includes:

- Host authorization ID (*username*)
- Application program name
- Application handle
- Outbound application ID (*luwid*).

SHOW DETAIL

Specifies that output include the following additional information:

- Client application ID
- Client sequence number
- Client database alias
- Client node name (*nname*)
- Client release level
- Client code page
- Outbound sequence number
- Host database name
- Host release level.

EXTENDED

Generates an extended report. This report includes all of the fields that are listed when the SHOW DETAIL option is specified, plus the following additional fields:

- DCS application status
- Status change time
- Client platform
- Client protocol
- Client code page
- Process ID of the client application
- Host coded character set ID (CCSID).

Note:

1. The application status field contains one of the following values:

connect pending - outbound

Denotes that the request to connect to a host database has been issued, and that DB2 Connect is waiting for the connection to be established.

waiting for request

Denotes that the connection to the host database has been established, and that DB2 Connect is waiting for an SQL statement from the client application.

waiting for reply

Denotes that the SQL statement has been sent to the host database.

2. The status change time is shown only if the System Monitor UOW switch was turned on during processing. Otherwise, Not Collected is shown.

Usage notes

The database administrator can use this command to match client application connections *to* the gateway with corresponding host connections *from* the gateway.

The database administrator can also use agent ID information to force specified applications off a DB2 Connect server.

Chapter 75. LIST DCS DIRECTORY

Lists the contents of the Database Connection Services (DCS) directory.

Authorization

None

Required connection

None

Command syntax

▶▶—LIST DCS DIRECTORY—▶▶

Command parameters

None

Examples

The following is sample output from LIST DCS DIRECTORY:

```
Database Connection Services (DCS) Directory
```

```
Number of entries in the directory = 1
```

```
DCS 1 entry:
```

```
Local database name           = DB2
Target database name          = DSN_DB_1
Application requestor name    =
DCS parameters                =
Comment                       = DB2/MVS Location name DSN_DB_1
DCS directory release level   = 0x0100
```

These fields are identified as follows:

Local database name

Specifies the local alias of the target host database. This corresponds to the *database-name* parameter entered when the host database was cataloged in the DCS directory.

Target database name

Specifies the name of the host database that can be accessed. This corresponds to the *target-database-name* parameter entered when the host database was cataloged in the DCS directory.

Application requester name

Specifies the name of the program residing on the application requester or server.

DCS parameters

String that contains the connection and operating environment parameters to use with the application requester. Corresponds to the parameter string

entered when the host database was cataloged. The string must be enclosed by double quotation marks, and the parameters must be separated by commas.

Comment

Describes the database entry.

DCS directory release level

Specifies the version number of the Distributed Database Connection Services[®] program under which the database was created.

Usage notes

The DCS directory is created the first time that the CATALOG DCS DATABASE command is invoked. It is maintained on the path/drive where DB2 was installed, and provides information about host databases that the workstation can access if the DB2 Connect program has been installed. The host databases can be:

- DB2 databases on OS/390 and z/OS host
- DB2 databases on System i hosts
- DB2 databases on VSE & VM hosts

Chapter 76. LIST DRDA INDOUBT TRANSACTIONS

Provides a list of transactions that are indoubt between DRDA requesters and DRDA servers. If DRDA commit protocols are being used, lists indoubt transactions between DRDA sync point managers.

Authorization

None

Required connection

Instance

Command syntax

```
▶▶—LIST DRDA INDOUBT TRANSACTIONS—┬──────────────────────────────────▶▶  
                                     └─WITH PROMPTING─┘
```

Command parameters

WITH PROMPTING

Indicates that indoubt transactions are to be processed. If this parameter is specified, an interactive dialog mode is initiated, permitting the user to commit or roll back indoubt transactions. If this parameter is not specified, indoubt transactions are written to the standard output device, and the interactive dialog mode is not initiated.

A forget option is not supported. Once the indoubt transaction is committed or rolled back, the transaction is automatically forgotten.

Interactive dialog mode permits the user to:

- List all indoubt transactions (enter 1)
- List indoubt transaction number *x* (enter 1, followed by a valid transaction number)
- Quit (enter q)
- Commit transaction number *x* (enter c, followed by a valid transaction number)
- Roll back transaction number *x* (enter r, followed by a valid transaction number).

A blank space must separate the command letter from its argument.

Before a transaction is committed or rolled back, the transaction data is displayed, and the user is asked to confirm the action.

Usage notes

DRDA indoubt transactions occur when communication is lost between coordinators and participants in distributed units of work. A distributed unit of work lets a user or application read and update data at multiple locations within a single unit of work. Such work requires a two-phase commit.

The first phase requests all the participants to prepare for a commit. The second phase commits or rolls back the transactions. If a coordinator or participant becomes unavailable after the first phase, the distributed transactions are indoubt.

Before issuing the LIST DRDA INDOUBT TRANSACTIONS command, the application process must be connected to the DB2 sync point manager (SPM) instance. Use the **spm_name** database manager configuration parameter as the *dbalias* on the CONNECT statement.

TCP/IP connections, using the SPM to coordinate commits, use DRDA two-phase commit protocols.

Chapter 77. LIST HISTORY

Lists entries in the history file. The history file contains a record of recovery and administrative events. Recovery events include full database and table space level backup, incremental backup, restore, and rollforward operations. Additional logged events include create, alter, drop, or rename table space, reorganize table, drop table, and load.

Authorization

None

Required connection

Instance. You must attach to any remote database in order to run this command against it. For a local database, an explicit attachment is not required.

Command syntax

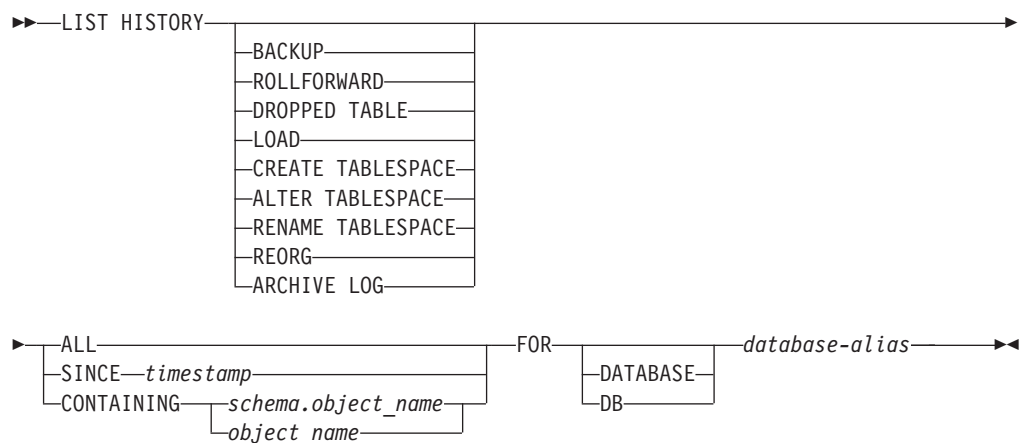

Command parameters

HISTORY

Lists all events that are currently logged in the history file.

BACKUP

Lists backup and restore operations.

ROLLFORWARD

Lists rollforward operations.

DROPPED TABLE

Lists dropped table records. A dropped table record is created only when the table is dropped and the table space containing it has the DROPPED TABLE RECOVERY option enabled. Returns the CREATE TABLE syntax for partitioned tables and indicates which table spaces contained data for the table that was dropped.

LOAD

Lists load operations.

CREATE TABLESPACE

Lists table space create and drop operations.

RENAME TABLESPACE

Lists table space renaming operations.

REORG

Lists reorganization operations. Includes information for each reorganized data partition of a partitioned table.

ALTER TABLESPACE

Lists alter table space operations.

ARCHIVE LOG

Lists archive log operations and the archived logs.

ALL Lists all entries of the specified type in the history file.

SINCE *timestamp*

A complete time stamp (format *yyyymmddhhmmss*), or an initial prefix (minimum *yyyy*) can be specified. All entries with time stamps equal to or greater than the time stamp provided are listed.

CONTAINING *schema.object_name*

This qualified name uniquely identifies a table.

CONTAINING *object_name*

This unqualified name uniquely identifies a table space.

FOR DATABASE *database-alias*

Used to identify the database whose recovery history file is to be listed.

Examples

```
db2 list history since 19980201 for sample
db2 list history backup containing userspace1 for sample
db2 list history dropped table all for db sample
db2 -v "list history reorg all for wsdb"
```

```
Op Obj Timestamp+Sequence Type Dev Earliest Log Current Log Backup ID
-----
G T 20080924101408 N S0000000.LOG S0000000.LOG
-----
```

Table: "ZHMFENG"."T1"

```
-----
Comment: REORG RECALIM
Start Time: 20080924101408
End Time: 20080924101409
Status: A
```

Usage notes

The SYSIBMADM.DB_HISTORY administrative view can be used to retrieve data from all database partitions.

The report generated by this command contains the following symbols:

Operation

- A - Create table space
- B - Backup
- C - Load copy
- D - Dropped table
- F - Roll forward

- G - Reorganize table
- L - Load
- N - Rename table space
- O - Drop table space
- Q - Quiesce
- R - Restore
- T - Alter table space
- U - Unload
- X - Archive log

Type

Archive Log types:

- P - Primary log path
- M - Secondary (mirror) log path
- N - Archive log command
- F - Failover archive path
- 1 - Primary log archive method
- 2 - Secondary log archive method

Backup types:

- F - Offline
- N - Online
- I - Incremental offline
- O - Incremental online
- D - Delta offline
- E - Delta online
- R - Rebuild

Rollforward types:

- E - End of logs
- P - Point in time

Load types:

- I - Insert
- R - Replace

Alter table space types:

- C - Add containers
- R - Rebalance

Quiesce types:

- S - Quiesce share
- U - Quiesce update
- X - Quiesce exclusive
- Z - Quiesce reset

Chapter 78. LIST INDOUBT TRANSACTIONS

Provides a list of transactions that are indoubt. The user can interactively commit, roll back, or forget the indoubt transactions.

The two-phase commit protocol comprises:

1. The PREPARE phase, in which the resource manager writes the log pages to disk, so that it can respond to either a COMMIT or a ROLLBACK primitive
2. The COMMIT (or ROLLBACK) phase, in which the transaction is actually committed or rolled back.

Forgetting a transaction releases resources held by a heuristically completed transaction (that is, one that has been committed or rolled back heuristically). An indoubt transaction is one which has been prepared, but not yet committed or rolled back.

Scope

This command returns a list of indoubt transactions on the executed node.

Authorization

None

Required connection

Database. If implicit connect is enabled, a connection to the default database is established.

Command syntax

►►—LIST INDOUBT TRANSACTIONS—
└──WITH PROMPTING──┘

Command parameters

WITH PROMPTING

Indicates that indoubt transactions are to be processed. If this parameter is specified, an interactive dialog mode is initiated, permitting the user to commit, roll back, or forget indoubt transactions. If this parameter is not specified, indoubt transactions are written to the standard output device, and the interactive dialog mode is not initiated.

Interactive dialog mode permits the user to:

- List all indoubt transactions (enter l)
- List indoubt transaction number *x* (enter l, followed by a valid transaction number)
- Quit (enter q)
- Commit transaction number *x* (enter c, followed by a valid transaction number)

- Roll back transaction number x (enter r , followed by a valid transaction number)
- Forget transaction number x (enter f , followed by a valid transaction number).

A blank space must separate the command letter from its argument.

Before a transaction is committed, rolled back, or forgotten, the transaction data is displayed, and the user is asked to confirm the action.

The LIST INDOUBT TRANSACTIONS command returns *type* information to show the role of the database in each indoubt transaction:

TM Indicates the indoubt transaction is using the database as a transaction manager database.

RM Indicates the indoubt transaction is using the database as a resource manager, meaning that it is one of the databases participating in the transaction, but is not the transaction manager database.

Usage notes

An indoubt transaction is a global transaction that was left in an indoubt state. This occurs when either the Transaction Manager (TM) or at least one Resource Manager (RM) becomes unavailable after successfully completing the first phase (that is, the PREPARE phase) of the two-phase commit protocol. The RMs do not know whether to commit or to roll back their branch of the transaction until the TM can consolidate its own log with the indoubt status information from the RMs when they again become available. An indoubt transaction can also exist in an MPP environment.

If LIST INDOUBT TRANSACTIONS is issued against the currently connected database, the command returns the information on indoubt transactions in that database.

Only transactions whose status is indoubt (i), or missing commit acknowledgment (m), or missing federated commit acknowledgment (d) can be committed.

Only transactions whose status is indoubt (i), missing federated rollback acknowledgment (b), or ended (e) can be rolled back.

Only transactions whose status is committed (c), rolled back (r), missing federated commit acknowledgment (d), or missing federated rollback acknowledgment (b) can be forgotten.

In the commit phase of a two-phase commit, the coordinator node waits for commit acknowledgments. If one or more nodes do not reply (for example, because of node failure), the transaction is placed in missing commit acknowledgment state.

Indoubt transaction information is valid only at the time that the command is issued. Once in interactive dialog mode, transaction status might change because of external activities. If this happens, and an attempt is made to process an indoubt transaction which is no longer in an appropriate state, an error message is displayed.

After this type of error occurs, the user should quit (q) the interactive dialog and reissue the LIST INDOUBT TRANSACTIONS WITH PROMPTING command to refresh the information shown.

Chapter 79. LIST NODE DIRECTORY

Lists the contents of the node directory.

Authorization

None

Required connection

None

Command syntax

```
»—LIST—┬──NODE DIRECTORY──┬──»
         └──ADMIN──┬──
                   └──SHOW DETAIL──┬──
```

Command parameters

ADMIN

Specifies administration server nodes.

SHOW DETAIL

Specifies that the output should include the following information:

- Remote instance name
- System
- Operating system type

Examples

The following is sample output from LIST NODE DIRECTORY:

```
Node Directory

Number of entries in the directory = 2

Node 1 entry:

Node name           = LANNODE
Comment             =
Directory entry type = LDAP
Protocol            = TCPIP
Hostname            = LAN.db2ntd3.torolab.ibm.com
Service name        = 50000

Node 2 entry:

Node name           = TLBA10ME
Comment             =
Directory entry type = LOCAL
Protocol            = TCPIP
Hostname            = tlba10me
Service name        = 447
```

The following is sample output from LIST ADMIN NODE DIRECTORY:

Node Directory

Number of entries in the directory = 2

Node 1 entry:

Node name	= LOCALADM
Comment	=
Directory entry type	= LOCAL
Protocol	= TCPIP
Hostname	= jaguar
Service name	= 523

Node 2 entry:

Node name	= MYDB2DAS
Comment	=
Directory entry type	= LDAP
Protocol	= TCPIP
Hostname	= peng.torolab.ibm.com
Service name	= 523

The common fields are identified as follows:

Node name

The name of the remote node. This corresponds to the name entered for the *nodename* parameter when the node was cataloged.

Comment

A comment associated with the node, entered when the node was cataloged. To change a comment in the node directory, uncatalog the node, and then catalog it again with the new comment.

Directory entry type

LOCAL means the entry is found in the local node directory file. LDAP means the entry is found on the LDAP server or LDAP cache.

Protocol

The communications protocol cataloged for the node.

For information about fields associated with a specific node type, see the applicable CATALOG...NODE command.

Usage notes

A node directory is created and maintained on each IBM Data Server Runtime Client. It contains an entry for each remote workstation having databases that the client can access. The DB2 client uses the communication end point information in the node directory whenever a database connection or instance attachment is requested.

The database manager creates a node entry and adds it to the node directory each time it processes a CATALOG...NODE command. The entries can vary, depending on the communications protocol being used by the node.

The node directory can contain entries for the following types of nodes:

- LDAP
- Local
- Named pipe
- TCPIP

- TCPIP4
- TCPIP6

Chapter 81. LIST PACKAGES/TABLES

Lists packages or tables associated with the current database.

Authorization

For the system catalog SYSCAT.PACKAGES (LIST PACKAGES) and SYSCAT.TABLES (LIST TABLES), one of the following is required:

- *sysadm*
- *sysctrl*
- *sysmaint*
- *sysmon*
- *dbadm*
- CONTROL privilege
- SELECT privilege.

Required connection

Database. If implicit connect is enabled, a connection to the default database is established.

Command syntax

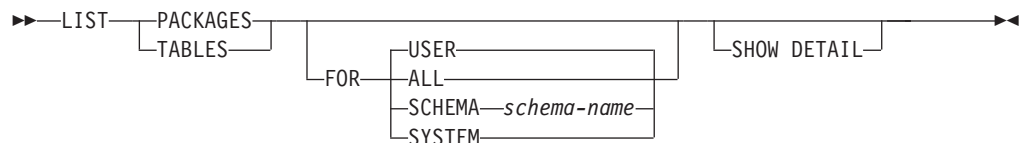

Command parameters

FOR If the FOR clause is not specified, the packages or tables for USER are listed.

ALL Lists all packages or tables in the database.

SCHEMA *schema-name*

Lists all packages or tables in the database for the specified schema only.

SYSTEM

Lists all system packages or tables in the database.

USER Lists all user packages or tables in the database for the current user.

SHOW DETAIL

If this option is chosen with the LIST TABLES command, the full table name and schema name are displayed. If this option is not specified, the table name is truncated to 30 characters, and the ">" symbol in the 31st column represents the truncated portion of the table name; the schema name is truncated to 14 characters and the ">" symbol in the 15th column represents the truncated portion of the schema name. If this option is chosen with the LIST PACKAGES command, the full package schema

(creator), version and bound by authid are displayed, and the package unique_id (consistency token shown in hexadecimal form). If this option is not specified, the schema name and bound by ID are truncated to 8 characters and the ">" symbol in the 9th column represents the truncated portion of the schema or bound by ID; the version is truncated to 10 characters and the ">" symbol in the 11th column represents the truncated portion of the version.

Examples

The following is sample output from LIST PACKAGES:

Package	Schema	Version	Bound by	Total sections	Valid	Format	Isolation level	Blocking
F4INS	USERA	VER1	SNOWBELL	221	Y	0	CS	U
F4INS	USERA	VER2.0	SNOWBELL	201	Y	0	RS	U
F4INS	USERA	VER2.3	SNOWBELL	201	N	3	CS	U
F4INS	USERA	VER2.5	SNOWBELL	201	Y	0	CS	U
PKG12	USERA		USERA	12	Y	3	RR	B
PKG15	USERA		USERA	42	Y	3	RR	B
SALARY	USERT	YEAR2000	USERT	15	Y	3	CS	N

The following is sample output from LIST TABLES:

Table/View	Schema	Type	Creation time
DEPARTMENT	SMITH	T	1997-02-19-13.32.25.971890
EMP_ACT	SMITH	T	1997-02-19-13.32.27.851115
EMP_PHOTO	SMITH	T	1997-02-19-13.32.29.953624
EMP_RESUME	SMITH	T	1997-02-19-13.32.37.837433
EMPLOYEE	SMITH	T	1997-02-19-13.32.26.348245
ORG	SMITH	T	1997-02-19-13.32.24.478021
PROJECT	SMITH	T	1997-02-19-13.32.29.300304
SALES	SMITH	T	1997-02-19-13.32.42.973739
STAFF	SMITH	T	1997-02-19-13.32.25.156337

9 record(s) selected.

Usage notes

LIST PACKAGES and LIST TABLES commands are available to provide a quick interface to the system tables.

The following SELECT statements return information found in the system tables. They can be expanded to select the additional information that the system tables provide.

```
select tabname, tabschema, type, create_time
from syscat.tables
order by tabschema, tabname;
```

```
select pkgname, pkgschema, pkgversion, unique_id, boundby, total_sect,
       valid, format, isolation, blocking
from syscat.packages
order by pkgschema, pkgname, pkgversion;
```

```
select tabname, tabschema, type, create_time
from syscat.tables
where tabschema = 'SYSCAT'
order by tabschema, tabname;
```

```
select pkgname, pkgschema, pkgversion, unique_id, boundby, total_sect,
       valid, format, isolation, blocking
```

```
from syscat.packages
where pkgschema = 'NULLID'
order by pkgschema, pkgname, pkgversion;

select tabname, tabschema, type, create_time
from syscat.tables
where tabschema = USER
order by tabschema, tabname;

select pkgname, pkgschema, pkgversion, unique_id, boundby, total_sect,
       valid, format, isolation, blocking
from syscat.packages
where pkgschema = USER
order by pkgschema, pkgname, pkgversion;
```

Chapter 82. LIST TABLESPACE CONTAINERS

Lists containers for the specified table space.

The table space snapshot contains all of the information displayed by the LIST TABLESPACE CONTAINERS command.

Scope

This command returns information only for the node on which it is executed.

Authorization

One of the following:

- *sysadm*
- *sysctrl*
- *sysmaint*
- *sysmon*
- *dbadm*

Required connection

Database

Command syntax

```
►►—LIST TABLESPACE CONTAINERS FOR—tablespace-id—┐—┘  
└—SHOW DETAIL—┘
```

Command parameters

FOR *tablespace-id*

An integer that uniquely represents a table space used by the current database. To get a list of all the table spaces used by the current database, use the LIST TABLESPACES command.

SHOW DETAIL

If this option is not specified, only the following basic information about each container is provided:

- Container ID
- Name
- Type (file, disk, or path).

If this option is specified, the following additional information about each container is provided:

- Total number of pages
- Number of usable pages
- Accessible (yes or no).

Examples

The following is sample output from LIST TABLESPACE CONTAINERS FOR 0:

Tablespace Containers for Tablespace 0

Container ID	= 0
Name	= /home/smith/smith/NODE0000/SQL00001/SQLT0000.0
Type	= Path

The following is sample output from LIST TABLESPACE CONTAINERS FOR 0 SHOW
DETAIL specified:

Tablespace Containers for Tablespace 0

Container ID	= 0
Name	= /home/smith/smith/NODE0000/SQL00001/SQLT0000.0
Type	= Path
Total pages	= 895
Useable pages	= 895
Accessible	= Yes

Chapter 83. LIST TABLESPACES

Lists table spaces and information about table spaces for the current database.

Information displayed by this command is also available in the table space snapshot.

Scope

This command returns information only for the database partition on which it is executed.

Authorization

One of the following:

- *sysadm*
- *sysctrl*
- *sysmaint*
- *sysmon*
- *dbadm*
- LOAD authority

Required connection

Database

Command syntax

```
▶▶—LIST TABLESPACES—┐—SHOW DETAIL—┘▶▶
```

Command parameters

SHOW DETAIL

If this option is not specified, only the following basic information about each table space is provided:

- Table space ID
- Name
- Type (system managed space or database managed space)
- Contents (any data, long or index data, or temporary data)
- State, a hexadecimal value indicating the current table space state. The externally visible state of a table space is composed of the hexadecimal sum of certain state values. For example, if the state is "quiesced: EXCLUSIVE" and "Load pending", the value is 0x0004 + 0x0008, which is 0x000c. The db2fbst (Get Tablespace State) command can be used to obtain the table space state associated with a given hexadecimal value. Following are the bit definitions listed in `sqlutil.h`:

0x0	Normal
0x1	Quiesced: SHARE
0x2	Quiesced: UPDATE

0x4	Quiesced: EXCLUSIVE
0x8	Load pending
0x10	Delete pending
0x20	Backup pending
0x40	Roll forward in progress
0x80	Roll forward pending
0x100	Restore pending
0x100	Recovery pending (not used)
0x200	Disable pending
0x400	Reorg in progress
0x800	Backup in progress
0x1000	Storage must be defined
0x2000	Restore in progress
0x4000	Offline and not accessible
0x8000	Drop pending
0x20000	Load in progress
0x2000000	Storage may be defined
0x4000000	StorDef is in 'final' state
0x8000000	StorDef was change prior to roll forward
0x10000000	DMS rebalance in progress
0x20000000	Table space deletion in progress
0x40000000	Table space creation in progress

If this option is specified, the following additional information about each table space is provided:

- Total number of pages
- Number of usable pages
- Number of used pages
- Number of free pages
- High water mark (in pages)
- Page size (in bytes)
- Extent size (in pages)
- Prefetch size (in pages)
- Number of containers
- Minimum recovery time (displayed only if not zero)
- State change table space ID (displayed only if the table space state is "load pending" or "delete pending")
- State change object ID (displayed only if the table space state is "load pending" or "delete pending")
- Number of quiescers (displayed only if the table space state is "quiesced: SHARE", "quiesced: UPDATE", or "quiesced: EXCLUSIVE")
- Table space ID and object ID for each quiescer (displayed only if the number of quiescers is greater than zero).

Examples

The following are two sample outputs from LIST TABLESPACES SHOW DETAIL.

```

          Tablespaces for Current Database
Tablespace ID      = 0
Name               = SYSCATSPACE
Type              = Database managed space
Contents          = Any data
State             = 0x0000
  Detailed explanation:
    Normal
Total pages       = 895
Useable pages     = 895

```



```

Used pages                = 895
Free pages                = Not applicable
High water mark (pages)  = Not applicable
Page size (bytes)        = 4096
Extent size (pages)      = 32
Prefetch size (pages)    = 32
Number of containers      = 1

Tablespace ID            = 1
Name                     = TEMPSPACE1
Type                     = System managed space
Contents                 = Temporary data
State                    = 0x0000
  Detailed explanation:
    Normal
Total pages              = 1
Useable pages            = 1
Used pages               = 1
Free pages               = Not applicable
High water mark (pages) = Not applicable
Page size (bytes)       = 4096
Extent size (pages)     = 32
Prefetch size (pages)   = 32
Number of containers     = 1

Tablespace ID            = 2
Name                     = USERSPACE1
Type                     = Database managed space
Contents                 = Any data
State                    = 0x000c
  Detailed explanation:
    Quiesced: EXCLUSIVE
    Load pending
Total pages              = 337
Useable pages            = 337
Used pages               = 337
Free pages               = Not applicable
High water mark (pages) = Not applicable
Page size (bytes)       = 4096
Extent size (pages)     = 32
Prefetch size (pages)   = 32
Number of containers     = 1
State change tablespace ID = 2
State change object ID   = 3
Number of quiescers      = 1
  Quiescer 1:
    Tablespace ID        = 2
    Object ID            = 3

```

DB21011I In a partitioned database server environment, only the table spaces on the current node are listed.

Tablespaces for Current Database

```

Tablespace ID            = 0
Name                     = SYSCATSPACE
Type                     = System managed space
Contents                 = Any data
State                    = 0x0000
  Detailed explanation:
    Normal
Total pages              = 1200
Useable pages            = 1200
Used pages               = 1200
Free pages               = Not applicable
High water mark (pages) = Not applicable
Page size (bytes)       = 4096
Extent size (pages)     = 32
Prefetch size (pages)   = 32

```

```

Number of containers                = 1

Tablespace ID                      = 1
Name                               = TEMPSPACE1
Type                               = System managed space
Contents                           = Temporary data
State                              = 0x0000
  Detailed explanation:
    Normal
Total pages                        = 1
Useable pages                      = 1
Used pages                         = 1
Free pages                         = Not applicable
High water mark (pages)           = Not applicable
Page size (bytes)                 = 4096
Extent size (pages)               = 32
Prefetch size (pages)             = 32
Number of containers              = 1

Tablespace ID                      = 2
Name                               = USERSPACE1
Type                               = System managed space
Contents                           = Any data
State                              = 0x0000
  Detailed explanation:
    Normal
Total pages                        = 1
Useable pages                      = 1
Used pages                         = 1
Free pages                         = Not applicable
High water mark (pages)           = Not applicable
Page size (bytes)                 = 4096
Extent size (pages)               = 32
Prefetch size (pages)             = 32
Number of containers              = 1

Tablespace ID                      = 3
Name                               = DMS8K
Type                               = Database managed space
Contents                           = Any data
State                              = 0x0000
  Detailed explanation:
    Normal
Total pages                        = 2000
Useable pages                      = 1952
Used pages                         = 96
Free pages                         = 1856
High water mark (pages)           = 96
Page size (bytes)                 = 8192
Extent size (pages)               = 32
Prefetch size (pages)             = 32
Number of containers              = 2

Tablespace ID                      = 4
Name                               = TEMP8K
Type                               = System managed space
Contents                           = Temporary data
State                              = 0x0000
  Detailed explanation:
    Normal
Total pages                        = 1
Useable pages                      = 1
Used pages                         = 1
Free pages                         = Not applicable
High water mark (pages)           = Not applicable
Page size (bytes)                 = 8192
Extent size (pages)               = 32

```

Prefetch size (pages) = 32
Number of containers = 1

DB21011I In a partitioned database server environment, only the table spaces on the current node are listed.

Usage notes

In a partitioned database environment, this command does not return all the table spaces in the database. To obtain a list of all the table spaces, query SYSCAT.TABLESPACES.

During a table space rebalance, the number of usable pages includes pages for the newly added container, but these new pages are not reflected in the number of free pages until the rebalance is complete. When a table space rebalance is not in progress, the number of used pages plus the number of free pages equals the number of usable pages.

There are currently at least 25 table or table space states supported by the IBM DB2 database product. These states are used to control access to data under certain circumstances, or to elicit specific user actions, when required, to protect the integrity of the database. Most of them result from events related to the operation of one of the DB2 utilities, such as the load utility, or the backup and restore utilities.

The following table describes each of the supported table space states. The table also provides you with working examples that show you exactly how to interpret and respond to states that you might encounter while administering your database. The examples are taken from command scripts that were run on AIX; you can copy, paste and run them yourself. If you are running the DB2 database product on a system that is not UNIX, ensure that any path names are in the correct format for your system. Most of the examples are based on tables in the SAMPLE database that comes with the DB2 database product. A few examples require scenarios that are not part of the SAMPLE database, but you can use a connection to the SAMPLE database as a starting point.

Table 18. Supported table space states

State	Hexadecimal state value	Description	Examples
Backup Pending	0x20	<p>A table space is in this state after a point-in-time table space rollforward operation, or after a load operation (against a recoverable database) that specifies the COPY NO option. The table space (or, alternatively, the entire database) must be backed up before the table space can be used. If the table space is not backed up, tables within that table space can be queried, but not updated.</p> <p>Note: A database must also be backed up immediately after it is enabled for rollforward recovery. A database is recoverable if the logretain database configuration parameter is set to RECOVERY, or the userexit database configuration parameter is set to YES. You cannot activate or connect to such a database until it has been backed up, at which time the value of the backup_pending informational database configuration parameter is set to NO.</p>	<p>1. Given load input file staff_data.del with content:</p> <pre>11,"Melnyk",20,"Sales",10,70000,15000: update db cfg for sample using logretain recovery; backup db sample; connect to sample; load from staff_data.del of del messages load.msg insert into staff copy no; update staff set salary = 69000 where id = 11;</pre> <p>2.</p> <pre>update db cfg for sample using logretain recovery; connect to sample;</pre>
Backup in Progress	0x800	<p>This is a transient state that is only in effect during a backup operation.</p>	<p>Issue an online BACKUP DATABASE command:</p> <pre>backup db sample online;</pre> <p>While the backup operation is running, execute the following script from another session:</p> <pre>connect to sample;</pre> <p>1.</p> <pre>list tablespaces show detail;</pre> <p>or</p> <p>2.</p> <pre>get snapshot for tablespaces on sample; connect reset;</pre> <p>Information returned for USERSPACE1 shows that this table space is in Backup in Progress state.</p>

Table 18. Supported table space states (continued)

State	Hexadecimal state value	Description	Examples
DMS Rebalance in Progress	0x10000000	This is a transient state that is only in effect during a data rebalancing operation. When new containers are added to a table space that is defined as database managed space (DMS), or existing containers are extended, a rebalancing of the table space data might occur. <i>Rebalancing</i> is the process of moving table space extents from one location to another in an attempt to keep the data striped. An <i>extent</i> is a unit of container space (measured in pages), and a <i>stripe</i> is a layer of extents <i>across the set of containers</i> for a table space.	<p>Given load input file staffdata.del with a substantial amount of data (for example, 20000 or more records):</p> <pre>connect to sample; create tablespace ts1 managed by database using (file '/home/melnyk/melnyk/NODE00000/SQL00001 /ts1c1' 1024); create table newstaff like staff in ts1; load from staffdata.del of del insert into newstaff nonrecoverable; alter tablespace ts1 add (file '/home/melnyk/melnyk /NODE00000/SQL00001/ts1c2' 1024); list tablespaces; connect reset;</pre> <p>Information returned for TS1 shows that this table space is in DMS Rebalance in Progress state.</p>
Disable Pending	0x200	A table space may be in this state during a database rollforward operation and should no longer be in this state by the end of the rollforward operation. The state is triggered by conditions that result from a table space going offline and compensation log records for a transaction not being written. The appearance and subsequent disappearance of this table space state is transparent to users.	An example illustrating this table space state is beyond the scope of this document.
Drop Pending	0x8000	A table space is in this state if one or more of its containers is found to have a problem during a database restart operation. (A database must be restarted if the previous session with this database terminated abnormally, such as during a power failure, for example.) If a table space is in Drop Pending state, it will not be available, and can only be dropped.	An example illustrating this table space state is beyond the scope of this document.

Table 18. Supported table space states (continued)

State	Hexadecimal state value	Description	Examples
Load in Progress	0x20000	This is a transient state that is only in effect during a load operation (against a recoverable database) that specifies the COPY NO option. See also Load in Progress table state.	<p>Given load input file staffdata.del with a substantial amount of data (for example, 20000 or more records):</p> <pre>update db cfg for sample using logretain recovery; backup db sample; connect to sample; create table newstaff like staff; load from staffdata.del of del insert into newstaff copy no; connect reset;</pre> <p>While the load operation is running, execute the following script from another session:</p> <pre>connect to sample; list tablespaces; connect reset;</pre> <p>Information returned for USERSPACE1 shows that this table space is in Load in Progress (and Backup Pending) state.</p>
Normal	0x0	A table space is in Normal state if it is not in any of the other (abnormal) table space states. Normal state is the initial state of a table space after it is created.	<pre>connect to sample; create tablespace ts1 managed by database using (file '/home/melnyk/melnyk/NODE0000/SQL00001 /tsc1' 1024); list tablespaces show detail;</pre>
Offline and Not Accessible	0x4000	A table space is in this state if there is a problem with one or more of its containers. A container might be inadvertently renamed, moved, or damaged. After the problem has been rectified, and the containers that are associated with the table space are accessible again, this abnormal state can be removed by disconnecting all applications from the database and then reconnecting to the database. Alternatively, you can issue an ALTER TABLESPACE statement, specifying the SWITCH ONLINE clause, to remove the Offline and Not Accessible state from the table space without disconnecting other applications from the database.	<pre>connect to sample; create tablespace ts1 managed by database using (file '/home/melnyk/melnyk/NODE0000/SQL00001 /tsc1' 1024); alter tablespace ts1 add (file '/home/melnyk/melnyk /NODE0000/SQL00001/tsc2' 1024); export to st_data.del of del select * from staff; create table stafftemp like staff in ts1; import from st_data.del of del insert into stafftemp; connect reset;</pre> <p>Rename table space container tsc1 to tsc3 and then try to query the STAFFTEMP table:</p> <pre>connect to sample; select * from stafftemp;</pre> <p>The query returns SQL0290N (table space access is not allowed), and the LIST TABLESPACES command returns a state value of 0x4000 (Offline and Not Accessible) for TS1. Rename table space container tsc3 back to tsc1. This time the query runs successfully.</p>

Table 18. Supported table space states (continued)

State	Hexadecimal state value	Description	Examples
Quiesced Exclusive	0x4	A table space is in this state when the application that invokes the table space quiesce function has exclusive (read or write) access to the table space. You can put a table space in Quiesced Exclusive state explicitly by issuing the QUIESCE TABLESPACES FOR TABLE command.	<p>Ensure that the table space state is Normal before setting it to Quiesced Exclusive.</p> <pre>connect to sample; quiesce tablespaces for table staff reset; quiesce tablespaces for table staff exclusive; connect reset;</pre> <p>Execute the following script from another session:</p> <pre>connect to sample; select * from staff where id=60; update staff set salary=50000 where id=60; list tablespaces; connect reset;</pre> <p>Information returned for USERSPACE1 shows that this table space is in Quiesced Exclusive state.</p>
Quiesced Share	0x1	A table space is in this state when both the application that invokes the table space quiesce function and concurrent applications have read (but not write) access to the table space. You can put a table space in Quiesced Share state explicitly by issuing the QUIESCE TABLESPACES FOR TABLE command.	<p>Ensure that the table space state is Normal before setting it to Quiesced Share.</p> <pre>connect to sample; quiesce tablespaces for table staff reset; quiesce tablespaces for table staff share; connect reset;</pre> <p>Execute the following script from another session:</p> <pre>connect to sample; select * from staff where id=40; update staff set salary=50000 where id=40; list tablespaces; connect reset;</pre> <p>Information returned for USERSPACE1 shows that this table space is in Quiesced Share state.</p>
Quiesced Update	0x2	A table space is in this state when the application that invokes the table space quiesce function has exclusive write access to the table space. You can put a table space in Quiesced Update state explicitly by issuing the QUIESCE TABLESPACES FOR TABLE command.	<p>Ensure that the table space state is Normal before setting it to Quiesced Update.</p> <pre>connect to sample; quiesce tablespaces for table staff reset; quiesce tablespaces for table staff intent to update; connect reset;</pre> <p>Execute the following script from another session:</p> <pre>connect to sample; select * from staff where id=50; update staff set salary=50000 where id=50; list tablespaces; connect reset;</pre> <p>Information returned for USERSPACE1 shows that this table space is in Quiesced Update state.</p>

Table 18. Supported table space states (continued)

State	Hexadecimal state value	Description	Examples
Reorg in Progress	0x400	This is a transient state that is only in effect during a reorg operation.	<p>Issue a REORG TABLE command:</p> <pre>connect to sample; reorg table staff; connect reset;</pre> <p>While the reorg operation is running, execute the following script from another session:</p> <pre>connect to sample;</pre> <ol style="list-style-type: none"> list tablespaces show detail; <p>or</p> <ol style="list-style-type: none"> get snapshot for tablespaces on sample; connect reset; <p>Information returned for USERSPACE1 shows that this table space is in Reorg in Progress state. Note: Table reorganization operations involving the SAMPLE database are likely to complete in a short period of time and, as a result, it may be difficult to observe the Reorg in Progress state using this approach.</p>
Restore Pending	0x100	Table spaces for a database are in this state after the first part of a redirected restore operation (that is, before the SET TABLESPACE CONTAINERS command is issued). The table space (or the entire database) must be restored before the table space can be used. You cannot connect to the database until the restore operation has been successfully completed, at which time the value of the restore_pending informational database configuration parameter is set to NO.	When the first part of the redirected restore operation in Storage May be Defined completes, all of the table spaces are in Restore Pending state.

Table 18. Supported table space states (continued)

State	Hexadecimal state value	Description	Examples
Restore in Progress	0x2000	This is a transient state that is only in effect during a restore operation.	<pre>update db cfg for sample using logretain recovery; backup db sample; backup db sample tablespace (userspace1);</pre> <p>The timestamp for this backup image is:</p> <pre>20040611174124 restore db sample tablespace (userspace1) online taken at 20040611174124;</pre> <p>While the restore operation is running, execute the following script from another session:</p> <pre>connect to sample;</pre> <ol style="list-style-type: none"> list tablespaces show detail; <p>or</p> <ol style="list-style-type: none"> get snapshot for tablespaces on sample; connect reset; <p>Information returned for USERSPACE1 shows that this table space is in Restore in Progress state.</p>
Roll Forward Pending	0x80	A table space is in this state after a restore operation against a recoverable database. The table space (or the entire database) must be rolled forward before the table space can be used. A database is recoverable if the logretain database configuration parameter is set to RECOVERY, or the userexit database configuration parameter is set to YES. You cannot activate or connect to the database until a rollforward operation has been successfully completed, at which time the value of the rollfwd_pending informational database configuration parameter is set to NO.	When the online table space restore operation in Restore in Progress completes, the table space USERSPACE1 is in Roll Forward Pending state.

Table 18. Supported table space states (continued)

State	Hexadecimal state value	Description	Examples
Roll Forward in Progress	0x40	This is a transient state that is only in effect during a rollforward operation.	<p>Given load input file staffdata.del with a substantial amount of data (for example, 20000 or more records):</p> <pre>update db cfg for sample using logretain recovery; backup db sample; connect to sample; create tablespace ts1 managed by database using (file '/home/melnyk/melnyk/NODE0000/SQL00001 /ts1c1' 1024); create table newstaff like staff in ts1; connect reset; backup db sample tablespace (ts1) online;</pre> <p>The timestamp for this backup image is:</p> <pre>20040630000715 connect to sample; load from staffdata.del of del insert into newstaff copy yes to /home/melnyk/backups; connect reset; restore db sample tablespace (ts1) online taken at 20040630000715; rollforward db sample to end of logs and stop tablespace (ts1) online;</pre> <p>While the rollforward operation is running, execute the following script from another session:</p> <pre>connect to sample;</pre> <ol style="list-style-type: none"> list tablespaces show detail; <p>or</p> <ol style="list-style-type: none"> get snapshot for tablespaces on sample; connect reset; <p>Information returned for TS1 shows that this table space is in Roll Forward in Progress state.</p>
Storage May be Defined	0x2000000	Table spaces for a database are in this state after the first part of a redirected restore operation (that is, before the SET TABLESPACE CONTAINERS command is issued). This allows you to redefine the containers, if you wish.	<pre>backup db sample;</pre> <p>Assuming that the timestamp for this backup image is 20040613204955:</p> <pre>restore db sample taken at 20040613204955 redirect; list tablespaces;</pre> <p>Information returned by the LIST TABLESPACES command shows that all of the table spaces are in Storage May be Defined and Restore Pending state.</p>

Table 18. Supported table space states (continued)

State	Hexadecimal state value	Description	Examples
Storage Must be Defined	0x1000	Table spaces for a database are in this state during a redirected restore operation to a new database if the set table space containers phase is omitted or if, during the set table space containers phase, the specified containers cannot be acquired. The latter can occur if, for example, an invalid path name has been specified, or there is insufficient disk space.	<pre>backup db sample;</pre> <p>Assuming that the timestamp for this backup image is 20040613204955:</p> <pre>restore db sample taken at 20040613204955 into mydb redirect; set tablespace containers for 2 using (path 'ts2c1'); list tablespaces;</pre> <p>Information returned by the LIST TABLESPACES command shows that table space SYSCATSPACE and table space TEMPSPACE1 are in Storage Must be Defined, Storage May be Defined, and Restore Pending state. Storage Must be Defined state takes precedence over Storage May be Defined state.</p>
Table Space Creation in Progress	0x40000000	This is a transient state that is only in effect during a create table space operation.	<pre>connect to sample; create tablespace ts1 managed by database using (file '/home/melnyk/melnyk/NODE00000/SQL00001/tsc1' 1024); create tablespace ts2 managed by database using (file '/home/melnyk/melnyk/NODE00000/SQL00001/tsc2' 1024); create tablespace ts3 managed by database using (file '/home/melnyk/melnyk/NODE00000/SQL00001/tsc3' 1024);</pre> <p>While the create table space operations are running, execute the following script from another session:</p> <pre>connect to sample;</pre> <ol style="list-style-type: none"> list tablespaces show detail; <p>or</p> <ol style="list-style-type: none"> get snapshot for tablespaces on sample; connect reset; <p>Information returned for TS1, TS2, and TS3 shows that these table spaces are in Table Space Creation in Progress state.</p>

Table 18. Supported table space states (continued)

State	Hexadecimal state value	Description	Examples
Table Space Deletion in Progress	0x20000000	This is a transient state that is only in effect during a delete table space operation.	<pre>connect to sample; create tablespace ts1 managed by database using (file '/home/melnyk/melnyk/NODE0000/SQL00001 /tsc1' 1024); create tablespace ts2 managed by database using (file '/home/melnyk/melnyk/NODE0000/SQL00001 /tsc2' 1024); create tablespace ts3 managed by database using (file '/home/melnyk/melnyk/NODE0000/SQL00001 /tsc3' 1024); drop tablespace ts1; drop tablespace ts2; drop tablespace ts3;</pre> <p>While the drop table space operations are running, execute the following script from another session:</p> <pre>connect to sample;</pre> <ol style="list-style-type: none"> list tablespaces show detail; <p>or</p> <ol style="list-style-type: none"> get snapshot for tablespaces on sample; connect reset; <p>Information returned for TS1, TS2, and TS3 shows that these table spaces are in Table Space Deletion in Progress state.</p>

For additional information about table space states, see the *Related links* section.

Chapter 84. LIST UTILITIES

Displays to standard output the list of active utilities on the instance. The description of each utility can include attributes such as start time, description, throttling priority (if applicable), as well as progress monitoring information (if applicable).

Scope

This command returns information for all database partitions.

Authorization

One of the following:

- *sysadm*
- *sysctrl*
- *sysmaint*
- *sysmon*

Required connection

Instance

Command syntax

```
▶▶—LIST UTILITIES—└─SHOW DETAIL─┘▶▶
```

Command parameters

SHOW DETAIL

Displays detailed progress information for utilities that support progress monitoring.

Examples

A RUNSTATS invocation on table *some_table*:

```
LIST UTILITIES
```

```
ID                = 1
Type              = RUNSTATS
Database Name     = PROD
Description       = krrose.some_table
Start Time        = 12/19/2003 11:54:45.773215
Priority          = 10
```

Monitoring the performance of an offline database backup:

```
LIST UTILITIES SHOW DETAIL
```

```
ID                = 2
Type              = BACKUP
Database Name     = SAMPLE
Description       = offline db
```

```
Start Time          = 10/30/2003 12:55:31.786115
Priority            = 0
Progress Monitoring:
  Phase Number [CURRENT] = 1
  Description         =
  Work Metric        = BYTES
  Total Work Units   = 20232453
  Completed Work Units = 230637
  Start Time        = 10/30/2003 12:55:31.786115
```

Usage notes

Use this command to monitor the status of running utilities. For example, you might use this utility to monitor the progress of an online backup. In another example, you might investigate a performance problem by using this command to determine which utilities are running. If the utility is suspected to be responsible for degrading performance then you might elect to throttle the utility (if the utility supports throttling). The ID from the LIST UTILITIES command is the same ID used in the SET UTIL_IMPACT_PRIORITY command.

Chapter 85. LOAD

Loads data into a DB2 table. Data residing on the server can be in the form of a file, tape, or named pipe. Data residing on a remotely connected client can be in the form of a fully qualified file or named pipe. Data can also be loaded from a user-defined cursor or by using a user-written script or application. If the COMPRESS attribute for the table is set to YES, the data loaded will be subject to compression on every data and database partition for which a dictionary already exists in the table, including data in the XML storage object of the table.

Quick link to “File type modifiers for the load utility” on page 385.

Restrictions

The load utility does not support loading data at the hierarchy level. The load utility is not compatible with range-clustered tables.

Scope

This command can be issued against multiple database partitions in a single request.

Authorization

One of the following:

- *dataaccess*
- LOAD authority on the database and
 - INSERT privilege on the table when the load utility is invoked in INSERT mode, TERMINATE mode (to terminate a previous load insert operation), or RESTART mode (to restart a previous load insert operation)
 - INSERT and DELETE privilege on the table when the load utility is invoked in REPLACE mode, TERMINATE mode (to terminate a previous load replace operation), or RESTART mode (to restart a previous load replace operation)
 - INSERT privilege on the exception table, if such a table is used as part of the load operation.
- To load data into a table that has protected columns, the session authorization ID must have LBAC credentials that allow write access to all protected columns in the table. Otherwise the load fails and an error (SQLSTATE 5U014) is returned.
- To load data into a table that has protected rows, the session authorization id must hold a security label that meets these criteria:
 - It is part of the security policy protecting the table
 - It was granted to the session authorization ID for write access or for all access

If the session authorization id does not hold such a security label then the load fails and an error (SQLSTATE 5U014) is returned. This security label is used to protect a loaded row if the session authorization ID's LBAC credentials do not allow it to write to the security label that protects that row in the data. This does not happen, however, when the security policy protecting the table was created

with the RESTRICT NOT AUTHORIZED WRITE SECURITY LABEL option of the CREATE SECURITY POLICY statement. In this case the load fails and an error (SQLSTATE 42519) is returned.

- If the REPLACE option is specified, the session authorization ID must have the authority to drop the table.
- If the LOCK WITH FORCE option is specified, SYSADM authority is required.

Since all load processes (and all DB2 server processes, in general) are owned by the instance owner, and all of these processes use the identification of the instance owner to access needed files, the instance owner must have read access to input data files. These input data files must be readable by the instance owner, regardless of who invokes the command.

Required connection

Database. If implicit connect is enabled, a connection to the default database is established.

Instance. An explicit attachment is not required. If a connection to the database has been established, an implicit attachment to the local instance is attempted.

Command syntax

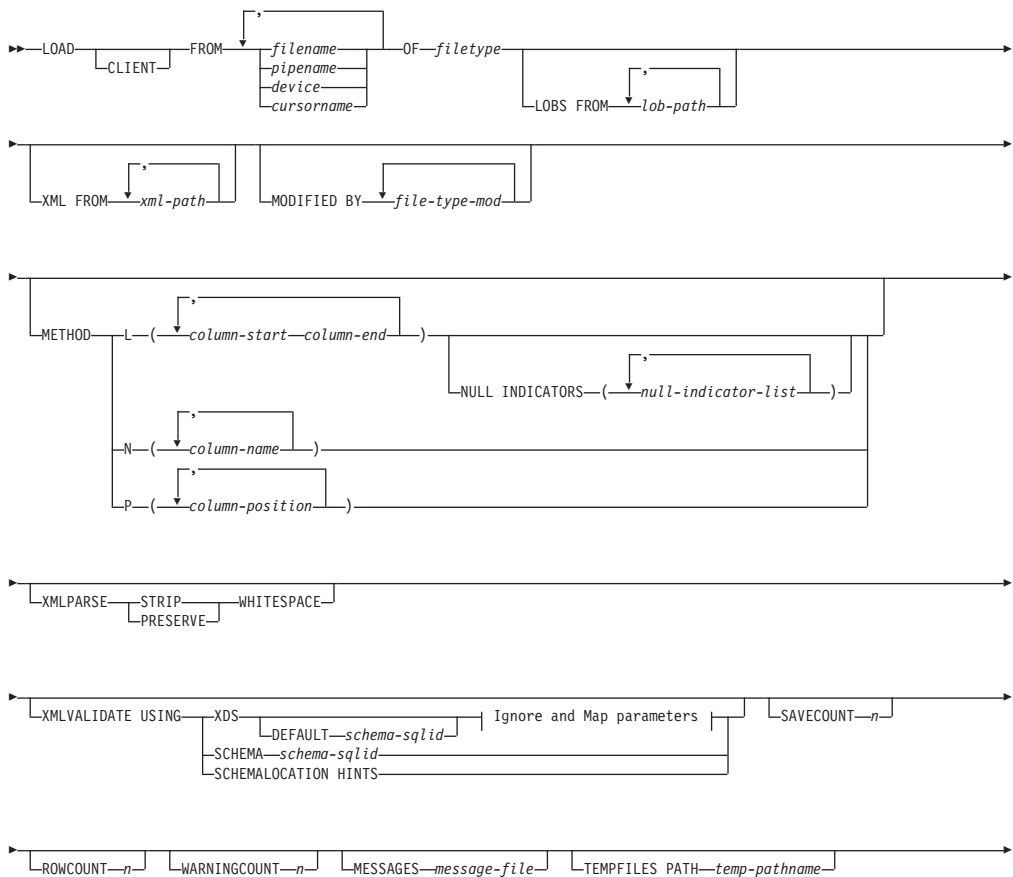

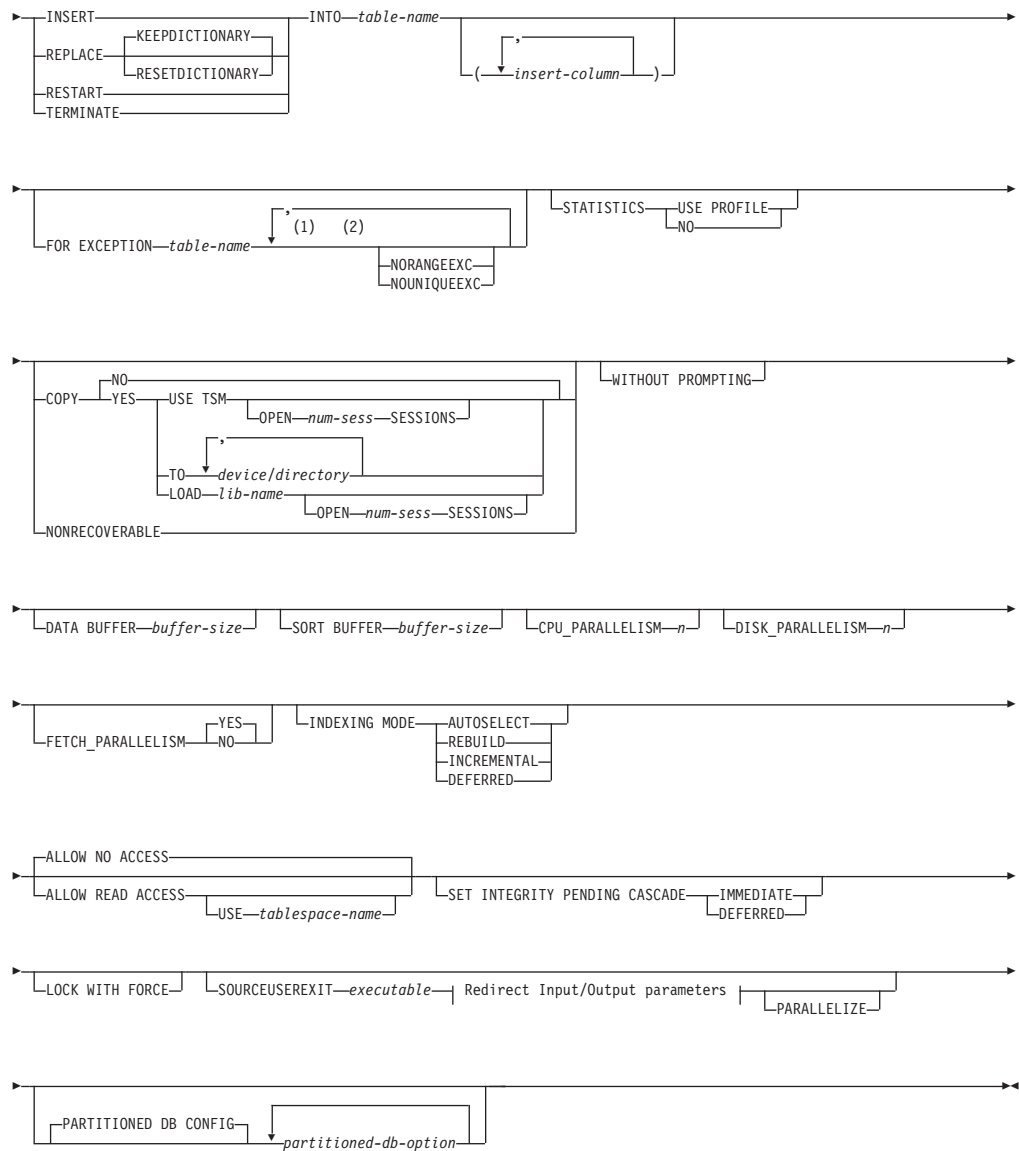

Ignore and Map parameters:

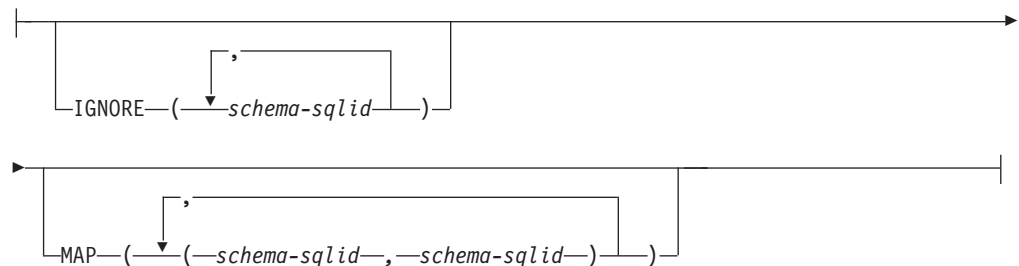

Redirect Input/Output parameters:

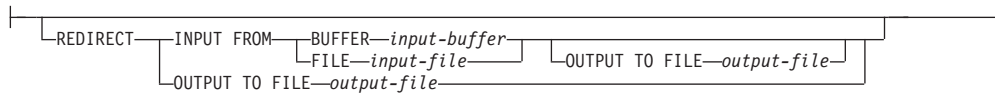

Notes:

- 1 These keywords can appear in any order.
- 2 Each of these keywords can only appear once.

Command parameters

CLIENT

Specifies that the data to be loaded resides on a remotely connected client. This option is ignored if the load operation is not being invoked from a remote client. This option is ignored if specified in conjunction with the CURSOR file type.

Note:

1. The `dumpfile` and `lobsinfile` modifiers and the XML FROM option refer to files on the server even when the CLIENT keyword is specified.
2. Code page conversion is not performed during a remote load operation. If the code page of the data is different from that of the server, the data code page should be specified using the `codepage` modifier.

In the following example, a data file (`/u/user/data.del`) residing on a remotely connected client is to be loaded into MYTABLE on the server database:

```
db2 load client from /u/user/data.del of del
modified by codepage=850 insert into mytable
```

FROM *filename* | *pipename* | *device* | *cursorname*

Specifies the file, pipe, device, or cursor referring to an SQL statement that contains the data being loaded. If the input source is a file, pipe, or device, it must reside on the database partition where the database resides, unless the CLIENT option is specified.

If several names are specified, they will be processed in sequence. If the last item specified is a tape device, the user is prompted for another tape. Valid response options are:

- c** Continue. Continue using the device that generated the warning message (for example, when a new tape has been mounted).
- d** Device terminate. Stop using the device that generated the warning message (for example, when there are no more tapes).
- t** Terminate. Terminate all devices.

Note:

1. It is recommended that the fully qualified file name be used. If the server is remote, the fully qualified file name must be used. If the database resides on the same database partition as the caller, relative paths can be used.
2. If data is exported into a file using the `EXPORT` command using the `ADMIN_CMD` procedure, the data file is owned by the fenced user ID.

This file is not usually accessible by the instance owner. To run the LOAD from CLP or the ADMIN_CMD procedure, the data file must be accessible by the instance owner ID, so read access to the data file must be granted to the instance owner.

3. Loading data from multiple IXF files is supported if the files are physically separate, but logically one file. It is *not* supported if the files are both logically and physically separate. (Multiple physical files would be considered logically one if they were all created with one invocation of the EXPORT command.)
4. If loading data that resides on a client machine, the data must be in the form of either a fully qualified file or a named pipe.
5. When loading XML data from files into tables in a partitioned database environment, the XML data files must be read-accessible to all the database partitions where loading is taking place.

OF *filetype*

Specifies the format of the data:

- ASC (non-delimited ASCII format).
- DEL (delimited ASCII format).
- IXF (Integration Exchange Format, PC version) is a binary format that is used exclusively by DB2.
- CURSOR (a cursor declared against a SELECT or VALUES statement).

Note: When using a CURSOR file type to load XML data into a table in a distributed database environment, the PARTITION_ONLY and LOAD_ONLY modes are not supported.

LOBS FROM *lob-path*

The path to the data files containing LOB values to be loaded. The path must end with a slash. If the CLIENT option is specified, the path must be fully qualified. The names of the LOB data files are stored in the main data file (ASC, DEL, or IXF), in the column that will be loaded into the LOB column. The maximum number of paths that can be specified is 999. This will implicitly activate the LOBSINFILF behavior.

This option is ignored when specified in conjunction with the CURSOR file type.

MODIFIED BY *file-type-mod*

Specifies file type modifier options. See “File type modifiers for the load utility” on page 385.

METHOD

- L** Specifies the start and end column numbers from which to load data. A column number is a byte offset from the beginning of a row of data. It is numbered starting from 1. This method can only be used with ASC files, and is the only valid method for that file type.

NULL INDICATORS *null-indicator-list*

This option can only be used when the METHOD L parameter is specified; that is, the input file is an ASC file). The null indicator list is a comma-separated list of positive integers specifying the column number of each null indicator field. The column number is the byte offset of the null indicator field from the beginning of a row of data. There must be one entry in the null indicator list for each

data field defined in the METHOD L parameter. A column number of zero indicates that the corresponding data field always contains data.

A value of Y in the NULL indicator column specifies that the column data is NULL. Any character *other than* Y in the NULL indicator column specifies that the column data is not NULL, and that column data specified by the METHOD L option will be loaded.

The NULL indicator character can be changed using the MODIFIED BY option.

- N Specifies the names of the columns in the data file to be loaded. The case of these column names must match the case of the corresponding names in the system catalogs. Each table column that is not nullable should have a corresponding entry in the METHOD N list. For example, given data fields F1, F2, F3, F4, F5, and F6, and table columns C1 INT, C2 INT NOT NULL, C3 INT NOT NULL, and C4 INT, method N (F2, F1, F4, F3) is a valid request, while method N (F2, F1) is not valid. This method can only be used with file types IXF or CURSOR.
- P Specifies the field numbers (numbered from 1) of the input data fields to be loaded. Each table column that is not nullable should have a corresponding entry in the METHOD P list. For example, given data fields F1, F2, F3, F4, F5, and F6, and table columns C1 INT, C2 INT NOT NULL, C3 INT NOT NULL, and C4 INT, method P (2, 1, 4, 3) is a valid request, while method P (2, 1) is not valid. This method can only be used with file types IXF, DEL, or CURSOR, and is the only valid method for the DEL file type.

XML FROM *xml-path*

Specifies one or more paths that contain the XML files. XDSs are contained in the main data file (ASC, DEL, or IXF), in the column that will be loaded into the XML column.

XMLPARSE

Specifies how XML documents are parsed. If this option is not specified, the parsing behavior for XML documents will be determined by the value of the CURRENT XMLPARSE OPTION special register.

STRIP WHITESPACE

Specifies to remove whitespace when the XML document is parsed.

PRESERVE WHITESPACE

Specifies not to remove whitespace when the XML document is parsed.

XMLVALIDATE

Specifies that XML documents are validated against a schema, when applicable.

USING XDS

XML documents are validated against the XML schema identified by the XML Data Specifier (XDS) in the main data file. By default, if the XMLVALIDATE option is invoked with the USING XDS clause, the schema used to perform validation will be determined by the SCH attribute of the XDS. If an SCH attribute is not present in the XDS, no schema validation will occur unless a default schema is specified by the DEFAULT clause.

The DEFAULT, IGNORE, and MAP clauses can be used to modify the schema determination behavior. These three optional clauses apply directly to the specifications of the XDS, and not to each other. For example, if a schema is selected because it is specified by the DEFAULT clause, it will not be ignored if also specified by the IGNORE clause. Similarly, if a schema is selected because it is specified as the first part of a pair in the MAP clause, it will not be re-mapped if also specified in the second part of another MAP clause pair.

USING SCHEMA *schema-sqlid*

XML documents are validated against the XML schema with the specified SQL identifier. In this case, the SCH attribute of the XML Data Specifier (XDS) will be ignored for all XML columns.

USING SCHEMALOCATION HINTS

XML documents are validated against the schemas identified by XML schema location hints in the source XML documents. If a schemaLocation attribute is not found in the XML document, no validation will occur. When the USING SCHEMALOCATION HINTS clause is specified, the SCH attribute of the XML Data Specifier (XDS) will be ignored for all XML columns.

See examples of the XMLVALIDATE option below.

IGNORE *schema-sqlid*

This option can only be used when the USING XDS parameter is specified. The IGNORE clause specifies a list of one or more schemas to ignore if they are identified by an SCH attribute. If an SCH attribute exists in the XML Data Specifier for a loaded XML document, and the schema identified by the SCH attribute is included in the list of schemas to IGNORE, then no schema validation will occur for the loaded XML document.

Note:

If a schema is specified in the IGNORE clause, it cannot also be present in the left side of a schema pair in the MAP clause.

The IGNORE clause applies only to the XDS. A schema that is mapped by the MAP clause will not be subsequently ignored if specified by the IGNORE clause.

DEFAULT *schema-sqlid*

This option can only be used when the USING XDS parameter is specified. The schema specified through the DEFAULT clause identifies a schema to use for validation when the XML Data Specifier (XDS) of a loaded XML document does not contain an SCH attribute identifying an XML Schema.

The DEFAULT clause takes precedence over the IGNORE and MAP clauses. If an XDS satisfies the DEFAULT clause, the IGNORE and MAP specifications will be ignored.

MAP *schema-sqlid*

This option can only be used when the USING XDS parameter is specified. Use the MAP clause to specify alternate schemas to use in place of those specified by the SCH attribute of an XML Data Specifier (XDS) for each loaded XML document. The MAP clause specifies a list of one or more schema pairs, where each pair represents a mapping of one schema to another. The first schema in the pair represents a schema that is referred to

by an SCH attribute in an XDS. The second schema in the pair represents the schema that should be used to perform schema validation.

If a schema is present in the left side of a schema pair in the MAP clause, it cannot also be specified in the IGNORE clause.

Once a schema pair mapping is applied, the result is final. The mapping operation is non-transitive, and therefore the schema chosen will not be subsequently applied to another schema pair mapping.

A schema cannot be mapped more than once, meaning that it cannot appear on the left side of more than one pair.

SAVECOUNT *n*

Specifies that the load utility is to establish consistency points after every *n* rows. This value is converted to a page count, and rounded up to intervals of the extent size. Since a message is issued at each consistency point, this option should be selected if the load operation will be monitored using LOAD QUERY. If the value of *n* is not sufficiently high, the synchronization of activities performed at each consistency point will impact performance.

The default value is zero, meaning that no consistency points will be established, unless necessary.

This option is ignored when specified in conjunction with the CURSOR file type or when loading a table containing an XML column.

ROWCOUNT *n*

Specifies the number of *n* physical records in the file to be loaded. Allows a user to load only the first *n* rows in a file.

WARNINGCOUNT *n*

Stops the load operation after *n* warnings. Set this parameter if no warnings are expected, but verification that the correct file and table are being used is desired. If the load file or the target table is specified incorrectly, the load utility will generate a warning for each row that it attempts to load, which will cause the load to fail. If *n* is zero, or this option is not specified, the load operation will continue regardless of the number of warnings issued. If the load operation is stopped because the threshold of warnings was encountered, another load operation can be started in RESTART mode. The load operation will automatically continue from the last consistency point. Alternatively, another load operation can be initiated in REPLACE mode, starting at the beginning of the input file.

MESSAGES *message-file*

Specifies the destination for warning and error messages that occur during the load operation. If a message file is not specified, messages are written to standard output. If the complete path to the file is not specified, the load utility uses the current directory and the default drive as the destination. If the name of a file that already exists is specified, the utility appends the information.

The message file is usually populated with messages at the end of the load operation and, as such, is not suitable for monitoring the progress of the operation.

TEMPFILES PATH *temp-pathname*

Specifies the name of the path to be used when creating temporary files during a load operation, and should be fully qualified according to the server database partition.

Temporary files take up file system space. Sometimes, this space requirement is quite substantial. Following is an estimate of how much file system space should be allocated for all temporary files:

- 136 bytes for each message that the load utility generates
- 15 KB overhead if the data file contains long field data or LOBs. This quantity can grow significantly if the INSERT option is specified, and there is a large amount of long field or LOB data already in the table.

INSERT

One of four modes under which the load utility can execute. Adds the loaded data to the table without changing the existing table data.

REPLACE

One of four modes under which the load utility can execute. Deletes all existing data from the table, and inserts the loaded data. The table definition and index definitions are not changed. If this option is used when moving data between hierarchies, only the data for an entire hierarchy, not individual subtables, can be replaced.

KEEPDICTIONARY

An existing compression dictionary is preserved across the LOAD REPLACE operation. Provided the table COMPRESS attribute is YES, the newly replaced data is subject to being compressed using the dictionary that existed prior to the invocation of the load. If no dictionary previously existed in the table, a new dictionary is built using the data that is being replaced into the table as long as the table COMPRESS attribute is YES. The amount of data that is required to build the compression dictionary in this case is subject to the policies of ADC. This data is populated into the table as uncompressed. Once the dictionary is inserted into the table, the remaining data to be loaded is subject to being compressed with this dictionary. This is the default parameter. For summary, see Table 1 below.

Table 19. LOAD REPLACE KEEPDICTIONARY

Compress	Table row data dictionary exists	XML storage object dictionary exists ¹	Compression dictionary	Data compression
YES	YES	YES	Preserve table row data and XML dictionaries.	Data to be loaded is subject to compression.
YES	YES	NO	Preserve table row data dictionary and build a new XML dictionary.	Table row data to be loaded is subject to compression. After XML dictionary is built, remaining XML data to be loaded is subject to compression.
YES	NO	YES	Build table row data dictionary and preserve XML dictionary.	After table row data dictionary is built, remaining table row data to be loaded is subject to compression. XML data to be loaded is subject to compression.
YES	NO	NO	Build new table row data and XML dictionaries.	After dictionaries are built, remaining data to be loaded is subject to compression.

Table 19. LOAD REPLACE KEEPDICTIONARY (continued)

Compress	Table row data dictionary exists	XML storage object dictionary exists ¹	Compression dictionary	Data compression
NO	YES	YES	Preserve table row data and XML dictionaries.	Data to be loaded is not compressed.
NO	YES	NO	Preserve table row data dictionary.	Data to be loaded is not compressed.
NO	NO	YES	No effect on table row dictionary. Preserve XML dictionary.	Data to be loaded is not compressed.
NO	NO	NO	No effect.	Data to be loaded is not compressed.

Note:

1. A compression dictionary can be created for the XML storage object of a table only if the XML columns are added to the table in DB2 Version 9.7 or later, or if the table is migrated using an online table move.

RESETDICTIONARY

This directive instructs LOAD REPLACE processing to build a new dictionary for the table data object provided that the table COMPRESS attribute is YES. If the COMPRESS attribute is NO and a dictionary was already present in the table it will be removed and no new dictionary will be inserted into the table. A compression dictionary can be built with just one user record. If the loaded data set size is zero and if there is a pre-existing dictionary, the dictionary will not be preserved. The amount of data required to build a dictionary with this directive is not subject to the policies of ADC. For summary, see Table 2 below.

Table 20. LOAD REPLACE RESETDICTIONARY

Compress	Table row data dictionary exists	XML storage object dictionary exists ¹	Compression dictionary	Data compression
YES	YES	YES	Build new dictionaries ² . If the DATA CAPTURE CHANGES option is enabled on the CREATE TABLE or ALTER TABLE statements, the current table row data dictionary is kept (and referred to as the <i>historical compression dictionary</i>).	After dictionaries are built, remaining data to be loaded is subject to compression.
YES	YES	NO	Build new dictionaries ² . If the DATA CAPTURE CHANGES option is enabled on the CREATE TABLE or ALTER TABLE statements, the current table row data dictionary is kept (and referred to as the <i>historical compression dictionary</i>).	After dictionaries are built, remaining data to be loaded is subject to compression.

Table 20. LOAD REPLACE RESETDICTIONARY (continued)

Compress	Table row data dictionary exists	XML storage object dictionary exists ¹	Compression dictionary	Data compression
YES	NO	YES	Build new dictionaries.	After dictionaries are built, remaining data to be loaded is subject to compression.
YES	NO	NO	Build new dictionaries.	After dictionaries are built, remaining data to be loaded is subject to compression.
NO	YES	YES	Remove dictionaries.	Data to be loaded is not compressed.
NO	YES	NO	Remove table row data dictionary.	Data to be loaded is not compressed.
NO	NO	YES	Remove XML storage object dictionary.	Data to be loaded is not compressed.
NO	NO	NO	No effect.	All table data is not compressed.

Notes:

1. A compression dictionary can be created for the XML storage object of a table only if the XML columns are added to the table in DB2 Version 9.7 or later, or if the table is migrated using an online table move.
2. If a dictionary exists and the compression attribute is enabled, but there are no records to load into the table partition, a new dictionary cannot be built and the RESETDICTIONARY operation will not keep the existing dictionary.

TERMINATE

One of four modes under which the load utility can execute. Terminates a previously interrupted load operation, and rolls back the operation to the point in time at which it started, even if consistency points were passed. The states of any table spaces involved in the operation return to normal, and all table objects are made consistent (index objects might be marked as invalid, in which case index rebuild will automatically take place at next access). If the load operation being terminated is a LOAD REPLACE, the table will be truncated to an empty table after the LOAD TERMINATE operation. If the load operation being terminated is a LOAD INSERT, the table will retain all of its original records after the LOAD TERMINATE operation. For summary of dictionary management, see Table 3 below.

The LOAD TERMINATE option will not remove a backup pending state from table spaces.

RESTART

One of four modes under which the load utility can execute. Restarts a previously interrupted load operation. The load operation will automatically continue from the last consistency point in the load, build, or delete phase. For summary of dictionary management, see Table 4 below.

INTO *table-name*

Specifies the database table into which the data is to be loaded. This table cannot be a system table, a declared temporary table, or a created temporary table. An alias, or the fully qualified or unqualified table name

can be specified. A qualified table name is in the form `schema.tablename`. If an unqualified table name is specified, the table will be qualified with the CURRENT SCHEMA.

insert-column

Specifies the table column into which the data is to be inserted.

The load utility cannot parse columns whose names contain one or more spaces. For example,

```
db2 load from delfile1 of del noheader
method P (1, 2, 3, 4, 5, 6, 7, 8, 9)
insert into table1 (BLOB1, S2, I3, Int 4, I5, I6, DT7, I8, TM9)
```

will fail because of the `Int 4` column. The solution is to enclose such column names with double quotation marks:

```
db2 load from delfile1 of del noheader
method P (1, 2, 3, 4, 5, 6, 7, 8, 9)
insert into table1 (BLOB1, S2, I3, "Int 4", I5, I6, DT7, I8, TM9)
```

FOR EXCEPTION *table-name*

Specifies the exception table into which rows in error will be copied. Any row that is in violation of a unique index or a primary key index is copied. If an unqualified table name is specified, the table will be qualified with the CURRENT SCHEMA.

Information that is written to the exception table is *not* written to the dump file. In a partitioned database environment, an exception table must be defined for those database partitions on which the loading table is defined. The dump file, otherwise, contains rows that cannot be loaded because they are invalid or have syntax errors.

When loading XML data, using the FOR EXCEPTION clause to specify load exception table is not supported in the following cases:

- When using Label-based access control (LBAC).
- When loading a data into a data partitioned table.

NORANGEEXC

Indicates that if a row is rejected because of a range violation it will not be inserted into the exception table.

NOUNIQUEEXC

Indicates that if a row is rejected because it violates a unique constraint it will not be inserted into the exception table.

STATISTICS USE PROFILE

Instructs load to collect statistics during the load according to the profile defined for this table. This profile must be created before load is executed. The profile is created by the RUNSTATS command. If the profile does not exist and load is instructed to collect statistics according to the profile, a warning is returned and no statistics are collected.

STATISTICS NO

Specifies that no statistics are to be collected, and that the statistics in the catalogs are not to be altered. This is the default.

COPY NO

Specifies that the table space in which the table resides will be placed in backup pending state if forward recovery is enabled (that is, *logretain* or *userexit* is on). The COPY NO option will also put the table space state into the Load in Progress table space state. This is a transient state that will disappear when the load completes or aborts. The data in any table in the

table space cannot be updated or deleted until a table space backup or a full database backup is made. However, it is possible to access the data in any table by using the SELECT statement.

LOAD with COPY NO on a recoverable database leaves the table spaces in a backup pending state. For example, performing a LOAD with COPY NO and INDEXING MODE DEFERRED will leave indexes needing a refresh. Certain queries on the table might require an index scan and will not succeed until the indexes are refreshed. The index cannot be refreshed if it resides in a table space which is in the backup pending state. In that case, access to the table will not be allowed until a backup is taken. Index refresh is done automatically by the database when the index is accessed by a query. If one of COPY NO, COPY YES, or NONRECOVERABLE is not specified, and the database is recoverable (**logretain** or **logarchmeth1** is enabled), then COPY NO is the default.

COPY YES

Specifies that a copy of the loaded data will be saved. This option is invalid if forward recovery is disabled.

USE TSM

Specifies that the copy will be stored using Tivoli Storage Manager (TSM).

OPEN *num-sess* SESSIONS

The number of I/O sessions to be used with TSM or the vendor product. The default value is 1.

TO *device/directory*

Specifies the device or directory on which the copy image will be created.

LOAD *lib-name*

The name of the shared library (DLL on Windows operating systems) containing the vendor backup and restore I/O functions to be used. It can contain the full path. If the full path is not given, it will default to the path where the user exit programs reside.

NONRECOVERABLE

Specifies that the load transaction is to be marked as non-recoverable and that it will not be possible to recover it by a subsequent roll forward action. The roll forward utility will skip the transaction and will mark the table into which data was being loaded as "invalid". The utility will also ignore any subsequent transactions against that table. After the roll forward operation is completed, such a table can only be dropped or restored from a backup (full or table space) taken after a commit point following the completion of the non-recoverable load operation.

With this option, table spaces are not put in backup pending state following the load operation, and a copy of the loaded data does not have to be made during the load operation. If one of COPY NO, COPY YES, or NONRECOVERABLE is not specified, and the database is not recoverable (**logretain** or **logarchmeth1** is not enabled), then NONRECOVERABLE is the default.

WITHOUT PROMPTING

Specifies that the list of data files contains all the files that are to be loaded, and that the devices or directories listed are sufficient for the entire load operation. If a continuation input file is not found, or the copy targets

are filled before the load operation finishes, the load operation will fail, and the table will remain in load pending state.

If this option is not specified, and the tape device encounters an end of tape for the copy image, or the last item listed is a tape device, the user is prompted for a new tape on that device.

DATA BUFFER *buffer-size*

Specifies the number of 4 KB pages (regardless of the degree of parallelism) to use as buffered space for transferring data within the utility. If the value specified is less than the algorithmic minimum, the minimum required resource is used, and no warning is returned.

This memory is allocated directly from the utility heap, whose size can be modified through the *util_heap_sz* database configuration parameter.

If a value is not specified, an intelligent default is calculated by the utility at run time. The default is based on a percentage of the free space available in the utility heap at the instantiation time of the loader, as well as some characteristics of the table.

SORT BUFFER *buffer-size*

This option specifies a value that overrides the SORTHEAP database configuration parameter during a load operation. It is relevant only when loading tables with indexes and only when the INDEXING MODE parameter is not specified as DEFERRED. The value that is specified cannot exceed the value of SORTHEAP. This parameter is useful for throttling the sort memory that is used when loading tables with many indexes without changing the value of SORTHEAP, which would also affect general query processing.

CPU_PARALLELISM *n*

Specifies the number of processes or threads that the load utility will create for parsing, converting, and formatting records when building table objects. This parameter is designed to exploit the number of processes running per database partition. It is particularly useful when loading presorted data, because record order in the source data is preserved. If the value of this parameter is zero, or has not been specified, the load utility uses an intelligent default value (usually based on the number of CPUs available) at run time.

Note:

1. If this parameter is used with tables containing either LOB or LONG VARCHAR fields, its value becomes one, regardless of the number of system CPUs or the value specified by the user.
2. Specifying a small value for the SAVECOUNT parameter causes the loader to perform many more I/O operations to flush both data and table metadata. When CPU_PARALLELISM is greater than one, the flushing operations are asynchronous, permitting the loader to exploit the CPU. When CPU_PARALLELISM is set to one, the loader waits on I/O during consistency points. A load operation with CPU_PARALLELISM set to two, and SAVECOUNT set to 10 000, completes faster than the same operation with CPU_PARALLELISM set to one, even though there is only one CPU.

DISK_PARALLELISM *n*

Specifies the number of processes or threads that the load utility will create for writing data to the table space containers. If a value is not specified, the

utility selects an intelligent default based on the number of table space containers and the characteristics of the table.

FETCH_PARALLELISM YES | NO

When performing a load from a cursor where the cursor is declared using the DATABASE keyword, or when using the API `sqlu_remotefetch_entry` media entry, and this option is set to YES, the load utility attempts to parallelize fetching from the remote data source if possible. If set to NO, no parallel fetching is performed. The default value is YES. For more information, see *Moving data using the CURSOR file type*.

INDEXING MODE

Specifies whether the load utility is to rebuild indexes or to extend them incrementally. Valid values are:

AUTOSELECT

The load utility will automatically decide between REBUILD or INCREMENTAL mode. The decision is based on the amount of data being loaded and the depth of the index tree. Information relating to the depth of the index tree is stored in the index object. RUNSTATS is not required to populate this information. AUTOSELECT is the default indexing mode.

REBUILD

All indexes will be rebuilt. The utility must have sufficient resources to sort all index key parts for both old and appended table data.

INCREMENTAL

Indexes will be extended with new data. This approach consumes index free space. It only requires enough sort space to append index keys for the inserted records. This method is only supported in cases where the index object is valid and accessible at the start of a load operation (it is, for example, not valid immediately following a load operation in which the DEFERRED mode was specified). If this mode is specified, but not supported due to the state of the index, a warning is returned, and the load operation continues in REBUILD mode. Similarly, if a load restart operation is begun in the load build phase, INCREMENTAL mode is not supported.

Incremental indexing is not supported when all of the following conditions are true:

- The LOAD COPY option is specified (*logarchmeth1* with the USEREXIT or LOGRETAIN option).
- The table resides in a DMS table space.
- The index object resides in a table space that is shared by other table objects belonging to the table being loaded.

To bypass this restriction, it is recommended that indexes be placed in a separate table space.

DEFERRED

The load utility will not attempt index creation if this mode is specified. Indexes will be marked as needing a refresh. The first access to such indexes that is unrelated to a load operation might force a rebuild, or indexes might be rebuilt when the database is restarted. This approach requires enough sort space for all key parts for the largest index. The total time subsequently taken for

index construction is longer than that required in REBUILD mode. Therefore, when performing multiple load operations with deferred indexing, it is advisable (from a performance viewpoint) to let the last load operation in the sequence perform an index rebuild, rather than allow indexes to be rebuilt at first non-load access.

Deferred indexing is only supported for tables with non-unique indexes, so that duplicate keys inserted during the load phase are not persistent after the load operation.

ALLOW NO ACCESS

Load will lock the target table for exclusive access during the load. The table state will be set to Load In Progress during the load. ALLOW NO ACCESS is the default behavior. It is the only valid option for LOAD REPLACE.

When there are constraints on the table, the table state will be set to Set Integrity Pending as well as Load In Progress. The SET INTEGRITY statement must be used to take the table out of Set Integrity Pending state.

ALLOW READ ACCESS

Load will lock the target table in a share mode. The table state will be set to both Load In Progress and Read Access. Readers can access the non-delta portion of the data while the table is being load. In other words, data that existed before the start of the load will be accessible by readers to the table, data that is being loaded is not available until the load is complete. LOAD TERMINATE or LOAD RESTART of an ALLOW READ ACCESS load can use this option; LOAD TERMINATE or LOAD RESTART of an ALLOW NO ACCESS load cannot use this option. Furthermore, this option is not valid if the indexes on the target table are marked as requiring a rebuild.

When there are constraints on the table, the table state will be set to Set Integrity Pending as well as Load In Progress, and Read Access. At the end of the load, the table state Load In Progress will be removed but the table states Set Integrity Pending and Read Access will remain. The SET INTEGRITY statement must be used to take the table out of Set Integrity Pending. While the table is in Set Integrity Pending and Read Access states, the non-delta portion of the data is still accessible to readers, the new (delta) portion of the data will remain inaccessible until the SET INTEGRITY statement has completed. A user can perform multiple loads on the same table without issuing a SET INTEGRITY statement. Only the original (checked) data will remain visible, however, until the SET INTEGRITY statement is issued.

ALLOW READ ACCESS also supports the following modifiers:

USE *tablespace-name*

If the indexes are being rebuilt, a shadow copy of the index is built in table space *tablespace-name* and copied over to the original table space at the end of the load during an INDEX COPY PHASE. Only system temporary table spaces can be used with this option. If not specified then the shadow index will be created in the same table space as the index object. If the shadow copy is created in the same table space as the index object, the copy of the shadow index object over the old index object is instantaneous. If the shadow copy is in a different table space from the index object a physical copy is

performed. This could involve considerable I/O and time. The copy happens while the table is offline at the end of a load during the INDEX COPY PHASE.

Without this option the shadow index is built in the same table space as the original. Since both the original index and shadow index by default reside in the same table space simultaneously, there might be insufficient space to hold both indexes within one table space. Using this option ensures that you retain enough table space for the indexes.

This option is ignored if the user does not specify INDEXING MODE REBUILD or INDEXING MODE AUTOSELECT. This option will also be ignored if INDEXING MODE AUTOSELECT is chosen and load chooses to incrementally update the index.

SET INTEGRITY PENDING CASCADE

If LOAD puts the table into Set Integrity Pending state, the SET INTEGRITY PENDING CASCADE option allows the user to specify whether or not Set Integrity Pending state of the loaded table is immediately cascaded to all descendents (including descendent foreign key tables, descendent immediate materialized query tables and descendent immediate staging tables).

IMMEDIATE

Indicates that Set Integrity Pending state is immediately extended to all descendent foreign key tables, descendent immediate materialized query tables and descendent staging tables. For a LOAD INSERT operation, Set Integrity Pending state is not extended to descendent foreign key tables even if the IMMEDIATE option is specified.

When the loaded table is later checked for constraint violations (using the IMMEDIATE CHECKED option of the SET INTEGRITY statement), descendent foreign key tables that were placed in Set Integrity Pending Read Access state will be put into Set Integrity Pending No Access state.

DEFERRED

Indicates that only the loaded table will be placed in the Set Integrity Pending state. The states of the descendent foreign key tables, descendent immediate materialized query tables and descendent immediate staging tables will remain unchanged.

Descendent foreign key tables might later be implicitly placed in Set Integrity Pending state when their parent tables are checked for constraint violations (using the IMMEDIATE CHECKED option of the SET INTEGRITY statement). Descendent immediate materialized query tables and descendent immediate staging tables will be implicitly placed in Set Integrity Pending state when one of its underlying tables is checked for integrity violations. A warning (SQLSTATE 01586) will be issued to indicate that dependent tables have been placed in Set Integrity Pending state. See the Notes section of the SET INTEGRITY statement in the SQL Reference for when these descendent tables will be put into Set Integrity Pending state.

If the SET INTEGRITY PENDING CASCADE option is not specified:

- Only the loaded table will be placed in Set Integrity Pending state. The state of descendent foreign key tables, descendent immediate

materialized query tables and descendent immediate staging tables will remain unchanged, and can later be implicitly put into Set Integrity Pending state when the loaded table is checked for constraint violations.

If LOAD does not put the target table into Set Integrity Pending state, the SET INTEGRITY PENDING CASCADE option is ignored.

LOCK WITH FORCE

The utility acquires various locks including table locks in the process of loading. Rather than wait, and possibly timeout, when acquiring a lock, this option allows load to force off other applications that hold conflicting locks on the target table. Applications holding conflicting locks on the system catalog tables will not be forced off by the load utility. Forced applications will roll back and release the locks the load utility needs. The load utility can then proceed. This option requires the same authority as the FORCE APPLICATIONS command (SYSADM or SYSCTRL).

ALLOW NO ACCESS loads might force applications holding conflicting locks at the start of the load operation. At the start of the load the utility can force applications that are attempting to either query or modify the table.

ALLOW READ ACCESS loads can force applications holding conflicting locks at the start or end of the load operation. At the start of the load the load utility can force applications that are attempting to modify the table. At the end of the load operation, the load utility can force applications that are attempting to either query or modify the table.

SOURCEUSEREXIT *executable*

Specifies an executable filename which will be called to feed data into the utility.

REDIRECT

INPUT FROM

BUFFER *input-buffer*

The stream of bytes specified in *input-buffer* is passed into the STDIN file descriptor of the process executing the given executable.

FILE *input-file*

The contents of this client-side file are passed into the STDIN file descriptor of the process executing the given executable.

OUTPUT TO

FILE *output-file*

The STDOUT and STDERR file descriptors are captured to the fully qualified server-side file specified.

PARALLELIZE

Increases the throughput of data coming into the load utility by invoking multiple user exit processes simultaneously. This option is only applicable in multi-partition database environments and is ignored in single-partition database environments.

For more information, see *Moving data using a customized application (user exit)*.

PARTITIONED DB CONFIG *partitioned-db-option*

Allows you to execute a load into a table distributed across multiple database partitions. The PARTITIONED DB CONFIG parameter allows you to specify partitioned database-specific configuration options. The *partitioned-db-option* values can be any of the following:

```
PART_FILE_LOCATION x
OUTPUT_DBPARTNUMS x
PARTITIONING_DBPARTNUMS x
MODE x
MAX_NUM_PART_AGENTS x
ISOLATE_PART_ERRS x
STATUS_INTERVAL x
PORT_RANGE x
CHECK_TRUNCATION
MAP_FILE_INPUT x
MAP_FILE_OUTPUT x
TRACE x
NEWLINE
DISTFILE x
OMIT_HEADER
RUN_STAT_DBPARTNUM x
```

Detailed descriptions of these options are provided in *Load configuration options for partitioned database environments*.

RESTARTCOUNT

Reserved.

USING *directory*

Reserved.

Examples

Example 1

TABLE1 has 5 columns:

- COL1 VARCHAR 20 NOT NULL WITH DEFAULT
- COL2 SMALLINT
- COL3 CHAR 4
- COL4 CHAR 2 NOT NULL WITH DEFAULT
- COL5 CHAR 2 NOT NULL

ASCFILE1 has 7 elements:

- ELE1 positions 01 to 20
- ELE2 positions 21 to 22
- ELE3 positions 23 to 23
- ELE4 positions 24 to 27
- ELE5 positions 28 to 31
- ELE6 positions 32 to 32
- ELE7 positions 33 to 40

Data Records:

```
1...5....10....15....20....25....30....35....40
Test data 1          XXN 123abcdN
Test data 2 and 3   QQY   wxyzN
Test data 4,5 and 6 WWN6789   Y
```

The following command loads the table from the file:

```
db2 load from ascfile1 of asc modified by striptblanks reclen=40
method L (1 20, 21 22, 24 27, 28 31)
null indicators (0,0,23,32)
insert into table1 (col1, col5, col2, col3)
```

Note:

1. The specification of `striptblanks` in the `MODIFIED BY` parameter forces the truncation of blanks in `VARCHAR` columns (`COL1`, for example, which is 11, 17 and 19 bytes long, in rows 1, 2 and 3, respectively).
2. The specification of `reclen=40` in the `MODIFIED BY` parameter indicates that there is no new-line character at the end of each input record, and that each record is 40 bytes long. The last 8 bytes are not used to load the table.
3. Since `COL4` is not provided in the input file, it will be inserted into `TABLE1` with its default value (it is defined `NOT NULL WITH DEFAULT`).
4. Positions 23 and 32 are used to indicate whether `COL2` and `COL3` of `TABLE1` will be loaded `NULL` for a given row. If there is a `Y` in the column's null indicator position for a given record, the column will be `NULL`. If there is an `N`, the data values in the column's data positions of the input record (as defined in `L(.....)`) are used as the source of column data for the row. In this example, neither column in row 1 is `NULL`; `COL2` in row 2 is `NULL`; and `COL3` in row 3 is `NULL`.
5. In this example, the `NULL INDICATORS` for `COL1` and `COL5` are specified as 0 (zero), indicating that the data is not nullable.
6. The `NULL INDICATOR` for a given column can be anywhere in the input record, but the position must be specified, and the `Y` or `N` values must be supplied.

Example 2 (Loading LOBs from Files)

`TABLE1` has 3 columns:

- `COL1 CHAR 4 NOT NULL WITH DEFAULT`
- `LOB1 LOB`
- `LOB2 LOB`

`ASCFILE1` has 3 elements:

- `ELE1` positions 01 to 04
- `ELE2` positions 06 to 13
- `ELE3` positions 15 to 22

The following files reside in either `/u/user1` or `/u/user1/bin`:

- `ASCFILE2` has LOB data
- `ASCFILE3` has LOB data
- `ASCFILE4` has LOB data
- `ASCFILE5` has LOB data
- `ASCFILE6` has LOB data
- `ASCFILE7` has LOB data

Data Records in `ASCFILE1`:

```

1...5...10...15...20...25...30.
REC1 ASCFILE2 ASCFILE3
REC2 ASCFILE4 ASCFILE5
REC3 ASCFILE6 ASCFILE7

```

The following command loads the table from the file:

```

db2 load from ascfile1 of asc
  lobs from /u/user1, /u/user1/bin
  modified by lobsinfile reclen=22
  method L (1 4, 6 13, 15 22)
  insert into table1

```

Note:

1. The specification of lobsinfile in the MODIFIED BY parameter tells the loader that all LOB data is to be loaded from files.
2. The specification of reclen=22 in the MODIFIED BY parameter indicates that there is no new-line character at the end of each input record, and that each record is 22 bytes long.
3. LOB data is contained in 6 files, ASCFILE2 through ASCFILE7. Each file contains the data that will be used to load a LOB column for a specific row. The relationship between LOBs and other data is specified in ASCFILE1. The first record of this file tells the loader to place REC1 in COL1 of row 1. The contents of ASCFILE2 will be used to load LOB1 of row 1, and the contents of ASCFILE3 will be used to load LOB2 of row 1. Similarly, ASCFILE4 and ASCFILE5 will be used to load LOB1 and LOB2 of row 2, and ASCFILE6 and ASCFILE7 will be used to load the LOBs of row 3.
4. The LOBS FROM parameter contains 2 paths that will be searched for the named LOB files when those files are required by the loader.
5. To load LOBs directly from ASCFILE1 (a non-delimited ASCII file), without the lobsinfile modifier, the following rules must be observed:
 - The total length of any record, including LOBs, cannot exceed 32 KB.
 - LOB fields in the input records must be of fixed length, and LOB data padded with blanks as necessary.
 - The striptblanks modifier must be specified, so that the trailing blanks used to pad LOBs can be removed as the LOBs are inserted into the database.

Example 3 (Using Dump Files)

Table FRIENDS is defined as:

```
table friends "( c1 INT NOT NULL, c2 INT, c3 CHAR(8) )"
```

If an attempt is made to load the following data records into this table,

```

23, 24, bobby
, 45, john
4,, mary

```

the second row is rejected because the first INT is NULL, and the column definition specifies NOT NULL. Columns which contain initial characters that are not consistent with the DEL format will generate an error, and the record will be rejected. Such records can be written to a dump file.

DEL data appearing in a column outside of character delimiters is ignored, but does generate a warning. For example:

```

22,34,"bob"
24,55,"sam" sdf

```

The utility will load "sam" in the third column of the table, and the characters "sdf" will be flagged in a warning. The record is not rejected. Another example:

```
22 3, 34,"bob"
```

The utility will load 22,34,"bob", and generate a warning that some data in column one following the 22 was ignored. The record is not rejected.

Example 4 (Loading a Table with an Identity Column)

TABLE1 has 4 columns:

- C1 VARCHAR(30)
- C2 INT GENERATED BY DEFAULT AS IDENTITY
- C3 DECIMAL(7,2)
- C4 CHAR(1)

TABLE2 is the same as TABLE1, except that C2 is a GENERATED ALWAYS identity column.

Data records in DATAFILE1 (DEL format):

```
"Liszt"  
"Hummel",,187.43, H  
"Grieg",100, 66.34, G  
"Satie",101, 818.23, I
```

Data records in DATAFILE2 (DEL format):

```
"Liszt", 74.49, A  
"Hummel", 0.01, H  
"Grieg", 66.34, G  
"Satie", 818.23, I
```

Note:

1. The following command generates identity values for rows 1 and 2, since no identity values are supplied in DATAFILE1 for those rows. Rows 3 and 4, however, are assigned the user-supplied identity values of 100 and 101, respectively.

```
db2 load from datafile1.del of del replace into table1
```
2. To load DATAFILE1 into TABLE1 so that identity values are generated for all rows, issue one of the following commands:

```
db2 load from datafile1.del of del method P(1, 3, 4)  
replace into table1 (c1, c3, c4)  
db2 load from datafile1.del of del modified by identityignore  
replace into table1
```
3. To load DATAFILE2 into TABLE1 so that identity values are generated for each row, issue one of the following commands:

```
db2 load from datafile2.del of del replace into table1 (c1, c3, c4)  
db2 load from datafile2.del of del modified by identitymissing  
replace into table1
```
4. To load DATAFILE1 into TABLE2 so that the identity values of 100 and 101 are assigned to rows 3 and 4, issue the following command:

```
db2 load from datafile1.del of del modified by identityoverride  
replace into table2
```

In this case, rows 1 and 2 will be rejected, because the utility has been instructed to override system-generated identity values in favor of

user-supplied values. If user-supplied values are not present, however, the row must be rejected, because identity columns are implicitly not NULL.

5. If DATAFILE1 is loaded into TABLE2 without using any of the identity-related file type modifiers, rows 1 and 2 will be loaded, but rows 3 and 4 will be rejected, because they supply their own non-NULL values, and the identity column is GENERATED ALWAYS.

Example 5 (Loading a Table with a Row Change Timestamp Column)

TABLE1 has 4 columns:

- C1 VARCHAR(30)
- C2 ROW CHANGE TIMESTAMP GENERATED BY DEFAULT
- C3 DECIMAL(7,2)
- C4 CHAR(1)

TABLE2 is the same as TABLE1, except that C2 is a GENERATED ALWAYS column.

Data records in DATAFILE1 (DEL format):

```
"Liszt"  
"Hummel",,187.43, H  
"Grieg", 2006-05-23-15.55.53.209971, 66.34, G  
"Satie", 2006-05-22-19.34.14.947681, 818.23, I
```

Data records in DATAFILE2 (DEL format):

```
"Liszt", 74.49, A  
"Hummel", 0.01, H  
"Grieg", 66.34, G  
"Satie", 818.23, I
```

Note:

1. The following command generates ROW CHANGE TIMESTAMP values for rows 1 and 2, since no ROW CHANGE TIMESTAMP values are supplied in DATAFILE1 for those rows. Rows 3 and 4, however, are assigned the user-supplied ROW CHANGE TIMESTAMP values of 2006-05-23-15.55.53.209971 and 2006-05-22-19.34.14.947681, respectively.

```
db2 load from datafile1.del of del replace into table1
```
2. To load DATAFILE1 into TABLE1 so that ROW CHANGE TIMESTAMP values are generated for all rows, issue one of the following commands:

```
db2 load from datafile1.del of del method P(1, 3, 4) replace into table1  
(c1, c3, c4)
```



```
db2 load from datafile1.del of del modified by rowchangetimestampignore  
replace into table1
```
3. To load DATAFILE2 into TABLE1 so that ROW CHANGE TIMESTAMP values are generated for each row, issue one of the following commands:

```
db2 load from datafile2.del of del replace into table1 (c1, c3, c4)
```



```
db2 load from datafile2.del of del modified by rowchangetimestampmissing  
replace into table1
```
4. To load DATAFILE1 into TABLE2 so that the ROW CHANGE TIMESTAMP values of 2006-05-23-15.55.53.209971 and 2006-05-22-19.34.14.947681 are assigned to rows 3 and 4, issue the following command:

```
db2 load from datafile1.del of del modified by rowchangetimestampoverride  
replace into table2
```

In this case, rows 1 and 2 will be rejected, because the utility has been instructed to override system-generated ROW CHANGE TIMESTAMP values in favor of user-supplied values. If user-supplied values are not present, however, the row must be rejected, because row change timestamp columns are implicitly not NULL.

5. If DATAFILE1 is loaded into TABLE2 without using any of the ROW CHANGE related file type modifiers, rows 1 and 2 will be loaded, but rows 3 and 4 will be rejected, because they supply their own non-NULL values, and the row change timestamp column is GENERATED ALWAYS.

Example 6 (Loading using the CURSOR file type)

Table ABC.TABLE1 has 3 columns:

```
ONE INT
TWO CHAR(10)
THREE DATE
```

Table ABC.TABLE2 has 3 columns:

```
ONE VARCHAR
TWO INT
THREE DATE
```

Executing the following commands will load all the data from ABC.TABLE1 into ABC.TABLE2:

```
db2 declare mycurs cursor for select two,one,three from abc.table1
db2 load from mycurs of cursor insert into abc.table2
```

If ABC.TABLE1 resides in a database different from the database ABC.TABLE2 is in, the DATABASE, USER, and USING options of the DECLARE CURSOR command can be used to perform the load. For example, if ABC.TABLE1 resides in database DB1, and the user ID and password for DB1 are user1 and pwd1 respectively, executing the following commands will load all the data from ABC.TABLE1 into ABC.TABLE2:

```
db2 declare mycurs cursor database DB1 user user1 using pwd1
for select two,one,three from abc.table1
db2 load from mycurs of cursor insert into abc.table2
```

Examples of loading data from XML documents

Loading XML data

Example 1

The user has constructed a data file with XDS fields to describe the documents that are to be inserted into the table. It might appear like this :

```
1, "<XDS FIL=""file1.xml"" />"
2, "<XDS FIL='file2.xml' OFF='23' LEN='45' />"
```

For the first row, the XML document is identified by the file named file1.xml. Note that since the character delimiter is the double quote character, and double quotation marks exist inside the XDS, the double quotation marks contained within the XDS are doubled. For the second row, the XML document is identified by the file named file2.xml, and starts at byte offset 23, and is 45 bytes in length.

Example 2

The user issues a load command without any parsing or validation options for the XML column, and the data is loaded successfully:

```
LOAD FROM data.del of DEL INSERT INTO mytable
```

Loading XML data from CURSOR

Loading data from cursor is the same as with a regular relational column type. The user has two tables, T1 and T2, each of which consist of a single XML column named C1. To LOAD from T1 into T2, the user will first declare a cursor:

```
DECLARE X1 CURSOR FOR SELECT C1 FROM T1;
```

Next, the user may issue a LOAD using the cursor type :

```
LOAD FROM X1 of CURSOR INSERT INTO T2
```

Applying the XML specific LOAD options to the cursor type is the same as loading from a file.

Examples of using the XMLVALIDATE clause

XMLVALIDATE USING XDS

Example 1

```
USING XDS DEFAULT schema-sqlid
```

The user would like to validate according to the schema indicated in the XDS. If there are any XDS values without SCH attributes, these documents will be validated against the schema that is used in this clause.

```
XMLVALIDATE USING XDS DEFAULT S1.SCHEMA_B
```

Example 2

The user would like to validate but IGNORE certain schemas that are mentioned in the XDS.

```
XMLVALIDATE USING XDS IGNORE S1.SCHEMA_C
```

Example 3

The user would like to validate but remap some of the schemas in the XDS.

```
XMLVALIDATE USING XDS MAP( (S1.SCHEMA_A, S2.SCHEMA_B ), (S3.SCHEMA_C, S5.SCHEMA_E) )
```

Given the above XDS, any document with an SCH attribute of S1.SCHEMA_A will be validated against S2.SCHEMA_B. Also, any document with an SCH attribute of S3.SCHEMA_C will be validated against S5.SCHEMA_E.

Example 4

The user would like to use a combination of the DEFAULT, IGNORE, and MAP options:

```
XMLVALIDATE USING XDS
  DEFAULT S8.SCHEMA_H
  IGNORE (S9.SCHEMA_I, S10.SCHEMA_J)
  MAP ((S1.SCHEMA_A, S2.SCHEMA_B), (S3.SCHEMA_C, S5.SCHEMA_E),
       (S6.SCHEMA_F, S3.SCHEMA_C), (S4.SCHEMA_D, S7.SCHEMA_G))
```

For an XML column that contains the following XDS:

```
<XDS FIL='xmlfile.001.xml' />
```

The XML schema with SQL identifier "S8.SCHEMA_H" is used to validate the document in file `xmlfile.001.xml`, since "S8.SCHEMA_H" was specified as the default schema to use.

For an XML column that contains the following XDS:

```
<XDS FIL='xmlfile.002.xml' OFF='10' LEN='500' SCH='S10.SCHEMA_J' />
```

No schema validation occurs for the document in file `xmlfile.002.xml`, since although the XDS specifies "S10.SCHEMA_J" as the schema to use, that schema is part of the IGNORE clause. The document contents can be found at byte offset 10 in the file (meaning the 11th byte), and is 500 bytes long.

For an XML column that contains the following XDS:

```
<XDS FIL='xmlfile.003.xml' SCH='S6.SCHEMA_F' />
```

The XML schema with SQL identifier "S3.SCHEMA_C" is used to validate the document in file `xmlfile.003.xml`. This is because the MAP clause specifies that schema "S6.SCHEMA_F" should be mapped to schema "S3.SCHEMA_C". Note that further mapping does not take place, therefore the mapping of schema "S3.SCHEMA_C" to schema "S5.SCHEMA_E" does not apply in this case.

For an XML column that contains the following XDS:

```
<XDS FIL='xmlfile.004.xml' SCH='S11.SCHEMA_K' />
```

The XML schema with SQL identifier "S11.SCHEMA_K" is used to validate the document in file `xmlfile.004.xml`. Note that none of the DEFAULT, IGNORE, or MAP specifications apply in this case.

XMLVALIDATE USING SCHEMA

The user wants to validate all XML documents according to a single SCHEMA. For the following XMLVALIDATE clause:

```
XMLVALIDATE USING SCHEMA S2.SCHEMA_B
```

For an XML column that contains the following XDS:

```
<XDS FIL='xmlfile.001.xml' />
```

The document in file `xmlfile.001.xml` is validated using the XML schema with SQL identifier "S2.SCHEMA_B".

For an XML column that contains the following XDS:

```
<XDS FIL='xmlfile.002.xml' SCH='S1.SCHEMA_A' />
```

The document in file `xmlfile.002.xml` is validated using the XML schema with SQL identifier "S2.SCHEMA_B". Note that the SCH attribute is ignored, since validation is being performed using a schema specified by the USING SCHEMA clause.

XMLVALIDATE USING SCHEMALOCATION HINTS

The user would like to validate against schema information located within the document itself. For the following XMLVALIDATE clause:

```
XMLVALIDATE USING SCHEMALOCATION HINTS
```

For an XML column that contains the following XDS:

```
<XDS FIL='xmlfile.001.xml' />
```

The XML schema used is determined by the schemaLocation attribute in the document contents, and no validation would occur if one is not present.

For an XML column that contains the following XDS:

```
<XDS FIL='xmlfile.002.xml' SCH='S1.SCHEMA_A' />
```

The XML schema used is determined by the schemaLocation attribute in the document contents, and no validation would occur if one is not present. Note that the SCH attribute is ignored, since validation is being performed using SCHEMALOCATION HINTS.

Usage notes

- Data is loaded in the sequence that appears in the input file. If a particular sequence is desired, the data should be sorted before a load is attempted. If preservation of the source data order is not required, consider using the ANYORDER file type modifier, described below in the *File type modifiers for the load utility* section.
- The load utility builds indexes based on existing definitions. The exception tables are used to handle duplicates on unique keys. The utility does not enforce referential integrity, perform constraints checking, or update materialized query tables that are dependent on the tables being loaded. Tables that include referential or check constraints are placed in Set Integrity Pending state. Summary tables that are defined with REFRESH IMMEDIATE, and that are dependent on tables being loaded, are also placed in Set Integrity Pending state. Issue the SET INTEGRITY statement to take the tables out of Set Integrity Pending state. Load operations cannot be carried out on replicated materialized query tables.
- If a clustering index exists on the table, the data should be sorted on the clustering index prior to loading. Data does not need to be sorted prior to loading into a multidimensional clustering (MDC) table, however.
- If you specify an exception table when loading into a protected table, any rows that are protected by invalid security labels will be sent to that table. This might allow users that have access to the exception table to access to data that they would not normally be authorized to access. For better security be careful who you grant exception table access to, delete each row as soon as it is repaired and copied to the table being loaded, and drop the exception table as soon as you are done with it.
- Security labels in their internal format might contain newline characters. If you load the file using the DEL file format, those newline characters can be mistaken for delimiters. If you have this problem use the older default priority for delimiters by specifying the delprioritychar file type modifier in the LOAD command.
- For performing a load using the CURSOR file type where the DATABASE keyword was specified during the DECLARE CURSOR command, the user ID and

password used to authenticate against the database currently connected to (for the load) will be used to authenticate against the source database (specified by the DATABASE option of the DECLARE CURSOR command). If no user ID or password was specified for the connection to the loading database, a user ID and password for the source database must be specified during the DECLARE CURSOR command.

- Loading a multiple-part PC/IXF file whose individual parts are copied from a Windows system to an AIX system is supported. The names of all the files must be specified in the LOAD command. For example, LOAD FROM DATA.IXF, DATA.002 OF IXF INSERT INTO TABLE1. Loading to the Windows operating system from logically split PC/IXF files is not supported.
- When restarting a failed LOAD, the behavior will follow the existing behavior in that the BUILD phase will be forced to use the REBUILD mode for indexes.
- Loading XML documents between databases is not supported and returns error message SQL1407N.

Summary of LOAD TERMINATE and LOAD RESTART dictionary management

The following chart summarizes the compression dictionary management behavior for LOAD processing under the TERMINATE directive.

Table 21. LOAD TERMINATE dictionary management

Table COMPRESS attribute	Does table row data dictionary exist prior to LOAD?	XML storage object dictionary exists prior to LOAD ¹	TERMINATE: LOAD REPLACE KEEPDICTIONARY or LOAD INSERT	TERMINATE: LOAD REPLACE RESETDICTIONARY
YES	YES	YES	Keep existing dictionaries.	Neither dictionary is kept. ²
YES	YES	NO	Keep existing dictionary.	Nothing is kept. ²
YES	NO	YES	Keep existing dictionary.	Nothing is kept.
YES	NO	NO	Nothing is kept.	Nothing is kept.
NO	YES	YES	Keep existing dictionaries.	Nothing is kept.
NO	YES	NO	Keep existing dictionary.	Nothing is kept.
NO	NO	YES	Keep existing dictionary.	Nothing is kept.
NO	NO	NO	Do nothing.	Do nothing.

Note:

1. A compression dictionary can be created for the XML storage object of a table only if the XML columns are added to the table in DB2 Version 9.7 or later, or if the table is migrated using an online table move.
2. In the special case that the table has data capture enabled, the table row data dictionary is kept.

LOAD RESTART truncates a table up to the last consistency point reached. As part of LOAD RESTART processing, a compression dictionary will exist in the table if it was present in the table at the time the last LOAD consistency point was taken. In that case, LOAD RESTART will not create a new dictionary. For a summary of the possible conditions, see Table 4 below.

Table 22. LOAD RESTART dictionary management

Table COMPRESS Attribute	Table row data dictionary exist prior to LOAD consistency point? ¹	XML Storage object dictionary existed prior to last LOAD? ²	RESTART: LOAD REPLACE KEEPDICTIONARY or LOAD INSERT	RESTART: LOAD REPLACE RESETDICTIONARY
YES	YES	YES	Keep existing dictionaries.	Keep existing dictionaries.
YES	YES	NO	Keep existing table row data dictionary and build XML dictionary subject to ADC.	Keep existing table row data dictionary and build XML dictionary.
YES	NO	YES	Build table row data dictionary subject to ADC. Keep existing XML dictionary.	Build table row data dictionary. Keep existing XML dictionary.
YES	NO	NO	Build table row data and XML dictionaries subject to ADC.	Build table row data and XML dictionaries.
NO	YES	YES	Keep existing dictionaries.	Remove existing dictionaries.
NO	YES	NO	Keep existing table row data dictionary.	Remove existing table row data dictionary.
NO	NO	YES	Keep existing XML dictionary.	Remove existing XML dictionary.
NO	NO	NO	Do nothing.	Do nothing.

Notes:

1. The SAVECOUNT option is ignored when loading XML data, load operations that fail during the load phase restart from the beginning of the operation.
2. A compression dictionary can be created for the XML storage object of a table only if the XML columns are added to the table in DB2 Version 9.7 or later, or if the table is migrated using an online table move.

File type modifiers for the load utility

Table 23. Valid file type modifiers for the load utility: All file formats

Modifier	Description
anyorder	This modifier is used in conjunction with the <i>cpu_parallelism</i> parameter. Specifies that the preservation of source data order is not required, yielding significant additional performance benefit on SMP systems. If the value of <i>cpu_parallelism</i> is 1, this option is ignored. This option is not supported if SAVECOUNT > 0, since crash recovery after a consistency point requires that data be loaded in sequence.
generatedignore	This modifier informs the load utility that data for all generated columns is present in the data file but should be ignored. This results in all generated column values being generated by the utility. This modifier cannot be used with either the generatedmissing or the generatedoverride modifier.
generatedmissing	If this modifier is specified, the utility assumes that the input data file contains no data for the generated column (not even NULLs). This results in all generated column values being generated by the utility. This modifier cannot be used with either the generatedignore or the generatedoverride modifier.

Table 23. Valid file type modifiers for the load utility: All file formats (continued)

Modifier	Description
generatedoverride	<p>This modifier instructs the load utility to accept user-supplied data for all generated columns in the table (contrary to the normal rules for these types of columns). This is useful when migrating data from another database system, or when loading a table from data that was recovered using the RECOVER DROPPED TABLE option on the ROLLFORWARD DATABASE command. When this modifier is used, any rows with no data or NULL data for a non-nullable generated column will be rejected (SQL3116W). When this modifier is used, the table will be placed in Set Integrity Pending state. To take the table out of Set Integrity Pending state without verifying the user-supplied values, issue the following command after the load operation:</p> <pre>SET INTEGRITY FOR < table-name > GENERATED COLUMN IMMEDIATE UNCHECKED</pre> <p>To take the table out of Set Integrity Pending state and force verification of the user-supplied values, issue the following command after the load operation:</p> <pre>SET INTEGRITY FOR < table-name > IMMEDIATE CHECKED.</pre> <p>When this modifier is specified and there is a generated column in any of the partitioning keys, dimension keys or distribution keys, then the LOAD command will automatically convert the modifier to generatedignore and proceed with the load. This will have the effect of regenerating all of the generated column values.</p> <p>This modifier cannot be used with either the generatedmissing or the generatedignore modifier.</p>
identityignore	<p>This modifier informs the load utility that data for the identity column is present in the data file but should be ignored. This results in all identity values being generated by the utility. The behavior will be the same for both GENERATED ALWAYS and GENERATED BY DEFAULT identity columns. This means that for GENERATED ALWAYS columns, no rows will be rejected. This modifier cannot be used with either the identitymissing or the identityoverride modifier.</p>
identitymissing	<p>If this modifier is specified, the utility assumes that the input data file contains no data for the identity column (not even NULLs), and will therefore generate a value for each row. The behavior will be the same for both GENERATED ALWAYS and GENERATED BY DEFAULT identity columns. This modifier cannot be used with either the identityignore or the identityoverride modifier.</p>
identityoverride	<p>This modifier should be used only when an identity column defined as GENERATED ALWAYS is present in the table to be loaded. It instructs the utility to accept explicit, non-NULL data for such a column (contrary to the normal rules for these types of identity columns). This is useful when migrating data from another database system when the table must be defined as GENERATED ALWAYS, or when loading a table from data that was recovered using the DROPPED TABLE RECOVERY option on the ROLLFORWARD DATABASE command. When this modifier is used, any rows with no data or NULL data for the identity column will be rejected (SQL3116W). This modifier cannot be used with either the identitymissing or the identityignore modifier. The load utility will not attempt to maintain or verify the uniqueness of values in the table's identity column when this option is used.</p>
indexfreespace= <i>x</i>	<p><i>x</i> is an integer between 0 and 99 inclusive. The value is interpreted as the percentage of each index page that is to be left as free space when load rebuilds the index. Load with INDEXING MODE INCREMENTAL ignores this option. The first entry in a page is added without restriction; subsequent entries are added to maintain the percent free space threshold. The default value is the one used at CREATE INDEX time.</p> <p>This value takes precedence over the PCTFREE value specified in the CREATE INDEX statement. The indexfreespace option affects index leaf pages only.</p>

Table 23. Valid file type modifiers for the load utility: All file formats (continued)

Modifier	Description
lobsinfile	<p><i>lob-path</i> specifies the path to the files containing LOB data. The ASC, DEL, or IXF load input files contain the names of the files having LOB data in the LOB column.</p> <p>This option is not supported in conjunction with the CURSOR filetype.</p> <p>The LOBS FROM clause specifies where the LOB files are located when the “lobsinfile” modifier is used. The LOBS FROM clause will implicitly activate the LOBSINFILE behavior. The LOBS FROM clause conveys to the LOAD utility the list of paths to search for the LOB files while loading the data.</p> <p>Each path contains at least one file that contains at least one LOB pointed to by a Lob Location Specifier (LLS) in the data file. The LLS is a string representation of the location of a LOB in a file stored in the LOB file path. The format of an LLS is <i>filename.ext.nnn.mmm/</i>, where <i>filename.ext</i> is the name of the file that contains the LOB, <i>nnn</i> is the offset in bytes of the LOB within the file, and <i>mmm</i> is the length of the LOB in bytes. For example, if the string <i>db2exp.001.123.456/</i> is stored in the data file, the LOB is located at offset 123 in the file <i>db2exp.001</i>, and is 456 bytes long.</p> <p>To indicate a null LOB, enter the size as -1. If the size is specified as 0, it is treated as a 0 length LOB. For null LOBS with length of -1, the offset and the file name are ignored. For example, the LLS of a null LOB might be <i>db2exp.001.7.-1/</i>.</p>
noheader	<p>Skips the header verification code (applicable only to load operations into tables that reside in a single-partition database partition group).</p> <p>If the default MPP load (mode PARTITION_AND_LOAD) is used against a table residing in a single-partition database partition group, the file is not expected to have a header. Thus the noheader modifier is not needed. If the LOAD_ONLY mode is used, the file is expected to have a header. The only circumstance in which you should need to use the noheader modifier is if you wanted to perform LOAD_ONLY operation using a file that does not have a header.</p>
norowwarnings	<p>Suppresses all warnings about rejected rows.</p>
pagefreespace= <i>x</i>	<p><i>x</i> is an integer between 0 and 100 inclusive. The value is interpreted as the percentage of each data page that is to be left as free space. If the specified value is invalid because of the minimum row size, (for example, a row that is at least 3 000 bytes long, and an <i>x</i> value of 50), the row will be placed on a new page. If a value of 100 is specified, each row will reside on a new page. The PCTFREE value of a table determines the amount of free space designated per page. If a pagefreespace value on the load operation or a PCTFREE value on a table have not been set, the utility will fill up as much space as possible on each page. The value set by pagefreespace overrides the PCTFREE value specified for the table.</p>
rowchangetimestampignore	<p>This modifier informs the load utility that data for the row change timestamp column is present in the data file but should be ignored. This results in all ROW CHANGE TIMESTAMPS being generated by the utility. The behavior will be the same for both GENERATED ALWAYS and GENERATED BY DEFAULT columns. This means that for GENERATED ALWAYS columns, no rows will be rejected. This modifier cannot be used with either the rowchangetimestampmissing or the rowchangetimestampoverride modifier.</p>
rowchangetimestampmissing	<p>If this modifier is specified, the utility assumes that the input data file contains no data for the row change timestamp column (not even NULLs), and will therefore generate a value for each row. The behavior will be the same for both GENERATED ALWAYS and GENERATED BY DEFAULT columns. This modifier cannot be used with either the rowchangetimestampignore or the rowchangetimestampoverride modifier.</p>

Table 23. Valid file type modifiers for the load utility: All file formats (continued)

Modifier	Description
rowchangetimestampoverride	<p>This modifier should be used only when a row change timestamp column defined as GENERATED ALWAYS is present in the table to be loaded. It instructs the utility to accept explicit, non-NULL data for such a column (contrary to the normal rules for these types of row change timestamp columns). This is useful when migrating data from another database system when the table must be defined as GENERATED ALWAYS, or when loading a table from data that was recovered using the DROPPED TABLE RECOVERY option on the ROLLFORWARD DATABASE command. When this modifier is used, any rows with no data or NULL data for the ROW CHANGE TIMESTAMP column will be rejected (SQL3116W). This modifier cannot be used with either the rowchangetimestampmissing or the rowchangetimestampignore modifier. The load utility will not attempt to maintain or verify the uniqueness of values in the table's row change timestamp column when this option is used.</p>
seclabelchar	<p>Indicates that security labels in the input source file are in the string format for security label values rather than in the default encoded numeric format. LOAD converts each security label into the internal format as it is loaded. If a string is not in the proper format the row is not loaded and a warning (SQLSTATE 01H53, SQLCODE SQL3242W) is returned. If the string does not represent a valid security label that is part of the security policy protecting the table then the row is not loaded and a warning (SQLSTATE 01H53, SQLCODE SQL3243W) is returned.</p> <p>This modifier cannot be specified if the seclabelname modifier is specified, otherwise the load fails and an error (SQLCODE SQL3525N) is returned.</p> <p>If you have a table consisting of a single DB2SECURITYLABEL column, the data file might look like this:</p> <pre> "CONFIDENTIAL:ALPHA:G2" "CONFIDENTIAL;SIGMA:G2" "TOP SECRET:ALPHA:G2" </pre> <p>To load or import this data, the SECLABELCHAR file type modifier must be used:</p> <pre> LOAD FROM input.del OF DEL MODIFIED BY SECLABELCHAR INSERT INTO t1 </pre>
seclabelname	<p>Indicates that security labels in the input source file are indicated by their name rather than the default encoded numeric format. LOAD will convert the name to the appropriate security label if it exists. If no security label exists with the indicated name for the security policy protecting the table the row is not loaded and a warning (SQLSTATE 01H53, SQLCODE SQL3244W) is returned.</p> <p>This modifier cannot be specified if the seclabelchar modifier is specified, otherwise the load fails and an error (SQLCODE SQL3525N) is returned.</p> <p>If you have a table consisting of a single DB2SECURITYLABEL column, the data file might consist of security label names similar to:</p> <pre> "LABEL1" "LABEL1" "LABEL2" </pre> <p>To load or import this data, the SECLABELNAME file type modifier must be used:</p> <pre> LOAD FROM input.del OF DEL MODIFIED BY SECLABELNAME INSERT INTO t1 </pre> <p>Note: If the file type is ASC, any spaces following the name of the security label will be interpreted as being part of the name. To avoid this use the striptblanks file type modifier to make sure the spaces are removed.</p>

Table 23. Valid file type modifiers for the load utility: All file formats (continued)

Modifier	Description
totalreespace= <i>x</i>	<p><i>x</i> is an integer greater than or equal to 0 . The value is interpreted as the percentage of the total pages in the table that is to be appended to the end of the table as free space. For example, if <i>x</i> is 20, and the table has 100 data pages after the data has been loaded, 20 additional empty pages will be appended. The total number of data pages for the table will be 120. The data pages total does not factor in the number of index pages in the table. This option does not affect the index object. If two loads are done with this option specified, the second load will not reuse the extra space appended to the end by the first load.</p>
usedefaults	<p>If a source column for a target table column has been specified, but it contains no data for one or more row instances, default values are loaded. Examples of missing data are:</p> <ul style="list-style-type: none"> • For DEL files: two adjacent column delimiters (",,") or two adjacent column delimiters separated by an arbitrary number of spaces (" , ") are specified for a column value. • For DEL/ASC/WSF files: A row that does not have enough columns, or is not long enough for the original specification. For ASC files, NULL column values are not considered explicitly missing, and a default will not be substituted for NULL column values. NULL column values are represented by all space characters for numeric, date, time, and /timestamp columns, or by using the NULL INDICATOR for a column of any type to indicate the column is NULL. <p>Without this option, if a source column contains no data for a row instance, one of the following occurs:</p> <ul style="list-style-type: none"> • For DEL/ASC/WSF files: If the column is nullable, a NULL is loaded. If the column is not nullable, the utility rejects the row.

Table 24. Valid file type modifiers for the load utility: ASCII file formats (ASC/DEL)

Modifier	Description
codepage= <i>x</i>	<p><i>x</i> is an ASCII character string. The value is interpreted as the code page of the data in the input data set. Converts character data (and numeric data specified in characters) from this code page to the database code page during the load operation.</p> <p>The following rules apply:</p> <ul style="list-style-type: none"> • For pure DBCS (graphic), mixed DBCS, and EUC, delimiters are restricted to the range of x00 to x3F, inclusive. • For DEL data specified in an EBCDIC code page, the delimiters might not coincide with the shift-in and shift-out DBCS characters. • nullindchar must specify symbols included in the standard ASCII set between code points x20 and x7F, inclusive. This refers to ASCII symbols and code points. EBCDIC data can use the corresponding symbols, even though the code points will be different. <p>This option is not supported in conjunction with the CURSOR filetype.</p>

Table 24. Valid file type modifiers for the load utility: ASCII file formats (ASC/DEL) (continued)

Modifier	Description
dateformat="x"	<p>x is the format of the date in the source file.¹ Valid date elements are:</p> <p>YYYY - Year (four digits ranging from 0000 - 9999) M - Month (one or two digits ranging from 1 - 12) MM - Month (two digits ranging from 1 - 12; mutually exclusive with M) D - Day (one or two digits ranging from 1 - 31) DD - Day (two digits ranging from 1 - 31; mutually exclusive with D) DDD - Day of the year (three digits ranging from 001 - 366; mutually exclusive with other day or month elements)</p> <p>A default value of 1 is assigned for each element that is not specified. Some examples of date formats are:</p> <p>"D-M-YYYY" "MM.DD.YYYY" "YYYYDDD"</p>
dumpfile = x	<p>x is the fully qualified (according to the server database partition) name of an exception file to which rejected rows are written. A maximum of 32 KB of data is written per record. Following is an example that shows how to specify a dump file:</p> <pre>db2 load from data of del modified by dumpfile = /u/user/filename insert into table_name</pre> <p>The file will be created and owned by the instance owner. To override the default file permissions, use the dumpfileaccessall file type modifier.</p> <p>Note:</p> <ol style="list-style-type: none"> 1. In a partitioned database environment, the path should be local to the loading database partition, so that concurrently running load operations do not attempt to write to the same file. 2. The contents of the file are written to disk in an asynchronous buffered mode. In the event of a failed or an interrupted load operation, the number of records committed to disk cannot be known with certainty, and consistency cannot be guaranteed after a LOAD RESTART. The file can only be assumed to be complete for a load operation that starts and completes in a single pass. 3. If the specified file already exists, it will not be recreated, but it will be appended.
dumpfileaccessall	<p>Grants read access to 'OTHERS' when a dump file is created.</p> <p>This file type modifier is only valid when:</p> <ol style="list-style-type: none"> 1. it is used in conjunction with dumpfile file type modifier 2. the user has SELECT privilege on the load target table 3. it is issued on a DB2 server database partition that resides on a UNIX operating system <p>If the specified file already exists, its permissions will not be changed.</p>
fastparse	<p>Use with caution. Reduces syntax checking on user-supplied column values, and enhances performance. Tables are guaranteed to be architecturally correct (the utility performs sufficient data checking to prevent a segmentation violation or trap), however, the coherence of the data is not validated. Only use this option if you are certain that your data is coherent and correct. For example, if the user-supplied data contains an invalid timestamp column value of :1>0-00-20-07.11.12.000000, this value is inserted into the table if FASTPARSE is specified, and rejected if FASTPARSE is not specified.</p>

Table 24. Valid file type modifiers for the load utility: ASCII file formats (ASC/DEL) (continued)

Modifier	Description
implieddecimal	<p>The location of an implied decimal point is determined by the column definition; it is no longer assumed to be at the end of the value. For example, the value 12345 is loaded into a DECIMAL(8,2) column as 123.45, <i>not</i> 12345.00.</p> <p>This modifier cannot be used with the packeddecimal modifier.</p>
timeformat="x"	<p>x is the format of the time in the source file.¹ Valid time elements are:</p> <ul style="list-style-type: none"> H - Hour (one or two digits ranging from 0 - 12 for a 12 hour system, and 0 - 24 for a 24 hour system) HH - Hour (two digits ranging from 0 - 12 for a 12 hour system, and 0 - 24 for a 24 hour system; mutually exclusive with H) M - Minute (one or two digits ranging from 0 - 59) MM - Minute (two digits ranging from 0 - 59; mutually exclusive with M) S - Second (one or two digits ranging from 0 - 59) SS - Second (two digits ranging from 0 - 59; mutually exclusive with S) SSSSS - Second of the day after midnight (5 digits ranging from 00000 - 86399; mutually exclusive with other time elements) TT - Meridian indicator (AM or PM) <p>A default value of 0 is assigned for each element that is not specified. Some examples of time formats are:</p> <pre>"HH:MM:SS" "HH.MM TT" "SSSSS"</pre>

Table 24. Valid file type modifiers for the load utility: ASCII file formats (ASC/DEL) (continued)

Modifier	Description
timestampformat="x"	<p>x is the format of the time stamp in the source file.¹ Valid time stamp elements are:</p> <ul style="list-style-type: none"> YYYY - Year (four digits ranging from 0000 - 9999) M - Month (one or two digits ranging from 1 - 12) MM - Month (two digits ranging from 01 - 12; mutually exclusive with M and MMM) MMM - Month (three-letter case-insensitive abbreviation for the month name; mutually exclusive with M and MM) D - Day (one or two digits ranging from 1 - 31) DD - Day (two digits ranging from 1 - 31; mutually exclusive with D) DDD - Day of the year (three digits ranging from 001 - 366; mutually exclusive with other day or month elements) H - Hour (one or two digits ranging from 0 - 12 for a 12 hour system, and 0 - 24 for a 24 hour system) HH - Hour (two digits ranging from 0 - 12 for a 12 hour system, and 0 - 24 for a 24 hour system; mutually exclusive with H) M - Minute (one or two digits ranging from 0 - 59) MM - Minute (two digits ranging from 0 - 59; mutually exclusive with M, minute) S - Second (one or two digits ranging from 0 - 59) SS - Second (two digits ranging from 0 - 59; mutually exclusive with S) SSSSS - Second of the day after midnight (5 digits ranging from 00000 - 86399; mutually exclusive with other time elements) U (1 to 12 times) <ul style="list-style-type: none"> - Fractional seconds(number of occurrences of U represent the number of digits with each digit ranging from 0 to 9 TT - Meridian indicator (AM or PM)
timestampformat="x" (Continued)	<p>A default value of 1 is assigned for unspecified YYYY, M, MM, D, DD, or DDD elements. A default value of 'Jan' is assigned to an unspecified MMM element. A default value of 0 is assigned for all other unspecified elements. Following is an example of a time stamp format:</p> <p style="padding-left: 40px;">"YYYY/MM/DD HH:MM:SS.UUUUUU"</p> <p>The valid values for the MMM element include: 'jan', 'feb', 'mar', 'apr', 'may', 'jun', 'jul', 'aug', 'sep', 'oct', 'nov' and 'dec'. These values are case insensitive.</p> <p>If the TIMESTAMPFORMAT modifier is not specified, the load utility formats the timestamp field using one of two possible formats:</p> <p>YYYY-MM-DD-HH.MM.SS YYYY-MM-DD HH:MM:SS</p> <p>The load utility chooses the format by looking at the separator between the DD and HH. If it is a dash '-', the load utility uses the regular dashes and dots format (YYYY-MM-DD-HH.MM.SS). If it is a blank space, then the load utility expects a colon ':' to separate the HH, MM and SS.</p> <p>In either format, if you include the microseconds field (UUUUUU), the load utility expects the dot '.' as the separator. Either YYYY-MM-DD-HH.MM.SS.UUUUUU or YYYY-MM-DD HH:MM:SS.UUUUUU are acceptable.</p> <p>The following example illustrates how to load data containing user defined date and time formats into a table called schedule:</p> <pre style="padding-left: 40px;">db2 load from delfile2 of del modified by timestampformat="yyyy.mm.dd hh:mm tt" insert into schedule</pre>

Table 24. Valid file type modifiers for the load utility: ASCII file formats (ASC/DEL) (continued)

Modifier	Description
usegraphiccodepage	<p>If usegraphiccodepage is given, the assumption is made that data being loaded into graphic or double-byte character large object (DBCLOB) data field(s) is in the graphic code page. The rest of the data is assumed to be in the character code page. The graphic codepage is associated with the character code page. LOAD determines the character code page through either the codepage modifier, if it is specified, or through the code page of the database if the codepage modifier is not specified.</p> <p>This modifier should be used in conjunction with the delimited data file generated by drop table recovery only if the table being recovered has graphic data.</p> <p>Restrictions</p> <p>The usegraphi ccodepage modifier MUST NOT be specified with DEL files created by the EXPORT utility, as these files contain data encoded in only one code page. The usegraphi ccodepage modifier is also ignored by the double-byte character large objects (DBCLOBs) in files.</p>
xmlchar	<p>Specifies that XML documents are encoded in the character code page.</p> <p>This option is useful for processing XML documents that are encoded in the specified character code page but do not contain an encoding declaration.</p> <p>For each document, if a declaration tag exists and contains an encoding attribute, the encoding must match the character code page, otherwise the row containing the document will be rejected. Note that the character codepage is the value specified by the codepage file type modifier, or the application codepage if it is not specified. By default, either the documents are encoded in Unicode, or they contain a declaration tag with an encoding attribute.</p>
xmlgraphic	<p>Specifies that XML documents are encoded in the specified graphic code page.</p> <p>This option is useful for processing XML documents that are encoded in a specific graphic code page but do not contain an encoding declaration.</p> <p>For each document, if a declaration tag exists and contains an encoding attribute, the encoding must match the graphic code page, otherwise the row containing the document will be rejected. Note that the graphic code page is the graphic component of the value specified by the codepage file type modifier, or the graphic component of the application code page if it is not specified. By default, documents are either encoded in Unicode, or they contain a declaration tag with an encoding attribute.</p>

Table 25. Valid file type modifiers for the load utility: ASC file formats (Non-delimited ASCII)

Modifier	Description
binarynumerics	<p>Numeric (but not DECIMAL) data must be in binary form, not the character representation. This avoids costly conversions.</p> <p>This option is supported only with positional ASC, using fixed length records specified by the <code>reclen</code> option.</p> <p>The following rules apply:</p> <ul style="list-style-type: none"> • No conversion between data types is performed, with the exception of BIGINT, INTEGER, and SMALLINT. • Data lengths must match their target column definitions. • FLOATs must be in IEEE Floating Point format. • Binary data in the load source file is assumed to be big-endian, regardless of the platform on which the load operation is running. <p>NULLs cannot be present in the data for columns affected by this modifier. Blanks (normally interpreted as NULL) are interpreted as a binary value when this modifier is used.</p>
nochecklengths	<p>If <code>nochecklengths</code> is specified, an attempt is made to load each row, even if the source data has a column definition that exceeds the size of the target table column. Such rows can be successfully loaded if code page conversion causes the source data to shrink; for example, 4-byte EUC data in the source could shrink to 2-byte DBCS data in the target, and require half the space. This option is particularly useful if it is known that the source data will fit in all cases despite mismatched column definitions.</p>
nullindchar= <i>x</i>	<p><i>x</i> is a single character. Changes the character denoting a NULL value to <i>x</i>. The default value of <i>x</i> is <code>Y</code>.²</p> <p>This modifier is case sensitive for EBCDIC data files, except when the character is an English letter. For example, if the NULL indicator character is specified to be the letter <code>N</code>, then <code>n</code> is also recognized as a NULL indicator.</p>
packeddecimal	<p>Loads packed-decimal data directly, since the <code>binarynumerics</code> modifier does not include the DECIMAL field type.</p> <p>This option is supported only with positional ASC, using fixed length records specified by the <code>reclen</code> option.</p> <p>Supported values for the sign nibble are:</p> <ul style="list-style-type: none"> + = 0xC 0xA 0xE 0xF - = 0xD 0xB <p>NULLs cannot be present in the data for columns affected by this modifier. Blanks (normally interpreted as NULL) are interpreted as a binary value when this modifier is used.</p> <p>Regardless of the server platform, the byte order of binary data in the load source file is assumed to be big-endian; that is, when using this modifier on Windows operating systems, the byte order must not be reversed.</p> <p>This modifier cannot be used with the <code>implieddecimal</code> modifier.</p>
reclen= <i>x</i>	<p><i>x</i> is an integer with a maximum value of 32 767. <i>x</i> characters are read for each row, and a new-line character is not used to indicate the end of the row.</p>

Table 25. Valid file type modifiers for the load utility: ASC file formats (Non-delimited ASCII) (continued)

Modifier	Description
striptblanks	<p>Truncates any trailing blank spaces when loading data into a variable-length field. If this option is not specified, blank spaces are kept.</p> <p>This option cannot be specified together with striptnulls. These are mutually exclusive options. This option replaces the obsolete t option, which is supported for earlier compatibility only.</p>
striptnulls	<p>Truncates any trailing NULLs (0x00 characters) when loading data into a variable-length field. If this option is not specified, NULLs are kept.</p> <p>This option cannot be specified together with striptblanks. These are mutually exclusive options. This option replaces the obsolete padwithzero option, which is supported for earlier compatibility only.</p>
zoneddecimal	<p>Loads zoned decimal data, since the BINARYNUMERICS modifier does not include the DECIMAL field type. This option is supported only with positional ASC, using fixed length records specified by the RECLLEN option.</p> <p>Half-byte sign values can be one of the following:</p> <ul style="list-style-type: none"> + = 0xC 0xA 0xE 0xF - = 0xD 0xB <p>Supported values for digits are 0x0 to 0x9.</p> <p>Supported values for zones are 0x3 and 0xF.</p>

Table 26. Valid file type modifiers for the load utility: DEL file formats (Delimited ASCII)

Modifier	Description
chardelx	<p>x is a single character string delimiter. The default value is a double quotation mark ("). The specified character is used in place of double quotation marks to enclose a character string.²³ If you want to explicitly specify the double quotation mark (") as the character string delimiter, you should specify it as follows:</p> <pre>modified by chardel""</pre> <p>The single quotation mark (') can also be specified as a character string delimiter as follows:</p> <pre>modified by chardel''</pre>
coldelx	<p>x is a single character column delimiter. The default value is a comma (.). The specified character is used in place of a comma to signal the end of a column.²³</p>
decplusblank	<p>Plus sign character. Causes positive decimal values to be prefixed with a blank space instead of a plus sign (+). The default action is to prefix positive decimal values with a plus sign.</p>
decptx	<p>x is a single character substitute for the period as a decimal point character. The default value is a period (.). The specified character is used in place of a period as a decimal point character.²³</p>

Table 26. Valid file type modifiers for the load utility: DEL file formats (Delimited ASCII) (continued)

Modifier	Description
delprioritychar	<p>The current default priority for delimiters is: record delimiter, character delimiter, column delimiter. This modifier protects existing applications that depend on the older priority by reverting the delimiter priorities to: character delimiter, record delimiter, column delimiter. Syntax:</p> <pre>db2 load ... modified by delprioritychar ...</pre> <p>For example, given the following DEL data file:</p> <pre>"Smith, Joshua",4000,34.98<row delimiter> "Vincent,<row delimiter>, is a manager", 4005,44.37<row delimiter></pre> <p>With the delprioritychar modifier specified, there will be only two rows in this data file. The second <row delimiter> will be interpreted as part of the first data column of the second row, while the first and the third <row delimiter> are interpreted as actual record delimiters. If this modifier is <i>not</i> specified, there will be three rows in this data file, each delimited by a <row delimiter>.</p>
keepblanks	<p>Preserves the leading and trailing blanks in each field of type CHAR, VARCHAR, LONG VARCHAR, or CLOB. Without this option, all leading and trailing blanks that are not inside character delimiters are removed, and a NULL is inserted into the table for all blank fields.</p> <p>The following example illustrates how to load data into a table called TABLE1, while preserving all leading and trailing spaces in the data file:</p> <pre>db2 load from delfile3 of del modified by keepblanks insert into table1</pre>
nochardel	<p>The load utility will assume all bytes found between the column delimiters to be part of the column's data. Character delimiters will be parsed as part of column data. This option should not be specified if the data was exported using DB2 (unless nochardel was specified at export time). It is provided to support vendor data files that do not have character delimiters. Improper usage might result in data loss or corruption.</p> <p>This option cannot be specified with charde1x, delprioritychar or nodoublede1. These are mutually exclusive options.</p>
nodoublede1	<p>Suppresses recognition of double character delimiters.</p>

Table 27. Valid file type modifiers for the load utility: IXF file format

Modifier	Description
forcein	<p>Directs the utility to accept data despite code page mismatches, and to suppress translation between code pages.</p> <p>Fixed length target fields are checked to verify that they are large enough for the data. If nochecklengths is specified, no checking is done, and an attempt is made to load each row.</p>
nochecklengths	<p>If nochecklengths is specified, an attempt is made to load each row, even if the source data has a column definition that exceeds the size of the target table column. Such rows can be successfully loaded if code page conversion causes the source data to shrink; for example, 4-byte EUC data in the source could shrink to 2-byte DBCS data in the target, and require half the space. This option is particularly useful if it is known that the source data will fit in all cases despite mismatched column definitions.</p>

Note:

1. Double quotation marks around the date format string are mandatory. Field separators cannot contain any of the following: a-z, A-Z, and 0-9. The field separator should not be the same as the character delimiter or field delimiter in the DEL file format. A field separator is optional if the start and end positions of an element are unambiguous. Ambiguity can exist if (depending on the modifier) elements such as D, H, M, or S are used, because of the variable length of the entries.

For time stamp formats, care must be taken to avoid ambiguity between the month and the minute descriptors, since they both use the letter M. A month field must be adjacent to other date fields. A minute field must be adjacent to other time fields. Following are some ambiguous time stamp formats:

```
"M" (could be a month, or a minute)
"M:M" (Which is which?)
"M:YYYY:M" (Both are interpreted as month.)
"S:M:YYYY" (adjacent to both a time value and a date value)
```

In ambiguous cases, the utility will report an error message, and the operation will fail.

Following are some unambiguous time stamp formats:

```
"M:YYYY" (Month)
"S:M" (Minute)
"M:YYYY:S:M" (Month...Minute)
"M:H:YYYY:M:D" (Minute...Month)
```

Some characters, such as double quotation marks and back slashes, must be preceded by an escape character (for example, \).

2. Character values provided for the chardel, coldel, or decpt file type modifiers must be specified in the code page of the source data.

The character code point (instead of the character symbol), can be specified using the syntax xJJ or 0xJJ, where JJ is the hexadecimal representation of the code point. For example, to specify the # character as a column delimiter, use one of the following:

```
... modified by coldel# ...
... modified by coldel0x23 ...
... modified by coldelX23 ...
```

3. *Delimiter considerations for moving data* lists restrictions that apply to the characters that can be used as delimiter overrides.
4. The load utility does not issue a warning if an attempt is made to use unsupported file types with the MODIFIED BY option. If this is attempted, the load operation fails, and an error code is returned.
5. When importing into a table containing an implicitly hidden row change timestamp column, the implicitly hidden property of the column is not honoured. Therefore, the rowchangetimestampmissing file type modifier *must* be specified in the import command if data for the column is not present in the data to be imported and there is no explicit column list present.

Table 28. LOAD behavior when using codepage and usegraphiccodepage

codepage=N	usegraphiccodepage	LOAD behavior
Absent	Absent	All data in the file is assumed to be in the database code page, not the application code page, even if the CLIENT option is specified.
Present	Absent	All data in the file is assumed to be in code page N. Warning: Graphic data will be corrupted when loaded into the database if N is a single-byte code page.

Table 28. LOAD behavior when using codepage and usegraphiccodepage (continued)

codepage=N	usegraphiccodepage	LOAD behavior
Absent	Present	<p>Character data in the file is assumed to be in the database code page, even if the CLIENT option is specified. Graphic data is assumed to be in the code page of the database graphic data, even if the CLIENT option is specified.</p> <p>If the database code page is single-byte, then all data is assumed to be in the database code page.</p> <p>Warning: Graphic data will be corrupted when loaded into a single-byte database.</p>
Present	Present	<p>Character data is assumed to be in code page N. Graphic data is assumed to be in the graphic code page of N.</p> <p>If N is a single-byte or double-byte code page, then all data is assumed to be in code page N.</p> <p>Warning: Graphic data will be corrupted when loaded into the database if N is a single-byte code page.</p>

Chapter 86. LOAD QUERY

Checks the status of a load operation during processing and returns the table state. If a load is not processing, then the table state alone is returned. A connection to the same database, and a separate CLP session are also required to successfully invoke this command. It can be used either by local or remote users.

Authorization

None

Required connection

Database

Command syntax

```
➤➤—LOAD QUERY—TABLE—table-name—┬─TO—local-message-file—┬─NOSUMMARY—┬─
└──────────────────────────────────┘└──────────────────┘└──────────┘
➤──────────────────────────────────────────────────────────────────────────┘
└─SHOWDELTA—┘
```

Command parameters

NOSUMMARY

Specifies that no load summary information (rows read, rows skipped, rows loaded, rows rejected, rows deleted, rows committed, and number of warnings) is to be reported.

SHOWDELTA

Specifies that only new information (pertaining to load events that have occurred since the last invocation of the LOAD QUERY command) is to be reported.

SUMMARYONLY

Specifies that only load summary information is to be reported.

TABLE *table-name*

Specifies the name of the table into which data is currently being loaded. If an unqualified table name is specified, the table will be qualified with the CURRENT SCHEMA.

TO *local-message-file*

Specifies the destination for warning and error messages that occur during the load operation. This file cannot be the *message-file* specified for the LOAD command. If the file already exists, all messages that the load utility has generated are appended to it.

Examples

A user loading a large amount of data into the STAFF table in the BILLYBOB database, wants to check the status of the load operation. The user can specify:

```
db2 connect to billybob
db2 load query table staff to /u/mydir/staff.tempmsg
```

The output file /u/mydir/staff.tempmsg might look like the following:

```
SQL3501W The table space(s) in which the table resides will not be placed in
backup pending state since forward recovery is disabled for the database.
```

```
SQL3109N The utility is beginning to load data from file
"/u/mydir/data/staffbig.del"
```

```
SQL3500W The utility is beginning the "LOAD" phase at time "03-21-2002
11:31:16.597045".
```

```
SQL3519W Begin Load Consistency Point. Input record count = "0".
```

```
SQL3520W Load Consistency Point was successful.
```

```
SQL3519W Begin Load Consistency Point. Input record count = "104416".
```

```
SQL3520W Load Consistency Point was successful.
```

```
SQL3519W Begin Load Consistency Point. Input record count = "205757".
```

```
SQL3520W Load Consistency Point was successful.
```

```
SQL3519W Begin Load Consistency Point. Input record count = "307098".
```

```
SQL3520W Load Consistency Point was successful.
```

```
SQL3519W Begin Load Consistency Point. Input record count = "408439".
```

```
SQL3520W Load Consistency Point was successful.
```

```
SQL3532I The Load utility is currently in the "LOAD" phase.
```

```
Number of rows read           = 453376
Number of rows skipped        = 0
Number of rows loaded         = 453376
Number of rows rejected       = 0
Number of rows deleted        = 0
Number of rows committed     = 408439
Number of warnings            = 0
```

```
Tablestate:
  Load in Progress
```

Usage notes

In addition to locks, the load utility uses table states to control access to the table. The LOAD QUERY command can be used to determine the table state; LOAD QUERY can be used on tables that are not currently being loaded. For a partitioned table, the state reported is the most restrictive of the corresponding visible data partition states. For example, if a single data partition is in the Read Access Only state and all other data partitions are in Normal state, the load query operation returns the Read Access Only state. A load operation will not leave a subset of data partitions in a state different from the rest of the table. The table states described by LOAD QUERY are as follows:

Normal

A table is in Normal state if it is not in any of the other (abnormal) table states. Normal state is the initial state of a table after it is created.

Set Integrity Pending

The table has constraints which have not yet been verified. Use the SET INTEGRITY statement to take the table out of Set Integrity Pending state. The load utility places a table in Set Integrity Pending state when it begins a load operation on a table with constraints.

Load in Progress

This is a transient state that is only in effect during a load operation. For information about bringing a table out of Load in Progress state if your load operation has failed or was interrupted, see the section on pending states after a load operation in the *Related links* section. See also Load in Progress table space state.

Load Pending

A load operation has been active on this table but has been aborted before the data could be committed. Issue a LOAD TERMINATE, LOAD RESTART, or LOAD REPLACE command to bring the table out of this state.

Read Access Only

A table is in this state during a load operation if the ALLOW READ ACCESS option was specified. Read Access Only is a transient state that allows other applications and utilities to have read access to data that existed prior to the load operation.

Reorg Pending

A REORG command recommended ALTER TABLE statement has been executed on the table. A classic REORG must be performed before the table is accessible again.

Unavailable

The table is unavailable. The table can only be dropped or restored from a backup. Rolling forward through a non-recoverable load operation will place a table in the unavailable state.

Not Load Restartable

The table is in a partially loaded state that will not allow a load restart operation. The table will also be in load pending state. Issue a LOAD TERMINATE or a LOAD REPLACE command to bring the table out of the not load restartable state. A table is placed in not load restartable state when a rollforward operation is performed after a failed load operation that has not been successfully restarted or terminated, or when a restore operation is performed from an online backup that was taken while the table was in load in progress or load pending state. In either case, the information required for a load restart operation is unreliable, and the not load restartable state prevents a load restart operation from taking place.

Unknown

The LOAD QUERY command is unable to determine the table state.

There are currently at least 25 table or table space states supported by the IBM DB2 database product. These states are used to control access to data under certain circumstances, or to elicit specific user actions, when required, to protect the integrity of the database. Most of them result from events related to the operation of one of the DB2 utilities, such as the load utility, or the backup and restore utilities.

Although dependent table spaces are no longer quiesced (a quiesce is a persistent lock) prior to a load operation, the Load in Progress table space state prevents the

backup of dependent tables during a load operation. The Load in Progress table space state is different from the Load in Progress table state: All load operations use the Load in Progress table state, but load operations (against a recoverable database) with the COPY NO option specified also use the Load in Progress table space state.

The following table describes each of the supported table states. The table also provides you with working examples that show you exactly how to interpret and respond to states that you might encounter while administering your database. The examples are taken from command scripts that were run on AIX; you can copy, paste and run them yourself. If you are running the DB2 database product on a system that is not UNIX, ensure that any path names are in the correct format for your system. Most of the examples are based on tables in the SAMPLE database that comes with the DB2 database product. A few examples require scenarios that are not part of the SAMPLE database, but you can use a connection to the SAMPLE database as a starting point.

Table 29. Supported table states

State	Examples
Load Pending	<p>Given load input file staffdata.del with a substantial amount of data (for example, 20000 or more records), create a small table space that contains the target table of the load operation, a new table called NEWSTAFF:</p> <pre>connect to sample; create tablespace ts1 managed by database using (file '/home/melnyk/melnyk/NODE0000 /SQL00001/ts1c1' 256); create table newstaff like staff in ts1; load from staffdata.del of del insert into newstaff; load query table newstaff; load from staffdata.del of del terminate into newstaff; load query table newstaff; connect reset;</pre> <p>Information returned by the LOAD QUERY command shows that the NEWSTAFF table is in Load Pending state; after a load terminate operation, the table is in Normal state.</p>
Load in Progress	<p>Given load input file staffdata.del with a substantial amount of data (for example, 20000 or more records):</p> <pre>connect to sample; create table newstaff like staff; load from staffdata.del of del insert into newstaff;</pre> <p>While the load operation is running, execute the following script from another session:</p> <pre>connect to sample; load query table newstaff; connect reset;</pre> <p>Information returned by the LOAD QUERY command shows that the NEWSTAFF table is in Load in Progress state.</p>
Normal	<pre>connect to sample; create table newstaff like staff; load query table newstaff;</pre> <p>Information returned by the LOAD QUERY command shows that the NEWSTAFF table is in Normal state.</p>

Table 29. Supported table states (continued)

State	Examples
Not Load Restartable	<p>Given load input file staffdata.del with a substantial amount of data (for example, 20000 or more records):</p> <pre>update db cfg for sample using logretain recovery; backup db sample; connect to sample; create tablespace ts1 managed by database using (file '/home/melnyk/melnyk/NODE0000 /SQL00001/ts1c1' 256); create table newstaff like staff in ts1; connect reset; backup db sample;</pre> <p>The timestamp for this backup image is: 20040629205935</p> <pre>connect to sample; load from staffdata.del of del insert into newstaff copy yes to /home/melnyk/backups; connect reset; restore db sample taken at 20040629205935; rollforward db sample to end of logs and stop; connect to sample; load query table newstaff; connect reset;</pre> <p>Information returned by the LOAD QUERY command shows that the NEWSTAFF table is in Not Load Restartable and Load Pending state.</p> <pre>connect to sample; load from staffdata.del of del terminate into newstaff copy yes to /home/melnyk/backups; load query table newstaff; connect reset;</pre> <p>Information returned by the LOAD QUERY command shows that the NEWSTAFF table is now in Normal state.</p>
Read Access Only	<p>Given load input file staffdata.del with a substantial amount of data (for example, 20000 or more records):</p> <pre>connect to sample; export to st_data.del of del select * from staff; create table newstaff like staff; import from st_data.del of del insert into newstaff; load from staffdata.del of del insert into newstaff allow read access;</pre> <p>While the load operation is running, execute the following script from another session:</p> <pre>connect to sample; load query table newstaff; select * from newstaff; connect reset;</pre> <p>Information returned by the LOAD QUERY command shows that the NEWSTAFF table is in Read Access Only and Load in Progress state. The query returns only the exported contents of the STAFF table, data that existed in the NEWSTAFF table prior to the load operation.</p>
Set Integrity Pending	<p>Given load input file staff_data.del with content:</p> <pre>11,"Melnyk",20,"Sales",10,70000,15000:</pre> <pre>connect to sample; alter table staff add constraint max_salary check (100000 - salary > 0); load from staff_data.del of del insert into staff; load query table staff;</pre> <p>Information returned by the LOAD QUERY command shows that the STAFF table is in Set Integrity Pending state.</p>

Table 29. Supported table states (continued)

State	Examples
Unavailable	<p>Given load input file staff_data.del with content:</p> <pre>11,"Melnyk",20,"Sales",10,70000,15000: update db cfg for sample using logretain recovery; backup db sample;</pre> <p>The timestamp for this backup image is: 20040629182012</p> <pre>connect to sample; load from staff_data.del of del insert into staff nonrecoverable; connect reset; restore db sample taken at 20040629182012; rollforward db sample to end of logs and stop; connect to sample; load query table staff; connect reset;</pre> <p>Information returned by the LOAD QUERY command shows that the STAFF table is in Unavailable state.</p>

For additional information about table states, see the *Related links* section.

The progress of a load operation can also be monitored with the LIST UTILITIES command.

Chapter 87. UPGRADE DATABASE

Converts a DB2 database of the previous version to the formats corresponding to the release run by the instance.

The `db2ckupgrade` command must be issued prior to upgrading the instance to verify that your databases are ready for upgrade. The `db2iupgrade` command implicitly calls the `db2ckupgrade`. Backup all databases prior to upgrade, and prior to the installation of the current version of DB2 database product on Windows operating systems.

Authorization

sysadm

Required connection

This command establishes a database connection.

Command syntax

```
➤➤ UPGRADE DATABASE database-alias
      DB
➤➤ USER username USING password
```

Command parameters

DATABASE *database-alias*

Specifies the alias of the database to be upgraded to the currently installed version of the database manager.

USER *username*

Identifies the user name under which the database is to be upgraded.

USING *password*

The password used to authenticate the user name. If the password is omitted, but a user name was specified, the user is prompted to enter it.

Examples

The following example upgrades the database cataloged under the database alias `sales`:

```
db2 UPGRADE DATABASE sales
```

Usage notes

This command will only upgrade a database to a newer version, and cannot be used to convert an upgraded database to its previous version.

The database must be cataloged before upgrade.

If an error occurs during upgrade, it might be necessary to issue the `TERMINATE` command before attempting the suggested user response. For example, if a log full error occurs during upgrade (SQL1704: Database upgrade failed. Reason code "3"), it will be necessary to issue the `TERMINATE` command before increasing the values of the database configuration parameters `LOGPRIMARY` and `LOGFILSIZ`. The CLP must refresh its database directory cache if the upgrade failure occurs after the database has already been relocated (which is likely to be the case when a "log full" error returns).

Chapter 88. PING

Tests the network response time of the underlying connectivity between a client and a connected database server.

Authorization

None

Required connection

Database

Command syntax

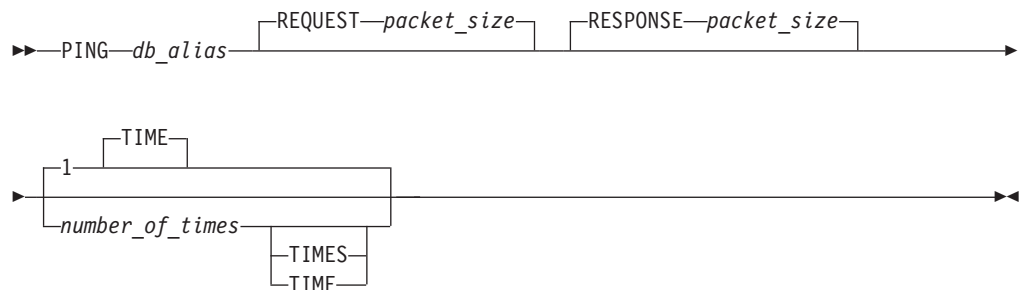

Command parameters

db_alias

Specifies the database alias for the database on a DRDA server that the ping is being sent to. This parameter, although mandatory, is not currently used. It is reserved for future use. Any valid database alias name can be specified.

REQUEST *packet_size*

Specifies the size, in bytes, of the packet to be sent to the server. The size must be between 0 and 32767 inclusive. The default is 10 bytes. This option is only valid on servers running DB2 Database for Linux, UNIX, and Windows Version 8 or later, or DB2 Universal Database for z/OS Version 8 or later.

RESPONSE *packet_size*

Specifies the size, in bytes, of the packet to be returned back to client. The size must be between 0 and 32767 inclusive. The default is 10 bytes. This option is only valid on servers running DB2 Database for Linux, UNIX, and Windows Version 8 or later, or DB2 UDB for z/OS Version 8 or later.

number_of_times

Specifies the number of iterations for this test. The value must be between 1 and 32767 inclusive. The default is 1. One timing will be returned for each iteration.

Examples

Example 1

To test the network response time for the connection to the host database hostdb once:

```
db2 ping hostdb 1  
or  
db2 ping hostdb
```

The command will display output that looks like this:

```
Elapsed time: 7221 microseconds
```

Example 2

To test the network response time for the connection to the host database hostdb 5 times:

```
db2 ping hostdb 5  
or  
db2 ping hostdb 5 times
```

The command will display output that looks like this:

```
Elapsed time: 8412 microseconds  
Elapsed time: 11876 microseconds  
Elapsed time: 7789 microseconds  
Elapsed time: 10124 microseconds  
Elapsed time: 10988 microseconds
```

Example 3

To test the network response time for a connection to the host database hostdb, with a 100-byte request packet and a 200-byte response packet:

```
db2 ping hostdb request 100 response 200  
or  
db2 ping hostdb request 100 response 200 1 time
```

Usage notes

A database connection must exist before invoking this command, otherwise an error will result.

The elapsed time returned is for the connection between the IBM Data Server Client and the DB2 server.

This command will not work when it is used from a DB2 Universal Database Version 7 client through a DB2 Connect Version 8 to a connected DB2 host database server.

Chapter 89. PRECOMPILE

Processes an application program source file containing embedded SQL statements. A modified source file is produced, containing host language calls for the SQL statements and, by default, a package is created in the database.

Scope

This command can be issued from any database partition in `db2nodes.cfg`. In a partitioned database environment, it can be issued from any database partition server defined in the `db2nodes.cfg` file. It updates the database catalogs on the catalog database partition. Its effects are visible to all database partitions.

Authorization

One of the following authorizations:

- `dbadm` authority
- If `SQLERROR CHECK` or `EXPLAIN ONLY` is specified, either `EXPLAIN` or `SQLADM` authority is sufficient.
- If a package does not exist, `BINDADD` authority and:
 - If the schema name of the package does not exist, `IMPLICIT_SCHEMA` authority on the database.
 - If the schema name of the package does exist, `CREATEIN` privilege on the schema.
- If the package exists, one of the following privileges:
 - `ALTERIN` privilege on the schema
 - `BIND` privilege on the package

The user also needs all privileges required to compile any static SQL statements in the application. Privileges granted to groups are not used for authorization checking of static statements.

Required connection

Database. If implicit connect is enabled, a connection to the default database is established.

Command syntax

For DB2 Database for Linux, UNIX, and Windows

►► `PRECOMPILE` `filename`
 └── `PREP` ───┘

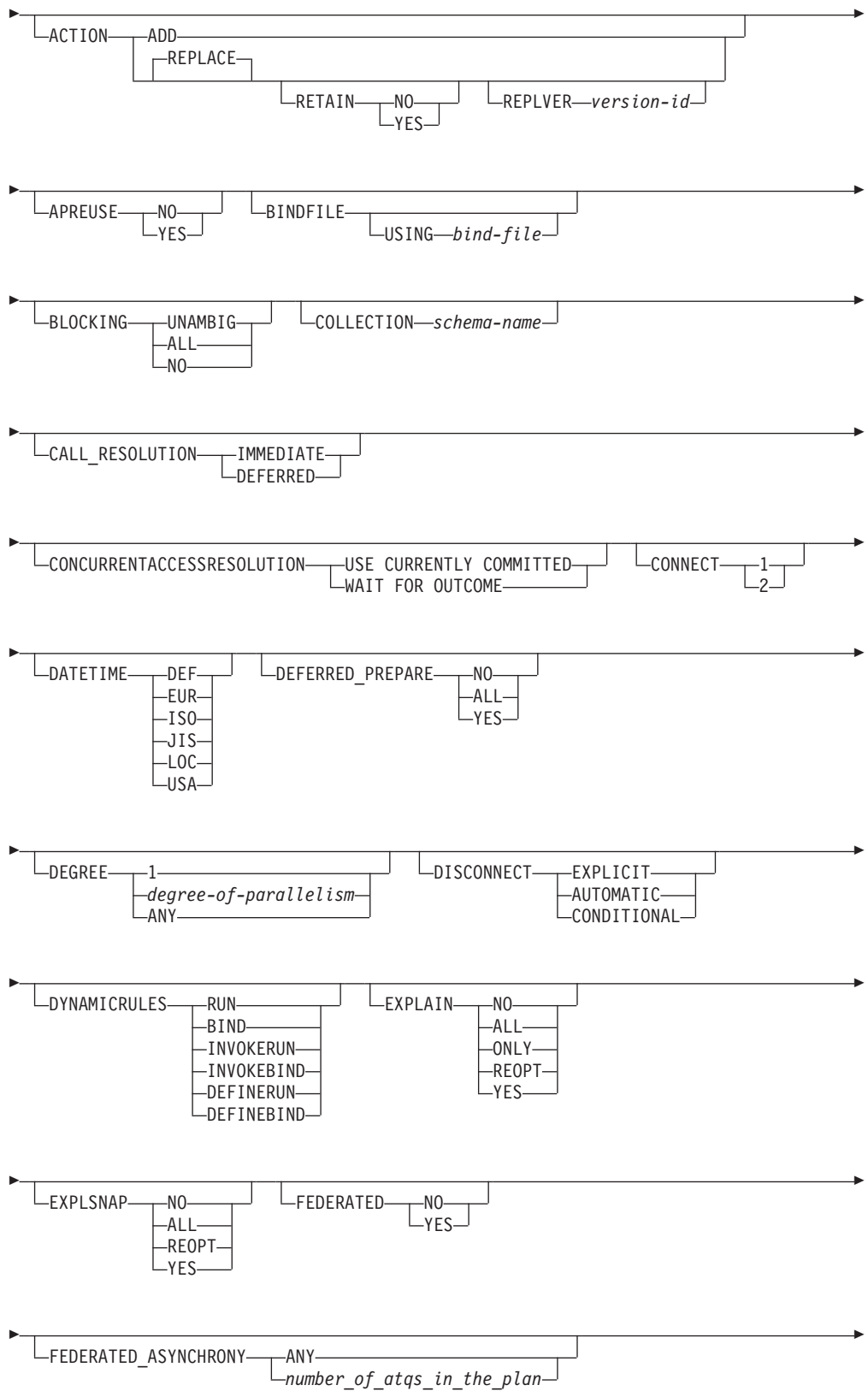

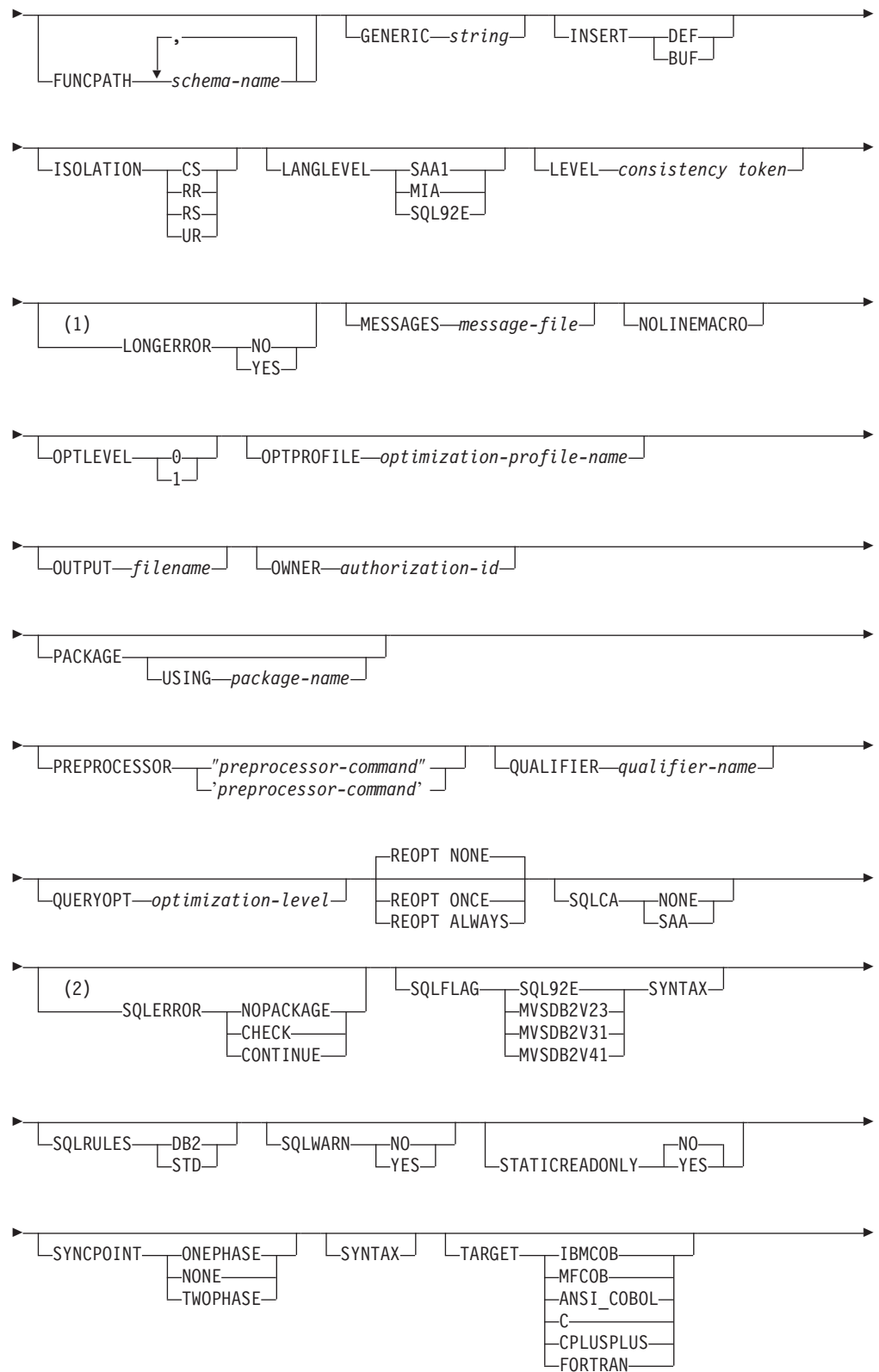

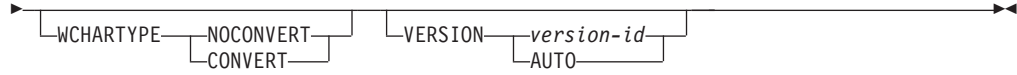

Notes:

- 1 NO is the default for 32 bit systems and for 64 bit NT systems where long host variables can be used as declarations for INTEGER columns. YES is the default for 64 bit UNIX systems.
- 2 SYNTAX is a synonym for SQLERROR(CHECK).

For DB2 Database on servers other than Linux, Windows and UNIX

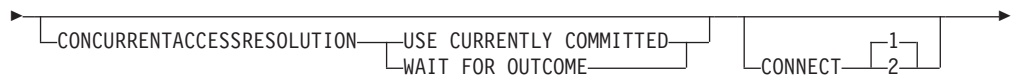
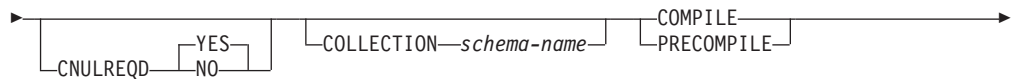
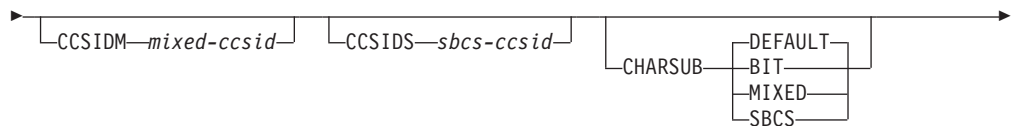
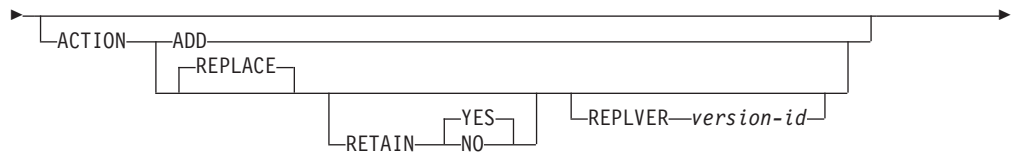
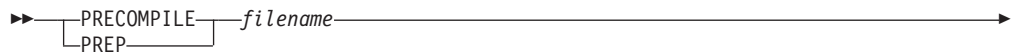

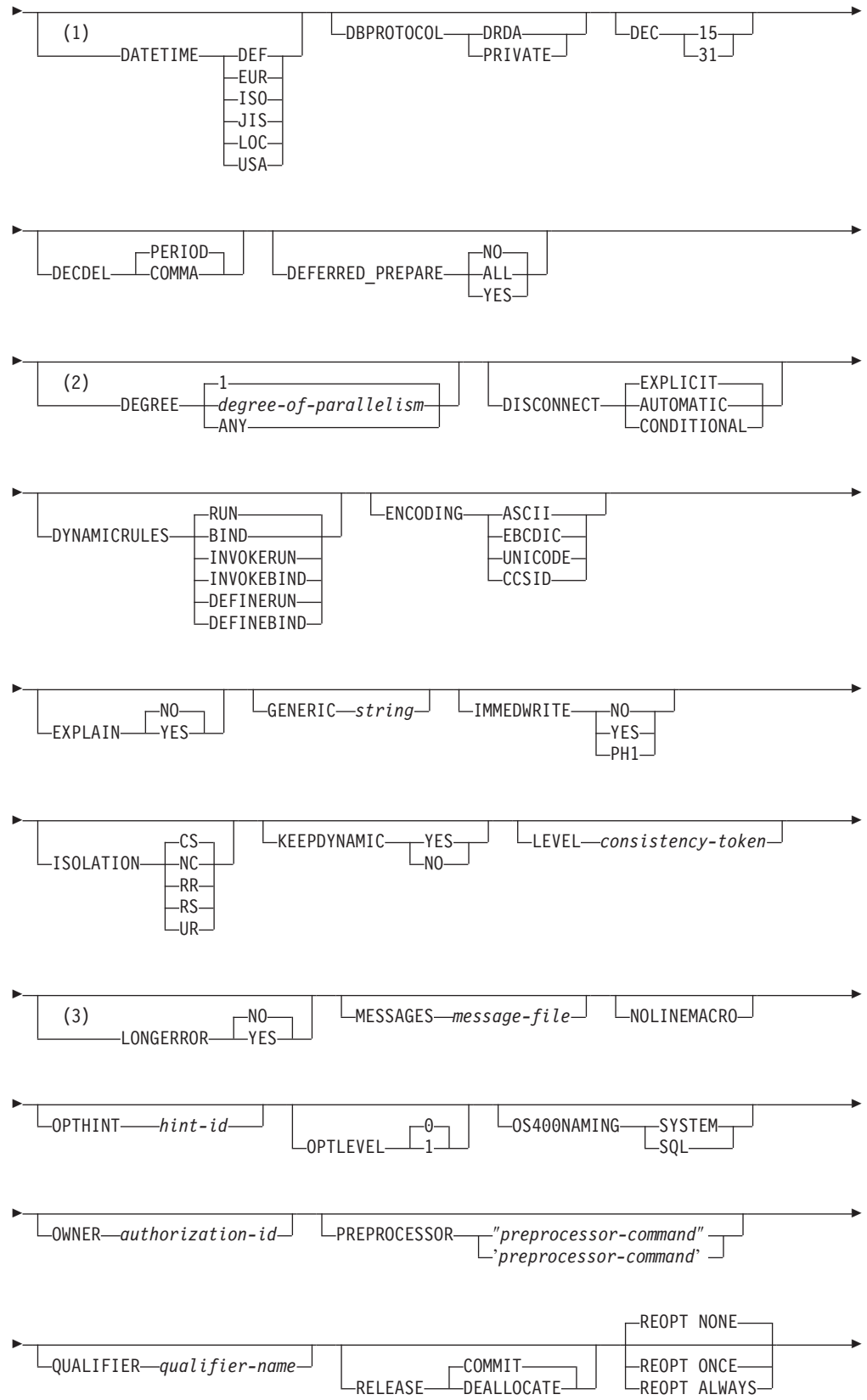

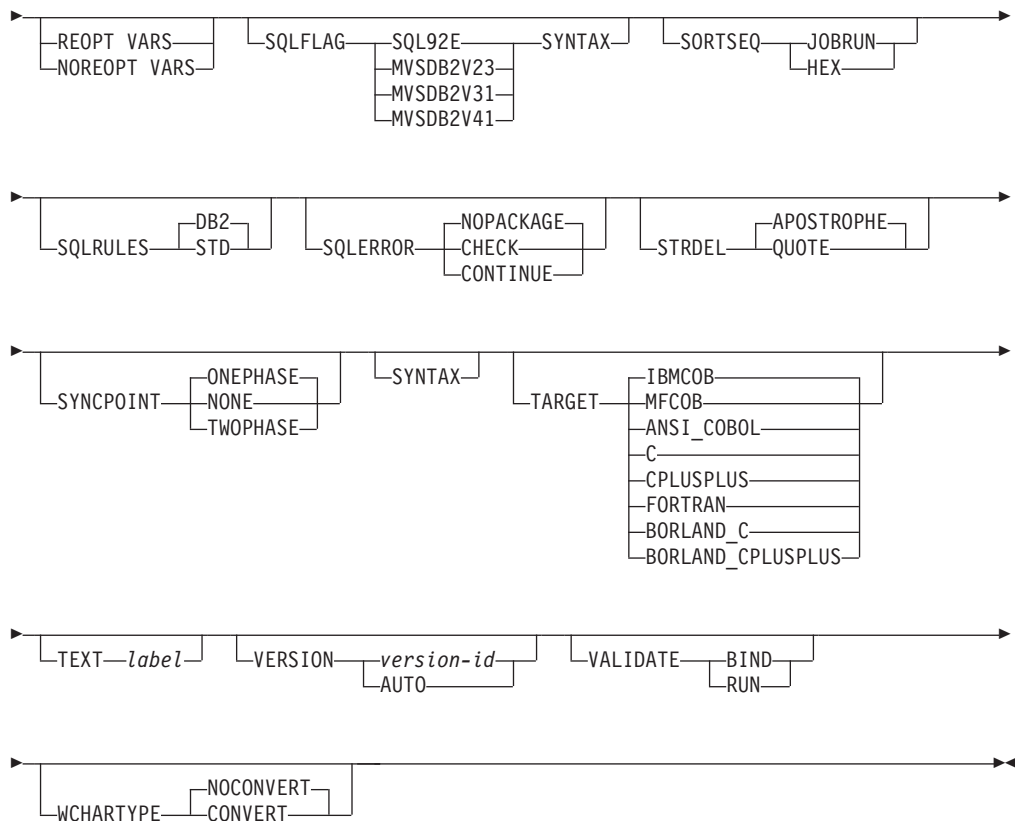

Notes:

- 1 If the server does not support the DATETIME DEF option, it is mapped to DATETIME ISO.
- 2 The DEGREE option is only supported by DRDA Level 2 Application Servers.
- 3 NO is the default for 32 bit systems and for 64 bit NT systems where long host variables can be used as declarations for INTEGER columns. YES is the default for 64 bit UNIX systems.

Command parameters

filename

Specifies the source file to be precompiled. An extension of:

- .sqc must be specified for C applications (generates a .c file)
- .sqx (Windows operating systems), or .sqC (UNIX and Linux operating systems) must be specified for C++ applications (generates a .cxx file on Windows operating systems, or a .C file on UNIX and Linux operating systems)
- .sqb must be specified for COBOL applications (generates a .cb1 file)
- .sqf must be specified for FORTRAN applications (generates a .for file on Windows operating systems, or a .f file on UNIX and Linux operating systems).

The preferred extension for C++ applications containing embedded SQL on UNIX and Linux operating systems is sqc; however, the sqx convention, which was invented for systems that are not case sensitive, is tolerated by UNIX and Linux operating systems.

ACTION

Indicates whether the package can be added or replaced.

ADD Indicates that the named package does not exist, and that a new package is to be created. If the package already exists, execution stops, and a diagnostic error message is returned.

REPLACE

Indicates that the existing package is to be replaced by a new one with the same package name and creator. This is the default value for the ACTION option.

RETAIN

Indicates whether EXECUTE authorities are to be preserved when a package is replaced. If ownership of the package changes, the new owner grants the BIND and EXECUTE authority to the previous package owner.

NO Does not preserve EXECUTE authorities when a package is replaced. This value is not supported by DB2.

YES Preserves EXECUTE authorities when a package is replaced. This is the default value.

REPLVER *version-id*

Replaces a specific version of a package. The version identifier specifies which version of the package is to be replaced. If the specified version does not exist, an error is returned. If the REPLVER option of REPLACE is not specified, and a package already exists that matches the package name and version of the package being precompiled, that package will be replaced; if not, a new package will be added.

APREUSE

Specifies whether static SQL access plans are to be reused. When this option is enabled, the query compiler will attempt to reuse the access plans for the statement in any existing packages during the bind and during future implicit and explicit rebinds.

YES The query compiler will attempt to reuse the access plans for the statements in the package. If there is an existing package, the query compiler will attempt to reuse the access plan for every statement that can be matched with a statement in the new bind file. For a statement to match, the statement text must be identical and the section number for the statement in the existing package must match what the section number will be for the statement in the new package.

NO The query compiler will not attempt to reuse access plans for the statements in the package. This is the default setting.

BINDFILE

Results in the creation of a bind file. A package is not created unless the package option is also specified. If a bind file is requested, but no package is to be created, as in the following example:

```
db2 prep sample.sqc bindfile
```

object existence and authentication SQLCODEs will be treated as warnings instead of errors. This will allow a bind file to be successfully created, even

if the database being used for precompilation does not have all of the objects referred to in static SQL statements within the application. The bind file can be successfully bound, creating a package, once the required objects have been created.

USING *bind-file*

The name of the bind file that is to be generated by the precompiler. The file name must have an extension of .bnd. If a file name is not entered, the precompiler uses the name of the program (entered as the *filename* parameter), and adds the .bnd extension. If a path is not provided, the bind file is created in the current directory.

BLOCKING

Specifies the type of row blocking for cursors. The blocking of row data that contains references to LOB column data types is also supported in environments where the Database Partitioning Feature (DPF) is enabled.

ALL For cursors that are specified with the FOR READ ONLY clause or cursors not specified as FOR UPDATE, blocking occurs.

Ambiguous cursors are treated as read-only.

NO Blocking does not occur for any cursor.

For the definition of a read-only cursor and an ambiguous cursor, refer to *DECLARE CURSOR statement*.

Ambiguous cursors are treated as updatable.

UNAMBIG

For cursors that are specified with the FOR READ ONLY clause, blocking occurs.

Cursors that are not declared with the FOR READ ONLY or FOR UPDATE clause which are not ambiguous and are read-only will be blocked. Ambiguous cursors will not be blocked.

Ambiguous cursors are treated as updatable.

CALL_RESOLUTION

If set, the CALL_RESOLUTION DEFERRED option indicates that the CALL statement will be executed as an invocation of the deprecated sqlproc() API. If not set or if IMMEDIATE is set, the CALL statement will be executed as a normal SQL statement. SQL0204 will be issued if the precompiler fails to resolve the procedure on a CALL statement with CALL_RESOLUTION IMMEDIATE.

CCSIDG *double-ccsid*

An integer specifying the coded character set identifier (CCSID) to be used for double byte characters in character column definitions (without a specific CCSID clause) in CREATE and ALTER TABLE SQL statements. This option is not supported by DB2 Database for Linux, UNIX, and Windows. The DRDA server will use a system defined default value if this option is not specified.

CCSIDM *mixed-ccsid*

An integer specifying the coded character set identifier (CCSID) to be used for mixed byte characters in character column definitions (without a specific CCSID clause) in CREATE and ALTER TABLE SQL statements.

This option is not supported by DB2 Database for Linux, UNIX, and Windows. The DRDA server will use a system defined default value if this option is not specified.

CCSIDS *sbc-ccsid*

An integer specifying the coded character set identifier (CCSID) to be used for single byte characters in character column definitions (without a specific CCSID clause) in CREATE and ALTER TABLE SQL statements. This option is not supported by DB2 Database for Linux, UNIX, and Windows. The DRDA server will use a system defined default value if this option is not specified.

CHARSUB

Designates the default character sub-type that is to be used for column definitions in CREATE and ALTER TABLE SQL statements. This DRDA precompile/bind option is not supported by DB2.

BIT Use the FOR BIT DATA SQL character sub-type in all new character columns for which an explicit sub-type is not specified.

DEFAULT

Use the target system defined default in all new character columns for which an explicit sub-type is not specified.

MIXED

Use the FOR MIXED DATA SQL character sub-type in all new character columns for which an explicit sub-type is not specified.

SBCS Use the FOR SBCS DATA SQL character sub-type in all new character columns for which an explicit sub-type is not specified.

CNULREQD

This option is related to the LANGLEVEL precompile option, which is not supported by DRDA. It is valid only if the bind file is created from a C or a C++ application. This DRDA bind option is not supported by DB2.

NO The application was coded on the basis of the LANGLEVEL SAA1 precompile option with respect to the null terminator in C string host variables.

YES The application was coded on the basis of the LANGLEVEL MIA precompile option with respect to the null terminator in C string host variables.

COLLECTION *schema-name*

Specifies a 128-byte collection identifier for the package. If not specified, the authorization identifier for the user processing the package is used.

CONCURRENTACCESSRESOLUTION

Specifies the concurrent access resolution to use for statements in the package.

USE CURRENTLY COMMITTED

Specifies that the database manager can use the currently committed version of the data for applicable scans when it is in the process of being updated or deleted. Rows in the process of being inserted can be skipped. This clause applies when the isolation level in effect is Cursor Stability or Read Stability (for Read Stability it skips uncommitted inserts only) and is ignored otherwise. Applicable scans include read-only scans that can be part of a read-only statement as well as a non read-only statement. The settings for the registry variables

DB2_EVALUNCOMMITTED, **DB2_SKIPDELETED**, and **DB2_SKIPINSERTED** no longer apply.

WAIT FOR OUTCOME

Specifies Cursor Stability and higher scans to wait for the commit or rollback when encountering data in the process of being updated. Rows in the process of being inserted or deleted rows are not skipped. The settings for the registry variables **DB2_EVALUNCOMMITTED**, **DB2_SKIPDELETED**, and **DB2_SKIPINSERTED** no longer apply.

CONNECT

- 1 Specifies that a **CONNECT** statement is to be processed as a type 1 **CONNECT**.
- 2 Specifies that a **CONNECT** statement is to be processed as a type 2 **CONNECT**.

DATETIME

Specifies the date and time format to be used.

- DEF** Use a date and time format associated with the territory code of the database.
- EUR** Use the IBM standard for Europe date and time format.
- ISO** Use the date and time format of the International Standards Organization.
- JIS** Use the date and time format of the Japanese Industrial Standard.
- LOC** Use the date and time format in local form associated with the territory code of the database.
- USA** Use the IBM standard for U.S. date and time format.

DBPROTOCOL

Specifies what protocol to use when connecting to a remote site that is identified by a three-part name statement. Supported by DB2 for OS/390 only. For a list of supported option values, refer to the documentation for DB2 for OS/390.

- DEC** Specifies the maximum precision to be used in decimal arithmetic operations. This DRDA precompile/bind option is not supported by DB2. The DRDA server will use a system defined default value if this option is not specified.
- 15 15-digit precision is used in decimal arithmetic operations.
 - 31 31-digit precision is used in decimal arithmetic operations.

DECDEL

Designates whether a period (.) or a comma (,) will be used as the decimal point indicator in decimal and floating point literals. This DRDA precompile/bind option is not supported by DB2. The DRDA server will use a system defined default value if this option is not specified.

COMMA

Use a comma (,) as the decimal point indicator.

PERIOD

Use a period (.) as the decimal point indicator.

DEFERRED_PREPARE

Provides a performance enhancement when accessing DB2 common server databases or DRDA databases. This option combines the SQL PREPARE statement flow with the associated OPEN, DESCRIBE, or EXECUTE statement flow to minimize inter-process or network flow.

NO The PREPARE statement will be executed at the time it is issued.

YES Execution of the PREPARE statement will be deferred until the corresponding OPEN, DESCRIBE, or EXECUTE statement is issued.

The PREPARE statement will not be deferred if it uses the INTO clause, which requires an SQLDA to be returned immediately. However, if the PREPARE INTO statement is issued for a cursor that does not use any parameter markers, the processing will be optimized by pre-OPENing the cursor when the PREPARE is executed.

ALL Same as YES, except that a PREPARE INTO statement is also deferred. If the PREPARE statement uses the INTO clause to return an SQLDA, the application must not reference the content of this SQLDA until the OPEN, DESCRIBE, or EXECUTE statement is issued and returned.

DEGREE

Specifies the degree of parallelism for the execution of static SQL statements in an SMP system. This option does not affect CREATE INDEX parallelism.

1 The execution of the statement will not use parallelism.

degree-of-parallelism

Specifies the degree of parallelism with which the statement can be executed, a value between 2 and 32 767 (inclusive).

ANY Specifies that the execution of the statement can involve parallelism using a degree determined by the database manager.

DISCONNECT

AUTOMATIC

Specifies that all database connections are to be disconnected at commit.

CONDITIONAL

Specifies that the database connections that have been marked RELEASE or have no open WITH HOLD cursors are to be disconnected at commit.

EXPLICIT

Specifies that only database connections that have been explicitly marked for release by the RELEASE statement are to be disconnected at commit.

DYNAMICRULES

Defines which rules apply to dynamic SQL at run time for the initial setting of the values used for authorization ID and for the implicit qualification of unqualified object references.

RUN Specifies that the authorization ID of the user executing the package is to be used for authorization checking of dynamic SQL statements. The authorization ID will also be used as the default

package qualifier for implicit qualification of unqualified object references within dynamic SQL statements. This is the default value.

BIND Specifies that all of the rules that apply to static SQL for authorization and qualification are to be used at run time. That is, the authorization ID of the package owner is to be used for authorization checking of dynamic SQL statements, and the default package qualifier is to be used for implicit qualification of unqualified object references within dynamic SQL statements.

DEFINERUN

If the package is used within a routine context, the authorization ID of the routine definer is to be used for authorization checking and for implicit qualification of unqualified object references within dynamic SQL statements within the routine.

If the package is used as a standalone application, dynamic SQL statements are processed as if the package were bound with DYNAMICRULES RUN.

DEFINEBIND

If the package is used within a routine context, the authorization ID of the routine definer is to be used for authorization checking and for implicit qualification of unqualified object references within dynamic SQL statements within the routine.

If the package is used as a standalone application, dynamic SQL statements are processed as if the package were bound with DYNAMICRULES BIND.

INVOKERUN

If the package is used within a routine context, the current statement authorization ID in effect when the routine is invoked is to be used for authorization checking of dynamic SQL statements and for implicit qualification of unqualified object references within dynamic SQL statements within that routine.

If the package is used as a standalone application, dynamic SQL statements are processed as if the package were bound with DYNAMICRULES RUN.

INVOKEBIND

If the package is used within a routine context, the current statement authorization ID in effect when the routine is invoked is to be used for authorization checking of dynamic SQL statements and for implicit qualification of unqualified object references within dynamic SQL statements within that routine.

If the package is used as a standalone application, dynamic SQL statements are processed as if the package were bound with DYNAMICRULES BIND.

Because dynamic SQL statements will be using the authorization ID of the package owner in a package exhibiting bind behavior, the binder of the package should not have any authorities granted to them that the user of the package should not receive. Similarly, when defining a routine that will exhibit define behavior, the definer of the routine should not have any authorities granted to them that the user of the package should not receive since a dynamic statement will be using the authorization ID of the routine's definer.

The following dynamically prepared SQL statements cannot be used within a package that was not bound with DYNAMICRULES RUN: GRANT, REVOKE, ALTER, CREATE, DROP, COMMENT ON, RENAME, SET INTEGRITY, and SET EVENT MONITOR STATE.

ENCODING

Specifies the encoding for all host variables in static statements in the plan or package. Supported by DB2 for OS/390 only. For a list of supported option values, refer to the documentation for DB2 for OS/390.

EXPLAIN

Stores information in the Explain tables about the access plans chosen for each SQL statement in the package. DRDA does not support the ALL value for this option.

NO Explain information will not be captured.

YES Explain tables will be populated with information about the chosen access plan at prep/bind time for static statements and at run time for incremental bind statements.

If the package is to be used for a routine and the package contains incremental bind statements, then the routine must be defined as MODIFIES SQL DATA. If this is not done, incremental bind statements in the package will cause a run time error (SQLSTATE 42985).

REOPT

Explain information for each reoptimizable incremental bind SQL statement will be placed in the Explain tables at run time. In addition, Explain information will be gathered for reoptimizable dynamic SQL statements at run time, even if the CURRENT EXPLAIN MODE special register is set to NO.

If the package is to be used for a routine, then the routine must be defined as MODIFIES SQL DATA, otherwise incremental bind and dynamic statements in the package will cause a run time error (SQLSTATE 42985).

ONLY The ONLY option allows you to explain statements without having the privilege to execute them. The explain tables are populated but no persistent package is created. If an existing package with the same name and version is encountered during the bind process, the existing package is neither dropped nor replaced even if you specified ACTION REPLACE. If an error occurs during population of the explain tables, explain information is not added for the statement that returned the error and for any statements that follow it.

ALL Explain information for each eligible static SQL statement will be placed in the Explain tables at prep/bind time. Explain information for each eligible incremental bind SQL statement will be placed in the Explain tables at run time. In addition, Explain information will be gathered for eligible dynamic SQL statements at run time, even if the CURRENT EXPLAIN MODE special register is set to NO.

If the package is to be used for a routine, then the routine must be defined as MODIFIES SQL DATA, otherwise incremental bind and dynamic statements in the package will cause a run time error (SQLSTATE 42985).

EXPLSNAP

Stores Explain Snapshot information in the Explain tables. This DB2 precompile/bind option is not supported by DRDA.

NO An Explain Snapshot will not be captured.

YES An Explain Snapshot for each eligible static SQL statement will be placed in the Explain tables at prep/bind time for static statements and at run time for incremental bind statements.

If the package is to be used for a routine and the package contains incremental bind statements, then the routine must be defined as MODIFIES SQL DATA or incremental bind statements in the package will cause a run time error (SQLSTATE 42985).

REOPT

Explain Snapshot information for each reoptimizable incremental bind SQL statement will be placed in the Explain tables at run time. In addition, Explain Snapshot information will be gathered for reoptimizable dynamic SQL statements at run time, even if the CURRENT EXPLAIN SNAPSHOT special register is set to NO.

If the package is to be used for a routine, then the routine must be defined as MODIFIES SQL DATA, otherwise incremental bind and dynamic statements in the package will cause a run time error (SQLSTATE 42985).

ALL An Explain Snapshot for each eligible static SQL statement will be placed in the Explain tables at prep/bind time. Explain Snapshot information for each eligible incremental bind SQL statement will be placed in the Explain tables at run time. In addition, Explain Snapshot information will be gathered for eligible dynamic SQL statements at run time, even if the CURRENT EXPLAIN SNAPSHOT special register is set to NO.

If the package is to be used for a routine, then the routine must be defined as MODIFIES SQL DATA, or incremental bind and dynamic statements in the package will cause a run time error (SQLSTATE 42985).

FEDERATED

Specifies whether a static SQL statement in a package references a nickname or a federated view. If this option is not specified and a static SQL statement in the package references a nickname or a federated view, a warning is returned and the package is created.

This option is not supported by DRDA servers.

NO A nickname or federated view is not referenced in the static SQL statements of the package. If a nickname or federated view is encountered in a static SQL statement during the prepare or bind phase of this package, an error is returned and the package is *not* created.

YES A nickname or federated view can be referenced in the static SQL statements of the package. If no nicknames or federated views are encountered in static SQL statements during the prepare or bind of the package, no errors or warnings are returned and the package is created.

FEDERATED_ASYNCRONY

Specifies the maximum number of asynchrony table queues (ATQs) that the federated server supports in the access plan for programs that use embedded SQL.

ANY The optimizer determines the number of ATQs for the access plan. The optimizer assigns an ATQ to all eligible SHIP or remote pushdown operators in the plan. The value that is specified for DB2_MAX_ASYNC_REQUESTS_PER_QUERY server option limits the number of asynchronous requests.

number_of_atqs_in_the_plan

The number of ATQs in the plan. You specify a number in the range 0 to 32767.

FUNCPATH

Specifies the function path to be used in resolving user-defined distinct types and functions in static SQL. If this option is not specified, the default function path is "SYSIBM","SYSFUN",USER where USER is the value of the USER special register. This DB2 precompile/bind option is not supported by DRDA.

schema-name

An SQL identifier, either ordinary or delimited, which identifies a schema that exists at the application server. No validation that the schema exists is made at precompile or at bind time. The same schema cannot appear more than once in the function path. The schema name SYSPUBLIC cannot be specified for the function path. The number of schemas that can be specified is limited by the length of the resulting function path, which cannot exceed 2048 bytes. The schema SYSIBM does not need to be explicitly specified; it is implicitly assumed to be the first schema if it is not included in the function path.

INSERT

Allows a program being precompiled or bound against a DB2 Enterprise Server Edition server to request that data inserts be buffered to increase performance.

BUF Specifies that inserts from an application should be buffered.

DEF Specifies that inserts from an application should not be buffered.

GENERIC *string*

Supports the binding of new options that are defined in the target database, but are not supported by DRDA. Do not use this option to pass bind options that *are* defined in BIND or PRECOMPILE. This option can substantially improve dynamic SQL performance. The syntax is as follows:

```
generic "option1 value1 option2 value2 ..."
```

Each option and value must be separated by one or more blank spaces. For example, if the target DRDA database is DB2 Universal Database, Version 8, one could use:

```
generic "explsnap all queryopt 3 federated yes"
```

to bind each of the EXPLSNAP, QUERYOPT, and FEDERATED options.

The maximum length of the string is 32768 bytes.

IMMEDWRITE

Indicates whether immediate writes will be done for updates made to

group buffer pool dependent pagesets or database partitions. Supported by DB2 for OS/390 only. For a list of supported option values, refer to the documentation for DB2 for OS/390.

ISOLATION

Determines how far a program bound to this package can be isolated from the effect of other executing programs.

- CS** Specifies Cursor Stability as the isolation level.
- NC** No Commit. Specifies that commitment control is not to be used. This isolation level is not supported by DB2.
- RR** Specifies Repeatable Read as the isolation level.
- RS** Specifies Read Stability as the isolation level. Read Stability ensures that the execution of SQL statements in the package is isolated from other application processes for rows read and changed by the application.
- UR** Specifies Uncommitted Read as the isolation level.

LANGLEVEL

Specifies the SQL rules that apply for both the syntax and the semantics for both static and dynamic SQL in the application. This option is not supported by DRDA servers.

- MIA** Select the ISO/ANS SQL92 rules as follows:
- To support error SQLCODE or SQLSTATE checking, an SQLCA must be declared in the application code.
 - C null-terminated strings are padded with blanks and always include a null-terminating character, even if truncation occurs.
 - The FOR UPDATE clause is optional for all columns to be updated in a positioned UPDATE.
 - A searched UPDATE or DELETE requires SELECT privilege on the object table of the UPDATE or DELETE statement if a column of the object table is referenced in the search condition or on the right hand side of the assignment clause.
 - A column function that can be resolved using an index (for example MIN or MAX) will also check for nulls and return warning SQLSTATE 01003 if there were any nulls.
 - An error is returned when a duplicate unique constraint is included in a CREATE or ALTER TABLE statement.
 - An error is returned when no privilege is granted and the grantor has no privileges on the object (otherwise a warning is returned).
- SAA1** Select the common IBM DB2 rules as follows:
- To support error SQLCODE or SQLSTATE checking, an SQLCA must be declared in the application code.
 - C null-terminated strings are not terminated with a null character if truncation occurs.
 - The FOR UPDATE clause is required for all columns to be updated in a positioned UPDATE.
 - A searched UPDATE or DELETE will not require SELECT privilege on the object table of the UPDATE or DELETE statement unless a fullselect in the statement references the object table.

- A column function that can be resolved using an index (for example MIN or MAX) will not check for nulls and warning SQLSTATE 01003 is not returned.
- A warning is returned and the duplicate unique constraint is ignored.
- An error is returned when no privilege is granted.

SQL92E

Defines the ISO/ANS SQL92 rules as follows:

- To support checking of SQLCODE or SQLSTATE values, variables by this name can be declared in the host variable declare section (if neither is declared, SQLCODE is assumed during precompilation).
- C null-terminated strings are padded with blanks and always include a null-terminating character, even if truncation occurs.
- The FOR UPDATE clause is optional for all columns to be updated in a positioned UPDATE.
- A searched UPDATE or DELETE requires SELECT privilege on the object table of the UPDATE or DELETE statement if a column of the object table is referenced in the search condition or on the right hand side of the assignment clause.
- A column function that can be resolved using an index (for example MIN or MAX) will also check for nulls and return warning SQLSTATE 01003 if there were any nulls.
- An error is returned when a duplicate unique constraint is included in a CREATE or ALTER TABLE statement.
- An error is returned when no privilege is granted and the grantor has no privileges on the object (otherwise a warning is returned).

KEEPDYNAMIC

Specifies whether dynamic SQL statements are to be kept after commit points. Supported by DB2 for OS/390 only. For a list of supported option values, refer to the documentation for DB2 for OS/390.

LEVEL *consistency-token*

Defines the level of a module using the consistency token. The consistency token is any alphanumeric value up to 8 characters in length. The RDB package consistency token verifies that the requester's application and the relational database package are synchronized. This option is not recommended for general use.

LONGERROR

Indicates whether long host variable declarations will be treated as an error. For portability, sqlint32 can be used as a declaration for an INTEGER column in precompiled C and C++ code.

NO Does not generate errors for the use of long host variable declarations. This is the default for 32 bit systems and for 64 bit NT systems where long host variables can be used as declarations for INTEGER columns. The use of this option on 64 bit UNIX platforms will allow long host variables to be used as declarations for BIGINT columns.

YES Generates errors for the use of long host variable declarations. This is the default for 64 bit UNIX systems.

MESSAGES *message-file*

Specifies the destination for warning, error, and completion status messages. A message file is created whether the bind is successful or not. If a message file name is not specified, the messages are written to standard output. If the complete path to the file is not specified, the current directory is used. If the name of an existing file is specified, the contents of the file are overwritten.

NOLINEMACRO

Suppresses the generation of the #line macros in the output .c file. Useful when the file is used with development tools which require source line information such as profiles, cross-reference utilities, and debuggers. This precompile option is used for the C/C++ programming languages only.

OPTHINT

Controls whether query optimization hints are used for static SQL. Supported by DB2 for OS/390 only. For a list of supported option values, refer to the documentation for DB2 for OS/390.

OPTLEVEL

Indicates whether the C/C++ precompiler is to optimize initialization of internal SQLDAs when host variables are used in SQL statements. Such optimization can increase performance when a single SQL statement (such as FETCH) is used inside a tight loop.

0 Instructs the precompiler not to optimize SQLDA initialization.

1 Instructs the precompiler to optimize SQLDA initialization. This value should not be specified if the application uses:

- pointer host variables, as in the following example:

```
exec sql begin declare section;  
char (*name)[20];  
short *id;  
exec sql end declare section;
```

- C++ data members directly in SQL statements.

OPTPROFILE *optimization-profile-name*

Specifies the name of an existing optimization profile to be used for all static statements in the package. The default value of the option is an empty string. The value also applies as the default for dynamic preparation of DML statements for which the CURRENT OPTIMIZATION PROFILE special register is null. If the specified name is unqualified, it is an SQL identifier, which is implicitly qualified by the QUALIFIER bind option.

The BIND command does not process the optimization file, but only validates that the name is syntactically valid. Therefore if the optimization profile does not exist or is invalid, an SQL0437W warning with reason code 13 will not occur until a DML statement is optimized using that optimization profile.

OUTPUT *filename*

Overrides the default name of the modified source file produced by the compiler. It can include a path.

OS400NAMING

Specifies which naming option is to be used when accessing DB2 for System i data. Supported by DB2 for System i only. For a list of supported option values, refer to the documentation for DB2 for System i.

Because of the slashes used as separators, a DB2 utility can still report a syntax error at execution time on certain SQL statements which use the

System i system naming convention, even though the utility might have been precompiled or bound with the OS400NAMING SYSTEM option. For example, the Command Line Processor will report a syntax error on an SQL CALL statement if the System i system naming convention is used, whether or not it has been precompiled or bound using the OS400NAMING SYSTEM option.

OWNER *authorization-id*

Designates a 128-byte authorization identifier for the package owner. The owner must have the privileges required to execute the SQL statements contained in the package. Only a user with DBADM authority can specify an authorization identifier other than the user ID. The default value is the primary authorization ID of the precompile/bind process. SYSIBM, SYSCAT, and SYSSTAT are not valid values for this option. The *authorization-id* can only be a user (cannot be a role or a group).

PACKAGE

Creates a package. If neither PACKAGE, BINDFILE, nor SYNTAX is specified, a package is created in the database by default.

USING *package-name*

The name of the package that is to be generated by the precompiler. If a name is not entered, the name of the application program source file (minus extension and folded to uppercase) is used. Maximum length is 128 bytes.

PREPROCESSOR "*preprocessor-command*"

Specifies the preprocessor command that can be executed by the precompiler before it processes embedded SQL statements. The preprocessor command string (maximum length 1024 bytes) must be enclosed either by double or by single quotation marks.

This option enables the use of macros within the declare section. A valid preprocessor command is one that can be issued from the command line to invoke the preprocessor without specifying a source file. For example,

```
xlc -P -DMYMACRO=0
```

QUALIFIER *qualifier-name*

Provides an 128-byte implicit qualifier for unqualified objects contained in the package. The default is the owner's authorization ID, whether or not **owner** is explicitly specified.

QUERYOPT *optimization-level*

Indicates the desired level of optimization for all static SQL statements contained in the package. The default value is 5. The SET CURRENT QUERY OPTIMIZATION statement describes the complete range of optimization levels available. This DB2 precompile/bind option is not supported by DRDA.

RELEASE

Indicates whether resources are released at each COMMIT point, or when the application terminates. This DRDA precompile/bind option is not supported by DB2.

COMMIT

Release resources at each COMMIT point. Used for dynamic SQL statements.

DEALLOCATE

Release resources only when the application terminates.

REOPT

Specifies whether to have DB2 optimize an access path using values for host variables, parameter markers, global variables, and special registers. Valid values are:

NONE

The access path for a given SQL statement containing host variables, parameter markers, global variables, or special registers will not be optimized using real values for these variables. The default estimates for these variables will be used instead, and this plan is cached and used subsequently. This is the default behavior.

ONCE The access path for a given SQL statement will be optimized using the real values of the host variables, parameter markers, global variables, or special registers when the query is first executed. This plan is cached and used subsequently.

ALWAYS

The access path for a given SQL statement will always be compiled and reoptimized using the values of the host variables, parameter markers, global variables, or special registers known at each execution time.

REOPT | NOREOPT VARS

These options have been replaced by REOPT ALWAYS and REOPT NONE; however, they are still supported for compatibility with previous releases. Specifies whether to have DB2 determine an access path at run time using values for host variables, global variables, parameter markers, and special registers. Supported by DB2 for OS/390 only. For a list of supported option values, refer to the documentation for DB2 for OS/390.

SQLCA

For FORTRAN applications only. This option is ignored if it is used with other languages.

NONE

Specifies that the modified source code is not consistent with the SAA definition.

SAA Specifies that the modified source code is consistent with the SAA definition.

SQLERROR

Indicates whether to create a package or a bind file if an error is encountered.

CHECK

Specifies that the target system performs all syntax and semantic checks on the SQL statements being bound. A package will not be created as part of this process. If, while binding, an existing package with the same name and version is encountered, the existing package is neither dropped nor replaced even if ACTION REPLACE was specified.

CONTINUE

Creates a package, even if errors occur when binding SQL statements. Those statements that failed to bind for authorization or existence reasons can be incrementally bound at execution time if VALIDATE RUN is also specified. Any attempt to execute them at run time generates an error (SQLCODE -525, SQLSTATE 51015).

NOPACKAGE

A package or a bind file is not created if an error is encountered.

SQLFLAG

Identifies and reports on deviations from the SQL language syntax specified in this option.

A bind file or a package is created only if the BINDFILE or the PACKAGE option is specified, in addition to the SQLFLAG option.

Local syntax checking is performed only if one of the following options is specified:

- BINDFILE
- PACKAGE
- SQLERROR CHECK
- SYNTAX

If SQLFLAG is not specified, the flagger function is not invoked, and the bind file or the package is not affected.

SQL92E SYNTAX

The SQL statements will be checked against ANSI or ISO SQL92 Entry level SQL language format and syntax with the exception of syntax rules that would require access to the database catalog. Any deviation is reported in the precompiler listing.

MVSDB2V23 SYNTAX

The SQL statements will be checked against MVS DB2 Version 2.3 SQL language syntax. Any deviation from the syntax is reported in the precompiler listing.

MVSDB2V31 SYNTAX

The SQL statements will be checked against MVS DB2 Version 3.1 SQL language syntax. Any deviation from the syntax is reported in the precompiler listing.

MVSDB2V41 SYNTAX

The SQL statements will be checked against MVS DB2 Version 4.1 SQL language syntax. Any deviation from the syntax is reported in the precompiler listing.

SORTSEQ

Specifies which sort sequence table to use on the System i system.

Supported by DB2 for System i only. For a list of supported option values, refer to the documentation for DB2 for System i.

SQLRULES

Specifies:

- Whether type 2 CONNECTs are to be processed according to the DB2 rules or the Standard (STD) rules based on ISO/ANS SQL92.
- How an application specifies the format of LOB columns in the result set.

DB2

- Permits the SQL CONNECT statement to switch the current connection to another established (*dormant*) connection.

- This default setting allows an application to specify whether LOB values or LOB locators are retrieved only during the first fetch request. Subsequent fetch requests must use the same format for the LOB columns.

STD

- Permits the SQL CONNECT statement to establish a *new* connection only. The SQL SET CONNECTION statement must be used to switch to a dormant connection.
- The application can change between retrieving LOB values and LOB locators with each fetch request. This means that cursors with one or more LOB columns cannot be blocked, regardless of the BLOCKING bind option setting.

SQLWARN

Indicates whether warnings will be returned from the compilation of dynamic SQL statements (via PREPARE or EXECUTE IMMEDIATE), or from describe processing (via PREPARE...INTO or DESCRIBE).

NO Warnings will not be returned from the SQL compiler.

YES Warnings will be returned from the SQL compiler.

SQLCODE +238 is an exception. It is returned regardless of the **sqlwarn** option value.

STATICREADONLY

Determines whether static cursors will be treated as being READ ONLY. This DB2 precompile/bind option is not supported by DRDA.

NO All static cursors will take on the attributes as would normally be generated given the statement text and the setting of the LANGLEVEL precompile option. This is the default value.

YES Any static cursor that does not contain the FOR UPDATE or FOR READ ONLY clause will be considered READ ONLY.

STRDEL

Designates whether an apostrophe (') or double quotation marks (") will be used as the string delimiter within SQL statements. This DRDA precompile/bind option is not supported by DB2. The DRDA server will use a system defined default value if this option is not specified.

APOSTROPHE

Use an apostrophe (') as the string delimiter.

QUOTE

Use double quotation marks (") as the string delimiter.

SYNCPOINT

Specifies how commits or rollbacks are to be coordinated among multiple database connections. This command parameter is ignored and is only included here for backward compatibility.

NONE

Specifies that no Transaction Manager (TM) is to be used to perform a two-phase commit, and does not enforce single updater, multiple reader. A COMMIT is sent to each participating database. The application is responsible for recovery if any of the commits fail.

ONEPHASE

Specifies that no TM is to be used to perform a two-phase commit. A one-phase commit is to be used to commit the work done by each database in multiple database transactions.

TWOPHASE

Specifies that the TM is required to coordinate two-phase commits among those databases that support this protocol.

SYNTAX

Suppresses the creation of a package or a bind file during precompilation. This option can be used to check the validity of the source file without modifying or altering existing packages or bind files. SYNTAX is a synonym for SQLERROR CHECK.

If SYNTAX is used together with the PACKAGE option, PACKAGE is ignored.

TARGET

Instructs the precompiler to produce modified code tailored to one of the supported compilers on the current platform.

IBMCOB

On AIX, code is generated for the IBM COBOL Set for AIX compiler.

MFCOB

Code is generated for the Micro Focus COBOL compiler. This is the default if a TARGET value is not specified with the COBOL precompiler on all Linux, UNIX and Windows operating systems.

ANSI_COBOL

Code compatible with the ANS X3.23-1985 standard is generated.

C

Code compatible with the C compilers supported by DB2 on the current platform is generated.

CPLUSPLUS

Code compatible with the C++ compilers supported by DB2 on the current platform is generated.

FORTTRAN

Code compatible with the FORTRAN compilers supported by DB2 on the current platform is generated.

TEXT *label*

The description of a package. Maximum length is 255 characters. The default value is blanks. This DRDA precompile/bind option is not supported by DB2.

TRANSFORM GROUP

Specifies the transform group name to be used by static SQL statements for exchanging user-defined structured type values with host programs. This transform group is not used for dynamic SQL statements or for the exchange of parameters and results with external functions or methods. This option is not supported by DRDA servers.

groupname

An SQL identifier of up to 128 bytes in length. A group name cannot include a qualifier prefix and cannot begin with the prefix SYS since this is reserved for database use. In a static SQL

statement that interacts with host variables, the name of the transform group to be used for exchanging values of a structured type is as follows:

- The group name in the TRANSFORM GROUP bind option, if any
- The group name in the TRANSFORM GROUP prep option as specified at the original precompilation time, if any
- The DB2_PROGRAM group, if a transform exists for the given type whose group name is DB2_PROGRAM
- No transform group is used if none of the above conditions exist.

The following errors are possible during the bind of a static SQL statement:

- SQLCODE *yyy*, SQLSTATE *xxxxx*: A transform is needed, but no static transform group has been selected.
- SQLCODE *yyy*, SQLSTATE *xxxxx*: The selected transform group does not include a necessary transform (TO SQL for input variables, FROM SQL for output variables) for the data type that needs to be exchanged.
- SQLCODE *yyy*, SQLSTATE *xxxxx*: The result type of the FROM SQL transform is not compatible with the type of the output variable, or the parameter type of the TO SQL transform is not compatible with the type of the input variable.

In these error messages, *yyyyy* is replaced by the SQL error code, and *xxxxx* by the SQL state code.

VALIDATE

Determines when the database manager checks for authorization errors and object not found errors. The package owner authorization ID is used for validity checking.

BIND Validation is performed at precompile/bind time. If all objects do not exist, or all authority is not held, error messages are produced. If `SQLERROR CONTINUE` is specified, a package/bind file is produced despite the error message, but the statements in error are not executable.

RUN Validation is attempted at bind time. If all objects exist, and all authority is held, no further checking is performed at execution time.

If all objects do not exist, or all authority is not held at precompile/bind time, warning messages are produced, and the package is successfully bound, regardless of the `SQLERROR CONTINUE` option setting. However, authority checking and existence checking for SQL statements that failed these checks during the precompile/bind process can be redone at execution time.

VERSION

Defines the version identifier for a package. If this option is not specified, the package version will be "" (the empty string).

version-id

Specifies a version identifier that is any alphanumeric value, \$, #, @, _ , -, or ., up to 64 characters in length.

AUTO

The version identifier will be generated from the consistency token. If the consistency token is a timestamp (it will be if the `LEVEL` option is not specified), the timestamp is converted into ISO character format and is used as the version identifier.

WCHARTYPE

Specifies the format for graphic data.

CONVERT

Host variables declared using the `wchar_t` base type will be treated as containing data in `wchar_t` format. Since this format is not directly compatible with the format of graphic data stored in the database (DBCS format), input data in `wchar_t` host variables is implicitly converted to DBCS format on behalf of the application, using the ANSI C function `wcstombs()`. Similarly, output DBCS data is implicitly converted to `wchar_t` format, using `mbstowcs()`, before being stored in host variables.

NOCONVERT

Host variables declared using the `wchar_t` base type will be treated as containing data in DBCS format. This is the format used within the database for graphic data; it is, however, different from the native `wchar_t` format implemented in the C language. Using `NOCONVERT` means that graphic data will not undergo conversion between the application and the database, which can improve efficiency. The application is, however, responsible for ensuring that data in `wchar_t` format is not passed to the database manager. When this option is used, `wchar_t` host variables should not be manipulated with the C wide character string functions, and should not be initialized with wide character literals (*L-literals*).

Usage notes

A modified source file is produced, which contains host language equivalents to the SQL statements. By default, a package is created in the database to which a connection has been established. The name of the package is the same as the file name (minus the extension and folded to uppercase), up to a maximum of 8 characters. Although the maximum length of a package name is 128 bytes, unless the `PACKAGE USING` option is specified, only the first 8 characters of the file name are used to maintain compatibility with previous versions of DB2.

Following connection to a database, PREP executes under the transaction that was started. PREP then issues a `COMMIT` or a `ROLLBACK` to terminate the current transaction and start another one.

Creating a package with a schema name that does not already exist results in the implicit creation of that schema. The schema owner is `SYSIBM`. The `CREATEIN` privilege on the schema is granted to `PUBLIC`.

During precompilation, an Explain Snapshot is not taken unless a package is created and `EXPLSNAP` has been specified. The snapshot is put into the Explain tables of the user creating the package. Similarly, Explain table information is only captured when `EXPLAIN` is specified, and a package is created.

Precompiling stops if a fatal error or more than 100 errors occur. If a fatal error occurs, the utility stops precompiling, attempts to close all files, and discards the package.

When a package exhibits bind behavior, the following will be true:

1. The implicit or explicit value of the BIND option OWNER will be used for authorization checking of dynamic SQL statements.
2. The implicit or explicit value of the BIND option QUALIFIER will be used as the implicit qualifier for qualification of unqualified objects within dynamic SQL statements.
3. The value of the special register CURRENT SCHEMA has no effect on qualification.

In the event that multiple packages are referenced during a single connection, all dynamic SQL statements prepared by those packages will exhibit the behavior as specified by the DYNAMICRULES option for that specific package and the environment they are used in.

If an SQL statement was found to be in error and the PRECOMPILE option SQLERROR CONTINUE was specified, the statement will be marked as invalid and another PRECOMPILE must be issued in order to change the state of the SQL statement. Implicit and explicit rebind will not change the state of an invalid statement in a package bound with VALIDATE RUN. A statement can change from static to incremental bind or incremental bind to static across implicit and explicit rebinds depending on whether or not object existence or authority problems exist during the rebind.

Binding a package with REOPT ONCE or REOPT ALWAYS might change static and dynamic statement compilation and performance.

For an embedded SQL program, if the FEDERATED_ASYNCHRONY precompile option is not explicitly specified the static statements in the package are bound using the FEDERATED_ASYNC configuration parameter. If the FEDERATED_ASYNCHRONY option is specified explicitly, that value is used for binding the packages and is also the initial value of the special register. Otherwise, the value of the database manager configuration parameter is used as the initial value of the special register. The FEDERATED_ASYNCHRONY precompile option influences dynamic SQL only when it is explicitly set.

Chapter 90. PRUNE HISTORY/LOGFILE

Used to delete entries from the recovery history file or to delete log files from the active log file path. Deleting entries from the recovery history file might be necessary if the file becomes excessively large and the retention period is high.

Authorization

One of the following:

- *sysadm*
- *sysctrl*
- *sysmaint*
- *dbadm*

Required connection

Database

Command syntax

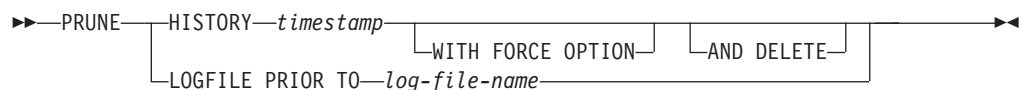

Command parameters

HISTORY *timestamp*

Identifies a range of entries in the recovery history file that will be deleted. A complete time stamp (in the form *yyyymmddhhmmss*), or an initial prefix (minimum *yyyy*) can be specified. All entries with time stamps equal to or less than the time stamp provided are deleted from the recovery history file.

WITH FORCE OPTION

Specifies that the entries will be pruned according to the time stamp specified, even if some entries from the most recent restore set are deleted from the file. A restore set is the most recent full database backup including any restores of that backup image. If this parameter is not specified, all entries from the backup image forward will be maintained in the history.

AND DELETE

Specifies that the associated log archives will be physically deleted (based on the location information) when the history file entry is removed. This option is especially useful for ensuring that archive storage space is recovered when log archives are no longer needed. If you are archiving logs via a user exit program, the logs cannot be deleted using this option.

If you set the **auto_del_rec_obj** database configuration parameter to ON, calling PRUNE HISTORY with the AND DELETE parameter will also physically delete backup images and load copy images if their history file entry is pruned.

LOGFILE PRIOR TO *log-file-name*

Specifies a string for a log file name, for example S0000100.LOG. All log files prior to (but not including) the specified log file will be deleted. The **logretain** database configuration parameter must be set to RECOVERY or CAPTURE.

Examples

To remove the entries for all restores, loads, table space backups, and full database backups taken before and including December 1, 1994 from the recovery history file, enter:

```
db2 prune history 199412
```

199412 is interpreted as 19941201000000.

Usage notes

If the WITH FORCE OPTION is used, you might delete entries that are required for automatic restoration of databases. Manual restores will still work correctly. Use of this command can also prevent the db2ckrst utility from being able to correctly analyze the complete chain of required backup images. Using the PRUNE HISTORY command without the WITH FORCE OPTION prevents required entries from being deleted.

Those entries with status DB2HISTORY_STATUS_DO_NOT_DELETE will not be pruned. If the WITH FORCE OPTION is used, then objects marked as DB2HISTORY_STATUS_DO_NOT_DELETE will still be pruned or deleted. You can set the status of recovery history file entries to DB2HISTORY_STATUS_DO_NOT_DELETE using the UPDATE HISTORY command, the ADMIN_CMD with UPDATE_HISTORY, or the db2HistoryUpdate API. You can use the DB2HISTORY_STATUS_DO_NOT_DELETE status to prevent key recovery history file entries from being pruned and to prevent associated recovery objects from being deleted.

You can prune snapshot backup database history file entries using the PRUNE HISTORY command, but you cannot delete the related physical recovery objects using the AND DELETE parameter. The only way to delete snapshot backup object is to use the db2acsutil command.

Chapter 91. PUT ROUTINE

Uses the specified routine SQL Archive (SAR) file to define a routine in the database.

Authorization

dbadm. This authority must be granted directly to the user and not inherited via a role.

Required connection

Database. If implicit connect is enabled, a connection to the default database is established.

Command syntax

```
➤➤ PUT ROUTINE FROM file-name [OWNER new-owner] [USE REGISTERS]
```

Command parameters

FROM *file-name*

Names the file where routine SQL archive (SAR) is stored.

OWNER *new-owner*

Specifies a new authorization name that will be used for authorization checking of the routine. The new owner must have the necessary privileges for the routine to be defined. If the OWNER clause is not specified, the authorization name that was originally defined for the routine is used.

USE REGISTERS

Indicates that the CURRENT SCHEMA and CURRENT PATH special registers are used to define the routine. If this clause is not specified, the settings for the default schema and SQL path are the settings used when the routine is defined. CURRENT SCHEMA is used as the schema name for unqualified object names in the routine definition (including the name of the routine) and CURRENT PATH is used to resolve unqualified routines and data types in the routine definition.

Examples

```
PUT ROUTINE FROM procs/proc1.sar;
```

Usage notes

No more than one procedure can be concurrently installed under a given schema.

If a GET ROUTINE or a PUT ROUTINE operation (or their corresponding procedure) fails to execute successfully, it will always return an error (SQLSTATE 38000), along with diagnostic text providing information about the cause of the failure. For example, if the procedure name provided to GET ROUTINE does not identify an SQL procedure, diagnostic "-204, 42704" text will be returned, where "-204" and "42704" are the SQLCODE and SQLSTATE, respectively, that identify the

cause of the problem. The `SQLCODE` and `SQLSTATE` in this example indicate that the procedure name provided in the `GET ROUTINE` command is undefined.

Chapter 92. QUERY CLIENT

Returns current connection settings for an application process.

Authorization

None

Required connection

None

Command syntax

►►—QUERY CLIENT—◄◄

Command parameters

None

Examples

The following is sample output from QUERY CLIENT:

The current connection settings of the application process are:

```
CONNECT      = 1
DISCONNECT   = EXPLICIT
MAX_NETBIOS_CONNECTIONS = 1
SQLRULES     = DB2
SYNCPOINT    = ONEPHASE
CONNECT_DBPARTITIONNUM = CATALOG_DBPARTITIONNUM
ATTACH_DBPARTITIONNUM  = -1
```

If `CONNECT_DBPARTITIONNUM` and `ATTACH_DBPARTITIONNUM` are not set using the `SET CLIENT` command, these parameters have values identical to that of the environment variable `DB2NODE`. If the displayed value of the `CONNECT_DBPARTITIONNUM` or the `ATTACH_DBPARTITIONNUM` parameter is `-1`, the parameter has not been set; that is, either the environment variable `DB2NODE` has not been set, or the parameter was not specified in a previously issued `SET CLIENT` command.

Usage notes

The connection settings for an application process can be queried at any time during execution.

Chapter 93. QUIESCE

Forces all users off the specified instance and database and puts it into a quiesced mode. While the database instance or database is in quiesced mode, you can perform administrative tasks on it. After administrative tasks are complete, use the UNQUIESCE command to activate the instance and database and allow other users to connect to the database but avoid having to shut down and perform another database start.

In this mode, only users with authority in this restricted mode are allowed to attach or connect to the instance/database. Users with *sysadm*, *sysmaint*, and *sysctrl* authority always have access to an instance while it is quiesced, and users with *sysadm* and *dbadm* authority always have access to a database while it is quiesced.

Scope

QUIESCE DATABASE results in all objects in the database being in the quiesced mode. Only the allowed user/group and *sysadm*, *sysmaint*, *dbadm*, or *sysctrl* will be able to access the database or its objects.

QUIESCE INSTANCE *instance-name* means the instance and the databases in the instance *instance-name* will be in quiesced mode. The instance will be accessible just for *sysadm*, *sysmaint*, and *sysctrl* and allowed user/group.

If an instance is in quiesced mode, a database in the instance cannot be put in quiesced mode.

Authorization

One of the following:

For database level quiesce:

- *sysadm*
- *dbadm*

For instance level quiesce:

- *sysadm*
- *sysctrl*

Required connection

Database

(Database connection is not required for an instance quiesce.)

Command syntax

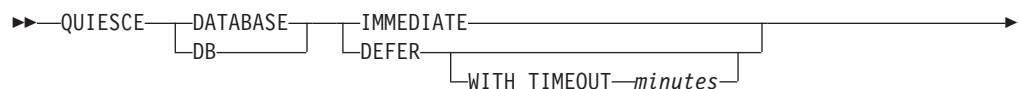

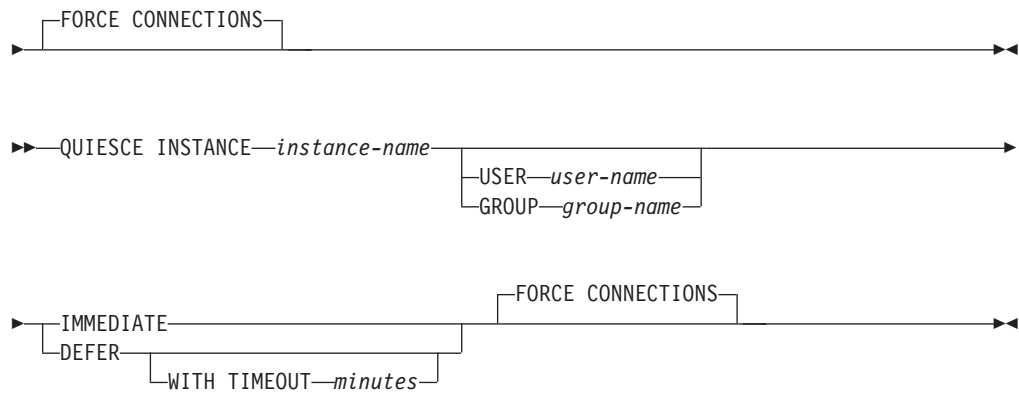

Command parameters

DEFER

Wait for applications until they commit the current unit of work.

WITH TIMEOUT *minutes*

Specifies a time, in minutes, to wait for applications to commit the current unit of work. If no value is specified, in a single-partition database environment, the default value is 10 minutes. In a partitioned database environment the value specified by the **start_stop_time** database manager configuration parameter will be used.

IMMEDIATE

Do not wait for the transactions to be committed, immediately rollback the transactions.

FORCE CONNECTIONS

Force the connections off.

DATABASE

Quiesce the database. All objects in the database will be placed in quiesced mode. Only specified users in specified groups and users with *sysadm*, *sysmaint*, and *sysctrl* authority will be able to access to the database or its objects.

INSTANCE *instance-name*

The instance *instance-name* and the databases in the instance will be placed in quiesced mode. The instance will be accessible only to users with *sysadm*, *sysmaint*, and *sysctrl* authority and specified users in specified groups.

USER *user-name*

Specifies the name of a user who will be allowed access to the instance while it is quiesced.

GROUP *group-name*

Specifies the name of a group that will be allowed access to the instance while the instance is quiesced.

Examples

In the following example, the default behavior is to force connections, so it does not need to be explicitly stated and can be removed from this example.

```
db2 quiesce instance crankarm user frank immediate force connections
```

The following example forces off all users with connections to the database.

```
db2 quiesce db immediate
```

- The first example will quiesce the instance crankarm, while allowing user frank to continue using the database.

The second example will quiesce the database you are attached to, preventing access by all users except those with one of the following authorities: *sysadm*, *sysmaint*, *sysctrl*, or *dbadm*.

- This command will force all users off the database or instance if FORCE CONNECTIONS option is supplied. FORCE CONNECTIONS is the default behavior; the parameter is allowed in the command for compatibility reasons.
- The command will be synchronized with the FORCE CONNECTIONS and will only complete once the FORCE CONNECTIONS has completed.

Usage notes

- After QUIESCE INSTANCE, only users with *sysadm*, *sysmaint*, or *sysctrl* authority or a user name and group name provided as parameters to the command can connect to the instance.
- After QUIESCE DATABASE, users with *sysadm*, *sysmaint*, *sysctrl*, or *dbadm* authority, and GRANT/REVOKE privileges can designate who will be able to connect. This information will be stored permanently in the database catalog tables.

For example,

```
grant quiesce_connect on database to <username/groupname>  
revoke quiesce_connect on database from <username/groupname>
```

Chapter 94. QUIESCE TABLESPACES FOR TABLE

Quiesces table spaces for a table. There are three valid quiesce modes: share, intent to update, and exclusive. There are three possible states resulting from the quiesce function:

- Quiesced: SHARE
- Quiesced: UPDATE
- Quiesced: EXCLUSIVE

Scope

In a single-partition environment, this command quiesces all table spaces involved in a load operation in exclusive mode for the duration of the load operation. In a partitioned database environment, this command acts locally on a database partition. It quiesces only that portion of table spaces belonging to the database partition on which the load operation is performed. For partitioned tables, all of the table spaces listed in SYSDATAPARTITIONS.TBSPACEID and SYSDATAPARTITIONS.LONG_TBSPACEID associated with a table and with a status of normal, attached or detached, (for example, SYSDATAPARTITIONS.STATUS of 'N', 'A' or 'D', respectively) are quiesced.

Authorization

One of the following:

- *sysadm*
- *sysctrl*
- *sysmaint*
- *dbadm*
- *load*

Required connection

Database

Command syntax

```
►► QUIESCE TABLESPACES FOR TABLE tablename | schema.tablename | SHARE | INTENT TO UPDATE | EXCLUSIVE | RESET
```

Command parameters

TABLE

tablename

Specifies the unqualified table name. The table cannot be a system catalog table.

schema.tablename

Specifies the qualified table name. If *schema* is not provided, the CURRENT SCHEMA will be used. The table cannot be a system catalog table.

SHARE

Specifies that the quiesce is to be in share mode.

When a "quiesce share" request is made, the transaction requests intent share locks for the table spaces and a share lock for the table. When the transaction obtains the locks, the state of the table spaces is changed to QUIESCED SHARE. The state is granted to the quiescer only if there is no conflicting state held by other users. The state of the table spaces, along with the authorization ID and the database agent ID of the quiescer, are recorded in the table space table, so that the state is persistent. The table cannot be changed while the table spaces for the table are in QUIESCED SHARE state. Other share mode requests to the table and table spaces are allowed. When the transaction commits or rolls back, the locks are released, but the table spaces for the table remain in QUIESCED SHARE state until the state is explicitly reset.

INTENT TO UPDATE

Specifies that the quiesce is to be in intent to update mode.

When a "quiesce intent to update" request is made, the table spaces are locked in intent exclusive (IX) mode, and the table is locked in update (U) mode. The state of the table spaces is recorded in the table space table.

EXCLUSIVE

Specifies that the quiesce is to be in exclusive mode.

When a "quiesce exclusive" request is made, the transaction requests super exclusive locks on the table spaces, and a super exclusive lock on the table. When the transaction obtains the locks, the state of the table spaces changes to QUIESCED EXCLUSIVE. The state of the table spaces, along with the authorization ID and the database agent ID of the quiescer, are recorded in the table space table. Since the table spaces are held in super exclusive mode, no other access to the table spaces is allowed. The user who invokes the quiesce function (the quiescer) has exclusive access to the table and the table spaces.

RESET

Specifies that the state of the table spaces is to be reset to normal. A quiesce state cannot be reset if the connection that issued the quiesce request is still active.

Example

```
db2 quiesce tablespaces for table staff share
```

```
db2 quiesce tablespaces for table boss.org intent to update
```

Usage notes

This command is not supported for declared temporary tables.

A quiesce is a persistent lock. Its benefit is that it persists across transaction failures, connection failures, and even across system failures (such as power failure, or reboot).

A quiesce is owned by a connection. If the connection is lost, the quiesce remains, but it has no owner, and is called a *phantom quiesce*. For example, if a power outage caused a load operation to be interrupted during the delete phase, the table spaces for the loaded table would be left in delete pending, quiesce exclusive state. Upon database restart, this quiesce would be an unowned (or phantom) quiesce. The removal of a phantom quiesce requires a connection with the same user ID used when the quiesce mode was set.

To remove a phantom quiesce:

1. Connect to the database with the same user ID used when the quiesce mode was set.
2. Use the LIST TABLESPACES command to determine which table space is quiesced.
3. Re-quiesce the table space using the current quiesce state. For example:

```
db2 quiesce tablespaces for table mytable exclusive
```

Once completed, the new connection owns the quiesce, and the load operation can be restarted.

There is a limit of five quiescers on a table space at any given time.

A quiescer can upgrade the state of a table space from a less restrictive state to a more restrictive one (for example, S to U, or U to X). If a user requests a state lower than one that is already held, the original state is returned. States are not downgraded.

Chapter 95. QUIT

Exits the command line processor interactive input mode and returns to the operating system command prompt. If a batch file is being used to input commands to the command line processor, commands are processed until QUIT, TERMINATE, or the end-of-file is encountered.

Authorization

None

Required connection

None

Command syntax

»—QUIT—«

Command parameters

None

Usage notes

QUIT does not terminate the command line processor back-end process or break a database connection. CONNECT RESET breaks a connection, but does not terminate the back-end process. The TERMINATE command does both.

Chapter 96. REBIND

Allows the user to recreate a package stored in the database without the need for a bind file.

Authorization

One of the following:

- *dbadm* authority
- ALTERIN privilege on the schema
- BIND privilege on the package.

The authorization ID logged in the BOUNDBY column of the SYSCAT.PACKAGES system catalog table, which is the ID of the most recent binder of the package, is used as the binder authorization ID for the rebind, and for the default *schema* for table references in the package. This default qualifier can be different from the authorization ID of the user executing the rebind request. REBIND will use the same bind options that were specified when the package was created.

Required connection

Database. If no database connection exists, and if implicit connect is enabled, a connection to the default database is made.

Command syntax

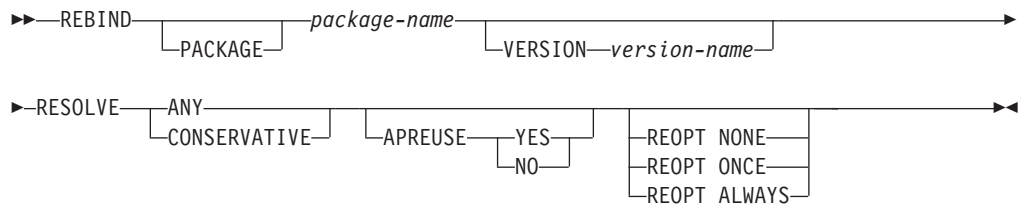

Command parameters

PACKAGE *package-name*

The qualified or unqualified name that designates the package to be rebound.

VERSION *version-name*

The specific version of the package to be rebound. When the version is not specified, it is taken to be "" (the empty string).

RESOLVE

Specifies whether rebinding of the package is to be performed with or without conservative binding semantics. This affects whether new objects that use the SQL path for resolution are considered during resolution on static DML statements in the package. This option is not supported by DRDA. Valid values are:

ANY All possible matches in the SQL path are considered for resolving

references to any objects that use the SQL path for object resolution. Conservative binding semantics are not used. This is the default.

CONSERVATIVE

Only those objects in the SQL path that were defined before the last explicit bind time stamp are considered for resolving references to any objects that use the SQL path for object resolution. Conservative binding semantics are used. This option is not supported for an inoperative package.

APREUSE

Specifies whether static SQL access plans are to be reused. When this option is enabled, the query compiler will attempt to reuse the access plans for static SQL statements in the existing package during the rebind and during future implicit and explicit rebinds. The default is the value used during the previous invocation of the BIND or REBIND command or the ALTER PACKAGE statement. To determine the value, query the APREUSE column for the package in SYSCAT.PACKAGES.

YES The query compiler will attempt to reuse the access plans for the statements in the package.

NO The query compiler will not attempt to reuse access plans for the statements in the package.

REOPT

Specifies whether to have DB2 optimize an access path using values for host variables, parameter markers, global variables, and special registers.

NONE

The access path for a given SQL statement containing host variables, parameter markers, global variables, or special registers will not be optimized using real values for these variables. The default estimates for these variables will be used instead, and this plan is cached and used subsequently. This is the default behavior.

ONCE The access path for a given SQL statement will be optimized using the real values of the host variables, parameter markers, global variables, or special registers when the query is first executed. This plan is cached and used subsequently.

ALWAYS

The access path for a given SQL statement will always be compiled and re-optimized using the values of the host variables, parameter markers, global variables, or special registers known at each execution time.

Usage notes

REBIND does not automatically commit the transaction following a successful rebind. The user must explicitly commit the transaction. This enables "what if" analysis, in which the user updates certain statistics, and then tries to rebind the package to see what changes. It also permits multiple rebinds within a unit of work.

The REBIND command *will* commit the transaction if auto-commit is enabled.

This command:

- Provides a quick way to recreate a package. This enables the user to take advantage of a change in the system without a need for the original bind file. For example, if it is likely that a particular SQL statement can take advantage of a newly created index, the REBIND command can be used to recreate the package. REBIND can also be used to recreate packages after RUNSTATS has been executed, thereby taking advantage of the new statistics.
- Provides a method to recreate inoperative packages. Inoperative packages must be explicitly rebound by invoking either the bind utility or the rebound utility. A package will be marked inoperative (the VALID column of the SYSCAT.PACKAGES system catalog will be set to X) if a function instance on which the package depends is dropped.
- Gives users control over the rebinding of invalid packages. Invalid packages will be automatically (or implicitly) rebound by the database manager when they are executed. This might result in a noticeable delay in the execution of the first SQL request for the invalid package. It may be desirable to explicitly rebound invalid packages, rather than allow the system to automatically rebound them, in order to eliminate the initial delay and to prevent unexpected SQL error messages which might be returned in case the implicit rebound fails. For example, following database upgrade, all packages stored in the database will be invalidated by the UPGRADE DATABASE command. Given that this might involve a large number of packages, it may be desirable to explicitly rebound all of the invalid packages at one time. This explicit rebinding can be accomplished using BIND, REBIND, or the db2rbind tool).

If multiple versions of a package (many versions with the same package name and creator) exist, only one version can be rebound at once. If not specified in the VERSION option, the package version defaults to be "". Even if there exists only one package with a name that matches, it will not be rebound unless its version matches the one specified or the default.

The choice of whether to use BIND or REBIND to explicitly rebound a package depends on the circumstances. It is recommended that REBIND be used whenever the situation does not specifically require the use of BIND, since the performance of REBIND is significantly better than that of BIND. BIND *must* be used, however:

- When there have been modifications to the program (for example, when SQL statements have been added or deleted, or when the package does not match the executable for the program).
- When the user wishes to modify any of the bind options as part of the rebound. REBIND does not support any bind options. For example, if the user wishes to have privileges on the package granted as part of the bind process, BIND must be used, since it has a GRANT option.
- When the package does not currently exist in the database.
- When detection of *all* bind errors is desired. REBIND only returns the first error it detects, whereas the BIND command returns the first 100 errors that occur during binding.

REBIND is supported by DB2 Connect.

If REBIND is executed on a package that is in use by another user, the rebound will not occur until the other user's logical unit of work ends, because an exclusive lock is held on the package's record in the SYSCAT.PACKAGES system catalog table during the rebound.

When REBIND is executed, the database manager recreates the package from the SQL statements stored in the SYSCAT.STATEMENTS system catalog table.

If REBIND encounters an error, processing stops, and an error message is returned.

REBIND will re-explain packages that were created with the EXPLSNAP bind option set to YES or ALL (indicated in the EXPLAIN_SNAPSHOT column in the SYSCAT.PACKAGES catalog table entry for the package) or with the EXPLAIN bind option set to YES or ALL (indicated in the EXPLAIN_MODE column in the SYSCAT.PACKAGES catalog table entry for the package). The Explain tables used are those of the REBIND requester, not the original binder.

If an SQL statement was found to be in error and the BIND option SQLERROR CONTINUE was specified, the statement will be marked as invalid even if the problem has been corrected. REBIND will not change the state of an invalid statement. In a package bound with VALIDATE RUN, a statement can change from static to incremental bind or incremental bind to static across a REBIND depending on whether or not object existence or authority problems exist during the REBIND.

Rebinding a package with REOPT ONCE | ALWAYS might change static and dynamic statement compilation and performance.

If REOPT is not specified, REBIND will preserve the existing REOPT value used at precompile or bind time.

Chapter 97. RECOVER DATABASE

Restores and rolls forward a database to a particular point in time or to the end of the logs.

Scope

In a partitioned database environment, this command can only be invoked from the catalog partition. A database recover operation to a specified point in time affects all database partitions that are listed in the `db2nodes.cfg` file. A database recover operation to the end of logs affects the database partitions that are specified. If no partitions are specified, it affects all database partitions that are listed in the `db2nodes.cfg` file.

Authorization

To recover an existing database, one of the following:

- *sysadm*
- *sysctrl*
- *sysmaint*

To recover to a new database, one of the following:

- *sysadm*
- *sysctrl*

Required connection

To recover an existing database, a database connection is required. This command automatically establishes a connection to the specified database and will release the connection when the recover operation finishes. To recover to a new database, an instance attachment and a database connection are required. The instance attachment is required to create the database.

Command syntax

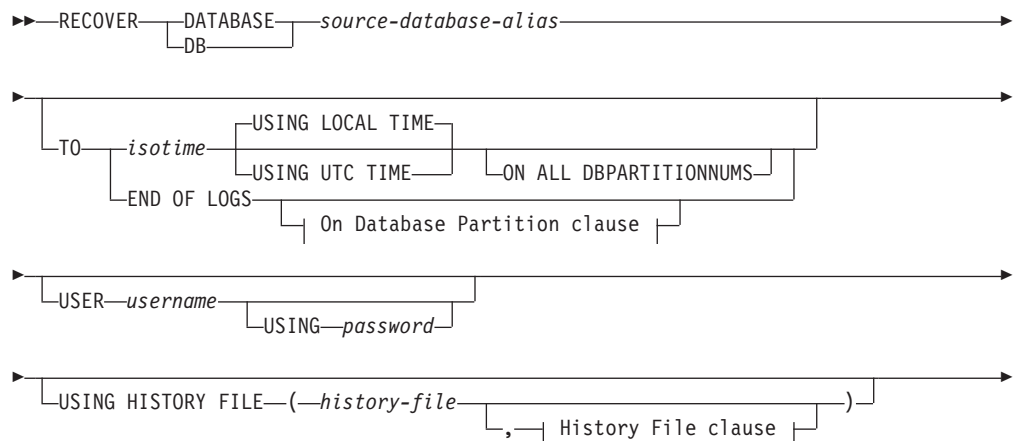

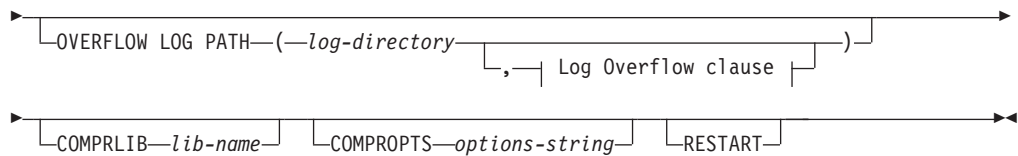

On Database Partition clause:

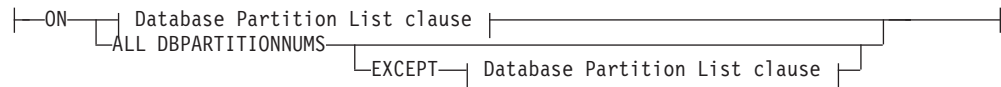

Database Partition List clause:

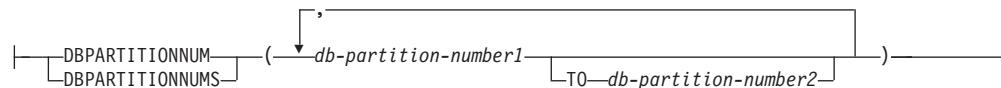

Log Overflow clause:

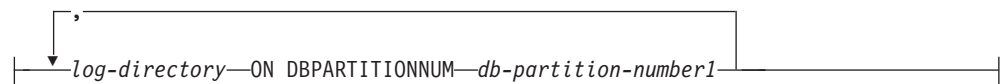

History File clause:

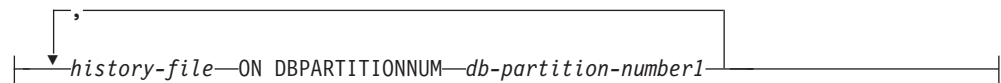

Command parameters

DATABASE *database-alias*

The alias of the database that is to be recovered.

USER *username*

The user name under which the database is to be recovered.

USING *password*

The password used to authenticate the user name. If the password is omitted, the user is prompted to enter it.

TO

isotime The point in time to which all committed transactions are to be recovered (including the transaction committed precisely at that time, as well as all transactions committed previously).

This value is specified as a time stamp, a 7-part character string that identifies a combined date and time. The format is *yyyy-mm-dd-hh.mm.ss.nnnnnn* (year, month, day, hour, minutes, seconds, microseconds). The time stamp in a backup image is based on the local time at which the backup operation started. The `CURRENT TIMEZONE` special register specifies the difference between UTC and local time at the application server. The difference is represented by a time duration (a decimal number in

which the first two digits represent the number of hours, the next two digits represent the number of minutes, and the last two digits represent the number of seconds). Subtracting CURRENT TIMEZONE from a local time converts that local time to UTC.

USING LOCAL TIME

Specifies the point in time to which to recover. This option allows the user to recover to a point in time that is the server's local time rather than UTC time. This is the default option.

Note:

1. If the user specifies a local time for recovery, all messages returned to the user will also be in local time. All times are converted on the server, and in partitioned database environments, on the catalog database partition.
2. The timestamp string is converted to UTC on the server, so the time is local to the server's time zone, not the client's. If the client is in one time zone and the server in another, the server's local time should be used. This is different from the local time option from the Control Center, which is local to the client.
3. If the timestamp string is close to the time change of the clock due to daylight saving time, it is important to know if the stop time is before or after the clock change, and specify it correctly.

USING UTC TIME

Specifies the point in time to which to recover.

END OF LOGS

Specifies that all committed transactions from all online archive log files listed in the database configuration parameter **logpath** are to be applied.

ON ALL DBPARTITIONNUMS

Specifies that transactions are to be rolled forward on all database partitions specified in the `db2nodes.cfg` file. This is the default if a database partition clause is not specified.

EXCEPT

Specifies that transactions are to be rolled forward on all database partitions specified in the `db2nodes.cfg` file, except those specified in the database partition list.

ON DBPARTITIONNUM | ON DBPARTITIONNUMS

Roll the database forward on a set of database partitions.

db-partition-number1

Specifies a database partition number in the database partition list.

TO *db-partition-number2*

Specifies the second database partition number, so that all database partitions from *db-partition-number1* up to and including *db-partition-number2* are included in the database partition list.

USING HISTORY FILE *history-file*

history-file **ON DBPARTITIONNUM**

In a partitioned database environment, allows a different history file

OVERFLOW LOG PATH *log-directory*

Specifies an alternate log path to be searched for archived logs during recovery. Use this parameter if log files were moved to a location other

than that specified by the **logpath** database configuration parameter. In a partitioned database environment, this is the (fully qualified) default overflow log path *for all database partitions*. A relative overflow log path can be specified for single-partition databases.

The OVERFLOW LOG PATH command parameter will overwrite the value (if any) of the database configuration parameter **overflowlogpath**.

COMPRLIB *lib-name*

Indicates the name of the library to be used to perform the decompression. The name must be a fully qualified path referring to a file on the server. If this parameter is not specified, DB2 will attempt to use the library stored in the image. If the backup was not compressed, the value of this parameter will be ignored. If the specified library cannot be loaded, the restore operation will fail.

COMPROPTS *options-string*

Describes a block of binary data that is passed to the initialization routine in the decompression library. The DB2 database system passes this string directly from the client to the server, so any issues of byte reversal or code page conversion are handled by the decompression library. If the first character of the data block is "@", the remainder of the data is interpreted by the DB2 database system as the name of a file residing on the server. The DB2 database system will then replace the contents of *string* with the contents of this file and pass the new value to the initialization routine instead. The maximum length for the string is 1 024 bytes.

RESTART

The RESTART keyword can be used if a prior RECOVER operation was interrupted or otherwise did not complete. Starting in V9.1, a subsequent RECOVER command will attempt to continue the previous RECOVER, if possible. Using the RESTART keyword forces RECOVER to start with a fresh restore and then rollforward to the PIT specified.

log-directory **ON DBPARTITIONNUM**

In a partitioned database environment, allows a different log path to override the default overflow log path for a specific database partition.

Examples

In a single-partition database environment, where the database being recovered currently exists, and the most recent version of the history file is available in the **dftdbpath**:

1. To use the latest backup image and rollforward to the end of logs using all default values:

```
RECOVER DB SAMPLE
```
2. To recover the database to a PIT, issue the following. The most recent image that can be used will be restored, and logs applied until the PIT is reached.

```
RECOVER DB SAMPLE TO 2001-12-31-04.00.00
```
3. To recover the database using a saved version of the history file, issue the following. For example, if the user needs to recover to an extremely old PIT which is no longer contained in the current history file, the user will have to provide a version of the history file from this time period. If the user has saved a history file from this time period, this version can be used to drive the recover.

```
RECOVER DB SAMPLE TO 1999-12-31-04.00.00  
USING HISTORY FILE (/home/user/old1999files/db2rhist.asc)
```

In a single-partition database environment, where the database being recovered does not exist, you must use the USING HISTORY FILE clause to point to a history file.

1. If you have not made any backups of the history file, so that the only version available is the copy in the backup image, the recommendation is to issue a RESTORE followed by a ROLLFORWARD. However, to use RECOVER, you would first have to extract the history file from the image to some location, for example /home/user/oldfiles/db2rhist.asc, and then issue this command. (This version of the history file does not contain any information about log files that are required for rollforward, so this history file is not useful for RECOVER.)

```
RECOVER DB SAMPLE TO END OF LOGS
USING HISTORY FILE (/home/user/fromimage/db2rhist.asc)
```

2. If you have been making periodic or frequent backup copies of the history, the USING HISTORY FILE clause should be used to point to this version of the history file. If the file is /home/user/myfiles/db2rhist.asc, issue the command:

```
RECOVER DB SAMPLE TO PIT
USING HISTORY FILE (/home/user/myfiles/db2rhist.asc)
```

(In this case, you can use any copy of the history file, not necessarily the latest, as long as it contains a backup taken before the point-in-time (PIT) requested.)

In a partitioned database environment, where the database exists on all database partitions, and the latest history file is available on **dftdbpath** on all database partitions:

1. To recover the database to a PIT on all nodes. DB2 will verify that the PIT is reachable on all nodes before starting any restore operations.

```
RECOVER DB SAMPLE TO 2001-12-31-04.00.00
```

2. To recover the database to this PIT on all nodes. DB2 will verify that the PIT is reachable on all nodes before starting any restore operations. The RECOVER operation on each node is identical to a single-partition RECOVER.

```
RECOVER DB SAMPLE TO END OF LOGS
```

3. Even though the most recent version of the history file is in the **dftdbpath**, you might want to use several specific history files. Unless otherwise specified, each database partition will use the history file found locally at /home/user/oldfiles/db2rhist.asc. The exceptions are nodes 2 and 4. Node 2 will use: /home/user/node2files/db2rhist.asc, and node 4 will use: /home/user/node4files/db2rhist.asc.

```
RECOVER DB SAMPLE TO 1999-12-31-04.00.00
USING HISTORY FILE (/home/user/oldfiles/db2rhist.asc,
/home/user/node2files/db2rhist.asc ON DBPARTITIONNUM 2,
/home/user/node4files/db2rhist.asc ON DBPARTITIONNUM 4)
```

4. It is possible to recover a subset of nodes instead of all nodes, however a PIT RECOVER can not be done in this case, the recover must be done to EOL.

```
RECOVER DB SAMPLE TO END OF LOGS ON DBPARTITIONNUMS(2 TO 4, 7, 9)
```

In a partitioned database environment, where the database does not exist:

1. If you have not made any backups of the history file, so that the only version available is the copy in the backup image, the recommendation is to issue a RESTORE followed by a ROLLFORWARD. However, to use RECOVER, you would first have to extract the history file from the image to some location, for example, /home/user/oldfiles/db2rhist.asc, and then issue this command.

(This version of the history file does not contain any information about log files that are required for rollforward, so this history file is not useful for the recover.)

```
RECOVER DB SAMPLE TO PIT
  USING HISTORY FILE (/home/user/fromimage/db2rhist.asc)
```

2. If you have been making periodic or frequent backup copies of the history, the USING HISTORY FILE clause should be used to point to this version of the history file. If the file is /home/user/myfiles/db2rhist.asc, you can issue the following command:

```
RECOVER DB SAMPLE TO END OF LOGS
  USING HISTORY FILE (/home/user/myfiles/db2rhist.asc)
```

Usage notes

- Recovering a database might require a load recovery using tape devices. If prompted for another tape, the user can respond with one of the following:
 - c** Continue. Continue using the device that generated the warning message (for example, when a new tape has been mounted).
 - d** Device terminate. Stop using the device that generated the warning message (for example, when there are no more tapes).
 - t** Terminate. Terminate all devices.
- If there is a failure during the restore portion of the recover operation, you can reissue the RECOVER DATABASE command. If the restore operation was successful, but there was an error during the rollforward operation, you can issue a ROLLFORWARD DATABASE command, since it is not necessary (and it is time-consuming) to redo the entire recover operation.
- In a partitioned database environment, if there is an error during the restore portion of the recover operation, it is possible that it is only an error on a single database partition. Instead of reissuing the RECOVER DATABASE command, which restores the database on all database partitions, it is more efficient to issue a RESTORE DATABASE command for the database partition that failed, followed by a ROLLFORWARD DATABASE command.

Chapter 98. REDISTRIBUTE DATABASE PARTITION GROUP

Redistributes data across the database partitions in a database partition group. The target distribution of data can be uniform (default) or user specified to meet specific system requirements.

The REDISTRIBUTE DATABASE PARTITION GROUP command redistributes data across all partitions in a database partition group. This affects all objects present in the database partition group and cannot be restricted to one object alone.

This command can only be issued from the catalog database partition. Use the LIST DATABASE DIRECTORY command to determine which database partition is the catalog database partition for each database.

Scope

This command affects all database partitions in the database partition group.

Authorization

One of the following authorities is required:

- SYSADM
- SYCTRL
- DBADM

In addition, one of the following groups of authorizations is also required:

- DELETE, INSERT, and SELECT privileges on all tables in the database partition group being redistributed
- DATAACCESS authority

Command syntax

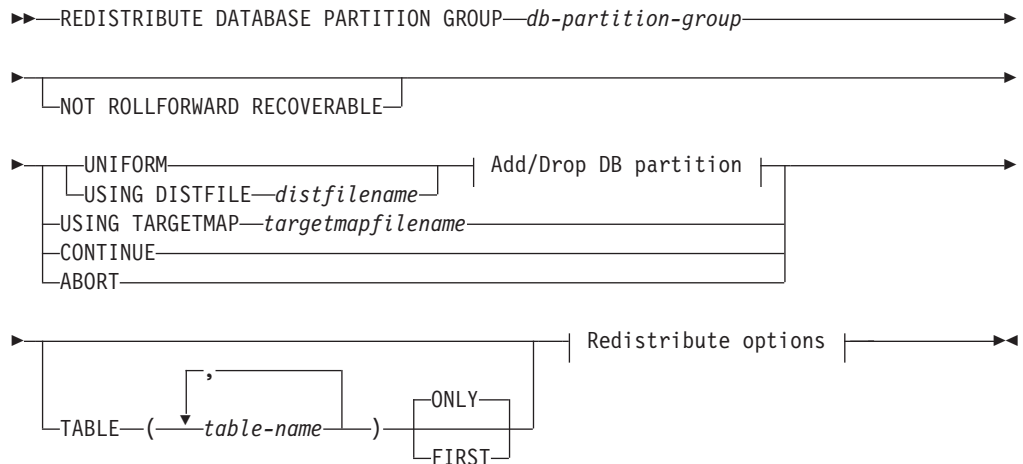

Add/Drop DB partition:

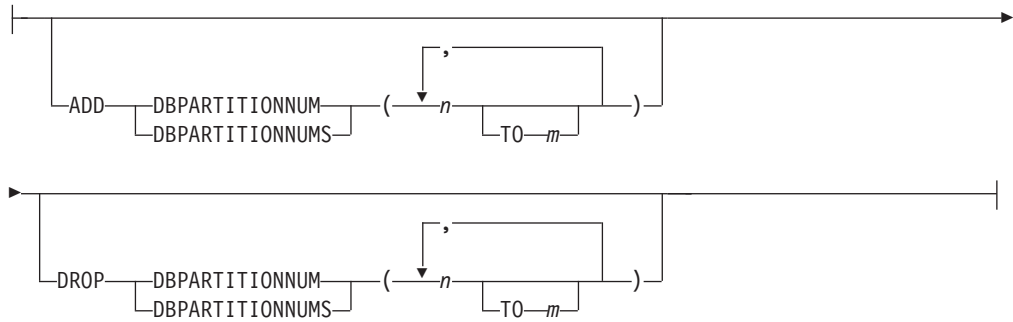

Redistribute options:

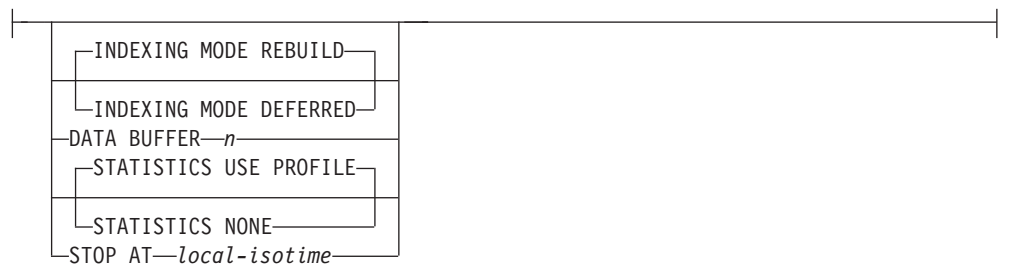

Command parameters

DATABASE PARTITION GROUP *db-partition-group*

The name of the database partition group. This one-part name identifies a database partition group described in the SYSCAT.DBPARTITIONGROUPS catalog table. The database partition group cannot currently be undergoing redistribution.

Note: Tables in the IBMCATGROUP and the IBMTEMPGROUP database partition groups cannot be redistributed.

NOT ROLLFORWARD RECOVERABLE

When this option is used, the REDISTRIBUTE DATABASE PARTITION GROUP command is not roll forward recoverable.

- Data is moved in bulk instead of by internal insert and delete operations. This reduces the number of times that a table must be scanned and accessed, which results in better performance.
- Log records are no longer required for each of the insert and delete operations. This means that you no longer need to manage large amounts of active log space and log archiving space in your system when performing data redistribution. This is particularly beneficial if, in the past, large active log space and storage requirements forced you to break a single data redistribution operation into multiple smaller redistribution tasks, which might have resulted in even more time required to complete the end-to-end data redistribution operation.
- When using the REDISTRIBUTE DATABASE PARTITION GROUP command with the NOT ROLLFORWARD RECOVERABLE option, the redistribute operation uses the INDEXING MODE DEFERRED option for

tables that contain XML columns. If a table does not contain an XML column, the redistribute operation uses the indexing mode specified when issuing the command.

When this option is *not* used, extensive logging of all row movement is performed such that the database can be recovered later in the event of any interruptions, errors, or other business need.

UNIFORM

Specifies that the data is uniformly distributed across hash partitions (that is, every hash partition is assumed to have the same number of rows), but the same number of hash partitions do not map to each database partition. After redistribution, all database partitions in the database partition group have approximately the same number of hash partitions.

USING DISTFILE *distfilename*

If the distribution of distribution key values is skewed, use this option to achieve a uniform redistribution of data across the database partitions of a database partition group.

Use the *distfilename* to indicate the current distribution of data across the 32 768 hash partitions.

Use row counts, byte volumes, or any other measure to indicate the amount of data represented by each hash partition. The utility reads the integer value associated with a partition as the weight of that partition. When a *distfilename* is specified, the utility generates a target distribution map that it uses to redistribute the data across the database partitions in the database partition group as uniformly as possible. After the redistribution, the weight of each database partition in the database partition group is approximately the same (the weight of a database partition is the sum of the weights of all hash partitions that map to that database partition).

For example, the input distribution file might contain entries as follows:

```
10223
1345
112000
0
100
...
```

In the example, hash partition 2 has a weight of 112000, and partition 3 (with a weight of 0) has no data mapping to it at all.

The *distfilename* should contain 32 768 positive integer values in character format. The sum of the values should be less than or equal to 4 294 967 295.

If the path for *distfilename* is not specified, the current directory is used.

USING TARGETMAP *targetmapfilename*

The file specified in *targetmapfilename* is used as the target distribution map. Data redistribution is done according to this file. If the path is not specified, the current directory is used.

If a database partition, included in the target map, is not in the database partition group, an error is returned. Issue ALTER DATABASE PARTITION GROUP ADD DBPARTITIONNUM statement before running REDISTRIBUTE DATABASE PARTITION GROUP command.

If a database partition, excluded from the target map, is in the database partition group, that database partition will not be included in the

partitioning. Such a database partition can be dropped using ALTER DATABASE PARTITION GROUP DROP DBPARTITIONNUM statement either before or after the REDISTRIBUTE DATABASE PARTITION GROUP command.

CONTINUE

Continues a previously failed or stopped REDISTRIBUTE DATABASE PARTITION GROUP operation. If none occurred, an error is returned.

ABORT

Aborts a previously failed or stopped REDISTRIBUTE DATABASE PARTITION GROUP operation. If none occurred, an error is returned.

ADD

DBPARTITIONNUM *n*

TO *m*

n or *n TO m* specifies a list or lists of database partition numbers which are to be added into the database partition group. Any specified partition must not already be defined in the database partition group (SQLSTATE 42728). This is equivalent to executing the ALTER DATABASE PARTITION GROUP statement with ADD DBPARTITIONNUM clause specified.

DBPARTITIONNUMS *n*

TO *m*

n or *n TO m* specifies a list or lists of database partition numbers which are to be added into the database partition group. Any specified partition must not already be defined in the database partition group (SQLSTATE 42728). This is equivalent to executing the ALTER DATABASE PARTITION GROUP statement with ADD DBPARTITIONNUM clause specified.

Note: When a database partition is added using this option, containers for table spaces are based on the containers of the corresponding table space on the lowest numbered existing partition in the database partition group. If this would result in a naming conflict among containers, which could happen if the new partitions are on the same physical machine as existing containers, this option should not be used. Instead, the ALTER DATABASE PARTITION GROUP statement should be used with the WITHOUT TABLESPACES option prior to issuing the REDISTRIBUTE DATABASE PARTITION GROUP command. Table space containers can then be created manually specifying appropriate names.

DROP

DBPARTITIONNUM *n*

TO *m*

n or *n TO m* specifies a list or lists of database partition numbers which are to be dropped from the database partition group. Any specified partition must already be defined in the database partition group (SQLSTATE 42729). This is equivalent to executing the ALTER DATABASE PARTITION GROUP statement with the DROP DBPARTITIONNUM clause specified.

DBPARTITIONNUMS *n*

TO *m*

n or *n* TO *m* specifies a list or lists of database partition numbers which are to be dropped from the database partition group. Any specified partition must already be defined in the database partition group (SQLSTATE 42729). This is equivalent to executing the ALTER DATABASE PARTITION GROUP statement with the DROP DBPARTITIONNUM clause specified.

TABLE *tablename*

Specifies a table order for redistribution processing.

ONLY If the table order is followed by the **ONLY** keyword (which is the default), then, only the specified tables will be redistributed. The remaining tables can be later processed by subsequent REDISTRIBUTE CONTINUE commands. This is the default.

FIRST If the table order is followed by the **FIRST** keyword, then, the specified tables will be redistributed with the given order and the remaining tables in the database partition group will be redistributed with random order.

INDEXING MODE

This parameter specifies how indexes are maintained during redistribution when the NOT ROLLFORWARD RECOVERABLE option is specified. Valid values are:

REBUILD

Indexes will be rebuilt from scratch. Indexes do not have to be valid to use this option. As a result of using this option, index pages will be clustered together on disk.

DEFERRED

Redistribute will not attempt to maintain any indexes. Indexes will be marked as needing a refresh. The first access to such indexes may force a rebuild, or indexes may be rebuilt when the database is restarted.

Note: For non-MDC tables, if there are invalid indexes on the tables, the REDISTRIBUTE DATABASE PARTITION GROUP command automatically rebuilds them if you do not specify **INDEXING MODE DEFERRED**. For an MDC table, even if you specify **INDEXING MODE DEFERRED**, a composite index that is invalid is rebuilt before table redistribution begins because the utility needs the composite index to process an MDC table.

DATA BUFFER *n*

Specifies the number of 4 KB pages to use as buffered space for transferring data within the utility. If the value specified is lower than the minimum supported value, the minimum value is used and no warning is returned. This memory is allocated directly from the utility heap, whose size can be modified through the **util_heap_sz** database configuration parameter. If a value is not specified, an intelligent default is calculated by the utility at runtime at the beginning of processing each table. Specifically, the default is to use 50% of the memory available in the utility heap at the time redistribution of the table begins and to take into account various table properties as well.

STOP AT *local-isotime*

When this option is specified, before beginning data redistribution for each table, the *local-isotime* is compared with the current local timestamp. If the specified *local-isotime* is equal to or earlier than the current local timestamp, the utility stops with a warning message. Data redistribution processing of tables in progress at the stop time will complete without interruption. No new data redistribution processing of tables begins. The unprocessed tables can be redistributed using the **CONTINUE** option. This *local-isotime* value is specified as a time stamp, a 7-part character string that identifies a combined date and time. The format is *yyyy-mm-dd-hh.mm.ss.nnnnnn* (year, month, day, hour, minutes, seconds, microseconds) expressed in local time.

STATISTICS

This option specifies that the utility should collect statistics for the tables that have a statistics profile. Specifying this option is more efficient than separately issuing the RUNSTATS command after the data redistribution is completed.

USE PROFILE

Statistics will be collected for the tables with a statistics profile. For tables without a statistics profile, nothing will be done. This is the default.

NONE

Statistics will not be collected for tables.

Examples: Redistribute steps

You may want to add or drop node from node group. Following is the step for adding new node to a node group and redistribute the data. Added database partition is not in the distribution map, but the containers for the table spaces in the database partition group have been created; the database partition is added to the distribution map when a redistribute database partition group operation has completed successfully.

1. Identify the nodegroups that will require redistribution. In this document, the node group that needs to be redistributed is “sampleNodegrp”.
2. Identify objects that should be disabled or removed before redistribute .
 - a. Replicate MQTs: This type of MQT is not supported as part of the REDISTRIBUTE utility. They need to be dropped before running redistribute and recreated afterward.

```
SELECT tabschema, tablename
FROM syscat.tables
WHERE partition_mode = 'R'
```

- b. Write-to-table event monitors: You should disable any automatically activated write-to-table event monitors that have a table that resides in the database partition group to be redistributed.

```
SELECT distinct evmonname
FROM syscat.eventtables E
JOIN syscat.tables T on T.tabname = E.tabname
AND T.tabschema = E.tabschema
JOIN syscat.tablespace S on S.tbpace = T.tbpace
AND S.ngname = 'sampleNodegrp'
```

- c. Explain tables: It is recommended to create the explain tables in a single partition nodegroup. However, if they are defined in a nodegroup that requires redistribution, you may consider dropping them before the redistribute and redefining them once redistribute is complete, if the data generated to date does not need to be maintained.

- d. Table access mode and load state: Ensure that all tables in the node groups to be redistributed are in full access mode and have no load pending or load in progress state.

```
SELECT distinct trim(T.creator) || '\.' || trim(T.name)
AS name, T.access_mode, A.load_status
FROM sysibm.systables T, sysibm.sysnodegroups N, sysibmadm.admintabinfo A
WHERE T.pmap_id = N.pmap_id
AND A.tabschema = T.creator
AND A.tabname = T.name
AND N.name = 'sampleNodegrp'
AND (T.access_mode <> 'F' or A.load_status is not null)
```

- e. Statistics profiles: Table statistics can be updated as part of the redistribution process if a statistics profile is defined for the table. Having the REDISTRIBUTE utility update a table's statistics reduces I/O as all the data is scanned for the redistribute and no additional scan of the data is needed for RUNSTATS.

```
RUNSTATS on table schema.table
USE PROFILE runstats_profile
SET PROFILE ONLY
```

3. Review the database configuration. **util_heap_sz** is critical to the data movement processing between database partitions – allocate as much memory as possible to **util_heap_sz** for the duration of the redistribution. Sufficient **sortheap** is required, if index rebuild is done as part of the redistribution. Increase **util_heap_sz** and **sortheap** as necessary to improve redistribute performance.
4. Retrieve the database configuration settings to be used for the new database partitions. When adding database partitions, a default database configuration is used. As a result, it's important to update the database configuration on the new nodes before the REDISTRIBUTE command is issued to ensure that the configuration is balanced across the entire warehouse.

```
SELECT name,
CASE WHEN deferred_value_flags = 'AUTOMATIC'
THEN deferred_value_flags
ELSE substr(deferred_value,1,20)
END
AS deferred_value
FROM sysibmadm.dbcfg
WHERE dbpartitionnum = existing-node
AND deferred_value != ''
AND name NOT IN ('hadr_local_host','hadr_local_svc','hadr_peer_window',
'hadr_remote_host','hadr_remote_inst','hadr_remote_svc',
'hadr_syncmode','hadr_timeout','backup_pending','codepage',
'codeset','collate_info','country','database_consistent',
'database_level','hadr_db_role','log_retain_status',
'loghead','logpath','multipage_alloc','numsegs','pagesize',
'release','restore_pending','restrict_access',
'rollfwd_pending','territory','user_exit_status',
'number_compat','varchar2_compat','database_memory')
```

5. Backup the database (or the table spaces in nodegroups that will be redistributed), before starting the redistribution process to ensure a recent recovery point.
6. Define the new data BCUs in DB2 by updating the db2nodes.cfg file and adding the new data BCU database partition specifications and define the new database partitions to DB2 using the ADD NODE WITHOUT TABLESPACES command.

```
db2start nodenum x export DB2NODE=x
db2 add node without tablespaces
db2stop nodenum x
```

Note: If it is not the first logical port on the data BCU, then execute a start and stop of the first logical port number before and after the above sequence of commands for subsequent logical ports.

7. Define system temporary table space containers on the newly defined database partitions.

```
ALTER TABLESPACE tablespace_name
  ADD container_information
  ON dbpartitionnums (x to y)
```

8. Add the new logical database partitions to the database partition groups that span the data BCUs.

```
ALTER DATABASE PARTITION GROUP partition_group_name
  ADD dbpartitionnums (x to y)
  WITHOUT TABLESPACES
```

9. Define permanent data table space containers on the newly defined database partitions.

```
ALTER TABLESPACE tablespace_name
  ADD container_information
  ON dbpartitionnums (x to y)
```

10. Apply the database configuration settings retrieved in step 4 to the new database partitions (or issue a single UPDATE DB CFG command against all database partitions using the new DB2 9.5 single view of configuration support).

11. Capture the definition of and then drop any replicated MQTs existing in the database partition groups to be redistributed.

```
db2look -d dbname -e -z
  schema -t replicated_MQT_table_names
  -o repMQTs.clp
```

12. Disable any write-to-table event monitors that exist in the database partition groups to be redistributed.

```
SET EVENT MONITOR monitor_name STATE 0
```

13. Run the REDISTRIBUTE utility to redistribute uniformly across all database partitions. Following shows the simple redistribute command:

```
REDISTRIBUTE DATABASE PARTITION GROUP sampleNodegrp
  NOT ROLLFORWARD RECOVERABLE uniform;
```

User also should consider specifying a table list as input to the REDISTRIBUTE command to enforce the order that the tables will be processed. The REDISTRIBUTE utility will move the data (compressed and compacted). Optionally, indexes will be rebuilt and statistics updated if statistics profiles are defined. Therefore instead of previous command, the following script can be run:

```
REDISTRIBUTE DATABASE PARTITION GROUP sampleNodegrp
  NOT ROLLFORWARD RECOVERABLE uniform
  TABLE (tab1, tab2,...) FIRST;
```

Consequences of using the NOT ROLLFORWARD RECOVERABLE option

When the REDISTRIBUTE DATABASE PARTITION GROUP command is issued and the NOT ROLLFORWARD RECOVERABLE option is specified, a minimal logging strategy is used that minimizes the writing of log records for each moved row. This type of logging is important for the usability of the redistribute operation since an approach that fully logs all data movement could, for large systems, require an impractical amount of active and permanent log space and would generally have poorer performance characteristics. It is important, however, for users to be aware that as a result of this minimal logging model, the

REDISTRIBUTE DATABASE PARTITION GROUP command is *not* rollforward recoverable. This means that any operation that results in the database rolling forward through a redistribute operation results in all tables touched by the redistribution operation being left in the UNAVAILABLE state. Such tables can only be dropped, which means there is no way to recover the data in these tables. This is why, for recoverable databases, the REDISTRIBUTE DATABASE PARTITION GROUP utility when issued with the NOT ROLLFORWARD RECOVERABLE option puts all table spaces it touches into the BACKUP PENDING state, forcing the user to backup all redistributed table spaces at the end of a successful redistribute operation. With a backup taken after the redistribution operation, the user should not have a need to rollforward through the redistribute operation itself.

There is one very important consequence of the redistribute utility's lack of rollforward recoverability of which the user should be aware: If the user chooses to allow updates to be made against tables in the database (even tables outside the database partition group being redistributed) while the redistribute operation is running, including the period at the end of redistribute where the table spaces touched by redistribute are being backed up by the user, such updates can be lost in the event of a serious failure, for example, a database container is destroyed. The reason that such updates can be lost is that the redistribute operation is not rollforward recoverable. If it is necessary to restore the database from a backup taken prior to the redistribution operation, then it will not be possible to rollforward through the logs in order to replay the updates that were made during the redistribution operation without also rolling forward through the redistribute which, as was described above, leaves the redistributed tables in the UNAVAILABLE state. Thus, the only thing that can be done in this situation is to restore the database from the backup taken prior to redistribute without rolling forward. Then the redistribute operation can be performed again. Unfortunately, all the updates that occurred during the original redistribute operation are lost.

The importance of this point cannot be overemphasized. In order to be certain that there will be no lost updates during a redistribution operation, one of the following must be true:

- The user avoids making updates during the operation of the REDISTRIBUTE DATABASE PARTITION GROUP command, including the period after the command finishes where the affected table spaces are being backed up.
- Updates that are applied during the redistribute operation come from a repeatable source, meaning that they can be applied again at any time. For example, if the source of updates is data that is stored in a file and the updates are applied during batch processing, then clearly even in the event of a failure requiring a database restore, the updates would not be lost since they could simply be applied again at any time.

With respect to allowing updates to the database during the redistribution operation, the user must decide whether such updates are appropriate or not for their scenario based on whether or not the updates can be repeated after a database restore, if necessary.

Note: Not every failure during operation of the REDISTRIBUTE DATABASE PARTITION GROUP command results in this problem. In fact, most do not. The REDISTRIBUTE DATABASE PARTITION GROUP command is fully restartable, meaning that if the utility fails in the middle of its work, it can be easily continued

or aborted with the **CONTINUE** or **ABORT** options. The failures mentioned above are failures that require the user to restore from the backup taken prior to the redistribute operation.

Usage notes

- When the **NOT ROLLFORWARD RECOVERABLE** option is specified and the database is a recoverable database, the first time the utility accesses a table space, it is put into the **BACKUP PENDING** state. All the tables in that table space will become read-only until the table space is backed-up, which can only be done when all tables in the table space have finished being redistributed.
- When a redistribution operation is running, it produces an event log file containing general information about the redistribution operation and information such as the starting and ending time of each table processed. This event log file is written to:
 - The `homeinst/sqllib/redist` directory on Linux and UNIX systems, using the following format for subdirectories and file name: *database-name.database-partition-group-name.timestamp.log*.
 - The `DB2INSTPROF\instance\redist` directory on Windows operating systems (where **DB2INSTPROF** is the value of the **DB2INSTPROF** registry variable), using the following format for subdirectories and file name: *database-name.database-partition-group-name.timestamp.log*.
 - The time stamp value is the time when the command was issued.

For more information about the redistribute event log, refer to the “Redistribution event log file” topic.

- This utility performs intermittent COMMITs during processing.
- All packages having a dependency on a table that has undergone redistribution are invalidated. It is recommended to explicitly rebind such packages after the redistribute database partition group operation has completed. Explicit rebinding eliminates the initial delay in the execution of the first SQL request for the invalid package. The redistribute message file contains a list of all the tables that have undergone redistribution.
- By default, the redistribute utility will update the statistics for those tables that have a statistics profile. For the tables without a statistics profile, it is recommended that you separately update the table and index statistics for these tables by calling the `db2Runstats` API or by issuing the `RUNSTATS` command after the redistribute operation has completed.
- Database partition groups containing replicated materialized query tables or tables defined with `DATA CAPTURE CHANGES` cannot be redistributed.
- Redistribution is not allowed if there are user temporary table spaces with existing declared temporary tables or created temporary tables in the database partition group.
- Options such as **INDEXING MODE** are ignored on tables, on which they do not apply, without warning. For example, **INDEXING MODE** will be ignored on tables without indexes.
- Before starting a redistribute operation, ensure there are no tables in the Load Pending state. Table states can be checked by using the `LOAD QUERY` command.
- The `REDISTRIBUTE DATABASE PARTITION GROUP` command might fail (SQLSTATE 55071) if an add database partition server request is either pending or in progress. This command might also fail (SQLSTATE 55077) if a new database partition server is added online to the instance and not all applications are aware of the new database partition server.

Compatibilities

Tables containing XML columns that use the DB2 Version 9.5 or earlier XML record format cannot be redistributed. Use the `ADMIN_MOVE_TABLE` stored procedure to migrate the table to the new format.

For compatibility with versions earlier than Version 8:

- The keyword **NODEGROUP** can be substituted for **DATABASE PARTITION GROUP**.

Chapter 99. REFRESH LDAP

Refreshes the cache on a local machine with updated information when the information in Lightweight Directory Access Protocol (LDAP) has been changed.

Authorization

None

Required connection

None

Command syntax

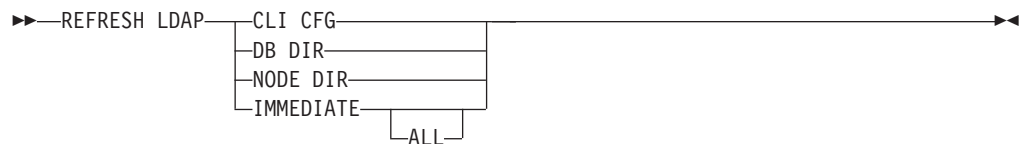

Command parameters

CLI CFG

Specifies that the CLI configuration is to be refreshed. This parameter is not supported on AIX or the Solaris operating system.

DB DIR

Specifies that the database directory is to be refreshed.

NODE DIR

Specifies that the node directory is to be refreshed.

IMMEDIATE

Specifies that the local database and node directories are to be refreshed immediately.

ALL Specifies that all database and node entries contained within the LDAP server are to be added into the local database and node directories.

Usage notes

If the object in LDAP is removed during refresh, the corresponding LDAP entry on the local machine is also removed. If the information in LDAP is changed, the corresponding LDAP entry is modified accordingly. If the DB2CLI.INI file is manually updated, the REFRESH LDAP CLI CFG command must be run to update the cache for the current user.

The REFRESH LDAP DB DIR and REFRESH LDAP NODE DIR commands remove the LDAP database or node entries found in the local database or node directories. The database or node entries will be added to the local database or node directories again when the user connects to a database or attaches to an instance found in LDAP, and DB2LDAPCACHE is either not set or set to YES.

The REFRESH LDAP IMMEDIATE command updates entries from the local database and node directories using the latest information found in LDAP. This update occurs immediately and regardless if DB2LDAPCACHE is enabled or not. Only database and node entries that originated from LDAP will be updated. Entries that were added manually remain unchanged.

The REFRESH LDAP IMMEDIATE ALL command immediately populates the local database and node directories with all the information found in LDAP. If an entry found in LDAP matches an existing local entry, the command will update the entry. This update will only occur if the local entry originated from LDAP. Entries that were added manually remain unchanged. This update is performed regardless if DB2LDAPCACHE is enabled or not.

When LDAP is disabled, performing either REFRESH LDAP IMMEDIATE or REFRESH LDAP IMMEDIATE ALL will result in SQLCODE -3279 (The command did not complete successfully because LDAP is disabled).

Chapter 100. REGISTER

Registers the DB2 server in the network directory server.

Authorization

None

Required connection

None

Command syntax

```
➤ REGISTER [DB2 SERVER] [IN] [ADMIN] | LDAP path | ➤
```

LDAP path:

```
| LDAP [NODE] nodename | ➤
  | AS |
➤ PROTOCOL [TCPIP] [HOSTNAME hostname] [SVCENAME svcename] [SECURITY SOCKS] | ➤
  | [TCPIP4] [HOSTNAME hostname] [SVCENAME svcename] [SECURITY SOCKS] |
  | [TCPIP6] [HOSTNAME hostname] [SVCENAME svcename] |
  | [NPIPE] |
➤ [REMOTE computer-name] [INSTANCE instance] [NODETYPE [SERVER] [MPP] [DCS]] [OSTYPE ostype] | ➤
➤ [WITH "comment-string"] [USER username] [PASSWORD password] |
```

Command parameters

IN Specifies the network directory server on which to register the DB2 server. The valid value is: LDAP for an LDAP (Lightweight Directory Access Protocol) directory server.

ADMIN

Specifies that an administration server node is to be registered.

NODE | AS *nodename*

Specify a short name to represent the DB2 server in LDAP. A node entry will be cataloged in LDAP using this node name. The client can attach to the server using this node name. The protocol associated with this LDAP node entry is specified through the PROTOCOL parameter.

PROTOCOL

Specifies the protocol type associated with the LDAP node entry. Since the database server can support more than one protocol type, this value specifies the protocol type used by the client applications. The DB2 server must be registered once per protocol. Valid values are: TCPIP, TCPIP4,

TCPIP6, and NPIPE. Specify NPIPE to use Windows Named Pipes. NPIPE is only supported on Windows operating systems.

HOSTNAME *hostname*

Specifies the TCP/IP host name (or IP address). IP address can be an IPv4 or IPv6 address when using protocol, TCPIP. IP address must be an IPv4 address when using protocol, TCPIP4. IP address must be an IPv6 address when using protocol, TCPIP6.

SVCENAME *svcename*

Specifies the TCP/IP service name or port number.

SECURITY SOCKS

Specifies that TCP/IP SOCKS is to be used. This parameter is only supported with IPv4. When protocol TCPIP is specified, the underlying protocol used will be IPv4.

REMOTE *computer-name*

Specifies the computer name of the machine on which the DB2 server resides. Specify this parameter only if registering a remote DB2 server in LDAP. The value must be the same as the value specified when adding the server machine to LDAP. For Windows operating systems, this is the computer name. For UNIX based systems, this is the TCP/IP host name.

INSTANCE *instance*

Specifies the instance name of the DB2 server. The instance name must be specified for a remote instance (that is, when a value for the REMOTE parameter has been specified).

NODETYPE

Specifies the node type for the database server. Valid values are:

SERVER

Specify the SERVER node type for a DB2 Enterprise Server Edition. This is the default.

MPP Specify the MPP node type for a DB2 Enterprise Server Edition - Extended (partitioned database) server.

DCS Specify the DCS node type when registering a host database server.

OSTYPE *ostype*

Specifies the operating system type of the server machine. Valid values are: AIX, NT, HPUX, SUN, MVS, OS400, VM, VSE and LINUX. If an operating system type is not specified, the local operating system type will be used for a local server and no operating system type will be used for a remote server.

WITH *"comment-string"*

Describes the DB2 server. Any comment that helps to describe the server registered in the network directory can be entered. Maximum length is 30 characters. A carriage return or a line feed character is not permitted. The comment text must be enclosed by double quotation marks.

Usage notes

Register the DB2 server once for each protocol that the server supports.

The REGISTER command should be issued once for each DB2 server instance to publish the server in the directory server. If the communication parameter fields are reconfigured, or the server network address changes, update the DB2 server on the network directory server.

To update the DB2 server in LDAP, use the UPDATE LDAP NODE command after the changes have been made.

If any protocol configuration parameter is specified when registering a DB2 server locally, it will override the value specified in the database manager configuration file.

If the REGISTER command is used to register a local DB2 instance in LDAP, and one or both of NODETYPE and OSTYPE are specified, they will be replaced with the values retrieved from the local system. If the REGISTER command is used to register a remote DB2 instance in LDAP, and one or both of NODETYPE and OSTYPE are not specified, the default value of SERVER and Unknown will be used, respectively.

If the REGISTER command is used to register a remote DB2 server in LDAP, the computer name and the instance name of the remote server must be specified along with the communication protocol for the remote server.

When registering a host database server, a value of DCS must be specified for the NODETYPE parameter.

Chapter 101. REGISTER XMLSCHEMA

Registers an XML schema with the XML schema repository (XSR).

Authorization

One of the following:

- *dbadm*
- IMPLICIT_SCHEMA database authority if the SQL schema does not exist
- CREATEIN privilege if the SQL schema exists

Required connection

Database

Command syntax

```
➤ REGISTER XMLSCHEMA schema-URI FROM content-URI
➤ [WITH properties-URI] [AS relational-identifier]
➤ [xml-document-subclause]
➤ [COMPLETE [WITH schema-properties-URI] [ENABLE DECOMPOSITION]]
```

xml-document-subclause:

```
| ( [ADD document-URI FROM content-URI [WITH properties-URI]] ) |
```

Command parameters

schema-URI

Specifies the URI, as referenced by XML instance documents, of the XML schema being registered.

FROM *content-URI*

Specifies the URI where the XML schema document is located. Only a local file specified by a file scheme URI is supported.

WITH *properties-URI*

Specifies the URI of a properties document for the XML schema. Only a local file specified by a file scheme URI is supported.

AS *relational-identifier*

Specifies a name that can be used to refer to the XML schema being registered. The relational name can be specified as a two-part SQL identifier, consisting of the SQL schema and the XML schema name, having the following format: SQLschema.name. The default relational schema, as

defined in the CURRENT SCHEMA special register, is used if no schema is specified. If no name is provided, a unique value is generated.

COMPLETE

Indicates that there are no more XML schema documents to be added. If specified, the schema is validated and marked as usable if no errors are found.

WITH *schema-properties-URI*

Specifies the URI of a properties document for the XML schema. Only a local file specified by a file scheme URI is supported.

ENABLE DECOMPOSITION

Specifies that this schema is to be used for decomposing XML documents.

ADD *document-URI*

Specifies the URI of an XML schema document to be added to this schema, as the document would be referenced from another XML document.

FROM *content-URI*

Specifies the URI where the XML schema document is located. Only a local file specified by a file scheme URI is supported.

WITH *properties-URI*

Specifies the URI of a properties document for the XML schema. Only a local file specified by a file scheme URI is supported.

Examples

```
REGISTER XMLSCHEMA 'http://myPOschema/PO.xsd'  
FROM 'file:///c:/TEMP/PO.xsd'  
WITH 'file:///c:/TEMP/schemaProp.xml'  
AS user1.POschema
```

Usage notes

- Before an XML schema document can be referenced and be available for validation and annotation, it must first be registered with the XSR. This command performs the first step of the XML schema registration process, by registering the primary XML schema document. The final step of the XML schema registration process requires that the COMPLETE XMLSCHEMA command run successfully for the XML schema. Alternatively, if there are no other XML schema documents to be included, issue the REGISTER XMLSCHEMA command with the COMPLETE keyword to complete registration in one step.
- When registering an XML schema in the database, a larger application heap (APPLHEAPSZ) may be required depending on the size of the XML schema. The recommended size is 1024 but larger schemas will require additional memory.

Chapter 102. REGISTER XSROBJECT

Registers an XML object in the database catalogs. Supported objects are DTDs and external entities.

Authorization

One of the following:

- *dbadm*
- IMPLICIT_SCHEMA database authority if the SQL schema does not exist
- CREATEIN privilege if the SQL schema exists

Required connection

Database

Command syntax

```
➤ REGISTER XSROBJECT system-ID [PUBLIC public-ID] FROM content-URI
➤ [AS relational-identifier] [DTD | EXTERNAL ENTITY]
```

Command parameters

system-ID

Specifies the system ID that is specified in the XML object declaration.

PUBLIC *public-ID*

Specifies an optional PUBLIC ID in the XML object declaration.

FROM *content-URI*

Specifies the URI where the content of an XML schema document is located. Only a local file specified by a file scheme URI is supported.

AS *relational-identifier*

Specifies a name that can be used to refer to the XML object being registered. The relational name can be specified as a two-part SQL identifier consisting of the relational schema and name separated by a period, for example "JOHNDOE.EMPLOYEEEDTD". If no relational schema is specified, the default relational schema defined in the special register CURRENT_SCHEMA is used. If no name is specified, one is generated automatically.

DTD Specifies that the object being registered is a Data Type Definition document (DTD).

EXTERNAL ENTITY

Specifies that the object being registered is an external entity.

Examples

1. Given this sample XML document which references an external entity:

```

<?xml version="1.0" standalone="no" ?>
<!DOCTYPE copyright [
  <!ELEMENT copyright (#PCDATA)>
]
>
<copyright>c</copyright>

```

Before this document can be successfully inserted into an XML column, the external entity needs to be registered. The following command registers an entity where the entity content is stored locally in C:\TEMP:

```

REGISTER XSROBJECT 'http://www.xmlwriter.net/copyright.xml'
  FROM 'c:\temp\copyright.xml' EXTERNAL ENTITY

```

2. Given this XML document fragment which references a DTD:

```

<!--inform the XML processor
  that an external DTD is referenced-->
<?xml version="1.0" standalone="no" ?>

<!--define the location of the
  external DTD using a relative URL address-->
<!DOCTYPE document SYSTEM "http://www.xmlwriter.net/subjects.dtd">

<document>
  <title>Subjects available in Mechanical Engineering.</title>
  <subjectID>2.303</subjectID>
  <subjectname>Fluid Mechanics</subjectname>
  ...

```

Before this document can be successfully inserted into an XML column, the DTD needs to be registered. The following command registers a DTD where the DTD definition is stored locally in C:\TEMP and the relational identifier to be associated with the DTD is "TEST.SUBJECTS":

```

REGISTER XSROBJECT 'http://www.xmlwriter.net/subjects.dtd'
  FROM 'file:///c:/temp/subjects.dtd' AS TEST.SUBJECTS DTD

```

3. Given this sample XML document which references a public external entity:

```

<?xml version="1.0" standalone="no" ?>
<!DOCTYPE copyright [
  <!ELEMENT copyright (#PCDATA)>
]
>
<copyright>c</copyright>

```

Before this document can be successfully inserted into an XML column, the public external entity needs to be registered. The following command registers an entity where the entity content is stored locally in C:\TEMP:

```

REGISTER XSROBJECT 'http://www.w3.org/xmlspec/copyright.xml'
  PUBLIC '-//W3C//TEXT copyright//EN' FROM 'file:///c:/temp/copyright.xml'
  EXTERNAL ENTITY

```

Chapter 103. REORG INDEXES/TABLE

Reorganizes an index or a table

You can reorganize all indexes defined on a table by rebuilding the index data into unfragmented, physically contiguous pages. Alternatively, you have the option of reorganizing specific indexes on a range partitioned table.

If you specify the CLEANUP ONLY option of the index clause, cleanup is performed without rebuilding the indexes. This command cannot be used against indexes on declared temporary tables or created temporary tables (SQLSTATE 42995).

The table option reorganizes a table by reconstructing the rows to eliminate fragmented data, and by compacting information.

Scope

This command affects all database partitions in the database partition group.

Authorization

One of the following:

- *sysadm*
- *sysctrl*
- *sysmaint*
- *dbadm*
- *sqladm*
- CONTROL privilege on the table.

Required connection

Database

Command syntax

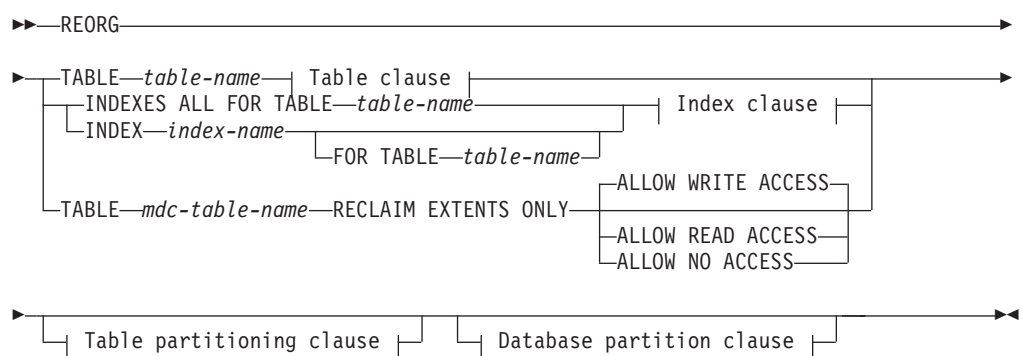
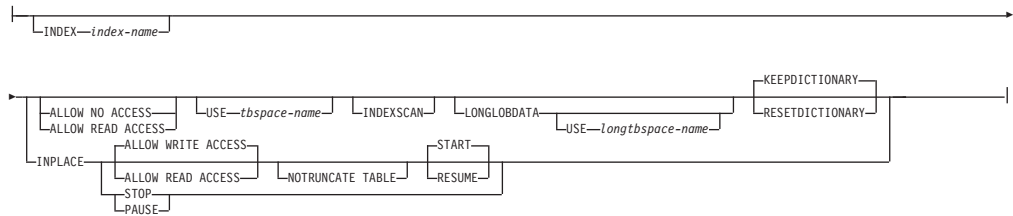

Table clause:



Index clause:

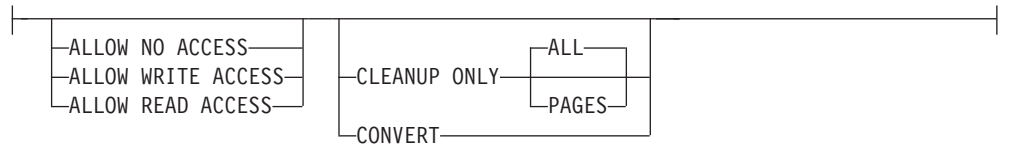
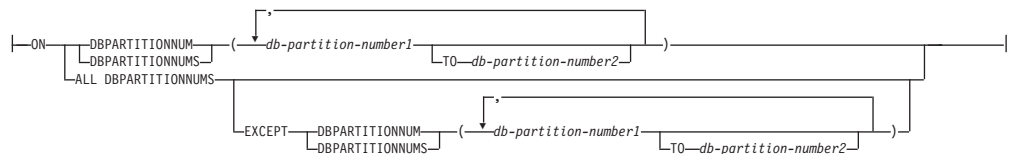

Table partitioning clause:



Database partition clause:



Command parameters

INDEXES ALL FOR TABLE *table-name*

Specifies the table whose indexes are to be reorganized. The table can be in a local or a remote database.

INDEX *index-name*

Specifies an individual index to be reorganized on a partitioned table. Reorganization of individual indexes are *only* supported for nonpartitioned indexes on a partitioned table. This parameter is not supported for block indexes.

FOR TABLE *table-name*

Specifies the table name location of the individual index being reorganized on a partitioned table. This parameter is optional, given that index names are unique across the database.

For REORG INDEXES when the ON DATA PARTITION option is specified, the access clause only applies to the named partition. Users can read from and write to the rest of the table while the indexes on the specified partition are being reorganized. This situation also applies to the default access levels.

ALLOW NO ACCESS

For REORG INDEX and REORG INDEXES, specifies that no other users can access the table or data partition while the indexes are being reorganized.

ALLOW READ ACCESS

For REORG INDEX and REORG INDEXES, specifies that other users can have read-only access to the table or data partition while the indexes are being reorganized. This access level is not supported for REORG INDEXES of a partitioned table unless the CLEANUP ONLY option or the ON DATA PARTITION option is specified.

ALLOW WRITE ACCESS

For REORG INDEX and REORG INDEXES, specifies that other users can read from and write to the table or data partition while the indexes are being reorganized.

This access level is not supported for multidimensional clustering (MDC) tables or extended indexes unless the CLEANUP ONLY option is specified. In addition, this access level is not supported for partitioned tables when the REORG INDEXES command is used unless the CLEANUP ONLY option or the ON DATA PARTITION option is specified.

When ACCESS mode is not specified, it is selected for the table or data partition in the following way:

Table 30. Default table access chosen based on the command, table type and additional parameters specified for the index clause:

Command	Table type	Table partitioning clause	Additional parameters specified for index clause	Default access mode
REORG INDEXES	Nonpartitioned table	Not applicable	Any	ALLOW READ ACCESS
REORG INDEX	Partitioned table	Not applicable	Any	ALLOW READ ACCESS
REORG INDEXES	Partitioned table	None	None specified	ALLOW NO ACCESS
REORG INDEXES	Partitioned table	ON DATA PARTITION	None specified	ALLOW READ ACCESS
REORG INDEXES	Partitioned table	With or without the ON DATA PARTITION clause	CLEANUP ONLY specified	ALLOW READ ACCESS

CLEANUP ONLY

When CLEANUP ONLY is requested, a cleanup rather than a full reorganization will be done. The indexes will not be rebuilt and any pages freed up will be available for reuse by indexes defined on this table only.

The CLEANUP ONLY PAGES option will search for and free committed pseudo empty pages. A committed pseudo empty page is one where all the keys on the page are marked as deleted and all these deletions are known to be committed. The number of pseudo empty pages in an indexes can be determined by running

RUNSTATS and looking at the NUM EMPTY LEAFs column in SYSCAT.INDEXES. The PAGES option will clean the NUM EMPTY LEAFs if they are determined to be committed.

The CLEANUP ONLY ALL option will free committed pseudo empty pages, as well as remove committed pseudo deleted keys from pages that are not pseudo empty. This option will also try to merge adjacent leaf pages if doing so will result in a merged leaf page that has at least PCTFREE free space on the merged leaf page, where PCTFREE is the percent free space defined for the index at index creation time. The default PCTFREE is ten percent. If two pages can be merged, one of the pages will be freed. The number of pseudo deleted keys in an index, excluding those on pseudo empty pages, can be determined by running RUNSTATS and then selecting the NUMRIDS DELETED from SYSCAT.INDEXES. The ALL option will clean the NUMRIDS DELETED and the NUM EMPTY LEAFs if they are determined to be committed.

ALL Specifies that indexes should be cleaned up by removing committed pseudo deleted keys and committed pseudo empty pages.

PAGES

Specifies that committed pseudo empty pages should be removed from the index tree. This will not clean up pseudo deleted keys on pages that are not pseudo empty. Since it is only checking the pseudo empty leaf pages, it is considerably faster than using the ALL option in most cases.

CONVERT

Converts type-1 indexes to type-2 index. If the index is already type 2, this option has no effect.

In Version 9.7, type-1 indexes are discontinued and all indexes that are created are type-2 indexes. As a result, the CONVERT option is deprecated.

All indexes created prior to Version 8 are type-1 indexes. Prior to Version 9.7, all indexes created by Version 8 and later are type-2 indexes, except when you create an index on a table that already has a type-1 index. In this case, the new index was also of type 1. This is no longer the case in Version 9.7 because all indexes created are type 2.

Use the ALLOW READ ACCESS or ALLOW WRITE ACCESS option to allow other transactions either read-only or read-write access to the table while the indexes are being reorganized. While ALLOW READ ACCESS and ALLOW WRITE ACCESS allow access to the table, during the period in which the reorganized copies of the indexes are made available, no access to the table is allowed.

TABLE *mdc-table-name* RECLAIM EXTENTS ONLY

Specifies the multidimensional clustering (MDC) table to reorganize to reclaim extents that are not being used. The name or alias in the form: *schema.table-name* can be used. The *schema* is the user name under which the table was created. If you omit the schema name, the default schema is assumed.

For REORG TABLE RECLAIM EXTENTS ONLY when the ON DATA PARTITION option is specified, the access clause only applies to the

named partition. Users can read from and write to the rest of the table while the extents on the specified partition are being reclaimed. This situation also applies to the default access levels.

ALLOW NO ACCESS

For REORG TABLE RECLAIM EXTENTS ONLY, specifies that no other users can access the table while the extents are being reclaimed.

ALLOW READ ACCESS

For REORG TABLE RECLAIM EXTENTS ONLY, specifies that other users can have read-only access to the table while the extents are being reclaimed.

ALLOW WRITE ACCESS

For REORG TABLE RECLAIM EXTENTS ONLY, specifies that other users can read from and write to the table while the extents are being reclaimed.

TABLE *table-name*

Specifies the table to reorganize. The table can be in a local or a remote database. The name or alias in the form: *schema.table-name* can be used. The *schema* is the user name under which the table was created. If you omit the schema name, the default schema is assumed.

For typed tables, the specified table name must be the name of the hierarchy's root table.

You cannot specify an index for the reorganization of a multidimensional clustering (MDC) table. In place reorganization of tables cannot be used for MDC tables.

INDEX *index-name*

Specifies the index to use when reorganizing the table. If you do not specify the fully qualified name in the form: *schema.index-name*, the default schema is assumed. The *schema* is the user name under which the index was created. The database manager uses the index to physically reorder the records in the table it is reorganizing.

For an in place table reorganization, if a clustering index is defined on the table and an index is specified, it must be clustering index. If the in place option is not specified, any index specified will be used. If you do not specify the name of an index, the records are reorganized without regard to order. If the table has a clustering index defined, however, and no index is specified, then the clustering index is used to cluster the table. You cannot specify an index if you are reorganizing an MDC table.

ALLOW NO ACCESS

Specifies that no other users can access the table while the table is being reorganized. When reorganizing a partitioned table with no Table partitioning clause, this value is the default.

ALLOW READ ACCESS

Allow only read access to the table during reorganization. This value is the default for a nonpartitioned table or for a partitioned table using the Table partitioning clause.

When the ON DATA PARTITION option is specified for a REORG TABLE of a range partitioned table, the access clause applies to the named partition only. If all indexes on the table are partitioned,

users can read from and write to the rest of the table while the partition is being reorganized and its indexes rebuilt. However, if any nonpartitioned indexes are defined for the table, access for the entire table is escalated to ALLOW NO ACCESS. In this situation, the nonpartitioned indexes are rebuilt along with the specified partition.

INPLACE

Reorganizes the table while permitting user access.

In place table reorganization is allowed only on nonpartitioned and non-MDC tables with type-2 indexes, but without extended indexes and with no indexes defined over XML columns in the table. In place table reorganization can only be performed on tables that are at least three pages in size.

In place table reorganization takes place asynchronously, and might not be effective immediately.

ALLOW READ ACCESS

Allow only read access to the table during reorganization.

ALLOW WRITE ACCESS

Allow write access to the table during reorganization. This is the default behavior.

NOTTRUNCATE TABLE

Do not truncate the table after in place reorganization. During truncation, the table is S-locked.

START

Start the in place REORG processing. Because this is the default, this keyword is optional.

STOP Stop the in place REORG processing at its current point.

PAUSE

Suspend or pause in place REORG for the time being.

RESUME

Continue or resume a previously paused in place table reorganization. When an online reorganization is resumed and you want the same options as when the reorganization was paused, you must specify those options again while resuming.

USE *tblspace-name*

Specifies the name of a system temporary table space in which to store a temporary copy of the table being reorganized. If you do not provide a table space name, the database manager stores a working copy of the table in the table spaces that contain the table being reorganized.

For an 8KB, 16KB, or 32KB table object, if the page size of the system temporary table space that you specify does not match the page size of the table spaces in which the table data resides, the DB2 database product will try to find a temporary table space of the correct size of the LONG/LOB objects. Such a table space must exist for the reorganization to succeed.

When you have two temporary table spaces of the same page size, and you specify one of them in the USE clause, they will be used

in a round robin fashion if there is an index in the table being reorganized. Say you have two table spaces, `temp space1` and `temp space2`, both of the same page size and you specify `temp space1` in the REORG command with the USE option. When you perform REORG the first time, `temp space1` is used. The second time, `temp space2` is used. The third time, `temp space1` is used and so on. To avoid this, you should drop one of the temporary table spaces.

For partitioned tables, the table space is used as temporary storage for the reorganization of data partitions in the table.

Reorganization of the entire partitioned table reorganizes a single data partition at a time. The amount of space required is equal to the largest data partition in the table, and not the entire table.

If you do not supply a table space name for a partitioned table, the table space where each data partition is located is used for temporary storage of that data partition. There must be enough free space in each data partition's table space to hold a copy of the data partition.

INDEXSCAN

For a clustering REORG an index scan will be used to re-order table records. Reorganize table rows by accessing the table through an index. The default method is to scan the table and sort the result to reorganize the table, using temporary table spaces as necessary. Even though the index keys are in sort order, scanning and sorting is typically faster than fetching rows by first reading the row identifier from an index.

LONGLOBDATA

Long field and LOB data are to be reorganized.

This is not required even if the table contains long or LOB columns. The default is to avoid reorganizing these objects because it is time consuming and does not improve clustering. However, running a reorganization with the LONGLOBDATA option on tables with XML columns will reclaim unused space and thereby reduce the size of the XML storage object.

This parameter is required when converting existing LOB data into inlined LOB data.

USE *longtblspace-name*

This is an optional parameter, which can be used to specify the name of a temporary table space to be used for rebuilding long data. If no temporary table space is specified for either the table object or for the long objects, the objects will be constructed in the table space they currently reside. If a temporary table space is specified for the table but this parameter is not specified, then the table space used for base reorg data will be used, unless the page sizes differ. In this situation, the DB2 database system will attempt to choose a temporary container of the appropriate page size to create the long objects in.

If USE *longtblspace-name* is specified, USE *tblspace-name* must also be specified. If it is not, the *longtblspace-name* argument is ignored.

KEEPDICTIONARY

If the COMPRESS attribute for the table is YES and the table has a compression dictionary then no new dictionary is built. All the

rows processed during reorganization are subject to compression using the existing dictionary. If the COMPRESS attribute is YES and a compression dictionary doesn't exist for the table, a dictionary will only be created (and the table compressed) in this scenario if the table is of a certain size (approximately 1 to 2 MB) and sufficient data exists within this table. If, instead, you explicitly state REORG RESETDICTIONARY, then a dictionary is built as long as there is at least 1 row in the table. If the COMPRESS attribute for the table is NO and the table has a compression dictionary, then reorg processing will preserve the dictionary and all the rows in the newly reorganized table will be in noncompressed format. It is not possible to compress some data such as LOB data not stored in the base table row.

When the LONGLOBDATA option is not specified, only the table row data is reorganized. The following table describes the behavior of KEEPDICTIONARY syntax in REORG command when the LONGLOBDATA option is not specified.

Table 31. REORG KEEPDICTIONARY

Compress	Dictionary Exists	Result; outcome
Y	Y	Preserve dictionary; rows compressed.
Y	N	Build dictionary; rows compressed
N	Y	Preserve dictionary; all rows uncompressed
N	N	No effect; all rows uncompressed

The following table describes the behavior of KEEPDICTIONARY syntax in REORG command when the LONGLOBDATA option is specified.

Table 32. REORG KEEPDICTIONARY when LONGLOBDATA option is specified.

Compress	Table row data dictionary exists	XML storage object dictionary exists ¹	Compression dictionary	Data compression
Y	Y	Y	Preserve dictionaries.	Existing data is compressed. New data will be compressed.
Y	Y	N	Preserve table row dictionary and create an XML storage object dictionary.	Existing data is compressed. New data will be compressed.
Y	N	Y	Create table row dictionary and preserve the XML dictionary.	Existing data is compressed. New data will be compressed.
Y	N	N	Create table row and XML dictionaries.	Existing data is compressed. New data will be compressed.
N	Y	Y	Preserve table row and XML dictionaries.	Table data is uncompressed. New data will be not be compressed.

Table 32. REORG KEEPDICTIONARY when LONGLOBDATA option is specified. (continued)

Compress	Table row data dictionary exists	XML storage object dictionary exists ¹	Compression dictionary	Data compression
N	Y	N	Preserve table row dictionary.	Table data is uncompressed. New data will be not be compressed.
N	N	Y	Preserve XML dictionary.	Table data is uncompressed. New data will be not be compressed.
N	N	N	No effect.	Table data is uncompressed. New data will be not be compressed.

Note:

1. A compression dictionary can be created for the XML storage object of a table only if the XML columns are added to the table in DB2 V9.7 or later, or if the table is migrated using the ONLINE_TABLE_MOVE stored procedure.

For any reinitialization or truncation of a table (such as for a replace operation), if the compress attribute for the table is NO, the dictionary is discarded if one exists. Conversely, if a dictionary exists and the compress attribute for the table is YES then a truncation will save the dictionary and not discard it. The dictionary is logged in its entirety for recovery purposes and for future support with data capture changes (that is, replication).

RESETDICTIONARY

If the COMPRESS attribute for the table is YES then a new row compression dictionary is built. All the rows processed during reorganization are subject to compression using this new dictionary. This dictionary replaces any previous dictionary. If the COMPRESS attribute for the table is NO and the table does have an existing compression dictionary then reorg processing will remove the dictionary and all rows in the newly reorganized table will be in noncompressed format. It is not possible to compress some data such as LOB data not stored in the base table row.

If the LONGLOBDATA option is not specified, only the table row data is reorganized. The following table describes the behavior of RESETDICTIONARY syntax in REORG command when the LONGLOBDATA option is not specified.

Table 33. REORG RESETDICTIONARY

Compress	Dictionary Exists	Result; outcome
Y	Y	Build new dictionary*; rows compressed. If DATA CAPTURE CHANGES option is specified on the CREATE TABLE or ALTER TABLE statements, the current dictionary is kept (referred to as the <i>historical compression dictionary</i>).
Y	N	Build new dictionary; rows compressed
N	Y	Remove dictionary; all rows uncompressed. If the DATA CAPTURE NONE option is specified on the CREATE TABLE or ALTER TABLE statements, the <i>historical compression dictionary</i> is also removed for the specified table.
N	N	No effect; all rows uncompressed

* - If a dictionary exists and the compression attribute is enabled but there currently isn't any data in the table, the RESETDICTIONARY operation will keep the existing dictionary. Rows which are smaller in size than the internal minimum record length and rows which do not demonstrate a savings in record length when an attempt is made to compress them are considered "insufficient" in this case.

The following table describes the behavior of RESETDICTIONARY syntax in REORG command when the LONGLOBDATA option is specified.

Table 34. REORG RESETDICTIONARY when LONGLOBDATA option is specified.

Compress	Table row data dictionary exists	XML storage object dictionary exists ¹	Data dictionary	Data compression
Y	Y	Y	Build dictionaries ^{2 3} .	Existing data is compressed. New data will be compressed.
Y	Y	N	Build new table row dictionary and create a new XML dictionary ³ .	Existing data is compressed. New data will be compressed.
Y	N	Y	Create table row data dictionary and build a new XML dictionary.	Existing data is compressed. New data will be compressed.
Y	N	N	Create dictionaries.	Existing data is compressed. New data will be compressed.
N	Y	Y	Remove dictionaries. Existing and new data is not compressed.	Existing table data is uncompressed. New data will be not be compressed.
N	Y	N	Remove table row dictionary. All data is uncompressed.	Existing table data is uncompressed. New data will be not be compressed.

Table 34. REORG RESETDICTIONARY when LONGLOBDATA option is specified. (continued)

Compress	Table row data dictionary exists	XML storage object dictionary exists ¹	Data dictionary	Data compression
N	N	Y	Remove XML storage object dictionary.	Existing table data is uncompressed. New data will be not be compressed.
N	N	N	No effect.	Existing table data is uncompressed. New data will be not be compressed.

Notes:

1. A compression dictionary can be created for the XML storage object of a table only if the XML columns are added to the table in DB2 V9.7 or later, or if the table is migrated using an online table move.
2. If a dictionary exists and the compression attribute is enabled but there currently isn't any data in the table, the RESETDICTIONARY operation will keep the existing dictionary. Rows which are smaller in size than the internal minimum record length and rows which do not demonstrate a savings in record length when an attempt is made to compress them are considered insufficient in this case.
3. If DATA CAPTURE CHANGES option is specified on the CREATE TABLE or ALTER TABLE statements, the current data dictionary is kept (referred to as the *historical compression dictionary*).

ALL DBPARTITIONNUMS

Specifies that operation is to be done on all database partitions specified in the db2nodes.cfg file. This is the default if a node clause is not specified.

EXCEPT

Specifies that operation is to be done on all database partitions specified in the db2nodes.cfg file, except those specified in the node list.

ON DATA PARTITION *partition-name*

Specifies the data partition for the reorganization.

This option is only for use with RECLAIM EXTENTS ONLY.

If the data partition name does not exist for the specified table, REORG fails and SQL0204N is returned.

ON DBPARTITIONNUM | ON DBPARTITIONNUMS

Perform operation on a set of database partitions.

db-partition-number1

Specifies a database partition number in the database partition list.

db-partition-number2

Specifies the second database partition number, so that all database partitions from *db-partition-number1* up to and including *db-partition-number2* are included in the database partition list.

Examples

To reorganize a table to reclaim space and use the temporary table space `mytemp1`, enter the following command:

```
db2 reorg table homer.employee use mytemp1
```

To reorganize tables in a partition group consisting of nodes 1, 2, 3, and 4 of a four-node system, you can enter either of the following commands:

```
db2 reorg table employee index empid on dbpartitionnum (1,3,4)
```

```
db2 reorg table homer.employee index homer.empid on all  
dbpartitionnums except dbpartitionnum (2)
```

To clean up the pseudo deleted keys and pseudo empty pages in all the indexes on the EMPLOYEE table while allowing other transactions to read and update the table, enter:

```
db2 reorg indexes all for table homer.employee allow write  
access cleanup only
```

To clean up the pseudo empty pages in all the indexes on the EMPLOYEE table while allowing other transactions to read and update the table, enter:

```
db2 reorg indexes all for table homer.employee allow write  
access cleanup only pages
```

To reorganize the EMPLOYEE table using the system temporary table space `TEMPSPACE1` as a work area, enter:

```
db2 reorg table homer.employee use tempSPACE1
```

To start, pause, and resume an in place reorg of the EMPLOYEE table with the default schema `HOMER`, which is specified explicitly in previous examples, enter the following commands:

```
db2 reorg table employee index empid inplace start  
db2 reorg table employee inplace pause  
db2 reorg table homer.employee inplace allow read access  
nottruncate table resume
```

The command to resume the reorg contains additional keywords to specify read access only and to skip the truncation step, which share-locks the table.

Usage notes

Restrictions:

- The REORG utility does not support the use of nicknames.
- The REORG TABLE command is not supported for declared temporary tables or created temporary tables.
- The REORG TABLE command cannot be used on views.
- Reorganization of a table is not compatible with range-clustered tables, because the range area of the table always remains clustered.

- REORG TABLE cannot be used on a partitioned table in a DMS table space while an online backup of ANY table space in which the table resides, including LOBs and indexes, is being performed.
- REORG TABLE cannot use an index that is based on an index extension.
- If a table is in reorg pending state, an inplace reorg is not allowed on the table.
- For partitioned tables:
 - The table must have an ACCESS_MODE in SYSCAT.TABLES of Full Access.
 - Reorganization skips data partitions that are in a restricted state due to an attach or detach operation. If the Table partitioning clause is specified, that partition must be fully accessible.
 - If an error occurs during table reorganization, some indexes or index partitions might be left invalid. The nonpartitioned indexes of the table will be marked invalid if the reorganization has reached or passed the replace phase for the first data partition. The index partitions for any data partition that has already reached or passed the replace phase will be marked invalid. Indexes will be rebuilt on the next access to the table or data partition.
 - If an error occurs during index reorganization when the ALLOW NONE access mode is used, some indexes on the table might be left invalid. For nonpartitioned RID indexes on the table, only the index that is being reorganized at the time of the failure will be left invalid. For MDC tables with nonpartitioned block indexes, one or more of the block indexes might be left invalid if an error occurs. For partitioned indexes, only the index object on the data partition being reorganized will be left invalid. Any indexes marked invalid will be rebuilt on the next access to the table or data partition.

Information about the current progress of table reorganization is written to the history file for database activity. The history file contains a record for each reorganization event. To view this file, execute the LIST HISTORY command for the database that contains the table you are reorganizing.

You can also use table snapshots to monitor the progress of table reorganization. Table reorganization monitoring data is recorded regardless of the Database Monitor Table Switch setting.

If an error occurs, an SQLCA dump is written to the history file. For an in-place table reorganization, the status is recorded as PAUSED.

When an indexed table has been modified many times, the data in the indexes might become fragmented. If the table is clustered with respect to an index, the table and index can get out of cluster order. Both of these factors can adversely affect the performance of scans using the index, and can impact the effectiveness of index page prefetching. REORG INDEX or REORG INDEXES can be used to reorganize one or all of the indexes on a table. Index reorganization will remove any fragmentation and restore physical clustering to the leaf pages. Use the REORGCHK command to help determine if an index needs reorganizing. Be sure to complete all database operations and release all locks before invoking index reorganization. This can be done by issuing a COMMIT after closing all cursors opened WITH HOLD, or by issuing a ROLLBACK.

A classic table reorganization (offline reorganization) rebuilds the indexes during the last phase of the reorganization. However, the inplace table reorganization (online reorganization) does not rebuild the indexes. It is recommended that you issue a REORG INDEXES command after the completion of an inplace table reorganization. An inplace table reorganization is asynchronous, therefore care

must be taken to ensure that the inplace table reorganization is complete before issuing the REORG INDEXES command. Issuing the REORG INDEXES command before the inplace table reorganization is complete, might cause the reorganization to fail (SQLCODE -2219).

Tables that have been modified so many times that data is fragmented and access performance is noticeably slow are candidates for the REORG TABLE command. You should also invoke this utility after altering the inline length of a structured type column in order to benefit from the altered inline length. Use the REORGCHK command to determine whether a table needs reorganizing. Be sure to complete all database operations and release all locks before invoking REORG TABLE. This can be done by issuing a COMMIT after closing all cursors opened WITH HOLD, or by issuing a ROLLBACK. After reorganizing a table, use RUNSTATS to update the table statistics, and REBIND to rebind the packages that use this table. The reorganize utility will implicitly close all the cursors.

If the table contains mixed row format because the table value compression has been activated or deactivated, an offline table reorganization can convert all the existing rows into the target row format.

If the table is distributed across several database partitions, and the table or index reorganization fails on any of the affected database partitions, only the failing database partitions will have the table or index reorganization rolled back.

If the reorganization is not successful, temporary files should not be deleted. The database manager uses these files to recover the database.

If the name of an index is specified, the database manager reorganizes the data according to the order in the index. To maximize performance, specify an index that is often used in SQL queries. If the name of an index is *not* specified, and if a clustering index exists, the data will be ordered according to the clustering index.

The PCTFREE value of a table determines the amount of free space designated per page. If the value has not been set, the utility will fill up as much space as possible on each page.

To complete a table space roll-forward recovery following a table reorganization, both regular and large table spaces must be enabled for roll-forward recovery.

If the table contains LOB columns that do not use the COMPACT option, the LOB DATA storage object can be significantly larger following table reorganization. This can be a result of the order in which the rows were reorganized, and the types of table spaces used (SMS or DMS).

Indexes over XML data may be recreated by the REORG INDEXES/TABLE command. For details, see "Recreation of indexes over XML data".

Chapter 104. REORGCHK

Calculates statistics on the database to determine if tables or indexes, or both, need to be reorganized or cleaned up.

Scope

This command can be issued from any database partition in the `db2nodes.cfg` file. It can be used to update table and index statistics in the catalogs.

Authorization

One of the following:

- *sysadm* or *dbadm* authority
- CONTROL privilege on the table.

Required connection

Database

Command syntax

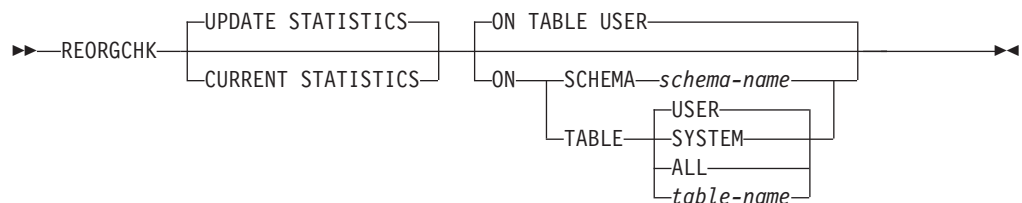

Command parameters

UPDATE STATISTICS

Calls the RUNSTATS routine to update table and index statistics, and then uses the updated statistics to determine if table or index reorganization is required.

If a portion of the table resides on the database partition where REORGCHK has been issued, the utility executes on this database partition. If the table does not exist on this database partition, the request is sent to the first database partition in the database partition group that holds a portion of the table. RUNSTATS then executes on this database partition.

CURRENT STATISTICS

Uses the current table statistics to determine if table reorganization is required.

ON SCHEMA *schema-name*

Checks all the tables created under the specified schema.

ON TABLE

USER Checks the tables that are owned by the run time authorization ID.

SYSTEM

Checks the system tables.

ALL Checks all user and system tables.

table-name

Specifies the table to check. The fully qualified name or alias in the form: *schema.table-name* must be used. The *schema* is the user name under which the table was created. If the table specified is a system catalog table, the *schema* is SYSIBM. For typed tables, the specified table name must be the name of the hierarchy's root table.

Examples

Issue the following command against the SAMPLE database:

```
db2 reorgchk update statistics on table system
```

In the resulting output, the terms for the table statistics (formulas 1-3) mean:

CARD

(CARDINALITY) Number of rows in base table.

OV (OVERFLOW) Number of overflow rows.

NP (NPAGES) Number of pages that contain data.

FP (FPAGES) Total number of pages.

ACTBLK

Total number of active blocks for a multidimensional clustering (MDC) table. This field is only applicable to tables defined using the ORGANIZE BY clause. It indicates the number of blocks of the table that contain data.

TSIZE Table size in bytes. Calculated as the product of the number of rows in the table (CARD) and the average row length. The average row length is computed as the sum of the average column lengths (AVGCOLLEN in SYSCOLUMNS) plus 10 bytes of row overhead. For long fields and LOBs only the approximate length of the descriptor is used. The actual long field or LOB data is not counted in TSIZE.

TABLEPAGESIZE

Page size of the table space in which the table data resides.

NPARTITIONS

Number of partitions if this is a partitioned table, otherwise 1.

F1 Results of Formula 1.

F2 Results of Formula 2.

F3 Results of Formula 3. This formula indicates the amount of space that is wasted in a table. This is measured in terms of the number of empty pages and the number of pages that include data that exists in the pages of a table. In multi-dimensional clustering (MDC) tables, the number of empty blocks and the number of blocks that include data is measured.

REORG

Each hyphen (-) displayed in this column indicates that the calculated results were within the set bounds of the corresponding formula, and each asterisk (*) indicates that the calculated results exceeded the set bounds of its corresponding formula.

- - or * on the left side of the column corresponds to F1 (Formula 1)

- - or * in the middle of the column corresponds to F2 (Formula 2)
- - or * on the right side of the column corresponds to F3 (Formula 3).

Table reorganization is suggested when the results of the calculations exceed the bounds set by the formula.

For example, --- indicates that, since the formula results of F1, F2, and F3 are within the set bounds of the formula, no table reorganization is suggested. The notation *-* indicates that the results of F1 and F3 suggest table reorganization, even though F2 is still within its set bounds. The notation *-- indicates that F1 is the only formula exceeding its bounds.

The table name is truncated to 30 characters, and the ">" symbol in the thirty-first column represents the truncated portion of the table name. An "*" suffix to a table name indicates it is an MDC table. An "*" suffix to an index name indicates it is an MDC dimension index.

The terms for the index statistics (formulas 4-8) mean:

INDCARD

(INDEX CARDINALITY) Number of index entries in the index. This could be different than table cardinality for some indexes. For example, for indexes on XML columns the index cardinality is likely greater than the table cardinality.

LEAF Total number of index leaf pages (NLEAF).

ELEAF

Number of pseudo empty index leaf pages (NUM_EMPTY_LEAFS)

A pseudo empty index leaf page is a page on which all the RIDs are marked as deleted, but have not been physically removed.

NDEL Number of pseudo deleted RIDs (NUMRIDS_DELETED)

A pseudo deleted RID is a RID that is marked deleted. This statistic reports pseudo deleted RIDs on leaf pages that are not pseudo empty. It does not include RIDs marked as deleted on leaf pages where all the RIDs are marked deleted.

KEYS Number of unique index entries that are not marked deleted (FULLKEYCARD)

LEAF_REC_SIZE

Record size of the index entry on a leaf page. This is the average size of the index entry excluding any overhead and is calculated from the average column length of all columns participating in the index.

NLEAF_REC_SIZE

Record size of the index entry on a non-leaf page. This is the average size of the index entry excluding any overhead and is calculated from the average column length of all columns participating in the index except any INCLUDE columns.

LEAF_PAGE_OVERHEAD

Reserved space on the index leaf page for internal use.

NLEAF_PAGE_OVERHEAD

Reserved space on the index non-leaf page for internal use.

INDEXPAGESIZE

Page size of the table space in which the index resides, specified at the time of index or table creation. If not specified, INDEXPAGESIZE has the same value as TABLEPAGESIZE.

LVLS Number of index levels (NLEVELS)

PCTFREE

Specifies the percentage of each index page to leave as free space, a value that is assigned when defining the index. Values can range from 0 to 99. The default value is 10.

LEAF_RECSIZE_OVERHEAD

Index record overhead on a leaf page. For indexes on tables in LARGE table spaces the overhead is 11 for partitioned tables and 9 for other tables. For indexes on tables in REGULAR table spaces these values are 9 for partitioned tables and 7 for others. The only exception to these rules are XML paths and XML regions indexes where the overhead is always 9. This information is also available in the table below for easy reference.

NLEAF_RECSIZE_OVERHEAD

Index record overhead on a non-leaf page. For indexes on tables in LARGE table spaces the overhead is 14 for partitioned tables and 12 for other tables. For indexes on tables in REGULAR table spaces these values are 12 for partitioned tables and 10 for others. The only exception to these rules are XML paths and XML regions indexes where the overhead is always 12. This information is also available in the table below for easy reference.

DUPKEYSIZE

Size of duplicate keys on index leaf pages. For indexes on tables in LARGE table spaces the DUPKEYSIZE is 9 for partitioned tables and 7 for other tables. For indexes on tables in REGULAR table spaces these values are 7 for partitioned tables and 5 for others. The only exception to these rules are XML paths and XML regions indexes where the DUPKEYSIZE is always 7. This information is also available in the table below for easy reference.

Table 35. LEAF_RECSIZE_OVERHEAD, NLEAF_RECSIZE_OVERHEAD, and DUPKEYSIZE values are a function of index type, table partitioning, and table space type

Variable	Data in REGULAR table space			Data in LARGE table space**		
	Regular Table		Partitioned Table	Regular Table		Partitioned Table
	XML paths or regions index	All other indexes	All indexes	XML paths or regions index	All other indexes	All indexes
LEAF_RECSIZE_OVERHEAD	9	7	9	9	9	11
NLEAF_RECSIZE_OVERHEAD	12	10	12	12	12	14
DUPKEYSIZE	7	5	7	7	7	9

** For indexes on tables in large table spaces the indexes will be assumed to have large RIDs. This may cause some of the formulas to give inaccurate results if the table space of the table was converted to large but the indexes have not yet been recreated or reorganized.

F4 Results of Formula 4.

F5 Results of Formula 5. The notation +++ indicates that the result exceeds

999, and is invalid. Rerun REORGCHK with the UPDATE STATISTICS option, or issue RUNSTATS, followed by the REORGCHK command.

F6 Results of Formula 6. The notation +++ indicates that the result exceeds 999, and might be invalid. Rerun REORGCHK with the UPDATE STATISTICS option, or issue RUNSTATS, followed by the REORGCHK command. If the statistics are current and valid, you should reorganize.

F7 Results of Formula 7.

F8 Results of Formula 8.

REORG

Each hyphen (-) displayed in this column indicates that the calculated results were within the set bounds of the corresponding formula, and each asterisk (*) indicates that the calculated result exceeded the set bounds of its corresponding formula.

- - or * on the left column corresponds to F4 (Formula 4)
- - or * in the second from left column corresponds to F5 (Formula 5)
- - or * in the middle column corresponds to F6 (Formula 6).
- - or * in the second column from the right corresponds to F7 (Formula 7)
- - or * on the right column corresponds to F8 (Formula 8).

Index reorganization advice is as follows:

- If the results of the calculations for Formula 1, 2 and 3 do not exceed the bounds set by the formula and the results of the calculations for Formula 4, 5 or 6 do exceed the bounds set, then index reorganization is recommended.
- If only the results of the calculations Formula 7 exceed the bounds set, but the results of Formula 1, 2, 3, 4, 5 and 6 are within the set bounds, then cleanup of the indexes using the CLEANUP ONLY option of index reorganization is recommended.
- If the only calculation result to exceed the set bounds is the that of Formula 8, then a cleanup of the pseudo empty pages of the indexes using the CLEANUP ONLY PAGES option of index reorganization is recommended.

On a partitioned table the results for formulas (5 to 8) can be misleading depending on when the statistics are collected. When data partitions are detached, the index keys for the detached partition are not cleaned up immediately. Instead, the cleanup is deferred and eventually the keys are removed by index cleaners which operate asynchronously in the background (this is known as Asynchronous Index Cleanup or AIC). While the index keys pending cleanup exist in the index, they will not be counted as part of the keys in the statistics because they are invisible and no longer part of the table. As a result, statistics collected before asynchronous index cleanup is run will be misleading. If the REORGCHK command is issued before asynchronous index cleanup completes, it will likely generate a false alarm for index reorganization or index cleanup based on the inaccurate statistics. Once asynchronous index cleanup is run, all the index keys that still belong to detached data partitions which require cleanup will be removed and this may eliminate the need for index reorganization.

For partitioned tables, you are encouraged to issue the REORGCHK after an asynchronous index cleanup has completed in order to generate accurate index statistics in the presence of detached data partitions. To

determine whether or not there are detached data partitions in the table, you can check the status field in the SYSDATAPARTITIONS table and look for the value I (index cleanup) or D (detached with dependant MQT).

Usage notes

This command does not display statistical information for declared temporary tables or created temporary tables.

This utility does not support the use of nicknames.

A new server release might introduce new table and index features. These new features might impact REORGCHK logic, that is, how REORGCHK computes REORG recommendations. If REORGCHK is issued from a client not at the same level as the server, it might report different results than those reported from a client at the same level as the server. REORGCHK is a client application, therefore, REORGCHK should be run from a client running the same level as the server. Doing so ensures the most accurate report is generated. For server administrative work, in general, use a client and a server at the same level.

Unless you specify the CURRENT STATISTICS option, REORGCHK gathers statistics on all columns using the default options only. Specifically, column group are not gathered and if LIKE statistics were previously gathered, they are not gathered by REORGCHK. The statistics gathered depend on the kind of statistics currently stored in the catalog tables:

- If detailed index statistics are present in the catalog for any index, table statistics and detailed index statistics (without sampling) for all indexes are collected.
- If detailed index statistics are not detected, table statistics as well as regular index statistics are collected for every index.
- If distribution statistics are detected, distribution statistics are gathered on the table. If distribution statistics are gathered, the number of frequent values and quantiles are based on the database configuration parameter settings.

REORGCHK calculates statistics obtained from eight different formulas to determine if performance has deteriorated or can be improved by reorganizing a table or its indexes. When a table uses less than or equal to (NPARTITIONS * 1 extent size) of pages, no table reorganization is recommended based on each formula. More specifically,

- For non-partitioned tables (NPARTITIONS =1), the threshold is:
(FPAGES <= 1 extent size)
- For partitioned tables, it is:
(FPAGES <= NPARTITIONS * 1 extent size)
- In a multi-partitioned database, after the number of database partitions in a database partition group of the table is considered, this threshold for not recommending table reorganization changes to:
FPAGES <= 'number of database partitions in a database partition group of the table' * NPARTITIONS * 1 extent size

Long field or LOB data is not accounted for while calculating TSIZE.

REORGCHK uses the following formulas to analyze the physical location of rows and the size of the table:

- Formula F1:
 $100 * \text{OVERFLOW} / \text{CARD} < 5$

The total number of overflow rows in the table should be less than 5 percent of the total number of rows. Overflow rows can be created when rows are updated and the new rows contain more bytes than the old ones (VARCHAR fields), or when columns are added to existing tables.

- Formula F2:

For regular tables:

$$100 * TSIZE / ((FPAGES - NPARTITIONS) * (TABLEPAGESIZE - 68)) > 70$$

The table size in bytes (TSIZE) should be more than 70 percent of the total space allocated for the table. (There should be less than 30% free space.) The total space allocated for the table depends upon the page size of the table space in which the table resides (minus an overhead of 68 bytes). Because the last page allocated in the data object is not usually filled, 1 is subtracted from FPAGES for each partition (which is the same as FPAGES - NPARTITIONS).

For MDC tables:

$$100 * TSIZE / ((ACTBLK - FULLKEYCARD) * EXTENTSIZE * (TABLEPAGESIZE - 68)) > 70$$

FULLKEYCARD represents the cardinality of the composite dimension index for the MDC table. Extent size is the number of pages per block. The formula checks if the table size in bytes is more than the 70 percent of the remaining blocks for a table after subtracting the minimum required number of blocks.

- Formula F3:

$$100 * NPAGES / FPAGES > 80$$

The number of pages that contain no rows at all should be less than 20 percent of the total number of pages. (Pages can become empty after rows are deleted.) As noted above, no table reorganization is recommended when (FPAGES <= NPARTITIONS * 1 extent size). Therefore, F3 is not calculated. For non-partitioned tables, NPARTITIONS = 1. In a multi-partitioned database, this condition changes to FPAGES = 'number of database partitions in a database partition group of the table' * NPARTITIONS * 1 extent size.

For MDC tables, the formula is:

$$100 * \text{activeblocks} / ((\text{fpages} / \text{ExtentSize}) - 1)$$

REORGCHK uses the following formulas to analyze the indexes and their the relationship to the table data:

- Formula F4:

– For non-partitioned tables:

$$\text{CLUSTERRATIO or normalized CLUSTERFACTOR} > 80$$

The global CLUSTERFACTOR and CLUSTERRATIO take into account the correlation between the index key and distribution key. The clustering ratio of an index should be greater than 80 percent. When multiple indexes are defined on one table, some of these indexes have a low cluster ratio. (The index sequence is not the same as the table sequence.) This cannot be avoided. Be sure to specify the most important index when reorganizing the table. The cluster ratio is usually not optimal for indexes that contain many duplicate keys and many entries.

– For partitioned tables:

$$\text{AVGPARTITION_CLUSTERRATIO or normalized AVGPARTITION_CLUSTERFACTOR} > 80$$

AVGPARTITION_CLUSTERFACTOR and AVGPARTITION_CLUSTERFACTOR values reflect how clustered data is within a data partition with respect to an index key. A partitioned table can be perfectly clustered for a particular index key within each data partition, and still have a low value for the CLUSTERFACTOR and CLUSTERRATIO because the index key is not a prefix of the table partitioning key. Design your tables and indexes using the most

important index keys as a prefix of the table partitioning key. In addition, because the optimizer uses the global clusteredness values to make decisions about queries that span multiple data partitions, it is possible to perform a clustering reorganization and have the optimizer still not choose the clustering index when the keys do not agree.

- Formula F5:

- For a single database partition:

$$100 * (KEYS * (LEAF_RECSIZE + LEAF_RECSIZE_OVERHEAD) + (INDCARD - KEYS) * DUPKEYSIZE) / ((NLEAF - NUM_EMPTY_LEAFS - 1) * (INDEXPAGESIZE - LEAF_PAGE_OVERHEAD)) > MIN(50, (100 - PCTFREE))$$

The space in use at the leaf level of the index should be greater than the minimum of 50 and 100-PCTFREE percent (only checked when NLEAF>1).

- For a multi-partition database environment:

$$100 * (KEYS * (LEAF_RECSIZE + LEAF_RECSIZE_OVERHEAD) + (INDCARD - KEYS) * DUPKEYSIZE) / ((NLEAF - NUM_EMPTY_LEAFS - NPARTITIONS) * (INDEXPAGESIZE - LEAF_PAGE_OVERHEAD)) > MIN(50, (100 - PCTFREE))$$

- Formula F6:

$$(100 - PCTFREE) * ((FLOOR((100 - LEVEL2PCTFREE) / 100 * (INDEXPAGESIZE - NLEAF_PAGE_OVERHEAD) / (NLEAF_RECSIZE + NLEAF_RECSIZE_OVERHEAD))) * (FLOOR((100 - MIN(10, LEVEL2PCTFREE)) / 100 * (INDEXPAGESIZE - NLEAF_PAGE_OVERHEAD) / (NLEAF_RECSIZE + NLEAF_RECSIZE_OVERHEAD)) ** (NLEVELS - 3)) * (INDEXPAGESIZE - LEAF_PAGE_OVERHEAD) / (KEYS * (LEAF_RECSIZE + LEAF_RECSIZE_OVERHEAD) + (INDCARD - KEYS) * DUPKEYSIZE)) < 100$$

To determine if recreating the index would result in a tree having fewer levels. This formula checks the ratio between the amount of space in an index tree that has one less level than the current tree, and the amount of space needed. If a tree with one less level could be created and still leave PCTFREE available, then a reorganization is recommended. The actual number of index entries should be more than (100-PCTFREE) percent of the number of entries an NLEVELS-1 index tree can handle (only checked if NLEVELS>2). In the case where NLEVELS = 2, the other REORGCHK formulas should be relied upon to determine if the index should be reorganized.

In simplified form, formula F6 can be rewritten as the following:

$$\frac{\text{Amount of space needed for an index if it was one level smaller}}{\text{Amount of space needed for all the entries in the index}} < 1$$

When the above left part is > 1, it means all index entries in the existing index can fit into an index that is one level smaller than the existing index. In this case, a reorg index is recommended.

The amount of space needed for an NLEVELS-1 index is calculated by:

$$(\text{The max number of leaf pages that a NLEVELS-1 index can have}) * (\text{Amount of space available to store index entries per leaf page})$$

where,

$$\begin{aligned} \text{The max number of leaf pages that a NLEVELS-1 index can have} = & \\ (\text{No. of entries a level 2 index page can have}) * & \\ (\text{No. of entries per page on levels greater than 2}) ** & \\ (\text{No. of levels in the intended index} - 2) = & \end{aligned}$$

$$\left\{ \frac{(100 - LEVEL2PCTFREE)}{100} \right\} * \left[\frac{(\text{Page Size} - \text{Overhead})}{(\text{Avg. size of each nonleaf index entry})} \right] * (100 - MIN(10, LEVEL2PCTFREE))$$

$$\text{FLOOR}\left(\frac{\text{-----}}{100} * \frac{(\text{PageSize} - \text{Overhead})}{\text{-----}}\right)**$$

(Avg. size of each nonleaf index entry)

(NLEVELS-3) }

(100 - LEVEL2PCTFREE) is the percentage of used space on level 2 of the index.

Level 2 is the level immediately above the leaf level.

(100 - MIN(10, LEVEL2PCTFREE)) is the percentage of used space on all levels above the second level.

NLEVELS is the number of index levels in the existing index.

The amount of space available to store index entries per leaf page =
 $((100 - \text{PCTFREE}) / 100 * (\text{INDEXPAGESIZE} - \text{LEAF_PAGE_OVERHEAD})) =$
 (Used space per page * (PageSize - Overhead))

The amount of space needed for all index entries:
 $\text{KEYS} * (\text{LEAF_RECSIZE} + \text{LEAF_RECSIZE_OVERHEAD}) +$
 $(\text{INDCARD} - \text{KEYS}) * \text{DUPKEYSIZE}$

(KEYS * (LEAF_RECSIZE + LEAF_RECSIZE_OVERHEAD)) represents the space used for the first occurrence of each key value in the index and ((INDCARD - KEYS) * DUPKEYSIZE) represents the space used for subsequent (duplicate) occurrences of a key value.

- Formula F7:

$$100 * (\text{NUMRIDS_DELETED} / (\text{NUMRIDS_DELETED} + \text{INDCARD})) < 20$$

The number of pseudo-deleted RIDs on non-pseudo-empty pages should be less than 20 percent.

- Formula F8:

$$100 * (\text{NUM_EMPTY_LEAFS} / \text{NLEAF}) < 20$$

The number of pseudo-empty leaf pages should be less than 20 percent of the total number of leaf pages.

Running statistics on many tables can take time, especially if the tables are large.

Usage notes for index compression

Formula F5 determines the ratio between the amount of space needed by the keys and the amount of space allocated. Formula F6 determines if recreating the index would result in a tree having fewer levels. The following formula checks the ratio between the amount of space in an index tree that has one less level than the current tree, and the amount of space needed. This formula relies on the amount of space needed for all index entries. Both formulae use the amount of space needed for all index entries.

The amount of space needed for all index entries in an uncompressed index is as follows:

$$\text{KEYS} * (\text{LEAF_RECSIZE} + \text{LEAF_RECSIZE_OVERHEAD}) +$$

$$(\text{INDCARD} - \text{KEYS}) * \text{DUPKEYSIZE}$$

where LEAF_RECSIZE is the average size of index key and DUPKEYSIZE is the size of a RID.

In a compressed index, LEAF_REC_SIZE is affected by prefix compression. DUPKEY_SIZE is not a reliable way to measure the size of duplicate keys on indexes. The amount of space needed in a compressed index is the amount of space needed for all uncompressed index entries multiplied by the index compression ratio.

$$\begin{aligned} & (\text{KEYS} * (\text{LEAF_REC_SIZE} + \text{LEAF_REC_SIZE_OVERHEAD}) + \\ & (\text{INDCARD} - \text{KEYS}) * \text{DUPKEY_SIZE}) * \text{COMPRESSION_RATIO} \end{aligned}$$

where COMPRESSION_RATIO is the estimated index compression ratio in the index. The COMPRESSION_RATIO is calculated as:

$$(100 - \text{PCT_PAGES_SAVED}) / 100$$

where PCT_PAGES_SAVED is the estimated percentage of leaf pages saved from index compression. This value is taken from the catalogs. If statistics are not collected, PCT_PAGES_SAVED is -1 in the catalogs, and COMPRESSION_RATIO is 1.

Both REORGCHK command and the REORGCHK_IX_STATS procedure show the PCT_PAGES_SAVED value.

Chapter 105. RESET ADMIN CONFIGURATION

Resets entries in the DB2 Administration Server (DAS) configuration file on the node to which you are connected. The DAS is a special administrative tool that enables remote administration of DB2 servers. The values are reset by node type, which is always a server with remote clients. For a list of DAS parameters, see the description of the UPDATE ADMIN CONFIGURATION command.

Scope

This command resets the DAS configuration file on the administration node of the system to which you are connected.

Authorization

dasadm

Required connection

Partition. To reset the DAS configuration for a remote system, specify the system using the FOR NODE option with the administration node name.

Command syntax

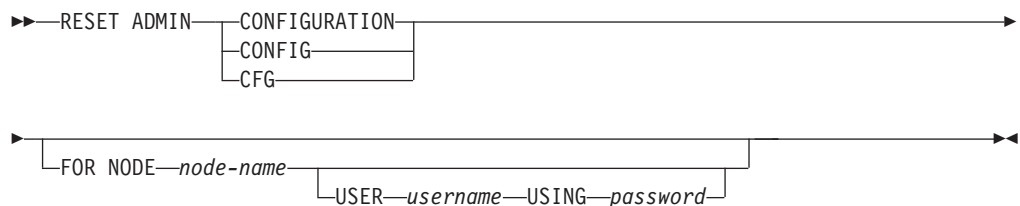

Command parameters

FOR NODE *node-name*

Enter the name of an administrator node to reset DAS configuration parameters there.

USER *username* **USING** *password*

If connection to the remote system requires user name and password, enter this information.

Usage notes

To reset the DAS configuration parameters on a remote system, specify the system using the administrator node name as an argument to the FOR NODE option and specify the user name and password if the connection to that node requires username and password authorization.

To view or print a list of the DAS configuration parameters, use the GET ADMIN CONFIGURATION command. To change the value of an admin parameter, use the UPDATE ADMIN CONFIGURATION command.

Changes to the DAS configuration parameters that can be updated on-line take place immediately. Other changes become effective only after they are loaded into memory when you restart the DAS with the db2admin command.

If an error occurs, the DAS configuration file does not change.

The DAS configuration file cannot be reset if the checksum is invalid. This might occur if you edit the DAS configuration file manually and do not use the appropriate command. If the checksum is invalid, you must drop and recreate the DAS to reset the its configuration file.

Chapter 106. RESET ALERT CONFIGURATION

Resets the health indicator settings for specific objects to the current defaults for that object type or resets the current default health indicator settings for an object type to the install defaults.

Important: This command or API has been deprecated and might be removed in a future release because the health monitor has been deprecated in Version 9.7. For more information, see the “Health monitor has been deprecated” topic in the *What’s New for DB2 Version 9.7* book.

Authorization

One of the following:

- *sysadm*
- *sysmaint*
- *sysctrl*

Required connection

Instance. An explicit attachment is not required.

Command syntax

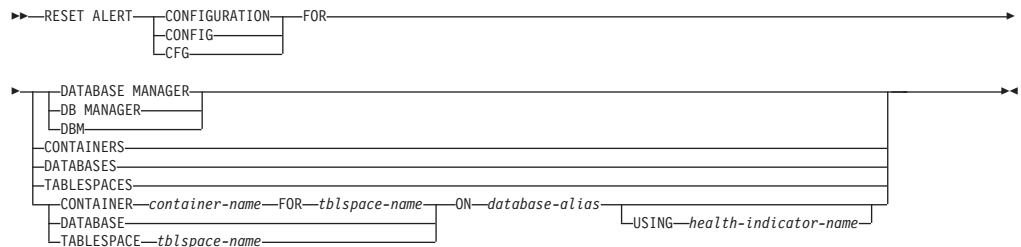

Command parameters

DATABASE MANAGER | DB MANAGER | DBM

Resets alert settings for the database manager.

CONTAINERS

Resets default alert settings for all table space containers managed by the database manager to the install default. These are the settings that apply to all table space containers that do not have custom settings. Custom settings are defined using the `CONTAINER container-name FOR tblspace-name ON database-alias` clause.

DATABASES

Resets alert settings for all databases managed by the database manager. These are the settings that apply to all databases that do not have custom settings. Custom settings are defined using the `DATABASE ON database-alias` clause.

TABLESPACES

Resets default alert settings for all table spaces managed by the database manager to the install default. These are the settings that apply to all table

spaces that do not have custom settings. Custom settings are defined using the `TABLESPACE tblspace-name ON database-alias` clause.

CONTAINER *container-name* **FOR** *tblspace-name* **ON** *database-alias*

Resets the alert settings for the table space container called *container-name*, for the table space specified using the `FOR tblspace-name` clause, on the database specified using the `ON database-alias` clause. If this table space container has custom settings, then these settings are removed and the current table space containers default is used.

DATABASE ON *database-alias*

Resets the alert settings for the database specified using the `ON database-alias` clause. If this database has custom settings, then these settings are removed and the install default is used.

TABLESPACE *tblspace-name* **ON** *database-alias*

Resets the alert settings for the table space called *tblspace-name*, on the database specified using the `ON database-alias` clause. If this table space has custom settings, then these settings are removed and the install default is used.

USING *health-indicator-name*

Specifies the set of health indicators for which alert configuration will be reset. Health indicator names consist of a two-letter object identifier followed by a name that describes what the indicator measures. For example:

```
db.sort_privmem_util
```

If you do not specify this option, all health indicators for the specified object or object type will be reset.

Chapter 107. RESET DATABASE CONFIGURATION

Resets the configuration of a specific database to the system defaults.

Scope

This command updates all database partitions by default, except when **DBPARTITIONNUM** is specified to reset only one database partition.

Authorization

One of the following:

- SYSADM
- SYSCTRL
- SYSMANT

Required connection

Instance. An explicit attachment is not required. If the database is listed as remote, an instance attachment to the remote node is established for the duration of the command.

Command syntax

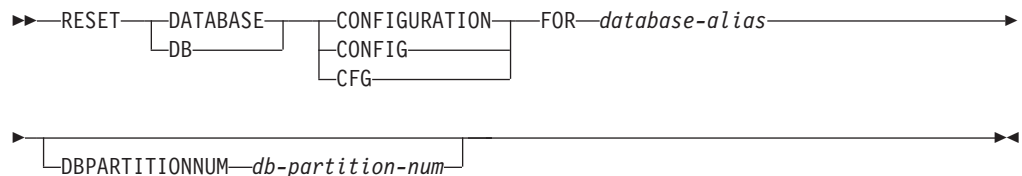

Command parameters

FOR *database-alias*

Specifies the alias of the database whose configuration is to be reset to the system defaults.

DBPARTITIONNUM *db-partition-num*

If a database configuration reset is to be applied to a specific database partition, this parameter may be used. If this parameter is not provided, the reset will take effect on all database partitions.

Example

Reset the database configuration on a multi-partition instance

A user has a partitioned database environment that has 4 database partitions as defined in the `db2nodes.cfg`:

```
10 gilera 0
20 gilera 1
30 motobi 0
40 motobi 1
```

The user has created the SAMPLE database on the instance. The catalog partition for SAMPLE is on database partition number 10. Let's assume the user is logged on to system motobi.

The following command will reset all the database configuration values for database SAMPLE on all database partitions:

```
db2 reset db cfg for sample
```

The following commands will reset all the database configuration values for database SAMPLE, only at database partition number 30:

```
db2 reset db cfg for sample dbpartitionnum 30
```

or

```
export DB2NODE=30
db2 reset db cfg for sample
```

Usage notes

To view or print a list of the database configuration parameters, use the GET DATABASE CONFIGURATION command.

To change the value of a configurable parameter, use the UPDATE DATABASE CONFIGURATION command.

Changes to the database configuration file become effective only after they are loaded into memory. All applications must disconnect from the database before this can occur.

If an error occurs, the database configuration file does not change.

The database configuration file cannot be reset if the checksum is invalid. This might occur if the database configuration file is changed without using the appropriate command. If this happens, the database must be restored to reset the database configuration file.

The RESET DATABASE CONFIGURATION command will reset the database configuration parameters to the documented default configuration values, where **auto_runstats** will be ON. **Self_tuning_mem** will be reset to ON on non-partitioned database environments and to OFF on partitioned database environments.

Chapter 108. RESET DATABASE MANAGER CONFIGURATION

Resets the parameters in the database manager configuration file to the system defaults. The values are reset by node type.

Authorization

SYSADM

Required connection

None or instance. An instance attachment is not required to perform local database manager configuration operations, but is required to perform remote database manager configuration operations. To update the database manager configuration for a remote instance, it is necessary to first attach to that instance. To update a configuration parameter online, it is also necessary to first attach to the instance.

Command syntax

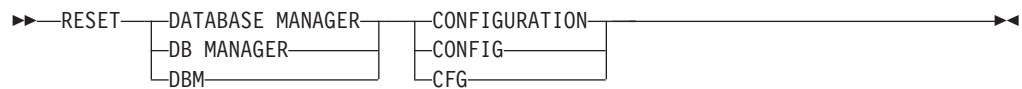

Command parameters

None

Usage notes

This command resets all parameters set by the installation program. This could cause error messages to be returned when restarting DB2. For example, if the **svcname** parameter is reset, the user will receive the SQL5043N error message when trying to restart DB2.

Before running this command, save the output from the GET DATABASE MANAGER CONFIGURATION command to a file so that you can refer to the existing settings. Individual settings can then be updated using the UPDATE DATABASE MANAGER CONFIGURATION command.

It is not recommended that the **svcname** parameter, set by the installation program, be modified by the user.

To view or print a list of the database manager configuration parameters, use the GET DATABASE MANAGER CONFIGURATION command. To change the value of a configurable parameter, use the UPDATE DATABASE MANAGER CONFIGURATION command.

For more information about these parameters, refer to the summary list of configuration parameters and the individual parameters.

Some changes to the database manager configuration file become effective only after they are loaded into memory. For more information on which parameters are

configurable on-line and which ones are not, see the configuration parameter summary. Server configuration parameters that are not reset immediately are reset during execution of db2start. For a client configuration parameter, parameters are reset the next time you restart the application. If the client is the command line processor, it is necessary to invoke TERMINATE.

If an error occurs, the database manager configuration file does not change.

The database manager configuration file cannot be reset if the checksum is invalid. This might occur if you edit the configuration file manually and do not use the appropriate command. If the checksum is invalid, you must recreate the instance.

Chapter 109. RESET MONITOR

Resets the internal database system monitor data areas of a specified database, or of all active databases, to zero. The internal database system monitor data areas include the data areas for all applications connected to the database, as well as the data areas for the database itself.

Authorization

One of the following:

- *sysadm*
- *sysctrl*
- *sysmaint*
- *sysmon*

Required connection

Instance. If there is no instance attachment, a default instance attachment is created.

To reset the monitor switches for a remote instance (or a different local instance), it is necessary to first attach to that instance.

Command syntax

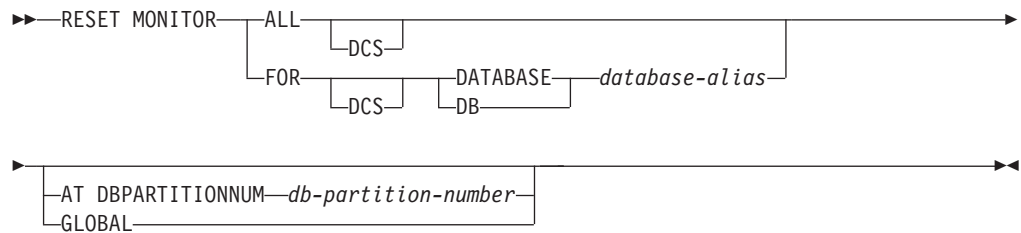

Command parameters

ALL This option indicates that the internal counters should be reset for all databases.

FOR DATABASE *database-alias*

This option indicates that only the database with alias *database-alias* should have its internal counters reset.

DCS Depending on which clause it is specified, this keyword resets the internal counters of:

- All DCS databases
- A specific DCS database.

AT DBPARTITIONNUM *db-partition-number*

Specifies the database partition for which the status of the monitor switches is to be displayed.

GLOBAL

Returns an aggregate result for all database partitions in a partitioned database environment.

Usage notes

Each process (attachment) has its own private view of the monitor data. If one user resets, or turns off a monitor switch, other users are not affected. Change the setting of the monitor switch configuration parameters to make global changes to the monitor switches.

If ALL is specified, some database manager information is also reset to maintain consistency of the returned data, and some database partition-level counters are reset.

Compatibilities

For compatibility with versions earlier than Version 8:

- The keyword NODE can be substituted for DBPARTITIONNUM.

Chapter 110. RESTART DATABASE

Restarts a database that has been abnormally terminated and left in an inconsistent state. At the successful completion of RESTART DATABASE, the application remains connected to the database if the user has CONNECT privilege.

Scope

This command affects only the node on which it is executed.

Authorization

None

Required connection

This command establishes a database connection.

Command syntax

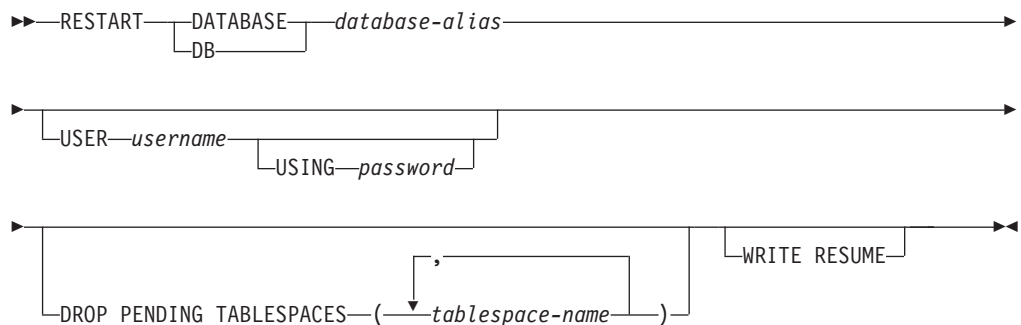

Command parameters

DATABASE *database-alias*
Identifies the database to restart.

USER *username*
Identifies the user name under which the database is to be restarted.

USING *password*
The password used to authenticate *username*. If the password is omitted, the user is prompted to enter it.

DROP PENDING TABLESPACES *tablespace-name*
Specifies that the database restart operation is to be successfully completed even if table space container problems are encountered.

If a problem occurs with a container for a specified table space during the restart process, the corresponding table space will not be available (it will be in drop-pending state) after the restart operation. If a table space is in the drop-pending state, the only possible action is to drop the table space.

In the case of circular logging, a troubled table space will cause a restart failure. A list of troubled table space names can be found in the administration notification log if a restart database operation fails because

of container problems. If there is only one system temporary table space in the database, and it is in drop pending state, a new system temporary table space must be created immediately following a successful database restart operation.

WRITE RESUME

Allows you to force a database restart on databases that failed while I/O writes were suspended. Before performing crash recovery, this option will resume I/O writes by removing the SUSPEND_WRITE state from every table space in the database.

The WRITE RESUME option can also be used in the case where the connection used to suspend I/O writes is currently hung and all subsequent connection attempts are also hanging. When used in this circumstance, RESTART DATABASE will resume I/O writes to the database without performing crash recovery. RESTART DATABASE with the WRITE RESUME option will only perform crash recovery when you use it after a database crash. The WRITE RESUME parameter can only be applied to the primary database, not to mirrored databases.

Usage notes

Execute this command if an attempt to connect to a database returns an error message, indicating that the database must be restarted. This action occurs only if the previous session with this database terminated abnormally (due to power failure, for example).

On a partitioned database system, in order to resolve the indoubt transactions, the RESTART DATABASE command should be issued on all nodes, as in the example below:

```
db2_all "db2 restart database database-alias"
```

If the database is only restarted on a single node within an MPP system, a message might be returned on a subsequent database query indicating that the database needs to be restarted. This occurs because the database partition on a node on which the query depends must also be restarted. Restarting the database on all nodes solves the problem.

Chapter 111. RESTORE DATABASE

The RESTORE DATABASE command recreates a damaged or corrupted database that has been backed up using the DB2 backup utility. The restored database is in the same state that it was in when the backup copy was made. This utility can also overwrite a database with a different image or restore the backup copy to a new database.

For information on the restore operations supported by DB2 database systems between different operating systems and hardware platforms, see “Backup and restore operations between different operating systems and hardware platforms” in the *Data Recovery and High Availability Guide and Reference*.

The restore utility can also be used to restore backup images in DB2 Version 9.7 that were backed up on DB2 Universal Database Version 8, DB2 Version 9.1, or DB2 Version 9.5. If a database upgrade is required, it will be invoked automatically at the end of the restore operation.

If, at the time of the backup operation, the database was enabled for rollforward recovery, the database can be brought to its previous state by invoking the rollforward utility after successful completion of a restore operation.

This utility can also restore a table space level backup.

Incremental images and images only capturing differences from the time of the previous capture (called a “delta image”) cannot be restored when there is a difference in operating systems or word size (32-bit or 64-bit).

Following a successful restore operation from one environment to a different environment, no incremental or delta backups are allowed until a non-incremental backup is taken. (This is not a limitation following a restore operation within the same environment.)

Even with a successful restore operation from one environment to a different environment, there are some considerations: packages must be rebound before use (using the BIND command, the REBIND command, or the db2rbind utility); SQL procedures must be dropped and recreated; and all external libraries must be rebuilt on the new platform. (These are not considerations when restoring to the same environment.)

A restore operation run over an existing database and existing containers reuses the same containers and tablespace map.

A restore operation run against a new database reacquires all containers and rebuilds an optimized tablespace map. A restore operation run over an existing database with one or more missing containers also reacquires all containers and rebuilds an optimized tablespace map.

Scope

This command only affects the node on which it is executed.

Authorization

To restore to an existing database, one of the following:

- *sysadm*
- *sysctrl*
- *sysmaint*

To restore to a new database, one of the following:

- *sysadm*
- *sysctrl*

Required connection

The required connection will vary based on the type of restore action:

- You require a database connection, to restore to an existing database. This command automatically establishes an exclusive connection to the specified database.
- You require an instance and a database connection, to restore to a new database. The instance attachment is required to create the database.
To restore to a new database at an instance different from the current instance, it is necessary to first attach to the instance where the new database will reside. The new instance can be local or remote. The current instance is defined by the value of the DB2INSTANCE environment variable.
- For snapshot restore, *instance* and *database* connections are required.

Command syntax

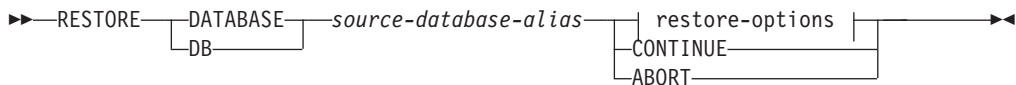

restore-options:

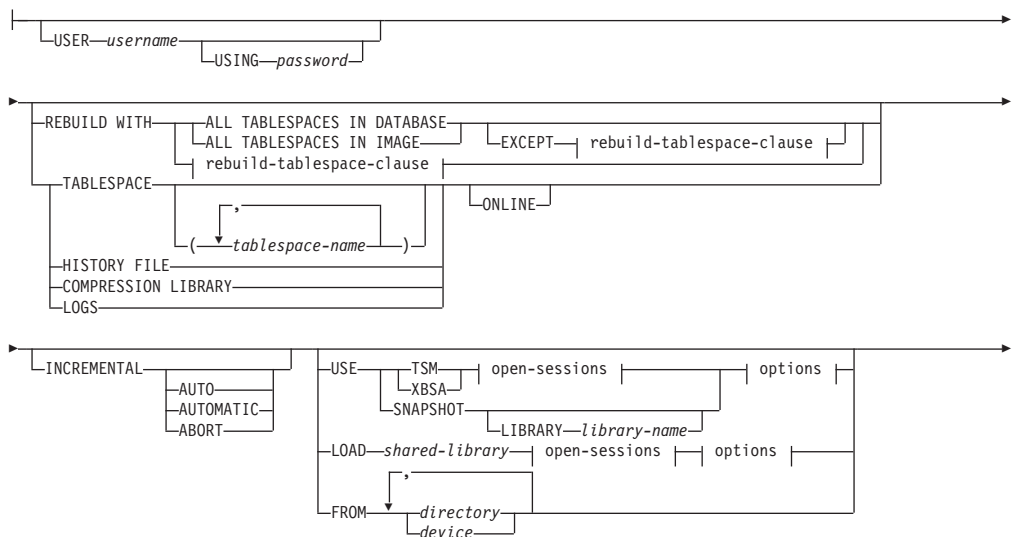

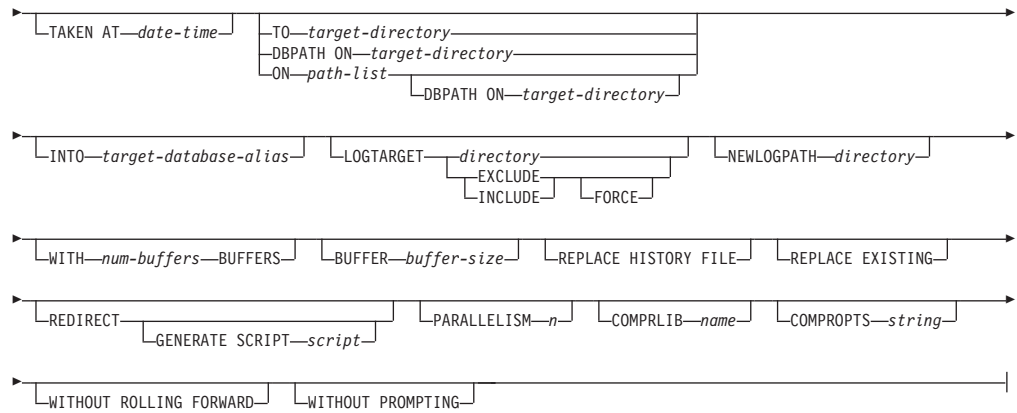

rebuild-tablespace-clause:

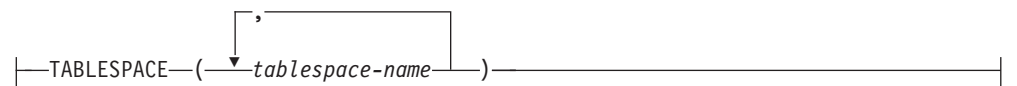

open-sessions:

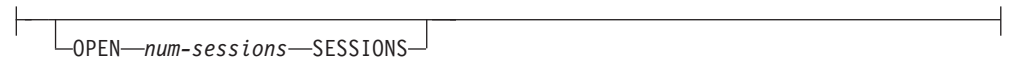

options:



Command parameters

DATABASE *source-database-alias*

Alias of the source database from which the backup was taken.

CONTINUE

Specifies that the containers have been redefined, and that the final step in a redirected restore operation should be performed.

ABORT

This parameter:

- Stops a redirected restore operation. This is useful when an error has occurred that requires one or more steps to be repeated. After RESTORE DATABASE with the ABORT option has been issued, each step of a redirected restore operation must be repeated, including RESTORE DATABASE with the REDIRECT option.
- Terminates an incremental restore operation before completion.

USER *username*

Identifies the user name under which the database is to be restored.

USING *password*

The password used to authenticate the user name. If the password is omitted, the user is prompted to enter it.

REBUILD WITH ALL TABLESPACES IN DATABASE

Restores the database with all the table spaces known to the database at the time of the image being restored. This restore overwrites a database if it already exists.

REBUILD WITH ALL TABLESPACES IN DATABASE EXCEPT

rebuild-tablespace-clause

Restores the database with all the table spaces known to the database at the time of the image being restored except for those specified in the list. This restore overwrites a database if it already exists.

REBUILD WITH ALL TABLESPACES IN IMAGE

Restores the database with only the table spaces in the image being restored. This restore overwrites a database if it already exists.

REBUILD WITH ALL TABLESPACES IN IMAGE EXCEPT *rebuild-tablespace-clause*

Restores the database with only the table spaces in the image being restored except for those specified in the list. This restore overwrites a database if it already exists.

REBUILD WITH *rebuild-tablespace-clause*

Restores the database with only the list of table spaces specified. This restore overwrites a database if it already exists.

TABLESPACE *tablespace-name*

A list of names used to specify the table spaces that are to be restored.

ONLINE

This keyword, applicable only when performing a table space-level restore operation, is specified to allow a backup image to be restored online. This means that other agents can connect to the database while the backup image is being restored, and that the data in other table spaces will be available while the specified table spaces are being restored.

HISTORY FILE

This keyword is specified to restore only the history file from the backup image.

COMPRESSION LIBRARY

This keyword is specified to restore only the compression library from the backup image. If the object exists in the backup image, it will be restored into the database directory. If the object does not exist in the backup image, the restore operation will fail.

LOGS This keyword is specified to restore only the set of log files contained in the backup image. If the backup image does not contain any log files, the restore operation will fail. If this option is specified, the LOGTARGET option must also be specified.

INCREMENTAL

Without additional parameters, INCREMENTAL specifies a manual cumulative restore operation. During manual restore the user must issue each restore command manually for each image involved in the restore. Do so according to the following order: last, first, second, third and so on up to and including the last image.

INCREMENTAL AUTOMATIC/AUTO

Specifies an automatic cumulative restore operation.

INCREMENTAL ABORT

Specifies abortion of an in-progress manual cumulative restore operation.

USE

- TSM** Specifies that the database is to be restored from output managed by Tivoli Storage Manager.
- XBSA** Specifies that the XBSA interface is to be used. Backup Services APIs (XBSA) are an open application programming interface for applications or facilities needing data storage management for backup or archiving purposes.

SNAPSHOT

Specifies that the data is to be restored from a snapshot backup.

You cannot use the SNAPSHOT parameter with any of the following parameters:

- INCREMENTAL
- TO
- ON
- DBPATH ON
- INTO
- NEWLOGPATH
- WITH *num-buffers* BUFFERS
- BUFFER
- REDIRECT
- REPLACE HISTORY FILE
- COMPRESSION LIBRARY
- PARALLELISM
- COMPRLIB
- OPEN *num-sessions* SESSIONS
- HISTORY FILE
- LOGS

Also, you cannot use the SNAPSHOT parameter with any restore operation that involves a table space list, which includes the REBUILD WITH option.

The default behavior when restoring data from a snapshot backup image will be a FULL DATABASE OFFLINE restore of all paths that make up the database including all containers, local volume directory, database path (DBPATH), primary log and mirror log paths of the most recent snapshot backup if no timestamp is provided (INCLUDE LOGS is the default for all snapshot backups unless EXCLUDE LOGS is explicitly stated). If a timestamp is provided, then that snapshot backup image will be restored.

LIBRARY *library-name*

Integrated into IBM Data Server is a DB2 ACS API driver for the following storage hardware:

- IBM TotalStorage[®] SAN Volume Controller
- IBM Enterprise Storage Server[®] Model 800
- IBM System Storage[™] DS6000[™]
- IBM System Storage DS8000[®]
- IBM System Storage N Series
- NetApp V-series

- NetApp FAS

If you have other storage hardware, and a DB2 ACS API driver for that storage hardware, you can use the LIBRARY parameter to specify the DB2 ACS API driver.

The value of the LIBRARY parameter is a fully-qualified library file name.

OPTIONS

"options-string"

Specifies options to be used for the restore operation. The string will be passed to DB2 ACS API driver exactly as it was entered, without the double quotation marks. You cannot use the **VENDOROPT** database configuration parameter to specify vendor-specific options for snapshot restore operations. You must use the OPTIONS parameter of the restore utilities instead.

@file-name

Specifies that the options to be used for the restore operation are contained in a file located on the DB2 server. The string will be passed to the vendor support library. The file must be a fully qualified file name.

OPEN *num-sessions* **SESSIONS**

Specifies the number of I/O sessions that are to be used with TSM or the vendor product.

FROM *directory/device*

The fully qualified path name of the directory or device on which the backup image resides. If USE TSM, FROM, and LOAD are omitted, the default value is the current working directory of the client machine. This target directory or device must exist on the target server/instance.

If several items are specified, and the last item is a tape device, the user is prompted for another tape. Valid response options are:

- c** Continue. Continue using the device that generated the warning message (for example, continue when a new tape has been mounted).
- d** Device terminate. Stop using *only* the device that generated the warning message (for example, terminate when there are no more tapes).
- t** Terminate. Abort the restore operation after the user has failed to perform some action requested by the utility.

LOAD *shared-library*

The name of the shared library (DLL on Windows operating systems) containing the vendor backup and restore I/O functions to be used. The name can contain a full path. If the full path is not given, the value defaults to the path on which the user exit program resides.

TAKEN AT[®] *date-time*

The time stamp of the database backup image. The time stamp is displayed after successful completion of a backup operation, and is part of the path name for the backup image. It is specified in the form *yyyymmddhhmmss*. A partial time stamp can also be specified. For example, if two different backup images with time stamps 20021001010101 and 20021002010101 exist, specifying 20021002 causes the image with time

stamp 20021002010101 to be used. If a value for this parameter is not specified, there must be only one backup image on the source media.

TO *target-directory*

This parameter states the target database directory. This parameter is ignored if the utility is restoring to an existing database. The drive and directory that you specify must be local. If the backup image contains a database that is enabled for automatic storage then only the database directory changes, the storage paths associated with the database do not change.

DBPATH ON *target-directory*

This parameter states the target database directory. This parameter is ignored if the utility is restoring to an existing database. The drive and directory that you specify must be local. If the backup image contains a database that is enabled for automatic storage and the ON parameter is not specified then this parameter is synonymous with the TO parameter and only the database directory changes, the storage paths associated with the database do not change.

ON *path-list*

This parameter redefines the storage paths associated with an automatic storage database. Using this parameter with a database that is not enabled for automatic storage results in an error (SQL20321N). The existing storage paths as defined within the backup image are no longer used and automatic storage table spaces are automatically redirected to the new paths. If this parameter is not specified for an automatic storage database then the storage paths remain as they are defined within the backup image.

One or more paths can be specified, each separated by a comma. Each path must have an absolute path name and it must exist locally. If the database does not already exist on disk and the DBPATH ON parameter is not specified then the first path is used as the target database directory.

For a multi-partition database the ON *path-list* option can only be specified on the catalog partition. The catalog partition must be restored before any other partitions are restored when the ON option is used. The restore of the catalog-partition with new storage paths will place all non-catalog nodes in a RESTORE_PENDING state. The non-catalog nodes can then be restored in parallel without specifying the ON clause in the restore command.

In general, the same storage paths must be used for each partition in a multi-partition database and they must all exist prior to executing the RESTORE DATABASE command. One exception to this is where database partition expressions are used within the storage path. Doing this allows the database partition number to be reflected in the storage path such that the resulting path name is different on each partition.

You use the argument " \$N" ([blank]\$N) to indicate a database partition expression. A database partition expression can be used anywhere in the storage path, and multiple database partition expressions can be specified. Terminate the database partition expression with a space character; whatever follows the space is appended to the storage path after the database partition expression is evaluated. If there is no space character in the storage path after the database partition expression, it is assumed that the rest of the string is part of the expression. The argument can only be used in one of the following forms:

Table 36. . Operators are evaluated from left to right. % represents the modulus operator. The database partition number in the examples is assumed to be 10.

Syntax	Example	Value
[blank]\$N	" \$N"	10
[blank]\$N+[number]	" \$N+100"	110
[blank]\$N%[number]	" \$N%5"	0
[blank]\$N+[number]%[number]	" \$N+1%5"	1
[blank]\$N%[number]+[number]	" \$N%4+2"	4
^a % is modulus.		

INTO *target-database-alias*

The target database alias. If the target database does not exist, it is created.

When you restore a database backup to an existing database, the restored database inherits the alias and database name of the existing database.

When you restore a database backup to a nonexistent database, the new database is created with the alias and database name that you specify. This new database name must be unique on the system where you restore it.

LOGTARGET *directory*

Non-snapshot restores:

The absolute path name of an existing directory on the database server, to be used as the target directory for extracting log files from a backup image. If this option is specified, any log files contained within the backup image will be extracted into the target directory. If this option is not specified, log files contained within a backup image will not be extracted. To extract only the log files from the backup image, specify the LOGS option.

Snapshot restores:

INCLUDE

Restore log directory volumes from the snapshot image. If this option is specified and the backup image contains log directories, then they will be restored. Existing log directories and log files on disk will be left intact if they do not conflict with the log directories in the backup image. If existing log directories on disk conflict with the log directories in the backup image, then an error will be returned.

EXCLUDE

Do not restore log directory volumes. If this option is specified, then no log directories will be restored from the backup image. Existing log directories and log files on disk will be left intact if they do not conflict with the log directories in the backup image. If a path belonging to the database is restored and a log directory will implicitly be restored because of this, thus causing a log directory to be overwritten, an error will be returned.

FORCE

Allow existing log directories in the current database to be overwritten and replaced when restoring the snapshot image. Without this option, existing log directories and log files on disk which conflict with log directories in the snapshot image will cause the restore to fail. Use this option to indicate that the restore can overwrite and replace those existing log directories.

Note: Use this option with caution, and always ensure that you have backed up and archived all logs that might be required for recovery.

Note: If LOGTARGET is not specified non-snapshot restores, then the default LOGTARGET directory is LOGTARGET EXCLUDE.

NEWLOGPATH *directory*

The absolute pathname of a directory that will be used for active log files after the restore operation. This parameter has the same function as the **newlogpath** database configuration parameter, except that its effect is limited to the restore operation in which it is specified. The parameter can be used when the log path in the backup image is not suitable for use after the restore operation; for example, when the path is no longer valid, or is being used by a different database.

WITH *num-buffers* **BUFFERS**

The number of buffers to be used. The DB2 database system will automatically choose an optimal value for this parameter unless you explicitly enter a value. A larger number of buffers can be used to improve performance when multiple sources are being read from, or if the value of PARALLELISM has been increased.

BUFFER *buffer-size*

The size, in pages, of the buffer used for the restore operation. The DB2 database system will automatically choose an optimal value for this parameter unless you explicitly enter a value. The minimum value for this parameter is 8 pages.

The restore buffer size must be a positive integer multiple of the backup buffer size specified during the backup operation. If an incorrect buffer size is specified, the buffers are allocated to be of the smallest acceptable size.

REPLACE HISTORY FILE

Specifies that the restore operation should replace the history file on disk with the history file from the backup image.

REPLACE EXISTING

If a database with the same alias as the target database alias already exists, this parameter specifies that the restore utility is to replace the existing database with the restored database. This is useful for scripts that invoke the restore utility, because the command line processor will not prompt the user to verify deletion of an existing database. If the WITHOUT PROMPTING parameter is specified, it is not necessary to specify REPLACE EXISTING, but in this case, the operation will fail if events occur that normally require user intervention.

REDIRECT

Specifies a redirected restore operation. To complete a redirected restore operation, this command should be followed by one or more SET TABLESPACE CONTAINERS commands, and then by a RESTORE DATABASE command with the CONTINUE option. All commands associated with a single redirected restore operation must be invoked from the same window or CLP session.

GENERATE SCRIPT *script*

Creates a redirect restore script with the specified file name. The script name can be relative or absolute and the script will be generated on the client side. If the file cannot be created on the client side, an error message

(SQL9304N) will be returned. If the file already exists, it will be overwritten. Please see the examples below for further usage information.

WITHOUT ROLLING FORWARD

Specifies that the database is not to be put in rollforward pending state after it has been successfully restored.

If, following a successful restore operation, the database is in rollforward pending state, the ROLLFORWARD command must be invoked before the database can be used again.

If this option is specified when restoring from an online backup image, error SQL2537N will be returned.

If backup image is of a recoverable database then WITHOUT ROLLING FORWARD cannot be specified with REBUILD option.

PARALLELISM *n*

Specifies the number of buffer manipulators that are to be created during the restore operation. The DB2 database system will automatically choose an optimal value for this parameter unless you explicitly enter a value.

COMPRLIB *name*

Indicates the name of the library to be used to perform the decompression (e.g., db2compr.dll for Windows; libdb2compr.so for Linux/UNIX systems). The name must be a fully qualified path referring to a file on the server. If this parameter is not specified, DB2 will attempt to use the library stored in the image. If the backup was not compressed, the value of this parameter will be ignored. If the specified library cannot be loaded, the restore operation will fail.

COMPROPTS *string*

Describes a block of binary data that is passed to the initialization routine in the decompression library. The DB2 database system passes this string directly from the client to the server, so any issues of byte reversal or code page conversion are handled by the decompression library. If the first character of the data block is "@", the remainder of the data is interpreted by the DB2 database system as the name of a file residing on the server. The DB2 database system will then replace the contents of *string* with the contents of this file and pass the new value to the initialization routine instead. The maximum length for the string is 1 024 bytes.

WITHOUT PROMPTING

Specifies that the restore operation is to run unattended. Actions that normally require user intervention will return an error message. When using a removable media device, such as tape or diskette, the user is prompted when the device ends, even if this option is specified.

Examples

1. In the following example, the database WSDB is defined on all 4 database partitions, numbered 0 through 3. The path /dev3/backup is accessible from all database partitions. The following offline backup images are available from /dev3/backup:

```
wsdb.0.db2inst1.NODE0000.CATN0000.20020331234149.001
wsdb.0.db2inst1.NODE0001.CATN0000.20020331234427.001
wsdb.0.db2inst1.NODE0002.CATN0000.20020331234828.001
wsdb.0.db2inst1.NODE0003.CATN0000.20020331235235.001
```

To restore the catalog partition first, then all other database partitions of the WSDb database from the /dev3/backup directory, issue the following commands from one of the database partitions:

```
db2_all '<<+0< db2 RESTORE DATABASE wsdb FROM /dev3/backup
TAKEN AT 20020331234149
INTO wsdb REPLACE EXISTING'
db2_all '<<+1< db2 RESTORE DATABASE wsdb FROM /dev3/backup
TAKEN AT 20020331234427
INTO wsdb REPLACE EXISTING'
db2_all '<<+2< db2 RESTORE DATABASE wsdb FROM /dev3/backup
TAKEN AT 20020331234828
INTO wsdb REPLACE EXISTING'
db2_all '<<+3< db2 RESTORE DATABASE wsdb FROM /dev3/backup
TAKEN AT 20020331235235
INTO wsdb REPLACE EXISTING'
```

The db2_all utility issues the restore command to each specified database partition. When performing a restore using db2_all, you should always specify REPLACE EXISTING and/or WITHOUT PROMPTING. Otherwise, if there is prompting, the operation will look like it is hanging. This is because db2_all does not support user prompting.

2. Following is a typical redirected restore scenario for a database whose alias is MYDB:

- a. Issue a RESTORE DATABASE command with the REDIRECT option.

```
restore db mydb replace existing redirect
```

After successful completion of step 1, and before completing step 3, the restore operation can be aborted by issuing:

```
restore db mydb abort
```

- b. Issue a SET TABLESPACE CONTAINERS command for each table space whose containers must be redefined. For example:

```
set tablespace containers for 5 using
(file 'f:\ts3con1' 20000, file 'f:\ts3con2' 20000)
```

To verify that the containers of the restored database are the ones specified in this step, issue the LIST TABLESPACE CONTAINERS command.

- c. After successful completion of steps 1 and 2, issue:

```
restore db mydb continue
```

This is the final step of the redirected restore operation.

- d. If step 3 fails, or if the restore operation has been aborted, the redirected restore can be restarted, beginning at step 1.
3. Following is a sample weekly incremental backup strategy for a recoverable database. It includes a weekly full database backup operation, a daily non-cumulative (delta) backup operation, and a mid-week cumulative (incremental) backup operation:

```
(Sun) backup db mydb use tsm
(Mon) backup db mydb online incremental delta use tsm
(Tue) backup db mydb online incremental delta use tsm
(Wed) backup db mydb online incremental use tsm
(Thu) backup db mydb online incremental delta use tsm
(Fri) backup db mydb online incremental delta use tsm
(Sat) backup db mydb online incremental use tsm
```

For an automatic database restore of the images created on Friday morning, issue:

```
restore db mydb incremental automatic taken at (Fri)
```

For a manual database restore of the images created on Friday morning, issue:

```
restore db mydb incremental taken at (Fri)
restore db mydb incremental taken at (Sun)
restore db mydb incremental taken at (Wed)
restore db mydb incremental taken at (Thu)
restore db mydb incremental taken at (Fri)
```

4. To produce a backup image, which includes logs, for transportation to a remote site:

```
backup db sample online to /dev3/backup include logs
```

To restore that backup image, supply a LOGTARGET path and specify this path during ROLLFORWARD:

```
restore db sample from /dev3/backup logtarget /dev3/logs
rollforward db sample to end of logs and stop overflow log path /dev3/logs
```

5. To retrieve only the log files from a backup image that includes logs:

```
restore db sample logs from /dev3/backup logtarget /dev3/logs
```
6. The USE TSM OPTIONS keywords can be used to specify the TSM information to use for the restore operation. On Windows platforms, omit the -fromowner option.

- Specifying a delimited string:

```
restore db sample use TSM options '"-fromnode=bar -fromowner=dmcinnis"'
```

- Specifying a fully qualified file:

```
restore db sample use TSM options @/u/dmcinnis/myoptions.txt
```

The file myoptions.txt contains the following information: -fromnode=bar -fromowner=dmcinnis

7. The following is a simple restore of a multi-partition automatic storage enabled database with new storage paths. The database was originally created with one storage path, /myPath0:

- On the catalog partition issue: restore db mydb on /myPath1,/myPath2
- On all non-catalog partitions issue: restore db mydb

8. A script output of the following command on a non-auto storage database:

```
restore db sample from /home/jseifert/backups taken at 20050301100417 redirect
generate script SAMPLE_NODE0000.clp
```

would look like this:

```
-- *****
-- ** automatically created redirect restore script
-- *****
UPDATE COMMAND OPTIONS USING S ON Z ON SAMPLE_NODE0000.out V ON;
SET CLIENT ATTACH_DBPARTITIONNUM 0;
SET CLIENT CONNECT_DBPARTITIONNUM 0;
-- *****
-- ** initialize redirected restore
-- *****
RESTORE DATABASE SAMPLE
-- USER '<username>'
-- USING '<password>'
FROM '/home/jseifert/backups'
TAKEN AT 20050301100417
-- DBPATH ON '<target-directory>'
INTO SAMPLE
-- NEWLOGPATH '/home/jseifert/jseifert/NODE0000/SQL00001/SQLLOGDIR/'
-- WITH <num-buff> BUFFERS
```

```

-- BUFFER <buffer-size>
-- REPLACE HISTORY FILE
-- REPLACE EXISTING
REDIRECT
-- PARALLELISM <n>
-- WITHOUT ROLLING FORWARD
-- WITHOUT PROMPTING
;
-- *****
-- ** tablespace definition
-- *****
-- ** Tablespace name                = SYSCATSPACE
-- ** Tablespace ID                  = 0
-- ** Tablespace Type                = System managed space
-- ** Tablespace Content Type        = Any data
-- ** Tablespace Page size (bytes)   = 4096
-- ** Tablespace Extent size (pages) = 32
-- ** Using automatic storage        = No
-- ** Total number of pages          = 5572
-- *****
SET TABLESPACE CONTAINERS FOR 0
-- IGNORE ROLLFORWARD CONTAINER OPERATIONS
USING (
  PATH 'SQLT0000.0'
);
-- *****
-- ** Tablespace name                = TEMPSPACE1
-- ** Tablespace ID                  = 1
-- ** Tablespace Type                = System managed space
-- ** Tablespace Content Type        = System Temporary data
-- ** Tablespace Page size (bytes)   = 4096
-- ** Tablespace Extent size (pages) = 32
-- ** Using automatic storage        = No
-- ** Total number of pages          = 0
-- *****
SET TABLESPACE CONTAINERS FOR 1
-- IGNORE ROLLFORWARD CONTAINER OPERATIONS
USING (
  PATH 'SQLT0001.0'
);
-- *****
-- ** Tablespace name                = USERSPACE1
-- ** Tablespace ID                  = 2
-- ** Tablespace Type                = System managed space
-- ** Tablespace Content Type        = Any data
-- ** Tablespace Page size (bytes)   = 4096
-- ** Tablespace Extent size (pages) = 32
-- ** Using automatic storage        = No
-- ** Total number of pages          = 1
-- *****
SET TABLESPACE CONTAINERS FOR 2
-- IGNORE ROLLFORWARD CONTAINER OPERATIONS
USING (
  PATH 'SQLT0002.0'
);
-- *****
-- ** Tablespace name                = DMS
-- ** Tablespace ID                  = 3
-- ** Tablespace Type                = Database managed space
-- ** Tablespace Content Type        = Any data
-- ** Tablespace Page size (bytes)   = 4096
-- ** Tablespace Extent size (pages) = 32
-- ** Using automatic storage        = No
-- ** Auto-resize enabled            = No
-- ** Total number of pages          = 2000
-- ** Number of usable pages         = 1960

```

```

-- ** High water mark (pages) = 96
-- *****
SET TABLESPACE CONTAINERS FOR 3
-- IGNORE ROLLFORWARD CONTAINER OPERATIONS
USING (
  FILE /tmp/dms1 1000
, FILE /tmp/dms2 1000
);
-- *****
-- ** Tablespace name = RAW
-- ** Tablespace ID = 4
-- ** Tablespace Type = Database managed space
-- ** Tablespace Content Type = Any data
-- ** Tablespace Page size (bytes) = 4096
-- ** Tablespace Extent size (pages) = 32
-- ** Using automatic storage = No
-- ** Auto-resize enabled = No
-- ** Total number of pages = 2000
-- ** Number of usable pages = 1960
-- ** High water mark (pages) = 96
-- *****
SET TABLESPACE CONTAINERS FOR 4
-- IGNORE ROLLFORWARD CONTAINER OPERATIONS
USING (
  DEVICE '/dev/hdb1' 1000
, DEVICE '/dev/hdb2' 1000
);
-- *****
-- ** start redirect restore
-- *****
RESTORE DATABASE SAMPLE CONTINUE;
-- *****
-- ** end of file
-- *****

```

9. A script output of the following command on an automatic storage database:

```

restore db test from /home/jseifert/backups taken at 20050304090733 redirect
generate script TEST_NODE0000.clp

```

would look like this:

```

-- *****
-- ** automatically created redirect restore script
-- *****
UPDATE COMMAND OPTIONS USING S ON Z ON TEST_NODE0000.out V ON;
SET CLIENT ATTACH_DBPARTITIONNUM 0;
SET CLIENT CONNECT_DBPARTITIONNUM 0;
-- *****
-- ** initialize redirected restore
-- *****
RESTORE DATABASE TEST
-- USER '<username>'
-- USING '<password>'
FROM '/home/jseifert/backups'
TAKEN AT 20050304090733
ON '/home/jseifert'
-- DBPATH ON <target-directory>
INTO TEST
-- NEWLOGPATH '/home/jseifert/jseifert/NODE0000/SQL00002/SQLLOGDIR/'
-- WITH <num-buff> BUFFERS
-- BUFFER <buffer-size>
-- REPLACE HISTORY FILE
-- REPLACE EXISTING
REDIRECT
-- PARALLELISM <n>
-- WITHOUT ROLLING FORWARD
-- WITHOUT PROMPTING

```

```

;
-- *****
-- ** tablespace definition
-- *****
-- *****
-- ** Tablespace name = SYSCATSPACE
-- ** Tablespace ID = 0
-- ** Tablespace Type = Database managed space
-- ** Tablespace Content Type = Any data
-- ** Tablespace Page size (bytes) = 4096
-- ** Tablespace Extent size (pages) = 4
-- ** Using automatic storage = Yes
-- ** Auto-resize enabled = Yes
-- ** Total number of pages = 6144
-- ** Number of usable pages = 6140
-- ** High water mark (pages) = 5968
-- *****
-- *****
-- ** Tablespace name = TEMPSPACE1
-- ** Tablespace ID = 1
-- ** Tablespace Type = System managed space
-- ** Tablespace Content Type = System Temporary data
-- ** Tablespace Page size (bytes) = 4096
-- ** Tablespace Extent size (pages) = 32
-- ** Using automatic storage = Yes
-- ** Total number of pages = 0
-- *****
-- *****
-- ** Tablespace name = USERSPACE1
-- ** Tablespace ID = 2
-- ** Tablespace Type = Database managed space
-- ** Tablespace Content Type = Any data
-- ** Tablespace Page size (bytes) = 4096
-- ** Tablespace Extent size (pages) = 32
-- ** Using automatic storage = Yes
-- ** Auto-resize enabled = Yes
-- ** Total number of pages = 256
-- ** Number of usable pages = 224
-- ** High water mark (pages) = 96
-- *****
-- *****
-- ** Tablespace name = DMS
-- ** Tablespace ID = 3
-- ** Tablespace Type = Database managed space
-- ** Tablespace Content Type = Any data
-- ** Tablespace Page size (bytes) = 4096
-- ** Tablespace Extent size (pages) = 32
-- ** Using automatic storage = No
-- ** Auto-resize enabled = No
-- ** Total number of pages = 2000
-- ** Number of usable pages = 1960
-- ** High water mark (pages) = 96
-- *****
SET TABLESPACE CONTAINERS FOR 3
-- IGNORE ROLLFORWARD CONTAINER OPERATIONS
USING (
  FILE '/tmp/dms1' 1000
, FILE '/tmp/dms2' 1000
);
-- *****
-- ** Tablespace name = RAW
-- ** Tablespace ID = 4
-- ** Tablespace Type = Database managed space
-- ** Tablespace Content Type = Any data
-- ** Tablespace Page size (bytes) = 4096
-- ** Tablespace Extent size (pages) = 32
-- ** Using automatic storage = No

```

```

-- ** Auto-resize enabled = No
-- ** Total number of pages = 2000
-- ** Number of usable pages = 1960
-- ** High water mark (pages) = 96
-- *****
SET TABLESPACE CONTAINERS FOR 4
-- IGNORE ROLLFORWARD CONTAINER OPERATIONS
USING (
  DEVICE '/dev/hdb1' 1000
, DEVICE '/dev/hdb2' 1000
);
-- *****
-- ** start redirect restore
-- *****
RESTORE DATABASE TEST CONTINUE;
-- *****
-- ** end of file
-- *****

```

10. The following are examples of the RESTORE DB command using the SNAPSHOT option:

Restore log directory volumes from the snapshot image and do not prompt.

```
db2 restore db sample use snapshot LOGTARGET INCLUDE without prompting
```

Do not restore log directory volumes and do not prompt.

```
db2 restore db sample use snapshot LOGTARGET EXCLUDE without prompting
```

Do not restore log directory volumes and do not prompt. When LOGTARGET is not specified, then the default is LOGTARGET EXCLUDE.

```
db2 restore db sample use snapshot without prompting
```

Allow existing log directories in the current database to be overwritten and replaced when restoring the snapshot image containing conflicting log directories, without prompting.

```
db2 restore db sample use snapshot LOGTARGET EXCLUDE FORCE without prompting
```

Allow existing log directories in the current database to be overwritten and replaced when restoring the snapshot image containing conflicting log directories, without prompting.

```
db2 restore db sample use snapshot LOGTARGET INCLUDE FORCE without prompting
```

Usage notes

- A RESTORE DATABASE command of the form `db2 restore db <name>` will perform a full database restore with a database image and will perform a table space restore operation of the table spaces found in a table space image. A RESTORE DATABASE command of the form `db2 restore db <name> tablespace` performs a table space restore of the table spaces found in the image. In addition, if a list of table spaces is provided with such a command, the explicitly listed table spaces are restored.
- Following the restore operation of an online backup, you must perform a roll-forward recovery.
- If a backup image is compressed, the DB2 database system detects this and automatically decompresses the data before restoring it. If a library is specified on the `db2Restore` API, it is used for decompressing the data. Otherwise, a check is made to see if a library is stored in the backup image and if the library exists, it is used. Finally, if there is not library stored in the backup image, the data cannot be decompressed and the restore operation fails.
- If the compression library is to be restored from a backup image (either explicitly by specifying the `COMPRESSION LIBRARY` option or implicitly by performing a normal restore of a compressed backup), the restore operation must be done on the same platform and operating system that the backup was

taken on. If the platform the backup was taken on is not the same as the platform that the restore is being done on, the restore operation will fail, even if DB2 normally supports cross-platform restores involving the two systems.

- A backed up SMS tablespace can only be restored into a SMS tablespace. You cannot restore it into a DMS tablespace, or vice versa.
- To restore log files from the backup image that contains them, the LOGTARGET option must be specified, providing the fully qualified and valid path that exists on the DB2 server. If those conditions are satisfied, the restore utility will write the log files from the image to the target path. If a LOGTARGET is specified during a restore of a backup image that does not include logs, the restore operation will return an error before attempting to restore any table space data. A restore operation will also fail with an error if an invalid, or read-only, LOGTARGET path is specified.
- If any log files exist in the LOGTARGET path at the time the RESTORE DATABASE command is issued, a warning prompt will be returned to the user. This warning will not be returned if WITHOUT PROMPTING is specified.
- During a restore operation where a LOGTARGET is specified, if any log file cannot be extracted, the restore operation will fail and return an error. If any of the log files being extracted from the backup image have the same name as an existing file in the LOGTARGET path, the restore operation will fail and an error will be returned. The restore database utility will not overwrite existing log files in the LOGTARGET directory.
- You can also restore only the saved log set from a backup image. To indicate that only the log files are to be restored, specify the LOGS option in addition to the LOGTARGET path. Specifying the LOGS option without a LOGTARGET path will result in an error. If any problem occurs while restoring log files in this mode of operation, the restore operation will terminate immediately and an error will be returned.
- During an automatic incremental restore operation, only the log files included in the target image of the restore operation will be retrieved from the backup image. Any log files included in intermediate images referenced during the incremental restore process will not be extracted from those intermediate backup images. During a manual incremental restore operation, the LOGTARGET path should only be specified with the final restore command to be issued.
- Offline full database backups as well as offline incremental database backups can be restored to a later database version, whereas online backups cannot. For multi-partition databases, the catalog partition must first be restored individually, followed by the remaining database partitions (in parallel or serial). However, the implicit database upgrade done by the restore operation can fail. In a multi-partition database it can fail on one or more database partitions. In this case, you can follow the RESTORE DATABASE command with a single UPGRADE DATABASE command issued from the catalog partition to upgrade the database successfully.

Snapshot restore

Like a traditional (non-snapshot) restore, the default behavior when restoring a snapshot backup image will be to NOT restore the log directories —LOGTARGET EXCLUDE.

If the DB2 manager detects that any log directory's group ID is shared among any of the other paths to be restored, then an error is returned. In this case, LOGTARGET INCLUDE or LOGTARGET INCLUDE FORCE must be specified, as the log directories must be part of the restore.

The DB2 manager will make all efforts to save existing log directories (primary, mirror and overflow) before the restore of the paths from the backup image takes place.

If you wish the log directories to be restored and the DB2 manager detects that the pre-existing log directories on disk conflict with the log directories in the backup image, then the DB2 manager will report an error. In such a case, if you have specified LOGTARGET INCLUDE FORCE, then this error will be suppressed and the log directories from the image will be restored, deleting whatever existed beforehand.

There is a special case in which the LOGTARGET EXCLUDE option is specified and a log directory path resides under the database directory (i.e., /NODExxxx/SQLxxxx/SQLLOGDIR/). In this case, a restore would still overwrite the log directory as the database path, and all of the contents beneath it, would be restored. If the DB2 manager detects this scenario and log files exist in this log directory, then an error will be reported. If you specify LOGTARGET EXCLUDE FORCE, then this error will be suppressed and those log directories from the backup image will overwrite the conflicting log directories on disk.

Chapter 112. REWIND TAPE

Rewinds tapes for backup and restore operations to streaming tape devices. This command is only supported on Windows operating systems.

Authorization

One of the following:

- *sysadm*
- *sysctrl*
- *sysmaint*

Required connection

None

Command syntax

►► REWIND TAPE ON device ◄◄

Command parameters

ON *device*

Specifies a valid tape device name. The default value is \\.\TAPE0.

Chapter 113. ROLLFORWARD DATABASE

Recovers a database by applying transactions recorded in the database log files. Invoked after a database or a table space backup image has been restored, or if any table spaces have been taken offline by the database due to a media error. The database must be recoverable (that is, the **logarchmeth1** or **logarchmeth2** database configuration parameters must be set to a value other than OFF) before the database can be recovered with rollforward recovery.

Scope

In a partitioned database environment, this command can only be invoked from the catalog partition. A database or table space rollforward operation to a specified point in time affects all database partitions that are listed in the `db2nodes.cfg` file. A database or table space rollforward operation to the end of logs affects the database partitions that are specified. If no database partitions are specified, it affects all database partitions that are listed in the `db2nodes.cfg` file; if rollforward recovery is not needed on a particular partition, that partition is ignored.

For partitioned tables, you are also required to roll forward related table spaces to the same point in time. This applies to table spaces containing data partitions of a table. If a single table space contains a portion of a partitioned table, rolling forward to the end of the logs is still allowed.

It is not possible to roll forward through log files created on a previous DB2 release version. This is an important consideration when upgrading to a new DB2 release version.

Authorization

One of the following:

- *sysadm*
- *sysctrl*
- *sysmaint*

Required connection

None. This command establishes a database connection.

Command syntax

```
➤➤—ROLLFORWARD—

|          |
|----------|
| DATABASE |
| DB       |

—database-alias—

|                        |
|------------------------|
| USER— <i>username</i>  |
| USING— <i>password</i> |

➤➤
```

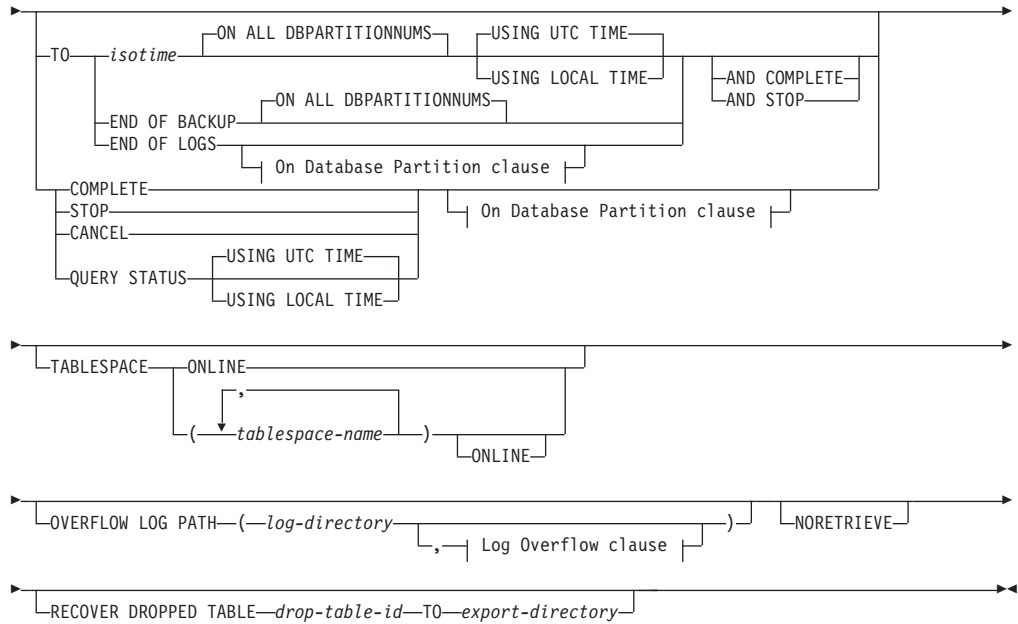

On Database Partition clause:

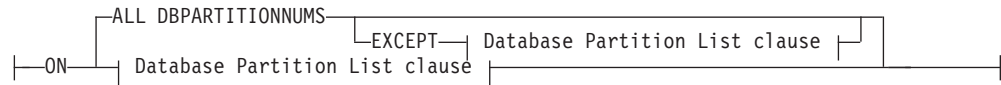

Database Partition List clause:



Log Overflow clause:

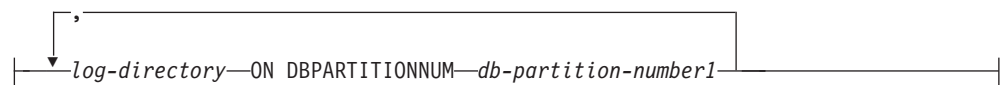

Command parameters

DATABASE *database-alias*

The alias of the database that is to be rollforward recovered.

USER *username*

The user name under which the database is to be rollforward recovered.

USING *password*

The password used to authenticate the user name. If the password is omitted, you will be prompted to enter it.

TO

isotime The point in time to which all committed transactions are to be rolled forward (including the transaction committed precisely at that time, as well as all transactions committed previously).

This value is specified as a time stamp, a 7-part character string that identifies a combined date and time. The format is *yyyy-mm-dd-hh.mm.ss* (year, month, day, hour, minutes, seconds), expressed in Coordinated Universal Time (UTC, formerly known as GMT). UTC helps to avoid having the same time stamp associated with different logs (because of a change in time associated with daylight savings time, for example). The time stamp in a backup image is based on the local time at which the backup operation started. The CURRENT TIMEZONE special register specifies the difference between UTC and local time at the application server. The difference is represented by a time duration (a decimal number in which the first two digits represent the number of hours, the next two digits represent the number of minutes, and the last two digits represent the number of seconds). Subtracting CURRENT TIMEZONE from a local time converts that local time to UTC.

USING UTC TIME

Allows you to rollforward to a point in time that is specified as UTC time. This is the default option.

USING LOCAL TIME

Allows you to rollforward to a point in time that is the server's local time rather than UTC time.

Note:

1. If you specify a local time for rollforward, all messages returned to you will also be in local time. All times are converted on the server, and in partitioned database environments, on the catalog database partition.
2. The timestamp string is converted to UTC on the server, so the time is local to the server's time zone, not the client's. If the client is in one time zone and the server in another, the server's local time should be used. This is different from the local time option from the Control Center, which is local to the client.
3. If the timestamp string is close to the time change of the clock due to daylight savings, it is important to know if the stop time is before or after the clock change, and specify it correctly.
4. Subsequent ROLLFORWARD commands that cannot specify the USING LOCAL TIME clause will have all messages returned to you in local time if this option is specified.
5. It is important to choose the USING LOCAL TIME or the USING UTC TIME (formerly known as GMT time) correctly. If not specified, the default is USING UTC TIME. Any mistake in the selection may cause rollforward to reach a different point in time than expected and truncate the logs after that point in time. Mistaking a local timestamp as a UTC timestamp may cause the required logs to be truncated undesirably and prevent further rollforwards to a point later than the mistaken time.

END OF LOGS

Specifies that all committed transactions from all online archive log files listed in the database configuration parameter **logpath** are to be applied.

END OF BACKUP

Specifies that all partitions in the partitioned database should be rolled forward to the *minimum recovery time*. See Examples section below for an example.

ALL DBPARTITIONNUMS | ON ALL DBPARTITIONNUMS

Specifies that transactions are to be rolled forward on all database partitions specified in the `db2nodes.cfg` file. This is the default if a database partition clause is not specified.

EXCEPT

Specifies that transactions are to be rolled forward on all database partitions specified in the `db2nodes.cfg` file, except those specified in the database partition list.

ON DBPARTITIONNUM | ON DBPARTITIONNUMS

Roll the database forward on a set of database partitions.

db-partition-number1

Specifies a database partition number in the database partition list.

db-partition-number2

Specifies the second database partition number, so that all database partitions from *db-partition-number1* up to and including *db-partition-number2* are included in the database partition list.

COMPLETE | STOP

Stops the rolling forward of log records, and completes the rollforward recovery process by rolling back any incomplete transactions and turning off the rollforward pending state of the database. This allows access to the database or table spaces that are being rolled forward. These keywords are equivalent; specify one or the other, but not both. The keyword AND permits specification of multiple operations at once; for example, `db2 rollforward db sample to end of logs and complete`. When rolling table spaces forward to a point in time, the table spaces are placed in backup pending state.

CANCEL

Cancels the rollforward recovery operation. This puts the database or one or more table spaces on all database partitions on which forward recovery has been started in restore pending state:

- If a *database* rollforward operation is not in progress (that is, the database is in rollforward pending state), this option puts the database in restore pending state.
- If a *table space* rollforward operation is not in progress (that is, the table spaces are in rollforward pending state), a table space list must be specified. All table spaces in the list are put in restore pending state.
- If a table space rollforward operation *is* in progress (that is, at least one table space is in rollforward in progress state), all table spaces that are in rollforward in progress state are put in restore pending state. If a table space list is specified, it must include all table spaces that are in rollforward in progress state. All table spaces on the list are put in restore pending state.

- If rolling forward to a point in time, any table space name that is passed in is ignored, and all table spaces that are in rollforward in progress state are put in restore pending state.
- If rolling forward to the end of the logs with a table space list, only the table spaces listed are put in restore pending state.

This option cannot be used to cancel a rollforward operation *that is actually running*. It can only be used to cancel a rollforward operation that is in progress but not actually running at the time. A rollforward operation can be in progress but not running if:

- It terminated abnormally.
- The STOP option was not specified.
- An error caused it to fail. Some errors, such as rolling forward through a non-recoverable load operation, can put a table space into restore pending state.

Use this option with caution, and only if the rollforward operation that is in progress cannot be completed because some of the table spaces have been put in rollforward pending state or in restore pending state. When in doubt, use the LIST TABLESPACES command to identify the table spaces that are in rollforward in progress state, or in rollforward pending state.

QUERY STATUS

Lists the log files that the database manager has rolled forward, the next archive file required, and the time stamp (in UTC) of the last committed transaction since rollforward processing began. In a partitioned database environment, this status information is returned for each database partition. The information returned contains the following fields:

Database partition number

Rollforward status

Status can be: database or table space rollforward pending, database or table space rollforward in progress, database or table space rollforward processing STOP, or not pending.

Next log file to be read

A string containing the name of the next required log file. In a partitioned database environment, use this information if the rollforward utility fails with a return code indicating that a log file is missing or that a log information mismatch has occurred.

Log files processed

A string containing the names of processed log files that are no longer needed for recovery, and that can be removed from the directory. If, for example, the oldest uncommitted transaction starts in log file x , the range of obsolete log files will not include x ; the range ends at $x - 1$. This field is not updated in case of a table space rollforward recovery operation.

Last committed transaction

A string containing a time stamp in ISO format ($yyyy-mm-dd-hh.mm.ss$) suffixed by either "UTC" or "Local" (see USING LOCAL TIME). This time stamp marks the last transaction committed after the completion of rollforward recovery. The time stamp applies to the database. For table space rollforward recovery, it is the time stamp of the last transaction committed to the database.

QUERY STATUS is the default value if the TO, STOP, COMPLETE, or CANCEL clauses are omitted. If TO, STOP, or COMPLETE was specified, status information is displayed if the command has completed successfully. If individual table spaces are specified, they are ignored; the status request does not apply only to specified table spaces.

TABLESPACE

This keyword is specified for table space-level rollforward recovery.

tablespace-name

Mandatory for table space-level rollforward recovery to a point in time. Allows a subset of table spaces to be specified for rollforward recovery to the end of the logs. In a partitioned database environment, each table space in the list does not have to exist at each database partition that is rolling forward. If it *does* exist, it must be in the correct state.

For partitioned tables, point in time roll-forward of a table space containing any piece of a partitioned table must also roll-forward all of the other table spaces in which that table resides to the same point in time. The table spaces containing the index partitions are included in the list of pieces of a partitioned table. Roll-forward to the end of the logs for a single table space containing a piece of a partitioned table is still allowed.

If a partitioned table has any attached or detached data partitions, then PIT rollforward must include all table spaces for these data partitions as well. To determine if a partitioned table has any attached, detached, or dropped data partitions, query the Status field of the SYSDATAPARTITIONS catalog table.

Because a partitioned table can reside in multiple table spaces, it will generally be necessary to roll forward multiple table spaces. Data that is recovered via dropped table recovery is written to the export directory specified in the ROLLFORWARD DATABASE command. It is possible to roll forward all table spaces in one command, or do repeated roll forward operations for subsets of the table spaces involved. If the ROLLFORWARD DATABASE command is done for one or a few table spaces, then all data from the table that resided in those table spaces will be recovered. A warning will be written to the notify log if the ROLLFORWARD DATABASE command did not specify the full set of the table spaces necessary to recover all the data for the table. Allowing rollforward of a subset of the table spaces makes it easier to deal with cases where there is more data to be recovered than can fit into a single export directory.

ONLINE

This keyword is specified to allow table space-level rollforward recovery to be done online. This means that other agents are allowed to connect while rollforward recovery is in progress.

OVERFLOW LOG PATH *log-directory*

Specifies an alternate log path to be searched for archived logs during recovery. Use this parameter if log files were moved to a location other than that specified by the **logpath** database configuration parameter. In a partitioned database environment, this is the (fully qualified) default overflow log path *for all database partitions*. A relative overflow log path can be specified for single-partition databases. The OVERFLOW LOG PATH command parameter will overwrite the value (if any) of the database configuration parameter **OVERFLOWLOGPATH**.

log-directory ON DBPARTITIONNUM

In a partitioned database environment, allows a different log path to override the default overflow log path for a specific database partition.

NORETRIEVE

Allows you to control which log files are to be rolled forward on the standby machine by allowing you to disable the retrieval of archived logs. The benefits of this are:

- By controlling the logfiles to be rolled forward, you can ensure that the standby machine is X hours behind the production machine, to avoid affecting both the systems.
- If the standby system does not have access to archive (eg. if TSM is the archive, it only allows the original machine to retrieve the files)
- It might also be possible that while the production system is archiving a file, the standby system is retrieving the same file, and it might then get an incomplete log file. Noretrieve would solve this problem.

RECOVER DROPPED TABLE *drop-table-id*

Recovers a dropped table during the rollforward operation. The table ID can be obtained using the LIST HISTORY command, in the Backup ID column of the output listing. For partitioned tables, the drop-table-id identifies the table as a whole, so that all data partitions of the table can be recovered in a single roll-forward command.

TO *export-directory*

Specifies a directory to which files containing the table data are to be written. The directory must be accessible to all database partitions.

Examples

Example 1

The ROLLFORWARD DATABASE command permits specification of multiple operations at once, each being separated with the keyword AND. For example, to roll forward to the end of logs, and complete, the separate commands:

```
db2 rollforward db sample to end of logs
db2 rollforward db sample complete
```

can be combined as follows:

```
db2 rollforward db sample to end of logs and complete
```

Although the two are equivalent, it is recommended that such operations be done in two steps. It is important to verify that the rollforward operation has progressed as expected, before stopping it and possibly missing logs. This is especially important if a bad log is found during rollforward recovery, and the bad log is interpreted to mean the “end of logs”. In such cases, an undamaged backup copy of that log could be used to continue the rollforward operation through more logs. However if the rollforward AND STOP option is used, and the rollforward encounters an error, the error will be returned to you. In this case, the only way to force the rollforward to stop and come online despite the error (that is, to come online at that point in the logs before the error) is to issue the ROLLFORWARD STOP command.

Example 2

Roll forward to the end of the logs (two table spaces have been restored):

```
db2 rollforward db sample to end of logs
db2 rollforward db sample to end of logs and stop
```

These two statements are equivalent. Neither AND STOP or AND COMPLETE is needed for table space rollforward recovery to the end of the logs. Table space names are not required. If not specified, all table spaces requiring rollforward recovery will be included. If only a subset of these table spaces is to be rolled forward, their names must be specified.

Example 3

After three table spaces have been restored, roll one forward to the end of the logs, and the other two to a point in time, both to be done online:

```
db2 rollforward db sample to end of logs tablespace(TBS1) online

db2 rollforward db sample to 1998-04-03-14.21.56 and stop
tablespace(TBS2, TBS3) online
```

Two rollforward operations cannot be run concurrently. The second command can only be invoked after the first rollforward operation completes successfully.

Example 4

After restoring the database, roll forward to a point in time, using OVERFLOW LOG PATH to specify the directory where the user exit saves archived logs:

```
db2 rollforward db sample to 1998-04-03-14.21.56 and stop
overflow log path (/logs)
```

Example 5 (partitioned database environments)

There are three database partitions: 0, 1, and 2. Table space TBS1 is defined on all database partitions, and table space TBS2 is defined on database partitions 0 and 2. After restoring the database on database partition 1, and TBS1 on database partitions 0 and 2, roll the database forward on database partition 1:

```
db2 rollforward db sample to end of logs and stop
```

This returns warning SQL1271 ("Database is recovered but one or more table spaces are off-line on database partition(s) 0 and 2.").

```
db2 rollforward db sample to end of logs
```

This rolls TBS1 forward on database partitions 0 and 2. The clause TABLESPACE(TBS1) is optional in this case.

Example 6 (partitioned database environments)

After restoring table space TBS1 on database partitions 0 and 2 only, roll TBS1 forward on database partitions 0 and 2:

```
db2 rollforward db sample to end of logs
```

Database partition 1 is ignored.

```
db2 rollforward db sample to end of logs tablespace(TBS1)
```

This fails, because TBS1 is not ready for rollforward recovery on database partition 1. Reports SQL4906N.

```
db2 rollforward db sample to end of logs on dbpartitionnums (0, 2)
tablespace(TBS1)
```

This completes successfully.

```
db2 rollforward db sample to 1998-04-03-14.21.56 and stop
tablespace(TBS1)
```

This fails, because TBS1 is not ready for rollforward recovery on database partition 1; all pieces must be rolled forward together. With table space rollforward to a point in time, the database partition clause is not accepted. The rollforward operation must take place on all the database partitions on which the table space resides.

After restoring TBS1 on database partition 1:

```
db2 rollforward db sample to 1998-04-03-14.21.56 and stop
tablespace(TBS1)
```

This completes successfully.

Example 7 (partitioned database environment)

After restoring a table space on all database partitions, roll forward to point in time 2, but do not specify AND STOP. The rollforward operation is still in progress. Cancel and roll forward to point in time 1:

```
db2 rollforward db sample to pit2 tablespace(TBS1)
db2 rollforward db sample cancel tablespace(TBS1)
```

```
** restore TBS1 on all database partitions **
```

```
db2 rollforward db sample to pit1 tablespace(TBS1)
db2 rollforward db sample stop tablespace(TBS1)
```

Example 8 (partitioned database environments)

Rollforward recover a table space that resides on eight database partitions (3 to 10) listed in the db2nodes.cfg file:

```
db2 rollforward database dwtest to end of logs tablespace (tssprodt)
```

This operation to the end of logs (not point in time) completes successfully. The database partitions on which the table space resides do not have to be specified. The utility defaults to the db2nodes.cfg file.

Example 9 (partitioned database environment)

Rollforward recover six small table spaces that reside on a single-partition database partition group (on database partition 6):

```
db2 rollforward database dwtest to end of logs on dbpartitionnum (6)
tablespace(tsstore, tssbuyer, tsstime, tsswhse, tsslscat, tssvendor)
```

This operation to the end of logs (not point in time) completes successfully.

Example 10 (partitioned database environment)

You can use the TO END OF BACKUP clause with the ROLLFORWARD command to roll forward all partitions in a partitioned database to the minimum recovery time. The minimum recovery time is the earliest point in time during a rollforward when a database is consistent (when the objects listed in the database catalogs match the objects that physically exist on disk). Manually determining the correct point in time to which to roll forward a database is difficult, particularly for a partitioned database. The END OF BACKUP option makes it easy.

db2 rollforward db sample to end of backup and complete

Usage notes

If restoring from an image that was created during an online backup operation, the specified point in time for the rollforward operation must be later than the time at which the online backup operation completed. If the rollforward operation is stopped before it passes this point, the database is left in rollforward pending state. If a table space is in the process of being rolled forward, it is left in rollforward in progress state.

If one or more table spaces is being rolled forward to a point in time, the rollforward operation must continue at least to the minimum recovery time, which is the last update to the system catalogs for this table space or its tables. The minimum recovery time (in Coordinated Universal Time, or UTC) for a table space can be retrieved using the LIST TABLESPACES SHOW DETAIL command.

Rolling databases forward might require a load recovery using tape devices. If prompted for another tape, you can respond with one of the following:

- c** Continue. Continue using the device that generated the warning message (for example, when a new tape has been mounted)
- d** Device terminate. Stop using the device that generated the warning message (for example, when there are no more tapes)
- t** Terminate. Take all affected table spaces offline, but continue rollforward processing.

If the rollforward utility cannot find the next log that it needs, the log name is returned in the SQLCA, and rollforward recovery stops. If no more logs are available, use the STOP option to terminate rollforward recovery. Incomplete transactions are rolled back to ensure that the database or table space is left in a consistent state.

Note: Rolling forward through a redistribute operation cannot restore the database content since log records are not recorded for data redistribution. See the “REDISTRIBUTE DATABASE PARTITION GROUP command”.

Compatibilities

For compatibility with versions earlier than Version 8:

- The keyword NODE can be substituted for DBPARTITIONNUM.
- The keyword NODES can be substituted for DBPARTITIONNUMS.
- Point in time rollforward is not supported with pre-V9.1 clients due to V9.1 support for partitioned tables.

Chapter 114. RUNCMD

Executes a specified command from the CLP interactive mode command history.

Scope

This command can only be run within CLP interactive mode. Specifically, it cannot be run from the CLP command mode or the CLP batch mode.

Authorization

None

Required connection

The required connection will depend on the command being executed.

Command syntax

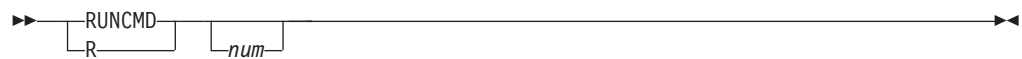

Command parameters

num If *num* is positive, executes the command corresponding to *num* in the command history. If *num* is negative, executes the command corresponding to *num*, counting backwards from the most recent command in the command history. Zero is not a valid value for *num*. If this parameter is not specified, executes the most recently run command. (This is equivalent to specifying a value of -1 for *num*).

Usage notes

1. Typically, you would execute the HISTORY command to see a list of recently executed commands and then execute the RUNCMD to execute a command from this list.
2. The RUNCMD command is not recorded in the command history, but the command executed by the RUNCMD command is recorded in the command history.

Chapter 115. RUNSTATS

Updates statistics about the characteristics of a table and/or associated indexes, or statistical views. These characteristics include number of records, number of pages, and average record length. The optimizer uses these statistics when determining access paths to the data.

For a table, this utility should be called when the table has had many updates, or after reorganizing the table. For a statistical view, this utility should be called when changes to underlying tables have substantially affected the rows returned by the view. The view must have been previously enabled for use in query optimization using the ALTER VIEW command.

Scope

This command can be issued from any database partition in the `db2nodes.cfg` file. It can be used to update the catalogs on the catalog database partition.

For tables, this command collects statistics for a table on the database partition from which it is invoked. If the table does not exist on that database partition, the first database partition in the database partition group is selected.

For views, this command collects statistics using data from tables on all participating database partitions.

Authorization

For tables, one of the following:

- *sysadm*
- *sysctrl*
- *sysmaint*
- *dbadm*
- *sqladm*
- CONTROL privilege on the table
- LOAD authority

You do not need any explicit privilege to use this command on any declared temporary table that exists within its connection.

For statistical views, one of the following:

- *sysadm*
- *sysctrl*
- *sysmaint*
- *dbadm*
- *sqladm*
- CONTROL privilege on the statistical view

In addition, you need to have appropriate privileges to access rows from the statistical view. Specifically, for each table, statistical view or nickname referenced in the statistical view definition, the user must have one of the following privileges:

- *dataaccess*
- CONTROL
- SELECT

Required connection

Database

Command syntax

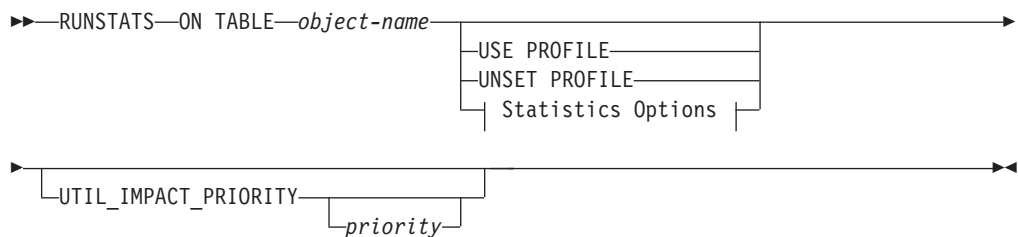

Statistics Options:

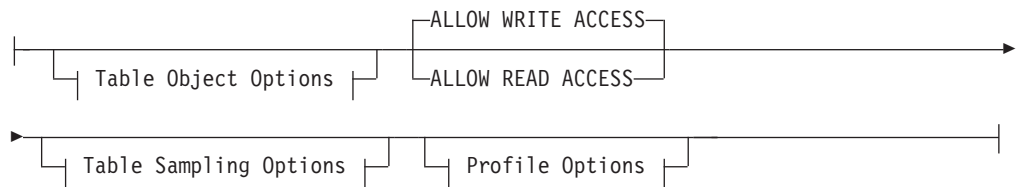

Table Object Options:

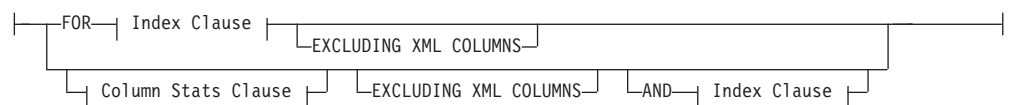
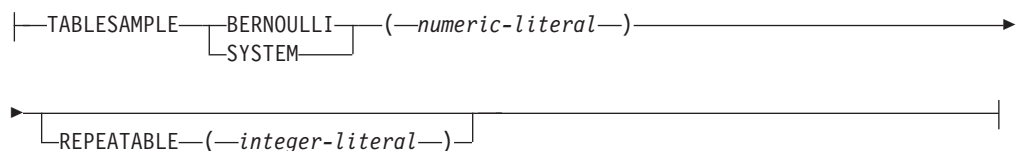

Table Sampling Options:



Profile Options:



Index Clause:

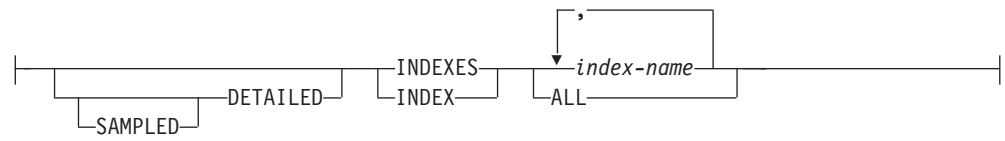

Column Stats Clause:

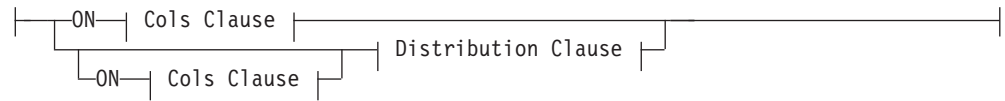

Distribution Clause:

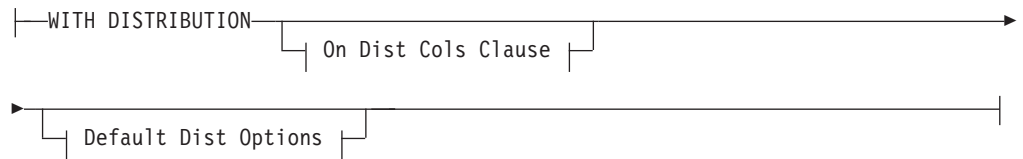

On Cols Clause:

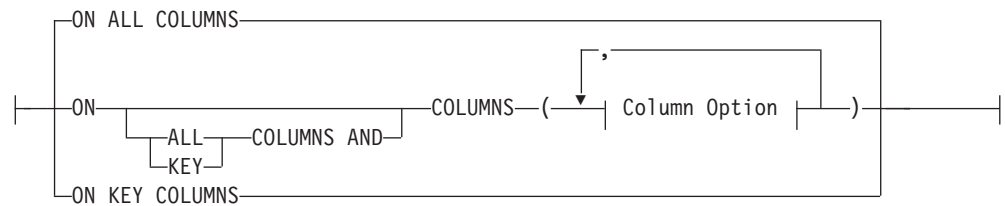

On Dist Cols Clause:

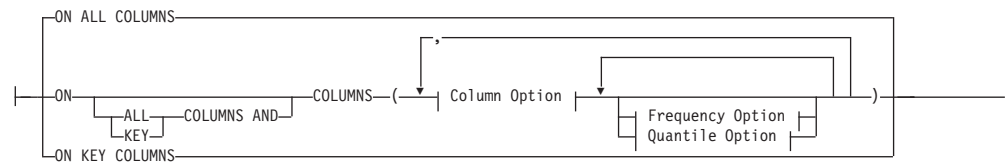

Default Dist Option:

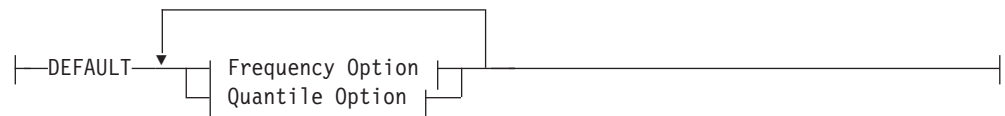

Frequency Option:



Quantile Option:

|—NUM_QUANTILES—*integer*—|

Column Option:

|—*column-name*—|
|—LIKE STATISTICS—|
|—, —|
|—(*column-name*)—|

Command parameters

object-name

Identifies the table or statistical view on which statistics are to be collected. It must not be a hierarchy table. For typed tables, *object-name* must be the name of the root table of the table hierarchy. The fully qualified name or alias in the form: *schema.object-name* must be used. The schema is the user name under which the table was created.

index-name

Identifies an existing index defined on the table. The fully qualified name in the form *schema.index-name* must be used. This option cannot be used for views.

USE PROFILE

This option allows RUNSTATS to employ a previously stored statistics profile to gather statistics for a table or statistical view. The statistics profile is created using the SET PROFILE options and is updated using the UPDATE PROFILE options.

UNSET PROFILE

Specify this option to remove an existing statistics profile. For example,
runstats on tablemyschema.mytable unset profile

FOR INDEXES

Collects and updates statistics for the indexes only. If no table statistics had been previously collected on the table, basic table statistics are also collected. These basic statistics do not include any distribution statistics. This option cannot be used for views.

AND INDEXES

Collects and updates statistics for both the table and the indexes. This option cannot be used for views.

DETAILED

Calculates extended index statistics. These are the CLUSTERFACTOR and PAGE_FETCH_PAIRS statistics that are gathered for relatively large indexes. This option cannot be used for views.

SAMPLED

This option, when used with the DETAILED option, allows RUNSTATS to employ a CPU sampling technique when compiling the extended index statistics. If the option is not specified, every entry in the index is examined to compute the extended index statistics. This option cannot be used for views.

ON ALL COLUMNS

To collect statistics on all eligible columns, use the ON ALL COLUMNS clause. Columns can be specified either for basic statistics collection (On Cols clause) or in conjunction with the WITH DISTRIBUTION clause (On Dist Cols Clause). The ON ALL COLUMNS specification is the default option if neither of the column specific clauses are specified.

If it is specified in the On Cols Clause, all columns will have only basic column statistics collected unless specific columns are chosen as part of the WITH DISTRIBUTION clause. Those columns specified as part of the WITH DISTRIBUTION clause will also have basic and distribution statistics collected.

If the WITH DISTRIBUTION ON ALL COLUMNS is specified both basic statistics and distribution statistics are collected for all eligible columns. Anything specified in the On Cols Clause is redundant and therefore not necessary.

ON COLUMNS

This clause allows the user to specify a list of columns for which to collect statistics. If you specify group of columns, the number of distinct values for the group will be collected. When you run RUNSTATS on a table without gathering index statistics, and specify a subset of columns for which statistics are to be gathered, then:

1. Statistics for columns not specified in the RUNSTATS command but which are the first column in an index are NOT reset.
2. Statistics for all other columns not specified in the RUNSTATS command are reset.

This clause can be used in the On Cols Clause and the On Dist Cols Clause. Collecting distribution statistics for a group of columns is not currently supported.

If XML type columns are specified in a column group, the XML type columns will be ignored for the purpose of collecting distinct values for the group. However, basic XML column statistics will be collected for the XML type columns in the column group.

EXCLUDING XML COLUMNS

This clause allows you to omit all XML type columns from statistics collection. This clause facilitates the collection of statistics on non-XML columns because the inclusion of XML data can require greater system resources. The EXCLUDING XML COLUMNS clause takes precedence over other clauses that specify XML columns for statistics collection. For example, if you use the EXCLUDING XML COLUMNS clause, and you also specify XML type columns with the ON COLUMNS clause or you use the ON ALL COLUMNS clause, all XML type columns will be ignored during statistics collection.

ON KEY COLUMNS

Instead of listing specific columns, you can choose to collect statistics on columns that make up all the indexes defined on the table. It is assumed here that critical columns in queries are also those used to create indexes on the table. If there are no indexes on the table, it is as good as an empty list and no column statistics will be collected. It can be used in the on-cols-clause or the on-dist-cols-clause. It is redundant in the on-cols-clause if specified in both clauses since the WITH DISTRIBUTION clause is used to specify collection of both basic and distribution statistics. XML type columns are by definition not a key

column and will not be included for statistics collection by the ON KEY COLUMNS clause. This option cannot be used for views.

column-name

Name of a column in the table or statistical view. If you specify the name of an ineligible column for statistics collection, such as a non-existent column or a mistyped column name, error (-205) is returned. Two lists of columns can be specified, one without distribution and one with distribution. If the column is specified in the list that is not associated with the WITH DISTRIBUTION clause only basic column statistics will be collected. If the column appears in both lists, distribution statistics will be collected (unless NUM_FREQVALUES and NUM_QUANTILES are set to zero).

NUM_FREQVALUES

Defines the maximum number of frequency values to collect. It can be specified for an individual column in the ON COLUMNS clause. If the value is not specified for an individual column, the frequency limit value will be picked up from that specified in the DEFAULT clause. If it is not specified there either, the maximum number of frequency values to be collected will be what is set in the NUM_FREQVALUES database configuration parameter.

NUM_QUANTILES

Defines the maximum number of distribution quantile values to collect. It can be specified for an individual column in the ON COLUMNS clause. If the value is not specified for an individual column, the quantile limit value will be picked up from that specified in the DEFAULT clause. If it is not specified there either, the maximum number of quantile values to be collected will be what is set in the NUM_QUANTILES database configuration parameter.

WITH DISTRIBUTION

This clause specifies that both basic statistics and distribution statistics are to be collected on the columns. If the ON COLUMNS clause is not specified, distribution statistics are collected on all the columns of the table or statistical view (excluding columns that are ineligible such as CLOB and LONG VARCHAR). If the ON COLUMNS clause is specified, distribution statistics are collected only on the column list provided (excluding those ineligible for statistics collection). If the clause is not specified, only basic statistics are collected.

Collection of distribution statistics on column groups is currently not supported; distribution statistics will not be collected when column groups are specified in the WITH DISTRIBUTION ON COLUMNS clause.

DEFAULT

If NUM_FREQVALUES or NUM_QUANTILES are specified, these values will be used to determine the maximum number of frequency and quantile statistics to be collected for the columns, if these are not specified for individual columns in the ON COLUMNS clause. If the DEFAULT clause is not specified, the values used will be those in the corresponding database configuration parameters.

LIKE STATISTICS

When this option is specified additional column statistics are collected. These statistics are the SUB_COUNT and the SUB_DELIM_LENGTH statistics in SYSSTAT.COLUMNS. The statistics are collected for columns of type CHAR and VARCHAR with a code page attribute of single-byte character set

(SBCS), FOR BIT DATA, or UTF-8. They are used by the query optimizer to improve the selectivity estimates for predicates of the type "column LIKE '%xyz'" and "column LIKE '%xyz%'"

ALLOW WRITE ACCESS

Specifies that other users can read from and write to the table(s) while statistics are calculated. For statistical views, these are the base tables referenced in the view definition.

The ALLOW WRITE ACCESS option is not recommended for tables that will have a lot of inserts, updates or deletes occurring concurrently. The RUNSTATS command first performs table statistics and then performs index statistics. Changes in the table's state between the time that the table and index statistics are collected might result in inconsistencies. Although having up-to-date statistics is important for the optimization of queries, it is also important to have consistent statistics. Therefore, statistics should be collected at a time when inserts, updates or deletes are at a minimum.

ALLOW READ ACCESS

Specifies that other users can have read-only access to the table(s) while statistics are calculated. For statistical views, these are the base tables referenced in the view definition.

TABLESAMPLE BERNOULLI

This option allows RUNSTATS to collect statistics on a sample of the rows from the table or statistical view. BERNOULLI sampling considers each row individually, including that row with probability P/100 (where P is the value of numeric-literal) and excluding it with probability 1-P/100. Thus, if the numeric-literal were evaluated to be the value 10, representing a 10 percent sample, each row would be included with probability 0.1 and be excluded with probability 0.9. Unless the optional REPEATABLE clause is specified, each execution of RUNSTATS will usually yield a different such sample of the table. All data pages will be retrieved through a table scan but only the percentage of rows as specified through the numeric-literal parameter will be used for the statistics collection.

TABLESAMPLE SYSTEM

This option allows RUNSTATS to collect statistics on a sample of the data pages from the table(s). SYSTEM sampling considers each page individually, including that page with probability P/100 (where P is the value of numeric-literal) and excluding it with probability 1-P/100. Unless the optional REPEATABLE clause is specified, each execution of RUNSTATS will usually yield a different such sample of the table. The size of the sample is controlled by the numeric-literal parameter in parentheses, representing an approximate percentage P of the table to be returned. Only a percentage of the data pages as specified through the numeric-literal parameter will be retrieved and used for the statistics collection.

On statistical views, SYSTEM sampling is restricted to views whose definitions are a select over a single base table. If the view contains multiple tables, SYSTEM sampling is also possible if:

- the tables are joined using equality predicates on all the primary key and foreign key columns included in a referential integrity constraint defined between the tables,
- no search condition filters rows in any parent tables in the relationship, and
- a single child table, that is also not a parent table, can be identified among all the tables.

If the statistical view does not meet those conditions, BERNOULLI sampling will be used instead and a warning will be returned (SQL2317W).

REPEATABLE (*integer-literal*)

Adding the REPEATABLE clause to the TABLESAMPLE clause ensures that repeated executions of RUNSTATS return the same sample. The *integer-literal* parameter is a non-negative integer representing the seed to be used in sampling. Passing a negative seed will result in an error (SQL1197N). The sample set might still vary between repeatable RUNSTATS invocations if activity against the table or statistical view resulted in changes to the table or statistical view data since the last time TABLESAMPLE REPEATABLE was run. Also, the method by which the sample was obtained as specified by the BERNOULLI or SYSTEM keyword, must also be the same to ensure consistent results.

numeric-literal

The numeric-literal parameter specifies the size of the sample to be obtained, as a percentage P. This value must be a positive number that is less than or equal to 100, and can be between 1 and 0. For example, a value of 0.01 represents one one-hundredth of a percent, such that 1 row in 10,000 would be sampled, on average. A value of 0 or 100 will be treated by the DB2 database system as if sampling was not specified, regardless of whether TABLESAMPLE BERNOULLI or TABLESAMPLE SYSTEM is specified. A value greater than 100 or less than 0 will be treated by DB2 as an error (SQL1197N).

SET PROFILE NONE

Specifies that no statistics profile will be set for this RUNSTATS invocation.

SET PROFILE

Allows RUNSTATS to generate and store a specific statistics profile in the system catalog tables and executes the RUNSTATS command options to gather statistics.

SET PROFILE ONLY

Allows RUNSTATS to generate and store a specific statistics profile in the system catalog tables without running the RUNSTATS command options.

UPDATE PROFILE

Allows RUNSTATS to modify an existing statistics profile in the system catalog tables, and runs the RUNSTATS command options of the updated statistics profile to gather statistics.

UPDATE PROFILE ONLY

Allows RUNSTATS to modify an existing statistics profile in the system catalog tables without running the RUNSTATS command options of the updated statistics profile.

UTIL_IMPACT_PRIORITY *priority*

Specifies that RUNSTATS will be throttled at the level specified by *priority*. *priority* is a number in the range of 1 to 100, with 100 representing the highest priority and 1 representing the lowest. The priority specifies the amount of throttling to which the utility is subjected. All utilities at the same priority undergo the same amount of throttling, and utilities at lower priorities are throttled more than those at higher priorities. If *priority* is not specified, the RUNSTATS will have the default priority of 50. Omitting the UTIL_IMPACT_PRIORITY keyword will invoke the RUNSTATS utility without throttling support. If the UTIL_IMPACT_PRIORITY keyword is

specified, but the **util_impact_lim** configuration parameter is set to 100, then the utility will run unthrottled. This option cannot be used for views.

In a partitioned database, when used on tables, the RUNSTATS command collects the statistics on only a single database partition. If the database partition from which the RUNSTATS command is executed has a partition of the table, then the command executes on that database partition. Otherwise, the command executes on the first database partition in the database partition group across which the table is partitioned.

Examples

1. Collect statistics on the table only, on all columns without distribution statistics:

```
RUNSTATS ON TABLE db2user.employee
```

2. Collect statistics on the table only, on columns empid and empname with distribution statistics:

```
RUNSTATS ON TABLE db2user.employee  
WITH DISTRIBUTION ON COLUMNS (empid, empname)
```

3. Collect statistics on the table only, on all columns with distribution statistics using a specified number of frequency limit for the table while picking the NUM_QUANTILES from the configuration setting:

```
RUNSTATS ON TABLE db2user.employee WITH DISTRIBUTION DEFAULT  
NUM_FREQVALUES 50
```

4. Collect statistics on a set of indexes:

```
RUNSTATS ON TABLE db2user.employee FOR INDEXES  
db2user.emp11, db2user.emp12
```

5. Collect basic statistics on all indexes only:

```
RUNSTATS ON TABLE db2user.employee FOR INDEXES ALL
```

6. Collect basic statistics on the table and all indexes using sampling for the detailed index statistics collection:

```
RUNSTATS ON TABLE db2user.employee AND SAMPLED DETAILED INDEXES ALL
```

7. Collect statistics on table, with distribution statistics on columns empid, empname and empdept and the two indexes Xempid and Xempname. Distribution statistics limits are set individually for empdept, while the other two columns use a common default:

```
RUNSTATS ON TABLE db2user.employee  
WITH DISTRIBUTION ON COLUMNS (empid, empname, empdept NUM_FREQVALUES  
50 NUM_QUANTILES 100)  
DEFAULT NUM_FREQVALUES 5 NUM_QUANTILES 10  
AND INDEXES db2user.Xempid, db2user.Xempname
```

8. Collect statistics on all columns used in indexes and on all indexes:

```
RUNSTATS ON TABLE db2user.employee ON KEY COLUMNS AND INDEXES ALL
```

9. Collect statistics on all indexes and all columns without distribution except for one column. Consider T1 containing columns c1, c2, ..., c8

```
RUNSTATS ON TABLE db2user.T1  
WITH DISTRIBUTION ON COLUMNS (c1, c2, c3 NUM_FREQVALUES 20  
NUM_QUANTILES 40, c4, c5, c6, c7, c8)  
DEFAULT NUM_FREQVALUES 0, NUM_QUANTILES 0 AND INDEXES ALL
```

```
RUNSTATS ON TABLE db2user.T1  
WITH DISTRIBUTION ON COLUMNS (c3 NUM_FREQVALUES 20 NUM_QUANTILES 40)  
AND INDEXES ALL
```

10. Collect statistics on table T1 for the individual columns c1 and c5 as well as on the column combinations (c2, c3) and (c2, c4). Multi-column cardinality is

very useful to the query optimizer when it estimates filter factors for predicates on columns in which the data is correlated.

```
RUNSTATS ON TABLE db2user.T1 ON COLUMNS (c1, (c2, c3),  
      (c2, c4), c5)
```

11. Collect statistics on table T1 for the individual columns c1 and c2. For column c1 also collect the LIKE predicate statistics.

```
RUNSTATS ON TABLE db2user.T1 ON COLUMNS (c1 LIKE STATISTICS, c2)
```

12. Register a statistics profile to collect statistics on the table only, on all columns with distribution statistics using a specified number of frequency limit for the table while picking the NUM_QUANTILES from the configuration setting. The command also updates the statistics as specified.

```
RUNSTATS ON TABLE db2user.employee WITH DISTRIBUTION DEFAULT  
      NUM_FREQVALUES 50 SET PROFILE
```

13. Register a statistics profile to collect statistics on the table only, on all columns with distribution statistics using a specified number of frequency limit for the table while picking the NUM_QUANTILES from the configuration setting. Statistics are not collected.

```
RUNSTATS ON TABLE db2user.employee WITH DISTRIBUTION  
      DEFAULT NUM_FREQVALUES 50 SET PROFILE ONLY
```

14. Modify the previously registered statistics profile by changing the NUM_FREQVALUES value from 50 to 30. The command also updates the statistics as specified.

```
RUNSTATS ON TABLE db2user.employee WITH DISTRIBUTION  
      DEFAULT NUM_FREQVALUES 30 UPDATE PROFILE
```

15. Modify the previously registered statistics profile by changing the NUM_FREQVALUES value from 50 to 30. Statistics are not collected.

```
RUNSTATS ON TABLE db2user.employee WITH DISTRIBUTION  
      DEFAULT NUM_FREQVALUES 30 UPDATE PROFILE ONLY
```

16. Modify the previously registered statistics profile by adding column emp1_address and column group (emp1_title, emp1_salary) options. The command also updates the statistics as specified.

```
RUNSTATS ON TABLE db2user.employee  
      ON COLUMNS (emp1_address, (emp1_title, emp1_salary))  
      UPDATE PROFILE
```

17. Modify the previously registered statistics profile by adding column emp1_address and column group (emp1_title, emp1_salary) options. Statistics are not collected.

```
RUNSTATS ON TABLE db2user.employee  
      ON COLUMNS (emp1_address, (emp1_title, emp1_salary))  
      UPDATE PROFILE ONLY
```

18. Collect statistics on a table using the options recorded in the statistics profile for that table:

```
RUNSTATS ON TABLE db2user.employee USE PROFILE
```

19. Query the RUNSTATS command options corresponding to the previously registered statistics profile stored in the catalogs of the table:

```
SELECT STATISTICS_PROFILE FROM SYSIBM.SYSTABLES WHERE NAME =  
      'EMPLOYEE'
```

20. Collect statistics, including distribution statistics, on 30 percent of the rows:

```
RUNSTATS ON TABLE db2user.employee WITH DISTRIBUTION  
      TABLESAMPLE BERNOULLI(30)
```

21. To control the sample set on which statistics will be collected and to be able to repeatedly use the same sample set, you can do so as follows:

```
RUNSTATS ON TABLE db2user.employee WITH DISTRIBUTION
TABLESAMPLE BERNOULLI(30) REPEATABLE(4196)
```

Issuing the same statement as above will result in the same set of statistics as long as the data has not changed in the interim.

22. Collect index statistics as well as table statistics on 1.5 percent of the data pages. Only table data pages and not index pages are sampled. In this example 1.5 percent of table data pages are used for the collection of table statistics, while for index statistics all the index pages will be used:

```
RUNSTATS ON TABLE db2user.employee AND INDEXES ALL TABLESAMPLE SYSTEM(1.5)
```

23. Collect statistics for a statistical view, on all columns, without distribution statistics:

```
RUNSTATS ON TABLE salesdb.product_sales_view
```

24. Collect statistics for a statistical view, with distribution statistics on the columns category, type and product_key. Distribution statistics limits are set for the category column, while the other columns use a common default:

```
RUNSTATS ON TABLE salesdb.product_sales_view
WITH DISTRIBUTION ON COLUMNS (category NUM_FREQVALUES 100 NUM_QUANTILES 100,
type, product_key) DEFAULT NUM_FREQVALUES 50 NUM_QUANTILES 50
```

25. Collect statistics, including distribution statistics, on 10 percent of the rows using row level sampling:

```
RUNSTATS ON TABLE db2user.daily_sales
WITH DISTRIBUTION TABLESAMPLE BERNOULLI (10)
```

26. Collect statistics, including distribution statistics, on 2.5 percent of the rows using data page level sampling. Additionally, specify the repeated use of the same sample set. For this command to succeed, the query must be such that the DB2 database system can successfully push data page sampling down to one or more tables. Otherwise, an error (SQL 20288N) is issued.

```
RUNSTATS ON TABLE db2user.daily_sales
WITH DISTRIBUTION TABLESAMPLE SYSTEM (2.5)
```

27. Register a statistics profile to collect statistics on the view and on all columns with distribution statistics as specified:

```
RUNSTATS ON TABLE salesdb.product_sales_view
WITH DISTRIBUTION DEFAULT NUM_FREQVALUES 50 NUM_QUANTILES 50
SET PROFILE
```

28. Modify the previously registered statistics profile. This command also updates the statistics as specified:

```
RUNSTATS ON TABLE salesdb.product_sales_view
WITH DISTRIBUTION DEFAULT NUM_FREQVALUES 25 NUM_QUANTILES 25
UPDATE PROFILE
```

Usage notes

1. When there are detached partitions on a partitioned table, index keys that still belong to detached data partitions which require cleanup will not be counted as part of the keys in the statistics. These keys are not counted because they are invisible and no longer part of the table. They will eventually get removed from the index by asynchronous index cleanup. As a result, statistics collected before asynchronous index cleanup is run will be misleading. If the RUNSTATS command is issued before asynchronous index cleanup completes, it will likely generate a false alarm for index reorganization or index cleanup based on the inaccurate statistics. Once asynchronous index cleanup is run, all the index keys that still belong to detached data partitions which require cleanup will be removed and this may eliminate the need for index reorganization.

For partitioned tables, you are encouraged to issue the RUNSTATS command after an asynchronous index cleanup has completed in order to generate accurate index statistics in the presence of detached data partitions. To determine whether or not there are detached data partitions in the table, you can check the status field in the SYSDATAPARTITIONS table and look for the value I (index cleanup) or D (detached with dependant MQT).

The RUNSTATS command collects statistics for all index partitions of a partitioned index. Statistics in the SYSTAT.INDEXES view for the partitioned index represent an index partition, except for FIRSTKEYCARD, FIRST2KEYCARD, FIRST3KEYCARD, FIRST4KEYCARD, and FULLKEYCARD statistics. Because these statistics are used in cardinality estimates, they are for the entire index and not for an index partition. Distribution statistics (frequent values and quantiles) are not collected for partitioned indexes, but are gathered if RUNSTATS is run on the table. Statistics on the leading columns of a partitioned index might not be as accurate as statistics on the leading columns of a nonpartitioned index.

2. It is recommended to run the RUNSTATS command:
 - On tables that have been modified considerably (for example, if a large number of updates have been made, or if a significant amount of data has been inserted or deleted or if LOAD has been done without the statistics option during LOAD).
 - On tables that have been reorganized (using REORG, REDISTRIBUTE DATABASE PARTITION GROUP).
 - On tables which have been row compressed.
 - When a new index has been created.
 - Before binding applications whose performance is critical.
 - When the prefetch quantity is changed.
 - On statistical views whose underlying tables have been modified substantially so as to change the rows that are returned by the view.
 - After LOAD has been executed with the STATISTICS option, use the RUNSTATS utility to collect statistics on XML columns. Statistics for XML columns are never collected during LOAD, even when LOAD is executed with the STATISTICS option. When RUNSTATS is used to collect statistics for XML columns only, existing statistics for non-XML columns that have been collected by LOAD or a previous execution of the RUNSTATS utility are retained. In the case where statistics on some XML columns have been collected previously, the previously collected statistics for an XML column will either be dropped if no statistics on that XML column are collected by the current command, or be replaced if statistics on that XML column are collected by the current command.
3. The options chosen must depend on the specific table and the application. In general:
 - If the table is a very critical table in critical queries, is relatively small, or does not change too much and there is not too much activity on the system itself, it might be worth spending the effort on collecting statistics in as much detail as possible.
 - If the time to collect statistics is limited, if the table is relatively large, or if the table is updated frequently, it might be beneficial to execute RUNSTATS limited to the set of columns that are used in predicates. This way, you will be able to execute the RUNSTATS command more often.
 - If time to collect statistics is very limited and the effort to tailor the RUNSTATS command on a table by table basis is a major issue, consider

collecting statistics for the "KEY" columns only. It is assumed that the index contains the set of columns that are critical to the table and are most likely to appear in predicates.

- If time to collect statistics is very limited and table statistics are to be gathered, consider using the TABLESAMPLE option to collect statistics on a subset of the table data.
 - If there are many indexes on the table and DETAILED (extended) information on the indexes might improve access plans, consider the SAMPLED option to reduce the time it takes to collect statistics.
 - If there is skew in certain columns and predicates of the type "column = constant", it might be beneficial to specify a larger NUM_FREQVALUES value for that column
 - Collect distribution statistics for all columns that are used in equality predicates and for which the distribution of values might be skewed.
 - For columns that have range predicates (for example "column >= constant", "column BETWEEN constant1 AND constant2") or of the type "column LIKE '%xyz'", it might be beneficial to specify a larger NUM_QUANTILES value.
 - If storage space is a concern and one cannot afford too much time on collecting statistics, do not specify high NUM_FREQVALUES or NUM_QUANTILES values for columns that are not used in predicates.
 - If index statistics are requested, and statistics have never been run on the table containing the index, statistics on both the table and indexes are calculated.
 - If statistics for XML columns in the table are not required, the EXCLUDING XML COLUMNS option can be used to exclude all XML columns. This option takes precedence over all other clauses that specify XML columns for statistics collection.
4. After the command is run note the following:
 - A COMMIT should be issued to release the locks.
 - To allow new access plans to be generated, the packages that reference the target table must be rebound.
 - Executing the command on portions of the table could result in inconsistencies as a result of activity on the table since the command was last issued. In this case a warning message is returned. Issuing RUNSTATS on the table only might make table and index level statistics inconsistent. For example, you might collect index level statistics on a table and later delete a significant number of rows from the table. If you then issue RUNSTATS on the table only, the table cardinality might be less than FIRSTKEYCARD, which is an inconsistency. In the same way, if you collect statistics on a new index when you create it, the table level statistics might be inconsistent.
 5. The RUNSTATS command will drop previously collected distribution statistics if table statistics are requested. For example, RUNSTATS ON TABLE, or RUNSTATS ON TABLE ... AND INDEXES ALL will cause previously collected distribution statistics to be dropped. If the command is run on indexes only then previously collected distribution statistics are retained. For example, RUNSTATS ON TABLE ... FOR INDEXES ALL will cause the previously collected distribution statistics to be retained. If the RUNSTATS command is run on XML columns only, then previously collected basic column statistics and distribution statistics are retained. In the case where statistics on some XML columns have been collected previously, the previously collected statistics for an XML column will either be dropped if no statistics on that

XML column are collected by the current command, or be replaced if statistics on that XML column are collected by the current command.

6. For range-clustered tables, there is a special system-generated index in the catalog tables which represents the range ordering property of range-clustered tables. When statistics are collected on this type of table, if the table is to be included as part of the statistics collection, statistics will also be collected for the system-generated index. The statistics reflect the fast access of the range lookups by representing the index as a two-level index with as many pages as the base data table, and having the base data clustered perfectly along the index order.
7. In the On Dist Cols Clause of the command syntax, the Frequency Option and Quantile Option parameters are currently not supported for Column GROUPS. These options are supported for single columns.
8. There are three prefetch statistics that cannot be computed when working in DMS mode. When looking at the index statistics in the index catalogs, you will see a -1 value for the following statistics:
 - AVERAGE_SEQUENCE_FETCH_PAGES
 - AVERAGE_SEQUENCE_FETCH_GAP
 - AVERAGE_RANDOM_FETCH_PAGES
9. RUNSTATS sampling through TABLESAMPLE only occurs with table data pages and not index pages. When index statistics as well as sampling is requested, all the index pages are scanned for statistics collection. It is only in the collection of table statistics where TABLESAMPLE is applicable. However, a more efficient collection of detailed index statistics is available through the SAMPLED DETAILED option. This is a different method of sampling than that employed by TABLESAMPLE and only applies to the detailed set of index statistics.
10. A statistics profile can be set or updated for the table or statistical view specified in the RUNSTATS command, by using the set profile or update profile options. The statistics profile is stored in a visible string format, which represents the RUNSTATS command, in the STATISTICS_PROFILE column of the SYSIBM.SYSTABLES system catalog table.
11. Statistics collection on XML type columns is governed by two DB2 database system registry values: DB2_XML_RUNSTATS_PATHID_K and DB2_XML_RUNSTATS_PATHVALUE_K. These two parameters are similar to the NUM_FREQVALUES parameter in that they specify the number of frequency values to collect. If not set, a default of 200 will be used for both parameters.
12. RUNSTATS acquires an IX table lock on SYSTABLES and a U lock on the row for the table on which stats are being gathered at the beginning of RUNSTATS. Operations can still read from SYSTABLES including the row with the U lock. Write operations are also possible, providing they do not occur against the row with the U lock. However, another reader or writer will not be able acquire an S lock on SYSTABLES because of RUNSTATS' IX lock.
13. Statistics are not collected for columns with structured types. If they are specified, columns with these data types are ignored.
14. Only AVGCOLLEN and NUMNULLS are collected for columns with LOB or LONG data types.
15. AVGCOLLEN represents the average space in bytes when the column is stored in database memory or a temporary table. This value represents the length of the data descriptor for LOB or LONG data types, except when LOB data is inlined on the data page.

Note: The average space required to store the column on disk may be different than the value represented by this statistic.

Chapter 116. SET CLIENT

Specifies connection settings for the back-end process.

Authorization

None

Required connection

None

Command syntax

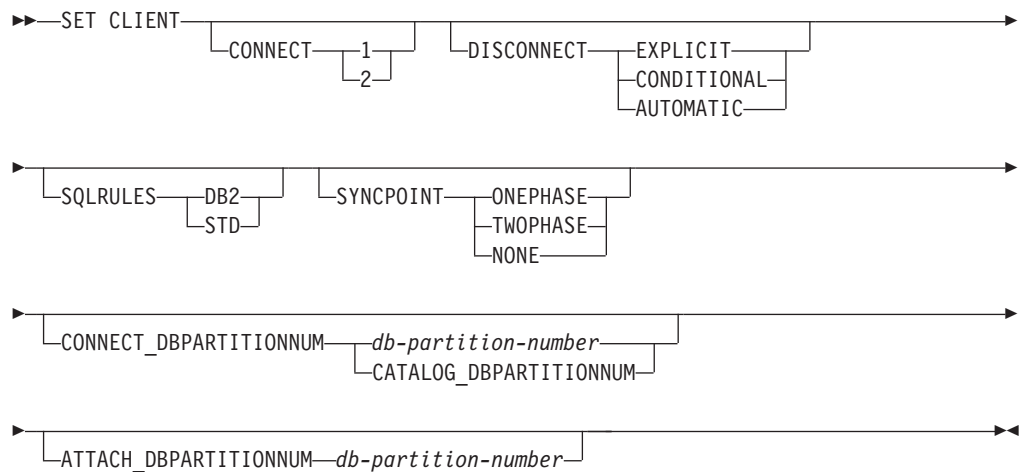

Command parameters

CONNECT

- 1 Specifies that a CONNECT statement is to be processed as a type 1 CONNECT.
- 2 Specifies that a CONNECT statement is to be processed as a type 2 CONNECT.

DISCONNECT

EXPLICIT

Specifies that only database connections that have been explicitly marked for release by the RELEASE statement are to be disconnected at commit.

CONDITIONAL

Specifies that the database connections that have been marked RELEASE or have no open WITH HOLD cursors are to be disconnected at commit.

AUTOMATIC

Specifies that all database connections are to be disconnected at commit.

SQLRULES

- DB2** Specifies that a type 2 CONNECT is to be processed according to the DB2 rules.
- STD** Specifies that a type 2 CONNECT is to be processed according to the Standard (STD) rules based on ISO/ANS SQL92.

SYNCPOINT

Specifies how commits or rollbacks are to be coordinated among multiple database connections. This command parameter is ignored and is only included here for backward compatibility.

ONEPHASE

Specifies that no transaction manager (TM) is to be used to perform a two-phase commit. A one-phase commit is to be used to commit the work done by each database in multiple database transactions.

TWOPHASE

Specifies that the TM is required to coordinate two-phase commits among those databases that support this protocol.

NONE

Specifies that no TM is to be used to perform a two-phase commit, and does not enforce single updater, multiple reader. A COMMIT is sent to each participating database. The application is responsible for recovery if any of the commits fail.

CONNECT_DBPARTITIONNUM (partitioned database environment only)

db-partition-number

Specifies the database partition to which a connect is to be made. A value between zero and 999, inclusive. Overrides the value of the environment variable DB2NODE.

CATALOG_DBPARTITIONNUM

Specifying this value permits the client to connect to the catalog database partition of the database without knowing the identity of that database partition in advance.

ATTACH_DBPARTITIONNUM *db-partition-number* (partitioned database environment only)

Specifies the database partition to which an attach is to be made. A value between zero and 999, inclusive. Overrides the value of the environment variable DB2NODE.

For example, if database partitions 1, 2, and 3 are defined, the client only needs to be able to access one of these database partitions. If only database partition 1 containing databases has been cataloged, and this parameter is set to 3, then the next attach attempt will result in an attachment at database partition 3, after an initial attachment at database partition 1.

Examples

To set specific values:

```
db2 set client connect 2 disconnect automatic sqlrules std
syncpoint twophase
```

To change SQLRULES back to DB2, but keep the other settings:

```
db2 set client sqlrules db2
```

The connection settings revert to default values after the `TERMINATE` command is issued.

Usage notes

`SET CLIENT` cannot be issued if one or more connections are active.

If `SET CLIENT` is successful, the connections in the subsequent units of work will use the connection settings specified. If `SET CLIENT` is unsuccessful, the connection settings of the back-end process are unchanged.

In a partitioned database environment (DPF), the connection settings could have an impact on acquiring trusted connections. For example, if the `CONNECT_DBPARTITIONNUM` option is set to a node such that the establishment of a connection on that node requires going through an intermediate node (a hop node), it is the IP address of that intermediate node and the communication protocol used to communicate between the hop node and the connection node that are considered when evaluating this connection in order to determine whether or not it can be marked as a trusted connection. In other words, it is not the original node from which the connection was initiated that is considered. Rather, it is the hop node that is considered.

Compatibilities

For compatibility with versions earlier than Version 8:

- The keyword `CONNECT_NODE` can be substituted for `CONNECT_DBPARTITIONNUM`.
- The keyword `CATALOG_NODE` can be substituted for `CATALOG_DBPARTITIONNUM`.
- The keyword `ATTACH_NODE` can be substituted for `ATTACH_DBPARTITIONNUM`.

Chapter 117. SET RUNTIME DEGREE

Sets the maximum run time degree of intra-partition parallelism for SQL statements for specified active applications.

Scope

This command affects all database partitions that are listed in the `$HOME/sql1lib/db2nodes.cfg` file.

Authorization

One of the following:

- *sysadm*
- *sysctrl*

Required connection

Instance. To change the maximum run time degree of intra-partition parallelism on a remote server, it is first necessary to attach to that server. If no attachment exists, the SET RUNTIME DEGREE command fails.

Command syntax

```
▶▶ SET RUNTIME DEGREE FOR ALL TO degree ▶▶  
    ( application-handle )
```

Command parameters

FOR

ALL The specified degree will apply to all applications.

application-handle

Specifies the agent to which the new degree applies. List the values using the LIST APPLICATIONS command.

TO *degree*

The maximum run time degree of intra-partition parallelism.

Examples

The following example sets the maximum run time degree of parallelism for two users, with *application-handle* values of 41408 and 55458, to 4:

```
db2 SET RUNTIME DEGREE FOR ( 41408, 55458 ) TO 4
```

Usage notes

This command provides a mechanism to modify the maximum degree of parallelism for active applications. It can be used to override the value that was determined at SQL statement compilation time.

The run time degree of intra-partition parallelism specifies the maximum number of parallel operations that will be used when the statement is executed. The degree of intra-partition parallelism for an SQL statement can be specified at statement compilation time using the CURRENT DEGREE special register or the DEGREE bind option. The maximum run time degree of intra-partition parallelism for an active application can be specified using the SET RUNTIME DEGREE command. The *max_querydegree* database manager configuration parameter specifies the maximum run time degree for any SQL statement executing on this instance of the database manager.

The actual run time degree will be the lowest of:

- the **max_querydegree** configuration parameter
- the application run time degree
- the SQL statement compilation degree.

Chapter 118. SET SERVEROUTPUT command

Specifies whether output from the DBMS_OUTPUT message buffer is redirected to standard output.

Authorization

EXECUTE privilege on the DBMS_OUTPUT module.

Required connection

Database

Command syntax

```
➤➤—SET SERVEROUTPUT—

|     |
|-----|
| OFF |
| ON  |

—➤➤
```

Command parameters

ON

Specifies that messages in the message buffer are redirected to standard output.

OFF

Specifies that messages in the message buffer are not redirected to standard output.

Examples

To redirect messages in the DBMS_OUTPUT message buffer to standard output, specify SET SERVEROUTPUT ON. In this example, the PUT procedure adds partial lines to the DBMS_OUTPUT message buffer. When proc1 runs, because SET SERVEROUTPUT ON is specified, the text stored in the DBMS_OUTPUT message buffer is displayed.

```
SET SERVEROUTPUT ON@

DROP PROCEDURE proc1@

CREATE PROCEDURE proc1()
BEGIN
  CALL DBMS_OUTPUT.PUT( 'p1 = ' || p1 );
  CALL DBMS_OUTPUT.PUT( 'p2 = ' || p2 );
  CALL DBMS_OUTPUT.NEW_LINE;
END@

CALL proc1( 10, 'Peter' )@

SET SERVEROUTPUT OFF@
```

This example results in the following output:

```
SET SERVEROUTPUT ON
DB20000I The SET SERVEROUTPUT command completed successfully.

DROP PROCEDURE PROC1
DB20000I The SQL command completed successfully.
```

```

CREATE PROCEDURE proc1()
BEGIN
  CALL DBMS_OUTPUT.PUT( 'p1 = ' || p1 );
  CALL DBMS_OUTPUT.PUT( 'p2 = ' || p2 );
  CALL DBMS_OUTPUT.NEW_LINE;
END@
DB20000I The SQL command completed successfully.

CALL proc1( 10, 'Peter' )@

  Return Status = 0

p1 = 10
p2 = Peter

SET SERVEROUTPUT OFF
DB20000I The SET SERVEROUTPUT command completed successfully.

```

Usage notes

Messages are added to the DBMS_OUTPUT message buffer by the PUT, PUT_LINE, and NEW_LINE procedures.

When the command SET SERVEROUTPUT ON executes, it calls the DBMS_OUTPUT.ENABLE procedure with the default buffer size of 20000 bytes and sets an internal flag in the client application. When this flag is enabled, the client application calls the GET_LINES procedure after executing each SELECT or CALL statement, and redirects the messages from the message buffer to standard output. To increase the DBMS_OUTPUT buffer size, call DBMS_OUTPUT.ENABLE procedure with a larger buffer size after executing SET SERVER OUTPUT ON, for example: CALL DBMS_OUTPUT.ENABLE(50000);

When the command SET SERVEROUTPUT OFF executes: it calls the DBMS_OUTPUT.DISABLE procedure, messages that are in the message buffer are discarded, and calls to PUT, PUT_LINE, and NEW_LINE procedures are ignored. The DBMS_OUTPUT.GET_LINES procedure will not be called after each SELECT or CALL statement.

Chapter 119. SET TABLESPACE CONTAINERS

A *redirected restore* is a restore in which the set of table space containers for the restored database is different from the set of containers for the original database at the time the backup was done. This command permits the addition, change, or removal of table space containers for a database that is to be restored. If, for example, one or more containers become inaccessible for any reason, the restore fails if it is not redirected to different containers.

This command can be used to convert existing regular or large database managed table spaces to use automatic storage. It can also be used to re-stripe existing automatic storage table spaces more evenly over the storage paths available to the database.

Authorization

One of the following:

- *sysadm*
- *sysctrl*

Required connection

Database

Command syntax

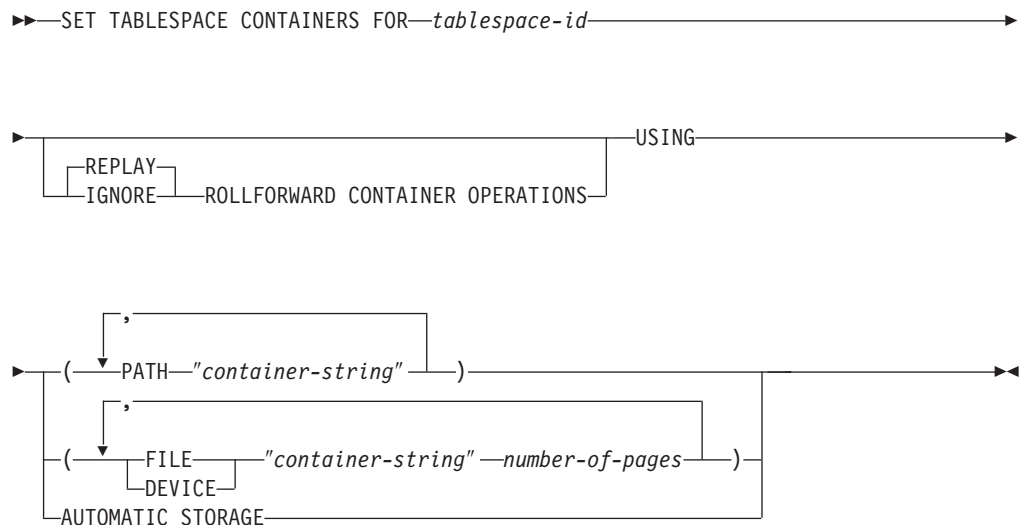

Command parameters

FOR *tablespace-id*

An integer that uniquely represents a table space used by the database being restored.

REPLAY ROLLFORWARD CONTAINER OPERATIONS

Specifies that any ALTER TABLESPACE operation issued against this table

space since the database was backed up is to be redone during a subsequent roll forward of the database.

IGNORE ROLLFORWARD CONTAINER OPERATIONS

Specifies that ALTER TABLESPACE operations in the log are to be ignored when performing a roll forward.

USING PATH *"container-string"*

For an SMS table space, identifies one or more containers that will belong to the table space and into which the table space data will be stored. It is an absolute or relative directory name. If the directory name is not absolute, it is relative to the database directory. The string cannot exceed 240 bytes in length.

USING FILE | DEVICE *"container-string" number-of-pages*

For a DMS table space, identifies one or more containers that will belong to the table space and into which the table space data will be stored. The container type (either FILE or DEVICE) and its size are specified. A mixture of file and device containers can be specified. The string cannot exceed 254 bytes in length.

For a file container, the string must be an absolute or relative file name. If the file name is not absolute, it is relative to the database directory.

For a device container, the string must be a device name. The device must already exist.

USING AUTOMATIC STORAGE

Specifies that the table space should be converted to use automatic storage and that the database will create new containers on its available storage paths. Once a table space has been redirected to use automatic storage, no container operations can be applied to the table space.

This option can be used to provide better striping across existing storage paths by redefining the containers of table spaces that are already managed by automatic storage.

Note: The table space will be offline while being restored.

This option is not supported for system managed table spaces.

Examples

See the example in RESTORE DATABASE.

Usage notes

A backup of a database, or one or more table spaces, keeps a record of all the table space containers in use by the table spaces being backed up. During a restore, all containers listed in the backup are checked to see if they currently exist and are accessible. If one or more of the containers is inaccessible for any reason, the restore will fail. In order to allow a restore in such a case, the redirecting of table space containers is supported during the restore. This support includes adding, changing, or removing of table space containers. It is this command that allows the user to add, change or remove those containers.

The IGNORE/REPLAY ROLLFORWARD CONTAINER OPERATIONS option is ignored when specified with the USING AUTOMATIC STORAGE option.

A redirected restore of a table space in a multi-partition environment using the USING AUTOMATIC STORAGE option of the SET TABLESPACE CONTAINERS command will only convert the table space to automatic storage on the partition being restored. It will not redefine the containers on any other database partition.

Note: By not redefining the containers on other database partitions, the definition of the table space differs on each partition. Later, when adding a database partition, use the ADD DBPARTITIONNUM command with the LIKE DBPARTITIONNUM option. Depending on the database partition chosen in this option, the new database partition will have either the table space defined with automatic storage or the table space defined without automatic storage. To remove both the inconsistency in the definitions of the table spaces and the need to decide between the definitions each time a new database partition is added, ensure that the table space definition is the same on all database partitions. For example, if all of the database partitions were subject to a redirected restore followed by using the USING AUTOMATIC STORAGE option of the SET TABLESPACE CONTAINERS command, then the table space will be converted to automatic storage on all the database partitions. Adding another database partition later will have the same definition for the table space as that found on the other database partitions.

Chapter 120. SET TAPE POSITION

Sets the positions of tapes for backup and restore operations to streaming tape devices. This command is only supported on Windows operating systems.

Authorization

One of the following:

- *sysadm*
- *sysctrl*
- *sysmaint*

Required connection

None

Command syntax

►► SET TAPE POSITION *ON device* TO *position* ◀◀

Command parameters

ON device

Specifies a valid tape device name. The default value is `\\.\TAPE0`.

TO position

Specifies the mark at which the tape is to be positioned. DB2 for Windows writes a tape mark after every backup image. A value of 1 specifies the first position, 2 specifies the second position, and so on. If the tape is positioned at tape mark 1, for example, archive 2 is positioned to be restored.

Chapter 121. SET UTIL_IMPACT_PRIORITY

Changes the impact setting for a running utility. Using this command, you can:

- throttle a utility that was invoked in unthrottled mode
- unthrottle a throttled utility (disable throttling)
- reprioritize a throttled utility (useful if running multiple simultaneous throttled utilities)

Scope

Authorization

One of the following:

- *sysadm*
- *sysctrl*
- *sysmaint*
- *sysmon*

Required connection

Instance. If there is more than one partition on the local machine, the attachment should be made to the correct partition. For example, suppose there are two partitions and a LIST UTILITIES command resulted in the following output:

```
ID = 2
Type = BACKUP
Database Name = IWZ
Partition Number = 1
Description = online db
Start Time = 07/19/2007 17:32:09.622395
State = Executing
Invocation Type = User
Throttling:
Priority = Unthrottled
Progress Monitoring:
Estimated Percentage Complete = 10
Total Work = 97867649689 bytes
Completed Work = 10124388481 bytes
```

The instance attachment must be made to partition 1 in order to issue a SET UTIL_IMPACT_PRIORITY command against the utility with ID 2. To do this, set DB2NODE=1 in the environment and then issue the instance attachment command.

Command syntax

```
►►—SET UTIL_IMPACT_PRIORITY FOR—utility-id—TO—priority—◄◄
```

Command parameters

utility-id

ID of the utility whose impact setting will be updated. IDs of running utilities can be obtained with the LIST UTILITIES command.

TO *priority*

Specifies an instance-level limit on the impact associated with running a utility. A value of 100 represents the highest priority and 1 represents the lowest priority. Setting *priority* to 0 will force a throttled utility to continue unthrottled. Setting *priority* to a non-zero value will force an unthrottled utility to continue in throttled mode.

Examples

The following example unthrottles the utility with ID 2.

```
SET UTIL_IMPACT_PRIORITY FOR 2 TO 0
```

The following example throttles the utility with ID 3 to priority 10. If the priority was 0 before the change then a previously unthrottled utility is now throttled. If the utility was previously throttled (priority had been set to a value greater than zero), then the utility has been reprioritized.

```
SET UTIL_IMPACT_PRIORITY FOR 3 TO 10
```

Relationship between UTIL_IMPACT_LIM and UTIL_IMPACT_PRIORITY settings

The database manager configuration parameter **util_impact_lim** sets the limit on the impact throttled utilities can have on the overall workload of the machine. 0-99 is a throttled percentage, 100 is no throttling.

The SET UTIL_IMPACT_PRIORITY command sets the priority that a particular utility has over the resources available to throttled utilities as defined by the **util_impact_lim** configuration parameter. (0 = unthrottled)

Using the backup utility as an example, if the **util_impact_lim**=10, all utilities can have no more than a 10% average impact upon the total workload as judged by the throttling algorithm. Using two throttled utilities as an example:

- Backup with util_impact_priority 70
- Runstats with util_impact_priority 50

Both utilities combined should have no more than a 10% average impact on the total workload, and the utility with the higher priority will get more of the available workload resources. For both the backup and runstats operations, it is also possible to declare the impact priority within the command line of that utility. If you do not issue the SET UTIL_IMPACT_PRIORITY command, the utility will run unthrottled (irrespective of the setting of **util_impact_lim**).

To view the current priority setting for the utilities that are running, you can use the LIST UTILITIES command.

Usage notes

Throttling requires having an impact policy defined by setting the **util_impact_lim** configuration parameter.

Chapter 122. SET WORKLOAD command

Specifies the workload to which the database connection is to be assigned. This command can be issued prior to connecting to a database or it can be used to reassign the current connection once the connection has been established. If the connection has been established, the workload reassignment will be performed at the beginning of the next unit of work.

Authorization

None, but see usage notes

Required connection

None

Command syntax

```
➤➤—SET WORKLOAD TO—┐—AUTOMATIC—┐  
                          └—SYSDEFAULTADMWORKLOAD—┘
```

Command parameters

AUTOMATIC

Specifies that the database connection will be assigned to a workload chosen by the workload evaluation that is performed automatically by the server.

SYSDEFAULTADMWORKLOAD

Specifies that the database connection will be assigned to the SYSDEFAULTADMWORKLOAD, allowing users with *accessctrl*, *dataaccess*, *wlmadm*, *secadm* or *dbadm* authority to bypass the normal workload evaluation.

Examples

To assign the connection to the SYSDEFAULTADMWORKLOAD:

```
SET WORKLOAD TO SYSDEFAULTADMWORKLOAD
```

To reset the workload assignment so that it uses the workload that is chosen by the workload evaluation performed by the server:

```
SET WORKLOAD TO AUTOMATIC
```

Usage notes

If the session authorization ID of the database connection does not have *accessctrl*, *dataaccess*, *wlmadm*, *secadm* or *dbadm* authority, the connection cannot be assigned to the SYSDEFAULTADMWORKLOAD and an SQL0552N error will be returned. If the SET WORKLOAD TO SYSDEFAULTADMWORKLOAD command is issued prior to connecting to a database, the SQL0552N error will be returned after the database connection has been established, at the beginning of the first unit of work. If the command is issued when the database connection has been established, the SQL0552N error will be returned at the beginning of the next unit of work, when the workload reassignment is supposed to take place.

Chapter 123. SET WRITE

The SET WRITE command allows a user to suspend I/O writes or to resume I/O writes for a database. Typical use of this command is for splitting a mirrored database. This type of mirroring is achieved through a disk storage system.

This new state, SUSPEND_WRITE, is visible from the Snapshot Monitor. All table spaces must be in a NORMAL state for the command to execute successfully. If any one table space is in a state other than NORMAL, the command will fail.

Scope

This command only affects the database partition on which it is executed.

Authorization

This command only affect the node on which it is executed. The authorization of this command requires the issuer to have one of the following privileges:

- *sysadm*
- *sysctrl*
- *sysmaint*

Required Connection

Database

Command Syntax

```
▶▶ SET WRITE {SUSPEND | RESUME} FOR {DATABASE | DB} ▶▶
```

Command Parameters

SUSPEND

Suspending I/O writes will put all table spaces into a new state SUSPEND_WRITE state. Writes to the logs are also suspended by this command. All database operations, apart from online backup and restore, should function normally while database writes are suspended. However, some operations can wait while attempting to flush dirty pages from the buffer pool or log buffers to the logs. These operations will resume normally once the database writes are resumed.

RESUME

Resuming I/O writes will remove the SUSPEND_WRITE state from all of the table spaces and make the table spaces available for update.

Usage notes

It is suggested that I/O writes be resumed from the same connection from which they were suspended. Ensuring that this connection is available to resume I/O writes involves not performing any operations from this connection until database writes are resumed. Otherwise, some operations can wait for I/O writes to be

resumed if dirty pages must be flushed from the buffer pool or from log buffers to the logs. Furthermore, subsequent connection attempts might hang if they require flushing dirty pages from the buffer pool to disk. Subsequent connections will complete successfully once database I/O resumes. If your connection attempts are hanging, and it has become impossible to resume I/O from the connection that you used to suspend I/O, then you will have to run the `RESTART DATABASE` command with the `WRITE RESUME` option. When used in this circumstance, the `RESTART DATABASE` command will resume I/O writes without performing crash recovery. The `RESTART DATABASE` command with the `WRITE RESUME` option will only perform crash recovery when you use it after a database crash.

Chapter 124. START DATABASE MANAGER

Starts the current database manager instance background processes on a single database partition or on all the database partitions defined in a multi-partitioned database environment.

Scope

In a multi-partitioned database environment, this command affects all database partitions that are listed in the `$HOME/sqllib/db2nodes.cfg` file, unless the `DBPARTITIONNUM` parameter is used.

Authorization

One of the following:

- *sysadm*
- *sysctrl*
- *sysmaint*

The `ADD DBPARTITIONNUM` start option requires either *sysadm* or *sysctrl* authority.

You must meet Windows operating system requirements for starting a service. If Extended Security is disabled, you must be a member of the Administrators, Server Operators or Power Users group. If Extended Security is enabled, you must be a member of either the Administrators group or the DB2ADMNS group to start the database.

Required connection

None

Command syntax

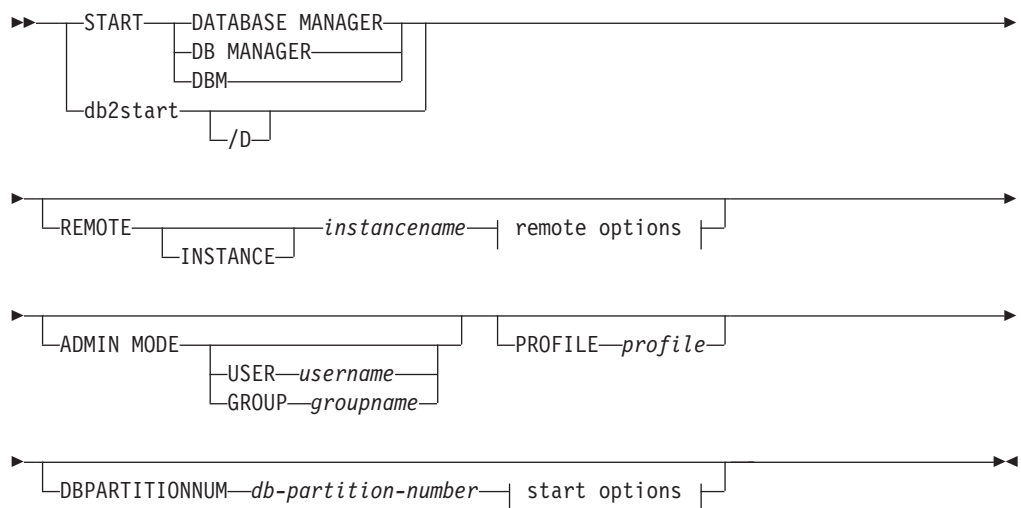

remote options:

```
|-----|  
| ADMINNODE nodename USER username USING password |-----|  
|-----|  
| HOSTNAME hostname |-----|
```

start options:

```
|-----|  
| ADD DBPARTITIONNUM add dbpartitionnum options |-----|  
|-----|  
| STANDALONE |-----|  
|-----|  
| RESTART restart options |-----|
```

add dbpartitionnum options:

```
|-----|  
| DBPARTITIONNUM db-partition-number HOSTNAME hostname PORT logical-port |----->  
|----->  
| COMPUTER computer-name | USER username | PASSWORD password |----->  
|----->  
|-----|  
| NETNAME netname | LIKE DBPARTITIONNUM db-partition-number |-----|  
|-----|  
|-----|  
| WITHOUT TABLESPACES |-----|
```

restart options:

```
|-----|  
| HOSTNAME hostname | PORT logical-port | COMPUTER computername |----->  
|----->  
|----->  
| USER username | PASSWORD password | NETNAME netname |----->  
|----->  
|-----|  
| IN PARALLEL |-----|
```

Command parameters

REMOTE [INSTANCE] *instancename*

Specifies the name of the remote instance you want to start.

ADMINNODE *nodename*

With REMOTE, or REMOTE INSTANCE, specifies the name of the administration node.

HOSTNAME *hostname*

With REMOTE, or REMOTE INSTANCE, specifies the name of the host node.

USER *username*

With REMOTE, or REMOTE INSTANCE, specifies the name of the user.

USING *password*

With REMOTE, or REMOTE INSTANCE, and USER, specifies the password of the user.

ADMIN MODE

Starts the instance in quiesced mode for administration purposes. This is

equivalent to the QUIESCE INSTANCE command except in this case the instance is not already “up”, and therefore there is no need to force the connections OFF.

USER *username*

With ADMIN MODE, specifies the name of the user.

GROUP *groupname*

With ADMIN MODE, specifies the name of the group.

All of the following parameters are valid in an Enterprise Server Edition (ESE) environment only.

PROFILE *profile*

Specifies the name of the profile file to be executed at each database partition to define the DB2 environment. This file is executed before the database partitions are started. The profile file must reside in the `sql1ib` directory of the instance owner. The environment variables in the profile file are not necessarily all defined in the user session.

DBPARTITIONNUM *db-partition-number*

Specifies the database partition to be started. If no other options are specified, a normal startup is done at this database partition.

Valid values are from 0 to 999 inclusive. If ADD DBPARTITIONNUM is not specified, the value must already exist in the `db2nodes.cfg` file of the instance owner. If no database partition number is specified, all database partitions defined in the configuration file are started.

ADD DBPARTITIONNUM

Specifies that the new database partition server is added to the `db2nodes.cfg` file of the instance owner with the *hostname* and *logical-port* values.

Ensure that the combination of *hostname* and *logical-port* is unique.

The add database partition server utility is executed internally to create all existing databases on the database server partition being added. The new database partition server is automatically added to the `db2nodes.cfg` file.

Note: Any uncataloged database is not recognized when adding a new database partition. The uncataloged database will not be present on the new database partition. An attempt to connect to the database on the new database partition returns the error message SQL1013N.

If the ADD request is made in an environment that has two or more active database partition servers, the new database partition server is visible to the environment when the ADD processing completes.

If the ADD request is made in an environment that has one database partition server and it is active, after ADD processing completes, the new database partition server is inactive. The instance must be restarted by using `db2stop` and `db2start` before the new database partition server can participate in the partitioned database environment. If the ADD request is made in an environment that has one database partition server and it is inactive, after ADD processing completes, the new database partition server (or servers, if more than one is added) is active. Only the original database partition server needs to be started.

A newly added database partition is configured during ADD processing as follows:

1. In a multipartition environment, the new database partition is configured using the database configuration parameter values from a noncatalog database partition.
2. In a single-partition environment, the new database partition is configured using the database configuration parameter values from the catalog partition.
3. If a problem occurs in copying the database configuration parameter values to the new database partition, the new database partition is configured using the default database configuration parameter values.

DBPARTITIONNUM *db-partition-number*

Specifies the value of the database partition number for the new database partition to be created.

HOSTNAME *hostname*

With ADD DBPARTITIONNUM, specifies the host name to be added to the `db2nodes.cfg` file.

PORT *logical-port*

With ADD DBPARTITIONNUM, specifies the logical port to be added to the `db2nodes.cfg` file. Valid values are from 0 to 999.

COMPUTER *computername*

The computer name for the machine on which the new database partition is created. This parameter is mandatory on Windows, but is ignored on other operating systems.

USER *username*

The user name for the account on the new database partition. This parameter is mandatory on Windows, but is ignored on other operating systems.

PASSWORD *password*

The password for the account on the new database partition. This parameter is mandatory on Windows, but is ignored on other operating systems.

NETNAME *netname*

Specifies the *netname* to be added to the `db2nodes.cfg` file. If not specified, this parameter defaults to the value specified for *hostname*.

IN PARALLEL

Issue the RESTART DATABASE command for parallel execution.

LIKE DBPARTITIONNUM *db-partition-number*

Specifies that the containers for the system temporary table spaces will be the same as the containers on the specified *db-partition-number* for each database in the instance. The database partition specified must be a database partition that is already in the `db2nodes.cfg` file. For system temporary table spaces that are defined to use automatic storage (in other words, system temporary table spaces that were created with the MANAGED BY AUTOMATIC STORAGE clause of the CREATE TABLESPACE statement or where no MANAGED BY CLAUSE was specified at all), the containers will not necessarily match those from the partition specified. Instead, containers will automatically be assigned by the database manager based on the storage paths that are associated with the database. This may or may not result in the same containers being used on these two partitions.

WITHOUT TABLESPACES

Specifies that containers for the system temporary table spaces are not created for any of the databases. The ALTER TABLESPACE statement must be used to add system temporary table space containers to each database before the database can be used. This option is ignored for system temporary table spaces that are defined to use automatic storage (in other words, system temporary table spaces that were created with the MANAGED BY AUTOMATIC STORAGE clause of the CREATE TABLESPACE statement or where no MANAGED BY CLAUSE was specified at all). For these table spaces, there is no way to defer container creation. Containers will automatically be assigned by the database manager based on the storage paths that are associated with the database.

STANDALONE

Specifies that the database partition is to be started in stand-alone mode. FCM does not attempt to establish a connection to any other database partition. This option is used when adding a database partition.

RESTART

Starts the database manager after a failure. Other database partitions are still operating, and this database partition attempts to connect to the others. If neither the *hostname* nor the *logical-port* parameter is specified, the database manager is restarted using the *hostname* and *logical-port* values specified in `db2nodes.cfg`. If either parameter is specified, the new values are sent to the other database partitions when a connection is established. The `db2nodes.cfg` file is updated with this information.

HOSTNAME *hostname*

You can use the HOSTNAME option with the RESTART parameter to restart a database partition on a different machine than is specified in the database partition configuration file, `db2nodes.cfg`.

Restriction:

When you are using the DB2 High Availability Feature, you should not use the HOSTNAME option with the RESTART parameter to restart a database partition on a different machine. To restart or move a database partition from one machine in a cluster to another machine, use DB2 High Availability Instance Configuration Utility (`db2haicu`).

PORT *logical-port*

With RESTART, specifies the logical port number to be used to override that in the database partition configuration file. If not specified, this parameter defaults to the *logical-port* value that corresponds to the *num* value in the `db2nodes.cfg` file. Valid values are from 0 to 999.

COMPUTER *computername*

The computer name for the machine on which the new database partition is created. This parameter is mandatory on Windows, but is ignored on other operating systems.

USER *username*

The user name for the account on the new database partition. This parameter is mandatory on Windows, but is ignored on other operating systems.

PASSWORD *password*

The password for the account on the new database partition. This parameter is mandatory on Windows, but is ignored on other operating systems.

NETNAME *netname*

Specifies the *netname* to override that specified in the `db2nodes.cfg` file. If not specified, this parameter defaults to the *netname* value that corresponds to the *db-partition-number* value in the `db2nodes.cfg` file.

Examples

The following is sample output from `db2start` issued on a three-database partition system with database partitions 10, 20, and 30:

```
04-07-1997 10:33:05 10 0 SQL1063N DB2START processing was successful.  
04-07-1997 10:33:07 20 0 SQL1063N DB2START processing was successful.  
04-07-1997 10:33:07 30 0 SQL1063N DB2START processing was successful.  
SQL1063N DB2START processing was successful.
```

Usage notes

On Microsoft Windows Vista or later versions, you must execute this command from a DB2 command window running with full administrator privileges.

It is not necessary to issue this command on a client node. It is provided for compatibility with older clients, but it has no effect on the database manager.

Once started, the database manager instance runs until the user stops it, even if all application programs that were using it have ended.

If the database manager starts successfully, a successful completion message is sent to the standard output device. If an error occurs, processing stops, and an error message is sent to the standard output device. In a partitioned database environment, messages are returned on the database partition that issued the `START DATABASE MANAGER` command.

If no parameters are specified in a partitioned database environment, the database manager is started on all parallel nodes using the parameters specified in the database partition configuration file.

If a `START DATABASE MANAGER` command is in progress, ensure that the applicable database partitions have started *before* issuing a request to the database.

The `db2cshrc` file is not supported and cannot be used to define the environment.

You can start an instance in a quiesced state. You can do this by using one of the following choices:

```
db2start admin mode
```

or

```
db2start admin mode user username
```

or

```
db2start admin mode group groupname
```

When adding a new database partition server, START DATABASE MANAGER must determine whether or not each database in the instance is enabled for automatic storage. This is done by communicating with the catalog partition for each database. If automatic storage is enabled then the storage path definitions are retrieved as part of that communication. Likewise, if system temporary table spaces are to be created with the database partitions, START DATABASE MANAGER might have to communicate with another database partition server to retrieve the table space definitions for the database partitions that reside on that server. The **start_stop_time** database manager configuration parameter is used to specify the time, in minutes, by which the other database partition server must respond with the automatic storage and table space definitions. If this time is exceeded, the command fails. If this situation occurs, increase the value of **start_stop_time**, and reissue the command.

A new database partition server cannot be added when any of the following commands, statements, or operations are in progress. Otherwise SQL6074N is returned.

- QUIESCE INSTANCE
- UNQUIESCE INSTANCE
- STOP DB2 (db2stop)
- STOP DATABASE MANAGER DBPARTITIONNUM
- START DB2 (db2start)
- START DATABASE MANAGER DBPARTITIONNUM
- START DATABASE MANAGER with restart options
- CREATE DATABASE
- DROP DATABASE
- QUIESCE DATABASE
- UNQUIESCE DATABASE
- ACTIVATE DATABASE
- DEACTIVATE DATABASE
- A Z lock on a database object
- Backing up the database on all database partition servers
- Restoring the database
- ALTER, ALTER, or DROP of a table space
- Updating of automatic storage paths

On UNIX platforms, the START DATABASE MANAGER command supports the SIGINT signal. It is issued if CTRL+C is pressed. If this signal occurs, all in-progress startups are interrupted and a message (SQL1044N) is returned from each interrupted database partition to the \$HOME/sql1lib/log/db2start.*timestamp*.log error log file. Database partitions that are already started are not affected. If CTRL+C is pressed on a database partition that is starting, db2stop must be issued on that database partition before an attempt is made to start it again.

On Windows operating systems, neither the db2start command nor the NET START command returns warnings if any communication subsystem failed to start. The database manager in a Windows environment is implemented as a service, and does not return an error if the service is started successfully. Be sure to examine the Event Log or the db2diag log file for any errors that might have occurred during the running of db2start.

Compatibilities

For compatibility with versions earlier than Version 8:

- The keywords LIKE NODE can be substituted for LIKE DBPARTITIONNUM.
- The keyword ADDNODE can be substituted for ADD DBPARTITIONNUM.
- The keyword NODENUM can be substituted for DBPARTITIONNUM.

Chapter 125. START HADR

Starts HADR operations for a database.

Authorization

One of the following:

- *sysadm*
- *sysctrl*
- *sysmaint*

Required connection

Instance. The command establishes a database connection if one does not exist, and closes the database connection when the command completes.

Command syntax

```
▶▶ START HADR ON DATABASE database-alias
                   DB
USER user-name AS PRIMARY BY FORCE
                   USING password
                   STANDBY
```

Command parameters

DATABASE *database-alias*

Identifies the database on which HADR operations are to start.

USER *user-name*

Identifies the user name under which the HADR operations are to be started.

USING *password*

The password used to authenticate *user-name*.

AS PRIMARY

Specifies that HADR primary operations are to be started on the database.

BY FORCE

Specifies that the HADR primary database will not wait for the standby database to connect to it. After a start BY FORCE, the primary database will still accept valid connections from the standby database whenever the standby later becomes available. When BY FORCE is used, the database will perform crash recovery if necessary, regardless of the value of database configuration parameter **AUTORESTART**. Other methods of starting a primary database (such as non-forced START HADR command, ACTIVATE DATABASE command, or client connection) will respect the **AUTORESTART** setting.

Caution: Use the START HADR command with the AS PRIMARY BY FORCE option with caution. If the standby database has been

changed to a primary and the original primary database is restarted by issuing the START HADR command with the AS PRIMARY BY FORCE option, both copies of your database will be operating independently as primaries. (This is sometimes referred to as *split brain* or *dual primary*.) In this case, each primary database can accept connections and perform transactions, and neither receives and replays the updates made by the other. As a result, the two copies of the database will become inconsistent with each other.

AS STANDBY

Specifies that HADR standby operations are to be started on the database. The standby database will attempt to connect to the HADR primary database until a connection is successfully established, or until the connection attempt is explicitly rejected by the primary. (The connection might be rejected by the primary database if an HADR configuration parameter is set incorrectly or if the database copies are inconsistent, both conditions for which continuing to retry the connection is not appropriate.)

Usage notes

The following table shows database behavior in various conditions:

Database status	Behavior upon START HADR command with the AS PRIMARY option	Behavior upon START HADR command with the AS STANDBY option
Inactive standard database	Activated as HADR primary database.	Database starts as an standby database if it is in rollforward-pending mode (which can be the result of a restore or a split mirror) or in rollforward in-progress mode. Otherwise, an error is returned.
Active standard database	Database enters HADR primary role.	Error message returned.
Inactive primary database	Activated as HADR primary database.	After a failover, this reintegrates the failed primary into the HADR pair as the new standby database. Some restrictions apply.
Active primary database	Warning message issued.	Error message returned.
Inactive standby database	Error message returned.	Starts the database as the standby database.
Active standby database	Error message returned.	Warning message issued.

When issuing the START HADR command, the corresponding error codes might be generated: SQL1767N, SQL1769N, or SQL1770N with a reason code of 98. The reason code indicates that there is no installed license for HADR on the server where the command was issued. To correct the problem, install a valid HADR license using the db2licm or install a version of the server that contains a valid HADR license as part of its distribution.

Chapter 126. STOP DATABASE MANAGER

Stops the current database manager instance. Unless explicitly stopped, the database manager continues to be active. This command does not stop the database manager instance if any applications are connected to databases. If there are no database connections, but there are instance attachments, it forces the instance attachments and stops the database manager. This command also deactivates any outstanding database activations before stopping the database manager.

In a partitioned database environment, this command stops the current database manager instance on a database partition or on all database partitions. When it stops the database manager on all database partitions, it uses the `db2nodes.cfg` configuration file to obtain information about each database partition.

This command can also be used to drop a database partition from the `db2nodes.cfg` file (partitioned database environments only).

This command is not valid on a client.

Scope

By default, and in a partitioned database environment, this command affects all database partitions that are listed in the `db2nodes.cfg` file.

Authorization

One of the following:

- *sysadm*
- *sysctrl*
- *sysmaint*

Required connection

None

Command syntax

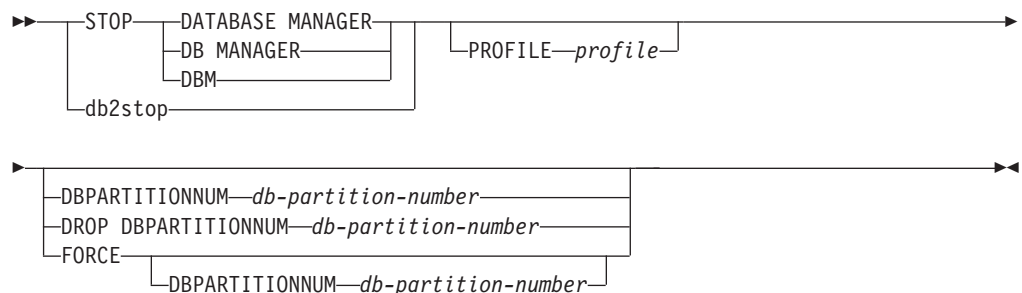

Command parameters

PROFILE *profile*

Partitioned database environments only. Specifies the name of the profile

file that was executed at startup to define the DB2 environment for those database partitions that were started. If a profile for the START DATABASE MANAGER command was specified, the same profile must be specified here. The profile file must reside in the sql11ib directory of the instance owner.

DBPARTITIONNUM *db-partition-number*

Partitioned database environments only. Specifies the database partition to be stopped.

Valid values are from 0 to 999 inclusive, and must be in the db2nodes.cfg file. If no database partition number is specified, all database partitions defined in the configuration file are stopped.

DROP DBPARTITIONNUM *db-partition-number*

Partitioned database environments only. Specifies the database partition to be dropped from the db2nodes.cfg file.

Before using this parameter, run the DROP DBPARTITIONNUM VERIFY command to ensure that there is no user data on this database partition.

When this option is specified, all database partitions in the db2nodes.cfg file are stopped.

FORCE

Specifies to use FORCE APPLICATION ALL when stopping the database manager at each database partition.

DBPARTITIONNUM *db-partition-number*

Partitioned database environments only. Specifies the database partition to be stopped after all applications on that database partition have been forced to stop. If the FORCE option is used without this parameter, all applications on all database partitions are forced before all the database partitions are stopped.

Examples

The following is sample output from db2stop issued on a three-partition system with database partitions 10, 20, and 30:

```
04-07-1997 10:32:53    10    0    SQL1064N  DB2STOP processing was successful.
04-07-1997 10:32:54    20    0    SQL1064N  DB2STOP processing was successful.
04-07-1997 10:32:55    30    0    SQL1064N  DB2STOP processing was successful.
SQL1064N  DB2STOP processing was successful.
```

Usage notes

On Microsoft Windows Vista or later versions, you must execute this command from a DB2 command window running with full administrator privileges.

It is not necessary to issue this command on a client node. It is provided for compatibility with older clients, but it has no effect on the database manager.

Once started, the database manager instance runs until the user stops it, even if all application programs that were using it have ended.

If the database manager is stopped, a successful completion message is sent to the standard output device. If an error occurs, processing stops, and an error message is sent to the standard output device.

If the database manager cannot be stopped because application programs are still connected to databases, use the FORCE APPLICATION command to disconnect all users first, or reissue the STOP DATABASE MANAGER command with the FORCE option.

The following information applies to partitioned database environments only:

- If no parameters are specified, the database manager is stopped on each database partition listed in the configuration file. The administration notification log might contain messages to indicate that other database partitions are shutting down.
- Any database partitions added to the partitioned database environment since the previous STOP DATABASE MANAGER command was issued will be updated in the db2nodes.cfg file.
- On UNIX platforms, if the value specified for the **start_stop_time** database manager configuration parameter is reached, all in-progress stops are interrupted, and message SQL6037N is returned from each interrupted database partition to the \$HOME/sqllib/log/db2stop.*timestamp*.log error log file. Database partitions that are already stopped are not affected.
- The db2cshrc file is not supported and cannot be specified as the value for the PROFILE parameter.

Attention: The UNIX kill command should *not* be used to terminate the database manager because it will abruptly end database manager processes without controlled termination and cleanup processing.

Chapter 127. STOP HADR

Stops HADR operations for a database.

Authorization

One of the following:

- *sysadm*
- *sysctrl*
- *sysmaint*

Required connection

Instance. The command establishes a database connection if one does not exist, and closes the database connection when the command completes.

Command syntax

```
▶▶ STOP HADR ON DATABASE database-alias
                   DB
▶
USER user-name
   USING password
```

Command parameters

DATABASE *database-alias*

Identifies the database on which HADR operations are to stop.

USER *user-name*

Identifies the user name under which the HADR operations are to be stopped.

USING *password*

The password used to authenticate *user-name*.

Usage notes

The following table shows database behavior in various conditions:

Database status	Behavior upon STOP HADR command
Inactive standard database	Error message returned.
Active standard database	Error message returned.
Inactive primary database	Database role changes to standard. Database configuration parameter hadr_db_role is updated to STANDARD. Database remains offline. At the next restart, enters standard role.

Database status	Behavior upon STOP HADR command
Active primary database	Stops shipping logs to the HADR standby database and shuts down all HADR EDUs on the HADR primary database. Database role changes to standard and database remains online. Database remains in standard role until an explicit START HADR command with the AS PRIMARY option is issued. Open sessions and transactions are not affected by the STOP HADR command. You can repeatedly issue STOP HADR and START HADR commands while the database remains online. These commands take effect dynamically.
Inactive standby database	Database role changes to standard. Database configuration parameter hadr_db_role is updated to STANDARD. Database remains offline. Database is put into rollforward pending mode.
Active standby database	Error message returned: Deactivate the standby database before attempting to convert it to a standard database.

When issuing the STOP HADR command, the corresponding error codes might be generated: SQL1767N, SQL1769N, or SQL1770N with a reason code of 98. The reason code indicates that there is no installed license for HADR on the server where the command was issued. To correct the problem, install a valid HADR license using the db2licm or install a version of the server that contains a valid HADR license as part of its distribution.

Chapter 128. TAKEOVER HADR

Instructs an HADR standby database to take over as the new HADR primary database for the HADR pair.

Authorization

One of the following:

- *sysadm*
- *sysctrl*
- *sysmaint*

Required connection

Instance. The command establishes a database connection if one does not exist, and closes the database connection when the command completes.

Command syntax

```
▶▶ TAKEOVER HADR ON DATABASE database-alias
                        DB
▶
USER user-name USING password BY FORCE PEER WINDOW ONLY
```

Command parameters

DATABASE *database-alias*

Identifies the current HADR standby database that should take over as the HADR primary database.

USER *user-name*

Identifies the user name under which the takeover operation is to be started.

USING *password*

The password used to authenticate *user-name*.

BY FORCE

Specifies that the database will not wait for confirmation that the original HADR primary database has been shut down. This option is required if the HADR pair is not in peer state.

PEER WINDOW ONLY

When this option is specified, there will not be any committed transaction loss if the command succeeds and the primary database is brought down before the end of the peer window period (set the database configuration parameter **HADR_PEER_WINDOW** to a non-zero value). Not bringing down the primary database, before the peer window expires, will result in *split brain*. If the **TAKEOVER BY FORCE PEER WINDOW ONLY** command is executed when the HADR pair is not in a peer or disconnected peer state (the peer window has expired), an error is returned.

Note: The takeover operation with the PEER WINDOW ONLY option may behave incorrectly if the primary database clock and the standby database clock are not synchronized to within 5 seconds of each other. That is, the operation may succeed when it should fail, or fail when it should succeed. You should use a time synchronization service (e.g., NTP) to keep the clocks synchronized to the same source.

Usage notes

The following table shows the behavior of the TAKEOVER HADR command when issued on an active standby database for each possible state and option combination. An error message is returned if this command is issued on an inactive standby database.

Standby state	BY FORCE option used	Takeover behavior
Disconnected peer	No	NOT ALLOWED (SQL1770N)
Disconnected peer	Yes, just BY FORCE	ALLOWED - NO ASSURANCE OF DATA CONSISTENCY Note: A "no transaction loss" takeover is also possible using the TAKEOVER BY FORCE command without the PEER WINDOW ONLY option, i.e., unconditional failover, as long as the necessary conditions hold. Such a failover can be executed even long after the expiration of the peer window that was in effect when the primary failed.
Disconnected peer	Yes, BY FORCE PEER WINDOW ONLY	ALLOWED - GREATER DEGREE OF DATA CONSISTENCY There are situations in which data loss can still happen: <ul style="list-style-type: none"> • If the primary database remains active past the time when the peer window expires, and if the primary database still has no connection to the standby database, the primary database will move out of disconnected peer state and resume processing transactions independently. • In NEARSYNC mode, if the standby database fails after acknowledging receipt of transaction logs from the primary database but before writing that transaction log information to disk, then that transaction log information, in the log receive buffer, might be lost.
Local catchup or remote catchup	No	Error message returned
Local catchup or remote catchup	Yes	Error message returned

Standby state	BY FORCE option used	Takeover behavior
Peer	No	<p>Primary database and standby database switch roles.</p> <p>If no failure is encountered during takeover, there will be no data loss. However, if failures are encountered during takeover, data loss might occur and the roles of the primary and standby might or might not have been changed. The following is a guideline for handling failures during a takeover in which the primary and standby switch roles:</p> <ol style="list-style-type: none"> 1. If a failure occurs during a takeover operation, the roles of the HADR databases might or might not have been changed. If possible, make sure both databases are online. Check the HADR role of the available database or databases using the Snapshot Monitor, or by checking the value of the database configuration parameter hadr_db_role. 2. If the intended new primary is still in standby role, and takeover is still desired, re-issue the TAKEOVER HADR command (see the next guideline regarding the BY FORCE option). 3. It is possible to end up with both databases in standby role. In that case, the TAKEOVER HADR command with the BY FORCE option can be issued at whichever node should now become the primary. The BY FORCE option is required in this case because the two standbys cannot establish the usual HADR primary-standby connection.
Peer	Yes	<p>Old primary marked as invalid, preventing it from writing any more logs or committing any more transactions.</p> <p>The next log write attempt brings down the database. However, if sessions on the old primary only run read-only queries, the old primary might stay up indefinitely. Existing client connections stay open as long as they perform read-only operations and new client connections might be accepted.</p> <p>To avoid a situation of dual-primary, it is recommended that you stop transaction processing on old primary first before issuing a TAKEOVER HADR command with the BY FORCE option.</p>
Remote catchup pending	No	Error message returned.
Remote catchup pending	Yes	The standby becomes a primary.

When issuing the TAKEOVER HADR command, the corresponding error codes might be generated: SQL1767N, SQL1769N, or SQL1770N with a reason code of 98. The reason code indicates that there is no installed license for HADR on the server where the command was issued. To correct the problem, install a valid HADR license using the db2licm or install a version of the server that contains a valid HADR license as part of its distribution.

When you issue the `TAKEOVER BY FORCE PEER WINDOW ONLY` command, and it succeeds (you called it while the primary was disconnected from the standby, but still within the peer window), then there will not be any transaction information on the primary database that was not already copied to the standby database.

Chapter 129. TERMINATE

Explicitly terminates the command line processor's back-end process.

Authorization

None

Required connection

None

Command syntax

»—TERMINATE—«

Command parameters

None

Usage notes

If an application is connected to a database, or a process is in the middle of a unit of work, TERMINATE causes the database connection to be lost. An internal commit is then performed.

Although TERMINATE and CONNECT RESET both break the connection to a database, only TERMINATE results in termination of the back-end process.

It is recommended that TERMINATE be issued prior to executing the db2stop command. This prevents the back-end process from maintaining an attachment to a database manager instance that is no longer available.

Back-end processes in MPP systems must also be terminated when the DB2NODE environment variable is updated in the session. This environment variable is used to specify the coordinator database partition number within an MPP multiple logical node configuration.

Chapter 130. UNCATALOG DATABASE

Deletes a database entry from the database directory.

Authorization

One of the following:

- *sysadm*
- *sysctrl*

Required connection

None. Directory operations affect the local directory only.

Command syntax

```
►► UNCATALOG DATABASE database-alias ◀◀
```

Command parameters

DATABASE *database-alias*

Specifies the alias of the database to uncatalog.

Usage notes

Only entries in the local database directory can be uncataloged. Entries in the system database directory can be deleted using the DROP DATABASE command.

To recatalog the database on the instance, use the UNCATALOG DATABASE and CATALOG DATABASE commands. To list the databases that are cataloged on a node, use the LIST DATABASE DIRECTORY command.

The authentication type of a database, used when communicating with an earlier server, can be changed by first uncataloging the database, and then cataloging it again with a different type.

If directory caching is enabled, database, node, and DCS directory files are cached in memory. See the information for the configuration parameter **dir_cache** in the GET DATABASE MANAGER CONFIGURATION command. An application's directory cache is created during its first directory lookup. Because the cache is only refreshed when the application modifies any of the directory files, directory changes made by other applications might not be effective until the application has restarted.

To refresh the CLP's directory cache, use the TERMINATE command. To refresh the database manager's shared cache, stop (db2stop) and then restart (db2start) the database manager. To refresh the directory cache for another application, stop and then restart that application.

Note: When you add a database partition to the system, all existing databases in the instance are expanded to the new database partition. However, any

uncataloged database is not recognized when adding a new database partition. The uncataloged database will not be present on the new database partition. An attempt to connect to the database on the new database partition returns the error message SQL1013N.

Chapter 131. UNCATALOG DCS DATABASE

Deletes an entry from the Database Connection Services (DCS) directory.

Authorization

One of the following:

- *sysadm*
- *sysctrl*

Required connection

None. Directory operations affect the local directory only.

Command syntax

```
►►—UNCATALOG DCS—

|            |
|------------|
| —DATABASE— |
| —DB—       |

—database-alias—►►
```

Command parameters

DATABASE *database-alias*

Specifies the alias of the DCS database to uncatalog.

Usage notes

DCS databases are also cataloged in the system database directory as remote databases and can be uncataloged using the UNCATALOG DATABASE command.

To recatalog a database in the DCS directory, use the UNCATALOG DCS DATABASE and CATALOG DCS DATABASE commands. To list the DCS databases that are cataloged on a node, use the LIST DCS DIRECTORY command.

If directory caching is enabled, database, node, and DCS directory files are cached in memory. See the information provided for the configuration parameter **dir_cache** in the output of the GET DATABASE MANAGER CONFIGURATION command. An application's directory cache is created during its first directory lookup. Since the cache is only refreshed when the application modifies any of the directory files, directory changes made by other applications might not be effective until the application has restarted.

To refresh the CLP's directory cache, use the TERMINATE command. To refresh DB2's shared cache, stop (db2stop) and then restart (db2start) the database. To refresh the directory cache for another application, stop and then restart that application.

Chapter 132. UNCATALOG LDAP DATABASE

Used to deregister the database from Lightweight Directory Access Protocol (LDAP).

Authorization

None

Required connection

None

Command syntax

```
►► UNCATALOG LDAP DATABASE dbalias
    └──┬──┘
      DB
      └──┬──┘
        USER username
          └──┬──┘
            PASSWORD password
```

Command parameters

DATABASE *dbalias*

Specifies the alias of the LDAP database to uncatalog.

USER *username*

Specifies the user's LDAP distinguished name (DN). The LDAP user DN must have sufficient authority to delete the object from the LDAP directory. If the user's LDAP DN is not specified, the credentials of the current logon user will be used.

PASSWORD *password*

Account password.

Usage notes

When a database is dropped, the database object is removed from LDAP. The database is also automatically deregistered from LDAP when the database server that manages the database is deregistered from LDAP. It might, however, be necessary to manually uncatalog the database from LDAP if:

- The database server does not support LDAP. The administrator must manually uncatalog each database from LDAP after the database is dropped.
- During DROP DATABASE, the database object cannot be removed from LDAP (because LDAP cannot be accessed). In this case, the database is still removed from the local machine, but the existing entry in LDAP is not deleted.

Chapter 133. UNCATALOG LDAP NODE

Uncatalogs a node entry in Lightweight Directory Access Protocol (LDAP).

Authorization

None

Required connection

None

Command syntax

```
►►—UNCATALOG LDAP—NODE—nodename—┬──USER—username—┬──PASSWORD—password—┘
```

Command parameters

NODE *nodename*

Specifies the name of the node to uncatalog.

USER *username*

Specifies the user's LDAP distinguished name (DN). The LDAP user DN must have sufficient authority to delete the object from the LDAP directory. If the user's LDAP DN is not specified, the credentials of the current logon user will be used.

PASSWORD *password*

Account password.

Usage notes

The LDAP node is automatically uncataloged when the DB2 server is deregistered from LDAP.

Chapter 134. UNCATALOG NODE

Deletes an entry from the node directory.

Authorization

One of the following:

- *sysadm*
- *sysctrl*

Required connection

None. Directory operations affect the local directory only.

Command syntax

►►—UNCATALOG NODE—*nodename*—————◄◄

Command parameters

NODE *nodename*

Specifies the node entry being uncataloged.

Usage notes

UNCATALOG NODE can be executed on any type of node, but only the local directory is affected, even if there is an attachment to a remote instance, or a different local instance.

If directory caching is enabled, database, node, and DCS directory files are cached in memory. To see if directory caching is enabled, check the value for the *dir_cache* directory cache support configuration parameter in the output from the GET DATABASE MANAGER CONFIGURATION command. An application's directory cache is created during its first directory lookup. Since the cache is only refreshed when the application modifies any of the directory files, directory changes made by other applications might not be effective until the application has restarted.

To refresh the CLP's directory cache, use the TERMINATE command. To refresh the database manager's shared cache, stop (*db2stop*) and then restart (*db2start*) the database manager. To refresh the directory cache for another application, stop and then restart that application.

Chapter 135. UNCATALOG ODBC DATA SOURCE

Uncatalogs a user or system ODBC data source.

A *data source*, in ODBC (Open Database Connectivity) terminology, is a user-defined name for a specific database. That name is used to access the database through ODBC APIs. On Windows, either user or system data sources can be uncataloged. A user data source is only visible to the user who cataloged it, whereas a system data source is visible to and can be used by all other users.

This command is available on Windows only.

Authorization

None

Required connection

None

Command syntax

```
►►—UNCATALOG—

|        |
|--------|
| USER   |
| SYSTEM |

—ODBC DATA SOURCE—data-source-name—►►
```

Command parameters

USER Uncatalog a user data source. This is the default if no keyword is specified.

SYSTEM

Uncatalog a system data source.

ODBC DATA SOURCE *data-source-name*

Specifies the name of the data source to be uncataloged. Maximum length is 32 characters.

Usage notes

On Microsoft Windows Vista or later versions, you must execute the UNCATALOG SYSTEM ODBC DATA SOURCE command from a DB2 command window running with full administrator privileges.

Chapter 136. UNQUIESCE

Restores user access to instances or databases which have been quiesced for maintenance or other reasons. UNQUIESCE restores user access without necessitating a shutdown and database restart.

Unless specifically designated, no user except those with *sysadm*, *sysmaint*, or *sysctrl* has access to a database while it is quiesced. Therefore an UNQUIESCE is required to restore general access to a quiesced database.

Scope

UNQUIESCE DB restores user access to all objects in the quiesced database.

UNQUIESCE INSTANCE *instance-name* restores user access to the instance and the databases in the instance *instance-name*.

To stop the instance and unquiesce it and all its databases, issue the *db2stop* command. Stopping and restarting DB2 will unquiesce all instances and databases.

Authorization

One of the following:

For database level unquiesce:

- *sysadm*
- *dbadm*

For instance level unquiesce:

- *sysadm*
- *sysctrl*

Command syntax

```
►► UNQUIESCE — DB —————►►  
                  └─ INSTANCE — instance-name ─┘
```

Required connection

Database

(Database connection is not required for an instance unquiesce.)

Command parameters

DB Unquiesce the database. User access will be restored to all objects in the database.

INSTANCE *instance-name*

Access is restored to the instance *instance-name* and the databases in the instance.

Examples

Unquiescing a Database

```
db2 unquiesce db
```

This command will unquiesce the database that had previously been quiesced.

Chapter 137. UPDATE ADMIN CONFIGURATION

Modifies specified entries in the DB2 Administration Server (DAS) configuration file. The DAS is a special administrative tool that enables remote administration of DB2 servers.

When you install the DAS, a blank copy of the configuration file is stored on each physical database partition. You must create entries in each copy. You can specify the following DAS configuration parameters to be used the next time you start the DAS:

- Name of the DB2 Server System - **db2system**
- DAS Administration Authority Group Name - **dasadm_group**
- Scheduler Mode - **sched_enable**
- Tools Catalog Database Instance - **toolscat_inst**
- Tools Catalog Database - **toolscat_db**
- Tools Catalog Database Schema - **toolscat_schema**
- Execute Expired Tasks - **exec_exp_task**
- Scheduler User ID - **sched_userid**
- Authentication Type DAS - **authentication**

The following DAS configuration parameters can be specified originally and then later changed while the DAS is online:

- DAS Discovery Mode - **discover**
- SMTP Server - **smtp_server**
- Java Development Kit Installation Path DAS - **jdk_path**
- Location of Contact List - **contact_host**
- DAS Code Page - **das_codepage**
- DAS Territory - **das_territory**

For more information about these parameters, see individual parameter descriptions.

Scope

Issue this command from each administration node to specify or change parameter settings for that node.

Authorization

dasadm

Required connection

Node. To update the DAS configuration for a remote system, use the FOR NODE option with the administrator node name.

Command syntax

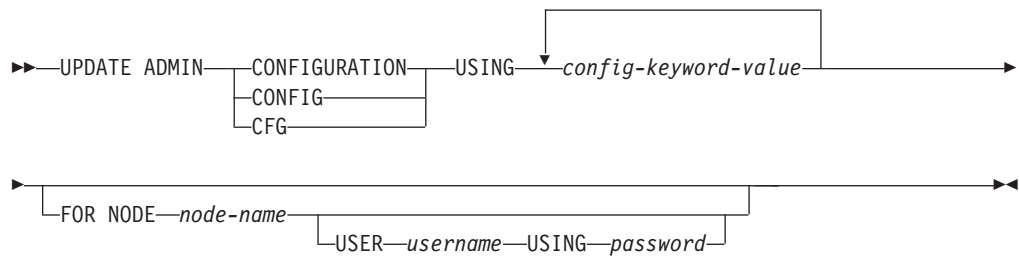

Command parameters

USING *config-keyword-value*

Specifies the admin configuration parameter to be updated.

FOR NODE

Enter the name of an administration node to update the DAS configuration parameters there.

USER *username* **USING** *password*

If connection to the administration node requires user name and password authorization, enter this information.

Usage notes

To view or print a list of the DAS configuration parameters, use GET ADMIN CONFIGURATION. To reset the DAS configuration parameters to the recommended DAS defaults, use RESET ADMIN CONFIGURATION.

When configuration parameters take effect depends on whether you change a standard configuration parameter or one of the parameters that can be reset online. Standard configuration parameter values are reset when you execute the db2admin command.

If an error occurs, the DAS configuration file is not changed.

In order to update the DAS configuration using UPDATE ADMIN CONFIGURATION, you must use the command line processor from an instance that is at the same installed level as the DAS.

The DAS configuration file cannot be updated if the checksum is invalid. This might occur if you change the DAS configuration file manually, without using the appropriate command. If this happens, you must drop and re-create the DAS to reset its configuration file.

Chapter 138. UPDATE ALERT CONFIGURATION

Updates the alert configuration settings for health indicators.

Important: This command or API has been deprecated and might be removed in a future release because the health monitor has been deprecated in Version 9.7. For more information, see the “Health monitor has been deprecated” topic in the *What’s New for DB2 Version 9.7* book.

Authorization

One of the following:

- *sysadm*
- *sysmaint*
- *sysctrl*

Required Connection

Instance. An explicit attachment is not required.

Command Syntax

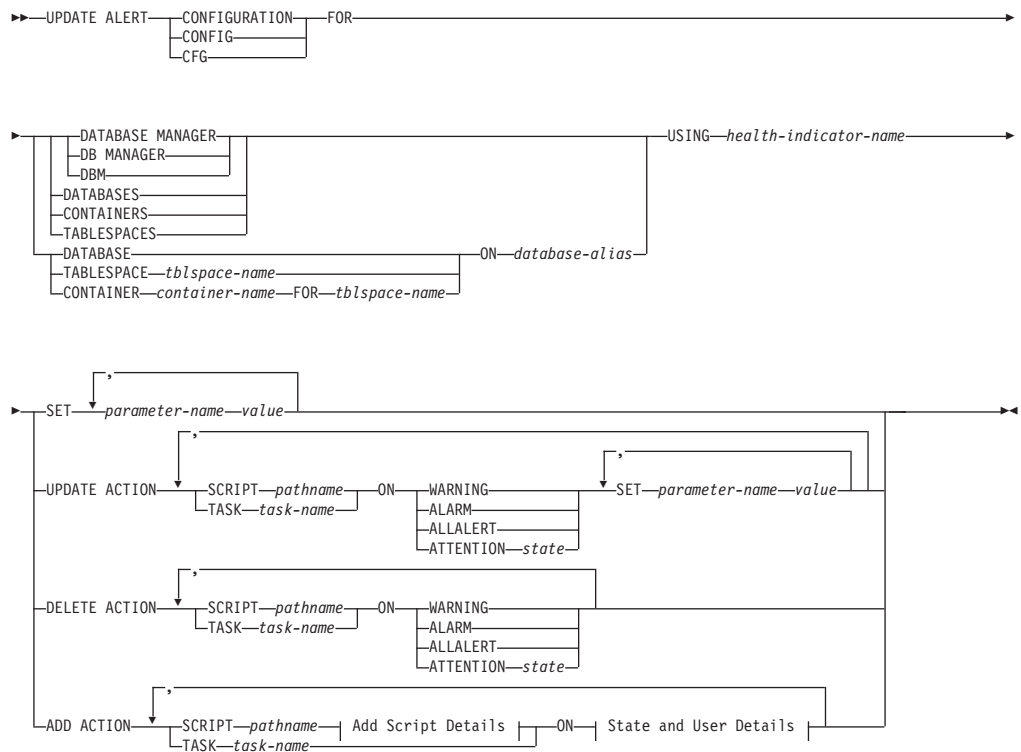

Add Script Details:

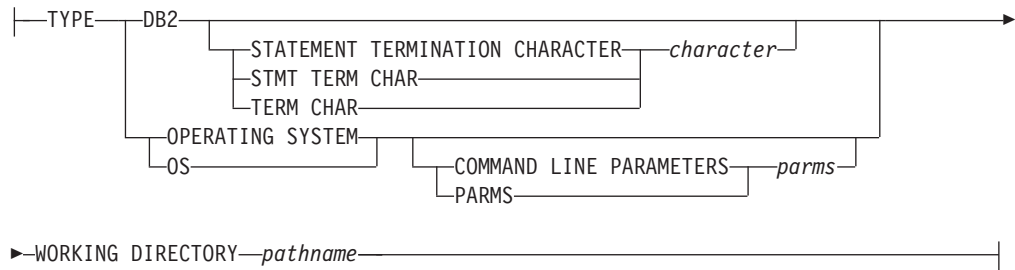

State and User Details:

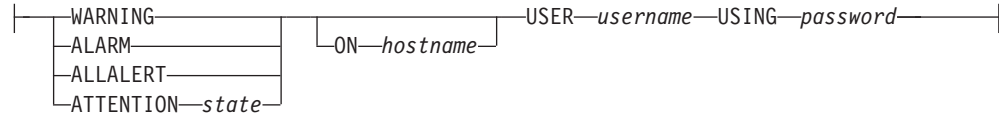

Command Parameters

DATABASE MANAGER

Updates alert settings for the database manager.

DATABASES

Updates alert settings for all databases managed by the database manager. These are the settings that apply to all databases that do not have custom settings. Custom settings are defined using the `DATABASE ON database-alias` clause.

CONTAINERS

Updates alert settings for all table space containers managed by the database manager. These are the settings that apply to all table space containers that do not have custom settings. Custom settings are defined using the `CONTAINER container-name ON database-alias` clause.

TABLESPACES

Updates alert settings for all table spaces managed by the database manager. These are the settings that apply to all table spaces that do not have custom settings. Custom settings are defined using the `TABLESPACE tblspace-name ON database-alias` clause.

DATABASE ON *database-alias*

Updates the alert settings for the database specified using the `ON database-alias` clause. If this database has custom settings, then they override the settings for all databases for the instance, which is specified using the `DATABASES` parameter.

CONTAINER *container-name* FOR *tblspace-name* ON *database-alias*

Updates the alert settings for the table space container called *container-name*, for the table space specified using the `FOR tblspace-name` clause, on the database specified using the `ON database-alias` clause. If this table space container has custom settings, then they override the settings for all table space containers for the database, which is specified using the `CONTAINERS` parameter.

TABLESPACE *tblspace-name* ON *database-alias*

Updates the alert settings for the table space called *name*, on the database specified using the `ON database-alias` clause. If this table space has custom settings, then they override the settings for all table spaces for the database, which is specified using the `TABLESPACES` parameter.

USING *health-indicator-name*

Specifies the set of health indicators for which alert configuration will be updated. Health indicator names consist of a two-letter object identifier followed by a name which describes what the indicator measures. For example:

```
db.sort_privmem_util
```

SET *parameter-name value*

Updates the alert configuration element, *parameter-name*, of the health indicator to the specified value. *parameter-name* must be one of the following:

- ALARM: the *value* is a health indicator unit.
- WARNING: the *value* is a health indicator unit.
- SENSITIVITY: the *value* is in seconds.
- ACTIONSENABLED: the *value* can be either YES or NO.
- THRESHOLDSCHECKED: the *value* can be either YES or NO.

UPDATE ACTION SCRIPT *pathname* ON [WARNING | ALARM | ALLALERT | ATTENTION *state*]

Specifies that the script attributes of the predefined script with absolute pathname *pathname* will be updated according to the following clause:

SET *parameter-name value*

Updates the script attribute, *parameter-name*, to the specified value. *parameter-name* must be one of the following:

- SCRIPTTYPE
OS or DB2 are the valid types.
- WORKINGDIR
- TERMCHAR
- CMDLINEPARMS

The command line parameters that you specify for the operating system script will precede the default supplied parameters. The parameters that are sent to the operating system script are:

- List of user supplied parameters
- Health indicator short name
- Fully qualified object name
- Health indicator value
- Alert state
- USERID
- PASSWORD
- SYSTEM

UPDATE ACTION TASK *task-name* ON [WARNING | ALARM | ALLALERT | ATTENTION *state*]

Specifies that the task attributes of the task with name *name* will be updated according to the following clause:

SET *parameter-name value*

Updates the task attribute, *parameter-name*, to the specified value. *parameter-name* must be one of the following:

- USERID
- PASSWORD
- SYSTEM

DELETE ACTION SCRIPT *pathname* ON [WARNING | ALARM | ALLALERT | ATTENTION *state*]

Removes the action script with absolute pathname *pathname* from the list of alert action scripts.

DELETE ACTION TASK *task-name* ON [WARNING | ALARM | ALLALERT | ATTENTION *state*]

Removes the action task called *name* from the list of alert action tasks.

ADD ACTION SCRIPT *pathname* ON [WARNING | ALARM | ALLALERT | ATTENTION *state*]

Specifies that a new action script with absolute pathname *pathname* is to be added, the attributes of which are given by the following:

TYPE An action script must be either a DB2 Command script or an operating system script:

- DB2
- OPERATING SYSTEM

If it is a DB2 Command script, then the following clause allows one to optionally specify the character, *character*, that is used in the script to terminate statements:

STATEMENT TERMINATION CHARACTER ;

If it is an operating system script, then the following clause allows one to optionally specify the command-line parameters, *parms*, that would be passed to the script upon invocation: COMMAND LINE PARAMETERS *parms*

WORKING DIRECTORY *pathname*

Specifies the absolute pathname, *pathname*, of the directory in which the script will be executed.

USER *username* **USING** *password*

Specifies the user account, *username*, and associated password, *password*, under which the script will be executed.

ADD ACTION TASK *name* ON [WARNING | ALARM | ALLALERT | ATTENTION *state*]

Specifies that a new task, called *name*, is to be added to be run ON the specified condition.

ON [WARNING | ALARM | ALLALERT | ATTENTION *state*]

Specifies the condition on which the action or task will run. For threshold-based health indicators (HIs), this is WARNING or ALARM. For state-based HIs, this will be a numeric state as documented for each state-based HI (for example, for the *ts.ts_op_status* health indicator, refer to the *tablespace_state* monitor element for table space states).

ATTENTION *state*

Valid numerical values for some of the database health indicator states are given below as an example for the ADD ACTION SCRIPT CLP command option:

- 0 - Active; Normal (ACTIVE)
- 1 - Quiesce pending (QUIESCE_PEND)
- 2 - Quiesced (QUIESCED)
- 3 - Rollforward (ROLLFWD)

Additional state-based health indicators are defined in the header files *sqlmon.h* and *sqlutil.h*.

Usage notes

For the ADD ACTION option, the supplied *username* and *password* may be exposed in various places where SQL statement text is captured:

- the network (username/password are passed over the wire unencrypted)
- db2diag log file
- trace files
- dump file
- snapshot monitor (dynamic SQL snapshot)
- system monitor snapshots
- a number of event monitors (statement, deadlock)
- query patroller
- explain tables
- db2pd output (package cache and lock timeout mechanisms, among others)
- DB2 audit records

Chapter 139. UPDATE ALTERNATE SERVER FOR DATABASE

Updates the alternate server for a database alias in the system database directory.

Scope

This command only affects the database partition on which it is executed.

Authorization

One of the following:

- *sysadm*
- *sysctrl*

Required connection

None

Command syntax

```
➤—UPDATE ALTERNATE SERVER FOR—DATABASE—database-alias—USING—➤  
                                  └─DB─┘  
➤—HOSTNAME—hostname—PORT—port-number—➤
```

Command parameters

DATABASE *database-alias*

Specifies the alias of the database where the alternate server is to be updated.

HOSTNAME *hostname*

Specifies a fully qualified host name or the IP address of the node where the alternate server for the database resides.

PORT *port-number*

Specifies the port number of the alternate server of the database manager instance.

Examples

The following example updates the alternate server for the SAMPLE database using host name montero and port 20396:

```
db2 update alternate server for database sample using hostname montero port 20396
```

The following two examples reset the alternate server for the SAMPLE database:

```
db2 update alternate server for database sample using hostname NULL port NULL
```

or

```
db2 update alternate server for database sample using hostname "" port NULL
```

Usage notes

- This command is only applied to the system database directory.

- This command should only be used on a server instance. If it is issued on a client instance, it is ignored and message SQL1889W is returned.
- If Lightweight Directory Access Protocol (LDAP) support is enabled on the machine on which the command is issued, the alternate server for the database will be automatically registered in the LDAP directory.

Chapter 140. UPDATE ALTERNATE SERVER FOR LDAP DATABASE

Updates the alternate server for a database in Lightweight Directory Access Protocol (LDAP).

Authorization

Read/write access to the LDAP server.

Required connection

None

Command syntax

```
►►—UPDATE ALTERNATE SERVER FOR LDAP—DATABASE—database-alias—►►
      └──┬──┘
      DB
►—USING—NODE—node—┬──┬──USER—username—┬──┬──►►
      └──┬──┘   └──┬──┘   └──┬──┘
      GWNODE—gwnode   PASSWORD—password
```

Command parameters

DATABASE *database-alias*

Specifies the alias of the database to be updated.

NODE *node*

Specifies the node name where the alternate server for the database resides.

GWNODE *gwnode*

Specifies the node name where the alternate gateway for the database resides.

USER *username*

Specifies the user's LDAP distinguished name (DN). The LDAP user DN must have sufficient authority to create the object in the LDAP directory. If the user's LDAP DN is not specified, the credentials of the current logon user will be used.

If the user's LDAP DN and password have been specified using db2ldcfg, the user name and password do not have to be specified here.

PASSWORD *password*

Account password.

If the user's LDAP DN and password have been specified using db2ldcfg, the user name and password do not have to be specified here.

Chapter 141. UPDATE CLI CONFIGURATION

Updates the contents of a specified section in the `db2cli.ini` file.

The `db2cli.ini` file is used as the DB2 call level interface (CLI) configuration file. It contains various keywords and values that can be used to modify the behavior of the DB2 CLI and the applications using it. The file is divided into sections, each section corresponding to a database alias name.

Authorization

None

Required connection

None

Command syntax

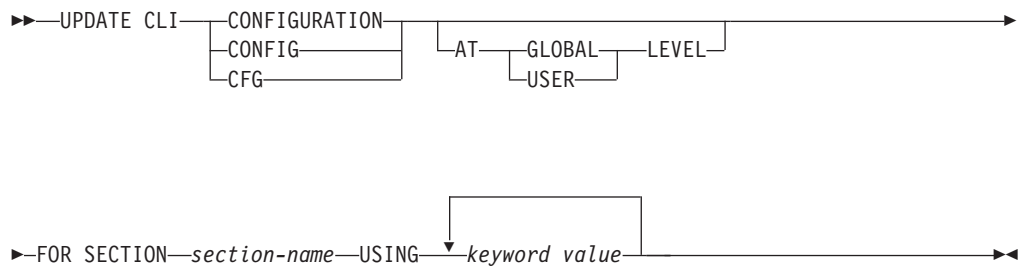

Command parameters

FOR SECTION *section-name*

Name of the section whose keywords are to be updated. If the specified section does not exist, a new section is created.

AT GLOBAL LEVEL

Specifies that the CLI configuration parameter is to be updated at the global level. This parameter is only applicable when LDAP support is enabled.

AT USER LEVEL

Specifies that the CLI configuration parameter is to be updated at the user level. If LDAP support is enabled, this setting will be consistent when logging on to different machines with the same LDAP user ID. If LDAP support is disabled, this setting will be consistent only when logging on to the same machine with the same operating system user ID.

USING *keyword value*

Specifies the CLI/ODBC parameter to be updated.

Usage notes

The section name and the keywords specified on this command are not case sensitive. However, the keyword values *are* case sensitive.

If a keyword value is a string containing single quotation marks or imbedded blanks, the entire string must be delimited by double quotation marks. For example:

```
db2 update cli cfg for section tstcli1x
using TableType "'TABLE','VIEW','SYSTEM TABLE'"
```

When the AT USER LEVEL keywords are specified, the CLI configuration parameters for the specified section are updated only for the current user; otherwise, they are updated for all users on the local machine. The CLI configuration at the user level is maintained in the LDAP directory and cached on the local machine. When reading the CLI configuration, DB2 always reads from the cache. The cache is refreshed when:

- The user updates the CLI configuration.
- The user explicitly forces a refresh of the CLI configuration using the REFRESH LDAP command.

In an LDAP environment, users can configure a set of default CLI settings for a database catalogued in the LDAP directory. When an LDAP cataloged database is added as a DSN (Data Source Name), either by using the CA (Configuration Assistant) or the ODBC configuration utility, any default CLI settings, if they exist in the LDAP directory, will be configured for that DSN on the local machine. The AT GLOBAL LEVEL clause must be specified to configure a CLI parameter as a default setting.

Chapter 142. UPDATE COMMAND OPTIONS

Sets one or more command options during an interactive session, or from a batch input file. The settings revert to system defaults (or the system default overrides in DB2OPTIONS) when the interactive session or batch input file ends.

Authorization

None

Required connection

None

Command syntax

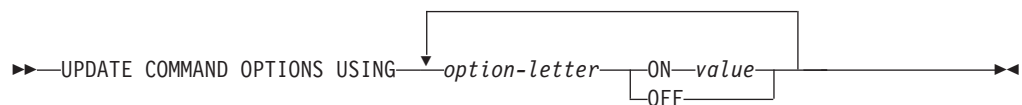

Command parameters

USING *option-letter*

The following option-letters can be set:

- a** Display SQLCA
- c** Auto-commit SQL statements
- d** Display the XML declarations of XML data
- e** Display SQLCODE/SQLSTATE
- i** Display XQuery results with proper indentation
- l** Log commands in a history file
- m** Display the number of rows affected by INSERT, DELETE, UPDATE or MERGE statements.
- n** Remove new line character
- o** Display to standard output
- p** Display DB2 interactive prompt
- q** Preserve whitespace and line feeds in strings delimited with single or double quotation marks.
- r** Save output report to a file
- s** Stop execution on command error
- v** Echo current command
- w** Show SQL statement warning messages
- z** Redirect all output to a file.

ON *value*

The e, l, r, and z options require a value if they are turned on. For the e option, *value* can be c to display the SQLCODE, or s to display the SQLSTATE. For the l, r, and z options, *value* represents the name to be used for the history file or the report file. No other options accept a value.

Usage notes

These settings override system defaults, settings in DB2OPTIONS, and options specified using the command line option flags.

The file input option (-f) and the statement termination option (-t) cannot be updated using this command.

To view the current option settings, use the LIST COMMAND OPTIONS command.

Chapter 143. UPDATE CONTACT

Updates the attributes of a contact that is defined on the local system. A contact is a user to whom the Scheduler and Health Monitor send messages. To create a contact, use the ADD CONTACT command. The setting of the Database Administration Server (DAS) `contact_host` configuration parameter determines whether the list is local or global.

Authorization

None

Required connection

None. Local execution only: this command cannot be used with a remote connection.

Command syntax

```
▶▶ UPDATE CONTACT name USING keyword value ◀◀
```

Command parameters

UPDATE CONTACT *name*

The name of the contact that will be updated.

USING *keyword value*

Specifies the contact parameter to be updated (*keyword*) and the value to which it will be set (*value*). The valid set of keywords is:

ADDRESS

The email address that is used by the SMTP server to send the notification.

TYPE Whether the address is for an email address or a pager.

MAXPAGELEN

The maximum number of characters that the pager can accept.

DESCRIPTION

A textual description of the contact. This has a maximum length of 128 characters.

Chapter 144. UPDATE CONTACTGROUP

Updates the attributes of a contact group that is defined on the local system. A contact group is a list of users who should be notified by the Scheduler and the Health Monitor. The setting of the Database Administration Server (DAS) `contact_host` configuration parameter determines whether the list is local or global.

Authorization

None

Required Connection

None

Command Syntax

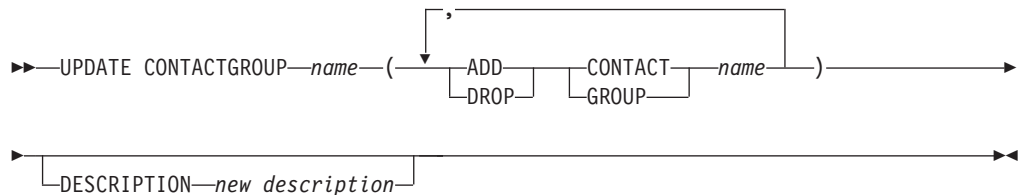

Command Parameters

CONTACTGROUP *name*

Name of the contact group which will be updated.

ADD CONTACT *name*

Specifies the name of the new contact to be added to the group. A contact can be defined with the `ADD CONTACT` command after it has been added to a group.

DROP CONTACT *name*

Specifies the name of a contact in the group that will be dropped from the group.

ADD GROUP *name*

Specifies the name of the new contact group to be added to the group.

DROP GROUP *name*

Specifies the name of a contact group that will be dropped from the group.

DESCRIPTION *new description*

Optional. A new textual description for the contact group.

Chapter 145. UPDATE DATABASE CONFIGURATION

Modifies individual entries in a specific database configuration file.

A database configuration file resides on every database partition on which the database has been created.

Scope

This command updates all database partitions by default, except when DBPARTITIONNUM is specified to update only one database partition.

Authorization

One of the following:

- *sysadm*
- *sysctrl*
- *sysmaint*

Required connection

Instance. An explicit attachment is not required, but a database connection is recommended when the database is active. If the database is listed as remote, an instance attachment to the remote node is established for the duration of the command. To change a parameter online, you must be connected to the database.

Command syntax

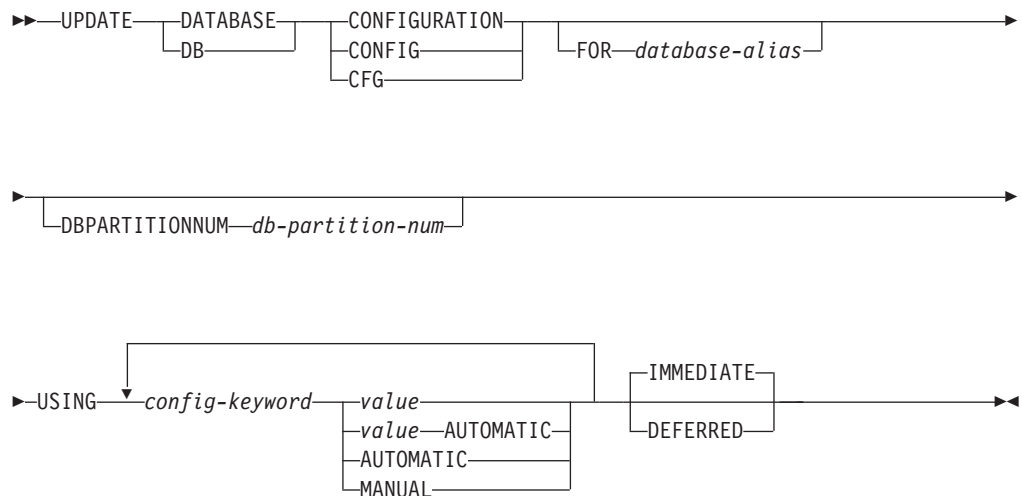

Command parameters

AUTOMATIC

Some configuration parameters can be set to `AUTOMATIC`, allowing DB2 to automatically adjust these parameters to reflect the current resource requirements. For a list of configuration parameters that support the `AUTOMATIC` keyword, refer to the configuration parameters summary. If

a value is specified along with the AUTOMATIC keyword, it might influence the automatic calculations. For specific details about this behavior, refer to the documentation for the configuration parameter.

DEFERRED

Make the changes only in the configuration file, so that the changes take effect the next time you reactivate the database.

FOR *database-alias*

Specifies the alias of the database whose configuration is to be updated. Specifying the database alias is not required when a database connection has already been established. You can update the configuration file for another database residing under the same database instance. For example, if you are connected only to database db11, and issue `update db config for alias db22 using immediate`:

- If there is no active connection on db22, the update will be successful because only the configuration file needs to be updated. A new connection (which will activate the database) will see the new change in memory.
- If there are active connections on db22 from other applications, the update will work on disk but not in memory. You will receive a warning saying that the database needs to be restarted.

DBPARTITIONNUM *db-partition-num*

If a database configuration update is to be applied to a specific database partition, this parameter may be used. If this parameter is not provided, the update will take effect on all database partitions.

IMMEDIATE

Make the changes immediately, while the database is running. IMMEDIATE is the default action, but it requires a database connection to be effective.

This is a default clause when operating in the CLPPlus interface as well. IMMEDIATE need not be called when using CLPPlus processor.

MANUAL

Disables automatic tuning for the configuration parameter. The parameter is set to its current internal value and is no longer updated automatically.

USING *config-keyword value*

config-keyword specifies the database configuration parameter to be updated. *value* specifies the value to be assigned to the parameter.

Examples

Update database configuration on DPF (multi-partition) instance

This example demonstrates how to update database configuration parameter **MAXAPPLS** from 10 to 50 for a database named SAMPLE.

A user has a DPF instance that has 4 partitions as defined in the `db2nodes.cfg`:

```
10 gilera 0
20 gilera 1
30 motobi 0
40 motobi 1
```

The user has created the SAMPLE database on the instance. The catalog partition for SAMPLE is on dbpartitionnum 10. Let's assume the user is logged on to system motobi.

Since the default behavior for a DPF instance is to update the database configurations on all database partitions, the following command issued by users will result in the same value for **MAXAPPLS** across all database partitions:

```
db2 update db cfg for sample using maxappls 50
```

To update **MAXAPPLS** only on dbpartitionnum 30, the following commands may be issued:

```
db2 update db cfg for sample dbpartitionnum 30 using maxappls 50
```

or

```
export DB2NODE=30
db2 update db cfg for sample using maxappls 50
```

Usage notes

To view or print a list of the database configuration parameters, use the GET DATABASE CONFIGURATION command.

To reset all the database configuration parameters to the recommended defaults, use the RESET DATABASE CONFIGURATION command.

To change a database configuration parameter, use the UPDATE DATABASE CONFIGURATION command. For example, to change the logging mode to "archival logging" on a single-partition database environment containing a database called ZELLMART, use:

```
db2 update db cfg for zellmart using logretain recovery
```

To check that the **logretain** configuration parameter has changed, use:

```
db2 get db cfg for zellmart
```

For example, to change the logging mode to "archival logging" on all partitions (provided the registry variable DB2_UPDDBCFG_SINGLE_DBPARTITION is set, by default, to NULL or FALSE) in a multiple-partitioned database environment containing a database called "zellmart", use:

```
db2 update db cfg for zellmart using logretain recovery
```

To check that the **logretain** configuration parameter has changed on all database partitions, use:

```
db2_all ";db2 get db cfg for zellmart"
```

Using the same example as above, but to update the logging mode to only one specific partition (30), use:

```
db2 update db cfg for zellmart dbpartitionnum 30 using logretain recovery
```

Optionally, you can leverage the SYSIBMADM.DBCFG view to get data from all partitions without having to use db2_all.

If you are working on a UNIX operating system, and you have the "grep" command, you can use the following command to view only the **logretain** values:

```
db2_all ";db2 get db cfg for zellmart | grep -i logretain"
```

For more information about DB2 configuration parameters and the values available for each type of database node, see the individual configuration parameter descriptions. The values of these parameters differ for each type of database node configured (server, client, or server with remote clients).

Not all parameters can be updated.

Some changes to the database configuration file become effective only after they are loaded into memory. All applications must disconnect from the database before this can occur. For more information on which parameters are configurable on-line and which ones are not, see summary list of configuration parameters.

For example, to change the **sortheap** database configuration parameter online for the SALES database, enter the following commands:

```
db2 connect to sales
db2 update db cfg using sortheap 1000
db2 connect reset
```

If an error occurs, the database configuration file does not change. The database configuration file cannot be updated if the checksum is invalid. This might occur if the database configuration file is changed without using the appropriate command. If this happens, the database must be restored to reset the database configuration file.

Chapter 146. UPDATE DATABASE MANAGER CONFIGURATION

Modifies individual entries in the database manager configuration file.

Authorization

sysadm

Required connection

None or instance. An instance attachment is not required to perform local DBM configuration operations, but is required to perform remote DBM configuration operations. To update the database manager configuration for a remote instance, it is necessary to first attach to that instance. To update a configuration parameter online, it is also necessary to first attach to the instance.

Command syntax

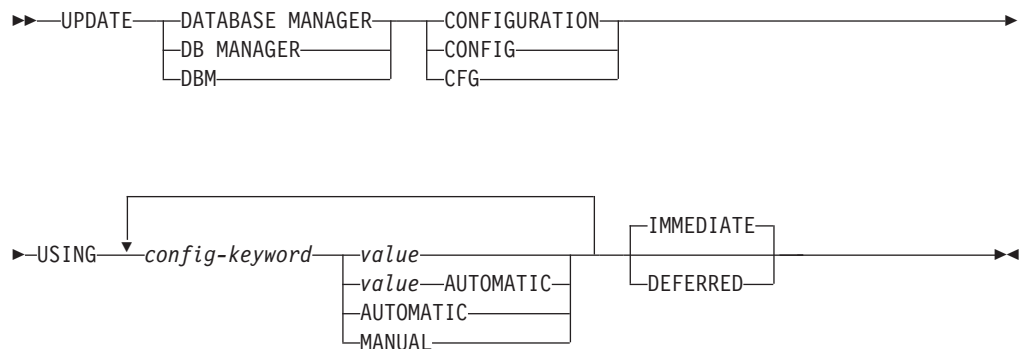

Command parameters

AUTOMATIC

Some configuration parameters can be set to *AUTOMATIC*, allowing DB2 to automatically adjust these parameters to reflect the current resource requirements. For a list of configuration parameters that support the *AUTOMATIC* keyword, refer to the configuration parameters summary. If a value is specified along with the *AUTOMATIC* keyword, it might influence the automatic calculations. For specific details about this behavior, refer to the documentation for the configuration parameter.

Note:

DEFERRED

Make the changes only in the configuration file, so that the changes take effect when the instance is restarted.

This is a default clause when operating in the CLPPlus interface. *DEFERRED* need not be called when using CLPPlus processor.

IMMEDIATE

Make the changes right now, dynamically, while the instance is running. IMMEDIATE is the default, but it requires an instance attachment to be effective.

MANUAL

Disables automatic tuning for the configuration parameter. The parameter is set to its current internal value and is no longer updated automatically.

USING *config-keyword value*

Specifies the database manager configuration parameter to be updated. For a list of configuration parameters, refer to the configuration parameters summary. *value* specifies the value to be assigned to the parameter.

Usage notes

To view or print a list of the database manager configuration parameters, use the GET DATABASE MANAGER CONFIGURATION command. To reset the database manager configuration parameters to the recommended database manager defaults, use the RESET DATABASE MANAGER CONFIGURATION command. For more information about database manager configuration parameters and the values of these parameters appropriate for each type of database node configured (server, client, or server with remote clients), see individual configuration parameter descriptions.

Not all parameters can be updated.

Some changes to the database manager configuration file become effective only after they are loaded into memory. For more information on which parameters are configurable online and which ones are not, see the configuration parameter summary. Server configuration parameters that are not reset immediately are reset during execution of db2start. For a client configuration parameter, parameters are reset the next time you restart the application. If the client is the command line processor, it is necessary to invoke TERMINATE.

For example, to change the **DIAGLEVEL** database manager configuration parameter online for the eastern instance of the database manager, enter the following command:

```
db2 attach to eastern
db2 update dbm cfg using DIAGLEVEL 1
db2 detach
```

If an error occurs, the database manager configuration file does not change.

The database manager configuration file cannot be updated if the checksum is invalid. This can occur if you edit database manager configuration file and do not use the appropriate command. If the checksum is invalid, you must reinstall the database manager to reset the database manager configuration file.

When you update the **SVCENAME**, or **TPNAME** database manager configuration parameters for the current instance, if LDAP support is enabled and there is an LDAP server registered for this instance, the LDAP server is updated with the new value or values.

Chapter 147. UPDATE HEALTH NOTIFICATION CONTACT LIST

Updates the contact list for notification about health alerts issued by an instance.

Authorization

One of the following:

- sysadm
- sysctrl
- sysmaint

Required Connection

Instance. An explicit attachment is not required.

Command Syntax

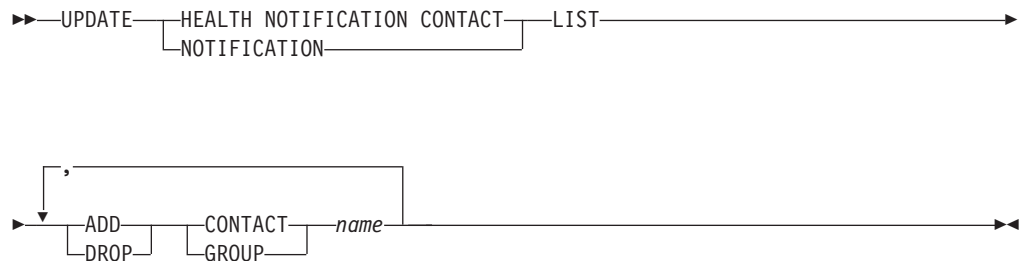

Command Parameters

ADD GROUP *name*

Add a new contact group that will notified of the health of the instance.

ADD CONTACT *name*

Add a new contact that will notified of the health of the instance.

DROP GROUP *name*

Removes the contact group from the list of contacts that will notified of the health of the instance.

DROP CONTACT *name*

Removes the contact from the list of contacts that will notified of the health of the instance.

Chapter 148. UPDATE HISTORY

Updates the location, device type, comment, or status in a history file entry.

Authorization

One of the following:

- *sysadm*
- *sysctrl*
- *sysmaint*
- *dbadm*

Required connection

Database

Command syntax

```
▶▶ UPDATE HISTORY [FOR object-part | EID eid] WITH  
[LOCATION new-location | DEVICE TYPE new-device-type |  
COMMENT new-comment | STATUS new-status]
```

Command parameters

FOR *object-part*

Specifies the identifier for the history entry to be updated. It is a time stamp with an optional sequence number from 001 to 999. This parameter cannot be used to update the entry status. To update the entry status, specify an EID instead.

EID *eid*

Specifies the history entry ID.

LOCATION *new-location*

Specifies the new physical location of a backup image. The interpretation of this parameter depends on the device type.

DEVICE TYPE *new-device-type*

Specifies a new device type for storing the backup image. Valid device types are:

- | | |
|---|------------------------|
| D | Disk |
| K | Diskette |
| T | Tape |
| A | Tivoli Storage Manager |
| F | Snapshot backup |
| U | User exit |
| P | Pipe |

- N Null device
- X XBSA
- Q SQL statement
- O Other

COMMENT *new-comment*

Specifies a new comment to describe the entry.

STATUS *new-status*

Specifies a new status for an entry. Only backup entries can have their status updated. Valid values are:

- A** Active. The backup image is on the active log chain. Most entries are active.
- I** Inactive. Backup images that no longer correspond to the current log sequence, also called the current log chain, are flagged as inactive.
- E** Expired. Backup images that are no longer required, because there are more than NUM_DB_BACKUPS active images, are flagged as expired.
- D** Deleted. Backup images that are no longer available for recovery should be marked as having been deleted.
- X** Do not delete. Recovery history file entries that are marked DB2HISTORY_STATUS_DO_NOT_DELETE will not be pruned by calls to the PRUNE HISTORY command, running the ADMIN_CMD procedure with PRUNE HISTORY, calls to the db2Prune API, or automated recovery history file pruning. You can use the DB2HISTORY_STATUS_DO_NOT_DELETE status to protect key recovery file entries from being pruned and the recovery objects associated with them from being deleted. Only log files, backup images, and load copy images can be marked as DB2HISTORY_STATUS_DO_NOT_DELETE.

Example

To update the history file entry for a full database backup taken on April 13, 1997 at 10:00 a.m., enter:

```
db2 update history for 19970413100000001 with
location /backup/dbbackup.1 device type d
```

Usage notes

The primary purpose of the database history file is to record information, but the data contained in the history is used directly by automatic restore operations. During any restore where the AUTOMATIC option is specified, the history of backup images and their locations will be referenced and used by the restore utility to fulfill the automatic restore request. If the automatic restore function is to be used and backup images have been relocated since they were created, it is recommended that the database history record for those images be updated to reflect the current location. If the backup image location in the database history is not updated, automatic restore will not be able to locate the backup images, but manual restore commands can still be used successfully.

Chapter 149. UPDATE LDAP NODE

Updates the protocol information associated with a node entry that represents the DB2 server in Lightweight Directory Access Protocol (LDAP).

Authorization

None

Required connection

None

Command syntax

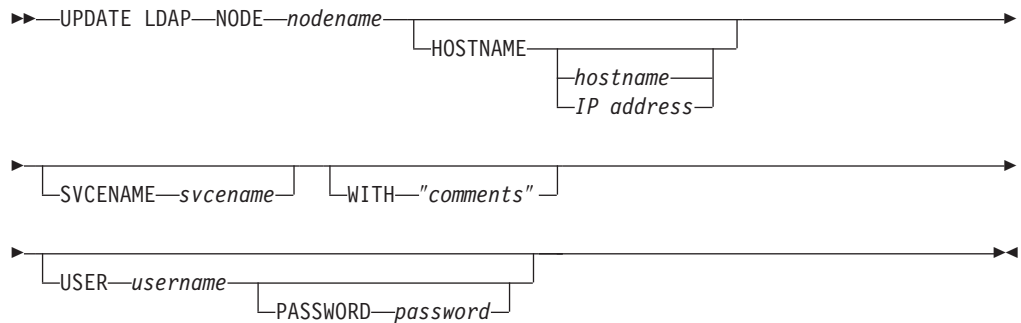

Command parameters

NODE *nodename*

Specifies the node name when updating a remote DB2 server. The node name is the value specified when registering the DB2 server in LDAP.

HOSTNAME *hostname* | *IP address*

Specifies the TCP/IP host name or IP address.

- If it is a TCPIP node, the host name will be resolved to an IPv4 or IPv6 address.
- If it is a TCPIP4 node, the host name will be resolved to an IPv4 address only.
- If it is a TCPIP6 node, the host name will be resolved to an IPv6 address only.

SVCENAME *svcename*

Specifies the TCP/IP service name or port number.

WITH "*comments*"

Describes the DB2 server. Any comment that helps to describe the server registered in the network directory can be entered. Maximum length is 30 characters. A carriage return or a line feed character is not permitted. The comment text must be enclosed by double quotation marks.

USER *username*

Specifies the user's LDAP distinguished name (DN). The LDAP user DN

must have sufficient authority to create and update the object in the LDAP directory. If the user's LDAP DN is not specified, the credentials of the current logon user will be used.

PASSWORD *password*
Account password.

Chapter 150. UPDATE MONITOR SWITCHES

Turns one or more database monitor recording switches on or off. When the database manager starts, the settings of the six switches are determined by the **dft_mon** database manager configuration parameter.

The database monitor records a base set of information at all times. Users who require more than this basic information can turn on the appropriate switches, but at a cost to system performance. The amount of information available in output from the GET SNAPSHOT command reflects which, if any, switches are on.

Authorization

One of the following:

- *sysadm*
- *sysctrl*
- *sysmaint*
- *sysmon*

Required connection

Instance or database:

- If there is neither an attachment to an instance, nor a connection to a database, a default instance attachment is created.
- If there is both an attachment to an instance, and a database connection, the instance attachment is used.

To update the monitor switches at a remote instance (or a different local instance), it is necessary to first attach to that instance.

Command syntax

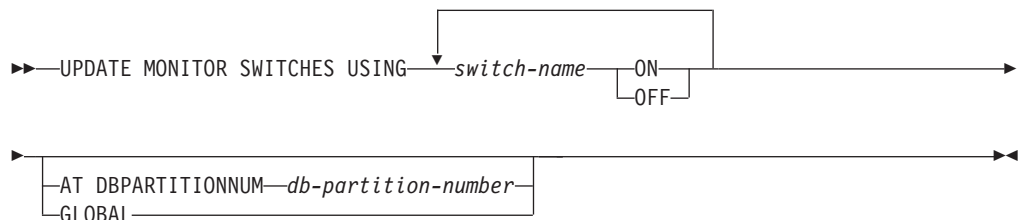

Command parameters

USING *switch-name*

The following switch names are available:

BUFFERPOOL

Buffer pool activity information

LOCK Lock information

SORT Sorting information

STATEMENT
SQL statement information

TABLE
Table activity information

TIMESTAMP
Monitoring timestamp information

UOW Unit of work information.

AT DBPARTITIONNUM *db-partition-number*
Specifies the database partition for which the status of the monitor switches is to be displayed.

GLOBAL
Returns an aggregate result for all database partitions in a partitioned database environment.

Usage notes

Information is collected by the database manager only after a switch is turned on. The switches remain set until `db2stop` is issued, or the application that issued the `UPDATE MONITOR SWITCHES` command terminates. To clear the information related to a particular switch, set the switch off, then on.

Updating switches in one application does not affect other applications.

To view the switch settings, use the `GET MONITOR SWITCHES` command.

Compatibilities

For compatibility with versions earlier than Version 8:

- The keyword `NODE` can be substituted for `DBPARTITIONNUM`.

Chapter 151. UPDATE XMLSCHEMA

Updates one XML schema with another in the XML schema repository (XSR).

Authorization

One of the following:

- *dbadm*
- SELECT privilege on the catalog views SYSCAT.XSROBJECTS and SYSCAT.XSROBJECTCOMPONENTS and one of the following sets of privileges:
 - ALTERIN privilege on the XML schema to be updated and DROPIN privilege on the new XML schema, if the DROP NEW SCHEMA option is specified.
 - OWNER of the XML schema specified by *xmlschema1*.

Required connection

Database

Command syntax

```
➤➤ UPDATE XMLSCHEMA xmlschema1 WITH xmlschema2 [DROP NEW SCHEMA] ➤➤
```

Command parameters

UPDATE XMLSCHEMA *xmlschema1*

Specifies the SQL identifier for the original XML schema to be updated.

WITH *xmlschema2*

Specifies the SQL identifier for the new XML schema that will be used to update the original XML schema.

DROP NEW SCHEMA

Indicates that the new XML schema should be dropped after it is used to update the original XML schema.

Example

```
UPDATE XMLSCHEMA JOHNDOE.OLDPROD  
WITH JOHNDOE.NEWPROD  
DROP NEW SCHEMA
```

The contents of the XML schema JOHNDOE.OLDPROD is updated with the contents of JOHNDOE.NEWPROD, and the XML schema JOHNDOE.NEWPROD is dropped.

Usage notes

- The original and new XML schema must be compatible. For details about the compatibility requirements, see “Compatibility requirements for evolving an XML schema”.
- Before an XML schema can be updated, both the original and the new schema must be registered in the XML schema repository (XSR).

Part 5. System commands

Chapter 152. dasauto - Autostart DB2 administration server

Enables or disables autostarting of the DB2 administration server.

Important: This command has been deprecated and might be removed in a future release because the Control Center and its associated components have been deprecated in Version 9.7. For more information, see the “Control Center tools and DB2 administration server (DAS) have been deprecated” topic in the *What’s New for DB2 Version 9.7* book.

This command is available on Linux and UNIX systems only. It is located in the DB2DIR/das/adm directory, where DB2DIR is the location where the current version of the DB2 database product is installed.

Authorization

dasadm

Required connection

None

Command syntax

►► dasauto -h -? -on -off ◀◀

Command parameters

- h | -?** Displays help information. When this option is specified, all other options are ignored, and only the help information is displayed.
- on** Enables autostarting of the DB2 administration server. The next time the system is restarted, the DB2 administration server will be started automatically.
- off** Disables autostarting of the DB2 administration server. The next time the system is restarted, the DB2 administration server will not be started automatically.

Chapter 153. `dascrt` - Create a DB2 administration server

The DB2 administration server (DAS) provides support services for DB2 tools such as the Control Center and the Configuration Assistant. If a system does not have a DAS, you can use this command to manually generate it.

Important: This command has been deprecated and might be removed in a future release because the Control Center and its associated components have been deprecated in Version 9.7. For more information, see the “Control Center tools and DB2 administration server (DAS) have been deprecated” topic in the *What’s New for DB2 Version 9.7* book.

The `dascrt` command is located in the `DB2DIR/instance` directory, where `DB2DIR` is the location where the current version of the DB2 database product is installed.

This command is available on Linux and UNIX based systems only. On Windows operating systems, you can use the `db2admin create` command for the same purpose.

Authorization

Root authority

Required connection

None

Command syntax

```
▶▶ dascrt -u DASuser [-d] ▶▶
```

Command parameters

`-u DASuser`

DASuser is the user ID under which the DAS will be created. The DAS will be created under the `/home/DASuser/das` directory.

The following restrictions apply:

- If existing IDs are used to create DB2 DAS, make sure that the IDs are not locked and do not have expired passwords.

`-d` Enters debug mode, for use with DB2 Service.

Usage notes

- On AIX 6.1 (or higher), when running this command from a shared DB2 copy in a system workload partition (WPAR) global environment, this command must be run as the root user.

Chapter 154. dasdrop - Remove a DB2 administration server

On Linux and UNIX based systems only, removes the DB2 Administration Server (DAS). The Administration Server provides support services for DB2 tools such as the Control Center and the Configuration Assistant. On Windows operating systems, you can use the db2admin drop command for the same purpose.

Important: This command has been deprecated and might be removed in a future release because the Control Center and its associated components have been deprecated in Version 9.7. For more information, see the “Control Center tools and DB2 administration server (DAS) have been deprecated” topic in the *What’s New for DB2 Version 9.7* book.

Authorization

Root authority

Required connection

None

Command syntax

```
▶▶ dasdrop [-d]
```

Command parameters

-d Enters debug mode, for use with DB2 Service.

Usage notes

- The dasdrop command is located in the DB2DIR/instance directory, where DB2DIR is the location where the current version of the DB2 database product is installed.
- On AIX 6.1 (or higher), when running this command from a shared DB2 copy in a system workload partition (WPAR) global environment, this command must be run as the root user.

Chapter 155. dasmgr - Migrate the DB2 administration server

Migrates the DB2 Administration Server (DAS) on the system from a previous version of DB2 database system (supported for migration to the current version of DB2 database system) to the current version of DB2 database system at the DB2 database level related to the path where the dasmgr is issued.

Important: This command has been deprecated and might be removed in a future release because the Control Center and its associated components have been deprecated in Version 9.7. For more information, see the “Control Center tools and DB2 administration server (DAS) have been deprecated” topic in the *What’s New for DB2 Version 9.7* book.

To move the DAS from one DB2 database system installation location to another within the same version of DB2 database system, the dasupdt command should be used. A DAS at a previous version of a DB2 database system can not be used to administer instances in the current version of DB2 database system.

On Linux and UNIX systems, this utility is located in the DB2DIR/instance directory. On Windows operating systems, it is located in the DB2DIR\bin directory. DB2DIR represents the installation location where the current version of the DB2 database system is installed.

Authorization

Root access on UNIX operating systems or Local Administrator authority on Windows operating systems

Required connection

None

Command syntax

For Linux and UNIX systems

```
▶▶ dasmgr [ -d ]
```

For Windows operating systems

```
▶▶ dasmgr [ -h ] [ -p path override ]
```

Command parameters

For Linux and UNIX systems

-d Enters debug mode, for use with DB2 Service.

For Windows operating systems

-h Displays usage information.

-p *path override*

Indicates that the DAS profile should be moved as well. *path override* is a user specified path to be used instead of the default DAS profile path.

Examples

On Linux and UNIX systems

```
DB2DIR/instance/dasmigr
```

On Windows operating systems

```
DB2DIR\bin\dasmigr
```

Usage notes

- On AIX 6.1 (or higher), when running this command from a shared DB2 copy in a system workload partition (WPAR) global environment, this command must be run as the root user.

Chapter 156. dasupdt - Update DAS

On Linux and UNIX systems, this command updates the DB2 Administration Server (DAS) if the related DB2 database system installation is updated.

Important: This command has been deprecated and might be removed in a future release because the Control Center and its associated components have been deprecated in Version 9.7. For more information, see the “Control Center tools and DB2 administration server (DAS) have been deprecated” topic in the *What’s New for DB2 Version 9.7* book.

This utility is located in the DB2DIR/instance directory, where DB2DIR is the location where the current version of the DB2 database product is installed. You can also use this utility to move the DAS from one installation location to another if both are at the same version of DB2 database system.

After the installation of a Fix Pack, the dasupdt command is executed automatically, if the DAS on the system is related to the DB2 installation path updated by installFixPack.

On Windows operating systems, this command updates the DAS from one DB2 copy to another within the same DB2 database version. To migrate a DAS from an older version, use the dasmigr command. With dasupdt, the DAS will be updated to the DB2 copy that the dasupdt command is executed from. This utility is located in the DB2IPATH\bin directory, where DB2IPATH is the location where the current version of the DB2 database product is installed.

Authorization

Root access on Linux and UNIX systems or Local Administrator authority on Windows operating systems

Required connection

None

Command syntax

For Linux and UNIX systems

```
▶▶ dasupdt [-d] [-D] [-h] [-?]
```

For Windows operating systems

```
▶▶ dasupdt [-h] [-p path override]
```

Command parameters

For Linux and UNIX systems

- d Sets the debug mode, which is used for problem analysis.
- D Moves the DAS from a higher code level on one path to a lower code level installed on another path.
- h | -? Displays usage information.

For Windows operating systems

- h Displays usage information.
- p *path override*
Indicates that the DAS profile should be moved as well. *path override* is a user specified path to be used instead of the default DAS profile path.

Examples

If a DAS is running in one DB2 installation path and you want to move the DAS to another installation path at a lower level (but the two installation paths are at the same version of DB2 database system), issue the following command from the installation path at the lower level:

```
dasupdt -D
```

Usage notes

- On AIX 6.1 (or higher), when running this command from a shared DB2 copy in a system workload partition (WPAR) global environment, this command must be run as the root user.

Chapter 157. db2_deinstall - Uninstall DB2 products, features, or languages

Uninstalls all the installed DB2 products, features, or languages:

- if db2_deinstall is run from a particular DB2 installation path, then it can uninstall everything, or a particular feature or language, from the same path.
- if db2_deinstall is run from DB2 media, then you need to specify a path using the -b option. It can then uninstall everything, or a particular feature or language, from that install path.

It is only available on Linux and UNIX systems.

The db2_deinstall command is located at DB2DIR/install, where DB2DIR is the location where the current version of the DB2 database product is installed. The db2_deinstall command is also available on DB2 media. The db2_deinstall command can be used to uninstall only the DB2 products related to the installation path.

Authorization

Root installations require root authority. For non-root installations, you must log on with the user ID that owns the non-root installation.

Required Connection

None

Command syntax

```
▶▶ db2_deinstall --F feature-name [-a] [-r response-file] [-f sqllib]  
[-b installpath] [-l log-file] [-t trace-file] [-h] [-?]
```

Command parameters

-F *feature-name*

Specifies the removal of one feature. To indicate uninstallation of multiple features, specify this parameter multiple times. For example, -F feature1 -F feature2.

Cannot be used in combination with -a, except in one case. When the feature being removed is the IBM Tivoli System Automation for Multiplatforms, TSAMP, and you have root authority, you can use -F TSAMP and -a in combination, which removes both TSAMP and DB2 together.

Can be used in combination with -r, except in one case. When the feature being removed is the IBM Tivoli System Automation for Multiplatforms, TSAMP, you cannot use -F TSAMP and -r in combination.

The DB2 uninstaller will automatically update the related DB2 instances after it removed some DB2 features. If instance update failed as reported in the log file, you need to manually update the related DB2 instances with the `db2iupdt` (root instances) or `db2nrupdt` (non-root instance) command.

-f sqllib

This option is only valid for non-root install. When it is used with `-a`, the instance top directory and anything underneath will be removed.

- a** Removes all installed DB2 products in the current location. Cannot be used in combination with `-F`, except in one case. When the feature being removed is the IBM Tivoli System Automation for Multiplatforms, TSAMP, and you have root authority, you can use `-F TSAMP` and `-a` in combination, which removes both TSAMP and DB2 together.

Cannot be combined with the `-r` parameter.

In a non-root install, `-a` used with `-f sqllib` will also remove the non-root instance, which includes removal of the `$HOME/sqllib` directory.

-r response-file

Performs an uninstallation of products, features, or languages based on what is specified in the response file. For example, `db2_deinstall -r db2un.rsp`.

Cannot be combined with the `-a` parameter.

Can be combined with the `-F` parameter, except in one case. When the feature being removed is the IBM Tivoli System Automation for Multiplatforms, TSAMP, you cannot use `-F TSAMP` and `-r` in combination.

If both the `-r` and `-F` parameters are specified, the DB2 features specified in the `-F` parameter override the `REMOVE_COMP` keywords in the response file.

The DB2 uninstaller will automatically update the related DB2 instances after it removed some DB2 features. If instance update failed as reported in the log file, you need to manually update the related DB2 instances with the `db2iupdt` (root instances) or `db2nrupdt` (non-root instance) command.

- b** This option is valid if the command is run from the DB2 media. It specifies the absolute path where the DB2 product was installed and will be uninstalled. The command will prompt for the path if the option is not specified.

-l log-file

Specifies the log file. For root installations, the default log file is `/tmp/db2_deinstall.log$$`, where `$$` represents the process ID.

For non-root installations, the default log file is `/tmp/db2_deinstall_<userID>.log`, where `userID` represents the user ID that owns the non-root installation. When the feature being removed is the IBM Tivoli System Automation for Multiplatforms, TSAMP, the install log file for SA MP will be located in the same directory as DB2 log files.

-t trace-file

Turns on the debug mode. The debug information is written to the file name specified as `trace-file`.

- h | -?** Displays help information.

Examples

- To uninstall all the DB2 database products that are installed in a location (DB2DIR), issue the db2_deinstall command located in the DB2DIR/install directory:

```
DB2DIR/install/db2_deinstall -a
```

Usage notes

- If you run db2_deinstall -a -f sqllib, the \$HOME/sqllib directory will be removed. Be certain to backup any files, that require saving, from this directory prior to running the command.
- If you have DB2 Text Search installed and run db2_deinstall -f, if Text Search is running on any instances related to the DB2 copy, you will receive an error message indicating you must first stop the Text Search instance service. Stop the Text Search instance service, then rerun the command.

Chapter 158. db2_install - Install DB2 product

Installs all features of a DB2 product to the given path. This command is available only on Linux and UNIX systems.

Authorization

Root installations require root authority. For non-root installations, you must log on with the user ID that owns the non-root installation.

Required Connection

None

Command syntax

```
db2_install [-b install-path] [-f NOTSAMP] [-f nobackup]
            [-f ignoreType1] [-p productShortName] [-c NLPACK_location]
            [-n] [-m] [-L language] [-l log-file] [-t trace-file]
            [-h]
            [-?]
```

Command parameters

-b *install-path*

Specifies the path where the DB2 product is to be installed. *install-path* must be a full path name and its maximum length is limited to 128 characters. This parameter is mandatory when the *-n* parameter is specified.

The *-b* option is not required for a non-root installation of the DB2 product, but it is still mandatory for a root installation, if the *-n* option is used. If *-b* is used in a non-root install, the path must be valid, which has to be the user's `$HOME/sql1ib`. For both root and non-root install, the length of the absolute installation path is limited to 128 bytes.

-f NOTSAMP

Specifies that the SA MP should not be either installed or updated.

-f *nobackup*

This applies to the non-root upgrade only. Forces `db2_install` to not backup installation files when the components are updated. If you choose not to backup the files, the space requirement of the installation directory is reduced. However, choosing not to backup the files also means that if any errors occur, the DB2 installer will not be able to perform a rollback operation. In this case, you will need to manually clean up the files and reinstall the product.

- f** *ignoreType1*
This applies to the non-root upgrade only. Forces db2_install to ignore type-1 indexes when checking the database status.
- p** *productShortName*
Specifies the DB2 product to be installed. This parameter is case insensitive and is mandatory when the -n parameter is specified. The product short name (*productShortName*) can be found in the file ComponentList.htm (under the product full name) located in the db2/*plat* sub directory on your media where *plat* is the platform name that you are installing on. You can only install one product at a time.
- c** *NLPACK_location*
Specifies the absolute path location of the related DB2 National Language Pack (NLPACK). This parameter is mandatory when -n is specified. The DB2 NLPACK location needs to be provided explicitly if all of the following conditions are met:
 - The -n option is specified.
 - The installation requires National Language (non-English) support.
 - The DB2 NLPACK is neither inside the DB2 product image nor in the same subdirectory as the DB2 product image.
- n** Specifies non-interactive mode. When specified, you must also specify -b, -p, and/or -c.
- m** This option applies to non-root installation only. Specifies upgrade of a non-root copy. During upgrade, all preexisting DB2 products in the current path are removed. Upgrade installs the specified product. Following the upgrade, other DB2 products need to be installed separately.
- L** *language*
Specifies national language support. You can install a non-English version of a DB2 product. However, you must run this command from the product CD, not the National Language pack CD. By default, English is always installed, therefore, English does not need to be specified. When more than one language is required, this parameter is mandatory. To indicate multiple languages, specify this parameter multiple times. For example, to install both French and German, specify -L FR -L DE. This parameter is case insensitive.
- l** *log-file*
Specifies the log file. For root installations, the default log file is /tmp/db2_install.log\$\$, where \$\$ represents the process ID. For non-root installations, the default log file is /tmp/db2_install_userID.log, where *userID* represents the user ID that owns the non-root installation. If the IBM Tivoli System Automation for Multiplatforms (SA MP) is being installed or updated with the db2_install command, the corresponding log file will be located in the same directory as DB2 log files.
- t** *trace-file*
Turns on the debug mode. The debug information is written to the file name specified as *trace-file*.
- h | -?** Displays usage information.

Examples

- To install from an image in /mnt/cdrom, and to be prompted for all needed input, or to install DB2 Enterprise Server Edition from an image in /mnt/cdrom, issue:

```
cd /mnt/cdrom
./db2_install
```

- To install DB2 Enterprise Server Edition to /db2/newlevel, from an image in /mnt/cdrom, non-interactively in English, issue:

```
cd /mnt/cdrom
./db2_install -p ese -b /db2/newlevel -n
```

Usage notes

Default log and trace filenames for a non-root DB2 installation includes the `userID` so as not to overwrite files resulting from root installations of DB2.

The default file names for non-root install will be as follows (the `userID` is the username of the non-root user who performs the non-root installation):

- /tmp/db2_install_`userID`.log
- /tmp/db2_install_`userID`.err
- /tmp/db2_install_`userID`.trc

After the non-root installation is complete, the log file will be copied to `$DB2DIR/install/logs` directory, which is the same directory as for a root installation.

For additional information, see the `-l logfile` command parameter.

Chapter 159. db2_local_ps - DB2 process status for Linux/UNIX

On Linux and UNIX systems, all of the DB2 processes running under an instance can be displayed using the db2_local_ps command.

Authorization

None

Required connection

None

Command syntax

►—db2_local_ps—◄

Command parameters

db2_local_ps

Outputs all of the DB2 processes running under an instance.

Examples

```
[db2inst1@bower1 ~]$ db2_local_ps
Node 0
  UID      PID      PPID     C    STIME    TTY      TIME CMD
db2inst1  3254    3253     0    14:04   pts/1    00:00:00 db2sysc 0
  root     3255    3254     0    14:04   pts/1    00:00:00 db2ckpwd 0
  root     3256    3254     0    14:04   pts/1    00:00:00 db2ckpwd 0
  root     3257    3254     0    14:04   pts/1    00:00:00 db2ckpwd 0
  root     3266    3254     0    14:04   pts/1    00:00:00 db2gds 0
db2inst1  3267    3254     0    14:04   pts/1    00:00:00 db2licc 0
db2inst1  3268    3254     0    14:04   pts/1    00:00:00 db2ipccm 0
db2inst1  3269    3254     0    14:04   pts/1    00:00:00 db2tcpcm 0
db2inst1  3271    3254     0    14:04   pts/1    00:00:00 db2resync 0
db2inst1  3273    3254     0    14:04   pts/1    00:00:00 db2acd ,0,0,0,1,0,0,897b50,...
db2inst1  3297    3266     0    14:04   pts/1    00:00:00 db2loggr (SAMPLE) 0
db2inst1  3299    3266     0    14:04   pts/1    00:00:00 db2loggw (SAMPLE) 0
db2inst1  3300    3266     0    14:04   pts/1    00:00:00 db2lfr (SAMPLE) 0
db2inst1  3301    3266     0    14:04   pts/1    00:00:00 db2dlock (SAMPLE) 0
db2inst1  3303    3266     0    14:04   pts/1    00:00:00 db2pclnr 0
db2inst1  3313    3266     0    14:05   pts/1    00:00:00 db2pfchr 0
db2inst1  3314    3266     0    14:05   pts/1    00:00:00 db2pfchr 0
db2inst1  3315    3266     0    14:05   pts/1    00:00:00 db2pfchr 0
db2inst1  3316    3266     0    14:05   pts/1    00:00:00 db2stmm (SAMPLE) 0
db2inst1  3317    3266     0    14:05   pts/1    00:00:00 db2taskd (TOOLSDB) 0
db2inst1  3318    3266     0    14:05   pts/1    00:00:00 db2taskd (SAMPLE) 0
db2inst1  3319    3266     0    14:05   pts/1    00:00:00 db2stmm (TOOLSDB) 0
db2inst1  3320    3266     0    14:05   pts/1    00:00:00 db2evmgi (DB2DETAILDEADLOCK) 0
db2inst1  3321    3266     0    14:05   pts/1    00:00:00 db2evmgi (DB2DETAILDEADLOCK) 0
db2inst1  3341    3266     0    14:05   pts/1    00:00:00 db2loggr (TOOLSDB) 0
db2inst1  3343    3266     0    14:05   pts/1    00:00:00 db2loggw (TOOLSDB) 0
db2inst1  3344    3266     0    14:05   pts/1    00:00:00 db2lfr (TOOLSDB) 0
db2inst1  3345    3266     0    14:05   pts/1    00:00:00 db2dlock (TOOLSDB) 0
db2inst1  3346    3266     0    14:05   pts/1    00:00:00 db2pclnr 0
db2inst1  3347    3266     0    14:05   pts/1    00:00:00 db2pfchr 0
db2inst1  3348    3266     0    14:05   pts/1    00:00:00 db2pfchr 0
```

db2inst1	3349	3266	0	14:05	pts/1 00:00:00	db2pfchr	0
db2inst1	3270	3268	2	14:04	pts/1 00:00:01	db2agent (TOOLSDB)	0
db2inst1	3285	3268	0	14:04	pts/1 00:00:00	db2agent (SAMPLE)	0

Node 1 ...

Usage notes

Note that processes will not be shown if the instance is stopped. Run the db2start command if processes are not listed.

Chapter 160. db2addicons - Create main menu entries for DB2 tools command

Creates main menu entries for DB2 tools.

On Linux operating systems, the db2addicons command creates main menu entries for DB2 tools for the current user. The main menu entries for DB2 tools are created by manually running the db2addicons command. For the DB2 instance owner, the menu entries are created automatically by instance utilities when the DB2 instance was created, updated or upgraded. If the main menu entries are needed on the desktop of another user, the db2addicons command can be run as that specific user, but the instance environment must first be set within that user's environment before running the command.

Authorization

None

Command syntax

►► db2addicons ◄◄

Command parameters

-h Displays usage information.

Chapter 161. db2admin - DB2 administration server

This utility is used to manage the DB2 Administration Server (DAS). If no parameters are specified, and the DAS exists, this command returns the name of the DAS.

Important: This command has been deprecated and might be removed in a future release because the Control Center and its associated components have been deprecated in Version 9.7. For more information, see the “Control Center tools and DB2 administration server (DAS) have been deprecated” topic in the *What’s New for DB2 Version 9.7* book.

On Linux and UNIX based systems, the executable file for the db2admin command can be found in the DASHOME/das/bin directory, where DASHOME is the home directory of the DAS user. On Windows operating systems, the db2admin executable is found under the DB2PATH\bin directory where DB2PATH is the location where the DB2 copy is installed.

Authorization

dasadm on UNIX operating systems but not associated with a 64-bit instance.

Local administrator on Windows operating systems.

Required connection

None

Command syntax

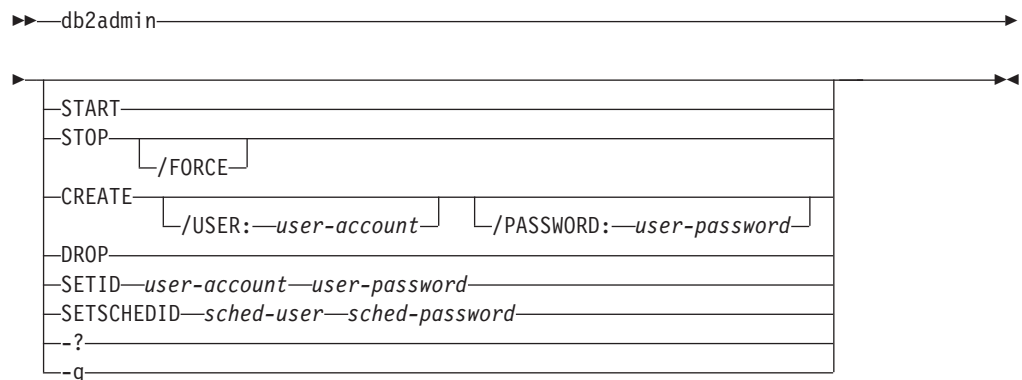

Command parameters

START

Start the DAS.

STOP /FORCE

Stop the DAS. The force option is used to force the DAS to stop, regardless of whether or not it is in the process of servicing any requests.

CREATE /USER: user-account /PASSWORD: user-password

Create the DAS. If a user name and password are specified, the DAS will

be associated with this user account. If the specified values are not valid, the utility returns an authentication error. The specified user account must be a valid SQL identifier, and must exist in the security database. It is recommended that a user account be specified to ensure that all DAS functions can be accessed. To create a DAS on UNIX operating systems, use the `dasrct` command.

DROP Deletes the DAS. To drop a DAS on UNIX operating systems you must use the `dasdrop` command.

SETID *user-account/user-password*
Establishes or modifies the user account associated with the DAS.

SETSCHEDID *sched-user/sched-password*
Establishes the logon account used by the scheduler to connect to the tools catalog database. Only required if the scheduler is enabled and the tools catalog database is remote to the DAS. For more information about the scheduler, see the *Administration Guide*.

-? Display help information. When this option is specified, all other options are ignored, and only the help information is displayed.

-q Run the `db2admin` command in quiet mode. No messages will be displayed when the command is run. This option can be combined with any of the other command options.

Chapter 162. db2adutl - Managing DB2 objects within TSM

Allows users to query, extract, verify, and delete backup images, logs, and load copy images that are saved using Tivoli Storage Manager (TSM). Also allows users to grant and revoke access to objects on a TSM server.

On UNIX operating systems, this utility is located in the sqllib/adsm directory. On Windows operating systems, it is located in sqllib\bin.

Authorization

None

Required connection

None

Command syntax

```
db2adutl db2-object-options access-control-options
```

db2-object-options:

```
QUERY-options COMPRLIB—decompression-library
EXTRACT-options
DELETE-options
VERIFY-options
COMPROPTS—decompression-options VERBOSE
DATABASE—database_name DBPARTITIONNUM—db-partition-number
DB
PASSWORD—password NODENAME—node_name OWNER—owner
WITHOUT PROMPTING
```

QUERY-options:

```
QUERY
TABLESPACE FULL NONINCREMENTAL INCREMENTAL DELTA SHOW INACTIVE
LOADCOPY
LOGS BETWEEN—sn1—AND—sn2 CHAIN—n
```

EXTRACT-options:

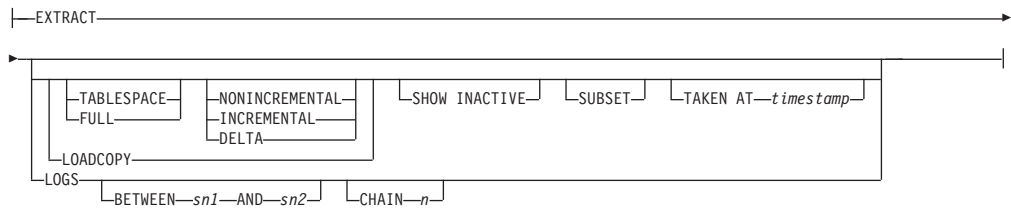

DELETE-options:

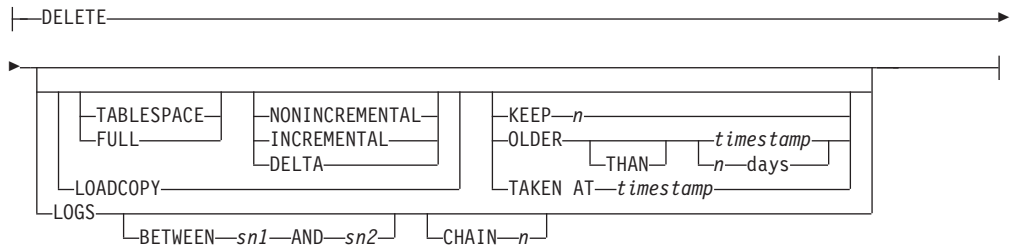

VERIFY-options:

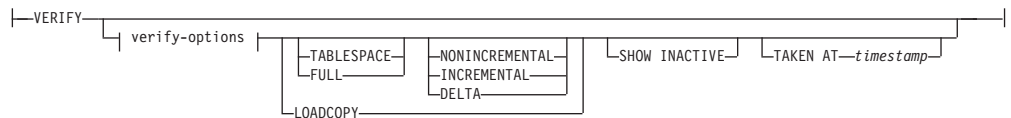

verify-options:



access-control-options:

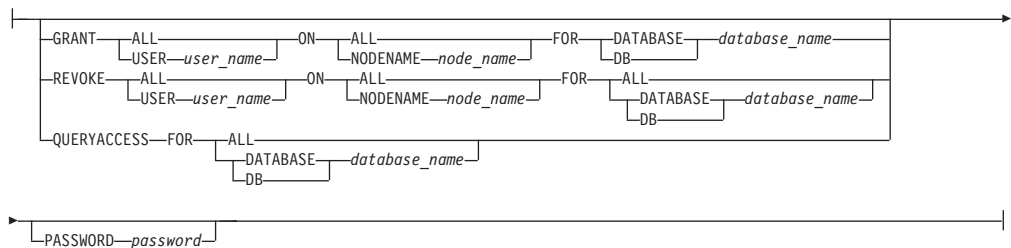

Command parameters

QUERY

Queries the TSM server for DB2 objects.

EXTRACT

Copies DB2 objects from the TSM server to the current directory on the local machine.

DELETE

Either deactivates backup objects or deletes log archives on the TSM server.

VERIFY

Performs consistency checking on the backup copy that is on the server. This parameter causes the entire backup image to be transferred over the network.

ALL Displays all available information.

CHECK

Displays results of checkbits and checksums.

DMS Displays information from headers of DMS table space data pages.

HEADER

Displays the media header information.

HEADERONLY

Displays the same information as HEADER but only reads the 4 K media header information from the beginning of the image. It does not validate the image.

LFH Displays the log file header (LFH) data.

OBJECT

Displays detailed information from the object headers.

PAGECOUNT

Displays the number of pages of each object type found in the image.

SGF Displays the automatic storage paths in the image.

SGFONLY

Displays only the automatic storage paths in the image but does not validate the image.

TABLESPACES

Displays the table space details, including container information, for the table spaces in the image.

TABLESPACESONLY

Displays the same information as TABLESPACES but does not validate the image.

TABLESPACE

Includes only table space backup images.

FULL Includes only full database backup images.

NONINCREMENTAL

Includes only non-incremental backup images.

INCREMENTAL

Includes only incremental backup images.

DELTA

Includes only incremental delta backup images.

LOADCOPY

Includes only load copy images.

LOGS Includes only log archive images

BETWEEN *sn1* AND *sn2*

Specifies that the logs between log sequence number 1 and log sequence number 2 are to be used.

CHAIN *n*

Specifies the chain ID of the logs to be used.

SHOW INACTIVE

Includes backup objects that have been deactivated.

SUBSET

Extracts pages from an image to a file. To extract pages, you will need an input and an output file. The default input file is called `extractPage.in`. You can override the default input file name by setting the `DB2LISTFILE` environment variable to a full path. The format of the input file is as follows:

For SMS table spaces:

```
S <tbspID> <objID> <objType> <startPage> <numPages>
```

Note:

1. `<startPage>` is an object page number that is object-relative.

For DMS table spaces:

```
D <tbspID> <objType> <startPage> <numPages>
```

Note:

1. `<objType>` is only needed if verifying DMS load copy images.
2. `<startPage>` is an object page number that is pool-relative.

For log files:

```
L <log num> <startPos> <numPages>
```

For other data (for example, initial data):

```
O <objType> <startPos> <numBytes>
```

The default output file is `extractPage.out`. You can override the default output file name by setting the `DB2EXTRACTFILE` environment variable to a full path.

TAKEN AT *timestamp*

Specifies a backup image by its time stamp.

KEEP *n*

Deactivates all objects of the specified type except for the most recent *n* by time stamp.

OLDER THAN *timestamp* or *n* days

Specifies that objects with a time stamp earlier than *timestamp* or *n* days will be deactivated.

COMPRLIB *decompression-library*

Indicates the name of the library to be used to perform the decompression. The name must be a fully qualified path referring to a file on the server. If

this parameter is not specified, DB2 will attempt to use the library stored in the image. If the backup was not compressed, the value of this parameter will be ignored. If the specified library cannot be loaded, the operation will fail.

COMPROPTS *decompression-options*

Describes a block of binary data that will be passed to the initialization routine in the decompression library. DB2 will pass this string directly from the client to the server, so any issues of byte reversal or code page conversion will have to be handled by the decompression library. If the first character of the data block is '@', the remainder of the data will be interpreted by DB2 as the name of a file residing on the server. DB2 will then replace the contents of the data block with the contents of this file and will pass this new value to the initialization routine instead. The maximum length for this string is 1024 bytes.

DATABASE *database_name*

Considers only those objects associated with the specified database name.

DBPARTITIONNUM *db-partition-number*

Considers only those objects created by the specified database partition number.

PASSWORD *password*

Specifies the TSM client password for this node, if required. If a database is specified and the password is not provided, the value specified for the *tsm_password* database configuration parameter is passed to TSM; otherwise, no password is used.

NODENAME *node_name*

Considers only those images associated with a specific TSM node name.

OWNER *owner*

Considers only those objects created by the specified owner.

WITHOUT PROMPTING

The user is not prompted for verification before objects are deleted.

VERBOSE

Displays additional file information.

GRANT ALL | USER *user_name*

Adds access rights to the TSM files on the current TSM node to all users or to the users specified. Granting access to users gives them access for all current and future files related to the database specified.

REVOKE ALL | USER *user_name*

Removes access rights to the TSM files on the current TSM node from all users or to the users specified.

QUERYACCESS

Retrieves the current access list. A list of users and TSM nodes is displayed.

ON ALL | NODENAME *node_name*

Specifies the TSM node for which access rights will be changed.

FOR ALL | DATABASE *database_name*

Specifies the database to be considered.

Examples

1. The following is sample output from the command `db2 backup database rawsampl use tsm`

Backup successful. The timestamp for this backup is : 20031209184503

The following is sample output from the command `db2adutl` query issued following the backup operation:

Query for database RAWSAMPL

Retrieving FULL DATABASE BACKUP information.

1 Time: 20031209184403, Oldest log: S0000050.LOG, Sessions: 1

Retrieving INCREMENTAL DATABASE BACKUP information.

No INCREMENTAL DATABASE BACKUP images found for RAWSAMPL

Retrieving DELTA DATABASE BACKUP information.

No DELTA DATABASE BACKUP images found for RAWSAMPL

Retrieving TABLESPACE BACKUP information.

No TABLESPACE BACKUP images found for RAWSAMPL

Retrieving INCREMENTAL TABLESPACE BACKUP information.

No INCREMENTAL TABLESPACE BACKUP images found for RAWSAMPL

Retrieving DELTA TABLESPACE BACKUP information.

No DELTA TABLESPACE BACKUP images found for RAWSAMPL

Retrieving LOCAL COPY information.

No LOCAL COPY images found for RAWSAMPL

Retrieving log archive information.

Log file: S0000050.LOG, Chain Num: 0, DB Partition Number: 0,

Taken at 2003-12-09-18.46.13

Log file: S0000051.LOG, Chain Num: 0, DB Partition Number: 0,

Taken at 2003-12-09-18.46.43

Log file: S0000052.LOG, Chain Num: 0, DB Partition Number: 0,

Taken at 2003-12-09-18.47.12

Log file: S0000053.LOG, Chain Num: 0, DB Partition Number: 0,

Taken at 2003-12-09-18.50.14

Log file: S0000054.LOG, Chain Num: 0, DB Partition Number: 0,

Taken at 2003-12-09-18.50.56

Log file: S0000055.LOG, Chain Num: 0, DB Partition Number: 0,

Taken at 2003-12-09-18.52.39

2. The following is sample output from the command `db2adutl delete full taken at 20031209184503 db rawsampl`

Query for database RAWSAMPL

Retrieving FULL DATABASE BACKUP information.

Taken at: 20031209184503 DB Partition Number: 0 Sessions: 1

Do you want to delete this file (Y/N)? y

Are you sure (Y/N)? y

Retrieving INCREMENTAL DATABASE BACKUP information.

No INCREMENTAL DATABASE BACKUP images found for RAWSAMPL

Retrieving DELTA DATABASE BACKUP information.

No DELTA DATABASE BACKUP images found for RAWSAMPL

The following is sample output from the command `db2adutl` query issued following the operation that deleted the full backup image. Note the timestamp for the backup image.

```

Query for database RAWSAMPL

Retrieving FULL DATABASE BACKUP information.
  1 Time: 20031209184403, Oldest log: S0000050.LOG, Sessions: 1

Retrieving INCREMENTAL DATABASE BACKUP information.
  No INCREMENTAL DATABASE BACKUP images found for RAWSAMPL

Retrieving DELTA DATABASE BACKUP information.
  No DELTA DATABASE BACKUP images found for RAWSAMPL

Retrieving TABLESPACE BACKUP information.
  No TABLESPACE BACKUP images found for RAWSAMPL

Retrieving INCREMENTAL TABLESPACE BACKUP information.
  No INCREMENTAL TABLESPACE BACKUP images found for RAWSAMPL

Retrieving DELTA TABLESPACE BACKUP information.
  No DELTA TABLESPACE BACKUP images found for RAWSAMPL

Retrieving LOCAL COPY information.
  No LOCAL COPY images found for RAWSAMPL

Retrieving log archive information.
  Log file: S0000050.LOG, Chain Num: 0, DB Partition Number: 0,
  Taken at 2003-12-09-18.46.13
  Log file: S0000051.LOG, Chain Num: 0, DB Partition Number: 0,
  Taken at 2003-12-09-18.46.43
  Log file: S0000052.LOG, Chain Num: 0, DB Partition Number: 0,
  Taken at 2003-12-09-18.47.12
  Log file: S0000053.LOG, Chain Num: 0, DB Partition Number: 0,
  Taken at 2003-12-09-18.50.14
  Log file: S0000054.LOG, Chain Num: 0, DB Partition Number: 0,
  Taken at 2003-12-09-18.50.56
  Log file: S0000055.LOG, Chain Num: 0, DB Partition Number: 0,
  Taken at 2003-12-09-18.52.39

```

- The following is sample output from the command `db2adutl queryaccess` for all

Node	User	Database Name	type
bar2	jchisan	sample	B
<all>	<all>	test	B

Access Types: B – Backup images L – Logs A - both

Usage notes

One parameter from each group below can be used to restrict what backup images types are included in the operation:

Granularity:

- FULL - include only database backup images.
- TABLESPACE - include only table space backup images.

Cumulativeness:

- NONINCREMENTAL - include only non-incremental backup images.
- INCREMENTAL - include only incremental backup images.

- DELTA - include only incremental delta backup images.

Compatibilities

For compatibility with versions earlier than Version 8:

- The keyword NODE can be substituted for DBPARTITIONNUM.

Chapter 163. db2advis - DB2 design advisor

The DB2 Design Advisor advises users on the creation of materialized query tables (MQTs) and indexes, the repartitioning of tables, the conversion to multidimensional clustering (MDC) tables, and the deletion of unused objects.

The recommendations are based on one or more SQL statements provided by the user. A group of related SQL statements is known as a *workload*. Users can rank the importance of each statement in a workload and specify the frequency at which each statement in the workload is to be executed. The Design Advisor outputs a DDL CLP script that includes CREATE INDEX, CREATE SUMMARY TABLE (MQT), and CREATE TABLE statements to create the recommended objects.

Structured type columns are not considered when this command is executed.

Authorization

Read access to the database. Read and write access to the explain tables. If materialized query tables (MQTs) are used, you must have CREATE TABLE authorization, and read and write access to the MQTs.

Required connection

None. This command establishes a database connection.

Command syntax

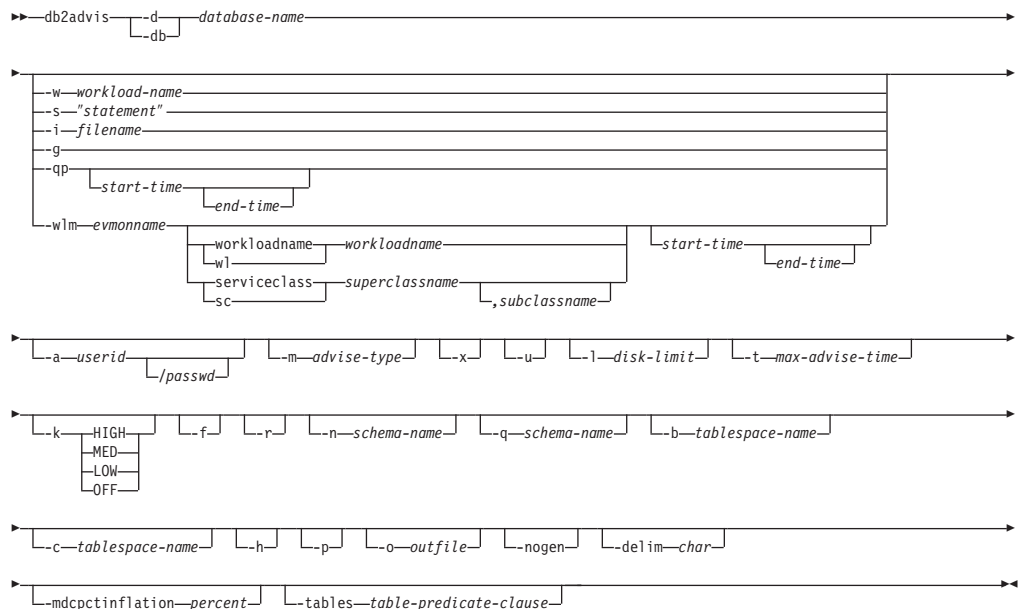

Command parameters

-a *userid/passwd*

Name and password used to connect to the database. The slash (/) must be included if a password is specified. A password should not be specified if the **-x** option is specified.

- b** *tablespace-name*
Specifies the name of a table space in which new MQTs will be created. If not specified, the advisor will select the table spaces from the set of table spaces that exist.
- c** *tablespace-name*
Specifies the name of a table space (where the table space can be of any type, for example, use a file name or directory) in which to create the simulation catalog tables. This table space must only be created on the catalog database partition group. The default is USERSPACE1.

It is recommended that the user create the table space employed for the simulation instead of using the default USERSPACE1. In addition, the ALTER TABLESPACE DROPPED TABLE RECOVERY OFF statement should be run on this table space to improve the performance of the db2advis utility. When the utility completes, turn the history back on for the table space. In a partitioned database environment, this option is required as USERSPACE1 is usually created across all partition groups.
- d** *database-name*
Specifies the name of the database to which a connection is to be established.
- delim** *char*
Indicates the statement delimiter character *char* in a workload file input. Default is '*'*'.
- f** Drops previously existing simulated catalog tables.
- g** Specifies the retrieval of the SQL statements from a dynamic SQL snapshot. If combined with the **-p** command parameter, the SQL statements are kept in the ADVISE_WORKLOAD table. This option cannot be specified with the **-i**, **-s**, **-qp**, or **-w** options.
- h** Display help information. When this option is specified, all other options are ignored, and only the help information is displayed.
- i** *filename*
Specifies the name of an input file containing one or more SQL statements. The default is standard input. Identify comment text with two hyphens at the start of each line; that is, *-- comment*. Statements must be delimited by semicolons.

The frequency at which each statement in the workload is to be executed can be changed by inserting the following line into the input file:

```
--#SET FREQUENCY x
```

The frequency can be updated any number of times in the file. This option cannot be specified with the **-g**, **-s**, **-qp**, or **-w** options.
- k** Specifies to what degree the workload will be compressed. Compression is done to allow the advisor to reduce the complexity of the advisor's execution while achieving similar results to those the advisor could provide when the full workload is considered. HIGH indicates the advisor will concentrate on a small subset of the workload. MED indicates the advisor will concentrate on a medium-sized subset of the workload. LOW indicates the advisor will concentrate on a larger subset of the workload. OFF indicates that no compression will occur and every query is considered. The default is MED.

-l *disk-limit*

Specifies the number of megabytes available for all recommended indexes and materialized views in the existing schema. Specify **-1** to use the maximum possible size. The default value is 20% of the total database size.

-m *advise-type*

Specifies the type of recommendation the advisor will return. Any combination of I, M, C, and P (in upper- or lowercase) can be specified. For example, `db2advise -m PC` will recommend partitioning and MDC tables. If **-m P** or **-m M** are used in a partitioned database environment, the `advise_partition` table is populated with the final partition recommendation. The choice of possible values are:

I Recommends new indexes. This is the default.

M Recommends new materialized query tables (MQTs) and indexes on the MQTs. In partitioned database environments, partitioning on MQTs is also recommended.

C Recommendation to convert standard tables to multidimensional clustering (MDC) tables; or, to create a clustering index on the tables.

P Recommends the repartitioning of existing tables.

-mdcpctinflation *percent*

Specifies the maximum percentage that the table disk size can increase in an MDC recommendation. For example, it indicates that a table is allowed to increase to $1 + \text{percent}/100$ times its original size when it is converted to a MDC table. *percent* is a floating point number with a default value of 10.

-n *schema-name*

Specifies the qualifying name of simulation catalog tables, and the qualifier for the new indexes and MQTs. The default schema name is the caller's user ID, except for catalog simulation tables where the default schema name is SYSTOOLS. The default is for new indexes to inherit the schema name of the index's base.

-nogen

Indicates that generated columns are not to be included in multidimensional clustering recommendations.

-o *outfile*

Saves the script to create the recommended objects in *outfile*.

-p

Keeps the plans that were generated while running the tool in the explain tables. The **-p** command parameter causes the workload for **-qp** and **-g** to be saved in the `ADVISE_WORKLOAD` table and saves the workload query plans that use the final recommendation in the explain tables.

-q *schema-name*

Specifies the qualifying name of unqualified names in the workload. It serves as the schema name to use for `CURRENT SCHEMA` when `db2advise` executes. The default schema name is the user ID of the person executing the command.

-qp

Specifies that the workload is coming from DB2 Query Patroller. The *start-time* and *end-time* options are timestamps used to check against the `time_completed` field of the `DB2QP.TRACK_QUERY_INFO` table. If no *start-time* and *end-time* timestamps are given, all rows are given "D" (for done) in the `completion_status` column of the table. If only *start-time* is given, the rows returned are those with `TIME_COMPLETED` greater than

or equal to the *start-time* value. In addition, if the *end-time* value is given, the rows returned are also restricted by `TIME_COMPLETED` less than or equal to the *end-time* value. This option cannot be used with the **-w**, **-wlm**, **-s**, **-i**, or **-g** options.

start-time

Specifies the start timestamp.

end-time

Specifies the end timestamp. This parameter is optional.

-r Specifies that detailed statistics should be used for the virtual MQTs and for the partitioning selection. If this option is not specified, the default is to use optimizer statistics for MQTs. Although the detailed statistics might be more accurate, the time to derive them will be significant and will cause the `db2adv` execution time to be greater. The **-r** command parameter uses sampling to obtain relevant statistics for MQTs and partitioning. For MQTs, when the sample query either fails or returns no rows, the optimizer estimates are used.

-s *"statement"*

Specifies the text of a single SQL statement to be assessed and have indexes suggested by the Design Advisor. The statement must be enclosed by double quotation marks. This option cannot be specified with the **-g**, **-i**, **-qp**, or **-w** options.

-t *max-advise-time*

Specifies the maximum allowable time, in minutes, to complete the operation. If no value is specified for this option, the operation will continue until it is completed. To specify an unlimited time enter a value of zero. The default is zero.

-tables *table-predicate-clause*

Indicates that only a subset of all existing tables should be considered. The *table-predicate-clause* must be a predicate that can be used in the `WHERE` clause of a query on `SYSCAT.TABLES`. The tables considered by `db2adv` will be the intersection of the tables from this query and the tables in the workload.

This command parameter does not apply to recommendations about new MQTs.

-u Specifies that the advisor will consider the recommendation of deferred MQTs. Incremental MQTs will not be recommended. When this option is specified, comments in the DDL CLP script indicate which of the MQTs could be converted to immediate MQTs. If immediate MQTs are recommended in a partitioned database environment, the default distribution key is the implied unique key for the MQT.

-w *workload-name*

Specifies the name of the workload to be assessed and have indexes suggested by the Design Advisor. This name is used in the `ADVISE_WORKLOAD` table. This option cannot be specified with the **-g**, **-i**, **-qp**, or **-s** options.

-wlm *evmonname*

Specifies to get the table names corresponding to the `ACTIVITY` and `ACTIVITYSTMT` logical data groups from `SYSCAT.EVENTTABLES` for event name *evmonname*, and joins them together on `ACTIVATE_TIMESTAMP`, `ACTIVITY_ID` and `ACTIVITY_SECONDARY_ID` for records that have `PARTIAL_RECORD = 0` (completed transactions). An

optional *start-time* and *end-time* timestamp can be added to get statements on or after the *start-time* and, optionally, on or before the *end-time*. *start-time* and *end-time* are with respect to the TIME_COMPLETED column from the ACTIVITY tables.

workloadname | **wl** *workloadname*

Specifies the *workloadname* that is searched for in SYSCAT.WORKLOADS. The ACTIVITY event monitor table is joined with SYSCAT.WORKLOADS on the workload id to obtain these statements.

serviceclass | **sc** *superclassname*

Specifies the service class information which comes from SYSCAT.SERVICECLASSES. When no subclass is given, all statements for a service superclass is retrieved, which is basically the PARENTSERVICECLASS in SYSCAT.SERVICECLASSES. The ACTIVITY event monitor table is joined with SYSCAT.SERVICECLASSES on the service class id to obtain these statements.

,subclassname

Specifies the *subclassname* if a *superclassname* is specified; separated by a comma. This parameter is optional.

start-time

Specifies the start timestamp.

end-time

Specifies the end timestamp. This parameter is optional.

-x Specifies that the password will be read from the terminal or through user input.

Examples

1. In the following example, the utility connects to database PROTOTYPE, and recommends indexes for table ADDRESSES without any constraints on the solution:

```
db2advis -d prototype -s "select * from addresses a
  where a.zip in ('93213', '98567', '93412')
  and (company like 'IBM%' or company like '%otus')"
```

2. In the following example, the utility connects to database PROTOTYPE, and recommends indexes that will not exceed 53 MB for queries in table ADVISE_WORKLOAD. The workload name is equal to "production". The maximum allowable time for finding a solution is 20 minutes.

```
db2advis -d prototype -w production -l 53 -t 20
```

3. In the following example, the input file db2advis.in contains SQL statements and a specification of the frequency at which each statement is to be executed:

```
--#SET FREQUENCY 100
SELECT COUNT(*) FROM EMPLOYEE;
SELECT * FROM EMPLOYEE WHERE LASTNAME='HAAS';
--#SET FREQUENCY 1
SELECT AVG(BONUS), AVG(SALARY) FROM EMPLOYEE
  GROUP BY WORKDEPT ORDER BY WORKDEPT;
```

The utility connects to database SAMPLE, and recommends indexes for each table referenced by the queries in the input file. The maximum allowable time for finding a solution is 5 minutes:

```
db2advis -d sample -f db2advis.in -t 5
```

4. In the following example, MQTs are created in table space SPACE1 and the simulation table space is SPACE2. The qualifying name for unqualified names in the workload is SCHEMA1, and the schema name in which the new MQTs will be recommended is SCHEMA2. The workload compression being used is HIGH and the disk space is unlimited. Sample statistics are used for the MQTs. Issuing the following command will recommend MQTs and, in a partitioned database environment, indexes and partitioning will also be recommended.

```
db2adviz -d prototype -w production -l -l -m M -b space1 -c space2 -k  
HIGH -q schema1 -n schema2 -r
```

To get the recommended MQTs, as well as indexes, partitioning and MDCs on both MQT and base tables, issue the command specifying a value of IMCP for the **-m** option as follows:

```
db2adviz -d prototype -w production -l -l -m IMCP -b space1 -c space2 -k  
HIGH -q schema1 -n schema2 -r
```

5. In the following example, the utility connects to database SAMPLE, and recommends MDC for tables for EMPLOYEE and DEPT where MDC candidates are allowed to grow by 30.5% of their original size.

```
db2adviz -d sample -type C -disklimit 100  
-tables "TABNAME IN ('EMPLOYEE','DEPT')" -mdcpcinflation 30.5
```

Usage notes

Because these features must be set up before you can run the DDL CLP script, database partitioning, multidimensional clustering, and clustered index recommendations are commented out of the DDL CLP script that is returned. It is up to you to transform your tables into the recommended DDL. One example of doing this is to use the ALTER TABLE stored procedure but there are restrictions associated with it in the same way the RENAME statement is restricted.

Starting with Version 9.7, the Design Advisor will not recommend partitioned indexes. All indexes will be recommended with the NOT PARTITIONED clause. With this recommendation, it is your choice whether to use PARTITIONED (the default) or NOT PARTITIONED to create indexes based on their application scenarios and on the benefit that partitioned index can provide.

For dynamic SQL statements, the frequency with which statements are executed can be obtained from the monitor as follows:

1. Issue the command:

```
db2 reset monitor for database database-alias
```

Wait for an appropriate interval of time.

2. Issue the command:

```
db2adviz -g other-options
```

If the **-p** parameter is used with the **-g** parameter, the dynamic SQL statements obtained will be placed in the ADVISE_WORKLOAD table with a generated workload name that contains a timestamp.

The default frequency for each SQL statement in a workload is 1, and the default importance is also 1. The generate_unique() function assigns a unique identifier to the statement, which can be updated by the user to be a more meaningful description of that SQL statement.

Any db2adviz error information can also be found in the db2diag log file.

When the advisor begins running, the ADVISE_INSTANCE table will contain a row that identifies the advisor. The main advisor row is identified by the START_TIME showing when the advisor began its run. This row's STATUS is "STARTED".

If issuing the db2advvis command results in an error saying "Cannot insert into DB2ADVVIS_INSTANCE", you will need to bind db2advvis.bnd and run the db2advvis command with the -I option. The bind operation can be performed by issuing the command:

```
db2 bind db2advvis.bnd blocking all grant public
```

When the advisor is completed, you can check the associated row with the appropriate START_TIME in the ADVISE_INSTANCE table. If STATUS is "COMPLETED", the advisor executed successfully. If STATUS is still "STARTED" and there is no db2advvis process running, the advisor has terminated prematurely. If STATUS has an "EX", you are also shown an "SQLCODE" to determine how the advisor failed.

If the -I *disk-limit* option is not specified, you must have at least one of SYSADM, SYSCTRL, SYSMAINT, or SYSMON authority to determine the maximum database size using the GET_DBSIZE_INFO stored procedure.

The *table-predicate-clause* in the -**tables** parameter is used to query SYSCAT.TABLES and determine the tables that the advisor will consider. Only base tables or existing MQTs can be considered, but aliases and logical views can be used in the *table-predicate-clause* to return the list of base table names or MQTs. For example, to specify the subset of tables that have views that start with 'TV', specify -tables "(tablename, tabschema) in (SELECT bname, bschema FROM SYSCAT.TABDEP WHERE TABNAME LIKE 'TV%')".

As of Version 9.7, the query optimizer measures the cost of the I/O savings and the cost of decompressing key values and RIDs in the cost model. As such, the Index advisor is capable of estimating the compressed index size.

Chapter 164. db2audit - Audit facility administrator tool

DB2 provides an audit facility to assist in the detection of unknown or unanticipated access to data. The DB2 audit facility generates and permits the maintenance of an audit trail for a series of predefined database events. The records generated from this facility are kept in audit log files. The analysis of these records can reveal usage patterns which would identify system misuse. Once identified, actions can be taken to reduce or eliminate such system misuse. The audit facility acts at both the instance and database levels, independently recording all activities in separate logs based on either the instance or the database.

DB2 provides the ability to independently audit at both the instance and at the individual database level. The db2audit tool is used to configure audit at the instance level as well as control when such audit information is collected. The AUDIT SQL statement is used to configure and control the audit requirements for an individual database. The db2audit tool can be used to archive both instance and database audit logs as well as to extract from archived logs of either type. For additional information, see the *Related links* section below.

When working in a partitioned database environment, many of the auditable events occur at the database partition at which the user is connected (the coordinator partition) or at the catalog partition (if they are not the same database partition). The implication of this is that audit records can be generated by more than one database partition. Part of each audit record contains information on the coordinator partition and originating database partition identifiers.

The instance audit log (`db2audit.instance.log.node_number[.timestamp]`) is located in the instance's `security/auditdata` subdirectory, and the audit configuration file (`db2audit.cfg`) is located in the instance's `security` subdirectory. The database audit log is named `db2audit.db.dbname.log.node_number[.timestamp]`. At the time you create an instance, read/write permissions are set on these files, where possible, by the operating system. By default, the permissions are read/write for the instance owner only. It is recommended that you do not change these permissions.

Authorized users of the audit facility can control the following actions within the audit facility, using `db2audit`:

- Start recording auditable events within the DB2 instance. This does not include database level activities.
- Stop recording auditable events within the DB2 instance.
- Configure the behavior of the audit facility at the instance level only.
- Select the categories of the auditable events to be recorded at the instance level only.
- Request a description of the current audit configuration for the instance.
- Flush any pending audit records from the instance and write them to the audit log.
- Archive audit records from the current audit log for either the instance or a database under the instance.
- Extract audit records from an archived audit log by formatting and copying them to a flat file or ASCII delimited file. Extraction is done in preparation for analysis of log records.

Authorization

sysadm

Required Connection

None

Command syntax

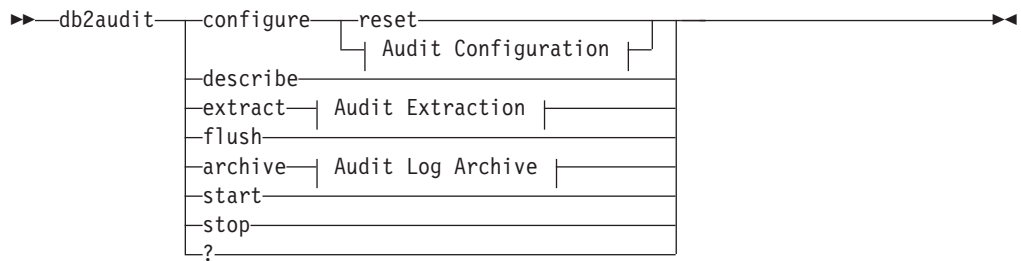

Audit Configuration:

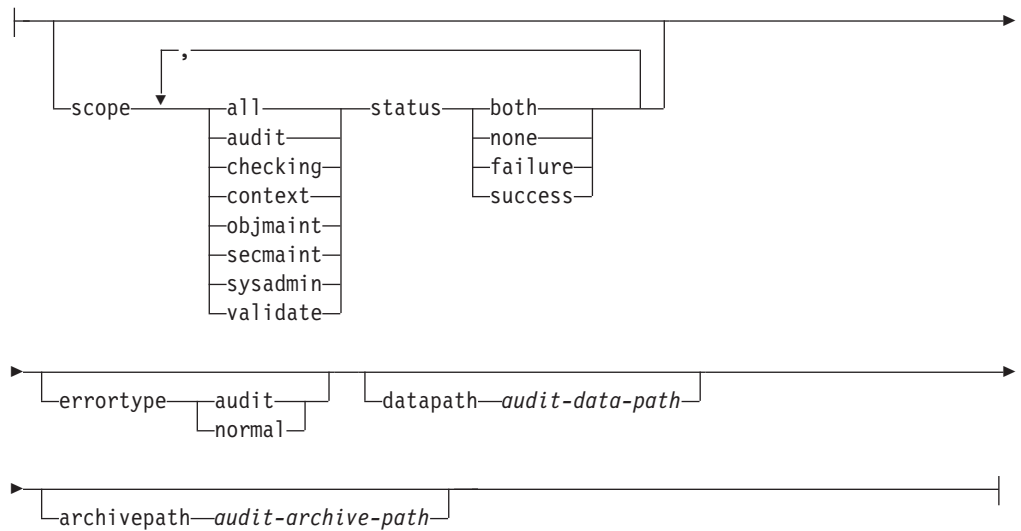

Audit Extraction:

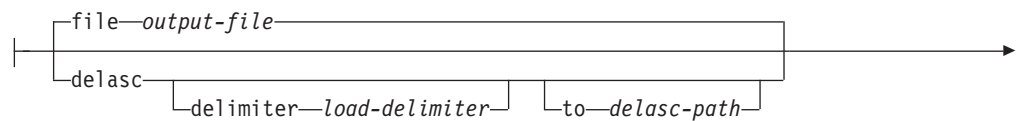

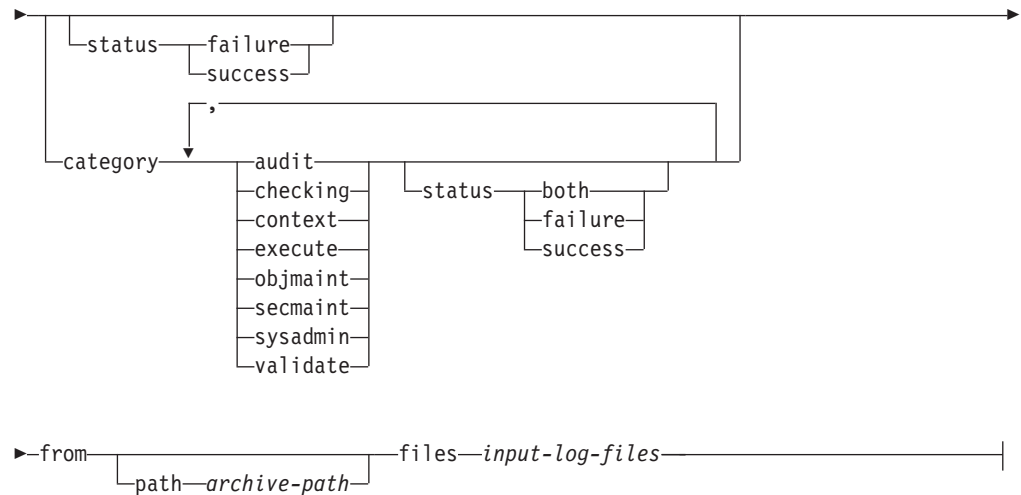

Audit Log Archive:

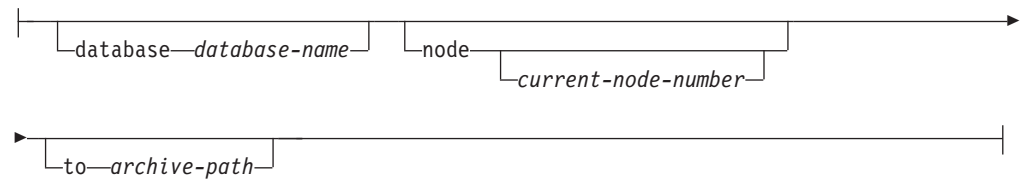

Command parameters

configure

This parameter allows the modification of the `db2audit.cfg` configuration file in the instance's security subdirectory. Updates to this file can occur even when the instance is stopped. Updates, occurring when the instance is active, dynamically affect the auditing being done by the DB2 instance. The configure action on the configuration file causes the creation of an audit record if the audit facility has been started and the **audit** category of auditable events is being audited. All configure options, except the data path and archive path, only apply to instance level audit events, and not to database level audit events. The path options apply to the instance and all databases within the instance.

The following are the possible actions on the configuration file:

- reset** This action causes the configuration file to revert to the initial configuration (where scope is all of the categories except **context**, status for each category is failure, errortype is normal, and the auditing of instance level events is off). This action will create a new audit configuration file if the original has been lost or damaged. The audit data path and archive path will be blank. This option does not reset any of the audit policies or use of those policies at the database level.
- scope** This action specifies which categories will be audited, and the status of each of those categories.
- status** This action specifies whether only successful or failing

events, or both successful and failing events, should be logged. status has the following options:

both Successful and failing events will be audited.

none No events for this category will be audited.

failure
Only failing events will be audited.

success
Only successful events will be audited.

Only the categories specified on the configure statement will be modified. All other categories will have their status preserved.

Note:

- The default scope is all categories except **context** and may result in records being generated rapidly. In conjunction with the mode (synchronous or asynchronous), the selection of the categories may result in a significant performance reduction and significantly increased disk requirements. It is recommended that the number and type of events being logged be limited as much as possible, otherwise the size of the audit log will grow rapidly. This action also allows a particular focus for auditing and reduces the growth of the log.
- **context** events occur before the status of an operation is known. Therefore, such events are logged regardless of the value associated with this parameter, unless the status is none.
- If the same category is repeated, or categories are also specified with the all keyword, a syntax error will be returned.

errortype

This action specifies whether audit errors are returned to the user or are ignored. The value for this parameter can be:

audit All errors including errors occurring within the audit facility are managed by DB2 database and all negative SQLCODEs are reported back to the caller.

normal
Any errors generated by db2audit are ignored and only the SQLCODEs for the errors associated with the operation being performed are returned to the application.

datapath *audit-data-path*

This is the directory to which the audit logs produced by DB2 will be written. The default is `sqllib/security/auditdata` (<*instance path*>\instance\security\auditdata on Windows). This parameter affects all auditing within an instance, including database level auditing. This must be a fully qualified path and not a relative path. The instance owner must have write permission on this directory. On Windows, the user issuing a local instance command, for example, db2start, db2audit, and db2 update dbm cfg, must also have write permission on this directory if the command is required to be audited. On a DPF system, this directory does not need to be an NFS shared directory, although that is possible. A non-shared directory will result in increased performance as each node is writing to a unique disk. The maximum length of the path is 971 bytes for UNIX/Linux and 208 bytes for Windows systems.

If the path is provided as "", then the path will be updated to be the default. db2audit describe will show no path as being set and the default path will be used. Note, to prevent the shell from interpreting the quotes, they will generally need to be escaped, for example

```
db2audit configure datapath "\\\""
```

The data path must exist. In a DPF environment, the same data path will be used on each node. There is no way to specify a unique set of data paths for a particular node unless database partition expressions are used as part of the data path name. Doing this allows the node number to be reflected in the storage path such that the resulting path name is different on each database partition. See *Automatic storage databases* for information about database partition expressions.

archivepath *audit-archive-path*

This is the default directory for the archive and extract options. In a DPF environment, it is recommended that this directory be an NFS shared directory accessible by all nodes. The default is sqllib/security/auditdata (sqllib\instance\security\auditdata on Windows). This must be a fully qualified path and not a relative path. The instance owner must have write permission on this directory. The maximum length of the path is 971 bytes for UNIX/Linux and 208 bytes for Windows systems.

The archive path must exist, and database partition expressions are NOT allowed for the archive path.

describe

This parameter displays to standard output the current instance level audit configuration information and status.

The following items are displayed:

- If audit is active.
- The status for each category.
- The error type in the form of whether or not an SQLCA is returned on errors.
- The data and archive paths.

This is an example of what the describe output looks like:

```
DB2 AUDIT SETTINGS:
```

```
Audit active: "FALSE "  
Log audit events: "SUCCESS"  
Log checking events: "FAILURE"  
Log object maintenance events: "BOTH"  
Log security maintenance events: "BOTH "  
Log system administrator events: "NONE"  
Log validate events: "FAILURE"  
Log context events: "NONE"  
Return SQLCA on audit error: "TRUE "  
Audit Data Path: "/auditdata"  
Audit Archive Path: "/auditarchive"
```

```
AUD0000I  Operation succeeded.
```

extract This parameter allows the movement of audit records from the audit log to

an indicated destination. The audit log will be created in the database code page. All of the fields will be converted to the current application code page when extract is run.

The following are the options that can be used when extracting:

file *output-file*

The extracted audit records are placed in *output-file*. If the directory is not specified, *output-file* is written to the current working directory. If the file already exists the output will be appended to it. If a file name is not specified, records are written to the db2audit.out file in the archive path specified in the audit configuration file.

delasc

The extracted audit records are placed in a delimited ASCII format suitable for loading into DB2 database relational tables. The output is placed in separate files, one for each category. In addition, the file auditlobs will also be created to hold any lobes that are included in the audit data. The filenames are:

- audit.del
- checking.del
- objmaint.del
- secmaint.del
- sysadmin.del
- validate.del
- context.del
- execute.del
- auditlobs

If the files already exist the output will be appended to them. The auditlobs file will be created if the **context** or **execute** categories are extracted. LOB Location Specifiers are included in the .del files to reference the LOBS in the auditlobs file.

delimiter *load-delimiter*

Allows you to override the default audit character string delimiter, which is the double quote ("), when extracting from the audit log. You would use delimiter followed by the new delimiter that you want to use in preparation for loading into a table that will hold the audit records. The new load delimiter can be either a single character (such as !) or a four-character string representing a hexadecimal number (such as 0xff).

to *delasc-path*

Allows you to specify the path to which the delimited files are written. If it is not specified, then the files are written to the directory indicated by the audit archive path option specified in the audit configuration file.

category

The audit records for the specified categories of audit events are to be extracted. If not specified, all categories are eligible for extraction.

status

The audit records for the specified status are to be extracted. If not specified, all records are eligible for extraction.

path

The path to the location of the archived audit logs. If this is not specified, the archive path in the audit configuration will be used. The path is not used if the filename contains a fully qualified path.

files

The list of audit log files that will be extracted. This may be a single file or a list of files. These files are not altered during an extract. The filenames will be combined with path to get the fully qualified filenames if they are not already fully qualified. The list may include standard shell wild cards to specify multiple files.

flush This parameter forces any pending audit records to be written to the audit log. Also, the audit state is reset from "unable to log" to a state of "ready to log" if the audit facility is in an error state.

archive

This parameter moves the current audit log for either an individual database or the instance to a new location for archiving and later extraction. The current timestamp will be appended to the filename. All records that are currently being written to the audit log will complete before the log is archived to ensure full records are not split apart. All records that are created while the archive is in progress will be written to the current audit log, and not the archived log, once the archive has finished.

The following are the options that can be used when archiving:

database *database-name*

The name of the database for which you would like to archive the audit log. If the database name is not supplied, then the instance level audit log is archived.

node

Indicates that the archive command is to only be run on the current node, and that the `node_number` monitor element will indicate what the current node is. This is only required on a DPF system.

current-node-number

Informs the `db2audit` executable about which node it is currently running on. This parameter is required if the `DB2NODE` environment variable does not contain the current node.

to *archive-path*

The directory where the archived audit log should be created. The directory must exist and the instance owner must have create permission on this directory. If this is not provided, the archive path in the audit configuration will be used.

The format of the filename that is created is:

- `db2audit.instance.log.node_number[.YYYYMMDDHHMMSS]` for the instance log
- `db2audit.db.dbname.log.node_number[.YYYYMMDDHHMMSS]` for the database log

where `YYYY` is the year, `MM` is the month, `DD` is the day, `HH` is the hour, `MM` is the minute, and `SS` is the seconds. The time will be the local time. The database name portion will not be present for instance audit logs. The node number in a non-DPF environment will be 0. If the file already exists, an append will be performed.

The timestamp will not reflect the last record in the log with 100% accuracy. The timestamp represents when the archive command was run. Entries that are currently being written to the log file must finish before it can be moved, and these entries may have timestamps that are later than the timestamp given to the filename.

If the node option is not specified, then the audit log on all nodes will be archived. The database server must be started in this case. If the database server has not been started, then archive must be run on each node, and the node option must be specified to indicate on which node archive is to be run (AUD0029).

The archive option will output the result and names of the files from each node that archive was run on.

- start** This parameter causes the audit facility to begin auditing events based on the contents of the `db2audit.cfg` file for the instance only. In a partitioned DB2 database instance, auditing will begin for instance and client level activities on all database partitions when this clause is specified. If the **audit** category of events has been specified for auditing, then an audit record will be logged when the audit facility is started. This has no effect on database level auditing, which is controlled through the AUDIT DDL statement.
- stop** This parameter causes the audit facility to stop auditing events for the instance only. In a partitioned DB2 database instance, auditing will be stopped for instance and client level activities on all database partitions when this clause is specified. If the **audit** category of events has been specified for auditing, then an audit record will be logged when the audit facility is stopped. This has no effect on database level auditing, which is controlled through the AUDIT DDL statement.
- ?** This parameter displays the help information for the `db2audit` command.

Examples

This is a typical example of how to archive and extract a delimited ASCII file in a DPF environment. The Windows `remove (rm)` command deletes the old delimited ASCII files.

```
rm /auditdelasc/*.del
db2audit flush
db2audit archive database mydb to /auditarchive
```

(files will be indicated for use in next step)

```
db2audit extract delasc to /auditdelasc from files /auditarchive
/db2audit.db.mydb.log.*.20070514102856
```

load the .del files into a DB2 table...

Usage notes

- Database level auditing is controlled with the AUDIT statement. For additional information, see the *Related links* section below.
- The instance level audit facility must be stopped and started explicitly. When starting, the audit facility uses existing audit configuration information. Since the audit facility is independent of the DB2 database server, it will remain active even if the instance is stopped. In fact, when the instance is stopped, an audit record may be generated in the audit log.

- Ensure that the audit facility has been turned on by issuing the db2audit start command before using the audit utilities.
- There are different categories of audit records that may be generated. In the description of the categories of events available for auditing (below), you should notice that following the name of each category is a one-word keyword used to identify the category type. The categories of events available for auditing are:
 - Audit (**audit**). Generates records when audit settings are changed or when the audit log is accessed.
 - Authorization Checking (**checking**). Generates records during authorization checking of attempts to access or manipulate DB2 database objects or functions.
 - Object Maintenance (**objmaint**). Generates records when creating or dropping data objects.
 - Security Maintenance (**secmaint**). Generates records when granting or revoking: object or database privileges, or DBADM authority. Records are also generated when the database manager security configuration parameters SYSADM_GROUP, SYSCTRL_GROUP, or SYSMAINT_GROUP are modified.
 - System Administration (**sysadmin**). Generates records when operations requiring SYSADM, SYSMAINT, or SYSCTRL authority are performed.
 - User Validation (**validate**). Generates records when authenticating users or retrieving system security information.
 - Operation Context (**context**). Generates records to show the operation context when an instance operation is performed. This category allows for better interpretation of the audit log file. When used with the log's event correlator field, a group of events can be associated back to a single database operation.
 - You can audit failures, successes, both or none.

For additional information, see the *Related links* section below.

- Any operation on the instance may generate several records. The actual number of records generated and moved to the audit log depends on the number of categories of events to be recorded as specified by the audit facility configuration. It also depends on whether successes, failures, or both, are audited. For this reason, it is important to be selective of the events to audit.
- To clean up and/or view audit logs, run archive on a regular basis, then run extract on the archived file to save what is useful. The audit logs can then be deleted with standard file system delete commands.

Chapter 165. db2batch - Benchmark tool

Reads SQL statements and XQuery statements from either a flat file or standard input, dynamically prepares and describes the statements, and returns an answer set.

This tool can work in both a single partition database and in a multiple partition database.

Through the tool's optional parameters you are able to control the number of rows to be fetched from the answer set, the number of fetched rows to be sent to the output file or standard output, and the level of performance information to be returned.

The output default is to use standard output. You can name the output file for the results summary.

Authorization

The same authority level as that required by the SQL statements or the XQuery statements to be read.

Required connection

None. This command establishes a database connection.

Command syntax

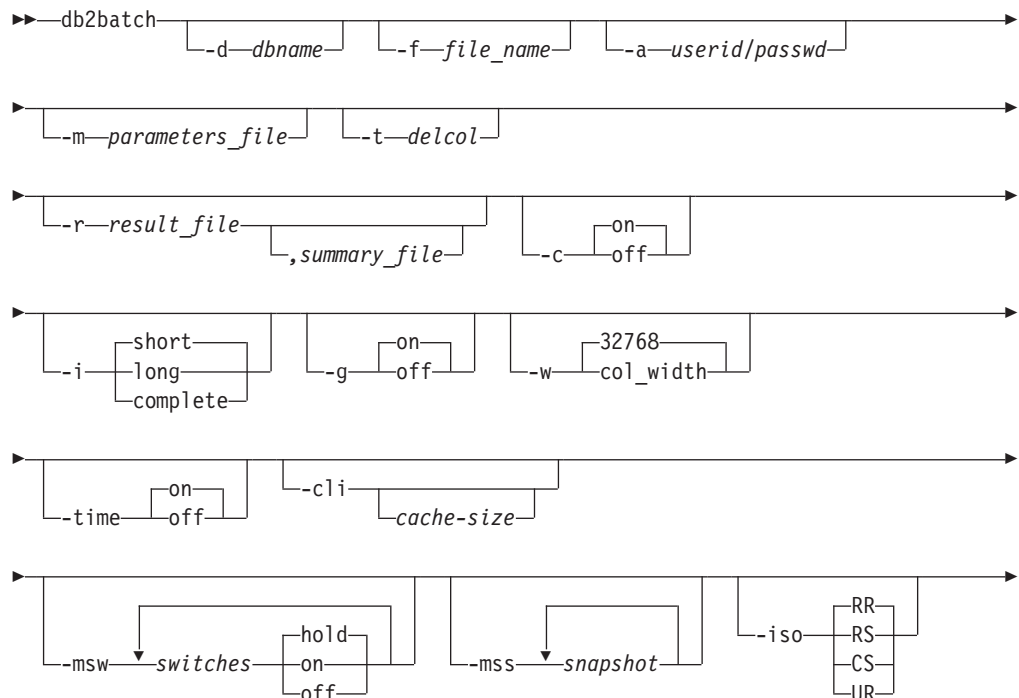

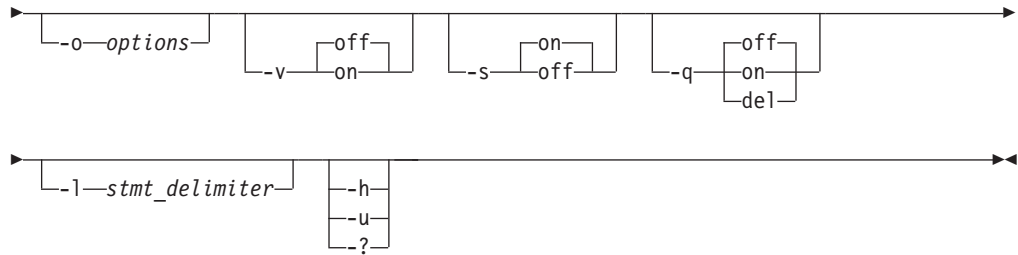

Command parameters

-d *dbname*

An alias name for the database against which SQL statements and XQuery statements are to be applied. If this option is not specified, the value of the DB2DBDFT environment variable is used.

-f *file_name*

Name of an input file containing SQL statements and XQuery statements. The default is standard input.

Identify comment text by adding two hyphens in front of the comment text, that is, *--comment*. All text following the two hyphens until the end of the line is treated as a comment. Strings delimited with single or double quotation marks may contain two adjacent hyphens, and are treated as string constants rather than comments. To include a comment in the output, mark it as follows: *--#COMMENT comment*.

A *block* is a group of SQL statements and XQuery statements that are treated as one. By default, information is collected for all of the statements in the block at once, rather than one at a time. Identify the beginning of a block of queries as follows: *--#BGBLK*. Identify the end of a block of queries as follows: *--#EOBLK*. Blocks of queries can be included in a repeating loop by specifying a repeat count when defining the block, as follows: *--#BGBLK repeat_count*. Statements in the block will be prepared only on the first iteration of the loop.

You can use #PARAM directives or a parameter file to specify the parameter values for a given statement and a given iteration of a block. See the -m option below for details.

Specify one or more control options as follows: *--#SET control option value*. Valid control options are:

ROWS_FETCH

Number of rows to be fetched from the answer set. Valid values are -1 to *n*. The default value is -1 (all rows are to be fetched).

ROWS_OUT

Number of fetched rows to be sent to output. Valid values are -1 to *n*. The default value is -1 (all fetched rows are to be sent to output).

PERF_DETAIL *perf_detail*

Specifies the level of performance information to be returned. Valid values are:

- 0** Do not return any timing information or monitoring snapshots.
- 1** Return elapsed time only.

- 2 Return elapsed time and a snapshot for the application.
- 3 Return elapsed time, and a snapshot for the database manager, the database, and the application.
- 4 Return a snapshot for the database manager, the database, the application, and the statement (the latter is returned only if autocommit is OFF, and single statements, not blocks of statements, are being processed). The snapshot will not include hash join information.
- 5 Return a snapshot for the database manager, the database, the application, and the statement (the latter is returned only if autocommit is OFF, and single statements, not blocks of statements, are being processed). Also return a snapshot for the buffer pools, table spaces and FCM (an FCM snapshot is only available in a multi-database-partition environment). The snapshot will not include hash join information.

The default value is 1. A value >1 is only valid on DB2 Version 2 and DB2 database servers, and is not currently supported on host machines.

ERROR_STOP

Specifies whether or not db2batch should stop running when a non-critical error occurs. Valid values are:

- no** Continue running when a non-critical error occurs. This is the default option.
- yes** Stop running when a non-critical error occurs.

DELIMITER

A one- or two-character end-of-statement delimiter. The default value is a semicolon (;).

SLEEP

Number of seconds to sleep. Valid values are 1 to *n*.

PAUSE

Prompts the user to continue.

SNAPSHOT *snapshot*

Specifies the monitoring snapshots to take. See the -mss option for the snapshots that can be taken.

TIMESTAMP

Generates a time stamp.

TIMING

Print timing information. Valid values are:

- ON** Timing information is printed. This is the default.
- OFF** Timing information is not printed.

-a *userid/passwd*

Specifies the user ID and password used to connect to the database. The slash (/) must be included.

-m *parameters_file*

Specifies an input file with parameter values to bind to the SQL statement parameter markers before executing a statement. The default is to not bind parameters.

If a parameters file is used, then each line specifies the parameter values for a given statement and a given iteration of a block. If instead #PARAM directives are used, multiple values and even parameter ranges are specified in advance for each parameter of each statement, and on each iteration of the block a random value is chosen from the specified sets for each parameter. #PARAM directives and a parameters file cannot be mixed.

Parameter Value Format:

-36.6	'DB2'	X'0AB2'	G'...'	NULL
12	'batch'	x'32ef'	N'...'	null
+1.345E-6	'db2 batch'	X'afd4'	g'...'	Null

Each parameter is defined like a SQL constant, and is separated from other parameters by whitespace. Non-delimited text represents a number, plain delimited (') text represents a single byte character string, 'x' or 'X' prefixed text enclosed in single quotation marks (') represents a binary string encoded as pairs of hex digits, 'g', 'G', 'n', or 'N' prefixed text enclosed in single quotation marks (') represents a graphic string composed of double byte characters, and 'NULL' (case insensitive) represents a null value. To specify XML data, use delimited (') text, such as '<last>Brown</last>'.

Parameter Input File Format:

Line X lists the set of parameters to supply to the Xth SQL statement that is executed in the input file. If blocks of statements are not repeated, then this corresponds to the Xth SQL statement that is listed in the input file. A blank line represents no parameters for the corresponding SQL statement. The number of parameters and their types must agree with the number of parameters and the types expected by the SQL statement.

Parameter Directive Format:

```
--#PARAM [single | start:end | start:step:end] [...]
```

Each parameter directive specifies a set of parameter values from which one random value is selected for each execution of the query. Sets are composed of both single parameter values and parameter value ranges. Parameter value ranges are specified by placing a colon (':') between two valid parameter values, with whitespace being an optional separator. A third parameter value can be placed between the start and end values to be used as a step size which overrides the default. Each parameter range is the equivalent of specifying the single values of 'start', 'start+step', 'start+2*step', ... 'start+n*step' where *n* is chosen such that 'start+n*step' >= 'end' but 'start+(n+1)*step' > 'end'. While parameter directives can be used to specify sets of values for any type of parameter (even NULL), ranges are only supported on numerical parameter values (integers and decimal numbers).

-t *delcol*

Specifies a single character column separator. Specify -t TAB for a tab column delimiter or -t SPACE for a space column delimiter. By default, a space is used when the -q on option is set, and a comma is used when the -q del option is set.

- r *result_file*
An output file that will contain the query results. If the optional *summary_file* is specified, it will contain the summary table. The default is standard output.
- c Automatically commit changes resulting from each statement. The default is ON.
- i Specifies to measure elapsed time intervals. Valid values are:
 - short** Measure the elapsed time to run each statement. This is the default.
 - long** Measure the elapsed time to run each statement including overhead between statements.
 - complete** Measure the elapsed time to run each statement where the prepare, execute, and fetch times are reported separately.
- g Specifies whether timing is reported by block or by statement. Valid values are:
 - on** A snapshot is taken for the entire block and only block timing is reported in the summary table. This is the default.
 - off** A snapshot is taken and summary table timing is reported for each statement executed in the block.
- w Specifies the maximum column width of the result set, with an allowable range of 0 to 2 G. Data is truncated to this width when displayed, unless the data cannot be truncated. You can increase this setting to eliminate the warning CLI0002W and get a more accurate fetch time. The default maximum width is 32768 columns.
- time Specifies whether or not to report the timing information. Valid values are:
 - on** Timing is reported. This is the default.
 - off** Timing is not reported.
- cli Embedded dynamic SQL mode, previously the default mode for the db2batch, command is no longer supported. This command only runs in CLI mode. The -cli option exists for backwards compatibility. Specifying it (including the optional *cache-size* argument) will not cause errors, but will be ignored internally.
- msw *switch*
Sets the state of each specified monitor switch. You can specify any of the following: uow, statement, table, bufferpool, lock, sort, and timestamp. The special switch all sets all of the above switches. For each switch that you specify you must choose one of:
 - hold** The state of the switch is unchanged. This is the default.
 - on** The switch is turned ON.
 - off** The switch is turned OFF.
- mss *snapshot*
Specifies the monitoring snapshots that should be taken after each statement or block is executed, depending on the -g option. More than one snapshot can be taken at a time, with the information from all snapshots combined into one large table before printing. The possible snapshots are: applinfo_all, dbase_applinfo, dcs_applinfo_all, db2, dbase, dbase_all,

dcx_dbase, dcs_dbase_all, dbase_remote, dbase_remote_all, agent_id, dbase_appls, appl_all, dcs_appl_all, dcs_appl_handle, dcs_dbase_appls, dbase_appls_remote, appl_remote_all, dbase_tables, appl_locks_agent_id, dbase_locks, dbase_tablespaces, bufferpools_all, dbase_bufferpools, and dynamic_sql.

The special snapshot all takes all of the above snapshots. Any snapshots involving an appl ID are not supported in favour of their agent ID (application handle) equivalents. By default, no monitoring snapshots are taken.

- iso** Specifies the isolation level, which determines how data is locked and isolated from other processes while the data is being accessed. By default, db2batch uses the RR isolation level.

The TxnIsolation configuration keyword in the db2cli.ini file does not affect db2batch. To run this command with an isolation level other than RR, the -iso parameter must be specified.

RR Repeatable read (ODBC Serializable). This is the default.

RS Read stability (ODBC Repeatable Read).

CS Cursor stability (ODBC Read Committed).

UR Uncommitted read (ODBC Read Uncommitted).

-o options

Control options. Valid options are:

f *rows_fetch*

Number of rows to be fetched from the answer set. Valid values are -1 to *n*. The default value is -1 (all rows are to be fetched).

r *rows_out*

Number of fetched rows to be sent to output. Valid values are -1 to *n*. The default value is -1 (all fetched rows are to be sent to output).

p *perf_detail*

Specifies the level of performance information to be returned. Valid values are:

- 0** Do not return any timing information or monitoring snapshots.
- 1** Return elapsed time only.
- 2** Return elapsed time and a snapshot for the application.
- 3** Return elapsed time, and a snapshot for the database manager, the database, and the application.
- 4** Return a snapshot for the database manager, the database, the application, and the statement (the latter is returned only if autocommit is OFF, and single statements, not blocks of statements, are being processed).
- 5** Return a snapshot for the database manager, the database, the application, and the statement (the latter is returned only if autocommit is OFF, and single statements, not blocks of statements, are being processed). Also return a

snapshot for the buffer pools, table spaces and FCM (an FCM snapshot is only available in a multi-database-partition environment).

The default value is 1. A value >1 is only valid on DB2 Version 2 and DB2 database servers, and is not currently supported on host machines.

o *query_optimization_class*

Sets the query optimization class. Valid values are 0, 1, 2, 3, 5, 7, or 9. The default is -1 to use the current optimization class.

e *explain_mode*

Sets the explain mode under which db2batch runs. The explain tables must be created prior to using this option. Valid values are:

no Run query only (default).

explain

Populate explain tables only. This option populates the explain tables and causes explain snapshots to be taken.

yes Populate explain tables and run query. This option populates the explain tables and causes explain snapshots to be taken.

s *error_stop*

Specifies whether or not db2batch should stop running when a non-critical error occurs. Valid values are:

no Continue running when a non-critical error occurs. This is the default option.

yes Stop running when a non-critical error occurs.

-v Verbose. Send information to standard error during query processing. The default value is OFF.

-s Summary table. Provide a summary table for each query or block of queries, containing elapsed time with arithmetic and geometric means, the rows fetched, and the rows output.

-q Query output. Valid values are:

off Output the query results and all associated information. This is the default.

on Output only query results in non-delimited format.

del Output only query results in delimited format.

-l *stmt_delimiter*

Specifies the termination character (statement delimiter). The delimiter can be 1 or 2 characters. The default is a semi-colon (;).

-h | -u | -?

Displays help information. When this option is specified, all other options are ignored, and only the help information is displayed.

Examples

1. The following is sample output from the command `db2batch -d crystal -f update.sql`

```

* Timestamp: Thu Feb 02 2006 10:06:13 EST
-----

* SQL Statement Number 1:
create table demo (c1 bigint, c2 double, c3 varchar(8));
* Elapsed Time is:      0.101091 seconds
-----

* SQL Statement Number 2:
insert into demo values (-9223372036854775808, -0.000000000000005, 'demo');
* Elapsed Time is:      0.002926 seconds
-----

* SQL Statement Number 3:
insert into demo values (9223372036854775807, 0.000000000000005, 'demodemo');
* Elapsed Time is:      0.005676 seconds
-----

* SQL Statement Number 4:
select * from demo;

C1                C2                C3
-----
-9223372036854775808 -5.000000000000000E-015 demo
 9223372036854775807 +5.000000000000000E-015 demodemo

* 2 row(s) fetched, 2 row(s) output.
* Elapsed Time is:      0.001104 seconds
-----

* SQL Statement Number 5:
drop table demo;
* Elapsed Time is:      0.176135 seconds

* Summary Table:

Type      Number      Repetitions Total Time (s) Min Time (s)  Max Time (s)
-----
Statement      1          1      0.101091      0.101091      0.101091
Statement      2          1      0.002926      0.002926      0.002926
Statement      3          1      0.005676      0.005676      0.005676
Statement      4          1      0.001104      0.001104      0.001104
Statement      5          1      0.176135      0.176135      0.176135

Arithmetic Mean Geometric Mean Row(s) Fetched Row(s) Output
-----
      0.101091      0.101091          0          0
      0.002926      0.002926          0          0
      0.005676      0.005676          0          0
      0.001104      0.001104          2          2
      0.176135      0.176135          0          0

* Total Entries:      5

```



```
* Total Time:          0.286932 seconds
* Minimum Time:       0.001104 seconds
* Maximum Time:      0.176135 seconds
* Arithmetic Mean Time: 0.057386 seconds
* Geometric Mean Time: 0.012670 seconds
-----
```

```
* Timestamp: Thu Feb 02 2006 10:06:13 EST
```

Usage notes

- All SQL statements must be terminated by a delimiter (default ';') set by the `--SET DELIMITER` command. This delimiter can be 1 or 2 characters.
- SQL statement length is limited only by available memory and the interface used. Statements can break over multiple lines, but multiple statements are not allowed on a single line.
- Input file line length is limited only by available memory.
- `c` automatically issues `CONNECT` and `CONNECT RESET` statements.
- `PAUSE` and `SLEEP` are timed when *long* is specified for the *-i* timing option.
- Explain tables must be created before explain options can be used.
- All command line options and input file statements are case insensitive with respect to `db2batch`.
- `db2batch` supports the following data types: `INTEGER`, `CHAR`, `VARCHAR`, `LONG VARCHAR`, `FLOAT`, `SMALLINT`, `BIGINT`, `DECIMAL`, `DATE`, `TIME`, `TIMESTAMP`, `CLOB`, `GRAPHIC`, `VARGRAPHIC`, `LONGVARGRAPHIC`, `DBCLOB`, `BLOB`, and `XML`.
- `--SET PERF_DETAIL perf_detail` (or `-o p perf_detail`) provides a quick way to obtain monitoring output. If the performance detail level is `> 1`, all monitor switches are turned on internally by `db2batch`. If more precise control of monitoring output is needed, use the options `-msw` and `-mss` (or `--SET SNAPSHOT`).

Chapter 166. db2acsutil - Manage DB2 snapshot backup objects command

You can use db2acsutil to manage DB2 snapshot backup objects in the following three ways:

1. list the DB2 snapshot backups that you can use to restore your database
2. delete DB2 snapshot backups that were generated using the BACKUP command, the db2Backup API, or the ADMIN_CMD stored procedure with the BACKUP DATABASE parameter
3. monitor the status of DB2 snapshot backups

Authorization

None

Required connection

None

Command syntax

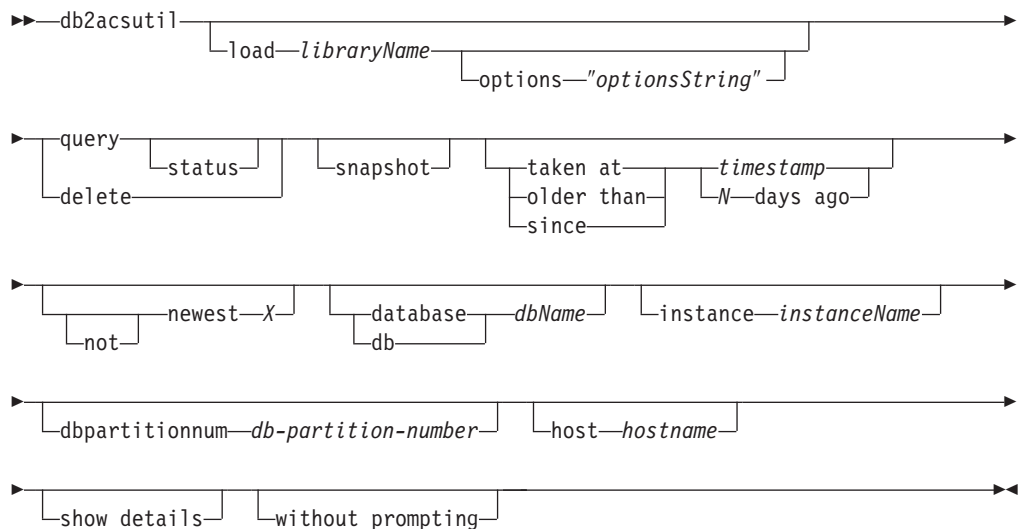

Command parameters

load *libraryName*

The name of the shared library containing the vendor fast copying technology used in the DB2 snapshot backup. This parameter can contain the full path. If the full path is not given, the default path is the same library as with the BACKUP DB and RESTORE DB commands (in ~/sqlib/acs).

options "*optionsString*"

Specifies options to be used for this utility. The string will be passed to the vendor support library exactly as it was entered, without the double quotation marks.

query

Queries the ACS repository and returns a table of known objects.

status

Queries the ACS repository and returns a table of known objects with their current status.

delete

This deletes DB2 snapshot objects, and removes their record from the ACS repository once they have been deleted.

snapshot

Filters the records returned or operated on to only snapshot objects.

taken at | older than | since

These options filter the results of the utility to the specified time ranges.

timestamp

A timestamp of the form YYYYMMDDhhmmss.

N days ago

Number of days ago, where *N* is the number of days prior to the current date.

[not] newest X

Filter the utility results such that only the newest (by timestamp) *X* records are considered. If the NOT keyword is specified, then all records except the newest *X* are considered.

database | db *dbName*

Considers only those objects associated with the specified database name.

instance *instanceName*

The name of the database manager instance associated with the DB2 snapshot backup objects you are managing.

dbpartitionnum *db-partition-number*

Considers only those objects created by the specified database partition number.

host *hostname*

Considers only those objects created by the specified *hostname*. For example, this would typically be the TCP/IP hostname of the DB2 server.

show details

Displays detailed object information from the ACS repository. If this option is used, instead of a table with a single brief record per line, a detailed stanza will be produced for each ACS object.

without prompting

Specifies that the utility will run unattended, and that any actions which normally require user intervention will return an error message.

Examples

Sample output for a snapshot backup with an active background copy.

```
db2acsutil query status db f01 instance db2inst1 dbpartitionnum 0
```

```
Instance  Database  Part Image Time      Status
=====  =====  ===  =====  =====
keon14    F01         0    20070719120848  Remotely mountable + Background_monitor
                                           pending (16 / 1024 MB)
```

Sample output for a snapshot backup with a completed background copy.
db2acsutil query status db f01 instance db2inst1 dbpartitionnum 0 show details

```
Instance : keon14
Database : F01
Partition : 0
Image timestamp : 20070719120848
Host : machine1
Owner :
DB2 Version : 9.5.0
Creation time : Thu Jul 19 12:08:50 2007
First active log (chain:file) : 0:0
Metadata bytes : 6196
Progress state : Successful
Usability state : Remotely mountable + Repetitively restorable + Swap restorable
                  + Physical protection + Full copy
Bytes completed : 0
Bytes total : 0
```

Usage notes

Using db2acsutil is the only way to delete DB2 snapshot backups created using the BACKUP command, the db2Backup API, or the ADMIN_CMD stored procedure with the BACKUP DATABASE parameter. You cannot use automated recovery object deletion or the PRUNE HISTORY command with the AND DELETE parameter to delete DB2 snapshot backups. You also cannot delete backups manually through the filer/storage system.

The usability state of a DB2 snapshot backup indicates what you can do with the DB2 snapshot. Table 1 lists and describes possible DB2 snapshot backup usability states.

Table 37. Usability states returned for DB2 snapshot backups

Usability state	Description
LOCALLY_MOUNTABLE	You can mount the backed up data from the local machine.
REMOTEY_MOUNTABLE	You can mount the backed up data from a remote machine.
REPETITIVELY_RESTORABLE	You can use the DB2 snapshot backup image multiple times to restore your backed up data.
DESTRUCTIVELY_RESTORABLE	You can use the DB2 snapshot backup image to restore your backed up data once; after the backed up data is restored, this DB2 snapshot image, and potentially others, are destroyed.
SWAP_RESTORABLE	You can access the volumes directly, but a RESTORE DB command cannot be executed and the backed up data cannot be copied back onto the source volumes.
PHYSICAL_PROTECTION	The snapshot is protected against physical failures in the source volumes.
FULL_COPY	A full copy of the data has been created. You can use the DB2 snapshot backup image to restore the backed up data.

Table 37. Usability states returned for DB2 snapshot backups (continued)

Usability state	Description
DELETED	Indicates that a backup has been marked for deletion. The snapshot storage associated with a DELETED backup will be withdrawn via a maintenance process running in the background. Once this has completed, the backup will be removed from the ACS repository.
FORCED_MOUNT	Awaiting verification of filesystem consistency by mounting an AIX JFS filesystem.
BACKGROUND_MONITOR_PENDING	Status is being monitored by the ACS background progress monitor.
TAPE_BACKUP_PENDING	Awaiting an offloaded tape backup.
TAPE_BACKUP_IN_PROGRESS	An offloaded tape backup is currently in progress.
TAPE_BACKUP_COMPLETE	Offloaded tape backup has completed.

Chapter 167. db2bfd - Bind file description tool

Displays the contents of a bind file. This utility, which can be used to examine and to verify the SQL statements within a bind file, as well as to display the precompile options used to create the bind file, might be helpful in problem determination related to an application's bind file.

Authorization

None

Required connection

None

Command syntax



Command parameters

- h Display help information. When this option is specified, all other options are ignored, and only the help information is displayed.
 - b Display the bind file header.
 - s Display the SQL statements.
 - v Display the host variable declarations.
- filespec* Name of the bind file whose contents are to be displayed.

Chapter 168. db2ca - Start the Configuration Assistant

Starts the Configuration Assistant. The Configuration Assistant is a graphical interface that is used to manage DB2 database configuration such as database manager configuration, DB2 registry, node directory, database directory and DCS directory.

Important: This command has been deprecated and might be removed in a future release because the Control Center and its associated components have been deprecated in Version 9.7. For more information, see the “Control Center tools and DB2 administration server (DAS) have been deprecated” topic in the *What’s New for DB2 Version 9.7* book.

Authorization

sysadm

Required Connection

None

Command syntax

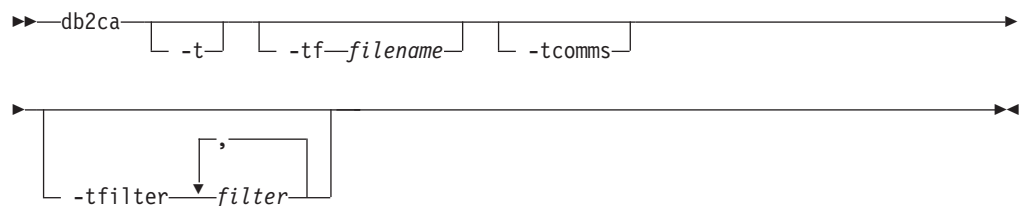

Command parameters

- t** Turns on the GUI trace and sends the output to a console window. On Windows operating systems, the `db2ca` command does not have a console window. Therefore, this option has no effect on Windows operating systems.
- tf filename** Turns on the GUI trace and saves the output of the trace to the specified file. The output file is saved to `<DB2 install path>\sql1lib\tools` on Windows operating systems and to `/home/<userid>/sql1lib/tools` on Linux and UNIX systems.
- tcomms** Limits tracing to communications events.
- tfilter filter** Limits tracing to entries containing the specified filter or filters.

Chapter 169. db2cap - CLI/ODBC static package binding tool

Binds a capture file to generate one or more static packages. A capture file is generated during a static profiling session of a CLI/ODBC/JDBC/.NET application, and contains SQL statements that were captured during the application run. This utility processes the capture file so that it can be used by the CLI/ODBC/JDBC/.NET driver to execute static SQL for the application.

Authorization

- Access privileges to any database objects referenced by SQL statements recorded in the capture file.
- Sufficient authority to set bind options such as OWNER and QUALIFIER if they are different from the connect ID used to invoke the db2cap command.
- BINDADD authority if the package is being bound for the first time; otherwise, BIND authority is required.

Command syntax

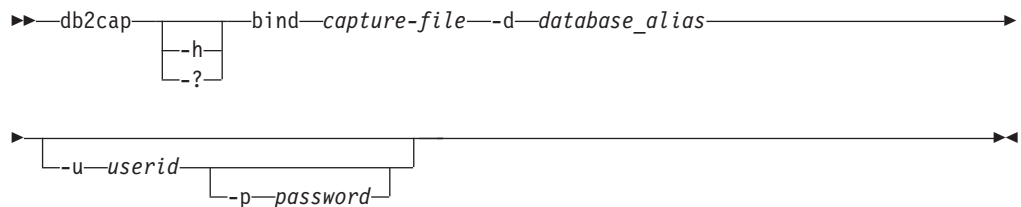

Command parameters

-h | -? Displays help text for the command syntax.

bind *capture-file*

Binds the statements from the capture file and creates one or more packages. This capture file is also known as the pureQueryXML file for .NET.

-d *database_alias*

Specifies the database alias for the database that will contain one or more packages.

-u *userid*

Specifies the user ID to be used to connect to the data source. If a user ID is not specified, a trusted authorization ID is obtained from the system.

-p *password*

Specifies the password to be used to connect to the data source.

Usage notes

This command must be entered in lowercase on UNIX platforms, but can be entered in either lowercase or uppercase on Windows operating systems. Static package binding for .NET applications is supported only on Windows operating systems.

This utility supports many user-specified bind options that can be found in the capture file. In order to change the bind options, open the capture file in a text editor.

The `SQLERROR(CONTINUE)` and the `VALIDATE(RUN)` bind options can be used to create a package.

When using this utility to create a package, static profiling must be disabled.

The number of packages created depends on the isolation levels used for the SQL statements that are recorded in the capture file. The package name consists of up to a maximum of the first seven characters of the package keyword from the capture file, and one of the following single-character suffixes:

- 0 - Uncommitted Read (UR)
- 1 - Cursor Stability (CS)
- 2 - Read Stability (RS)
- 3 - Repeatable Read (RR)
- 4 - No Commit (NC)

To obtain specific information about packages, the user can:

- Query the appropriate SYSIBM catalog tables using the `COLLECTION` and `PACKAGE` keywords found in the capture file.
- View the capture file.

Chapter 170. db2cat - System catalog analysis

Analyzes the contents of packed descriptors. Given a database name and other qualifying information, this command will query the system catalogs for information and format the results. It must be issued on the server.

Authorization

None

Required Connection

None

Command syntax

```
db2cat [-d dbname] [-h] [-l] [-n name] [-o outfile]
       [-p descriptor] [-vi versionID] [-s schema] [-t] [-z]
       [-v] [-x] [-cb]
```

Command parameters

-d *dbname*

dbname is the name of the database for which the command will query the system catalogs.

-h Displays usage information.

-l Turns on case sensitivity for the object name.

-n *name*

Specifies the name of the object.

-o *outfile*

Specifies the name of the output file.

-p *descriptor*

Specifies the name of the packed descriptor (pd) to display where *descriptor* is one of the following:

check Display table check constraints packed descriptor.

rel Display referential integrity constraint packed descriptor.

table Display table packed descriptor. This includes the inline length if at least one exists for the table.

summary

Display summary table packed descriptor.

trig Display table trigger packed descriptor.

view Display view packed descriptor.

remote Display remote non-relational data sources packed descriptor.

ast Display materialized query table packed descriptor.

routine Display routine packed descriptor.

sysplan Display package packed descriptor.

datatype Display structured type packed descriptor.

sequence Display sequence packed descriptor.

esri Display key transformation thread and index extension packed descriptor.

event Display event monitor packed descriptor.

server Display server packed descriptor.

auth Display privileges held by this grantee on this object.

-vi *versionID*
Specifies the version ID of the package packed descriptor. -vi is only valid when -p sysplan is specified. If *versionID* is omitted, the default is the empty string.

-s *schema*
Specifies the name of the object schema.

-t Displays terminal output.

-z Disables keystroke prompt.

-v Validates packed descriptor. This parameter is only valid for table packed descriptors.

-x Validates table space extentsize in catalogs (does not require a table name).

-cb Cleans orphan rows from SYSCAT.BUFFERPOOLNODES (does not require a table name).

Usage notes

- Table name and table schema may be supplied in LIKE predicate form, which allows percent sign (%) and underscore (_) to be used as pattern matching characters to select multiple sources with one invocation.
- Prompting will occur for all fields that are not supplied or are incompletely specified (except for the -h and -l options).
- If -o is specified without a file name, and -t is not specified, you will be prompted for a file name (the default name is db2cat.out).
- If neither -o nor -t is specified, you will be prompted for a file name (the default is terminal output).
- If -o and -t are both specified, the output will be directed to the terminal.

Chapter 171. db2cc - Start control center

Starts the Control Center. The Control Center is a graphical interface that is used to manage database objects (such as databases, tables, and packages) and their relationship to one another.

Important: This command has been deprecated and might be removed in a future release because the Control Center and its associated components have been deprecated in Version 9.7. For more information, see the “Control Center tools and DB2 administration server (DAS) have been deprecated” topic in the *What’s New for DB2 Version 9.7* book.

Authorization

sysadm

Command syntax

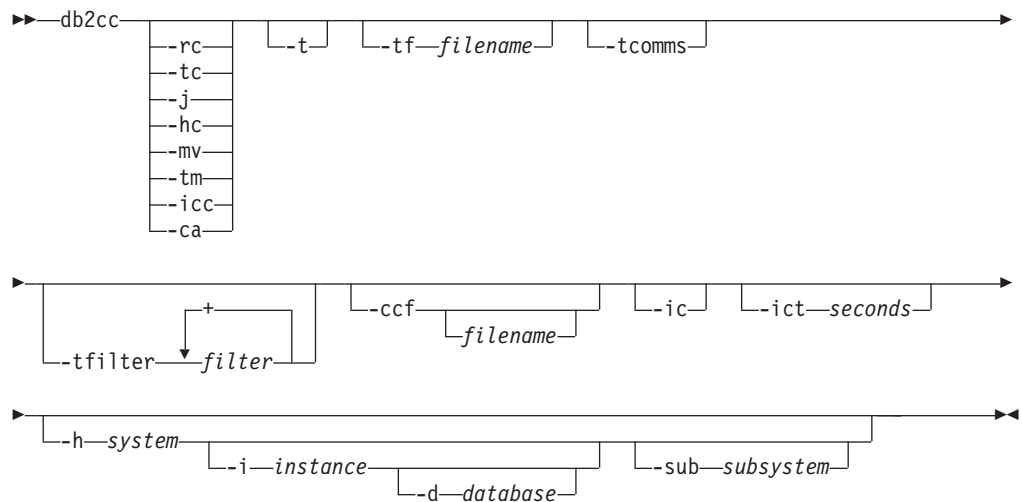

Command parameters

- `-rc` Opens the Replication Center.
- `-hc` Opens the Health Center.
- `-tc` Opens the Task Center.
- `-j` Opens the Journal.
- `-mv` Opens the Memory Visualizer.
- `-tm` Opens the Identify Indoubt Transaction Manager.
- `-icc` Opens the Information Catalog Manager.
- `-ca` Opens the Configuration Assistant.
- `-t` Turns on Control Center Trace for an initialization code. On Windows operating systems, the `db2cc` command does not have a console window. Therefore, this option has no effect on Windows operating systems.

- tf** Turns on Control Center Trace for an initialization code and saves the output of the trace to the specified file. The output file is saved to <DB2 install path>\sqllib\tools on Windows and to /home/<userid>/sqllib/tools on UNIX operating systems.
- tcomms**
Limits tracing to communications events.
- tfilter** *filter*
Limits tracing to entries containing the specified filter or filters.
- ccf** *filename*
Opens the Command Editor. If a filename is specified, the contents of this file are loaded into the Command Editor's Script page. When specifying a file name, you must provide the absolute path to the file.
- ic** Opens the Information Center.
- ict** *seconds*
Idle Connection Timer. Closes any idle connections in the pools maintained by the Control Center after the number of seconds specified. The default timer is 30 minutes.
- h** *system*
Opens the Control Center in the context of a system.
- i** *instance*
Opens the Control Center in the context of an instance.
- d** *database*
Opens the Control Center in the context of a database.
- sub** *subsystem*
Opens the Control Center in the context of a subsystem.

Chapter 172. db2cfexp - Connectivity configuration export tool

Exports connectivity configuration information to an export profile, which can later be imported at another DB2 database workstation instance of similar instance type (that is, client instance to client instance). The resulting profile will contain only configuration information associated with the current DB2 database instance. This profile can be referred to as a *client* configuration profile or a configuration profile of an *instance*.

This utility exports connectivity configuration information into a file known as a configuration profile. It is a non-interactive utility that packages all of the configuration information needed to satisfy the requirements of the export options specified. Items that can be exported are:

- Database information (including DCS and ODBC information)
- Node information
- Protocol information
- database manager configuration settings
- registry settings
- Common ODBC/CLI settings.

This utility is especially useful for exporting connectivity configuration information at workstations that do not have the DB2 Configuration Assistant installed, and in situations where multiple similar remote DB2 clients are to be installed, configured, and maintained (for example, cloning or making templates of client configurations).

Authorization

One of the following:

- *sysadm*
- *sysctrl*

Command syntax

```
▶▶ db2cfexp filename [TEMPLATE | BACKUP | MAINTAIN] ▶▶
```

Command parameters

filename

Specifies the fully qualified name of the target export file. This file is known as a configuration profile.

TEMPLATE

Creates a configuration profile that is used as a template for other instances of the same instance type (that is, client instance to client instance). The profile includes information about:

- All databases, including related ODBC and DCS information
- All nodes associated with the exported databases

- Common ODBC/CLI settings
- Common client settings in the database manager configuration
- Common client settings in the DB2 registry.

BACKUP

Creates a configuration profile of the DB2 database instance for local backup purposes. This profile contains all of the instance configuration information, including information of a specific nature relevant only to this local instance. The profile includes information about:

- All databases including related ODBC and DCS information
- All nodes associated with the exported databases
- Common ODBC/CLI settings
- All settings in the database manager configuration
- All settings in the DB2 registry
- All protocol information.

MAINTAIN

Creates a configuration profile containing only database- and node-related information for maintaining or updating other instances.

Note:

The db2cfexp command will not export the File data source location information from a client.

If you use the default location, no action is required. If you change the default location on a client, you will need to manually copy this location when exporting connectivity information.

To copy the File data source location from one client to another:

1. On the client you are exporting connectivity information, locate the %DB2PATH%\TOOLS directory.
2. Copy the CA.properties file.
3. On the client you are importing connectivity information, locate the %DB2PATH%\TOOLS directory.
4. Overwrite the existing CA.properties file with the copy taken from the originating client.

You have duplicated the File data source location from one client to another.

Chapter 173. db2cfimp - Connectivity configuration import tool

Imports connectivity configuration information from a file known as a configuration profile. It is a non-interactive utility that will attempt to import all the information found in the configuration profile.

A configuration profile can contain connectivity items such as:

- Database information (including DB2 Connect and ODBC information)
- Node information
- Protocol information
- database manager configuration settings
- DB2 database registry settings
- Common ODBC/CLI settings.

This utility can be used to duplicate the connectivity information from another similar instance (that is, client instance to client instance) that was configured previously. It is especially useful on workstations that do not have the DB2 Configuration Assistant (CA) installed, and in situations where multiple similar remote DB2 clients are to be installed, configured, and maintained (for example, cloning or making templates of client configurations). When cloning an instance, the profile imported should always be a client configuration profile that contains configuration information about one DB2 database instance only.

Authorization

One of the following:

- *sysadm*
- *sysctrl*

Note:

- The root ID should not be used to run the tool.
- If a valid ID is used to run the tool, the ID must have the correct permission for the configuration profile to be imported.

Command syntax

►►—db2cfimp—*filename*—————►►

Command parameters

filename

Specifies the fully qualified name of the configuration profile to be imported. Valid import configuration profiles are profiles created by any DB2 database or DB2 Connect product using the Configuration Assistant, Control Center, or db2cfexp.

Chapter 174. db2chglibpath - Modify the embedded runtime library search path

Modifies the embedded runtime library search path value within an executable or shared library file. It can be used to replace the embedded runtime library search path value with a new user-specified value when the existing value is no longer valid.

The db2chglibpath command can be used to replace the requirement for using operating system library search path environment variables such as LIBPATH (AIX), SHLIB_PATH (HPPA, HPIPF) and LD_LIBRARY_PATH (AIX, SUN, HPPA64, HPIPF and Linux). This command is only supported on Linux and UNIX operating systems. It can be found under the DB2DIR/bin directory, where DB2DIR is the DB2 database installation location.

Prerequisites

- Read and write access is required on the shared library or executable file to be modified.
- The binary has to have an embedded library path to start with, and the embedded path cannot be changed to anything bigger than the path already in the binary.
- The length of the user-specified value that is to replace the embedded runtime library search path value must not be greater than the existing value.
- This command directly modifies the binary code of the shared library or executable file and it is *strongly recommended* that you create a backup of the file before using the command.

Required Connection

None

Command syntax

```
► db2chglibpath [ -querypath ] [ -q ] [ -search=search-expression -replace=replace-expression ] [ -show ] [ -32 ] [ -64 ] [ -verbose ] [ -help ] [ -v ] [ -h ]
```

Command parameters

-querypath

Specifies that a query should be performed without altering the embedded library path in the binary.

-search=search-expression

Specifies the expression to be searched for.

- replace=***replace-expression*
Specifies the expression that the *search-expression* is to be replaced with.
- show** Specifies that the search and replace operations are to be performed without actually writing the changes to the file(s).
- 32** Performs the operation if the binary type is 32-bit.
- 64** Performs the operation if the binary type is 64-bit.
- verbose**
Displays information about the operations that are being performed.
- help** Displays usage information.

Examples

- To change the embedded runtime library search path value in the executable file named `myexecutable` from `/usr/opt/db2_08_01/lib` to `/u/usr1/sqllib/lib32`, issue:

```
db2chglbpath -search=/usr/opt/db2_08_01/lib -replace=/u/usr1/sqllib/lib32
/mypath/myexecutable
```

Note that the length of the new value is the same as that of the original value.

Usage notes

- This command is only to be used for updating DB2 database application executables and DB2 external routine shared library files when other methods for upgrading applications and routines cannot be used or are unsuccessful. See the related links for topics on application and routine upgrade.
- This command is not supported under DB2 service contract agreements. It is provided as-is and as such, IBM is not responsible for its unintended or malicious use.
- This command does not create a backup of the shared library or executable file before modifying it. It is *strongly recommended* that a backup copy of the file be made prior to issuing this command.

Chapter 175. db2chgpath - Change embedded runtime path

Used by DB2 installer on Linux and UNIX systems to update the embedded runtime path in the related DB2 library and executable files. The command can be reissued under the direction of IBM DB2 support if there were errors related to the command during the DB2 installation.

Note: If SELinux (Security-enhanced Linux) is enabled after the DB2 installations on Red Hat Enterprise Linux version 5 (RHEL5), you need to manually run this command for each DB2 installation of the current release to make DB2 work properly. See *Usage notes* section below for additional information.

Authorization

Root installations require root authority. For non-root installations, you must log on with the user ID that owns the non-root installation.

Required Connection

None

Command syntax

```
db2chgpath -d -f file-name
```

Command parameters

- d** Turns debug mode ON. Use this option only when instructed by DB2 Support.
- f file-name** Specifies a specific file name to update the runtime path. *file-name* should have the path name relative to the base of the current DB2 product install location.

Examples

- To check all files under the DB2 product install path and do a runtime path update, issue:
`<DB2 installation path>/install/db2chgpath`
- To update the path for a specific file called `libdb2.a` which is under `<DB2 installation path>/lib64` directory, issue:
`<DB2 installation path>/install/db2chgpath -f lib64/libdb2.a`

Usage notes

On RHEL5 systems, if the user has installed a DB2 product, when SELinux was either uninstalled or disabled, and wants to enable SELinux, these are the steps:

- Install SELinux rpms if necessary.
- Change `/etc/sysconfig/selinux`; set the status to "permissive" or "enforcing".
- Reboot the machine to apply SELinux labels to all files.

- Run `db2chgpath` to set the SELinux attribute that allows DB2 shared libraries with text relocations to be loaded (`textrel_shlib_t`).

Chapter 176. db2ckbkp - Check backup

This utility can be used to test the integrity of a backup image and to determine whether or not the image can be restored. It can also be used to display the metadata stored in the backup header.

Authorization

Anyone can access the utility, but users must have read permissions on image backups in order to execute this utility against them.

Required connection

None

Command syntax

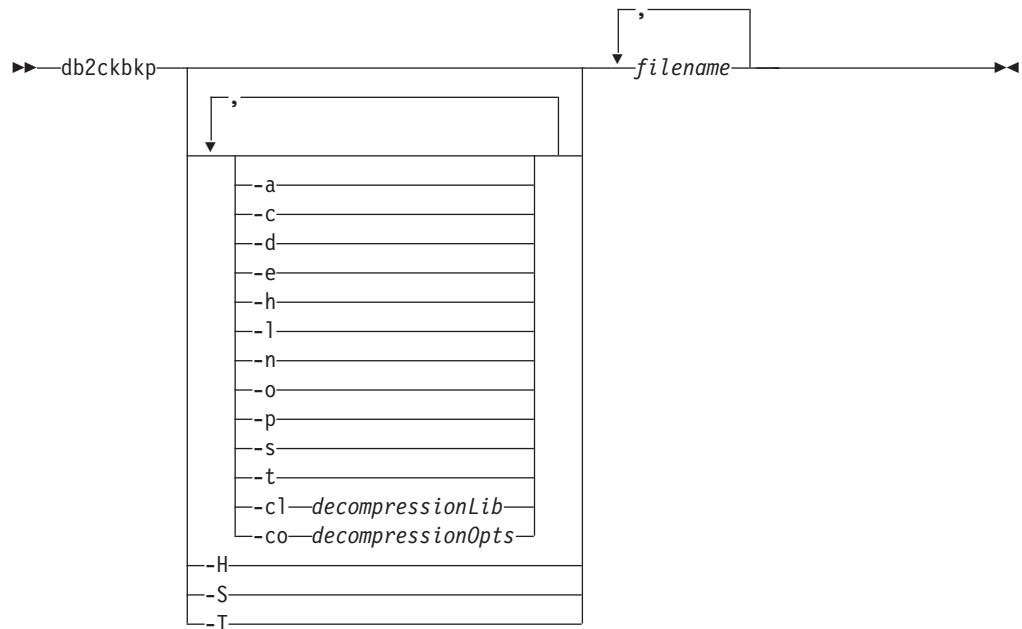

Command parameters

- a Displays all available information.
- c Displays results of checkbits and checksums.
- cl *decompressionLib*
Indicates the name of the library to be used to perform the decompression. The name must be a fully qualified path referring to a file on the server. If this parameter is not specified, DB2 will attempt to use the library stored in the image. If the backup was not compressed, the value of this parameter will be ignored. If the specified library cannot be loaded, the operation will fail.
- co *decompressionOpts*
Describes a block of binary data that will be passed to the initialization

routine in the decompression library. DB2 will pass this string directly from the client to the server, so any issues of byte reversal or code page conversion will have to be handled by the decompression library. If the first character of the data block is '@', the remainder of the data will be interpreted by DB2 as the name of a file residing on the server. DB2 will then replace the contents of *string* with the contents of this file and will pass this new value to the initialization routine instead. The maximum length for string is 1024 bytes.

- d Displays information from the headers of DMS table space data pages.
- e Extracts pages from an image to a file. To extract pages, you will need an input and an output file. The default input file is called `extractPage.in`. You can override the default input file name by setting the `DB2LISTFILE` environment variable to a full path. The format of the input file is as follows:

For SMS table spaces:

```
S <tbspID> <objID> <objType> <startPage> <numPages>
```

Note:

1. <startPage> is an object page number that is object-relative.

For DMS table spaces:

```
D <tbspID> <objType> <startPage> <numPages>
```

Note:

1. <objType> is only needed if verifying DMS load copy images.
2. <startPage> is an object page number that is pool-relative.

For log files:

```
L <log num> <startPos> <numPages>
```

For other data (for example, initial data):

```
O <objType> <startPos> <numBytes>
```

The default output file is `extractPage.out`. You can override the default output file name by setting the `DB2EXTRACTFILE` environment variable to a full path.

- h Displays media header information including the name and path of the image expected by the restore utility.
- H Displays the same information as -h but only reads the 4K media header information from the beginning of the image. It does not validate the image. This option cannot be used in combination with any other options.
- l Displays log file header (LFH) and mirror log file header (MFH) data.
- n Prompt for tape mount. Assume one tape per device.
- o Displays detailed information from the object headers.
- p Displays the number of pages of each object type. This option will not show the number of pages for all different object types if the backup was done for DMS table spaces data. It only shows the total of all pages as `SQLUDMSTABLESPACEDATA`. The object types for `SQLUDMSLOBDATA` and `SQLUDMSLONGDATA` will be zero for DMS table spaces.
- s Displays the automatic storage paths in the image.

- S Displays the same information as -s but does not validate the image. This option cannot be used in combination with any other options.
- t Displays table space details, including container information, for the table spaces in the image.
- T Displays the same information as -t but does not validate the image. This option cannot be used in combination with any other options.

filename

The name of the backup image file. One or more files can be checked at a time.

Note:

1. If the complete backup consists of multiple objects, the validation will only succeed if db2ckbkp is used to validate all of the objects at the same time.
2. When checking multiple parts of an image, the first backup image object (.001) must be specified first.

Examples

Example 1 (on UNIX platforms)

```
db2ckbkp SAMPLE.0.krodger.NODE0000.CATN0000.19990817150714.001
SAMPLE.0.krodger.NODE0000.CATN0000.19990817150714.002
SAMPLE.0.krodger.NODE0000.CATN0000.19990817150714.003
```

```
[1] Buffers processed: ##
[2] Buffers processed: ##
[3] Buffers processed: ##
Image Verification Complete - successful.
```

Example 2

```
db2ckbkp -h SAMPLE2.0.krodger.NODE0000.CATN0000.19990818122909.001
```

```
=====
MEDIA HEADER REACHED:
=====
Server Database Name      -- SAMPLE2
Server Database Alias    -- SAMPLE2
Client Database Alias    -- SAMPLE2
Timestamp                 -- 19990818122909
Database Partition Number -- 0
Instance                  -- krodger
Sequence Number          -- 1
Release ID                -- 900
Database Seed             -- 65E0B395
DB Comment's Codepage (Volume) -- 0
DB Comment (Volume)      --
DB Comment's Codepage (System) -- 0
DB Comment (System)      --
Authentication Value      -- 255
Backup Mode               -- 0
Include Logs              -- 0
Compression               -- 0
Backup Type               -- 0
Backup Gran.              -- 0
Status Flags              -- 11
System Cats inc           -- 1
Catalog Database Partition No. -- 0
DB Codeset                -- IS08859-1
DB Territory              --
LogID                     -- 1074717952
```

```
LogPath                -- /home/krodger/krodger/NODE0000/
                        SQL00001/SQLLOGDIR
Backup Buffer Size      -- 4194304
Number of Sessions     -- 1
Platform               -- 0
```

The proper image file name would be:
SAMPLE2.0.krodger.NODE0000.CATN0000.19990818122909.001

```
[1] Buffers processed: ####
Image Verification Complete - successful.
```

Usage notes

1. If a backup image was created using multiple sessions, db2ckbkp can examine all of the files at the same time. Users are responsible for ensuring that the session with sequence number 001 is the first file specified.
2. This utility can also verify backup images that are stored on tape (except images that were created with a variable block size). This is done by preparing the tape as for a restore operation, and then invoking the utility, specifying the tape device name. For example, on UNIX based systems:

```
db2ckbkp -h /dev/rmt0
```

and on Windows:

```
db2ckbkp -d \\.\tape1
```

3. If the image is on a tape device, specify the tape device path. You will be prompted to ensure it is mounted, unless option -n is given. If there are multiple tapes, the first tape must be mounted on the first device path given. (That is the tape with sequence 001 in the header).

The default when a tape device is detected is to prompt the user to mount the tape. The user has the choice on the prompt. Here is the prompt and options: (where the device I specified is on device path /dev/rmt0)

```
Please mount the source media on device /dev/rmt0.
Continue(c), terminate only this device(d), or abort this tool(t)?
(c/d/t)
```

The user will be prompted for each device specified, and when the device reaches the end of tape.

Chapter 177. db2ckupgrade - Check database for upgrade

Verifies that a database can be migrated.

Scope

In a partitioned database environment, run the db2ckupgrade command on each database partition. This command only affects the database partition on which it is issued.

Authorization

SYSADM

Required connection

None

Command syntax

```
db2ckupgrade [-e] [-l filename] [-not1] [-u userid] [-p password]
```

Command parameters

database

Specifies an alias name of a local database to be scanned.

-e Specifies that all local cataloged databases are to be scanned.

-l filename

Specifies a log file to keep a list of errors and warnings generated for the scanned database.

-not1 Disables the check for type-1 indexes. If this option is not specified, the db2ckupgrade command checks for type-1 indexes and generates the type1_index_<database-name>.db2 script file, in the same directory indicated for the log file, containing REORG INDEXES ALL commands with the **ALLOW WRITE ACCESS** and **CONVERT** clauses for each identified type-1 index.

-p password

Specifies the password of the system administrator's user ID.

-u userid

Specifies the user ID of the system administrator.

Usage notes

To run the db2ckupgrade command:

- On Linux and UNIX operating systems, install a new DB2 copy to which you want to upgrade. Then run the db2ckupgrade command from the *DB2DIR/bin* directory, where *DB2DIR* is the location where the DB2 copy is installed.
- On Windows operating systems, insert the DB2 database product CD to which you want to upgrade. Then run the db2ckupgrade command from the db2\Windows\Utilities directory on the CD.

The db2ckupgrade command fails to run against databases which are catalogued as remote databases.

This command verifies that all the following conditions are true:

- A catalogued database actually exists.
- A database is not in an inconsistent state.
- A database is not in a backup pending state.
- A database is not in a restore pending state.
- A database is not in rollforward pending state.
- Table spaces are in a normal state.
- A database does not contain user-defined types (UDTs) with the name ARRAY, BINARY, CURSOR, DECFLOAT, ROW, VARBINARY, or XML.
- A database does not contain the system-defined DATALINK data type.
- A database does not have a schema with the name SYSPUBLIC.
- A database does not have orphan rows in system catalog tables that would cause database upgrade to fail.
- A database enabled as an HADR primary database allows successful connections.
- An HADR database role is not standby.
- If SYSCATSPACE is a DMS table space and AUTORESIZE is not enabled, SYSCATSPACE has at least 50% free pages of total pages.
- A database is not enabled for XML Extender.

A local database must pass all of these checks to succeed at the upgrade process. The db2iupgrade command calls the db2ckupgrade command with the **-not1** parameter and specifying db2ckupgrade.log as the log file. The db2iupgrade fails if the db2ckupgrade command finds that any of these conditions listed above are not true, and returns the DBI1205E error code. The user needs to resolve these errors before upgrading the instance.

The db2ckupgrade command writes to the log file, specified with the **-l** parameter, a warning message for any of the following conditions:

- Column names, routine parameter names, or variable names are called NULL.
- Type-1 indexes exist in the database.
- External routines are declared NOT FENCED and NOT THREADSAFE or user-defined wrappers on UNIX and Linux operating systems are declared NOT FENCED.
- Workload connection attributes contain asterisks (*).
- Database is enabled for DB2 WebSphere® MQ functions.

During installation on Windows operating systems, if you select a DB2 copy with the **upgrade** action in the **Work with Existing** window and you have local

databases cataloged on your instances, a message box will warn you that you must run the `db2ckupgrade` command from the DB2 database product CD. Then you can choose one of the following actions:

- Ignore the message and continue the installation process.
- Run the `db2ckupgrade` command. If this command runs successfully, continue the installation process. If you find errors, quit the installation process, fix any errors, and then rerun the installation process.
- Quit the installation process.

If the `-not1` parameter is omitted, the `db2ckupgrade` command calls the `db2IdentifyType1` command to identify type-1 indexes and to generate a script to convert type-1 indexes to type-2 indexes for a specified database. The `db2IdentifyType1` command can take a long time to complete its processing. The running time of the `db2IdentifyType1` command is proportional to the number of tables in the database and the number of database partitions. Take into account the following performance considerations:

- For databases with a large number of tables, large number of database partitions, or both, first run the `db2IdentifyType1` command on specific schemas or tables by using the `-s` or `-t` parameters until you process all your tables. Then run the `db2ckupgrade` command with the `-not1` parameter.
- For Version 9.1 or Version 9.5 partitioned database environments, run the `db2ckupgrade` command from one database partition, preferably the catalog partition for faster performance, to detect all type-1 indexes. Then run the `db2ckupgrade` command with the `-not1` parameter on all subsequent partitions.

To verify that a database is ready for upgrade, refer to “Verifying that your databases are ready for upgrade” in *Upgrading to DB2 Version 9.7*.

Chapter 178. db2ckrst - Check incremental restore image sequence

Queries the database history and generates a list of timestamps for the backup images that are required for an incremental restore. A simplified restore syntax for a manual incremental restore is also generated.

Authorization

None

Required connection

None

Command syntax

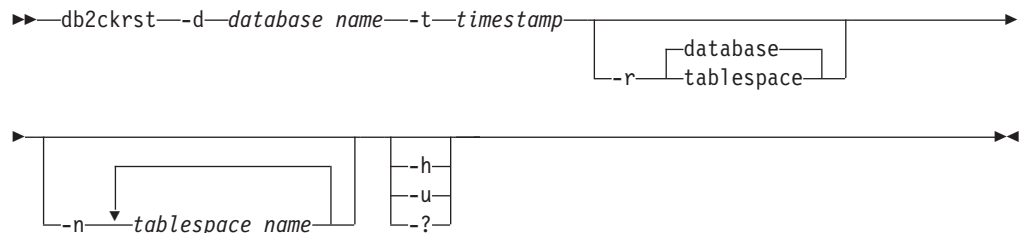

Command parameters

-d *database name*

Specifies the alias name for the database that will be restored.

-t *timestamp*

Specifies the timestamp for a backup image that will be incrementally restored.

-r Specifies the type of restore that will be executed. The default is database. If tablespace is chosen and no table space names are given, the utility looks into the history entry of the specified image and uses the table space names listed to do the restore.

-n *tablespace name*

Specifies the name of one or more table spaces that will be restored. If a database restore type is selected and a list of table space names is specified, the utility will continue as a table space restore using the table space names given.

-h | -u | -?

Displays help information. When this option is specified, all other options are ignored, and only the help information is displayed.

Examples

```
db2ckrst -d mr -t 20001015193455 -r database
db2ckrst -d mr -t 20001015193455 -r tablespace
db2ckrst -d mr -t 20001015193455 -r tablespace -n tbsp1 tbsp2
```

```

> db2 backup db mr

Backup successful. The timestamp for this backup image is : 20001016001426

> db2 backup db mr incremental

Backup successful. The timestamp for this backup image is : 20001016001445

> db2ckrst -d mr -t 20001016001445

Suggested restore order of images using timestamp 20001016001445 for
database mr.
=====
db2 restore db mr incremental taken at 20001016001445
db2 restore db mr incremental taken at 20001016001426
db2 restore db mr incremental taken at 20001016001445
=====

> db2ckrst -d mr -t 20001016001445 -r tablespace -n userspace1
Suggested restore order of images using timestamp 20001016001445 for
database mr.
=====
db2 restore db mr tablespace ( USERSPACE1 ) incremental taken at
20001016001445
db2 restore db mr tablespace ( USERSPACE1 ) incremental taken at
20001016001426
db2 restore db mr tablespace ( USERSPACE1 ) incremental taken at
20001016001445
=====

```

Usage notes

The db2ckrst utility will not be enhanced for the rebuilding of a database. Due to the constraints of the history file, the utility will not be able to supply the correct list if several table spaces need to be restored from more than one image.

The database history must exist in order for this utility to be used. If the database history does not exist, specify the HISTORY FILE option in the RESTORE command before using this utility.

If the FORCE option of the PRUNE HISTORY command is used, you can delete entries that are required for automatic incremental restoration of databases. Manual restores will still work correctly. Use of this command can also prevent the db2ckrst utility from being able to correctly analyze the complete chain of required backup images. The default operation of the PRUNE HISTORY command prevents required entries from being deleted. It is recommended that you do not use the FORCE option of the PRUNE HISTORY command.

This utility should not be used as a replacement for keeping records of your backups.

Chapter 179. db2cli - DB2 interactive CLI

Launches the interactive Call Level Interface environment for design and prototyping in CLI. Located in the `sqllib/samples/cli/` subdirectory of the home directory of the database instance owner. In case of IBM Data Server Driver for ODBC and CLI, the `db2cli` executable will be located in `clidriver/bin` directory.

Authorization

None

Required connection

None

Command syntax

▶▶—db2cli—————▶▶

Command parameters

None

Usage notes

DB2 Interactive CLI consists of a set of commands that can be used to design, prototype, and test CLI function calls. It is a programmers' testing tool provided for the convenience of those who want to use it, and IBM makes no guarantees about its performance. DB2 Interactive CLI is not intended for end users, and so does not have extensive error-checking capabilities.

Two types of commands are supported:

CLI commands

Commands that correspond to (and have the same name as) each of the function calls that is supported by IBM CLI

Support commands

Commands that do not have an equivalent CLI function.

Commands can be issued interactively, or from within a file. Similarly, command output can be displayed on the terminal, or written to a file. A useful feature of the CLI command driver is the ability to capture all commands that are entered during a session, and to write them to a file, thus creating a *command script* that can be rerun at a later time.

Chapter 180. db2cmd - Open DB2 command window

Opens the CLP-enabled DB2 window, and initializes the DB2 command line environment. Issuing this command is equivalent to clicking the *DB2 Command Window* icon.

This command is only available on Windows operating systems.

Authorization

None

Required connection

None

Command syntax

►► db2cmd [option-flag] [command] ◄◄

Command parameters

- c | /c** Execute command following the **-c** option in a new DB2 command window, and then terminate. For example, `db2cmd -c dir` causes the `dir` command to be invoked in a new DB2 command window, and then the DB2 command window closes.
- w | /w** Execute command following the **-w** option in a new DB2 command window, and wait for the new DB2 command window to be closed before terminating the process. For example, `db2cmd /w dir` invokes the `dir` command, and the process does not end until the new DB2 command window closes.
- i | /i** Execute command following the **-i** option while sharing the same DB2 command window and inheriting file handles. For example, `db2cmd -i dir` executes the `dir` command in the same DB2 command window.
- t | /t** Execute command following the **-t** option in a new DB2 CLP window with the specified command as the title of this new window.

Usage notes

If DB21061E ("Command line environment not initialized.") is returned when bringing up the CLP-enabled DB2 window, the operating system may be running out of environment space. Check the `config.sys` file for the SHELL environment setup parameter, and increase its value accordingly. For example:

```
SHELL=C:\COMMAND.COM C:\ /P /E:32768
```

Chapter 181. db2cptsa - Install or update DB2 HA scripts command

This utility installs or updates the DB2 High Availability (HA) scripts in `/usr/sbin/rsct/sapolicies/db2` on UNIX and Linux systems. You need these DB2 HA scripts to use the IBM Tivoli System Automation for Multiplatforms (SA MP) with the DB2 HA feature.

Authorization

This command must be run with root authority

Required connection

None

Command syntax

```
db2cptsa [-c] [-f] [-r] [-h | -?]
```

Command parameters

- c Verifies that the DB2 HA scripts exist in `/usr/sbin/rsct/sapolicies/db2`, and that they are at the proper level.
- f Forces a reinstall of the DB2 HA scripts in `/usr/sbin/rsct/sapolicies/db2`. Without this argument, if the version of the DB2 HA scripts that are already installed is the same as or higher than the version of the scripts being installed, then the installed scripts are not overwritten.
- r Removes the directory `/usr/sbin/rsct/sapolicies/db2`. This directory is where the DB2 HA scripts for SA MP are located. These scripts and this directory will only be removed if SA MP is not installed.
- h | -? Displays help information.

Usage notes

By default, this utility installs the DB2 HA scripts in `/usr/sbin/rsct/sapolicies/db2` if they aren't already installed there, or if the version of the scripts already installed is older than the version of the scripts being installed. This utility installs or updates the DB2 HA scripts if and only if SA MP is already installed.

This command can be found on the DB2 install media in the `db2/plat/tsamp` directory, where *plat* is:

- aix for DB2 for AIX 5L™
- linux for DB2 for Linux on 32-bit AMD and Intel® systems (x86)
- linuxamd64 for DB2 for Linux on AMD64 and Intel EM64T systems (x64)
- linuxppc for DB2 for Linux on POWER® (System i and pSeries®) systems
- linux390 for DB2 for Linux on System z9® and zSeries®

The command is also available at *DB2DIR/install/tsamp* directory where *DB2DIR* is the installation path of the DB2 database product for UNIX and Linux systems.

Chapter 182. db2dart - Database analysis and reporting tool

Examines databases for architectural correctness and reports any encountered errors.

Authorization

sysadm

Required connection

None. db2dart must be run with no users connected to the database.

Command syntax

►►—db2dart—*database-name*—
 └─*action*—
 └─*options*—►►

Command parameters

Inspection actions

- /DB** Inspects the entire database. This is the default option.
- /T** Inspects a single table. Requires two input values: a table space ID, and the table object ID or the table name.
- /TSF** Inspects only table space files and containers.
- /TSC** Inspects a table space's constructs, but not its tables. Requires one input value: table space ID.
- /TS** Inspects a single table space and its tables. Requires one input value: table space ID.
- /ATSC** Inspects constructs of all table spaces, but not their tables.

Data formatting actions

- /DD** Dumps formatted table data. If present, inline LOB data is also shown. Requires five input values: either a table object ID or table name, table space ID, page number to start with, number of pages, and verbose choice.
- /DI** Dumps formatted index data. Requires five input values: either a table object ID or table name, table space ID, page number to start with, number of pages, and verbose choice.
 - For nonpartitioned indexes on partitioned tables, the /DI action uses INDEX_OBJECTID and TBSPACEID from SYSCAT.INDEXES as the first two inputs to the /OI and /TSI options. The table name (/TN) option is not supported for the action.
 - For partitioned indexes on partitioned tables, the /DI action uses PARTITIONOBJECTID and TBSPACEID from SYSCAT.DATAPARTITIONS. The table name (/TN) option is not supported for the action.

/DM Dumps formatted block map data. Requires five input values: either a table object ID or table name, table space ID, page number to start with, number of pages, and verbose choice. The data shows whether a block has been reclaimed for use by the table space following a reorganization to reclaim multidimensional clustering (MDC) table blocks that were empty.

/DP Dumps pages in hex format.

- For permanent object in DMS table space, action /DP requires three input values consisting of table space ID, page number to start with, and number of pages.
- For permanent object in SMS table space, action /DP requires five input values consisting of table space ID, object ID, page number to start with, number of pages, and object type.

/DTSF Dumps formatted table space file information.

/DEMP

Dumps formatted extent map page (EMP) information for a DMS table. Requires two input values: table space ID and the table object ID or table name.

/DDEL

Dumps formatted table data in delimited ASCII format. Requires four input values: either a table object ID or table name, table space ID, page number to start with, and number of pages.

/DHWM

Dumps high water mark information. Requires one input value: table space ID.

/DXA Dumps formatted XML column data in ASCII format. Requires five input values: either a table object ID or table name, table space ID, page number to start with, number of pages, and verbose choice.

/DXH Dumps formatted XML column data in HEX format. Requires five input values: either a table object ID or table name, table space ID, page number to start with, number of pages, and verbose choice.

/LHWM

Suggests ways of lowering the high water mark. Requires two input values: table space ID and number of pages (desired high water mark).

Repair actions

/ETS Extends the table limit in a 4 KB table space (DMS only), if possible. Requires one input value: table space ID.

/MI Marks index as invalid. When specifying this parameter the database must be offline. Requires two input values: table space ID and index object ID. For partitioned indexes, these values can be obtained from INDPARTITIONOBJECTID and INDPARTITIONTBSPACEID for SYSCAT.INDEXPARTITIONS.

/RHWM

Reduces high water mark through empty SMP extents. When specifying this parameter the database must be offline. Requires one input value: table space ID.

Change state actions

/CHST

Change the state of a database. When specifying this parameter the database must be offline. Requires one input value: database backup pending state.

Help

/H Displays help information.

Input value options

/OI *object-id*

Specifies the object ID.

/TN *table-name*

Specifies the table name.

/TSI *tablespace-id*

Specifies the table space ID.

/ROW *sum*

Identifies whether long field descriptors, LOB descriptors, and control information should be checked. You can specify just one option or add the values to specify more than one option.

1 Checks control information in rows.

2 Checks long field and LOB descriptors.

/RPT *path*

Optional path for the report output file.

/RPTN *file-name*

Optional name for the report output file.

/PS *number*

Specifies the page number to start with. The page number must be suffixed with p for pool relative. Specifying **/PS 0 /NP 0** will cause all pages in the specified object to be dumped.

/NP *number*

Specifies the number of pages. Specifying **/PS 0 /NP 0** will cause all pages in the specified object to be dumped.

/V *option*

Specifies whether or not the verbose option should be implemented. Valid values are:

Y Specifies that the verbose option should be implemented.

N Specifies that the verbose option should not be implemented.

/SCR *option*

Specifies type of screen output, if any. Valid values are:

Y Normal screen output is produced.

M Minimized screen output is produced.

N No screen output is produced.

/RPTF *option*

Specifies type of report file output, if any. Valid values are:

Y Normal report file output is produced.

- E Only error information is produced to the report file.
- N No report file output is produced.

/ERR option

Specifies type of log to produce in DART.INF, if any. Valid values are:

- Y Produces normal log in DART.INF file.
- N Minimizes output to log DART.INF file.
- E Minimizes DART.INF file and screen output. Only error information is sent to the report file.

/WHAT DBBP option

Specifies the database backup pending state. Valid values are:

- OFF Off state.
- ON On state.

/QCK option

Quick option. Only applies to /DB, /T, and /TS actions. Only inspects page 0 of the DAT objects and partially inspects the index objects (does not inspect BMP, LOB, LF objects and does not traverse the entirety of the DAT or INX objects).

/TYP option

Specifies the type of object. Valid values are:

- DAT Object type is DAT.
- INX Object type is INDEX.
- BKM Object type is BMP.

Usage notes

1. When invoking the db2dart command, you can specify only one action. An action can support a varying number of options.
2. If you do not specify all the required input values when you invoke the db2dart command, you will be prompted for the values. For the /DDEL action, the options cannot be specified from the command line, and must be entered when prompted by db2dart.
3. The /ROW, /RPT, /RPTN, /SCR, /RPTF, /ERR, and /WHAT DBBP options can all be invoked in addition to the action. They are not required by any of the actions.
4. The /DB, /T and /TS options inspect the specified objects, including associated XML storage objects. The /DB option includes all XML storage objects in the database, the /T option includes XML storage objects associated with the specified table, and the /TS option inspects all XML storage objects whose parent objects exist in the specified table space. As well, the /DEMP option will dump formatted EMP information including that for associated XML storage objects.
5. When db2dart is run against a single table space, all dependent objects for a parent table in that table space are checked, irrespective of the table space in which the dependent objects reside. However, extent map page (EMP) information is not captured for dependent objects that reside outside of the specified table space. EMP information is captured for dependent objects found in the specified table space even when the parent object resides in a table space other than the one specified.

6. For partitioned tables, the `/DD`, `/DM`, `/DEMP`, `/DDEL`, `/DP`, `/DXA`, `/DXH` actions use `partitionobjectid` and `tblspaceid` from `syscat.datapartitions` as the input to the table object ID (`/OI`) and table space ID (`/TSI`) for a specific partition. The table name option (`/TN`) is not supported for these actions. The `/T` action supports the table name or global table object ID when use with global table space ID to check the entire table, and also supports using `partitionobjectid` and `tblspaceid` from `syscat.datapartitions` as the input to `/OI` and `/TSI` to check a specific partition.
7. In general, `db2dart` requests are to be run when the database is offline. However, for the `/DHWM` and `/LHWM` actions, an offline database is not strictly required. The report could be generated without the database being offline, but the reliability of the results will vary depending on how much write/update activity has occurred recently (less activity implies more reliable results).

Chapter 183. db2daslevel - Show DAS level

Shows the current level of the DAS on the system. Output from this command goes to the console by default.

Important: This command has been deprecated and might be removed in a future release because the Control Center and its associated components have been deprecated in Version 9.7. For more information, see the “Control Center tools and DB2 administration server (DAS) have been deprecated” topic in the *What’s New for DB2 Version 9.7* book.

Authorization

None

Required Connection

None

Command Syntax

▶▶—db2daslevel—————▶▶

Command parameters

None

Chapter 184. db2dclgn - Declaration generator

Generates declarations for a specified database table, eliminating the need to look up those declarations in the documentation. The generated declarations can be modified as necessary. The supported host languages are C/C++, COBOL, JAVA, and FORTRAN.

Authorization

None

Required connection

None

Command syntax

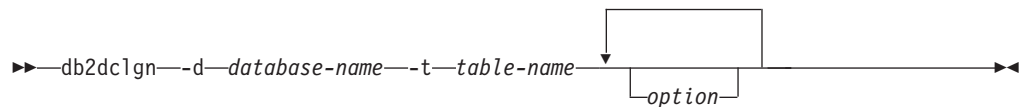

Command parameters

-d *database-name*

Specifies the name of the database to which a connection is to be established.

-t *table-name*

Specifies the name of the table from which column information is to be retrieved to generate declarations.

option One or more of the following:

-a *action*

Specifies whether declarations are to be added or replaced. Valid values are **ADD** and **REPLACE**. The default value is **ADD**.

-b *lob-var-type*

Specifies the type of variable to be generated for a LOB column. Valid values are:

LOB (default)

For example, in C, SQL TYPE is CLOB(5K) x.

LOCATOR

For example, in C, SQL TYPE is CLOB_LOCATOR x.

FILE For example, in C, SQL TYPE is CLOB_FILE x.

-c Specifies whether the column name is to be used as a suffix in the field name when a prefix (-n) is specified. If no prefix is specified, this option is ignored. The default behavior is to not use the column name as a suffix, but instead to use the column number, which starts at 1.

-i Specifies whether indicator variables are to be generated. Since

host structures are supported in C and COBOL, an indicator table of size equal to the number of columns is generated, whereas for JAVA and FORTRAN, individual indicator variables are generated for each column. The names of the indicator table and the variable are the same as the table name and the column name, respectively, prefixed by "IND-" (for COBOL) or "ind_" (for the other languages). The default behavior is to not generate indicator variables.

-l *language*

Specifies the host language in which the declarations are to be generated. Valid values are **C**, **COBOL**, **JAVA**, and **FORTRAN**. The default behavior is to generate C declarations, which are also valid for C++.

-n *name*

Specifies a prefix for each of the field names. A prefix must be specified if the -c option is used. If it is not specified, the column name is used as the field name.

-o *output-file*

Specifies the name of the output file for the declarations. The default behavior is to use the table name as the base file name, with an extension that reflects the generated host language:

- .h for C
- .cbl for COBOL
- .java for JAVA
- .f for FORTRAN (UNIX)
- .for for FORTRAN (INTEL)

-p *password*

Specifies the password to be used to connect to the database. It must be specified if a user ID is specified. The default behavior is to provide no password when establishing a connection.

-r *remarks*

Specifies whether column remarks, if available, are to be used as comments in the declarations, to provide more detailed descriptions of the fields.

-s *structure-name*

Specifies the structure name that is to be generated to group all the fields in the declarations. The default behavior is to use the unqualified table name.

-u *userid*

Specifies the user ID to be used to connect to the database. It must be specified if a password is specified. The default behavior is to provide no user ID when establishing a connection.

-v

Specifies whether the status (for example, the connection status) of the utility is to be displayed. The default behavior is to display only error messages.

-w *DBCS-var-type*

Specifies whether **sqldbchar** or **wchar_t** is to be used for a GRAPHIC/VARGRAPHIC/DBCLOB column in C.

-y *DBCS-symbol*

Specifies whether **G** or **N** is to be used as the DBCS symbol in COBOL.

-z encoding

Specifies the encoding the coding convention in accordance to the particular server. Encoding can be either **LUW** or **OS390**. If **OS390** is specified, the generated file would look identical to a file generated by OS390.

Examples

```
db2dclgn -d sample -t emp_resume -l cobol -a replace
```

Chapter 185. db2diag - db2diag logs analysis tool

This utility is a tool to filter and format both single and rotating db2diag log files. db2diag reads from rotating db2 diag logs if the database manager **DIAGSIZE** configuration parameter is set. Otherwise, by default, it reads from the default db2diag.log file.

Authorization

None

Required connection

None

Command syntax

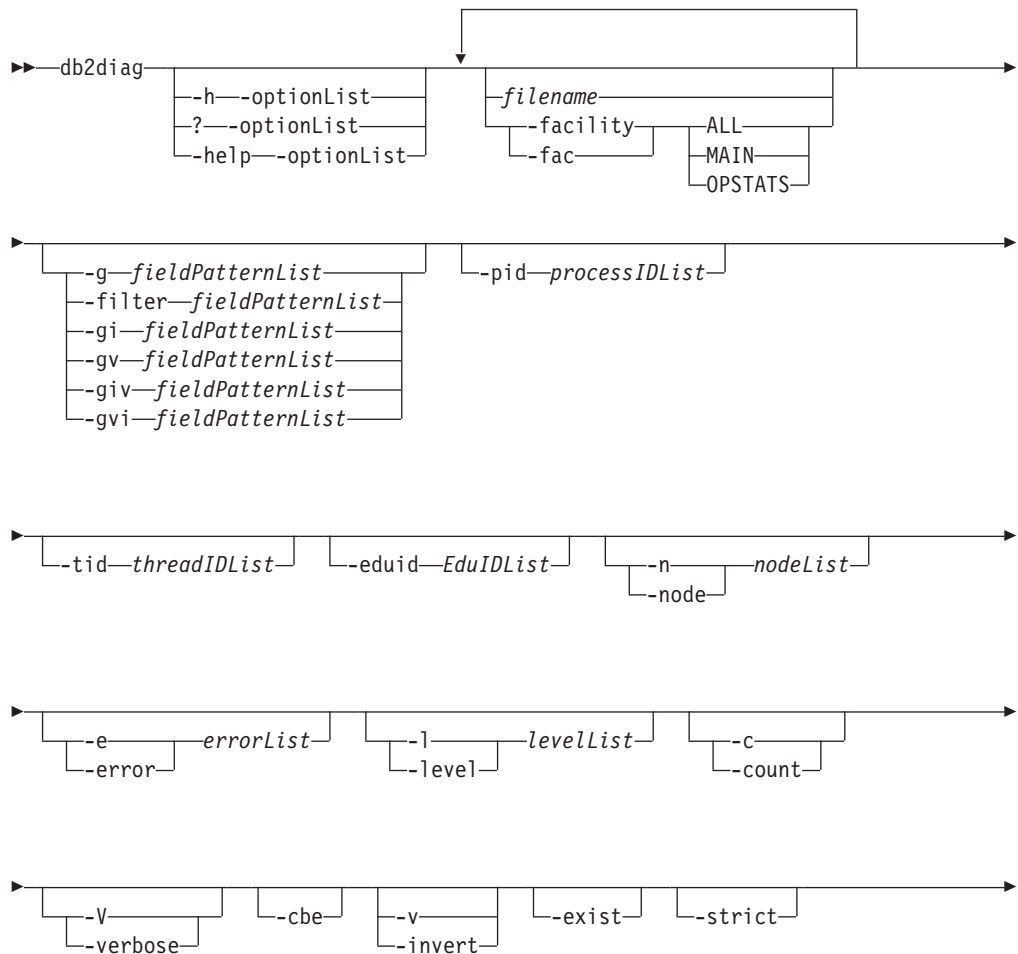

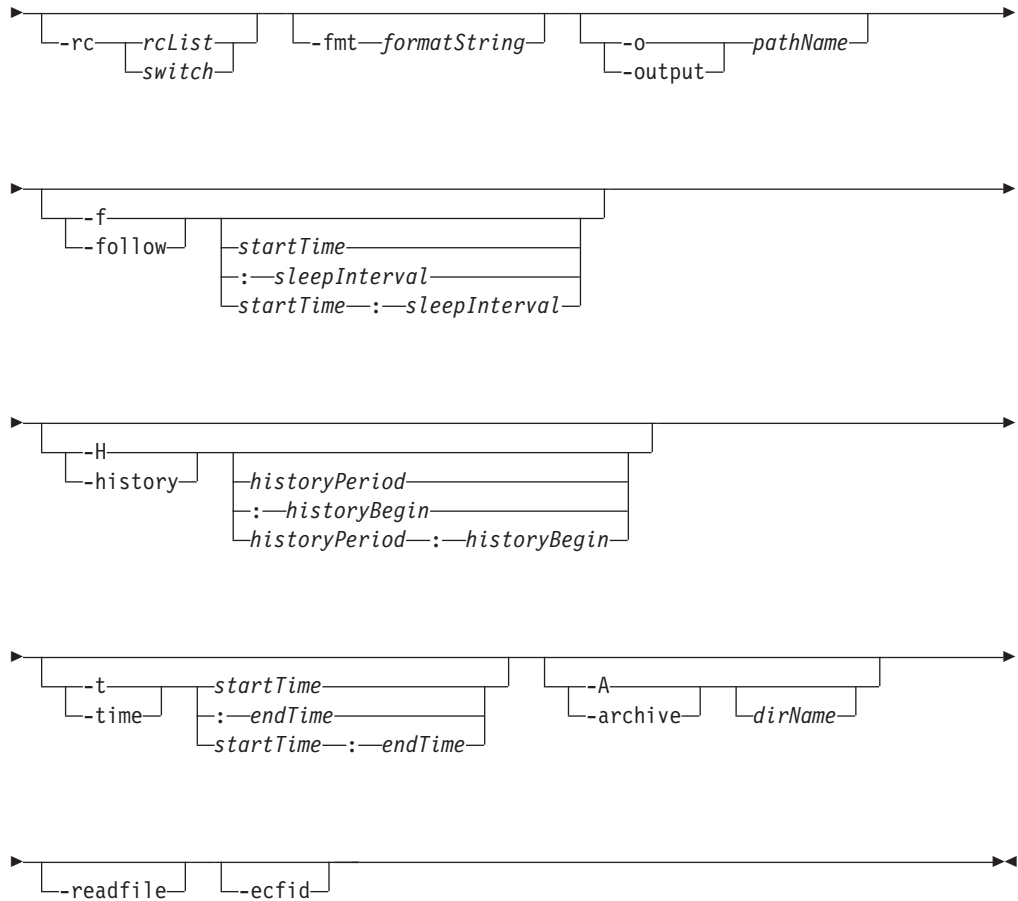

Command parameters

filename

Specifies one or more space-separated path names of DB2 diagnostic logs to be processed. If the file name is omitted, the db2diag log file from the current directory is processed. If the file is not found, a directory set by the **diagpath** configuration parameter is searched.

-facility | -fac

Reads the files from the corresponding facility. A facility is a logical grouping of records. For example, all optimizer statistics records are grouped into the OPTSTATS facility. The output will be in text format by default. Valid facility options are the following:

ALL Returns records from all facilities.

MAIN Returns records from DB2 general diagnostic logs, such as the db2diag log file, and rotating event logs.

OPSTATS

Returns records related to optimizer statistics.

-h | -help | ?

Displays help information. When this option is specified, all other options are ignored, and only the help information is displayed. If a list of options, *optionList*, containing one or more comma separated command parameters is omitted, a list of all available options with short descriptions is

displayed. For each option specified in the *optionList*, more detailed information and usage examples are displayed. Help output can be modified by using one of the following switches in place of the *optionList* argument to display more information about the tool and its usage:

brief Displays help information for all options without examples.

examples

Displays a few typical examples to assist in using the tool.

tutorial

Displays examples that describe advanced features.

notes Displays usage notes and restrictions.

all Displays complete information about all options, including usage examples for each option.

-fmt *formatString*

Formats the db2diag output using a format string, *formatString*, containing record fields in the form %field, %{field}, @field, or @field}. The %{field} and @field} are used to separate a field name from the alphanumeric (or any other allowed character) that may follow the field name. All field names are case-insensitive. Field names can be shortened to the several first characters that are necessary to recognize a field name without ambiguity. In addition, aliases can be used for fields with long names. A prefix before a field name, %, or @, specifies whether a text preceding the field will be displayed (%) or not (@), if the field is empty.

The following fields are currently available:

timestamp | ts

Time stamp. This field can be divided into its constituent fields: %tsyear, %tsmonth, %tsday, %tshour, %tsmin (minute), %tssec (second), %tsmsec (microsecond for UNIX operating systems, millisecond for Windows operating systems).

timezone | tz

Number of minutes difference from UTC (Universal Coordinated Time). For example, -300 is Eastern Time.

recordid | recid

A unique alphanumeric identifier for a record, such as I11455A696.

audience

Intended audience for a logged message. 'E' indicates external users (IBM customers, service analysts, and developers). 'I' indicates internal users (service analysts and developers). 'D' indicates debugging information for developers.

level Severity level of a message: Info, Warning, Error, Severe, or Event.

source Location from which the logged error originated: Origin, OS, Received, or Sent.

instance | inst

Instance name.

node Database partition server number.

database | db

Database name.

pid Process ID.

tid Thread ID.

eduid EDU ID.

eduname
EDU name.

process
Name associated with the process ID, in double quotation marks.
For example, "db2sysc.exe".

product
Product name. For example, DB2 COMMON.

component
Component name.

funcname
Function name.

probe Probe number.

function
Full function description: %prod, %comp, %funcname, probe:%probe.

appid The application ID. This value is the same as the appl_id monitor element data. For detailed information about how to interpret this value, see "appl_id - Application ID monitor element".

coordnode
Coordinator partition.

coordindex
Coordinator index.

apphdl
Application handle: %coordnode - %coordindex.

message | msg
Error message.

calledprod
Product name of the function that returned an error.

calledcomp
Component name of the function that returned an error.

calledfunc
Name of the function that returned an error.

called Full description of the function that returned an error: %calledprod, %calledcomp, %calledfunc.

rcval Return code value (32 bytes).

rcdesc Error description.

retcode | rc
Return code returned by the function called: %rcval %rcdesc.

errno System error number.

errname
System-specific error name.

oserror Operating system error returned by a system call: %errno %errname.

callstack Call stack.

datadesc Data description.

dataobject Data object.

data Full data section of a message: %datadesc %dataobject.

argdesc Argument description.

argobject Argument object.

arg Arguments of a function call that returned an error: %argdesc %argobject.

Event descriptions:

impact User impact (for events only).

startevent Start event description (*).

stopevent Stop event description (*).

changeevent Change event description (*).

init Initialization event description (*).

fini Finish/finalize event description (*).

startup Startup event description (*).

terminate Terminate event description (*).

bringdown Bringdown event description (*).

interrupt Interrupt event description (*).

associate Associate event description (*).

disassociate Disassociate event description (*).

changeconfig Change configuration event description (*).

transfer Transfer event description (*).

dispatch Dispatch event description (*).

switch Switch event description (*).

report Report event description (*).

get Get event description (*).

free Free event description (*).

open Open event description (*).

close Close event description (*).

work Work event description (*).

wait Wait event description (*).

available Available event description (*).

connect Connect event description (*).

disconnect Disconnect event description (*).

accept Accept event description (*).

recv Receive event description (*).

send Send event description (*).

create Create event description (*).

destroy Destroy event description (*).

request Request event description (*).

reply Reply event description (*).

dependency Dependency event description (*).

write Write event description (*).

read Read event description (*).

reset Reset event description (*).

collect Collect event description (*).

add Add event description (*).

alter Alter event description (*).

drop Drop event description (*).

invalidate Invalidate event description (*).

grant Grant event description (*).

revoke Revoke event description (*).

(*) Each event field has the following subfields:

- {event}type**
Event type (START, STOP, READ, WRITE, GET).
- {event}desc**
Event description (header with event information).
- {event}state**
Event state (success, failure, start, stop, in progress, idle) or event progress (in %).
- {event}attr**
Event attributes (business level, cached, sync, async, internal, external, logical, physical, auto, manual, temporary, permanent).
- {event}objid**
Unique object identifier (TABLE, CFG, DBM).
- {event}objname**
Event object name (e.g., "schema.tablename").
- {event}objdata**
Object data (used if object is not a string or simple integer type, e.g., data structure or some complex type).
- {event}qtype**
Event qualifier type (FROM, TO, ON, FOR, AT, BY, CONTEXT).
- {event}qname**
Event qualifier name/value (e.g., FOR "DB ABC").
- {event}qhdr**
Event qualifier data header (contains type, text description and size of data). Used together with the `{event}qdata` field.
- {event}qdata**
Event qualifier data (used if qualifier is not a string or simple integer type, e.g., some data structure or complex type).

In the above, keyword `{event}` should be substituted by event type for a specific event (e.g., start, stop, change, read, write).

To always display the text preceding a field name (for example, for the required fields), the `%` field prefix should be used. To display the text preceding a field name when this field contains some data, the `@` prefix should be used. Any combination of required and optional fields with the corresponding text descriptions is allowed.

The following special characters are recognized within a format string: `\n`, `\r`, `\f`, `\v`, and `\t`.

In contrast to other fields, the data and argument fields can contain several sections. To output a specific section, add the `[n]` after the field name where `n` is a section number ($1 \leq n \leq 64$). For example, to output the first data object and the second data description sections, use `{dataobj}[1]` and `{datadesc}[2]`. When `[n]` is not used, all sections logged are output using pre-formatted logged data exactly as appears in a log message, so

there is no need to add the applicable text description and separating newline before each data field, argument field, or section.

-filter *fieldPatternList* | **-g** *fieldPatternList*

fieldPatternList is a comma-separated list of field-pattern pairs in the following format: *fieldName* *operator* *searchPattern*.

The operator can be one of the following:

= Selects only those records that contain matches that form whole words. (Word search.)

:= Selects those records that contain matches in which a search pattern can be part of a larger expression.

!= Selects only non-matching lines. (Invert word match.)

!:= Selects only non-matching lines in which the search pattern can be part of a larger expression.

^= Selects records for which the field value starts with the search pattern specified.

!^= Selects records for which the field value does not start with the search pattern specified.

The same fields are available as described for the **-fmt** option, except that the **%** and **@** prefixes are not used for this option.

-gi *fieldPatternList*

Same as **-g**, but case-insensitive.

-gv *fieldPatternList*

Searches for messages that do not match the specified pattern.

-gvi | **-giv** *fieldPatternList*

Same as **-gv**, but case-insensitive.

-pid *processIDList*

Displays only log messages with the process IDs listed.

-tid *threadIDList*

Displays only log messages with the thread IDs listed.

-eduid *EduIDList*

Finds all records with a specified EDU ID from a list of EDU IDs containing one or more comma separated numeric values.

-n | **-node** *nodeList*

Displays only log messages with the database partition numbers listed.

-e | **-error** *errorList*

Displays only log messages with the error numbers listed.

-l | **-level** *levelList*

Finds all records with a specified severity level from a list of severity levels containing one or more comma separated text values, namely: Info, Warning, Error, Severe, Critical and Event.

-c | **-count**

Displays the number of records found.

-v | **-invert**

Inverts the pattern matching to select all records that do not match the specified pattern

-strict Displays records using only one *field: value* pair per line. All empty fields are skipped. This can be used for scripts to simplify parsing.

-V | -verbose

Outputs all fields, including empty fields.

-exist Defines how fields in a record are processed when a search is requested. If this option is specified, a field must exist in order to be processed.

-cbe Common Base Event (CBE) Canonical Situation Data.

-o | -output *pathName*

Saves the output to a file specified by a fully qualified *pathName*.

-f | -follow

If the input file is a regular file, specifies that the tool will not terminate after the last record of the input file has been processed. Instead, it sleeps for a specified interval of time (*sleepInterval*), and then attempts to read and process further records from the input file as they become available.

The follow mode will also handle rotating db2diag log files. For example, the command will read the latest rotating diagnostic log file in use (db2diag.23.log) and follow along to the next created rotating log file (db2diag.24.log) when the db2diag.23.log log file meets its size limit.

This option can be used when monitoring records being written to a file by another process. The *startTime* option can be specified to show all the records logged after this time. The *startTime* option is specified using the following format: YYYY-MM-DD-hh.mm.ss.nnnnnn, where

YYYY Specifies a year.

MM Specifies a month of a year (01 through 12).

DD Specifies a day of a month (01 through 31).

hh Specifies an hour of a day (00 through 23).

mm Specifies a minute of an hour (00 through 59).

ss Specifies a second of a minute (00 through 59).

nnnnnn

Specifies microseconds on UNIX operating systems, or milliseconds on Windows operating systems.

Some or all of the fields that follow the year field can be omitted. If they are omitted, the default values will be used. The default values are 1 for the month and day, and 0 for all other fields.

If an exact match for the record time stamp does not exist in the diagnostic log file, the closest time earlier than the specified time stamp will be used.

The *sleepInterval* option specifies a sleep interval in seconds. If a smaller time unit is required, it can be specified as a floating point value. The default value is 2 seconds

-H | -history

Displays the history of logged messages for the specified time interval. This option can be specified with the following options:

historyPeriod

Specifies that logged messages are displayed starting from the most recent logged record, for the duration specified by *historyPeriod*. The *historyPeriod* option is specified using the

following format: Number *timeUnit*, where Number is the number of time units and *timeUnit* indicates the type of time unit: M (month), d (day), h (hour), m (minute), and s (second). The default value for Number is 30, and for *timeUnit* is m.

historyPeriod:historyBegin

Specifies that logged messages are displayed starting from the time specified by *historyBegin*, for the duration specified by *historyPeriod*.

The format is *YYYY-MM-DD-hh.mm.ss.nnnnnn*, where:

YYYY Specifies a year.

MM Specifies a month of a year (01 through 12).

DD Specifies a day of a month (01 through 31).

hh Specifies an hour of a day (00 through 23).

mm Specifies a minute of an hour (00 through 59).

ss Specifies a second of a minute (00 through 59).

nnnnnn

Specifies microseconds (UNIX operating systems) or milliseconds (Windows operating systems).

-t | -time

Specifies a time stamp value. This option can be specified with one or both of the following options:

startTime

Displays all messages logged after *startTime*.

:endTime

Displays all messages logged before *endTime*.

To display messages logged between *startTime* and *endTime*, specify **-t *startTime:endTime***.

The format is *YYYY-MM-DD-hh.mm.ss.nnnnnn*, where:

YYYY Specifies a year.

MM Specifies a month of a year (01 through 12).

DD Specifies a day of a month (01 through 31).

hh Specifies an hour of a day (00 through 23).

mm Specifies a minute of an hour (00 through 59).

ss Specifies a second of a minute (00 through 59).

nnnnnn

Specifies microseconds (UNIX operating systems) or milliseconds (Windows operating systems).

Some or all of the fields that follow the year field can be omitted. If they are omitted, the default values will be used. The default values are 1 for the month and day, and 0 for all other fields.

If an exact match for the record time stamp does not exist in the diagnostic log file, the time closest to the time stamp specified will be used.

-A | -archive *dirName*

Archives both single and rotating diagnostic log files. When this option is specified, all other options are ignored. If one or more file names are specified, each file is processed individually. A timestamp, in the format YYYY-MM-DD-hh.mm.ss, is appended to the file name.

You can specify the name of the file and directory where it is to be archived. If the directory is not specified, the file is archived in the directory where the file is located and the directory name is extracted from the file name.

If you specify a directory but no file name, the current directory is searched for the db2diag log file. If found, the file will be archived in the specified directory. If the file is not found, the directory specified by the **diagpath** configuration parameter is searched for the db2diag log file. If found, it is archived in the directory specified.

If you do not specify a file or a directory, the current directory is searched for the db2diag log file. If found, it is archived in the current directory. If the file is not found, the directory specified by the **diagpath** configuration parameter is searched for the db2diag log file. If found, it is archived in the directory specified by the **diagpath** configuration parameter.

-readfile

Forces reading from a diagnostic log file ignoring any terminal input. This option can be used in scripts to guarantee that db2diag will read from a file and not from a terminal, especially in situations when stdin is disabled or when automated tools are used.

-rc *rcList* | *switch*

Displays descriptions of DB2 internal error return codes for a space separated list, rcList, of the particular ZRC or ECF hexadecimal or negative decimal return codes. A full list of ZRC or ECF return codes can be displayed by specifying one of the following switches:

zrc Displays short descriptions of DB2 ZRC return codes.

ecf Displays short descriptions of DB2 ECF return codes.

html Displays short descriptions of DB2 ZRC return codes in the HTML format.

When this option is specified, all other options are ignored and output is directed to a display.

-ecfid *ecfId*

Displays function information extracted from the numeric ecfId. When this option is specified, all other options are ignored.

Examples

To display all critical error messages, enter:

```
db2diag -level critical
```

or

```
db2diag -g 'level=Critical'
```

To display all severe error messages produced by the process with the process ID (PID) 52356 and on node 1, 2 or 3, enter:

```
db2diag -g level=Severe,pid=952356 -n 1,2,3
```

To display all messages containing database SAMPLE and instance aabrashk, enter:

```
db2diag -g db=SAMPLE,instance=aabrashk
```

To display all severe error messages containing the database field, enter:

```
db2diag -g db:= -gi level=severe
```

To display all error messages containing the DB2 ZRC return code 0x87040055, and the application ID G916625D.NA8C.068149162729, enter:

```
db2diag -g msg:=0x87040055 -l Error | db2diag -gi appid^=G916625D.NA
```

To display all messages not containing the LOADID data, enter:

```
db2diag -gv data!=LOADID
```

To display only logged records not containing the LOCAL pattern in the application ID field, enter:

```
db2diag -gi appid!=local or db2diag -g appid!=LOCAL
```

All records that don't match will be displayed. To output only messages that have the application ID field, enter:

```
db2diag -gvi appid:=local -exist
```

To display all messages logged after the one with timestamp 2003-03-03-12.16.26.230520 inclusively, enter:

```
db2diag -time 2003-03-03-12.16.26.230520
```

To display severe errors logged for the last three days, enter:

```
db2diag -gi "level=severe" -H 3d
```

To display all log messages not matching the pdLog pattern for the funcname field, enter:

```
db2diag -g 'funcname!=pdLog' or db2diag -gv 'funcn=pdLog'
```

To display all severe error messages containing component name starting from the "base sys, enter:

```
db2diag -l severe | db2diag -g "comp^=base sys"
```

To view the growth of the db2diag.log file, enter: `db2diag -f db2diag.log` This displays all records written to the db2diag.log file in the current directory. Records are displayed as they are added to the file. The display continues until you press Ctrl-C.

To write the context of the db2diag.log into the db2diag_123.log file located in the /home/user/Logs directory, enter:

```
db2diag -o /home/user/Logs/db2diag_123.log
```

To call db2diag from a Perl script using default settings, enter:

```
system("db2diag -readfile");
```

This will force db2diag to process db2diag.log/db2diag*.log files (Rotating logs if the database manager **DIAGSIZE** configuration parameter is set) from a directory specified by the **DIAGPATH** configuration parameter

To read the db2diag.log1 file from a specified directory ignoring any terminal input, enter:

```
system("db2diag -readfile /u/usr/sql1lib/db2dump/db2diag.log1");
```

To display function information corresponding to ecfid = 0x1C30000E, enter:

```
db2diag -ecfid 0x1C30000E
```

which is equivalent to,

```
db2diag -ecfid 472907790
```

This will display function name, component and product name.

To display only logged records containing eduid = 123, enter:

```
db2diag -eduid 123
```

To display all records containing eduid = 123 or eduid = 5678, enter:

```
db2diag -eduid "123,5678"
```

To display all severe error messages produced by a thread with eduid = 15, enter:

```
db2diag -g "level=Severe, eduid=15"
```

or, which is equivalent,

```
db2diag -g level=Severe | db2diag -eduid 15
```

Usage notes

- Each option can appear only once. They can be specified in any order and can have optional parameters. Short options can not be included together. For example, use `-l -e` and not `-le`.
- By default, db2diag looks for the db2diag log file in the current directory. If the file is not found, the directory set by the **diagpath** configuration parameter is searched next. If the db2diag log file is not found, db2diag returns an error and exits.
- Filtering and formatting options can be combined on a single command line to perform complex searches using pipes. The formatting options `-fmt`, `-strict`, `-cbe`, and `-verbose` should be used only after all filtering is done to ensure that only original logged messages with standard fields will be filtered, not those fields either defined or omitted by the user. It is not necessary to use `-` when using pipes.
- When pipes are used and one or more files names are specified on the command line, the db2diag input is processed differently depending on whether the `-` has been specified or not. If the `-` is omitted, input is taken from the specified files. In contrast, when the `-` option is specified, file names (even if present on the command line) are ignored and input from a terminal is used. When a pipe is used and a file name is not specified, the db2diag input is processed exactly the same way with or without the `-` specified on the command line.
- The `-exist` option overrides the default db2diag behavior for invert match searches when all records that do not match a pattern are output independent of whether they contain the proper fields or not. When the `-exist` option is specified, only the records containing fields requested are processed and output.
- If the `-fmt` (format) option is not specified, all messages (filtered or not) are output exactly as they are written in the diagnostic log file. Output record format can be changed by using the `-strict`, `-cbe`, and `-verbose` options.
- The `-fmt` option overrides the `-strict`, `-cbe` and `-verbose` options.
- Some restrictions apply when the `-cbe` option is specified and the db2diag log file has been transferred over a network from the original computer. The

db2diag tool collects information about DB2 and the computer host name locally, meaning that the DB2 version and the source or reporter componentID location field for the local system can be different from the corresponding values that were used on the original computer.

- It is recommended to specify the `-readfile` option when using db2diag in scripts. It will ensure reading from a file ignoring any terminal input.
- Ordinarily, the exit status is 0 if matches were found, and 1 if no matches were found. The exit status is 2 if there are syntax errors in the input data and patterns, the input files are inaccessible, or other errors are found.
- Severe errors resulting from DB2 Text Search can be found logged in the db2diag log file.
- Be aware that using this tool to read and filter rotating DB2DIAG log files (when the **diagsize** database configuration parameter is nonzero) will result in all the rotating diagnostic log files, to a series maximum of 10 files, to be read and filtered.

Chapter 186. db2drdat - DRDA trace

Allows the user to capture the DRDA data stream exchanged between a DRDA Application Requestor (AR) and the DB2 DRDA Application Server (AS). Although this tool is most often used for problem determination, by determining how many sends and receives are required to execute an application, it can also be used for performance tuning in a client/server environment.

Authorization

None

Command syntax

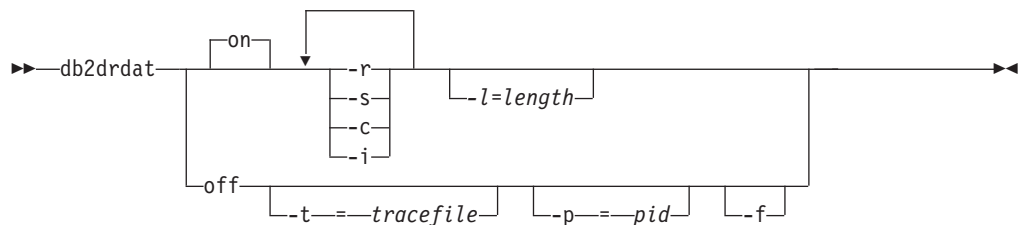

Command parameters

- on** Turns on AS trace events (all if none specified).
- off** Turns off AS trace events.
- r** Traces DRDA requests received from the DRDA AR.
- s** Traces DRDA replies sent to the DRDA AR.
- c** Traces the SQLCA received from the DRDA server on the host system. This is a formatted, easy-to-read version of *not null* SQLCAs.
- i** Includes time stamps in the trace information.
- l** Specifies the size of the buffer used to store the trace information.
- p** Traces events only for this process. If **-p** is not specified, all agents with incoming DRDA connections on the server are traced. The *pid* to be traced can be found in the *agent* field returned by the LIST APPLICATIONS command.
- t** Specifies the destination for the trace. If a file name is specified without a complete path, missing information is taken from the current path. If *tracefile* is not specified, messages are directed to *db2drdat.dmp* in the current directory.
- f** Formats communications buffers.

Usage notes

Do not issue *db2trc* commands while *db2drdat* is active.

db2drdat writes the following information to *tracefile*:

1. -r
 - Type of DRDA request
 - Receive buffer
2. -s
 - Type of DRDA reply/object
 - Send buffer

The command returns an exit code. A zero value indicates that the command completed successfully, and a nonzero value indicates that the command was not successful. If db2drdat sends the output to a file that already exists, the old file will be erased unless the permissions on the file do not allow it to be erased, in which case the operating system will return an error.

Chapter 187. db2drvmp - DB2 database drive map

Maps a database drive for Microsoft Cluster Server (MSCS). This command is available only on Windows platforms.

Authorization

Read/write access to the Windows registry and the cluster registry.

Required connection

Instance. The application creates a default instance attachment if one is not present.

Command syntax

```
db2drvmp {add | drop | query | reconcile} dbpartition_number from_drive to_drive
```

Command parameters

add Assigns a new database drive map.

drop Removes an existing database drive map.

query Queries a database map.

reconcile

Reapplies the database drive mapping to the registry when the registry contents are damaged or dropped accidentally.

dbpartition_number

The database partition number. This parameter is required for add and drop operations. If this parameter is not specified for a reconcile operation, db2drvmp reconciles the mapping for all database partitions.

from_drive

The drive letter from which to map. This parameter is required for add and drop operations. If this parameter is not specified for a reconcile operation, db2drvmp reconciles the mapping for all drives.

to_drive

The drive letter to which to map. This parameter is required for add operations. It is not applicable to other operations.

Examples

To set up database drive mapping from F: to E: for NODE0, issue the following command:

```
db2drvmp add 0 F E
```

To set up database drive mapping from E: to F: for NODE1, issue the following command:

```
db2drvmp add 1 E F
```

Usage notes

1. Database drive mapping does not apply to table spaces, containers, or any other database storage objects.
2. Any setup of or change to the database drive mapping does not take effect immediately. To activate the database drive mapping, use the Microsoft Cluster Administrator tool to bring the DB2 resource offline, then online.
3. Using the TARGET_DRVMAP_DISK keyword in the DB2MSCS.CFG file will enable drive mapping to be done automatically.

Chapter 188. db2empfa - Enable multipage file allocation

Enables the use of multipage file allocation for a database. With multipage file allocation enabled for SMS table spaces, disk space is allocated one extent at a time rather than one page at a time.

Scope

This command only affects the database partition on which it is executed.

Authorization

sysadm

Required connection

None. This command establishes a database connection.

Command syntax

▶▶—db2empfa—*database-alias*—————▶▶

Command parameters

database-alias

Specifies the alias of the database for which multipage file allocation is to be enabled.

Usage notes

This utility:

- Connects to the database partition (where applicable) in exclusive mode
- In all SMS table spaces, allocates empty pages to fill up the last extent in all data and index files which are larger than one extent
- Changes the value of the database configuration parameter **multipage_alloc** to YES
- Disconnects.

Since db2empfa connects to the database partition in exclusive mode, it cannot be run concurrently on the catalog database partition, or on any other database partition.

Chapter 189. db2envar.bat - Set environment of the current command window

Sets the environment of your current command window for the DB2 copy that db2envar.bat is executed from. This is useful if you want to switch between different DB2 copies from the command line. This command is only available on Windows operating systems.

Authorization

None

Required Connection

None

Command Syntax

▶▶—db2envar.bat—▶▶

Command parameters

None

Usage notes

When there are multiple DB2 copies on a machine, the full path should be used to indicate which db2envar.bat is to be executed. For example, if you want to set up the environment for the DB2 copy that is installed under e:\sql11ib, you should issue:e:\sql11ib\bin\db2envar.bat.

Chapter 190. db2eva - Event analyzer

Starts the event analyzer, allowing the user to trace performance data produced by DB2 event monitors that have their data directed to tables.

Important: This command has been deprecated and might be removed in a future release because the Control Center and its associated components have been deprecated in Version 9.7. For more information, see the “Control Center tools and DB2 administration server (DAS) have been deprecated” topic in the *What’s New for DB2 Version 9.7* book.

Authorization

All of the following privileges and authorizations are required:

- CONNECT authority (or an authority that implicitly includes CONNECT authority)
- SELECT privilege on the following catalog tables (or an authority that implicitly includes SELECT privilege on the catalog tables):
 - SYSIBM.EVENTMONITORS
 - SYSIBM.EVENTS
 - SYSIBM.EVENTTABLE

Required connection

Database connection

Command syntax

```
▶▶ db2eva [ -db database-alias ] [ -evm evmon-name ] ▶▶
```

Command parameters

The db2eva parameters are optional. If you do not specify parameters, the Open Event Analyzer dialog box appears to prompt you for the database and event monitor name.

-db *database-alias*

Specifies the name of the database defined for the event monitor.

-evm *evmon-name*

Specifies the name of the event monitor whose traces are to be analyzed.

Usage notes

Without the required access, the user cannot retrieve any event monitor data.

There are two methods for retrieving event monitor traces:

1. The user can enter db2eva from the command line and the Open Event Analyzer Dialog box opens to let the user choose the database and event monitor names from the drop-down lists before clicking OK to open the Event Analyzer dialog box.

2. The user can specify the `-db` and `-evm` parameters from the command line and the Event Analyzer dialog opens on the specified database.

The Event Analyzer connects to the database, and issues a select target from `SYSIBM.SYSEVENTTABLES` to get the event monitor tables. The connection is then released after the required data has been retrieved.

The event analyzer can be used to analyze the data produced by an active event monitor. However, event monitor captured after the event analyzer has been invoked might not be shown. Turn off the event monitor before invoking the Event Analyzer to ensure data are properly displayed.

Chapter 191. db2evmon - Event monitor productivity tool

Formats event monitor file and named pipe output, and writes it to standard output.

Authorization

None, unless connecting to the database (-db -evm) in which case, all of the following authorization is required:

- CONNECT authority (or an authority that implicitly includes CONNECT)
- SELECT privilege on the following catalog tables (or an authority that implicitly includes SELECT on the catalog tables):
 - SYSIBM.SYSTABLES
 - SYSIBM.SYSEVENTMONITORS

If the event monitor is db2detaildeadlock, then one of the following authorities or privilege is additionally required:

- *sysmon*
- *sysmaint*
- *sysctrl*
- *sysadm*
- EXECUTE privilege on the SNAPSHOT_DATABASE table function.
- *dataaccess*

Required connection

None

Command syntax

```
db2evmon --db database-alias --evm event-monitor-name --path event-monitor-target
```

Command parameters

-db *database-alias*

Specifies the database whose data is to be displayed. This parameter is case sensitive.

-evm *event-monitor-name*

The one-part name of the event monitor. An ordinary or delimited SQL identifier. This parameter is case sensitive.

-path *event-monitor-target*

Specifies the directory containing the event monitor trace files.

Usage notes

db2evmon generates the same output regardless of whether the command is issued while connecting to the database or specifying the path option.

- If the instance is not already started when db2evmon is issued with the -db and -evm options, the command will start the instance.
- If the instance is not already started when db2evmon is issued with the -path option, the command will not start the instance. The instance needs to be started explicitly.

If the data is being written to files, the tool formats the files for display using standard output. In this case, the monitor is turned on first, and any event data in the files is displayed by the tool. To view any data written to files after the tool has been run, reissue db2evmon.

If the data is being written to a pipe, the tool formats the output for display using standard output as events occur. In this case, the tool is started *before* the monitor is turned on.

Chapter 192. db2evtbl - Generate event monitor target table definitions

Generates sample CREATE EVENT MONITOR SQL statements that can be used when defining event monitors that write to SQL tables.

Authorization

None

Required connection

None

Command syntax

```
db2evtbl [-schema schema-name] [-partitioned]
         --evm event-monitor-name event type
```

Command parameters

-schema *schema-name*

Schema name. If not specified, the table names are unqualified.

-partitioned

If specified, elements that are only applicable for a partitioned database environment are also generated.

-evm *event-monitor-name*

The name of the event monitor.

event type

Any of the event types available on the CREATE EVENT MONITOR statement, for example, DATABASE, TABLES, UNIT OF WORK.

Examples

```
db2evtbl -schema smith -evm foo database, tables, tablespaces, bufferpools
```

Usage notes

Output is written to standard output.

Defining WRITE TO TABLE event monitors is more straightforward when using the db2evtbl tool. For example, the following steps can be followed to define and activate an event monitor.

1. Use db2evtbl to generate the CREATE EVENT MONITOR statement.
2. Edit the SQL statement, removing any unwanted columns.

3. Use the CLP to process the SQL statement. (When the CREATE EVENT MONITOR statement is executing, target tables are created.)
4. Issue SET EVENT MONITOR STATE to activate the new event monitor.

Since all events other than deadlock event monitors can be flushed, creating more than one record per event, users who do not use the FLUSH EVENT MONITOR statement can leave the element `evmon_flushes` out of any target tables.

Chapter 193. db2exfmt - Explain table format

You use the db2exfmt tool to format the contents of the EXPLAIN tables. This tool is located in the misc subdirectory of the instance sqllib directory. This tool uses the statistics from the EXPLAIN snapshot, if the snapshot is available.

Authorization

To use the tool, you require read access to the explain tables being formatted.

Command syntax

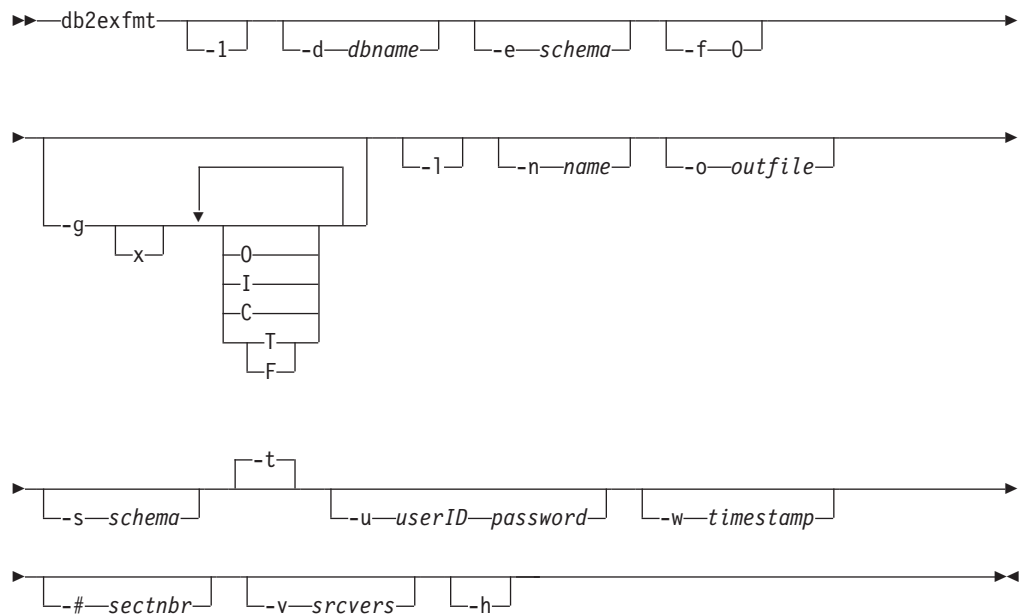

Command parameters

db2exfmt

If no options are specified, then the command enters interactive mode and you will be prompted to make entries.

-l Use defaults -e % -n % -s % -v % -w -l -# 0

If Explain schema is not supplied, the contents of the environment variable \$USER, or \$USERNAME will be used as a default. If this variable is not found, the user will be prompted for an Explain schema.

-d *dbname*

Name of the database containing packages.

-e *schema*

Explain table SQL schema.

-f Formatting flags. In this release, the only supported value is O (operator summary).

-g Graph plan.

x Turn OFF options (default is to turn them ON).

If only -g is specified, a graph, followed by formatted information for all of the tables, is generated. Otherwise, any combination of the following valid values can be specified:

- O Generate a graph only. Do not format the table contents.
- T Include total cost under each operator in the graph.
- F Include first tuple cost in graph.
- I Include I/O cost under each operator in the graph.
- C Include the expected output cardinality (number of tuples) of each operator in the graph.

Any combination of these options is allowed, except F and T, which are mutually exclusive.

- l Respect case when processing package names.
- n *name*
Name of the source of the explain request (SOURCE_NAME).
- s *schema*
SQL schema or qualifier of the source of the explain request (SOURCE_SCHEMA).
- o *outfile*
Output file name.
- t Direct the output to the terminal.
- u *userID password*
When connecting to a database, use the provided user ID and password.
Both the user ID and password must be valid according to naming conventions and be recognized by the database.
- w *timestamp*
Explain time stamp. Specify -1 to obtain the latest explain request.
- # *sectnbr*
Section number in the source. To request all sections, specify zero.
- v *srcvers*
Source version of source of Explain request (default %)
- h Display help information. When this option is specified, all other options are ignored, and only the help information is displayed.

Usage notes

You will be prompted for any parameter values that are not supplied, or that are incompletely specified, except in the case of the -h and the -l options.

If an explain table SQL schema is not provided, the value of the environment variable USER is used as the default. If this variable is not found, the user is prompted for an explain table SQL schema.

Source name, source SQL schema, and explain time stamp can be supplied in LIKE predicate form, which allows the percent sign (%) and the underscore (_) to be

used as pattern matching characters to select multiple sources with one invocation. For the latest explained statement, the explain time can be specified as -1.

If -o is specified without a file name, and -t is not specified, the user is prompted for a file name (the default name is db2exfmt.out). If neither -o nor -t is specified, the user is prompted for a file name (the default option is terminal output). If -o and -t are both specified, the output is directed to the terminal.

The db2exfmt command displays the statistics from the EXPLAIN snapshot, if the snapshot is available. Otherwise, db2exfmt displays statistics stored in the EXPLAIN_OBJECT table and also displays some statistics retrieved directly from the system catalog.

The following are EXPLAIN snapshot examples.

```
db2 explain plan with snapshot for query
db2exfmt
```

or,

```
db2 set current explain mode yes
db2 set current explain snapshot yes
run the query
db2exfmt
```

Chapter 194. db2exmig - Migrate explain tables

Migrates explain tables. The explain tables belonging to the user ID that is issuing the db2exmig command, or that is used to connect to the database, are migrated. The explain tables migration tool renames the existing explain tables, creates a new set of tables using the EXPLAIN.DDL, and copies the contents of the existing explain tables to the new tables. Finally, it drops the existing explain tables. The db2exmig command will preserve any user added columns on the explain tables.

Authorization

If the db2exmig application package is bound then the required authorization is one of the following authorities:

- *dbadm* authority
- EXECUTE authority on the db2exmig application package and SELECT privilege or CONTROL privilege on the following system catalogs:
 - SYSCAT.COLUMNS
 - SYSCAT.TABLES
 - SYSCAT.REFERENCES

If the db2exmig application package is not bound then the required authorization is *dbadm* authority.

Required Connection

None

Command Syntax

```
►► db2exmig -d dbname -e explain_schema -u userID -password password ◀◀
```

Command parameters

- d *dbname*
Specifies the database name.
- e *explain_schema*
Specifies the schema name of the explain tables to be migrated.
- u *userID password*
Specifies the current user's ID and password.

Usage notes

You can determine the db2exmig application package name by using the command: db2bfd -b db2exmig.bnd. The db2exmig.bnd files are located in the sqllib/bnd folder.

Chapter 195. db2expln - SQL and XQuery Explain

The db2expln tool describes the access plan selected for SQL and XQuery statements. It can be used to obtain a quick explanation of the chosen access plan when explain data was not captured. For static SQL and XQuery statements, db2expln examines the packages stored in the system catalog tables. For dynamic SQL and XQuery statements, db2expln examines the sections in the query cache.

Authorization

dbadm or one of the following authorizations or privileges:

- For static statements, SELECT privilege on the catalog tables
- For dynamic statements, SELECT privilege on the catalog tables plus one of the following authorizations or privileges:
 - Sufficient privileges to compile the statement
 - EXPLAIN authority
 - SQLADM authority

Command syntax

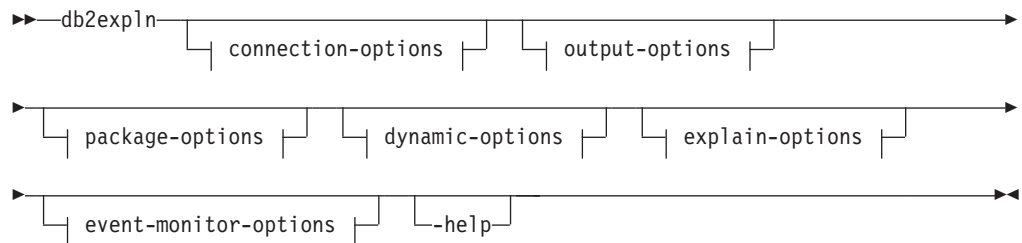

connection-options:

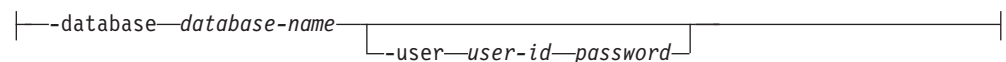

output-options:

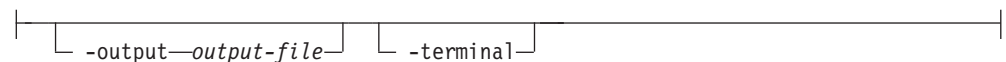

package-options:

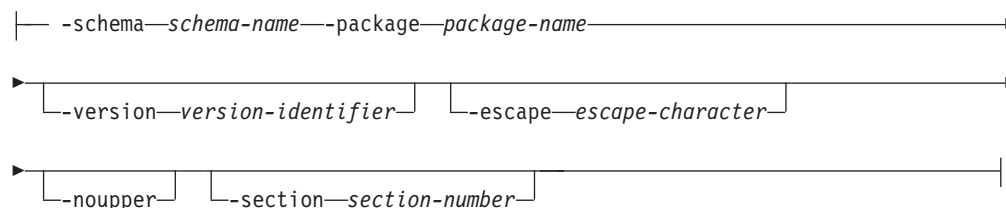

dynamic-options:

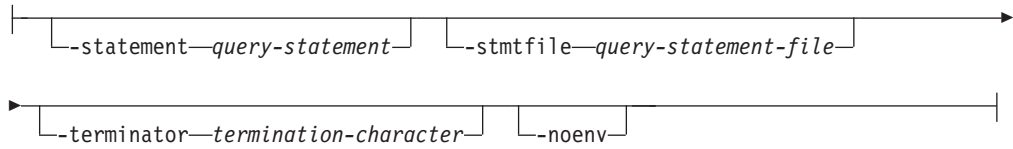

explain-options:

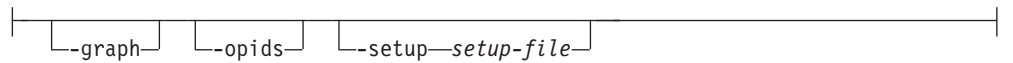

event-monitor-options:

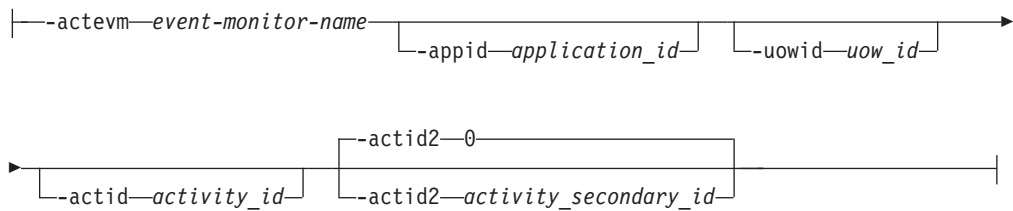

Command parameters

The options can be specified in any order.

connection-options:

These options specify the database to connect to and any options necessary to make the connection. The connection options are required except when the `-help` option is specified.

-database *database-name*

The name of the database that contains the packages to be explained.

For backward compatibility, you can use `-d` instead of `-database`.

-user *user-id password*

The authorization ID and password to use when establishing the database connection. Both *user-id* and *password* must be valid according to DB2 naming conventions and must be recognized by the database.

For backward compatibility, you can use `-u` instead of `-user`.

output-options:

These options specify where the `db2expln` output should be directed. Except when the `-help` option is specified, you must specify at least one output option. If you specify both options, output is sent to a file as well as to the terminal.

-output *output-file*

The output of `db2expln` is written to the file that you specify.

For backward compatibility, you can use `-o` instead of `-output`.

-terminal

The `db2expln` output is directed to the terminal.

For backward compatibility, you can use `-t` instead of `-terminal`.

package-options:

These options specify one or more packages and sections to be explained. Only static queries in the packages and sections are explained.

As in a LIKE predicate, you can use the pattern matching characters, which are percent sign (%) and underscore (_), to specify the *schema-name*, *package-name*, and *version-identifier*.

-schema *schema-name*

The SQL schema of the package or packages to be explained.

For backward compatibility, you can use `-c` instead of `-schema`.

-package *package-name*

The name of the package or packages to be explained.

For backward compatibility, you can use `-p` instead of `-package`.

-version *version-identifier*

The version identifier of the package or packages to be explained. The default version is the empty string.

-escape *escape-character*

The character, *escape-character* to be used as the escape character for pattern matching in the *schema-name*, *package-name*, and *version-identifier*.

For example, the `db2expln` command to explain the package `TESTID.CALC%` is as follows:

```
db2expln -schema TESTID -package CALC% ....
```

However, this command would also explain any other plans that start with `CALC`. To explain only the `TESTID.CALC%` package, you must use an escape character. If you specify the exclamation point (!) as the escape character, you can change the command to read: `db2expln -schema TESTID -escape ! -package CALC!% ...`. Then the ! character is used as an escape character and thus `!%` is interpreted as the % character and not as the "match anything" pattern. There is no default escape character.

For backward compatibility, you can use `-e` instead of `-escape`.

To avoid problems, do not specify the operating system escape character as the `db2expln` escape character.

-noupper

Specifies that the *schema-name*, *package-name*, and *version-identifier*, should not be converted to uppercase before searching for matching packages.

By default, these variables are converted to uppercase before searching for packages. This option indicates that these values should be used exactly as typed.

For backward compatibility, you can use `-l`, which is a lowercase L and not the number 1, instead of `-noupper`.

-section *section-number*

The section number to explain within the selected package or packages.

To explain all the sections in each package, use the number zero (0). This is the default behavior. If you do not specify this option, or if *schema-name*, *package-name*, or *version-identifier* contain a pattern-matching character, all sections are displayed.

To find section numbers, query the system catalog view SYSCAT.STATEMENTS. Refer to the *SQL Reference* for a description of the system catalog views.

For backward compatibility, you can use -s instead of -section.

dynamic-options:

These options specify one or more dynamic query statements to be explained.

-statement *query-statement*

An SQL or XQuery query statement to be dynamically prepared and explained. To explain more than one statement, either use the -stmtfile option to provide a file containing the query statements to explain, or use the -terminator option to define a termination character that can be used to separate statements in the -statement option.

-stmtfile *query-statement-file*

A file that contains one or more query statements to be dynamically prepared and explained. By default, each line of the file is assumed to be a distinct query statement. If statements must span lines, use the -terminator option to specify the character that marks the end of an query statement.

-terminator *termination-character*

The character that indicates the end of dynamic query statements. By default, the -statement option provides a single query statement and each line of the file in the -stmtfile is treated as a separate query statement. The termination character that you specify can be used to provide multiple query statements with -statement or to have statements span lines in the -stmtfile file.

-noenv

Specifies that dynamic statements that alter the compilation environment should not be executed after they have been explained.

By default, db2expln will execute any of the following statements after they have been explained:

```
SET CURRENT DEFAULT TRANSFORM GROUP
SET CURRENT DEGREE
SET CURRENT MAINTAINED TABLE TYPES FOR OPTIMIZATION
SET CURRENT QUERY OPTIMIZATION
SET CURRENT REFRESH AGE
SET PATH
SET SCHEMA
```

These statements make it possible to alter the plan chosen for subsequent dynamic query statements processed by db2expln.

If you specify -noenv, then these statement are explained, but not executed.

It is necessary to specify either -statement or -stmtfile to explain dynamic query. Both options can be specified in a single invocation of db2expln.

explain-options:

These options determine what additional information is provided in the explained plans.

-graph Show optimizer plan graphs. Each section is examined, and the original optimizer plan graph is constructed as presented by Visual Explain.

The generated graph may not match the Visual Explain graph exactly. It is possible for the optimizer graph to show some gaps, based on the information contained within the section plan.

For backward compatibility, you can specify `-g` instead of `-graph`.

-opids Display operator ID numbers in the explained plan.

The operator ID numbers allow the output from `db2expln` to be matched to the output from the `explain` facility. Not all operators have an ID number and that some ID numbers that appear in the `explain` facility output do not appear in the `db2expln` output.

For backward compatibility, you can specify `-i` instead of `-opids`.

-help Shows the help text for `db2expln`. If this option is specified no packages are explained.

Most of the command line is processed in the `db2exsrv` stored procedure. To get help on all the available options, it is necessary to provide **connection-options** along with `-help`. For example, use:

```
db2expln -help -database SAMPLE
```

For backward compatibility, you can specify `-h` or `-?`.

-setup *setup-file*

A file that contains one or more statements needed to setup the environment for dynamic statements or for static statements that need to be recompiled (such as a static statement that references a declared temporary table). Each statement in the file will be executed and any errors or warnings will be reported. The statements in the file are not explained.

event-monitor-options:

These options specify one or more section environments from an activities event monitor to be explained.

-actevm *event-monitor-name*

Specifies the name of the activities event monitor whose `activitystmt` logical grouping contains the section environments (in the **section_env** monitor element) to be explained.

-appid *application-id*

Specifies the application identifier (**appl_id** monitor element) uniquely identifying the application that issued the activities whose section environments are to be explained. `-actevm` must be specified if `-appid` is specified.

-uowid *uow-id*

Specifies the unit of work ID (**uow_id** monitor element) whose section environments are to be explained. The unit of work ID is unique only within a given application. `-actevm` must be specified if `-uowid` is specified.

-actid *activity-id*

Specifies the activity ID (**activity_id** monitor element) whose

section environments are to be explained. The activity ID is only unique within a given unit of work. -actevm must be specified if -actid is specified.

-actid2 *activity-secondary-id*

Specifies the activity secondary ID (**activity_secondary_id** monitor element) whose section environments are to be explained. This defaults to zero if not specified. -actevm must be specified if -actid2 is specified.

Usage notes

Unless you specify the -help option, you must specify either package-options or dynamic-options. You can explain both packages and dynamic SQL with a single invocation of db2expln.

Some of the option flags above might have special meaning to your operating system and, as a result, might not be interpreted correctly in the db2expln command line. However, you might be able to enter these characters by preceding them with an operating system escape character. For more information, see your operating system documentation. Make sure that you do not inadvertently specify the operating system escape character as the db2expln escape character.

Help and initial status messages, produced by db2expln, are written to standard output. All prompts and other status messages produced by the explain tool are written to standard error. Explain text is written to standard output or to a file depending on the output option chosen.

The following messages can be returned by db2expln:

- No packages found for database package pattern: "<creator>".<package> with version "<version>"

This message will appear in the output if no packages were found in the database that matched the specified pattern.

- Bind messages can be found in db2expln.msg

This message will appear in the output if the bind of db2expln.bnd was not successful. Further information on the problems encountered will be found in the db2expln.msg file in the current directory.

- Section number overridden to 0 (all sections) for potential multiple packages.

This message will appear in the output if multiple packages might be encountered by db2expln. This action will be taken if one of the pattern matching characters is used in the package or creator input arguments.

- Bind messages for <bind file> can be found in <message file>

This message will appear if the bind of the specified bind file was not successful. Further information on the problems encountered will be found in the specified message file on the database server.

- No static sections qualify from package.

This message will appear in the output if the specified package only contains dynamic query statements, which means that there are no static sections.

- Package "<creator>".<package>", "<version>", is not valid. Rebind the package and then rerun db2expln.

This message will appear in the output if the specified package is currently not valid. Reissue the BIND or REBIND command for the plan to recreate a valid package in the database, and then rerun db2expln.

The following statements will not be explained:

- BEGIN/END COMPOUND
- BEGIN/END DECLARE SECTION
- CLOSE cursor
- COMMIT and ROLLBACK
- CONNECT
- DESCRIBE
- Dynamic DECLARE CURSOR
- EXECUTE
- EXECUTE IMMEDIATE
- FETCH
- INCLUDE
- OPEN cursor
- PREPARE
- SQL control statements
- WHENEVER

Each sub-statement within a compound SQL statement might have its own section, which can be explained by db2expln.

Note: The db2expln command does not exclude any XQuery statements.

Examples

To explain multiple plans with one invocation of db2expln, use the -package, -schema, and -version option and specify string constants for packages and creators with LIKE patterns. That is, the underscore (_) can be used to represent a single character, and the percent sign (%) can be used to represent the occurrence of zero or more characters.

To explain all sections for all packages in a database named SAMPLE, with the results being written to the file my.exp, enter

```
db2expln -database SAMPLE -schema % -package % -output my.exp
```

As another example, suppose a user has a CLP script file called "statements.db2" and wants to explain the statements in the file. The file contains the following statements:

```
SET PATH=SYSIBM, SYSFUN, DEPT01, DEPT93@
SELECT EMPNO, TITLE(JOBID) FROM EMPLOYEE@
```

To explain these statements, enter the following command:

```
db2expln -database DEPTDATA -stmtfile statements.db2 -terminator @ -terminal
```

Explain the following statement:

```
SELECT e.lastname, e.job, d.deptname, d.location, p.projname
FROM employee AS e, department AS d, project AS p
WHERE e.workdept = d.deptno AND e.workdept = p.deptno
```

The following command:

```
db2expln -database SAMPLE
-statement "SELECT e.lastname, e.job,
           d.deptname, d.location, p.projname
           FROM employee AS e, department AS d, project AS p
           WHERE e.workdept = d.deptno AND e.workdept = p.deptno"
-terminal
```

returns:

DB2 Enterprise Server Edition n.n, nnnn-xxx (c) Copyright IBM Corp. 1991, yyyy
Licensed Material - Program Property of IBM
IBM DB2 Database SQL and XQUERY Explain Tool

***** DYNAMIC *****

===== STATEMENT =====

```
Isolation Level          = Cursor Stability
Blocking                  = Block Unambiguous Cursors
Query Optimization Class = 5

Partition Parallel       = No
Intra-Partition Parallel = No

SQL Path                  = "SYSIBM", "SYSFUN", "SYSPROC", "SYSIBMADM",
                           "SDINIRO"
```

Statement:

```
SELECT e.lastname, e.job, d.deptname, d.location, p.projname
FROM employee AS e, department AS d, project AS p
WHERE e.workdept =d.deptno AND e.workdept =p.deptno
```

Section Code Page = 1208

Estimated Cost = 22.802252
Estimated Cardinality = 105.000000

Access Table Name = SDINIRO.PROJECT ID = 2,10

```
#Columns = 2
Skip Inserted Rows
Avoid Locking Committed Data
Currently Committed for Cursor Stability
Relation Scan
| Prefetch: Eligible
Lock Intents
| Table: Intent Share
| Row : Next Key Share
Sargable Predicate(s)
| Process Build Table for Hash Join
```

Hash Join

```
Estimated Build Size: 4000
Estimated Probe Size: 4000
Access Table Name = SDINIRO.DEPARTMENT ID = 2,6
#Columns = 3
Skip Inserted Rows
Avoid Locking Committed Data
Currently Committed for Cursor Stability
Relation Scan
| Prefetch: Eligible
Lock Intents
| Table: Intent Share
| Row : Next Key Share
Sargable Predicate(s)
```

```

| | | Process Probe Table for Hash Join
Hash Join
| Estimated Build Size: 4000
| Estimated Probe Size: 4000
| Access Table Name = SDINIRO.EMPLOYEE ID = 2,7
| #Columns = 3
| Skip Inserted Rows
| Avoid Locking Committed Data
| Currently Committed for Cursor Stability
| Relation Scan
| | Prefetch: Eligible
| Lock Intents
| | Table: Intent Share
| | Row : Next Key Share
| Sargable Predicate(s)
| | Process Probe Table for Hash Join
Return Data to Application
| #Columns = 5

End of section

```

Chapter 196. db2extsec - Set permissions for DB2 objects

Sets the permissions for DB2 objects (for example, files, directories, network shares, registry keys and services) on updated DB2 database system installations.

As of DB2 version 9 Fixpak 2, domain groups can be used for extended security.

Authorization

sysadm

Required connection

None

Command syntax

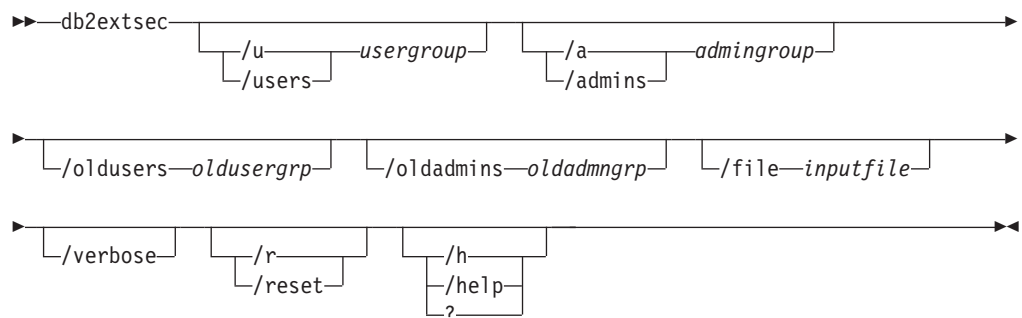

Command parameters

/u | **/users** *usergroup*

Specifies the name of the user group to be added. If this option is not specified, the default DB2 user group (DB2USERS) is used. The *usergroup* can be a local group or a domain group. To specify a local group, you can specify the group name with or without the machine name. For example, DB2USERS, or MYWKSTN\DB2USERS. To specify a domain group, you specify the *usergroup* in the form of DOMAIN\GROUP. For example, MYDOMAIN\DB2USERS.

/a | **/admins** *admingroup*

Specifies the name of the administration group to be added. If this option is not specified, the default DB2 administration group (DB2ADMNS) is used. The *admingroup* can be a local group or a domain group. To specify a local group, you can specify the group name with or without the machine name. For example, DB2ADMNS, or MYWKSTN\DB2ADMNS. To specify a domain group, you specify the *admingroup* in the form of DOMAIN\GROUP. For example, MYDOMAIN\DB2ADMNS.

Note: The following 3 parameters, `/oldusers`, `/oldadmins`, and `/file`, are required when you are changing the extended security group names and have file or directory objects that have been created outside of the default locations (i.e., install directory or database directories). The `db2extsec` command can only change permissions to a known set of DB2 files. If the user had created private DB2 files with extended security, then the user will need to

provide the locations of these file, so the db2extsec command can change the permissions on these files with the new extended security group names. The location of the files are to be supplied in the *inputfile* using the /file option.

/oldusers *oldusergrp*

The old DB2 users group name to be changed.

/oldadmins *oldadmngrp*

The old DB2 admins group name to be changed.

/file *inputfile*

File listing additional files/directories for which the permissions need to be updated.

/verbose

Output extra information.

/r | **/reset**

Specifies that the changes made by previously running db2extsec should be reversed. If you specify this option, all other options are ignored. This option will only work if no other DB2 commands have been issued since the db2extsec command was issued.

/h | **/help** | **?**

Displays the command help information.

Examples

To enable extended security and use the domain groups mydom\db2users and mydom\db2admns to protect your DB2 objects:

```
db2extsec /u mydom\db2users /a mydom\db2admns
```

To reset extended security to its previous setting (see /reset option above):

```
db2extsec /reset
```

To enable extended security as above, but also change the security group for the files/directories listed in c:\mylist.lst from local group db2admns and db2users to domain groups mydom\db2admns and mydom\db2users:

```
db2extsec /users mydom\db2users /admins mydom\db2admns /oldadmins db2admns  
/oldusers db2users /file c:\mylist.lst
```

Note: The format of the input file is as follows:

```
* This is a comment  
D:\MYBACKUPDIR  
D:\MYEXPORTDIR  
D:\MYMISCFILE\myfile.dat
```

```
* This is another comment  
E:\MYOTHERBACKUPDIR  
E:\MYOTHEREXPORTDIR
```

```
* These are more comments
```

Chapter 197. db2flsn - Find log sequence number

Returns the name of the file that contains the log record identified by a specified log sequence number (LSN).

Authorization

None

Command syntax

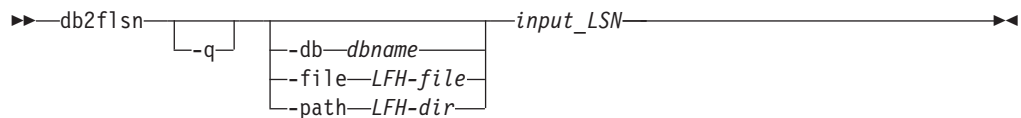

Command parameters

-q Specifies that only the log file name be printed. No error or warning messages will be printed, and status can only be determined through the return code. Valid error codes are:

- -100 Invalid input
- -101 Cannot open LFH file
- -102 Failed to read LFH file
- -103 Invalid LFH
- -104 Database is not recoverable
- -105 LSN too big
- -106 Invalid database
- -500 Logical error

Other valid return codes are:

- 0 Successful execution
- 99 Warning: the result is based on the last known log file size.

-db *dbname*

Specifies the database name which you want to investigate.

-file *LFH-file*

Specifies the full path of an LFH file including the file name.

-path *LFH-dir*

Specifies the full path to the directory where the LFH files, SQLLOGCTL.LFH.1 and its mirror copy SQLLOGCTL.LFH.2, reside.

input_LSN

A 12 or 16 character string that represents the internal (6 or 8 byte) hexadecimal value with leading zeros.

Examples

```
db2flsn 000000BF0030
```

Given LSN is contained in log page 2 in log file S0000002.LOG

```
db2flsn -q 000000BF0030
```

```

S0000002.LOG

db2flsn 000000BE0030
  Given LSN is contained in log page 2 in log file S0000001.LOG

db2flsn -q 000000BE0030
  S0000001.LOG

db2flsn -db flsntest 0000000000FA0000
  Warning: the result is based on the last known log file size (6
  4K pages starting from log extent 10). The input_LSN might be before
  the database becomes recoverable.

  Given LSN is contained in log page 2 in log file S0000002.LOG

db2flsn -q -db flsntest 0000000000FA0000
  S0000002.LOG

db2flsn -file C:\DB2\NODE0000\SQL00001\SQLLOGCTL.LFH.1 0000000000FA4368
  Given LSN is contained in log page 6 in log file S0000002.LOG

db2flsn -path C:\DB2\NODE0000\SQL00001 0000000000FA4368
  Given LSN is contained in log page 6 in log file S0000002.LOG

```

Usage notes

- If `-db`, `-file`, and `-path` are not specified, the tool assumes the LFH files, `SQLLOGCTL.LFH.1` and its mirror copy `SQLLOGCTL.LFH.2`, are in the current directory.
- If `-file` is specified, only the provided LFH file will be used.
- If `-file` is not specified, the latest log control record available from the two LFH files, `SQLLOGCTL.LFH.1` and its mirror copy `SQLLOGCTL.LFH.2`, will be used. If either of the two files is missing or corrupted, the other one will be used. When both files are missing or corrupted, `db2flsn` will fail.
- The tool uses the **logfilsiz** database configuration parameter. DB2 records the three most recent values for this parameter, and the first log file that is created with each **logfilsiz** value; this enables the tool to work correctly when **logfilsiz** changes. If the specified LSN predates the earliest recorded value of **logfilsiz**, the tool uses this value, and returns a warning. The tool can be used with database managers prior to DB2 Universal Database Version 5.2; in this case, the warning is returned even with a correct result (obtained if the value of **logfilsiz** remains unchanged).
- This tool can only be used with recoverable databases. A database is recoverable if it is configured with the **logarchmeth1** or **logarchmeth2** configuration parameters set to a value other than OFF.

Chapter 198. db2fm - DB2 fault monitor

Controls the DB2 fault monitor daemon. You can use db2fm to configure the fault monitor.

This command is only available on UNIX operating systems.

Authorization

Authorization over the instance against which you are running the command.

Required connection

None

Command syntax

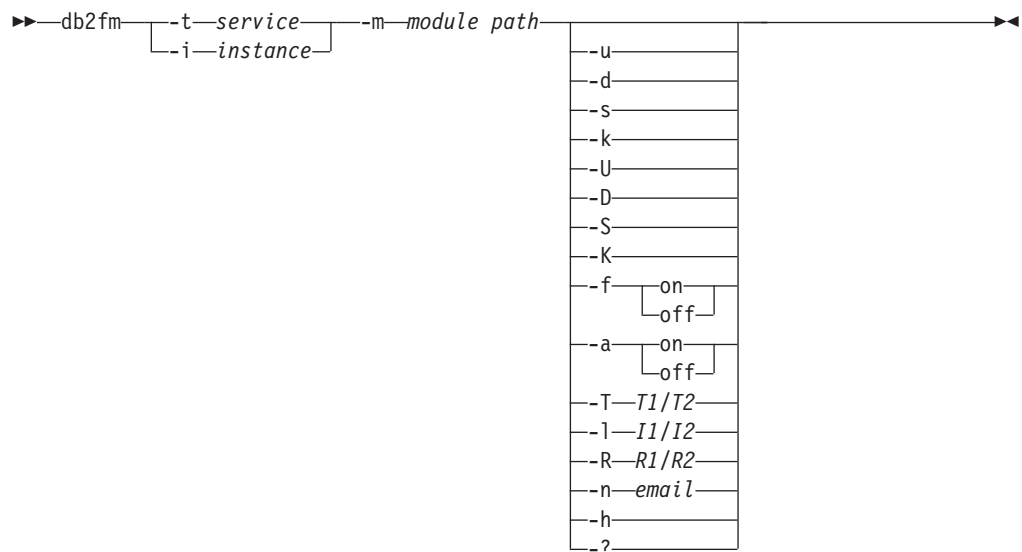

Command parameters

-m *module-path*

Defines the full path of the fault monitor shared library for the product being monitored. The default is \$INSTANCEHOME/sqllib/lib/libdb2gcf.

-t *service*

Gives the unique text descriptor for a service.

-i *instance*

Defines the instance of the service.

-u Brings the service up.

-U Brings the fault monitor daemon up.

-d Brings the instance down.

-D Brings the fault monitor daemon down.

-k Kills the service.

- K** Kills the fault monitor daemon.
- s** Returns the status of the service.
- S** Returns the status of the fault monitor daemon. The status of the service or fault monitor can be one of the following
 - Not properly installed,
 - INSTALLED PROPERLY but NOT ALIVE,
 - ALIVE but NOT AVAILABLE (maintenance),
 - AVAILABLE, or
 - UNKNOWN
- f on | off**
Turns fault monitor ON or OFF. If this option is set off, the fault monitor daemon will not be started, or the daemon will exit if it was running.
- a on | off**
Activates or deactivates fault monitoring. If this option is set to OFF, the fault monitor will not be actively monitoring, which means if the service goes down it will not try to bring it back.
- T T1/T2**
Overwrites the start and stop time-out.
For example:
 - -T 15/10 updates the two time-outs respectively
 - -T 15 updates the start time-out to 15 secs
 - -T /10 updates the stop time-out to 10 secs
- I I1/I2**
Sets the status interval and time-out respectively.
- R R1/R2**
Sets the number of retries for the status method and action before giving up.
- n email**
Sets the email address for notification of events.
- h | -?** Displays command usage help.

Chapter 199. db2fmcu - DB2 fault monitor controller command

DB2 Fault Monitor is the DB2 facility that automatically starts an instance after a crash. It can also auto restart an instance on machine reboot. You can configure the DB2 fault monitor on Linux and UNIX systems using the DB2 fault monitor controller command. The command must be run as root because it accesses the system's `inittab` file.

Authorization

Root

Required connection

None

Command syntax

```
db2fmcu -u -p db2fmcu_path -d -f inittab
```

Command parameters

-u -p *db2fmcu_path*

This option reconfigures the `inittab` file to include the fault monitor controller (FMC) at system startup, where *db2fmcu_path* is the complete path to the FMC daemon (`db2fmcu`) object, for example `/opt/IBM/db2/bin/db2fmcu`.

-d This option changes the `inittab` file configuration to prevent the FMC from being run at system startup.

-f *inittab*

This option specifies a path to the `inittab` file.

Examples

To start the fault monitor controller at system startup by reconfiguring the `inittab` file, run the following command:

```
db2fmcu -u -p /opt/IBM/db2/bin/db2fmcu
```

To prevent the fault monitor controller from being launched at system startup, run the following command:

```
db2fmcu -d
```

Usage notes

If you changed `/etc/inittab` manually, you need to send `SIGHUP` to process 1 to ask it to rescan `/etc/inittab` right away. Otherwise, it can take some time before the next rescan happens. If you updated `/etc/inittab` via `db2fmcu`, you don't need to send the signal as it is already done by `db2fmcu`.

Chapter 200. db2fodc - DB2 first occurrence data collection command

The db2fodc utility captures symptom-based data about the DB2 instance to help in problem determination situations. It is intended to collect information about potential hangs, severe performance issues, and various types of errors..

Purpose

This tool replaces and incorporates functionality from other PD tools. db2fodc command can be used for manual first occurrence data collection (FODC) on problems that cannot trigger automatic FODC, such as hangs or severe performance problems. It also can be used to collect data about index errors. The db2fodc tool captures data, to be included in the FODC package, and places it inside an FODC_symptom directory created in the current DIAGPATH, where symptom is the problem symptom.

Authorization

One of the following:

- On Linux and UNIX systems, the *sysadm* authority level. You must also be the instance owner.
- On Windows operating systems, the *sysadm* authority level.

Command syntax

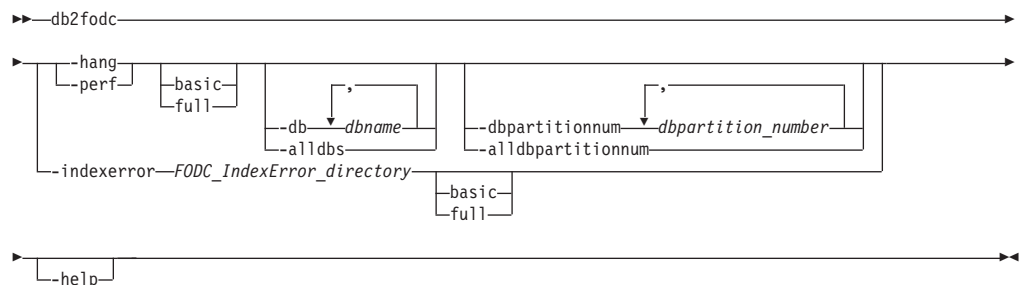

Command parameters

-hang

Collects FODC data related to a potential hang situation or a serious performance issue. The FODC package is prepared as a result of running this option. When this parameter is used, the instance is considered unusable and needs restarting. Data collection is performed as quickly as possible gathering as much information as possible.

basic

The basic collection mode will be run, without user interaction.

full

The full collection mode will be run, without user interaction. This option requires significantly more resources and time to run than basic collection mode.

-perf

Collects data related to a performance issue. This option should be used when the instance is still usable and restarting it is not necessary. This option should affect the system less than the `-hang` parameter. The FODC package is prepared as a result of running this option.

basic

The basic collection mode will be run, without user interaction.

full

The full collection mode will be run, without user interaction. This option includes the `db2trc` command and additional snapshots. This option requires significantly more resources to run than basic collection mode.

Suboptions of -hang and -perf**-alldbs**

Collects FODC data related to all active databases. This option is active by default.

-db *dbname*

Collects FODC data related to a specified database or databases. For example:

```
db2fodc -hang -db sample,dbsample
```

-alldbpartitionnum

Specifies that this command is to run on all active database partition servers in the instance. `db2fodc` will report information from database partition servers on the same physical machine that `db2fodc` is being run on.

-dbpartitionnum *dbpartition_number*

Collects FODC data related to all the specified database partition numbers.

-indexerror *FODC_IndexError_directory*

Collects data related to an index error. *FODC_IndexError_directory* is required and must contain the `db2cos_indexerror_short(.bat)` script and/or `db2cos_indexerror_long(.bat)` script.

basic

The basic collection mode will be run. Ensure no `db2dart` reports exist in the same *FODC_IndexError_directory*.

full

The full collection mode will be run. Ensure no `db2dart` reports exist in the same *FODC_IndexError_directory*. If the `db2cos_indexerror_long(.bat)` script contains the `db2dart /t` command, the full mode requires that the database the `db2dart /t` command is run against be offline.

-help

Displays usage and help information. When this option is specified, all other options are ignored, and only the help information is displayed.

Examples

To collect data during a potential hang without stopping the database manager:

```
db2fodc -hang -alldbs
```

Default DB2FODC registry variables and parameters are used. A new directory `FODC_hang_<timestamp>` is created under the current diagnostic path (an error is

generated if it already exists). `db2cos_hang` script is executed to collect manual FODC data into one or more files, deposited into the `FODC_hang_<timestamp>` directory.

To collect data from a specific database:

```
db2fodc -db SAMPLE -hang
```

Data collection is restricted to database `SAMPLE`. A new directory `FODC_hang_<timestamp>` is automatically created under the current diagnostic path, where the `timestamp` is the time when `db2fodc` was invoked. `db2cos_hang` script is executed to collect manual FODC data into the FODC package stored in the `FODC_hang_<timestamp>` directory.

To collect data during a performance issue from a specific database using the full collection script:

```
db2fodc -db SAMPLE -perf full
```

Data collection is restricted to database `SAMPLE`. A new directory `FODC_perf_<timestamp>` is created under the current diagnostic path. `db2cos_perf` script is executed to collect manual FODC data into one or more files, deposited into the `FODC_perf_<timestamp>` directory.

To collect data about index errors with default (basic) mode without stopping the database manager:

```
db2fodc -indexerror FODC_IndexError_directory
```

`db2cos_indexerror_short(.bat)` script is executed to collect manual FODC data into one or more files. The files are deposited into the directory `FODC_IndexError_directory`.

Usage notes

`db2fodc -hang` and `db2fodc -perf` may be run in a multi-partitioned environment with multiple physical nodes. In this environment

```
rah ";db2fodc -hang <full | basic> -alldbpartitionum other_options"
```

or

```
rah ";db2fodc -perf <full | basic> -alldbpartitionum other_options"
```

should be used to invoke `db2fodc` during a potential hang or severe performance issue at all DB2 DPF nodes in a single invocation. Use the suboption `full` or `basic` to set a collection mode which does not require user interaction. Options `-alldbpartitionum` and `-dbpartitionnum` work only for logical partition numbers (non-different physical machines). By default, only information from the current partition number is collected.

`db2fodc -hang` and `db2fodc -perf` will use a log file, `db2fodc_symptom.log`, placed inside the `FODC_symptom` directory, where `symptom` is either `hang` or `perf`. Inside this file, `db2fodc` will also store status information and meta-data describing the FODC package inside the FODC subdirectory. This file will contain information on the type of FODC, the timestamp of the start and/or end of data collection, and other information useful for the analysis of the FODC package.

The behavior of data collection by `db2fodc -hang` and `db2fodc -perf` is controlled via parameters, and can be customized by changing the script that is executed. If

you would like to customize the data collection on UNIX systems, copy the script placed in `/bin/db2cos_symptom` to `/adm/db2cos_symptom`, where *symptom* is either `hang` or `perf`. Once in this new directory, modify the script as you like. On Windows systems, simply modify the default script `\bin\db2cos_symptom.bat`. On UNIX systems, `db2fodc` first tries to execute the script in `/adm/db2cos_symptom`, and, if it is not found, executes the original script in `/bin/db2cos_symptom`. On Windows systems, the script `\bin\db2cos_symptom.bat` is always executed.

The data collected will be written to several files stored into a new or existing subdirectory of the default diagnostic path named `FODC_symptom_timestamp`, where *symptom* is the problem symptom, and *timestamp* is the time of either automatic or manual FODC invocation. A `db2diag` log file diagnostic message will be logged to notify you about the directory name used for this specific automatic or manual FODC.

`db2fodc -indexerror` may be run in a multi-partitioned environment with multiple physical or logical nodes. In this environment

```
db2_all "<<+node#< db2fodc -indexerror FODC_IndexError_directory <basic | full>"
```

should be used to invoke `db2fodc` to collect information for an index error at a specific DB2 DPF partition number. Replace `node#` with the number of the specific DPF node. This number is the last number in the directory name `<FODC_IndexError_timestamp_PID_EDUID_Node#>`. An `FODC_IndexError_directory` with an absolute path must be specified and the suboption `full` or `basic` may be used to set a collection mode. An absolute path is only required when using `db2fodc -indexerror` with the `db2_all` command.

`db2fodc -indexerror` will output the progress of the command and log the messages, if any, in the `db2diag` log file.

`db2fodc -indexerror` requires a `FODC_IndexError_directory` which contains the `db2cos_indexerror_short(.bat)` script and/or `db2cos_indexerror_long(.bat)` script as input.

The `db2cos_indexerror_short(.bat)` and `db2cos_indexerror_long(.bat)` scripts are located in the `FODC_IndexError_directory` created during the automatic index error FODC process. The scripts contain multiple `db2dart` commands. After running the scripts, the generated `db2dart` reports will be found in the same `FODC_IndexError_directory` that the scripts are located in. Issuing a manual `db2fodc -indexerror` command will not create a new directory. `db2fodc -indexerror` will generate new `db2dart` reports in the same `FODC_IndexError_directory` created by the automatic index error FODC process.

Do not rename or move the `FODC_IndexError_directory`. The `db2dart` commands in the scripts need this directory path to correctly generate reports.

If you need to run `db2fodc -indexerror` manually, check the `FODC_IndexError_directory` for any existing `db2dart` reports. Reports will have the extension `.rpt` and `.rpthex`. If reports exist, you should rename these reports or move them to a subdirectory under the `FODC_IndexError_directory` before running `db2fodc -indexerror` manually. This will preserve the existing reports for the `db2support` tool to collect and will allow `db2fodc -indexerror` to create new `db2dart` reports.

Preparation of the FODC package

Once execution of the `db2fodc` command has finished, the `db2support` tool

must be executed to collect the resulting diagnostic files and prepare the FODC package to be submitted to IBM Support.

By default, db2support will collect all FODC_XXX_XXX directories found under the diagnostics data directory path. This is done to avoid additional requests, from IBM Support, for diagnostic information.

db2fodc diagnostic data collection

db2fodc -hang collects the following information:

db2fodc -hang collects the following info:

- Basic operating system information. The problem could be due to OS level, patches, etc.
- Basic DB2 configuration information.
- Operating system monitor information: vmstat, netstat, iostat, etc.
 - 2 iterations at least: with timestamps saved
- Partial call stacks: DB2 stack traces of top CPU agents.
- Operating system trace: trace on AIX.
- Diagnostic information collected by db2pd.
- DB2 trace.
- Full DB2 call stacks.
- Second round of DB2 configuration information.
 - Including second DB2 trace collection.
- Snapshot information: db2 get snapshot for database, applications, tables, and so on.
 - Information will be collected per node in case of multiple logical nodes.

db2fodc -perf monitors the system possibly collecting the following information:

- Snapshots
- Stacktraces
- Virtual Memory (Vmstat)
- Input/Output information (Iostat)
- traces
- Some other information depending on the case. See the script for more details.

db2fodc -indexerror collects the following information:

- Basic Mode
 - db2cos_indexerror_short(.bat) script is run. See script for additional details.
 - If applicable db2dart commands exist in the script, the db2dart /DD and/or db2dart /DI data formatting actions are run with number of pages limited to 100.
- Full Mode
 - db2cos_indexerror_short(.bat) and db2cos_indexerror_long(.bat) scripts are run. See scripts for additional details.

- If applicable db2dart commands exist in the script `db2cos_indexerror_short(.bat)`, the `db2dart /DD` and/or `db2dart /DI` data formatting actions are run with number of pages limited to 100.
- If applicable db2dart commands exist in the script `db2cos_indexerror_long(.bat)`, the `db2dart /DD` and/or `db2dart /DI` data formatting actions are run with no limit to the number of pages.
- If applicable db2dart commands exist in the `db2cos_indexerror_long(.bat)` script, the `db2dart /T` command is run. This command requires the database be offline.

Chapter 201. db2fs - First steps

Launches the First Steps interface which contains links to the functions users need to begin learning about and using DB2.

On UNIX operating systems, db2fs is located in the sql11ib/bin directory. On Windows operating systems, db2fs.exe is located in the DB2PATH\bin directory.

One of the following browsers must be installed in order to issue the db2fs command:

- Internet Explorer 6.0 and up
- Mozilla 1.7 and up
- Firefox 2.0 and up

Authorization

sysadm

Command syntax

For UNIX operating systems

```
db2fs [-h] [-b browser]
```

For Windows operating systems

```
db2fs
```

Command parameters

For UNIX operating systems

-h Displays command usage information.

-b browser

Specifies the browser to be used. If it is not specified, db2fs searches for a browser in the directories specified in PATH.

For Windows operating systems

None

Chapter 202. db2gcf - Control DB2 instance

Starts, stops, or monitors a DB2 instance, usually from an automated script, such as in an HA (high availability) cluster.

On UNIX operating systems, this command is located in `INSTHOME/sqllib/bin`, where `INSTHOME` is the home directory of the instance owner. On Windows systems, this command is located in the `sqllib\bin` subdirectory.

Authorization

One of the following:

- instance owner
- Root access on Linux and UNIX systems or Local Administrator authority on Windows operating systems

Required connection

None

Command syntax

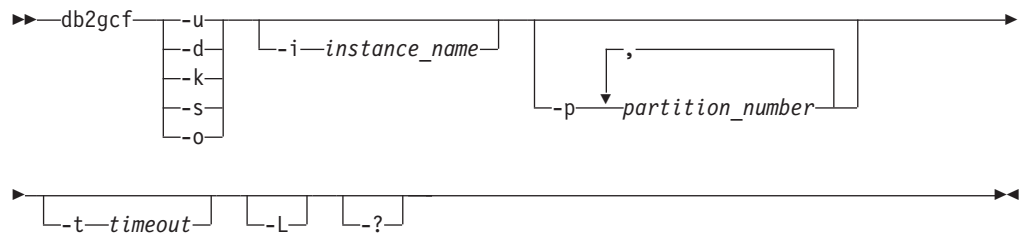

Command parameters

- u Starts specified database partition for specified instance on current database partition server (node).
- d Stops specified database partition for specified instance.
- k Removes all processes associated with the specified instance.
- s Returns status of the specified database partition and the specified instance. The possible states are:
 - *Available*: The specified database partition for the specified instance is available for processing.
 - *Operable*: The instance is installed but not currently available.
 - *Not operable*: The instance will be unable to be brought to available state.
- o Returns the default timeouts for each of the possible actions; you can override all these defaults by specifying a value for the `-t` parameter.
- i *instance_name*
Instance name to perform action against. If no instance name is specified, the value of `DB2INSTANCE` is used. If no instance name is specified and `DB2INSTANCE` is not set, the following error is returned:

db2gcf Error: Neither DB2INSTANCE is set nor instance passed.

-p *partition_number*

In a partitioned database environment, specifies database partition number(s) to perform action against on local node only (remote partitions are not monitored with this command). Specify the partition numbers without any spaces, but separate with commas. If no value is specified, the default is 0. This value is ignored in a single-partition database environment.

-t *timeout*

Timeout in seconds. The db2gcf command will return unsuccessfully if processing does not complete within the specified period of time. There are default timeouts for each of the possible actions; you can override all these defaults by specifying a value for the -t parameter.

-L Enables error logging. Instance-specific information will be logged to db2diag log file in the instance log directory. Non-instance specific information will be logged to system log files.

-? Displays help information. When this option is specified, all other options are ignored, and only the help information is displayed.

Examples

1. The following example starts the instance stevera on partition 0:

```
db2gcf -u -p 0 -i stevera
```

The following output is returned:

```
Instance : stevera
DB2 Start : Success
Partition 0 : Success
```

2. The following example returns the status of the instance stevera on partition 0:

```
db2gcf -s -p 0 -i stevera
```

The following output is returned:

```
Instance : stevera
DB2 State
Partition 0 : Available
```

3. The following example stops the instance stevera on partition 0:

```
db2gcf -d -p 0 -i stevera
```

The following output is returned:

```
Instance : stevera
DB2 Stop : Success
Partition 0 : Success
```

Usage notes

When used together, the -k and -p parameters do not allow all processes to be removed from the specified partition. Rather, all processes on the instance (all partitions) will be removed.

Return codes

The following is a list of all the return codes for this command.

db2gcf Return Values :

- 0 : db2 service(start,stop,kill) success or db2gcf -s status Available
- 1 : db2 service(start,stop) failed or db2gcf -s status Not Available
- 2 : db2gcf has been called with wrong number of parameters
- 3 : gcfmodule failed to execute the requested service

Chapter 203. db2gov - DB2 governor

Monitors and changes the behavior of applications that run against a database. By default, a daemon is started on every database partition, but the front-end utility can be used to start a single daemon at a specific database partition.

Important: With the new workload management features introduced in DB2 Version 9.5, the DB2 governor utility has been deprecated in Version 9.7 and might be removed in a future release. For more information, see the “DB2 Governor and Query Patroller have been deprecated” topic in the *What's New for DB2 Version 9.7* book.

Authorization

One of the following:

- *sysadm*
- *sysctrl*

In an environment with an instance that has a `db2nodes.cfg` file defined, you might also require the authorization to invoke the `db2_all` command. Environments with a `db2nodes.cfg` file defined include partitioned database environments as well as single-partition database environments that have a database partition defined in `db2nodes.cfg`.

Command syntax

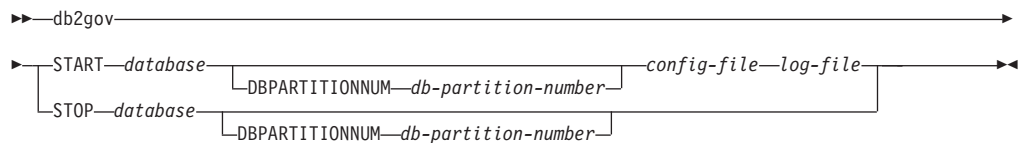

Command parameters

START *database*

Starts the governor daemon to monitor the specified database. Either the database name or the database alias can be specified. The name specified must be the same as the one specified in the governor configuration file. One daemon runs for each database that is being monitored. In a partitioned database environment, one daemon runs for each database partition. If the governor is running for more than one database, there will be more than one daemon running at that database server.

DBPARTITIONNUM *db-partition-number*

Specifies the database partition on which to start or stop the governor daemon. The number specified must be the same as the one specified in the database partition configuration file.

config-file

Specifies the configuration file to use when monitoring the database. The default location for the configuration file is the `sqllib` directory. If the specified file is not there, the front-end assumes that the specified name is the full name of the file.

log-file Specifies the base name of the file to which the governor writes log records. The log file is stored in the log subdirectory of the sqllib directory. The number of database partitions on which the governor is running is automatically appended to the log file name. For example, mylog.0, mylog.1, mylog.2.

STOP *database*

Stops the governor daemon that is monitoring the specified database. In a partitioned database environment, the front-end utility stops the governor on all database partitions by reading the database partition configuration file db2nodes.cfg.

Usage notes

In the [action] clause of the governor configuration file, the nice *nnn* parameter can be set to raise or lower the relative priority of agents working for an application. For additional information, see “Governor rule elements” in the guide called *Tuning Database Performance*.

Note: On AIX 5.3 or higher, the instance owner must have the CAP_NUMA_ATTACH capability to be able to raise the relative priority of agents working for the application. To grant this capability, logon as root and run the following command:

```
chuser capabilities=CAP_NUMA_ATTACH,CAP_PROPAGATE
```

Compatibilities

For compatibility with versions earlier than Version 8:

- The keyword NODENUM can be substituted for DBPARTITIONNUM.

Chapter 204. db2govlg - DB2 governor log query

Extracts records of specified type from the governor log files. The DB2 governor monitors and changes the behavior of applications that run against a database.

Important: With the new workload management features introduced in DB2 Version 9.5, the DB2 governor utility has been deprecated in Version 9.7 and might be removed in a future release. For more information, see the “DB2 Governor and Query Patroller have been deprecated” topic in the *What's New for DB2 Version 9.7* book.

Authorization

None

Command syntax

```
db2govlg log-file dbpartitionnum db-partition-number  
rectype record-type
```

Command parameters

log-file The base name of one or more log files that are to be queried.

dbpartitionnum *db-partition-number*

Number of the database partition on which the governor is running.

rectype *record-type*

The type of record that is to be queried. Valid record types are:

- START
- FORCE
- NICE
- ERROR
- WARNING
- READCFG
- STOP
- ACCOUNT

Compatibilities

For compatibility with versions earlier than Version 8:

- The keyword `nodenum` can be substituted for `dbpartitionnum`.

Chapter 205. db2gpmmap - Get distribution map

If a database is already set up and database partition groups defined for it, db2gpmmap gets the distribution map for the database table or the database partition group from the catalog partitioned database server.

Authorization

Both of the following:

- Read access to the system catalog tables
- BIND and EXECUTE package privileges on db2gpmmap.bnd

Required connection

Before using db2gpmmap the database manager must be started and db2gpmmap.bnd must be bound to the database. If not already bound db2gpmmap will attempt to bind the file.

Command syntax

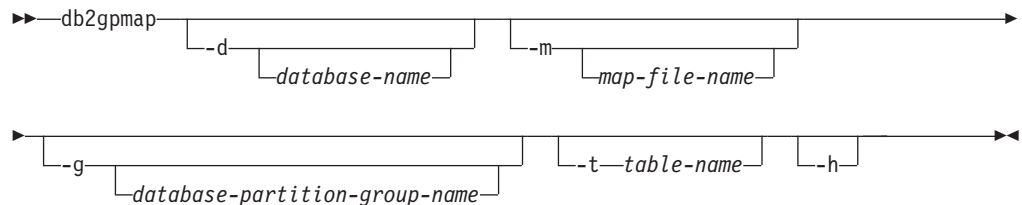

Command parameters

-d *database-name*

Specifies the name of the database for which to generate a distribution map. If no database name is specified, the value of the DB2DBDFT environment variable is used. If DB2DBDFT is not set, the default is the SAMPLE database.

-m *map-file-name*

Specifies the fully qualified file name where the distribution map will be saved. The default is db2split.map.

-g *database-partition-group-name*

Specifies the name of the database partition group for which to generate a distribution map. The default is IBMDEFAULTGROUP.

-t *table-name*

Specifies the table name.

-h Displays usage information.

Examples

The following example extracts the distribution map for a table ZURBIE.SALES in database SAMPLE into a file called C:\pmaps\zurbie_sales.map:

```
db2gpmmap -d SAMPLE -m C:\pmaps\zurbie_sales.map -t ZURBIE.SALES
```

Chapter 206. db2hc - Start health center

Starts the Health Center. The Health Center is a graphical interface that is used to view the overall health of database systems. Using the Health Center, you can view details and recommendations for alerts on health indicators and take the recommended actions to resolve the alerts.

Important: This command has been deprecated and might be removed in a future release because the Control Center and its associated components have been deprecated in Version 9.7. For more information, see the “Control Center tools and DB2 administration server (DAS) have been deprecated” topic in the *What’s New for DB2 Version 9.7* book.

Authorization

No special authority is required for viewing the information. Appropriate authority is required for taking actions.

Required Connection

Instance

Command Syntax

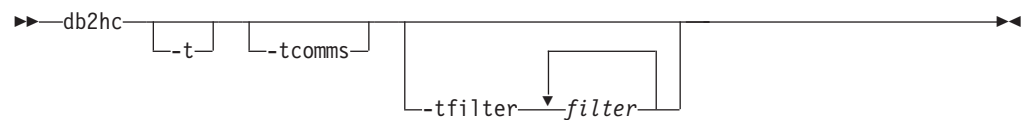

Command Parameters

- t** Turns on NavTrace for initialization code. You should use this option only when instructed to do so by DB2 Support.
- tcomms** Limits tracing to communication events. You should use this option only when instructed to do so by DB2 Support.
- tfilter *filter*** Limits tracing to entries containing the specified filter or filters. You should use this option only when instructed to do so by DB2 Support.

Chapter 207. db2iauto - Auto-start instance

Enables or disables the auto-start of an instance after each system restart. This command is available on Linux and UNIX systems only.

Authorization

One of the following:

- Root authority
- *sysadm*

Required connection

None

Command syntax

```
▶▶ db2iauto [-on | -off] instance-name ▶▶
```

Command parameters

- on** Enables auto-start for the specified instance.
 - off** Disables auto-start for the specified instance.
- instance-name*
The login name of the instance.

Chapter 208. db2iclus - Microsoft cluster server

Allows users to add, drop, migrate and unmigrate instances and DB2 administration servers (DAS) in a Microsoft Cluster Server (MSCS) environment. This command is only available on Windows platforms.

Authorization

Local administrator authority is required on the machine where the task will be performed. If adding a remote machine to an instance or removing a remote machine from an instance, local administrator authority is required on the target machine.

Required connection

None

Command syntax

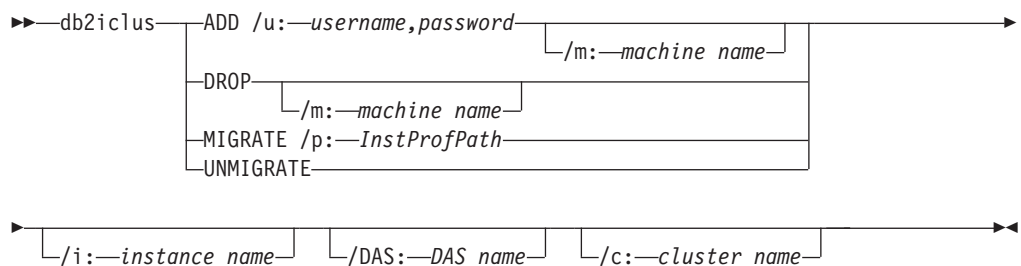

Command parameters

ADD Adds an MSCS node to a DB2 MSCS instance.

DROP Removes an MSCS node from a DB2 MSCS instance.

MIGRATE

Migrates a non-MSCS instance to an MSCS instance.

UNMIGRATE

Undoes the MSCS migration.

/DAS:DAS name

Specifies the DAS name. This option is required when performing the cluster operation against the DB2 administration server.

/c:cluster name

Specifies the MSCS cluster name if different from the default/current cluster.

/p:instance profile path

Specifies the instance profile path. This path must reside on a cluster disk so it is accessible when DB2 is active on any machine in the MSCS cluster. This option is required when migrating a non-MSCS instance to an MSCS instance.

/u:username,password

Specifies the account name and password for the DB2 service. This option is required when adding another MSCS node to the DB2 MSCS partitioned database instance.

/m:machine name

Specifies the remote computer name for adding or removing an MSCS node.

/i:instance name

Specifies the instance name if different from the default/current instance.

Examples

This example shows the use of the `db2iclus` command to manually configure the DB2 instance to run in a hot standby configuration that consists of two machines, WA26 and WA27.

1. To start, MSCS and DB2 Enterprise Server Edition must be installed on both machines.
2. Create a new instance called DB2 on machine WA26:

```
db2icrt DB2
```

3. From the Windows Services dialog box, ensure that the instance is configured to start manually.
4. If the DB2 instance is running, stop it with the `DB2STOP` command.
5. Install the DB2 resource type from WA26:

```
c:>db2wolfi i  
ok
```

If the `db2wolfi` command returns "Error : 183", then it is already installed. To confirm, the resource type can be dropped and added again. Also, the resource type will not show up in Cluster Administrator if it does not exist.

```
c:>db2wolfi u  
ok  
c:>db2wolfi i  
ok
```

6. From WA26, use the `db2iclus` command to transform the DB2 instance into a clustered instance.

```
c:>\db2iclus migrate /i:db2 /c:mycluster /m:wa26 /p:p:\db2profs
```

```
DBI1912I The DB2 Cluster command was successful.  
Explanation: The user request was successfully processed.  
User Response: No action required.
```

The directory `p:\db2profs` should be on a clustered drive and must already exist. This drive should also be currently owned by machine WA26.

7. From WA26, use the `db2iclus` command to add other machines to the DB2 cluster list:

```
c:>\db2iclus add /i:db2 /c:mycluster /m:wa27
```

```
DBI1912I The DB2 Cluster command was successful.  
Explanation: The user request was successfully processed.  
User Response: No action required.
```

This command should be executed for each subsequent machine in the cluster.

8. From Cluster Administrator, create a new group called "DB2 Group".

9. From Cluster Administrator, move the Physical Disk resources Disk O and Disk P into DB2 Group.
10. From Cluster Administrator, create a new resource type of type "IP Address" called "mscs5" that resides on the Public Network. This resource should also belong to DB2 Group. This will be a highly available IP address, and this address should not correspond to any machine on the network. Bring the IP Address resource type online and ensure that the address can be pinged from a remote machine.
11. From Cluster Administrator, create a new resource of type "DB2" that will belong to DB2 Group. The name of this resource must be exactly identical to the instance name, so it is called DB2 for this case. When Cluster Administrator prompts for dependencies associated with the DB2 resource, ensure it is dependent on Disk O, Disk P and mscs5.
12. Configure DB2 Group for fallback, if desired, via Cluster Administrator and using the DB2_FALLBACK profile variable.
13. Create or restore all databases putting all data on Disk O and Disk P.
14. Test the failover configuration.

Usage notes

To migrate an instance to run in an MSCS failover environment, you need to migrate the instance on the current machine first, then add other MSCS nodes to the instance using the db2iclus with the ADD option.

To revert an MSCS instance back to a regular instance, you first need to remove all other MSCS nodes from the instance by using the db2iclus with the DROP option. Next, you should undo the migration for the instance on the current machine.

Chapter 209. db2icrt - Create instance

Creates DB2 instances.

On Linux and UNIX operating systems, this utility is located in the *DB2DIR/instance* directory, where *DB2DIR* represents the installation location where the current version of the DB2 database system is installed. On Windows operating systems, this utility is located under the **DB2PATH**\bin directory where **DB2PATH** is the location where the DB2 copy is installed.

The db2icrt command creates DB2 instances in the instance owner's home directory.

Note: This command is not available for a non-root installation of DB2 database products on Linux and UNIX operating systems.

Authorization

Root access on Linux and UNIX operating systems or Local Administrator authority on Windows operating systems.

Command syntax

For Linux and UNIX operating systems

```
db2icrt [-h] [-d] [-a AuthType] [-p PortName]
        [-s InstType] [-u FencedID] InstName
```

For Windows operating systems

```
db2icrt InstName [-s InstType] [-u UserName, Password]
                 [-p InstProfPath] [-h HostName] [-r PortRange]
                 [-j "TEXT_SEARCH [,servicename] [,portnumber]" ] [-?]
```

Command parameters

For Linux and UNIX operating systems

- h | -? Displays the usage information.
- d Turns debug mode on. Use this option only when instructed by DB2 Support.

-a *AuthType*
Specifies the authentication type (SERVER, CLIENT or SERVER_ENCRYPT) for the instance. The default is SERVER.

-p *PortName*
Specifies the port name or number used by the instance. This option does not apply to client instances.

-s *InstType*
Specifies the type of instance to create. Use the **-s** option only when you are creating an instance other than the default associated with the installed product from which you are running db2icrt. Valid values are:

client Used to create an instance for a client. This is the default instance type for IBM Data Server Client, IBM Data Server Runtime Client, and DB2 Connect Personal Edition.

standalone

Used to create an instance for a database server with local clients. It is the default instance type for DB2 Personal Edition.

ese Used to create an instance for a database server with local and remote clients with DPF support. This is the default instance type for DB2 Enterprise Server Edition.

wse Used to create an instance for a database server with local and remote clients. This is the default instance type for DB2 Workgroup Server Edition, DB2 Express or Express-C Edition, and DB2 Connect Enterprise Edition.

DB2 products support their default instance types and the instance types lower than their default ones. For instance, DB2 Enterprise Server Edition supports the instance types of ese, wse, standalone and client.

-u *Fenced ID*
Specifies the name of the user ID under which fenced user-defined functions and fenced stored procedures will run. The **-u** option is required if you are not creating a client instance.

InstName
Specifies the name of the instance which is also the name of an existing user in the operating system. This has to be the last argument of the db2icrt command.

For Windows operating systems

InstName
Specifies the name of the instance.

-s *InstType*
Specifies the type of instance to create. Currently, there are four kinds of DB2 instance types. Valid values are:

client Used to create an instance for a client. This is the default instance type for IBM Data Server Client, IBM Data Server Runtime Client, and DB2 Connect Personal Edition.

standalone

Used to create an instance for a database server with local clients. It is the default instance type for DB2 Personal Edition.

ese Used to create an instance for a database server with local and remote clients with DPF support. The

`-s ese -u Username, Password`

options have to be used with `db2icrt` to create the ESE instance type and a DPF instance.

wse Used to create an instance for a database server with local and remote clients. This is the default instance type for DB2 Workgroup Server Edition, DB2 Express or Express-C Edition, and DB2 Connect Enterprise Edition.

DB2 products support their default instance types and the instance types lower than their default ones. For instance, DB2 Enterprise Server Edition supports the instance types of `ese`, `wse`, `standalone` and `client`.

-u *Username, Password*

Specifies the account name and password for the DB2 service. This option is required when creating a partitioned database instance.

-p *InstProfPath*

Specifies the instance profile path.

-h *HostName*

Overrides the default TCP/IP host name if there is more than one for the current machine. The TCP/IP host name is used when creating the default database partition (database partition 0). This option is only valid for partitioned database instances.

-r *PortRange*

Specifies a range of TCP/IP ports to be used by the partitioned database instance when running in MPP mode. For example, `-r 50000,50007`. The services file of the local machine will be updated with the following entries if this option is specified:

DB2_InstName	baseport/tcp
DB2_InstName_END	endport/tcp

/j "TEXT_SEARCH"

Configures the DB2 Text Search server using generated default values for service name and TCP/IP port number. This parameter cannot be used if the instance type is *client*.

/j "TEXT_SEARCH, servicename"

Configures the DB2 Text Search server using the provided service name and an automatically generated port number. If the service name has a port number assigned in the services file, it uses the assigned port number.

/j "TEXT_SEARCH, servicename, portnumber"

Configures the DB2 Text Search server using the provided service name and port number.

/j "TEXT_SEARCH, portnumber"

Configures the DB2 Text Search server using a default service name and the provided port number. Valid port numbers must be within the 1024 - 65535 range.

-? Displays usage information.

Examples

- On an AIX machine, to create an instance for the user ID `db2inst1`, issue the following command:

On a client machine:

```
DB2DIR/instance/db2icrt db2inst1
```

On a server machine:

```
DB2DIR/instance/db2icrt -u db2fenc1 db2inst1
```

where db2fenc1 is the user ID under which fenced user-defined functions and fenced stored procedures will run.

Usage notes

- The instance home/sqllib/db2tss/config folder is created by db2icrt on Linux and UNIX operating systems. It is advised that you use a symbolic link to an area outside the sqllib directory.
- The -s option is intended for situations in which you want to create an instance that does not use the full functionality of the system. For example, if you are using Enterprise Server Edition (ESE) on a UNIX operating system, but do not want partition capabilities, you could create a Workgroup Server Edition (WSE) instance, using the option -s WSE.
- To create a DB2 instance that supports Microsoft Cluster Server, first create an instance, then use the db2mscs command to migrate it to run in a MSCS instance.
- On Linux and UNIX operating systems, only one instance can be created under a user name. If you want to create an instance under a user name that already has an instance, you must drop the existing instance before creating the new one.
- When creating DB2 instances, consider the following restrictions:
 - If existing IDs are used to create DB2 instances, make sure that the IDs are not locked and do not have passwords expired.
- You can also use the db2isetup command to create and update DB2 instances using a graphical interface on all supported Linux and UNIX operating systems.
- On Linux and UNIX systems, if you are using the su command instead of the login command to become the root user, you must issue the su command with the - option to indicate that the process environment is to be set as if you had logged in to the system using the login command.
- On Linux and UNIX operating systems, you must not source the DB2 instance environment for the root user. Running db2icrt when you sourced the DB2 instance environment is not supported.
- On AIX 6.1 (or higher), when running this command from a shared DB2 copy in a system workload partition (WPAR) global environment, this command must be run as the root user.
- On Windows operating systems, if the IBM Tivoli Monitoring for Databases: DB2 Agent is installed and the DB2 instance is created, the Monitoring Agent for DB2 instance is also created if the following are true:
 - The DB2 instance type is standalone, wse, or ese.
 - The default DB2 copy has the ITM agent component installed.
 - The DB2 instance is at version 9.5 (or higher).
 - There is no existing ITM for Databases product.

In addition, the following are also created after the creation of the Monitoring Agent for DB2 instance: the Monitoring Agent for DB2 instance files, the NT service and the registry entries.

Chapter 210. db2idrop - Remove instance

Removes a DB2 instance that was created by db2icrt. You can only drop instances that are listed by db2ilist for the same DB2 copy where you are issuing db2idrop from.

On Linux and UNIX operating systems, this utility is located in the *DB2DIR/instance* directory, where *DB2DIR* represents the installation location where the current version of the DB2 database system is installed. On Windows operating systems, this utility is located under the **DB2PATH**\bin directory where **DB2PATH** is the location where the DB2 copy is installed.

Note: A non-root-installed DB2 instance, on Linux and UNIX operating systems, cannot be dropped using this command. The only option is to uninstall the non-root DB2 copy. See *Usage notes* below for more details.

Authorization

Root access on Linux and UNIX operating systems or Local Administrator on Windows operating systems.

Command syntax

For Linux and UNIX operating systems

```
db2idrop InstName [-d] [-f] [-h] [-?]
```

For Windows operating systems

```
db2idrop InstName [-f] [-h]
```

Command parameters

For Linux and UNIX operating systems

InstName

Specifies the name of the instance.

-d Enters debug mode, for use by DB2 Service.

-f This parameter is deprecated. Specifies the force applications flag. If this flag is specified all the applications using the instance will be forced to terminate.

-h | -? Displays the usage information.

For Windows operating systems

InstName

Specifies the name of the instance.

- f Specifies the force applications flag. If this flag is specified all the applications using the instance will be forced to terminate.
- h Displays usage information.

Examples

- If you created `db2inst1` on a Linux or UNIX operating system by issuing the following command:

```
/opt/IBM/db2/copy1/instance/db2icrt -u db2fenc1 db2inst1
```

To drop `db2inst1`, you must run the following command:

```
/opt/IBM/db2/copy1/instance/db2idrop db2inst1
```

Usage notes

- Before an instance is dropped, ensure that the DB2 database manager has been stopped and that DB2 database applications accessing the instance are disconnected and terminated. DB2 databases associated with the instance can be backed up, and configuration data saved for future reference if needed.
- The `db2idrop` command does not remove any databases. Remove the databases first if they are no longer required. If the databases are not removed, they can always be catalogued under another DB2 copy of the same release and continued to be used.
- If you wish to save DB2 Text Search configurations and plan to reuse instance databases, you need to take the extra step of saving the config directory (on UNIX: `instance_home/sqllib/db2tss/config` and on Windows: `instance_profile_path\instance_name\db2tss\config`) or config directory contents before issuing the `db2idrop` command. After the new instance is created, the config directory can be restored. However, restoring the config directory is only applicable if the new instance created is of the same release and fix pack level.
- A non-root-installed instance cannot be dropped on Linux and UNIX operating systems. To remove this DB2 instance, the only option available to the user is to uninstall the non-root copy of DB2 by running `db2_deinstall -a`.
- On Linux and UNIX operating systems, if you are using the `su` command instead of the `login` command to become the root user, you must issue the `su` command with the `-` option to indicate that the process environment is to be set as if you had logged in to the system using the `login` command.
- On Linux and UNIX operating systems, you must not source the DB2 instance environment for the root user. Running `db2idrop` when you sourced the DB2 instance environment is not supported.
- On AIX 6.1 (or higher), when running this command from a shared DB2 copy in a system workload partition (WPAR) global environment, this command must be run as the root user.
- On Windows operating systems, if the IBM Tivoli Monitoring for Databases: DB2 Agent is installed and the DB2 instance is dropped, the Monitoring Agent for DB2 is stopped. All files, services and registry entries created for the Monitoring Agent for DB2 instance are also deleted.

Chapter 211. db2IdentifyType1 - Type-1 index identification tool

Identifies and generates into an output file the appropriate REORG INDEXES ALL commands with the **ALLOW WRITE ACCESS** and **CONVERT** clauses which you can use to convert type-1 indexes to type-2 indexes for a specified database. This command is intended to be run on databases that have not yet been upgraded to Version 9.7.

You do not need to run this command if your databases do not have type-1 indexes. By default, all new indexes created in Version 8 (or later) are type-2 indexes, except when you created an index on a table that already had type-1 indexes or when the **DB2_INDEX_TYPE2** registry variable was set to OFF. You might also have type-1 indexes on databases that were created on DB2 UDB Version 7 (or earlier) and that have not yet been converted.

To minimize the performance impact on the first access to tables with type-1 indexes, run db2IdentifyType1, and convert these indexes before upgrading your database to Version 9.7. If some tables still have type-1 indexes on them during the database upgrade, those indexes are marked invalid. After the upgrade, those indexes are converted to type-2 indexes on first access to the tables, or on database restart if you set the **indexrec** configuration parameter to RESTART. The tables are inaccessible until you have rebuilt the indexes. See the Usage Notes section for other important performance notes and details about the impact of running this command in partitioned database environments.

This command does not perform the index conversion. After you generate the output file, you can review it, edit its content if necessary, and then run the output file by using the following command:

```
db2 -tvf filename
```

Run the db2IdentifyType1 command from the following directories:

- On Linux and UNIX operating systems: from the DB2DIR/bin directory, where DB2DIR is the location where the DB2 copy is installed
- On Windows operating systems: from the db2\Windows\Utilities directory on the product CD

Authorization

For databases not upgraded to Version 9.7, one of the following authorization levels is required:

- SYSADM
- DBADM

For databases upgraded to Version 9.7:

- DBADM

Required connection

Database. This command automatically establishes a connection to the specified database.

Command syntax

```
db2IdentifyType1 -d database-name -o filename [-s schema-name] [-t table-name] [-h]
```

Command parameters

-d database-name

Specifies the name of the database to query.

-o filename

Specifies the path and the name of a file to which to write the REORG INDEX commands. The db2IdentifyType1.err log file is created in the same path. The db2IdentifyType1.err log file contains troubleshooting information and is created only if the db2IdentifyType1 command fails. You can qualify the file name, which cannot exceed 246 characters, by using a full or relative path name. If a file with the same name exists, it is overwritten.

-s schema-name

Specifies the schema (creator user ID) of the tables to query. If you do not specify a schema, tables with all schemas are queried. You cannot specify more than one schema name at a time. You must specify schema name identifiers as they are shown in the system catalog tables, using uppercase. You must enclose delimited schema name identifiers in double quotation marks.

-t table-name

Specifies the name of a table to query. If you do not specify a table name, all tables are queried. You cannot specify more than one table name at a time. You must specify table name identifiers as they are shown in the system catalog tables, using uppercase. You must enclose delimited table name identifiers in double quotation marks.

-h Displays help information. If you specify this option, all other options are ignored.

Usage notes

You do not have to use this tool unless there are type-1 indexes in a database or unless you are unsure whether a database contains type-1 indexes. If you know that you have many type-1 indexes, then you might choose to run REORG INDEXES with the CONVERT option against all of the tables in your database, or against specific tables with type-1 indexes, rather than using this command to identify specific tables. REORG INDEXES with the CONVERT option has no effect if the indexes are already type-2.

This command does not detect typed tables with type-1 indexes in DB2 UDB Version 8 databases. If you are upgrading from Version 8, refer to the “Converting type-1 indexes to type-2 indexes” topic to determine whether your typed tables have type-1 indexes and to convert these indexes.

For databases with a large number of tables, the db2IdentifyType1 command can take a long time to complete its processing, you should use the -s or -t option to scan only a specific subset at a time.

Performance and usage considerations for partitioned database environments: In partitioned database environments, it is possible that type-1 indexes do not exist on all of the database partitions on which a table resides. This could occur if an index was converted to a type-2 index on only a subset of the database partitions. It is also possible that a table resides in a database partition group which does not include every database partition. Depending on the database version level, you might need to run the command on more than one partition:

- In Version 9.1 or Version 9.5 partitioned database environments, the `db2IdentifyType1` command needs to run only on one database partition to detect all type-1 indexes, regardless of whether these indexes exist on all database partitions. For best performance, you should run it on the catalog database partition. The command might take a long time to complete if the database has many partitions because data is gathered from each partition.
- In Version 8 partitioned database environments, the `db2IdentifyType1` command detects only type-1 indexes that exist on the partition where the command is run. If tables do not exist on every database partition, or if it is suspected that indexes might have been converted to type-2 on some partitions but not others, then you should run it on all database partitions to ensure that all type-1 indexes are detected.

Chapter 212. db2ilist - List instances

Lists all the instances that are created using the db2icrt command from the same DB2 copy location that you are running the db2ilist command.

On Linux and UNIX operating systems, this utility is located in the *DB2DIR/instance* directory, where *DB2DIR* is the instance directory where the DB2 copy is installed. On Windows operating systems, this utility is located under the **DB2PATH\bin** directory where **DB2PATH** represents the installation location where the current version of the DB2 database system is installed.

Authorization

None

Command syntax

```
▶▶ db2ilist [ -h ] ▶▶
```

Command parameters

-h Displays usage information.

Usage notes

- On Linux and UNIX operating systems, if you are using the su command instead of the login command to become the root user, you must issue the su command with the - option to indicate that the process environment is to be set as if you had logged in to the system using the login command.
- On Linux and UNIX operating systems, you must not source the DB2 instance environment for the root user. Running db2ilist when you sourced the DB2 instance environment is not supported.
- On AIX 6.1 (or higher), when running this command from a shared DB2 copy in a system workload partition (WPAR) global environment, this command must be run as the root user.

Chapter 213. db2iupgrade - Upgrade instance

The db2iupgrade command upgrades an instance to a DB2 copy of the current release from a DB2 copy of a previous release. The DB2 copy from where you are running the db2iupgrade command must support instance upgrade from the DB2 copy that you want to upgrade.

On Linux and UNIX systems, this command is located in the DB2DIR/instance directory, where DB2DIR represents the installation location where the new release of the DB2 database system is installed. This command does not support instance upgrade for a non-root installation.

On Windows operating systems, this command is located in the DB2PATH\bin directory, where DB2PATH is the location where the DB2 copy is installed. To move your instance profile from its current location to another location, use the /p option and specify the instance profile path. Otherwise, the instance profile will stay in its original location after the upgrade.

The db2iupgrade command calls the db2ckupgrade command with the **-not1** parameter and specifying db2ckupgrade.log as the log file. Verify that local databases are ready for upgrade before upgrading the instance. The **-not1** parameter disables the check for type-1 indexes. The log file is created in the instance home directory for Linux and UNIX operating systems or in the current directory for Windows operating systems. The instance upgrade will not continue if the db2ckupgrade command returns any errors.

In a partitioned database environment, the db2iupgrade command runs the db2ckupgrade command on the database partition where you issue the db2iupgrade command. Verify that all database partitions are ready for upgrade before upgrading an instance.

Authorization

Root access on Linux and UNIX systems or Local Administrator on Windows operating systems.

Command syntax

For Linux and UNIX systems

```
db2iupgrade [-d] [-k] [-a AuthType] [-u FencedID] InstName
```

For Windows operating systems

```
db2iupgrade InstName /u:username,password  
/p:instance-profile-path /q /a:authType
```

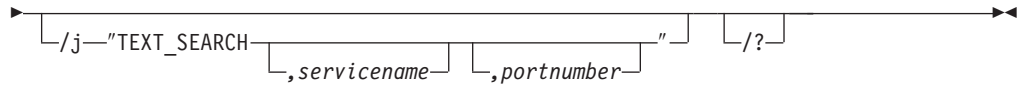

Command parameters

For Linux and UNIX systems

- d** Turns debug mode on. Use this option only when instructed by DB2 Support.
- k** Keeps the pre-upgrade instance type if it is supported in the DB2 copy from where you are running the `db2iupgrade` command. If this parameter is not specified, the instance type is upgraded to the default instance type supported.
- a *AuthType***
Specifies the authentication type (SERVER, CLIENT or SERVER_ENCRYPT) for the instance. The default is SERVER.
- u *FencedID***
Specifies the name of the user ID under which fenced user-defined functions and fenced stored procedures will run. This option is required when upgrading a DB2 client instance to a DB2 server instance.

InstName
Specifies the name of the instance.

For Windows operating systems

- InstName*
Specifies the name of the instance.
- /u:username,password**
Specifies the account name and password for the DB2 service. This option is required when upgrading a partitioned instance.
- /p:instance-profile-path**
Specifies the new instance profile path for the upgraded instance.
- /q** Issues the `db2iupgrade` command in quiet mode.
- /a:authType**
Specifies the authentication type (SERVER, CLIENT, or SERVER_ENCRYPT) for the instance.
- /j "TEXT_SEARCH"**
Configures the DB2 Text Search server using generated default values for service name and TCP/IP port number. This parameter cannot be used if the instance type is *client*.
- /j "TEXT_SEARCH, servicename"**
Configures the DB2 Text Search server using the provided service name and an automatically generated port number. If the service name has a port number assigned in the services file, it uses the assigned port number.
- /j "TEXT_SEARCH, servicename, portnumber"**
Configures the DB2 Text Search server using the provided service name and port number.

/j "TEXT_SEARCH, portnumber"

Configures the DB2 Text Search server using a default service name and the provided port number. Valid port numbers must be within the 1024 - 65535 range.

/? Displays usage information for the db2iupgrade command.

Usage notes

For Linux and UNIX systems

- The db2iupgrade command removes any symbolic links that exist in `/usr/lib` and `/usr/include` in version you are upgrading from. If you have applications that load `libdb2` directly from `/usr/lib` rather than using the operating system's library environment variable to find it, your applications might fail to execute properly after you have run the db2iupgrade command.
- If you use the db2iupgrade command to upgrade a DB2 instance from a previous version to the current version of a DB2 database system, the DB2 Global Profile Variables defined in an old DB2 database installation path will not be upgraded over to the new installation location. The DB2 Instance Profile Variables specific to the instance to be upgraded will be carried over after the instance is upgraded.
- If you are using the `su` command instead of the `login` command to become the root user, you must issue the `su` command with the `-` option to indicate that the process environment is to be set as if you had logged in to the system using the `login` command.
- You must not source the DB2 instance environment for the root user. Running the db2iupgrade command when you sourced the DB2 instance environment is not supported.
- On UNIX and Linux operating systems, if the IBM Tivoli Monitoring for Databases: DB2 Agent is installed and the DB2 instance is upgraded, the Monitoring Agent for DB2 instance is also created if the following are true:
 - The DB2 instance type is standalone, wse, or ese.
 - The DB2 instance is at version 9.5 (or higher).

In addition, ITMA must already be installed for the DB2 copy you are updating the instance for. Located in `DB2DIR/itma` directory, where `DB2DIR` represents the directory where the DB2 product is installed.

- On AIX 6.1 (or higher), when running this command from a shared DB2 copy in a system workload partition (WPAR) global environment, this command must be run as the root user.

For Windows operating systems

- On Windows operating systems, if the IBM Tivoli Monitoring for Databases: DB2 Agent is installed and the DB2 copy instance is updated, the Monitoring Agent for DB2 instance is also created if the following are true:
 - The DB2 instance type is standalone, wse, or ese.
 - The default DB2 copy has the ITM agent component installed.
 - The DB2 instance is at version 9.5 (or higher).
 - There is no existing ITM for Databases product.

In addition, the following are also created after the creation of the Monitoring Agent for DB2 instance: the Monitoring Agent for DB2 instance files, the NT service and the registry entries.

Chapter 214. db2inidb - Initialize a mirrored database

Initializes a mirrored database in a split mirror environment. The mirrored database can be initialized as a clone of the primary database, placed in roll forward pending state, or used as a backup image to restore the primary database. This command can only be run against a split mirror database, and it must be run before the split mirror can be used.

Authorization

One of the following:

- *sysadm*
- *sysctrl*
- *sysmaint*

Required connection

None

Command syntax

```
▶▶ db2inidb database_alias AS 

|          |
|----------|
| SNAPSHOT |
| STANDBY  |
| MIRROR   |

 RELOCATE USING configFile ▶▶
```

Command parameters

database_alias

Specifies the alias of the database to be initialized.

SNAPSHOT

Specifies that the mirrored database will be initialized as a clone of the primary database.

STANDBY

Specifies that the database will be placed in roll forward pending state. New logs from the primary database can be fetched and applied to the standby database. The standby database can then be used in place of the primary database if it goes down.

MIRROR

Specifies that the mirrored database is to be used as a backup image which can be used to restore the primary database.

RELOCATE USING *configFile*

Specifies that the database files are to be relocated based on the information listed in the specified *configFile* prior to initializing the database as a snapshot, standby, or mirror. The format of *configFile* is described in Chapter 245, "db2relocatedb - Relocate database," on page 1023.

Usage notes

Do not issue the `db2 connect to database-alias` operation before issuing the `db2inidb database-alias` as mirror command. Attempting to connect to a split mirror database before initializing it erases the log files needed during roll forward recovery. The connect sets your database back to the state it was in when you suspended the database. If the database is marked as consistent when it was suspended, the DB2 database system concludes there is no need for crash recovery and empties the logs for future use. If the logs have been emptied, attempting to roll forward results in the SQL4970N error message being returned.

In a partitioned database environment, `db2inidb` must be run on every database partition before the split mirror from any of the database partitions can be used. `db2inidb` can be run on all database partitions simultaneously using the `db2_all` command.

If, however, you are using the `RELOCATE USING` option, you cannot use the `db2_all` command to run `db2inidb` on all of the partitions simultaneously. A separate configuration file must be supplied for each partition, that includes the `NODENUM` value of the database partition being changed. For example, if the name of a database is being changed, every database partition will be affected and the `db2relocatedb` command must be run with a separate configuration file on each database partition. If containers belonging to a single database partition are being moved, the `db2relocatedb` command only needs to be run once on that database partition.

If the `RELOCATE USING configFile` parameter is specified and the database is relocated successfully, the specified `configFile` will be copied into the database directory and renamed to `db2path.cfg`. During a subsequent crash recovery or rollforward recovery, this file will be used to rename container paths as log files are being processed.

If a clone database is being initialized, the specified `configFile` will be automatically removed from the database directory after a crash recovery is completed.

If a standby database or mirrored database is being initialized, the specified `configFile` will be automatically removed from the database directory after a rollforward recovery is completed or canceled. New container paths can be added to the `db2path.cfg` file after `db2inidb` has been run. This would be necessary when `CREATE` or `ALTER TABLESPACE` operations are done on the original database and different paths must be used on the standby database.

Chapter 215. db2inspf - Format inspect results

This utility formats the data from INSPECT CHECK results into ASCII format. Use this utility to see details of the inspection. The formatting by the db2inspf utility can be for a table or a table space, and errors, warnings, and summary can be specified either alone or in any combination thereof.

Authorization

Anyone can access the utility, but users must have read permission on the results file in order to execute this utility against them.

Required connection

None

Command syntax

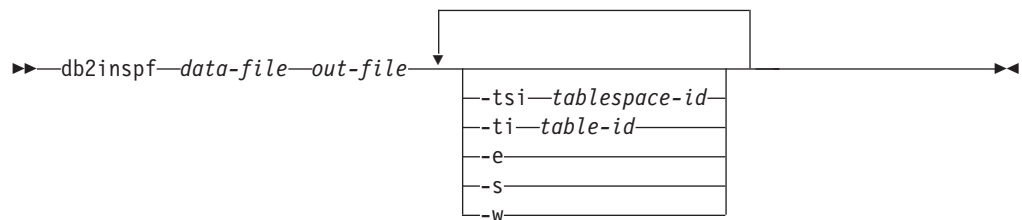

Command Parameters

data-file

The unformatted inspection results file to format.

out-file

The output file for the formatted output.

-tsi *table-space-id*

Table space ID. Format out only for tables in this table space.

-ti *table-id*

Table ID. Format out only for table with this ID, table space ID must also be provided.

-e Format out errors only.

-s Summary only.

-w Warnings only.

Examples

To format all errors, warnings and summaries from the data file tbschk.log, execute the following:

```
db2inspf tbschk.log tbschk_esw.txt -e -s -w
```

Chapter 216. db2iprune - Reduce installation image size command

The db2iprune command can reduce the size of your DB2 product installation image prior to installation.

This tool is useful for large-scale deployments of DB2, as well as for embedding DB2 within an application. Using the input file, or .prn file, which contains a full list of removable products, components, and languages, you can specify what you would like to remove from the installation image. The db2iprune command calls the input file and removes the files associated with those components and languages. The result is a new, smaller DB2 installation image that can be installed using the regular DB2 installation methods.

You cannot prune all products. At a minimum, one product must be still part of the resulting image.

Authorization

None

Required connection

None

Command syntax

```
▶▶ db2iprune --r input_file_path --p root_directory_path
▶ [ -o destination_directory_path ] [ -c ] [ -t trace_file ]
▶ [ -l log_filename ] [ -h ] [ -? ]
```

Command parameters

-r *input_file_path*

Specifies the full path to the input file that is to be used. The input file, or .prn file, contains a full list of removable components and is used to indicate which products, components, and languages you would like to remove from the installation image.

-p *root_directory_path*

(On Windows operating systems only.) Specifies the full path to the root directory of the source installation image. This directory contains setup and is the root directory of the DB2 installation DVD.

-o *destination_directory_path*

Specifies the full path to where the new DB2 pruned image is copied. Make sure that you have write access to this directory.

- c Specifies that you want to prune the source installation image directly. Ensure that the source installation image directory is writable.
- l Enables error logging. On Linux and UNIX operating systems, if the -l option is not specified, the default log file name is tmpdir/db2iprune_username.log. On Windows operating systems, the log file db2iprune.log is written to the destination directory.
- t *trace_file*
(On Linux and UNIX operating systems only.) Turns on the debug mode. The debug information is written to the file name specified.
- ? | -h Displays the usage information.

Examples

On Windows operating systems, to prune an IBM Data Server Client image where the input file is located in `c:\db2client.prn`, the DB2 `setup.exe` file is located in `d:\`, and you want your pruned IBM Data Server Client image to be copied to the `e:\compact_client` directory, you would enter the following command at the command prompt:

```
db2iprune.exe -r c:\db2client.prn -p d:\ -o e:\compact_client
```

On Linux and UNIX operating systems, to prune a IBM Data Server Client image where the input file is located in `/tmp/db2client.prn`, the DB2 source files are located on `/mnt/cdrom`, and you want your pruned IBM Data Server Client image to be copied to the `/compact_client` directory, you would enter the following command at the command prompt:

```
db2iprune -r /tmp/db2client.prn /mnt/cdrom -o /compact_client
```

Usage notes

The `db2iprune` command and sample input files are provided on the installation DVD:

On Windows operating systems

```
dvd_drive:\db2\Windows\utilities\db2iprune
```

On Linux and UNIX operating systems

```
product_image/db2/platform/utilities/db2iprune
```

Chapter 217. db2isetup - Start instance creation interface

Starts the DB2 Instance Setup wizard, a graphical tool for creating instances and for configuring new functionality on existing instances.

Authorization

For root installations, root authority is required on the system where the command is issued. For non-root installations, you must log on with the user ID that owns the non-root installation.

Required connection

None

Command syntax

```
db2isetup [-i language-code] [-l logfile] [-t tracefile]
           [-r response_file] [--?] [-h]
```

Command parameters

-i *language-code*

Two letter code for the preferred language in which to run the install. If unspecified, this parameter will default to the locale of the current user.

-l *logfile*

Writes the log to the file name specified. For root installations, the path and filename default to `/tmp/db2isetup.log`. For non-root installations, the default log file is `/tmp/db2isetup_userID.log`, where *userID* represents the user ID that owns the non-root installation.

-t *tracefile*

The full path and name of trace file specified by *tracefile*.

-r *response_file*

Full path and file name of the response file to use. The response file must contain the keyword FILE.

-? | **-h** Output usage information.

Usage notes

1. This instance setup wizard provides a subset of the functionality provided by the DB2 Setup wizard. The DB2 Setup wizard (which runs from the installation media) allows you to install DB2 components, do system setup tasks such as DAS creation/configuration, and set up instances. The DB2 Instance Setup wizard only provides the functionality pertaining to instance setup.
2. The executable file for this command is located in the `DB2DIR/instance` directory. It is available in a typical install, but not in a compact install.
3. `db2isetup` runs on all supported Linux and UNIX systems.

4. On AIX 6.1 (or higher), when running this command from a shared DB2 copy in a system workload partition (WPAR) global environment, this command must be run as the root user.

Chapter 218. db2iupdt - Update instances

This command updates an instance to run on a DB2 copy that has a new DB2 database product or feature installed, to run on a DB2 copy of the same version as the DB2 copy associated with the instance, or to upgrade the instance type to a higher level instance type.

The db2iupdt command can be issued against instances of the same version that are associated with the same or a different DB2 copy. In all cases, it will update the instance so that it runs against the code located in the same DB2 copy as where you issued the db2iupdt command. You should issue this command:

- if you install a fix pack and the automatic instance update fails.
- if you install a new DB2 database product or feature to the DB2 copy associated to the DB2 instance.
- if you want to update a DB2 instance from one DB2 copy to another DB2 copy of the same version of DB2 database product.

After a fix pack is installed on Linux and UNIX operating systems, the db2iupdt command is executed automatically.

To update an instance with db2iupdt, you must first stop all processes that are running for the instance.

Authorization

Root access on UNIX and Linux operating systems or Local Administrator on Windows operating systems.

Command syntax

For UNIX and Linux operating systems

```
db2iupdt [-h] [-d] [-k] [-D] [-s] [-a AuthType]
          [-u FencedID] [-e InstName]
```

For Windows operating systems

```
db2iupdt -InstName /u:username,password /p:instance-profile-path
          /r:baseport,endport /h:hostname /s /q
          /a:authType /j:"TEXT_SEARCH ,servicename ,portnumber"
```

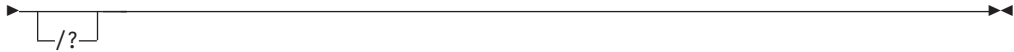

Command parameters

For UNIX and Linux operating systems

- h** | **-?** Displays the usage information.
- d** Turns debug mode on.
- k** Keeps the current instance type during the update.
- D** Moves an instance from a higher code level on one path to a lower code level installed on another path.
- s** Ignores the existing SPM log directory.
- a** *AuthType*
Specifies the authentication type (SERVER, SERVER_ENCRYPT or CLIENT) for the instance. The default is SERVER.
- u** *Fenced ID*
Specifies the name of the user ID under which fenced user defined functions and fenced stored procedures will run. This option is only needed when converting an instance from a client instance to a non-client instance type. To determine the current instance type, refer to the node type parameter in the output from a GET DBM CFG command. If an instance is already a non-client instance, or if an instance is a client instance and is staying as a client instance (for example, by using the **-k** option), the **-u** option is not needed. The **-u** option cannot change the fenced user for an existing instance.

InstName
Specifies the name of the instance.

- e** Updates every instance.

For Windows operating systems

InstName
Specifies the name of the instance.

/u:*username,password*
Specifies the account name and password for the DB2 service.

/p:*instance-profile-path*
Specifies the new instance profile path for the updated instance.

/r:*baseport,endport*
Specifies the range of TCP/IP ports to be used by the partitioned database instance when running in MPP mode. When this option is specified, the services file on the local machine will be updated with the following entries:

```
DB2_InstName      baseport/tcp
DB2_InstName_END  endport/tcp
```

/h:*hostname*
Overrides the default TCP/IP host name if there are more than one TCP/IP host names for the current machine.

- /s** Updates the instance to a partitioned instance.

/q Issues the db2iupdt command in quiet mode.

/a:authType

Specifies *authType*, the authentication type (SERVER, CLIENT, or SERVER_ENCRYPT) for the instance.

/j "TEXT_SEARCH"

Configures the DB2 Text Search server using generated default values for service name and TCP/IP port number. This parameter cannot be used if the instance type is *client*.

/j "TEXT_SEARCH, servicename"

Configures the DB2 Text Search server using the provided service name and an automatically generated port number. If the service name has a port number assigned in the services file, it uses the assigned port number.

/j "TEXT_SEARCH, servicename, portnumber"

Configures the DB2 Text Search server using the provided service name and port number.

/j "TEXT_SEARCH, portnumber"

Configures the DB2 Text Search server using a default service name and the provided port number. Valid port numbers must be within the 1024 - 65535 range.

/? Displays usage information for the db2iupdt command.

Examples (UNIX and Linux)

- An instance, db2inst2, is associated to a DB2 copy of DB2 database product installed at *DB2DIR1*. You have another DB2 copy of DB2 database product on the same computer at *DB2DIR2* for the same version of the DB2 database product as that installed on *DB2DIR1*. To update the instance to run from the DB2 copy installed at *DB2DIR1* to the DB2 copy installed at *DB2DIR2*, issue the following command:

```
DB2DIR2/instance/db2iupdt db2inst2
```

If the DB2 copy installed at *DB2DIR2* is at level lower than the DB2 copy installed at *DB2DIR1*, issue:

```
DB2DIR2/instance/db2iupdt -D db2inst2
```

Usage notes

For all supported operating systems

- If you use the db2iupdt command to update a DB2 instance from one DB2 copy to another DB2 copy of the same version of DB2 database product, the DB2 Global Profile Variables defined in an old DB2 copy installation path will not be updated over to the new installation location. The DB2 Instance Profile Variables specific to the instance will be carried over after the instance is updated.

For UNIX and Linux operating systems

- The db2iupdt command is located in the *DB2DIR/instance* directory, where *DB2DIR* is the location where the current version of the DB2 database product is installed.
- If you want to update a non-root instance, refer to the db2nrupdt non-root-installed instance update command. The db2iupdt does not support updating of non-root instances.

- If you are using the su command instead of the login command to become the root user, you must issue the su command with the - option to indicate that the process environment is to be set as if you had logged in to the system using the login command.
- You must not source the DB2 instance environment for the root user. Running db2iupdt when you sourced the DB2 instance environment is not supported.
- On UNIX and Linux operating systems, if the IBM Tivoli Monitoring for Databases: DB2 Agent is installed and the DB2 instance is updated, the Monitoring Agent for DB2 instance is also created if the following are true:
 - The DB2 instance type is standalone, wse, or ese.
 - The DB2 instance is at version 9.5 (or higher).

In addition, ITMA must already be installed for the DB2 copy you are updating the instance. Located in DB2DIR/itma directory, where DB2DIR represents the directory where the DB2 product is installed.

- On AIX 6.1 (or higher), when running this command from a shared DB2 copy in a system workload partition (WPAR) global environment, this command must be run as the root user.

For Windows operating systems

- The db2iupdt command is located in the *DB2PATH*\bin directory, where *DB2PATH* is the location where the current version of the DB2 database product is installed.
- The instance is updated to the DB2 copy from which you issue the db2iupdt command. However, to move your instance profile from its current location to another location, use the */p* option and specify the instance profile path. Otherwise, the instance profile will stay in its original location after the instance update. Use the db2iupgrade command instead to upgrade to the current release from a previous release.
- On Windows operating systems, if the IBM Tivoli Monitoring for Databases: DB2 Agent is installed and the DB2 copy instance is updated, the Monitoring Agent for DB2 instance is also created if the following are true:
 - The DB2 instance type is standalone, wse, or ese.
 - The default DB2 copy has the ITM agent component installed.
 - The DB2 instance is at version 9.5 (or higher).
 - There is no existing ITM for Databases product.

In addition, the following are also created after the creation of the Monitoring Agent for DB2 instance: the Monitoring Agent for DB2 instance files, the NT service and the registry entries.

Chapter 219. db2jdbcbind - DB2 JDBC package binder

This utility is used to bind or rebind the JDBC packages to a DB2 database. DB2 Version 8 databases already have the JDBC packages preinstalled, therefore, this command is usually necessary only for earlier servers. JDBC and CLI share the same packages. If the CLI packages have already been bound to a database, then it is not necessary to run this utility and vice versa.

Authorization

One of the following:

- *dbadm*
- BINDADD privilege if a package does not exist, and one of:
 - IMPLICIT_SCHEMA authority on the database if the schema name of the package does not exist
 - CREATEIN privilege on the schema if the schema name of the package exists
- ALTERIN privilege on the schema if the package exists
- BIND privilege on the package if it exists

Required connection

This command establishes a database connection.

Command syntax

```
▶ db2jdbcbind help -url jdbc:db2://servername:portnumber/dbname
▶ -user username -password password -collection collection ID
▶ -size number of packages
```

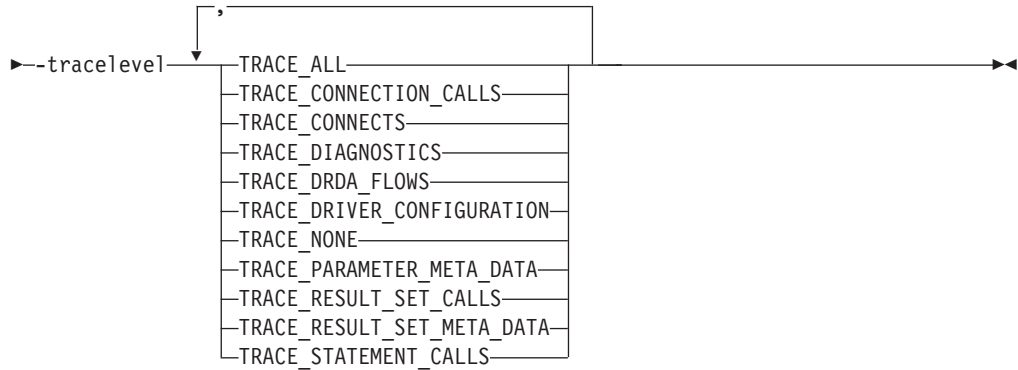

Command parameters

- help** Displays help information, all other options are ignored.
- url** *jdbc:db2://servername:portnumber/dbname*
Specifies a JDBC URL for establishing the database connection. The DB2 JDBC type 4 driver is used to establish the connection.
- user** *username*
Specifies the name used when connecting to a database.
- password** *password*
Specifies the password for the user name.
- collection** *collection ID*
The collection identifier (CURRENT PACKAGESET), to use for the packages. The default is NULLID. Use this to create multiple instances of the package set. This option can only be used in conjunction with the Connection or DataSource property `currentPackageSet`.
- size** *number of packages*
The number of internal packages to bind for each DB2 transaction isolation level and holdability setting. The default is 3. Since there are four DB2 isolation levels and two cursor holdability settings, there will be $4 \times 2 = 8$ times as many dynamic packages bound as are specified by this option. In addition, a single static package is always bound for internal use.
- tracelevel**
Identifies the level of tracing, only required for troubleshooting.

Chapter 220. db2ldcfg - Configure LDAP environment

Configures the Lightweight Directory Access Protocol (LDAP) user distinguished name (DN) and password for the current logon user in an LDAP environment using an IBM LDAP client.

Authorization

None

Required connection

None

Command syntax

```
▶▶ db2ldcfg -u userDN -w password -r
```

Command parameters

-u *userDN*

Specifies the LDAP user's Distinguished Name to be used when accessing the LDAP directory. As shown in the example below, the Distinguished name has several parts: the user ID, such as *jdoue*, the domain and organization names and the suffix, such as *com* or *org*.

-w *password*

Specifies the password.

-r Removes the user's DN and password from the machine environment.

Example:

```
db2ldcfg -u "uid=jdoue,dc=mydomain,dc=myorg,dc=com" -w password
```

Usage notes

In an LDAP environment using an IBM LDAP client, the default LDAP user's DN and password can be configured for the current logon user. Once configured, the LDAP user's DN and password are saved in the user's environment and used whenever DB2 accesses the LDAP directory. This eliminates the need to specify the LDAP user's DN and password when issuing the LDAP command or API. However, if the LDAP user's DN and password are specified when the command or API is issued, the default settings will be overridden.

This command can only be run when using an IBM LDAP client. On a Microsoft LDAP client, the current logon user's credentials will be used.

Chapter 221. db2level - Show DB2 service level

Shows the current Version and Service Level of the installed DB2 product. Output from this command goes to the console by default.

Authorization

None

Required Connection

None

Command Syntax

►►—db2level—————►►

Command parameters

None

Examples

On Windows operating systems, the db2level command shows the DB2 copy name. For example:

```
DB21085I Instance "DB2" uses "32" bits and DB2 code release "SQL09010" with
level identifier "01010107".
Informational tokens are "DB2 v9.1.0.189", "n060119", "", and Fix Pack "0".
Product is installed at "c:\SQLLIB" with DB2 Copy Name "db2build".
```

On Linux and UNIX based operating systems, the db2level command does not show the DB2 copy name. For example:

```
DB21085I Instance "wqzhuang" uses "64" bits and DB2 code release "SQL09010"
with level identifier "01010107".
Informational tokens are "DB2 v9.1.0.0", "n060124", "", and Fix Pack "0".
Product is installed at "/home/wqzhuang/sqllib".
```

Usage notes

The information output by the command includes Release, Level, and various informational tokens.

Chapter 222. db2licm - License management tool

Performs basic license functions in the absence of the Control Center. Adds, removes, lists, and modifies licenses and policies installed on the local system.

Note: Under the processor Value Unit (PVU) licensing structure, each processor core will be assigned a specific number of Value Units. You must acquire the total number of processor Value Units for each processor core on which the software programs are deployed. IBM continues to define a processor to be each processor core on a chip. For example, a dual-core chip contains two processor cores.

Each software program has a unique price per Value Unit. To determine the total cost of deploying an individual software program, you multiply the program price per Value Unit by the total number of processor Value Units required.

Authorization

On Windows operating systems:

- You must belong to the local Administrators or Power Users group to use the **-a**, **-r**, or **-x** command parameters.
- SYSADM authority is required to use the **-c**, **-e**, **-p**, **-r**, or **-u** command parameters.

On UNIX and Linux operating systems, no authority is required.

Required connection

None

Command syntax

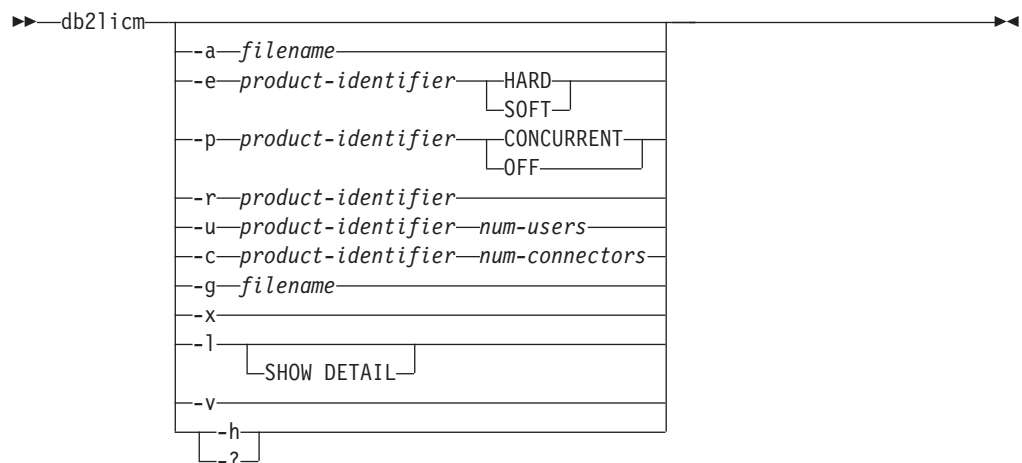

Command parameters

-a filename

Adds a license for a product. Specify a file name containing valid license

information. This can be obtained from your licensed product CD or by contacting your IBM representative or authorized dealer.

- c *product-identifier num-connectors*
Updates the number of connector entitlements that have been purchased. Specify the product identifier and the number of connector entitlements.
- e *product-identifier*
Updates the enforcement policy on the system. Valid values are:
 - HARD**
Specifies that unlicensed requests will not be allowed.
 - SOFT** Specifies that unlicensed requests will be logged but not restricted.
- g *filename*
Generates compliance report. Specify file name where output is to be stored.
- h | -? Displays help information. When this option is specified, all other options are ignored, and only the help information is displayed.
- l Lists all the products with available license information, including the product identifier.
 - SHOW DETAIL**
Specify to view detailed information about licensed features (if any).
- p *product-identifier*
Updates the license policy type to use on the system.
 - CONCURRENT**
Specify for concurrent user policy.
 - OFF** Specify to turn off all policies.
- r *product-identifier*
Removes the license for a product. To get the product identifier for a specific product, invoke the command with the -l option.
- u *product-identifier num-users*
Updates the number of user licenses that the customer has purchased. Specify the product identifier and the number of users.
- v Displays version information.
- x Resets license compliance information for the purposes of license compliance report.

Examples

```
db2licm -a db2ese.lic
db2licm -p db2consv concurrent
db2licm -r db2ese
db2licm -u db2wse 10
db2licm -e db2ese SOFT
```

Output example listing all the products with available license information, including the product identifier:

```
C:\Program Files\IBM\SQLLIB\BIN>db2licm -l
Product name:          "DB2 Enterprise Server Edition"
License type:          "Trial"
Expiry date:           "08/31/2009"
Product identifier:    "db2ese"
Version information:   "9.7"
```

Chapter 223. db2listvolumes - Display GUIDs for all disk volumes

Displays the GUIDs for all the disk volumes defined on a Windows operating system. This command creates two files in the directory where the tool is issued from. One file, called `volumes.xml`, contains information about each disk volume encoded in XML for easy viewing on an XML-enabled browser. The second file, called `tablespace.ddl`, contains the required syntax for specifying table space containers. This file must be updated to fill in the remaining information needed for a table space definition. The `db2listvolumes` command does not require any command line arguments. It is only available on Windows operating systems.

Authorization

Administrator

Required Connection

None

Command syntax

►►—`db2listvolumes`—————►►

Command parameters

None

Chapter 224. db2logsforrwd - List logs required for rollforward recovery

Parses the DB2TSCHG.HIS file. This utility allows a user to find out which log files are required for a table space rollforward operation. This utility is located in sqllib/bin.

Authorization

None

Required connection

None

Command syntax

```
▶▶ db2logsforrwd path -all ▶▶
```

Command parameters

path Full path and name of the DB2TSCHG.HIS file.

-all Displays more detailed information.

Examples

```
db2logsForRfwd /home/ofer/ofer/NODE0000/S0000001/DB2TSCHG.HIS
```

```
db2logsForRfwd DB2TSCHG.HIS -all
```

Chapter 225. db2look - DB2 statistics and DDL extraction tool

Extracts the required Data Definition Language (DDL) statements to reproduce the database objects of a production database on a test database. The db2look command generates the DDL statements by object type.

This tool can generate the required UPDATE statements used to replicate the statistics on the objects in a test database. It can also be used to generate the UPDATE DATABASE CONFIGURATION and UPDATE DATABASE MANAGER CONFIGURATION commands and the db2set commands so that query optimizer-related configuration parameters and registry variables on the test database match those of the production database.

It is often advantageous to have a test system contain a subset of the production system's data. However, access plans selected for such a test system are not necessarily the same as those that would be selected for the production system. Both the catalog statistics and the configuration parameters for the test system must be updated to match those of the production system. Using this tool makes it possible to create a test database where access plans are similar to those that would be used on the production system.

You should check the DDL statements generated by the db2look command since they might not exactly reproduce all characteristics of the original SQL objects. For table spaces on partitioned database environments, DDL might not be complete if some database partitions are not active. Make sure all database partitions are active using the ACTIVATE command.

Authorization

SELECT privilege on the system catalog tables.

In some cases, such as generating table space container DDL, you will require one of the following:

- *sysadm*
- *sysctrl*
- *sysmaint*
- *sysmon*
- *dbadm*

Required connection

None

Command syntax

```
►► db2look --d DBname [-e] [-u Creator] [-z schema]
```

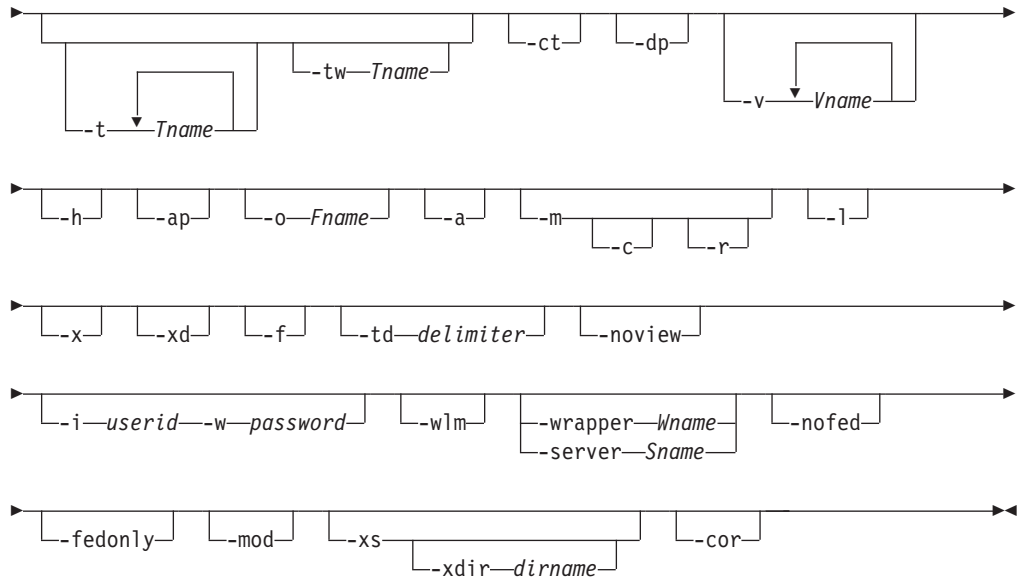

Command parameters

-d *DBname*

Alias name of the production database that is to be queried. *DBname* can be the name of a DB2 Database for Linux, UNIX, and Windows or DB2 Version 9.1 for z/OS (DB2 for z/OS) database. If the *DBname* is a DB2 for z/OS database, the db2look utility will extract the DDL and UPDATE statistics statements for OS/390 and z/OS objects. These DDL and UPDATE statistics statements are statements applicable to a DB2 Database for Linux, UNIX, and Windows database and not to a DB2 for z/OS database. This is useful for users who want to extract OS/390 and z/OS objects and recreate them in a DB2 Database for Linux, UNIX, and Windows database.

If *DBname* is a DB2 for z/OS database, the output of the db2look command is limited to the following:

- Generate DDL for tables, indexes, views, and user-defined distinct types
- Generate UPDATE statistics statements for tables, columns, column distributions and indexes

-e

Extract DDL statements for database objects. DDL for the following database objects are extracted when using the -e option:

- Audit policies
- Schemas
- Tables (including the inline length if at least one exists for the table, and the partition level INDEX IN clause for a partitioned table)
- Views
- Materialized query tables (MQT)
- Aliases
- Indexes (including partitioned indexes on partitioned tables)
- Triggers
- Sequences
- User-defined distinct types
- Primary key, referential integrity, and check constraints

- User-defined structured types
- User-defined functions
- User-defined methods
- User-defined transforms
- Wrappers
- Servers
- User mappings
- Nicknames
- Type mappings
- Function templates
- Function mappings
- Index specifications
- Stored procedures
- Roles
- Trusted contexts
- Global variables
- Security label components
- Security policies
- Security labels

The DDL generated by the db2look command can be used to recreate user-defined functions successfully. However, the user source code that a particular user-defined function references (the EXTERNAL NAME clause, for example) must be available in order for the user-defined function to be usable.

-u *Creator*

Creator ID. Limits output to objects with this creator ID. If option -a is specified, this parameter is ignored. The output will not include any inoperative objects. To display inoperative objects, use the -a option.

-z *schema*

Schema name. Limits output to objects with this schema name. The output will not include any inoperative objects. To display inoperative objects, use the -a option. If this parameter is not specified, objects with all schema names are extracted. If the -a option is specified, this parameter is ignored. This option is ignored for the federated DDL.

-t *Tname1 Tname2 ... TnameN*

Table name list. Limits the output to particular tables in the table list. The maximum number of tables is 30. Table names are separated by a blank space. Case-sensitive names and double-byte character set (DBCS) names must be enclosed inside a backward slash and double quotation delimiter, for example, \`MyTable` \". For multiple-word table names, the delimiters must be placed within quotation marks (for example, \"`My Table`\") to prevent the pairing from being evaluated word-by-word by the command line processor. If a multiple-word table name is not enclosed by the backward slash and double delimiter (for example, `My Table`), all words will be converted into uppercase and the db2look command will look for an uppercase table (for example, `MY TABLE`). When -t is used with -l, the combination does support partitioned tables in DB2 Version 9.5.

-tw *Tname*

Generates DDL for table names that match the pattern criteria specified by

Tname. Also generates the DDL for all dependent objects of all returned tables. *Tname* can be a single value only. The underscore character (_) in *Tname* represents any single character. The percent sign (%) represents a string of zero or more characters. Any other character in *Tname* only represents itself. When *-tw* is specified, the *-t* option is ignored.

- ct** Generate DDL by object creation time. Generating DDL by object creation time will not guarantee that all the object DDLs will be displayed in correct dependency order. The *db2look* command only supports the following options if the *-ct* option is also specified: *-e*, *-a*, *-u*, *-z*, *-t*, *-tw*, *-v*, *-l*, *-noview*, *-wlm*.
- dp** Generate DROP statement before CREATE statement. The DROP statement might not work if there is an object that depends on the dropped object. For example, dropping a schema will fail if there is a table that depends on the dropped schema, or dropping a user-defined type/function will fail if there is any other type, function, trigger, or table that depends on it. For typed tables, the DROP TABLE HIERARCHY statement will be generated for the root table only. A DROP statement is not generated for index, primary and foreign keys, and constraints, because they are always dropped when the table is dropped. When a table has the RESTRICT ON DROP attribute, it cannot be dropped.
- v** *Vname1 Vname2 ... VnameN*
Generates DDL for the specified views. The maximum number of views is 30. If the *-t* option is specified, the *-v* option is ignored. The rules governing case-sensitive, DBCS, and multiple-word table names also apply to view names.
- h** Display help information. When this option is specified, all other options are ignored, and only the help information is displayed.
- ap** Generates the required AUDIT USING statements to associate audit policies with other database objects.
- o** *Fname*
Write the output to *filename.sql*. If this option is not specified, output is written to standard output. If a filename is specified with an extension, the output will be written into that file.
- a** When this option is specified the output is not limited to the objects created under a particular creator ID. All objects, including inoperative objects, created by all users are considered. For example, if this option is specified with the *-e* option, DDL statements are extracted for all objects in the database. If this option is specified with the *-m* option, UPDATE statistics statements are extracted for all user created tables and indexes in the database. If neither *-u* nor *-a* is specified, the environment variable USER is used. On UNIX operating systems, this variable does not have to be explicitly set; on Windows systems, however, there is no default value for the USER environment variable: a user variable in the SYSTEM variables must be set, or a set *USER=username* must be issued for the session.
- m** Generates the required UPDATE statements to replicate the statistics on tables, statistical views, columns and indexes.
 - c** When this option is specified in conjunction with the *-m* option, the *db2look* command does not generate COMMIT, CONNECT and CONNECT RESET statements. The default action is to generate these statements.

-r When this option is specified in conjunction with the **-m** option, the **db2look** command does not generate the **RUNSTATS** command. The default action is to generate the **RUNSTATS** command.

Note: If you intend to run the command processor script created using **db2look** in mimic mode (**-m** option) against another database (for example, to make the catalog statistics of the test database match those in production), both databases must use the same codeset and territory.

-l If this option is specified, then the **db2look** command will generate DDL for user defined table spaces, database partition groups and buffer pools. DDL for the following database objects is extracted when using the **-l** option:

- User-defined table spaces
- User-defined database partition groups
- User-defined buffer pools

-x If this option is specified, the **db2look** command will generate authorization DDL (**GRANT** statement, for example).

The supported authorizations include:

- Table: ALTER, SELECT, INSERT, DELETE, UPDATE, INDEX, REFERENCE, CONTROL
- View: SELECT, INSERT, DELETE, UPDATE, CONTROL
- Index: CONTROL
- Schema: CREATEIN, DROPIN, ALTERIN
- Database: ACCESSCTRL, BINDADD, CONNECT, CREATETAB, CREATE_EXTERNAL_ROUTINE, CREATE_NOT_FENCED_ROUTINE, DATAACCESS, DBADM, EXPLAIN, IMPLICIT_SCHEMA, LOAD, QUIESCE_CONNECT, SECADM, SQLADM, WLMADM
- User-defined function (UDF): EXECUTE
- User-defined method: EXECUTE
- Stored procedure: EXECUTE
- Package: CONTROL, BIND, EXECUTE
- Column: UPDATE, REFERENCES
- Table space: USE
- Sequence: USAGE, ALTER
- Workloads: USAGE
- Global variables
- Role
- Security labels
- Exemptions

-xd If this option is specified, the **db2look** command will generate all authorization DDLs, including authorization DDL for objects whose authorizations were granted by **SYSIBM** at object creation time.

-f Use this option to extract the configuration parameters and registry variables that affect the query optimizer.

-td *delimiter*

Specifies the statement delimiter for SQL statements generated by the **db2look** command. If this option is not specified, the default is the

semicolon (;). It is recommended that this option be used if the `-e` option is specified. In this case, the extracted objects might contain triggers or SQL routines.

-noview

If this option is specified, CREATE VIEW DDL statements will not be extracted.

-i *userid*

Use this option when working with a remote database.

-w *password*

Used with the `-i` option, this parameter allows the user to run the `db2look` command against a database that resides on a remote system. The user ID and the password are used by the `db2look` command to log on to the remote system. If working with remote databases, the remote database must be the same version as the local database. The `db2look` command does not have down-level or up-level support.

-wlm This option generates WLM specific DDL output, which can serve to generate CREATE and ALTER statements for:

- Histograms
- WLM Event Monitors
- Service Classes
- Workloads
- Thresholds
- Work Class Sets
- Work Action Sets

-wrapper *Wname*

Generates DDL statements for federated objects that apply to this wrapper. The federated DDL statements that might be generated include: CREATE WRAPPER, CREATE SERVER, CREATE USER MAPPING, CREATE NICKNAME, CREATE TYPE MAPPING, CREATE FUNCTION ... AS TEMPLATE, CREATE FUNCTION MAPPING, CREATE INDEX SPECIFICATION, and GRANT (privileges to nicknames, servers, indexes). Only one wrapper name is supported; an error is returned if less than one or more than one is specified. This option does not support non-relational data sources.

-server *Sname*

Generates DDL statements for federated objects that apply to this server. The federated DDL statements that might be generated include: CREATE WRAPPER, CREATE SERVER, CREATE USER MAPPING, CREATE NICKNAME, CREATE TYPE MAPPING, CREATE FUNCTION ... AS TEMPLATE, CREATE FUNCTION MAPPING, CREATE INDEX SPECIFICATION, and GRANT (privileges to nicknames, servers, indexes). Only one server name is supported; an error is returned if less than one or more than one is specified. This option does not support non-relational data sources.

-nofed Specifies that no federated DDL statements will be generated. When this option is specified, the `-wrapper` and `-server` options are ignored.

-fedonly

Specifies that only federated DDL statements will be generated.

-mod Generates DDL statements for each module, and for all of the objects that are defined in each module.

- xs Exports all files necessary to register XML schemas and DTDs at the target database, and generates appropriate commands for registering them. The set of XSR objects that will be exported is controlled by the -u, -z, and -a options.
- xdir *dirname* Places exported XML-related files into the given path. If this option is not specified, all XML-related files will be exported into the current directory.
- cor Generates DDL statements with the CREATE OR REPLACE clause, regardless of whether or not the statements originally contained that clause.

Examples

- Generate the DDL statements for objects created by user `walid` in database `DEPARTMENT`. The `db2look` output is sent to file `db2look.sql`:

```
db2look -d department -u walid -e -o db2look.sql
```
- Generate the DDL statements for objects that have schema name `ianhe`, created by user `walid`, in database `DEPARTMENT`. The `db2look` output is sent to file `db2look.sql`:

```
db2look -d department -u walid -z ianhe -e -o db2look.sql
```
- Generate the `UPDATE` statements to replicate the statistics for the database objects created by user `walid` in database `DEPARTMENT`. The output is sent to file `db2look.sql`:

```
db2look -d department -u walid -m -o db2look.sql
```
- Generate both the DDL statements for the objects created by user `walid` and the `UPDATE` statements to replicate the statistics on the database objects created by the same user. The `db2look` output is sent to file `db2look.sql`:

```
db2look -d department -u walid -e -m -o db2look.sql
```
- Generate the DDL statements for objects created by all users in the database `DEPARTMENT`. The `db2look` output is sent to file `db2look.sql`:

```
db2look -d department -a -e -o db2look.sql
```
- Generate the DDL statements for all user-defined database partition groups, buffer pools and table spaces. The `db2look` output is sent to file `db2look.sql`:

```
db2look -d department -l -o db2look.sql
```
- Generate the `UPDATE` statements for optimizer-related database and database manager configuration parameters, as well as the `db2set` statements for optimizer-related registry variables in database `DEPARTMENT`. The `db2look` output is sent to file `db2look.sql`:

```
db2look -d department -f -o db2look.sql
```
- Generate the DDL for all objects in database `DEPARTMENT`, the `UPDATE` statements to replicate the statistics on all tables and indexes in database `DEPARTMENT`, the `GRANT` authorization statements, the `UPDATE` statements for optimizer-related database and database manager configuration parameters, the `db2set` statements for optimizer-related registry variables, and the DDL for all user-defined database partition groups, buffer pools and table spaces in database `DEPARTMENT`. The output is sent to file `db2look.sql`.

```
db2look -d department -a -e -m -l -x -f -o db2look.sql
```
- Generate all authorization DDL statements for all objects in database `DEPARTMENT`, including the objects created by the original creator. (In this case, the authorizations were granted by `SYSIBM` at object creation time.) The `db2look` output is sent to file `db2look.sql`:

```
db2look -d department -xd -o db2look.sql
```

- Generate the DDL statements for objects created by all users in the database DEPARTMENT. The db2look output is sent to file db2look.sql:

```
db2look -d department -a -e -td % -o db2look.sql
```

The output can then be read by the CLP:

```
db2 -td% -f db2look.sql
```

- Generate the DDL statements for objects in database DEPARTMENT, excluding the CREATE VIEW statements. The db2look output is sent to file db2look.sql:

```
db2look -d department -e -noview -o db2look.sql
```
- Generate the DDL statements for objects in database DEPARTMENT related to specified tables. The db2look output is sent to file db2look.sql:

```
db2look -d department -e -t tab1 \"My Tab1E2\" -o db2look.sql
```
- Generate the DDL statements for all objects (federated and non-federated) in the federated database FEDDEPART. For federated DDL statements, only those that apply to the specified wrapper, FEDWRAP, are generated. The db2look output is sent to standard output:

```
db2look -d feddepart -e -wrapper fedwrap
```
- Generate a script file that includes only non-federated DDL statements. The following system command can be run against a federated database (FEDDEPART) and yet only produce output like that found when run against a database which is not federated. The db2look output is sent to a file out.sql:

```
db2look -d feddepart -e -nofed -o out
```
- Generate the DDL statements for objects that have schema name walid in the database DEPARTMENT. The files required to register any included XML schemas and DTDs are exported to the current directory. The db2look output is sent to file db2look.sql:

```
db2look -d department -z walid -e -xs -o db2look.sql
```
- Generate the DDL statements for objects created by all users in the database DEPARTMENT. The files required to register any included XML schemas and DTDs are exported to directory /home/ofer/ofer/. The db2look output is sent to standard output:

```
db2look -d department -a -e -xs -xdir /home/ofer/ofer/
```
- Generate WLM specific DDLs exclusively, in database DEPARTMENT.

```
db2look -d department -wlm
```

Generate the DDLs for all objects in the database DEPARTMENT.

```
db2look -d department -wlm -e -l
```

Usage notes

On Windows operating systems, the db2look command must be run from a DB2 command window.

Several of the existing options support a federated environment. The following db2look command line options are used in a federated environment:

- -ap
When used, AUDIT USING statements are generated.
- -e
When used, federated DDL statements are generated.
- -x
When used, GRANT statements are generated to grant privileges to the federated objects.

- -xd
When used, federated DDL statements are generated to add system-granted privileges to the federated objects.
- -f
When used, federated-related information is extracted from the database manager configuration.
- -m
When used, statistics for nicknames are extracted.
- -wlm
When used, WLM specific DDLs will be output.

The ability to use federated systems needs to be enabled in the database manager configuration in order to create federated DDL statements. After the db2look command generates the script file, you must set the **federated** configuration parameter to YES before running the script.

You need to modify the output script to add the remote passwords for the CREATE USER MAPPING statements.

You need to modify the db2look command output script by adding AUTHORIZATION and PASSWORD to those CREATE SERVER statements that are used to define a DB2 family instance as a data source.

Usage of the -tw option is as follows:

- To both generate the DDL statements for objects in the DEPARTMENT database associated with tables that have names beginning with abc and send the output to the db2look.sql file:

```
db2look -d department -e -tw abc% -o db2look.sql
```

- To generate the DDL statements for objects in the DEPARTMENT database associated with tables that have a d as the second character of the name and to send the output to the db2look.sql file:

```
db2look -d department -e -tw _d% -o db2look.sql
```

- The db2look command uses the LIKE predicate when evaluating which table names match the pattern specified by the *Tname* argument. Because the LIKE predicate is used, if either the _ character or the % character is part of the table name, the backslash (\) escape character must be used immediately before the _ or the %. In this situation, neither the _ nor the % can be used as a wildcard character in *Tname*. For example, to generate the DDL statements for objects in the DEPARTMENT database associated with tables that have a percent sign in the neither the first nor the last position of the name:

```
db2look -d department -e -tw string\%string
```

- Case-sensitive, DBCS, and multi-word table and view names must be enclosed by both a backslash and double quotation marks. For example:

```
\ "My Table"
```

If a multibyte character set (MBCS) or double-byte character set (DBCS) name is not enclosed by the backward slash and double quotation delimiter and if it contains the same byte as the lowercase character, it will be converted into uppercase and db2look will look for a database object with the converted name. As a result, the DDL statement will not be extracted.

- The -tw option can be used with the -x option (to generate GRANT privileges), the -m option (to return table and column statistics), and the -l option (to generate the DDL for user-defined table spaces, database partition groups, and

buffer pools). If the -t option is specified with the -tw option, the -t option (and its associated *Tname* argument) is ignored.

- The -tw option cannot be used to generate the DDL for tables (and their associated objects) that reside on federated data sources, or on DB2 for z/OS, DB2 for i , or DB2 Server for VSE & VM.
- The -tw option is only supported via the CLP.

When requesting DDL on systems using the database partitioning feature, a warning message will be displayed in place of the DDL for table spaces that exist on inactive database partitions. To ensure proper DDL is produced for all table spaces all database partitions must be activated.

When extracting DDL for security label components of type array, the extracted DDL may not generate a security label component whose internal representation (i.e., the encoding of elements in that array) exactly matches the internal representation of that security label component within the database that the db2look extract was taken from. This can happen when a security label component of type array has been altered and one or more elements were added to it. In such cases, data extracted from one table and moved to another table, created from db2look output, will not have corresponding security label values, such that the protection of the new table may be compromised.

Related information

Nickname column and index names

Changing applications for migration

Chapter 226. db2ls - List installed DB2 products and features

Lists the DB2 products and features installed on your Linux and UNIX systems, including the DB2 HTML documentation. With the ability to install multiple copies of DB2 products on your system and the flexibility to install DB2 products and features in the path of your choice, you can use the db2ls command to list:

- where DB2 products are installed on your system and list the DB2 product level.
- all or specific DB2 products and features in a particular installation path.

The db2ls command can be found both in the installation media and in a DB2 install copy on the system. The db2ls command can be run from either location. The db2ls command can be run from the installation media for all products except IBM Data Server Driver Package.

Authorization

None

Required Connection

None

Command syntax

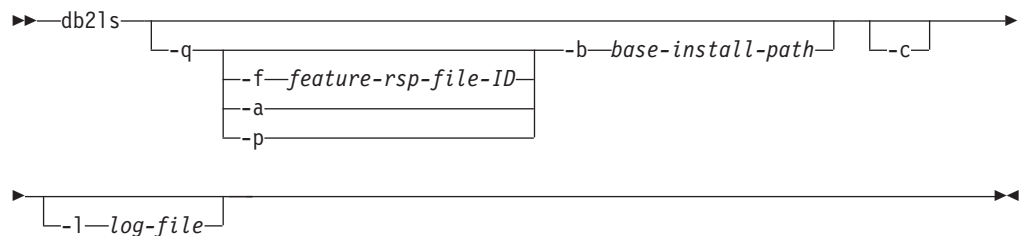

Command parameters

- q** Signifies that the query is to list installed DB2 products and features. By default, only the visible components (features) are displayed unless the **-a** parameter is also specified.
- f feature-rsp-file-ID**
Queries for the specific feature, if it is installed. If it is not installed, the return code from the program is nonzero, otherwise the return code is zero.
- a** Lists all hidden components as well as visible features. The db2ls command only lists visible features by default.
- p** Lists products only. This will give a brief list of which products the customer has installed rather than listing the features.
- b base-install-path**
When using the global db2ls command in `/usr/local/bin`, you need to specify which directory you are querying. The global db2ls command will simply call the db2ls from that install path and pass in the rest of the parameters.

- c Prints the output as a colon-separated list of entries rather than column-based. This allows you to programmatically with this information. The first line of output will be a colon-separated list of tokens to describe each entry. This first line will start with a hash character (“#”) to make it easy to ignore programmatically.
- l *log-file*
Trace log file to use for debugging purposes.

Examples

- To query what DB2 database features are installed to a particular path, issue:
`db2ls -q -b /opt/ibm/ese/v9`
- To see all DB2 database features installed to a particular path, issue:
`db2ls -q -a -b /opt/ibm/ese/v9`
- To check whether a specific DB2 database feature is installed or not, issue:
`db2ls -q -b /opt/ibm/ese/v9 -f <feature>`

Usage notes

- You cannot use the `db2ls` command on Windows operating systems.
- If the root has write permission in `/usr/local/bin` or is able to create `/usr/local/bin`, the symbolic link `/usr/local/bin/db2ls` will be created which points to `DB2DIR/install/db2ls` for the first installation of DB2 Version 9 or later version installed on the system. The root will update the link pointing to the highest version and level of DB2 installed on the system, if multiple copies of DB2 are installed.
A non-root installation will not create or change the `/usr/local/bin/db2ls`. In that case, to run `db2ls`, you have to do one of two things:
 - add `inst_home/sqlllib/install` to the user’s path. Then you can run `db2ls` as the non-root user.
 - pass in the exact path of the command, i.e., `inst_home/sqlllib/install/db2ls`.
- The `db2ls` command is the only method to query a DB2 product at Version 9 or later. You cannot query DB2 products using Linux or UNIX operating system native utilities such as `pkgadd`, `rpm`, `SMIT`, or `swinstall`. Any existing scripts containing a native installation utility that you use to interface and query with DB2 installations will need to change.
- Different feature listings are obtained depending upon the root versus non-root method of DB2 installation and the user running the command.

Without the `-q` option:

- For any user, other than the non-root-install instance user, the command displays all copies installed by the root user.
- For the non-root-install instance user, the command displays all DB2 copies installed by the root user plus the non-root copy owned by the non-root user.

With the `-q` option:

- If userA wants to know if userB has DB2 installed, userA can run `db2ls -q -b $userBHomeDir/sqlllib`. If userA has access permission, then the DB2 features installed by userB will be displayed, otherwise, an error message will be returned indicating that access permission was denied.
- If you run `db2ls -q` without the `-b` option, the installed features in the install path where `db2ls` belongs are displayed.
- If the directory is read-only, the `db2ls` command cannot be linked to from the `/usr/local/bin` directory. If you are running in a system workload partitions

(WPARs) you can use the `db2ls` command located in the installation image root directory to query a list of installed copies.

Chapter 227. db2move - Database movement tool

This tool, when used in the EXPORT/IMPORT/LOAD mode, facilitates the movement of large numbers of tables between DB2 databases located on workstations. The tool queries the system catalog tables for a particular database and compiles a list of all user tables. It then exports these tables in PC/IXF format. The PC/IXF files can be imported or loaded to another local DB2 database on the same system, or can be transferred to another workstation platform and imported or loaded to a DB2 database on that platform. Tables with structured type columns are not moved when this tool is used. When used in the COPY mode, this tool facilitates the duplication of a schema.

Authorization

This tool calls the DB2 export, import, and load APIs, depending on the action requested by the user. Therefore, the requesting user ID must have the correct authorization required by those APIs, or the request will fail.

Command syntax

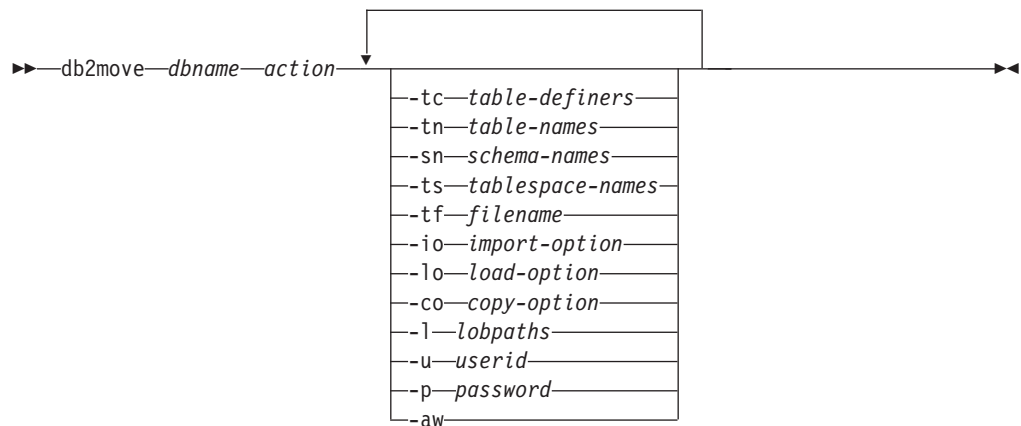

Command parameters

dbname

Name of the database.

action Must be one of:

EXPORT

Exports all tables that meet the filtering criteria in options. If no options are specified, exports all the tables. Internal staging information is stored in the db2move.lst file.

IMPORT

Imports all tables listed in the internal staging file db2move.lst. Use the -io option for IMPORT specific actions.

LOAD

Loads all tables listed in the internal staging file db2move.lst. Use the -lo option for LOAD specific actions.

COPY Duplicates a schema(s) into a target database. Use the `-sn` option to specify one or more schemas. See the `-co` option for COPY specific options. Use the `-tn` or `-tf` option to filter tables in `LOAD_ONLY` mode.

See below for a list of files that are generated during each action.

-tc *table-definers*

The default is all definers.

This is an EXPORT action only. If specified, only those tables created by the definers listed with this option are exported. If not specified, the default is to use all definers. When specifying multiple definers, they must be separated by commas; no blanks are allowed between definer IDs. This option can be used with the `-tn` *table-names* option to select the tables for export.

An asterisk (*) can be used as a wildcard character that can be placed anywhere in the string.

-tn *table-names*

The default is all user tables.

This is an EXPORT or COPY action only.

If specified with the EXPORT action, only those tables whose names match those in the specified string are exported. If not specified, the default is to use all user tables. When specifying multiple table names, they must be separated by commas; no blanks are allowed between table names. Table names should be listed unqualified and the `-sn` option should be used to filter schemas.

For export, an asterisk (*) can be used as a wildcard character that can be placed anywhere in the string.

If specified with the COPY action, the `-co "MODE" LOAD_ONLY copy-option` must also be specified, and only those tables specified will be repopulated on the target database. The table names should be listed with their schema qualifier in the format "schema"."table".

-sn *schema-names*

The default for EXPORT is all schemas (not for COPY).

If specified, only those tables whose schema names match will be exported or copied. If multiple schema names are specified, they must be separated by commas; no blanks are allowed between schema names. Schema names of less than 8 characters are padded to 8 characters in length.

In the case of export: If the asterisk wildcard character (*) is used in the schema names, it will be changed to a percent sign (%) and the table name (with percent sign) will be used in the LIKE predicate of the WHERE clause. If not specified, the default is to use all schemas. If used with the `-tn` or `-tc` option, db2move will only act on those tables whose schemas match the specified schema names and whose definers match the specified definers. A schema name fred has to be specified `-sn fr*d*` instead of `-sn fr*d` when using an asterisk.

-ts *tablespace-names*

The default is all table spaces.

This is an EXPORT action only. If this option is specified, only those tables that reside in the specified table space will be exported. If the asterisk

wildcard character (*) is used in the table space name, it will be changed to a percent sign (%) and the table name (with percent sign) will be used in the LIKE predicate in the WHERE clause. If the -ts option is not specified, the default is to use all table spaces. If multiple table space names are specified, they must be separated by commas; no blanks are allowed between table space names. Table space names less than 8 characters are padded to 8 characters in length. For example, a table space name mytb has to be specified -ts my*b* instead of -sn my*b when using the asterisk.

-tf *filename*

If specified with EXPORT action, only those tables whose names match exactly those in the specified file are exported. If not specified, the default is to use all user tables. The tables should be listed one per line, and each table should be fully qualified. Wildcard characters are not allowed in the strings. Here is an example of the contents of a file:

```
"SCHEMA1"."TABLE NAME1"  
"SCHEMA NAME77"."TABLE155"
```

If specified with the COPY action, the -co "MODE" LOAD_ONLY *copy-option* must also be specified, and only those tables specified in the file will be repopulated on the target database. The table names should be listed with their schema qualifier in the format "schema"."table".

-io *import-option*

The default is REPLACE_CREATE. See "IMPORT command options CREATE and REPLACE_CREATE are deprecated" for limitations of import create function.

Valid options are: INSERT, INSERT_UPDATE, REPLACE, CREATE, and REPLACE_CREATE.

-lo *load-option*

The default is INSERT.

Valid options are: INSERT and REPLACE.

-co When the db2move action is COPY, the following -co follow-on options will be available:

"TARGET_DB db name [USER userid USING password]"

Allows the user to specify the name of the target database and the user/password. (The source database user/password can be specified using the existing -p and -u options). The USER/USING clause is optional. If USER specifies a userid, then the password must either be supplied following the USING clause, or if it's not specified, then db2move will prompt for the password information. The reason for prompting is for security reasons discussed below. TARGET_DB is a mandatory option for the COPY action. The TARGET_DB cannot be the same as the source database. The ADMIN_COPY_SCHEMA procedure can be used for copying schemas within the same database. The COPY action requires inputting at least one schema (-sn) or one table (-tn or -tf).

Running multiple db2move commands to copy schemas from one database to another will result in deadlocks. Only one db2move command should be issued at a time. Changes to tables in the source schema during copy processing may mean that the data in the target schema is not identical following a copy.

"MODE"

DDL_AND_LOAD

Creates all supported objects from the source schema, and populates the tables with the source table data. This is the default option.

DDL_ONLY

Creates all supported objects from the source schema, but does not repopulate the tables.

LOAD_ONLY

Loads all specified tables from the source database to the target database. The tables must already exist on the target. The **LOAD_ONLY** mode requires inputting at least one table using the **-tn** or **-tf** option.

This is an optional option that is only used with the **COPY** action.

“SCHEMA_MAP”

Allows user to rename schema when copying to target. Provides a list of the source-target schema mapping, separated by commas, surrounded by brackets. e.g `schema_map ((s1, t1), (s2, t2))`. This would mean objects from schema `s1` will be copied to schema `t1` on the target; objects from schema `s2` will be copied to schema `t2` on the target. The default, and recommended, target schema name is the source schema name. The reason for this is `db2move` will not attempt to modify the schema for any qualified objects within object bodies. Therefore, using a different target schema name may lead to problems if there are qualified objects within the object body.

For example:`create view F00.v1 as 'select c1 from F00.t1'`

In this case, copy of schema `FOO` to `BAR`, `v1` will be regenerated as:`create view BAR.v1 as 'select c1 from F00.t1'`

This will either fail since schema `FOO` does not exist on the target database, or have an unexpected result due to `FOO` being different than `BAR`. Maintaining the same schema name as the source will avoid these issues. If there are cross dependencies between schemas, all inter-dependant schemas must be copied or there may be errors copying the objects with the cross dependencies.

For example:`create view F00.v1 as 'select c1 from BAR.t1'`

In this case, the copy of `v1` will either fail if `BAR` is not copied as well, or have an unexpected result if `BAR` on the target is different than `BAR` from the source. `db2move` will not attempt to detect cross schema dependencies.

This is an optional option that is only used with the **COPY** action.

“NONRECOVERABLE”

This option allows the user to override the default behavior of the load to be done with **COPY-NO**. With the default behavior, the user will be forced to take backups of each table space that was loaded into. When specifying this **NONRECOVERABLE** keyword, the user will not be forced to take backups of the table spaces immediately. It is, however, highly recommended that the backups be taken as soon as possible to ensure the newly created tables will be properly recoverable. This is an optional option available to the **COPY** action.

“OWNER”

Allows the user to change the owner of each new object created in the target schema after a successful COPY. The default owner of the target objects will be the connect user; if this option is specified, ownership will be transferred to the new owner. This is an optional option available to the COPY action.

“TABLESPACE_MAP”

The user may specify table space name mappings to be used instead of the table spaces from the source system during a copy. This will be an array of table space mappings surrounded by brackets. For example, `tablespace_map ((TS1, TS2), (TS3, TS4))`. This would mean that all objects from table space TS1 will be copied into table space TS2 on the target database and objects from table space TS3 will be copied into table space TS4 on the target. In the case of `((T1, T2), (T2, T3))`, all objects found in T1 on the source database will be recreated in T2 on the target database and any objects found in T2 on the source database will be recreated in T3 on the target database. The default is to use the same table space name as from the source, in which case, the input mapping for this table space is not necessary. If the specified table space does not exist, the copy of the objects using that table space will fail and be logged in the error file.

The user also has the option of using the `SYS_ANY` keyword to indicate that the target table space should be chosen using the default table space selection algorithm. In this case, `db2move` will be able to choose any available table space to be used as the target. The `SYS_ANY` keyword can be used for all table spaces, example: `tablespace_map SYS_ANY`. In addition, the user can specify specific mappings for some table spaces, and the default table space selection algorithm for the remaining. For example, `tablespace_map ((TS1, TS2), (TS3, TS4), SYS_ANY)`. This indicates that table space TS1 is mapped to TS2, TS3 is mapped to TS4, but the remaining table spaces will be using a default table space target. The `SYS_ANY` keyword is being used since it's not possible to have a table space starting with "SYS".

This is an optional option available to the COPY action.

-l *lobpaths*

For IMPORT and EXPORT, if this option is specified, it will be also used for XML paths. The default is the current directory.

This option specifies the absolute path names where LOB or XML files are created (as part of EXPORT) or searched for (as part of IMPORT or LOAD). When specifying multiple paths, each must be separated by commas; no blanks are allowed between paths. If multiple paths are specified, EXPORT will use them in round-robin fashion. It will write one LOB document to the first path, one to the second path, and so on up to the last, then back to the first path. The same is true for XML documents. If files are not found in the first path (during IMPORT or LOAD), the second path will be used, and so on.

-u *userid*

The default is the logged on user ID.

Both user ID and password are optional. However, if one is specified, the other must be specified. If the command is run on a client connecting to a remote server, user ID and password should be specified.

-p *password*

The default is the logged on password. Both user ID and password are optional. However, if one is specified, the other must be specified. When the -p option is specified, but the password not supplied, db2move will prompt for the password. This is done for security reasons. Inputting the password through command line creates security issues. For example, a ps -ef command would display the password. If, however, db2move is invoked through a script, then the passwords will have to be supplied. If the command is issued on a client connecting to a remote server, user ID and password should be specified.

- aw** Allow Warnings. When -aw is not specified, tables that experience warnings during export are not included in the db2move.lst file (although that table's .ixf file and .msg file are still generated). In some scenarios (such as data truncation) the user might want to allow such tables to be included in the db2move.lst file. Specifying this option allows tables which receive warnings during export to be included in the .lst file.

Examples

- To export all tables in the SAMPLE database (using default values for all options), issue:

```
db2move sample export
```
- To export all tables created by userid1 or user IDs LIKE us*rid2, and with the name tname1 or table names LIKE %tname2, issue:

```
db2move sample export -tc userid1,us*rid2 -tn tname1,*tname2
```
- To import all tables in the SAMPLE database (LOB paths D:\LOBPATH1 and C:\LOBPATH2 are to be searched for LOB files; this example is applicable to Windows operating systems only), issue:

```
db2move sample import -l D:\LOBPATH1,C:\LOBPATH2
```
- To load all tables in the SAMPLE database (/home/userid/lobpath subdirectory and the tmp subdirectory are to be searched for LOB files; this example is applicable to Linux and UNIX systems only), issue:

```
db2move sample load -l /home/userid/lobpath,/tmp
```
- To import all tables in the SAMPLE database in REPLACE mode using the specified user ID and password, issue:

```
db2move sample import -io replace -u userid -p password
```
- To duplicate schema schema1 from source database dbsrc to target database dbtgt, issue:

```
db2move dbsrc COPY -sn schema1 -co TARGET_DB dbtgt USER myuser1 USING mypass1
```
- To duplicate schema schema1 from source database dbsrc to target database dbtgt, rename the schema to newschema1 on the target, and map source table space ts1 to ts2 on the target, issue:

```
db2move dbsrc COPY -sn schema1 -co TARGET_DB dbtgt USER myuser1 USING mypass1  
SCHEMA_MAP ((schema1,newschema1)) TABLESPACE_MAP ((ts1,ts2), SYS_ANY))
```

Usage notes

- A db2move EXPORT, followed by a db2move IMPORT/LOAD, facilitates the movement of table data. It is necessary to manually move all other database

objects associated with the tables (such as aliases, views, or triggers) as well as objects that these tables may depend on (such as user-defined types or user-defined functions).

- If the IMPORT action with the CREATE or REPLACE_CREATE option is used to create the tables on the target database (both options are deprecated and may be removed in a future release), then the limitations outlined in “Imported table re-creation” are imposed. If unexpected errors are encountered during the db2move import phase when the REPLACE_CREATE option is used, examine the appropriate tabnnn.msg message file and consider whether the errors might be the result of the limitations on table creation.
- Tables that contain GENERATED ALWAYS identity columns cannot be imported or loaded using db2move. You can, however, manually import or load these tables. For more information, see “Identity column load considerations” or “Identity column import considerations”.
- When export, import, or load APIs are called by db2move, the **FileTypeMod** parameter is set to lobsinfile. That is, LOB data is kept in files that are separate from the PC/IXF file, for every table.
- The LOAD command must be run locally on the machine where the database and the data file reside.
- When using db2move LOAD and logretain is enabled for the database (the database is recoverable):
 - If the NONRECOVERABLE option is not specified, then db2move will invoke the db2Load API using the default COPY NO option, and the table spaces where the loaded tables reside are placed in the Backup Pending state upon completion of the utility (a full database or table space backup is required to take the table spaces out of the Backup Pending state).
 - If the NONRECOVERABLE option is specified, the table spaces are not placed in backup-pending state, however if rollforward recovery is performed later, the table is marked inaccessible and it must be dropped. For more information on Load recoverability options, see “Options for improving load performance”.
- Performance for the db2move command with the IMPORT or LOAD actions can be improved by altering the default buffer pool, IBMDEFAULTBP, and by updating the configuration parameters **sortheap**, **util_heap_sz**, **logfilsiz**, and **logprimary**.

Files Required/Generated When Using EXPORT:

- Input: None.
- Output:

EXPORT.out

The summarized result of the EXPORT action.

db2move.lst

The list of original table names, their corresponding PC/IXF file names (tabnnn.ixf), and message file names (tabnnn.msg). This list, the exported PC/IXF files, and LOB files (tabnnnc.yyy) are used as input to the db2move IMPORT or LOAD action.

tabnnn.ixf

The exported PC/IXF file of a specific table.

tabnnn.msg

The export message file of the corresponding table.

tabnnnc.yyy

The exported LOB files of a specific table.

“nnn” is the table number. “c” is a letter of the alphabet. “yyy” is a number ranging from 001 to 999.

These files are created only if the table being exported contains LOB data. If created, these LOB files are placed in the “lobpath” directories. There are a total of 26,000 possible names for the LOB files.

system.msg

The message file containing system messages for creating or deleting file or directory commands. This is only used if the action is EXPORT, and a LOB path is specified.

Files Required/Generated When Using IMPORT:

• Input:

db2move.lst

An output file from the EXPORT action.

tabnnn.ixf

An output file from the EXPORT action.

tabnnnc.yyy

An output file from the EXPORT action.

• Output:

IMPORT.out

The summarized result of the IMPORT action.

tabnnn.msg

The import message file of the corresponding table.

Files Required/Generated When Using LOAD:

• Input:

db2move.lst

An output file from the EXPORT action.

tabnnn.ixf

An output file from the EXPORT action.

tabnnnc.yyy

An output file from the EXPORT action.

• Output:

LOAD.out

The summarized result of the LOAD action.

tabnnn.msg

The LOAD message file of the corresponding table.

Files Required/Generated When Using COPY:

• Input: None

• Output:

COPYSCHEMA.msg

An output file containing messages generated during the COPY operation.

COPYSCHEMA.err

An output file containing an error message for each error encountered during the COPY operation, including DDL statements for each object which could not be recreated on the target database.

LOADTABLE.msg

An output file containing messages generated by each invocation of the Load utility (used to repopulate data on the target database).

LOADTABLE.err

An output file containing the names of tables that either encountered a failure during Load or still need to be populated on the target database. See the “Restarting a failed copy schema operation” topic for more details.

These files are timestamped and all files that are generated from one run will have the same timestamp.

Chapter 228. db2mq1sn - MQ listener

Invokes the asynchronous MQListener to monitor a set of WebSphere MQ message queues, passing messages that arrive on them to configured DB2 stored procedures. It can also perform associated administrative and configuration tasks. MQListener configuration information is stored in a DB2 database and consists of a set of named configurations, including a default. Each configuration is composed of a set of tasks. MQListener tasks are defined by the message queue from which to retrieve messages and the stored procedure to which they will be passed. The message queue description must include the name of the message queue and its queue manager, if it is not the default. Information about the stored procedure must include the database in which it is defined, a user name and password with which to access the database, and the procedure name and schema.

On Linux and UNIX operating systems, this utility is located in the DB2DIR/instance directory, where DB2DIR is the location where the current version of the DB2 database product is installed.

On Windows operating systems, this utility is located in the DB2PATH\sql1lib\bin directory, where DB2PATH is the location where the current version of the DB2 database product is installed.

For more information about controlling access to WebSphere MQ objects, refer to the *WebSphere MQ System Administration Guide* (SC34-6068-00).

Authorization

- All options except db2mq1sn admin access the MQListener configuration in the configDB database. The connection is made as configUser or, if no user is specified, an implicit connection is attempted. The user in whose name the connection is made must have EXECUTE privilege on package mqlConfi.
- To access MQ objects with the db2mq1sn run and db2mq1sn admin options, the user who executes the program must be able to open the appropriate MQ objects.
- To execute the db2mq1sn run option successfully, the dbUser specified in the db2mq1sn add option that created the task must have EXECUTE privilege on the specified stored procedure, and must have EXECUTE privilege on the package mqlRun in the dbName database.

Command syntax

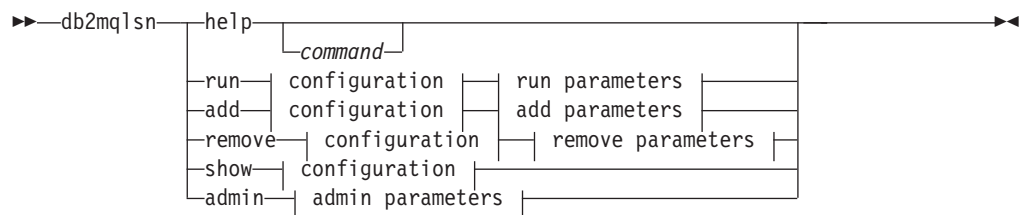

configuration:

---configDB---configuration database name----->

```

└─┬─configUser—user ID—configPwd—password—┘
└─┬─config—configuration name—┘

```

run parameters:

```

└─┬─adminQueue—admin queue name—┘
└─┬─adminQMgr—admin queue manager—┘

```

add parameters:

```

└─┬─inputQueue—input queue name—┘
└─┬─queueManager—queue manager name—┘
▶--procSchema—stored procedure schema—procName—stored procedure name—
▶--dbName—stored procedure database—┘
└─┬─dbUser—user ID—dbPwd—password—┘
└─┬─mqCoordinated—┘
└─┬─numInstances—number of instances to run—┘

```

remove parameters:

```

└─┬─inputQueue—input queue name—┘
└─┬─queueManager—queue manager name—┘

```

admin parameters:

```

└─┬─adminQueue—admin queue name—┘
└─┬─adminQueueList—namelist of admin queue names—┘
└─┬─adminQMgr—admin queue manager—┘
▶--adminCommand—shutdown—┘
└─┬─restart—┘

```

Command parameters

help *command*

Supplies detailed information about a particular command. If you do not give a command name, then a general help message is displayed.

-configDB *configuration database*

Name of the database that contains the configuration information.

-configUser *user ID* -configPwd *password*

Authorization information with which to access the configuration database.

-config *configuration name*

You can group individual tasks into a configuration. By doing this you can run a group of tasks together. If you do not specify a configuration name, then the utility runs the default configuration.

run

-adminQueue *admin queue name* **-adminQMgr** *admin queue manager*

This is the queue on which the MQListener listens for

administration commands. If you do not specify a queue manager, then the utility uses the configured default queue manager. If you do not specify an `adminQueue`, then the application does not receive any administration commands (such as shutdown or restart) through the message queue.

add

- inputQueue** *input queue name* **-queueManager** *queue manager name*
This is the queue on which the MQListener listens for messages for this task. If you do not specify a queue manager, the utility uses the default queue manager configured in WebSphere MQ.
- procSchema** *stored procedure schema* **-procName** *stored procedure name*
The stored procedure to which MQListener passes the message when it arrives.
- dbName** *stored procedure database*
MQListener passes the message to a stored procedure. This is the database in which the stored procedure is defined.
- dbUser** *user ID* **-dbPwd** *password*
The user on whose behalf the stored procedure is invoked.
- mqCoordinated**
This indicates that reading and writing to the WebSphere MQ message queue should be integrated into a transaction together with the DB2 stored procedure call. The entire transaction is coordinated by the WebSphere MQ coordinator. (The queue manager must also be configured to coordinate a transaction in this way. See the WebSphere MQ documentation for more information.) By default, the message queue operations are not part of the transaction in which the stored procedure is invoked.
- numInstances** *number of instances to run*
The number of duplicate instances of this task to run in this configuration. If you do not specify a value, then only one instance is run.

remove

- inputQueue** *input queue name* **-queueManager** *queue manager name*
This is the queue and queue manager that define the task that will be removed from the configuration. The combination of input queue and queue manager is unique within a configuration.

admin

- adminQueue** *admin queue name* **-adminQueueList** *namelist of admin queue names* **-adminQMGr** *admin queue manager*
The queue or namelist of queue names on which to send the admin command. If you do not specify a queue manager, the utility uses the default queue manager that is configured in WebSphere MQ.
- adminCommand** *admin command*
Submits a command. The command can be either shutdown or restart. shutdown causes a running MQListener to exit when the listener finishes processing the current message. restart performs a shutdown, and then reads the configuration again and restarts.

Examples

```
db2mq1sn show -configDB sampleDB -config nightlies
```

```
db2mq1sn add -configDB sampleDB -config nightlies -inputQueue app3
```

```
-procSchema imauser -procName proc3 -dbName aDB -dbUser imauser -dbPwd aSecret
```

```
db2mq1sn run -configDB -config nightlies
```

Chapter 229. db2mscs - Set up Windows failover utility

Creates the infrastructure for DB2 failover support on Windows using Microsoft Cluster Server (MSCS). This utility can be used to enable failover in both single-partition and partitioned database environments.

Authorization

The user must be logged on to a domain user account that belongs to the Administrators group of each machine in the MSCS cluster.

Command syntax

```
db2mscs [-f:input_file] [-u:instance_name]
```

Command parameters

-f:*input_file*

Specifies the input file to be used by the MSCS utility. If this parameter is specified, db2mscs utility will use filename as the input file, if this parameter is not specified, the db2mscs utility will try to use the DB2MSCS.CFG file that is in the current directory.

-u:*instance_name*

This option allows you to undo the db2mscs operation and revert the instance back to the non-MSCS instance specified by *instance_name*.

Usage notes

The db2mscs utility is a standalone command line utility used to transform a non-MSCS instance into an MSCS instance. The utility will create all MSCS groups, resources, and resource dependencies. It will also copy all DB2 information stored in the Windows registry to the cluster portion of the registry as well as moving the instance directory to a shared cluster disk. The db2mscs utility takes as input a configuration file provided by the user specifying how the cluster should be set up. The DB2MSCS.CFG file is an ASCII text file that contains parameters that are read by the db2mscs utility. You specify each input parameter on a separate line using the following format: `PARAMETER_KEYWORD=parameter_value`. For example:

```
CLUSTER_NAME=FINANCE
GROUP_NAME=DB2 Group
IP_ADDRESS=9.21.22.89
```

Two example configuration files can be found in the CFG subdirectory under the DB2 install directory. The first, DB2MSCS.EE, is an example for single-partition database environments. The second, DB2MSCS.EEE, is an example for partitioned database environments.

Ensure the Control Center is not active before issuing the db2mscs command. If the Control Center is active, the db2mscs utility will exit in error.

The parameters for the DB2MSCS.CFG file are as follows:

DB2_INSTANCE

The name of the DB2 instance. This parameter has a global scope and should be specified only once in the DB2MSCS.CFG file.

DAS_INSTANCE

The name of the DB2 Admin Server instance. Specify this parameter to migrate the DB2 Admin Server to run in the MSCS environment. This parameter has a global scope and should be specified only once in the DB2MSCS.CFG file.

CLUSTER_NAME

The name of the MSCS cluster. All the resources specified following this line are created in this cluster until another CLUSTER_NAME parameter is specified.

DB2_LOGON_USERNAME

The user name of the domain account for the DB2 service (specified as *domain\user*). This parameter has a global scope and should be specified only once in the DB2MSCS.CFG file.

DB2_LOGON_PASSWORD

The password of the domain account for the DB2 service. This parameter has a global scope and should be specified only once in the DB2MSCS.CFG file.

GROUP_NAME

The name of the MSCS group. If this parameter is specified, a new MSCS group is created if it does not exist. If the group already exists, it is used as the target group. Any MSCS resource specified after this parameter is created in this group or moved into this group until another GROUP_NAME parameter is specified. Specify this parameter once for each group. A MSCS group can be created within a MSCS Cluster.

DB2_NODE

The database partition number of the database partition server (or database partition) to be included in the current MSCS group. If multiple logical database partitions exist on the same machine, each database partition requires a separate DB2_NODE parameter. Specify this parameter after the GROUP_NAME parameter so that the DB2 resources are created in the correct MSCS group. This parameter is required for a multi-partitioned database environment.

IP_NAME

The name of the IP Address resource. The value for the IP_NAME is arbitrary, but it must be unique in the cluster. When this parameter is specified, an MSCS resource of type IP Address is created. This parameter is required for remote TCP/IP connections. This parameter is optional in a single partition database environment. A recommended name is the hostname that corresponds to the IP address.

IP_ADDRESS

The TCP/IP address for the IP resource specified by the preceding IP_NAME parameter. This parameter is required if the IP_NAME parameter is specified. This is a new IP address that is not used by any machine in the network.

IP_SUBNET

The TCP/IP subnet mask for the IP resource specified by the preceding IP_NAME parameter. This parameter is required if the IP_NAME parameter is specified.

IP_NETWORK

The name of the MSCS network to which the preceding IP Address resource belongs. This parameter is optional. If it is not specified, the first MSCS network detected by the system is used. The name of the MSCS network must be entered exactly as seen under the Networks branch in Cluster Administrator. The previous four IP keywords are used to create an IP Address resource.

NETNAME_NAME

The name of the Network Name resource. Specify this parameter to create the Network Name resource. This parameter is optional for single partition database environment. You must specify this parameter for the instance owning machine, on which DB2 instance directory resides, in a partitioned database environment.

NETNAME_VALUE

The value for the Network Name resource. This parameter must be specified if the NETNAME_NAME parameter is specified.

NETNAME_DEPENDENCY

The name for the IP resource that the Network Name resource depends on. Each Network Name resource must have a dependency on an IP Address resource. This parameter is optional. If it is not specified, the Network Name resource has a dependency on the first IP resource in the group.

SERVICE_DISPLAY_NAME

The display name of the Generic Service resource. Specify this parameter if you want to create a Generic Service resource.

SERVICE_NAME

The service name of the Generic Service resource. This parameter must be specified if the SERVICE_DISPLAY_NAME parameter is specified.

SERVICE_STARTUP

Optional startup parameter for the Generic Resource service.

DISK_NAME

The name of the physical disk resource to be moved to the current group. Specify as many disk resources as you need. The disk resources must already exist. When the db2mscs utility configures the DB2 instance for failover support, the instance directory is copied to the first MSCS disk in the group. To specify a different MSCS disk for the instance directory, use the INSTPROF_DISK parameter. The disk name used should be entered exactly as seen in Cluster Administrator.

INSTPROF_DISK

An optional parameter to specify an MSCS disk to contain the DB2 instance directory. If this parameter is not specified the db2mscs utility uses the first disk that belongs to the same group.

INSTPROF_PATH

An optional parameter to specify the exact path where the instance directory will be copied. This parameter *must* be specified when using IPSHADisks, a ServerRAID Netfinity® disk resource (for example, INSTPROF_PATH=p:\db2profs). INSTPROF_PATH will take precedence over INSTPROF_DISK if both are specified.

TARGET_DRVMAP_DISK

An optional parameter to specify the target MSCS disk for database drive mapping for a the multi-partitioned database environment. This parameter will specify the disk the database will be created on by mapping it from

the drive the create database command specifies. If this parameter is not specified, the database drive mapping must be manually registered using the db2drvmp utility.

DB2_FALLBACK

An optional parameter to control whether or not the applications should be forced off when the DB2 resource is brought offline. If not specified, then the setting for DB2_FALLBACK will be YES. If you do not want the applications to be forced off, then set DB2_FALLBACK to NO.

Chapter 230. db2mtrk - Memory tracker

Provides complete report of memory status, for instances, databases, agents, and applications. This command outputs the following memory pool allocation information:

- Current size
- Maximum size (hard limit)
- Largest size (high water mark)
- Type (identifier indicating function for which memory will be used)
- Agent who allocated pool (only if the pool is private)
- Application

The same information is also available from the Snapshot monitor.

Scope

In a partitioned database environment, this command can be invoked from any database partition defined in the `db2nodes.cfg` file. Apart from when instance level information is returned, the command returns information only for that database partition. This command does not return information for remote servers.

Authorization

One of the following:

- *sysadm*
- *sysctrl*
- *sysmaint*
- *sysmon*

Required Connection

Instance. The application creates a default instance attachment if one is not present.

Command Syntax

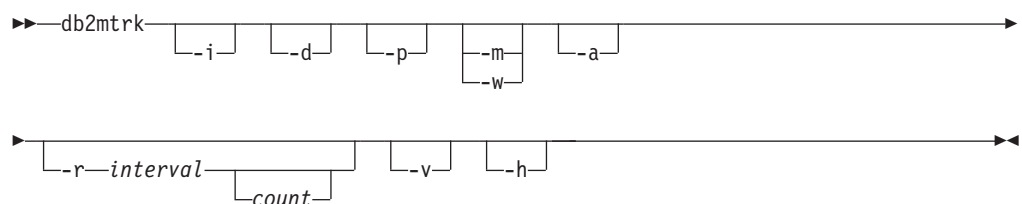

Command Parameters

- `-i` Show instance level memory.
- `-d` Show database level memory.
- `-a` Show application memory usage.
- `-p` Deprecated. Show private memory.

Replaced with -a parameter to show application memory usage.

- m** Show maximum values for each pool.
- w** Show high watermark values for each pool.
- r** Repeat mode
 - interval* Number of seconds to wait between subsequent calls to the memory tracker (in repeat mode).
 - count* Number of times to repeat.
- v** Verbose output.
- h** Show help screen. If you specify -h, only the help screen appears. No other information is displayed.

Examples

The following call returns database and instance normal values and repeats every 10 seconds:

```
db2mtrk -i -d -v -r 10
```

Consider the following output samples:

The command `db2mtrk -i -d` displays the following output:

Tracking Memory on: 2006/01/17 at 15:24:38

Memory for instance

monh	other
576.0K	8.0M

Memory for database: AJSTORM

utilh	pckcacheh	catcacheh	bph (1)	bph (S32K)	bph (S16K)	bph (S8K)
64.0K	640.0K	128.0K	34.2M	576.0K	320.0K	192.0K
bph (S4K)	shsortrh	lockh	dbh	apph (13)	appshrh	
128.0K	64.0K	9.6M	4.8M	64.0K	256.0K	

Memory for database: CMGARCIA

utilh	pckcacheh	catcacheh	bph (1)	bph (S32K)	bph (S16K)	bph (S8K)
64.0K	640.0K	128.0K	34.2M	576.0K	320.0K	192.0K
bph (S4K)	shsortrh	lockh	dbh	apph (26)	appshrh	
128.0K	64.0K	9.6M	4.8M	64.0K	256.0K	

The command `db2mtrk -a -i -d` displays the following output:

Tracking Memory on: 2007/01/15 at 11:30:38

Memory for instance

other	monh	fcmbp
11.5M	64.0K	640.0K

Memory for database: SAMPLE

utilh	pckcacheh	other	catcacheh	bph (1)	bph (S32K)	bph (S16K)
64.0K	1.0M	576.0K	448.0K	1.3M	832.0K	576.0K

bph (S8K)	bph (S4K)	shsorth	lockh	dbh	apph (12)	apph (11)
448.0K	384.0K	192.0K	320.0K	10.4M	64.0K	64.0K
apph (10)	apph (9)	apph (8)				
64.0K	64.0K	64.0K				

Application Memory for database: SAMPLE

appshrh
256.0K

Memory for application 11

apph	other
64.0K	64.0K

Memory for application 10

apph	other
64.0K	64.0K

Memory for application 9

apph	other
64.0K	64.0K

Memory for application 8

apph	other
64.0K	448.0K

The command `db2mtrk -a -v -i -d` displays the following output:

Tracking Memory on: 2007/01/15 at 11:22:56

Memory for instance

Other Memory is of size 12058624 bytes
 Database Monitor Heap is of size 65536 bytes
 FCMBP Heap is of size 655360 bytes
 Total: 12779520 bytes

Memory for database: SAMPLE

Backup/Restore/Util Heap is of size 65536 bytes
 Package Cache is of size 1048576 bytes
 Other Memory is of size 589824 bytes
 Catalog Cache Heap is of size 458752 bytes
 Buffer Pool Heap (1) is of size 1376256 bytes
 Buffer Pool Heap (System 32k buffer pool) is of size 851968 bytes
 Buffer Pool Heap (System 16k buffer pool) is of size 589824 bytes
 Buffer Pool Heap (System 8k buffer pool) is of size 458752 bytes
 Buffer Pool Heap (System 4k buffer pool) is of size 393216 bytes
 Shared Sort Heap is of size 196608 bytes
 Lock Manager Heap is of size 327680 bytes
 Database Heap is of size 10944512 bytes
 Application Heap (12) is of size 65536 bytes
 Application Heap (11) is of size 65536 bytes
 Application Heap (10) is of size 65536 bytes
 Application Heap (9) is of size 65536 bytes
 Application Heap (8) is of size 65536 bytes
 Applications Shared Heap is of size 524288 bytes
 Total: 18153472 bytes

Application Memory for database: SAMPLE

Applications Shared Heap is of size 524288 bytes

```

Total: 524288 bytes

Memory for application 11

Application Heap is of size 65536 bytes
Other Memory is of size 65536 bytes
Total: 131072 bytes

Memory for application 10

Application Heap is of size 65536 bytes
Other Memory is of size 65536 bytes
Total: 131072 bytes

Memory for application 9

Application Heap is of size 65536 bytes
Other Memory is of size 65536 bytes
Total: 131072 bytes

Memory for application 8

Application Heap is of size 65536 bytes
Other Memory is of size 458752 bytes
Total: 524288 bytes

Total: 1441792 bytes

```

Usage notes

Note:

1. When no flags are specified, usage is returned.
2. One of the -d, -h, -i, -p or -a flag must be specified.
3. When the -p parameter is specified, detailed private memory usage information is returned, grouped by agent ID.
4. When the -a parameter is specified, detailed application memory usage information is returned, grouped by application ID.
5. The "Other Memory" reported is the memory associated with the overhead of operating the database management system.
6. In some cases (such as the package cache) the maximum size displayed will be larger than the value assigned to the configuration parameter. In such cases, the value assigned to the configuration parameter is used as a 'soft limit', and the pool's actual memory usage might grow beyond the configured size.
7. For the buffer pool heaps, the number specified in the parentheses is either the buffer pool ID, or indicates that this buffer pool is one of the system buffer pools.
8. For application heaps, the number specified in parentheses is the application ID.
9. The maximum size that the memory tracker reports for some heaps is the amount of physical memory on the machine. These heaps are called unbounded heaps and are declared with an unlimited maximum size because when the heaps are declared, it is not clear how much memory they will require at peak times. Although these heaps are not strictly bounded by the physical memory on the machine, they are reported as the maximum size because it is a reasonable approximation.

Chapter 231. db2nchg - Change database partition server configuration

Modifies database partition server configuration. This includes moving the database partition server (node) from one machine to another; changing the TCP/IP host name of the machine; and selecting a different logical port number or a different network name for the database partition server (node). This command can only be used if the database partition server is stopped.

This command is available on Windows operating systems only.

Authorization

Local Administrator

Command syntax

```
db2nchg /n:dbpartitionnum [/i:instance_name]
  [/u:username,password] [/p:logical_port] [/h:host_name]
  [/m:machine_name] [/g:network_name]
```

Command parameters

/n:dbpartitionnum

Specifies the database partition number of the database partition server's configuration that is to be changed.

/i:instance_name

Specifies the instance in which this database partition server participates. If a parameter is not specified, the default is the current instance.

/u:username,password

Specifies the user name and password. If a parameter is not specified, the existing user name and password will apply.

/p:logical_port

Specifies the logical port for the database partition server. This parameter must be specified to move the database partition server to a different machine. If a parameter is not specified, the logical port number will remain unchanged.

/h:host_name

Specifies TCP/IP host name used by FCM for internal communications. If this parameter is not specified, the host name will remain the same.

/m:machine_name

Specifies the machine where the database partition server will reside. The database partition server can only be moved if there are no existing databases in the instance.

/g:network_name

Changes the network name for the database partition server. This parameter can be used to apply a specific IP address to the database partition server when there are multiple IP addresses on a machine. The network name or the IP address can be entered.

Examples

To change the logical port assigned to database partition 2, which participates in the instance TESTMPP, to logical port 3, enter the following command:

```
db2nchg /n:2 /i:TESTMPP /p:3
```

Chapter 232. db2ncrt - Add database partition server to an instance

Adds a database partition server (node) to an instance.

This command is available on Windows operating systems only.

Scope

If a database partition server is added to a computer where an instance already exists, a database partition server is added as a logical database partition server to the computer. If a database partition server is added to a computer where an instance does not exist, the instance is added and the computer becomes a new physical database partition server. This command should not be used if there are databases in an instance. Instead, the START DATABASE MANAGER command should be issued with the ADD DBPARTITIONNUM option. This ensures that the database is correctly added to the new database partition server. It is also possible to add a database partition server to an instance in which a database has been created. The db2nodes.cfg file should not be edited since changing the file might cause inconsistencies in the partitioned database environment.

Authorization

Local Administrator authority on the computer where the new database partition server is added.

Command syntax

```
db2ncrt /n:dbpartitionnum /u:username,password  
/i:instance_name /m:machine_name /p:logical_port  
/h:host_name /g:network_name /o:instance_owning_machine
```

Command parameters

/n:dbpartitionnum

A unique database partition number which identifies the database partition server. The number entered can range from 1 to 999.

/u:username,password

Specifies the logon account name and password for DB2.

/i:instance_name

Specifies the instance name. If a parameter is not specified, the default is the current instance.

/m:machine_name

Specifies the computer name of the Windows workstation on which the database partition server resides. This parameter is required if a database partition server is added on a remote computer.

/p:logical_port

Specifies the logical port number used for the database partition server. If this parameter is not specified, the logical port number assigned will be 0. When creating a logical database partition server, this parameter must be specified and a logical port number that is not in use must be selected. Note the following restrictions:

- Every computer must have a database partition server that has a logical port 0.
- The port number cannot exceed the port range reserved for FCM communications in the `x:\winnt\system32\drivers\etc\` directory. For example, if a range of 4 ports is reserved for the current instance, then the maximum port number is 3. Port 0 is used for the default logical database partition server.

/h:host_name

Specifies the TCP/IP host name that is used by FCM for internal communications. This parameter is required when the database partition server is being added on a remote computer.

/g:network_name

Specifies the network name for the database partition server. If a parameter is not specified, the first IP address detected on the system will be used. This parameter can be used to apply a specific IP address to the database partition server when there are multiple IP addresses on a computer. The network name or the IP address can be entered.

/o:instance_owning_machine

Specifies the computer name of the instance-owning computer. The default is the local computer. This parameter is required when the `db2ncrt` command is invoked on any computer that is not the instance-owning computer.

Examples

To add a new database partition server to the instance TESTMPP on the instance-owning computer SHAYER, where the new database partition server is known as database partition 2 and uses logical port 1, enter the following command:

```
db2ncrt /n:2 /u:QBPAULZ\paulz,g1reeky /i:TESTMPP /m:TEST /p:1 /o:SHAYER /h:TEST
```

Chapter 233. db2ndrop - Drop database partition server from an instance

Drops a database partition server (node) from an instance that has no databases. If a database partition server is dropped, its database partition number can be reused for a new database partition server. This command can only be used if the database partition server is stopped.

This command is available on Windows operating systems only.

Authorization

Local Administrator authority on the machine where the database partition server is being dropped.

Command syntax

```
db2ndrop /n:dbpartitionnum [/i:instance_name]
```

Command parameters

/n:dbpartitionnum

A unique database partition number which identifies the database partition server.

/i:instance_name

Specifies the instance name. If a parameter is not specified, the default is the current instance.

Examples

```
db2ndrop /n:2 /i=KMASCI
```

Usage notes

If the instance-owning database partition server (dbpartitionnum 0) is dropped from the instance, the instance becomes unusable. To drop the instance, use the db2idrop command.

This command should not be used if there are databases in this instance. Instead, the db2stop drop nodenum command should be used. This ensures that the database partition server is correctly removed from the partition database environment. It is also possible to drop a database partition server in an instance where a database exists. The db2nodes.cfg file should not be edited since changing the file might cause inconsistencies in the partitioned database environment.

To drop a database partition server that is assigned to the logical port 0 from a machine that is running multiple logical database partition servers, all other database partition servers assigned to the other logical ports must be dropped first. Each database partition server must have a database partition server assigned to logical port 0.

Chapter 234. db2nrcfg - Non-root install configuration tool command

Configuration tool used for non-root installations of DB2.

Authorization

Non-root ID who owns the non-root installation.

Required Connection

None

Command syntax

```
►► db2nrcfg [-a AuthType] [-d] [-p PortName] [-s InstType] [-h | -?] ►►
```

Command parameters

- a *AuthType*
Sets the authentication type (SERVER, CLIENT, or SERVER_ENCRYPT) for the instance.
- d Turns debug mode ON.
- p *PortName*
Sets the port name or port number to be used by this instance.
- s *InstType*
Sets the type of instance to be created (wse, ese, or client).
- h | -?
Displays help information.

Usage notes

This command is automatically run by DB2 installer during non-root installation.

The db2icrt, db2iupdt, and db2iupgrade commands, that are available for root install, are not be available in non-root install.

Chapter 235. db2rfe - Enable root features for non-root install command

This command enables the supported root features, in non-root installations of DB2, according to the configuration file. The DB2 non-root instance needs to be stopped before the db2rfe command is executed.

Authorization

User with root privilege.

Required Connection

None

Command syntax

```
▶▶ db2rfe -f db2rfe_config_file [ -h | -? ]
```

Command parameters

-f *db2rfe_config_file*

Specifies the configuration file to be used to enable root features.

-h | -?

Displays help information.

Usage notes

Each root feature, in the configuration file, will be in a separate section. Each section will have a start and end mark, comments describing what the section will enable, and the command to enable the root feature. The sample configuration file `db2rfe.cfg` will be installed to the `$DB2DIR/instance` directory.

The sample configuration file will look like the following (the non-root install owner is `db2inst3` in this example):

```
** =====  
**  
** Sample configuration file for db2rfe of IBM DB2  
** -----  
**  
** To select features and settings to configure, uncomment the corresponding  
** keywords and specify values for those keywords.  
**  
** Comments are made by placing either an asterisk (*) or a number sign (#) at  
** the start of a line  
**  
** =====
```

```
INSTANCENAME=db2inst3  
** This is required keyword.
```

```
** -----
** Set hard/soft data ulimit to unlimited, and hard/soft nofile ulimit to 65536.
**
** Note: This is for AIX only. On other platforms, refer to system documentation
** to set it manually.
** -----
** Valid value is NO and YES. Change to YES if you need to set the ulimit.
```

SET_ULIMIT=NO

```
** -----
** Enable DB2 High Availability (HA) feature
** -----
** Valid value is NO and YES. Change to YES if you need to enable this feature.
```

ENABLE_HA=NO

```
** -----
** ENABLE DB2 Authentication on the server using local operating system security.
** -----
** Valid value is NO and YES. Change to YES if you need to enable this feature.
```

ENABLE_OS_AUTHENTICATION=NO

```
** -----
** Reserve DB2 remote connection service entry
** -----
** Valid value is NO and YES. Change to YES if you need to enable this feature.
```

RESERVE_REMOTE_CONNECTION=NO

*SVCENAME=db2c_db2inst3
** char(14)

*SVCEPORT=48000
** Valid value: 1024 - 65535

```
** -----
** Reserve DB2 text search service entry
** -----
** Valid value is NO and YES. Change to YES if you need to enable this feature.
```

RESERVE_TEXT_SEARCH_CONNECTION=NO

*SVCENAME_TEXT_SEARCH=db2j_db2inst3
** char(14)

*SVCEPORT_TEXT_SEARCH=55000
** Valid value: 1024 - 65535

Chapter 236. db2nrupt - Non-root-installed instance update command

Update tool used for instances created by non-root installations of DB2.

Authorization

Non-root ID who owns the non-root installation.

Required Connection

None

Command syntax

```
db2nrupt [-a AuthType] [-d] [-k] [-h | -?]
```

Command parameters

- a** *AuthType*
Sets the authentication type (SERVER, CLIENT, or SERVER_ENCRYPT) for the instance.
- d** Turns debug mode ON.
- k**
Keeps the current instance type during the update.
- h | -?**
Displays help information.

Usage notes

The

db2icrt, db2iupdt, and db2iupgrade commands, that are used by root install, are not available in non-root install.

Chapter 237. db2nrupgrade - Upgrade non-root instance command

This command is only available on Linux and UNIX systems.

The db2nrupgrade command upgrades a non-root instance from a previous version of the DB2 database system to the current version of the DB2 copy from where you are running the db2nrupgrade command.

This command is located in the DB2DIR/instance directory, where DB2DIR represents the installation location where the new release of the DB2 database system is installed. This command does not support instance upgrade for a root installation.

Authorization

Non-root ID who owns the non-root installation copy.

Command syntax

```
▶▶—db2nrupgrade—┌─d─┐ ┌─a─AuthType─┐ ┌─b─backup_dir─┐▶▶
```

Command parameters

For Linux and UNIX systems

- d** Turns debug mode on. Use this option only when instructed by DB2 Support.
- a *AuthType*** Specifies the authentication type (SERVER, CLIENT or SERVER_ENCRYPT) for the instance. The default is SERVER.
- b *backup_dir*** This parameter is mandatory. Specifies the directory where the configuration files from the old DB2 version are stored.

Usage notes

- This command is run automatically during the copy upgrade. You do not need to manually run this command unless the copy upgrade failed.

Chapter 238. db2osconf - Utility for kernel parameter values

Makes recommendations for kernel parameter values based on the size of a system. The recommended values are high enough for a given system that they can accommodate most reasonable workloads. This command is currently available only for DB2 on HP-UX on 64-bit instances and the Solaris operating system.

Authorization

- On DB2 for HP-UX, no authorization is required. To make the changes recommended by the db2osconf utility, you must have root access.
- On DB2 for the Solaris operating system, you must have root access or be a member of the sys group.

Command syntax

To get the list of currently supported options, enter db2osconf -h:

```
db2osconf -h
Usage:
-c          # Client only
-f          # Compare to current
-h          # Help screen
-l          # List current
-m <mem in GB> # Specify memory in GB
-n <num CPUs> # Specify number of CPUs
-p <perf level> # Msg Q performance level (0-3)
-s <scale factor> # Scale factor (1-3)
-t <threads> # Number of threads
```

Command parameters

- c The -c switch is for client only installations. This option is available only on DB2 for the Solaris operating system.
- f Used to compare the current kernel parameters with the values that would be recommended by the db2osconf utility. The -f option is the default if no other options are entered with the db2osconf command. On the Solaris operating system, only the kernel parameters that differ will be displayed. Since the current kernel parameters are taken directly from the live kernel, they might not match those in /etc/system, the Solaris system specification file. If the kernel parameters from the live kernel are different than those listed in the /etc/system, the /etc/system file might have been changed without a reboot or there might be a syntax error in the file. On HP-UX, the -f option returns a list of recommended parameters and a list of recommended changes to parameter values:
***** Please Change the Following in the Given Order *****
WARNING [<parameter name>] should be set to <value>
- l Lists the current kernel parameters.
- m Overrides the amount of physical memory in GB. Normally, the db2osconf utility determines the amount of physical memory automatically. This option is available only on DB2 for the Solaris operating system.
- n Overrides the number of CPUs on the system. Normally, the db2osconf utility determines the number of CPUs automatically. This option is available only on DB2 for the Solaris operating system.

- p Sets the performance level for SYSV message queues. 0 (zero) is the default and 3 is the highest setting. Setting this value higher can increase the performance of the message queue facility at the expense of using more memory.
- s Sets the scale factor. The default scale factor is 1 and should be sufficient for almost any workload. If a scale factor of 1 is not enough, the system might be too small to handle the workload. The scale factor sets the kernel parameters recommendations to that of a system proportionally larger than the size of the current system. For example, a scale factor of 2.5 would recommend kernel parameters for a system that is 2.5 times the size of the current system.
- t Provides recommendations for `semsys:seminfo_semume` and `shmsys:shminfo_shmseg` kernel parameter values. This option is available only on DB2 for the Solaris operating system. For multi-threaded programs with a fair number of connections, these kernel parameters might have to be set beyond their default values. They only need to be reset if the multi-threaded program requiring them is a local application:

semsys:seminfo_semume

Limit of semaphore undo structures that can be used by any one process

shmsys:shminfo_shmseg

Limit on the number of shared memory segments that any one process can create.

These parameters are set in the `/etc/system` file. The following is a guide to set the values, and is what the `db2osconf` utility uses to recommend them. For each local connection DB2 will use one semaphore and one shared memory segment to communicate. If the multi-threaded application is a local application and has X number of connections to DB2, then that application (process) will need X number of shared memory segments and X number of the semaphore undo structures to communicate with DB2. So the value of the two kernel Parameters should be set to X + 10 (the plus 10 provides a safety margin).

Without the `-l` or `-f` switches, the `db2osconf` utility displays the kernel parameters using the syntax of the `/etc/system` file. To prevent human errors, the output can be cut and pasted directly into the `/etc/system` file.

The kernel parameters are recommended based on both the number of CPUs and the amount of physical memory on the system. If one is unproportionately low, the recommendations will be based on the lower of the two.

Examples

Here is a sample output produced by running the `db2osconf` utility with the `-t` switch set for 500 threads. The results received are machine-specific, so the results you receive will vary depending on your environment.

```
db2osconf -t 500

set msgsys:msginfo_msgmax = 65535
set msgsys:msginfo_msgmnb = 65535
set msgsys:msginfo_msgssz = 32
set msgsys:msginfo_msgseg = 32767
set msgsys:msginfo_msgmap = 2562
set msgsys:msginfo_msgmni = 2560
set msgsys:msginfo_msqtql = 2560
```

```

set semsys:seminfo_semmap = 3074
set semsys:seminfo_semmni = 3072
set semsys:seminfo_semmns = 6452
set semsys:seminfo_semmnu = 3072
set semsys:seminfo_semume = 600
set shmsys:shminfo_shmmax = 2134020096
set shmsys:shminfo_shmmni = 3072
set shmsys:shminfo_shmseg = 600

```

```

Total kernel space for IPC:
0.35MB (shm) + 1.77MB (sem) + 1.34MB (msg) == 3.46MB (total)

```

The recommended values for `set semsys:seminfo_semume` and `set shmsys:shminfo_shmseg` were the additional values provided by running `db2osconf -t 500`.

Usage notes

Even though it is possible to recommend kernel parameters based on a particular DB2 workload, this level of accuracy is not beneficial. If the kernel parameter values are too close to what are actually needed and the workload changes in the future, DB2 might encounter a problem due to a lack of interprocess communication (IPC) resources. A lack of IPC resources can lead to an unplanned outage for DB2 and a reboot would be necessary in order to increase kernel parameters. By setting the kernel parameters reasonably high, it should reduce or eliminate the need to change them in the future. The amount of memory consumed by the kernel parameter recommendations is almost trivial compared to the size of the system. For example, for a system with 4GB of RAM and 4 CPUs, the amount of memory for the recommended kernel parameters is 4.67MB or 0.11%. This small fraction of memory used for the kernel parameters should be acceptable given the benefits.

On the Solaris operating system, there are two versions of the `db2osconf` utility: one for 64-bit kernels and one for 32-bit kernels. The utility needs to be run as `root` or with the group `sys` since it accesses the following special devices (accesses are read-only):

```

crw-r----- 1 root    sys      13,  1 Jul 19 18:06 /dev/kmem
crw-rw-rw-  1 root    sys      72,  0 Feb 19 1999 /dev/ksyms
crw-r----- 1 root    sys      13,  0 Feb 19 1999 /dev/mem

```

Chapter 239. db2pd - Monitor and troubleshoot DB2 database

Retrieves information from the DB2 database system memory sets.

Authorization

One of the following authority levels is required:

- The SYSADM authority level.
- The SYSCTRL authority level.
- The SYSMANT authority level.
- The SYSMON authority level.

When the SYSMON authorization level is granted, the following options are not available:

- **dump**
- **memblocks**
- **stack**

Required connection

There is no minimum connection requirement. However, if a database scope option is specified, that database must be active before the command can return the requested information.

Command syntax

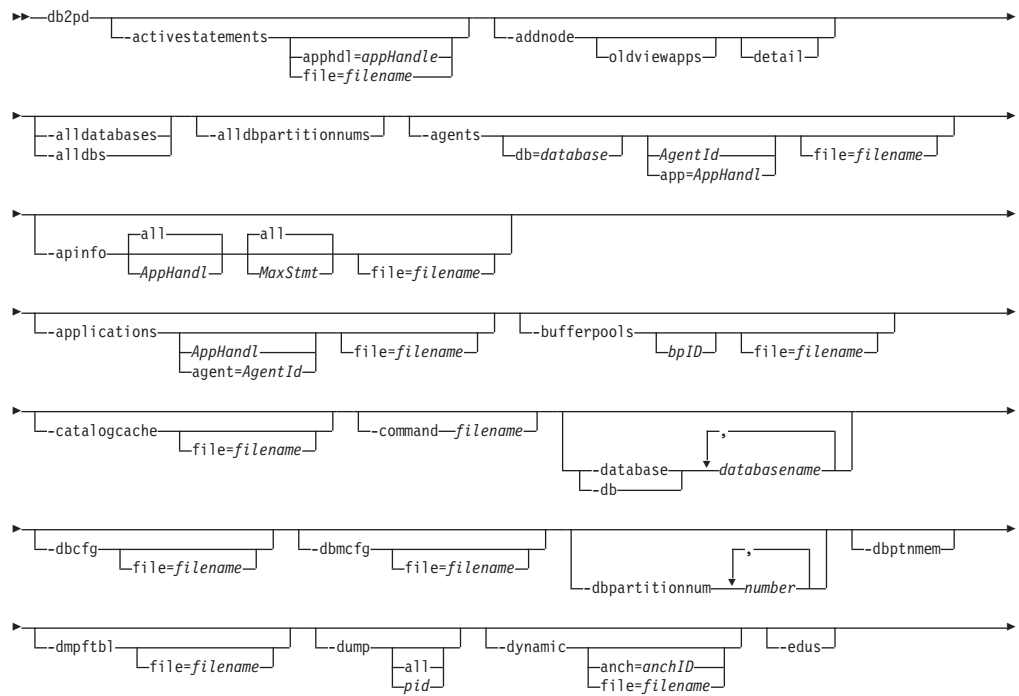

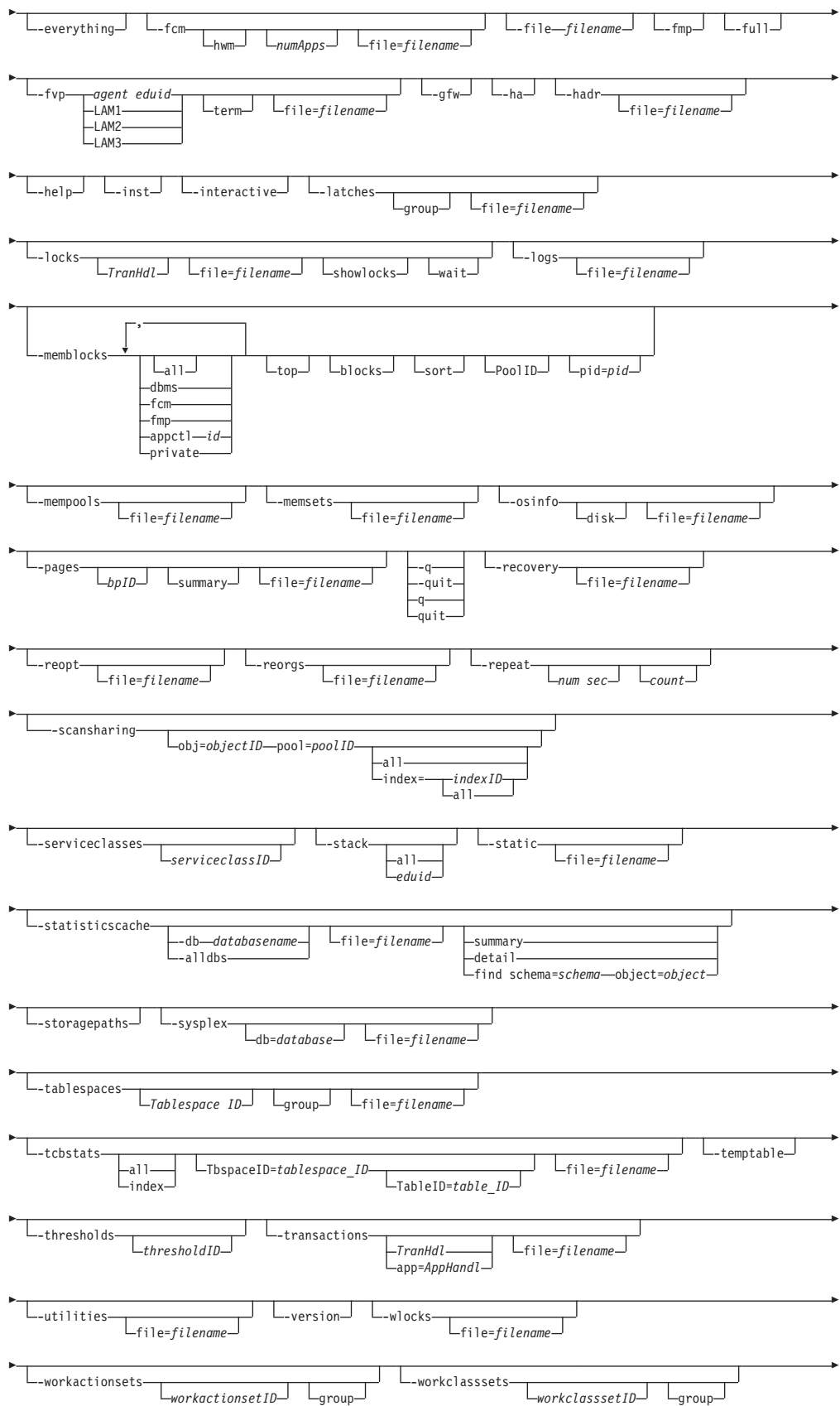



Command parameters

-activestatements

Returns information about the active statement list.

apphdl=*appHandle*

If an application handle is specified, information is returned about that particular application.

file=*filename*

Sends the **-activestatements** output to a specified file.

-addnode

Returns progress information on the add database partition server operation. This parameter only returns information when issued on the database partition server that is being added. The progress information is persistent on the new database partition server until it is restarted. If issued on an existing database partition server, this parameter returns no information.

See Sample output of the db2pd -addnode command.

-alldatabases | -alldbs

Specifies that the command attaches to all memory sets of all the databases.

-alldbpartitionnums

Specifies that this command is to run on all active database partition servers in the instance. db2pd will only report information from database partition servers on the same physical machine that db2pd is being run on.

-agents

Returns information about agents.

If an agent ID is specified, information is returned about the agent. If an application ID is specified, information is returned about all the agents that are performing work for the application. Specify this command parameter with the **-inst** parameter, if you have chosen a database that you want scope output for. See the agents usage notes.

-apinfo

Displays the detailed information about applications including the execution of dynamic SQL statements of the current unit of work (UOW), if it is applicable.

AppHandl

If an application handle is specified, information is returned about that particular application. The default is to display information for all applications running at that partition.

MaxStmt

If a number of maximum statements is specified, the information for the most recent of SQL statements, equalling the maximum number specified, is returned. The default is to display information for all the executed SQL statements.

file=*filename*

Sends the **-apinfo** output to a specified file.

See Sample output of the `db2pd -apinfo` command.

Note: To capture the past history of a unit of work (UOW) including the SQL statement text for the applications, activate a deadlock event monitor using the statement history clause. For example, use one of the following statements:

```
create event monitor testit for deadlocks with details history write to file path global
create event monitor testit for deadlocks with details history write to table
```

The CREATE EVENT MONITOR statement has additional options, such as the ability to specify the name of the table space and table into which data will be written. For details, see the CREATE EVENT MONITOR statement description. The event monitor with statement history capability affects all applications and increases the monitor heap usage by the DB2 database manager.

See the **-apinfo** usage notes.

-applications

Returns information about applications.

If an application ID is specified, information is returned about that application.

If an agent ID is specified, information is returned about the agent that is working on behalf of the application. See the **-applications** usage notes.

-bufferpools

Returns information about the buffer pools. If a bufferpool ID is specified, information is returned about the bufferpool. See the **-bufferpools** usage notes.

-catalogcache

Returns information about the catalog cache, which maintains an in-memory version of statistics. For example,

```
db2pd -catalogcache -db sample
```

See Sample output of the `db2pd -catalogcache` command.

Definitions for the returned information can be found here: **-catalogcache**. The output for SYSTABLES can have multiple entries for the same table (see DEPT in the above output). Multiple entries correspond to a different version of the statistics for the same table. The usage lock name will be unique among the entries for the same object and soft invalid entries will be marked with an 'S'. See the **-catalogcache** usage notes.

-command *filename*

Specifies to read and execute the `db2pd` command options that are specified in the file.

-database | **-db** *databasename*

Specifies that the command attaches to the database memory sets of the specified database.

-dbcfg Returns the settings of the database configuration parameters. See the **-dbcfg** usage notes.

-dbmcfg

Returns the settings of the database manager configuration parameters.

Specify this option with the **-inst** command parameter, if you have chosen a database for which you want scope output. See the **-dbmcfg** usage notes.

- dbpartitionnum** *number*
Specifies that the command is to run on the specified database partition server.
- dbptnmem**
Lists database partition memory statistics.
- dmpftbl**
Dumps file table contents.
- dump**
Produces stack trace and binary dump files in the **diagpath** directory. Only available on UNIX operating systems.
 - Specify with the **all** command parameter to produce stack trace files and binary dump files for all agents in the current database partition.
 - Specify with the *pid* option to produce a stack trace file and binary dump file for a specific agent.
- dynamic**
Returns information about the execution of dynamic SQL. See the **-dynamic** usage notes.
 - anch=anchID**
If an anchor identifier is specified, information is returned about that particular dynamic SQL.
 - file=filename**
Sends the **-dynamic** output to a specified file.
- edus** Lists all EDUs in the instance. In the case of a sustained trap, specifying this option outputs the EDU Name indicating that the EDU is suspended.
See Sample output of the db2pd -edus command.
- everything**
Runs all options for all databases on all database partition servers that are local to the server.
- fcm** Returns information about the fast communication manager.
 - Specify this parameter with the **-inst** parameter, if you have chosen a database for which you want scope output.
 - Specify this parameter with the **hwm** parameter, to retrieve high-watermark consumptions of FCM buffers and channels by applications since the start of the DB2 instance. The high-watermark consumption values of applications are retained even if they have disconnected from the database already.
 - Specify this parameter with the *numApps* option, to limit the maximum number of applications that the db2pd command reports in the current and HWM consumption statistics.
 See the **-fcm** usage notes.
- file** *filename*
Specifies to write the output to the specified file.
- fmp** Returns information about the process in which the fenced routines are executed. See the **-fmp** usage notes.
- full** Specifies that all output is expanded to its maximum length. If not specified, output is truncated to save space on the display.
- fvp** Displays fenced vendor process information and allows the termination of

a fenced vendor process in situations where it is not responding. This applies to backup, restore, prune history, load, load copy (roll forward) and Log Manager, where a vendor media device is being used.

Note: The **-database** *database* command parameter must be used in conjunction with this parameter in order to connect to the right memory set to gather the information.

agent eduid

Displays the fenced vendor process information for a DB2 EDU ID of a backup, restore, prune history, load or load copy (roll forward) agent.

LAM1 Displays fenced vendor process information for **logarchmeth1**.

LAM2 Displays fenced vendor process information for **logarchmeth2**.

LAM3 Displays fenced vendor process information for the special case where the current log archive method configuration parameter is not set to VENDOR, and so a fenced vendor process needs to be created temporarily, during ROLLFORWARD DATABASE, to retrieve logs from a previous vendor archiving method.

term On top of displaying fenced vendor process information, this option also terminates the fenced vendor process specified.

Note: This has no affect on Windows operating systems.

-gfw Returns a list of event monitors that are currently active or were deactivated for some reason. It also returns statistics and information about the targets into which event monitors write data for each fast writer independent coordinator.

-ha Reports high availability statistics.

-hadr Reports high availability disaster recovery (HADR) information. Descriptions of each reported element can be found in the high availability disaster recovery section of the *Database Monitoring Guide and Reference*.

-h | -help

Displays the online help information.

-inst Returns all instance-scope information.

-interactive

Specifies to override the values specified for the **DB2PDOPT** environment variable when running the db2pd command.

-latches

Reports all latch holders and all latch waiters.

group Just prints the list of holders followed by the list of waiters.

file=filename

Sends **-latches** output to *filename*.

-locks Returns information about the locks.

Specify a transaction handle to obtain information about the locks that are held by a specific transaction.

Specify with the **showlocks** command parameter to return detailed information about lock names. For row and block locks on partitioned

tables and individual data partitions, **showlocks** displays the data partition identifier as part of the row with the lock information.

Specify the **wait** command parameter to return locks in a wait state and the owners of those locks.

See the **-locks** usage notes.

-logs Returns information about the log files. See the **-logs** usage notes.

-memblocks

Returns information about the memory pools.

dbms Only report blocks in the dbms memory set.

fcm Only report blocks in the fast communication manager memory set.

fmp Only report blocks in the fenced mode procedure memory set.

appctl *id*
Only report blocks in the application control set.

all Report blocks from all memory sets.

top Report the top memory consumers for each set.

blocks Report the memory blocks for each set.

sort Report the sorted memory blocks for each pool in each set.

PoolID

Report memory blocks from a specific pool.

pid=*pid*
Report memory blocks from a specific process id (for UNIX operating systems only).

private

Report memory blocks from the private memory set (for Windows operating systems only).

See the **-memblocks** usage notes.

-mempools

Returns information about the memory pools.

Specify this option with the **-inst** option to include all the instance-scope information in the returned information. See the **-mempools** usage notes.

-memsets

Returns information about the memory sets.

Specify this command parameter with the **-inst** command parameter to include all the instance-scope information in the returned information. See the **-memsets** usage notes.

-osinfo

Returns operating system information. If a disk path is specified, information about the disk will be printed. See the **-osinfo** usage notes.

-pages Returns information about the buffer pool pages.

bpID If bufferpool ID is specified, only pages from the specified bufferpool are returned.

summary

If this option is specified, only the summary information section will be displayed.

See the **-pages** usage notes. See also Sample output of the db2pd -pages command.

-q | -quit | q | quit

Quit. When the db2pd keyword alone is issued, db2pd runs in interactive mode. The **quit** command causes an exit from this mode back to the standard command prompt.

-recovery

Returns information about recovery activity. See the **-recovery** usage notes.

-reopt Returns information about cached SQL statements that were re-optimized using the **REOPT ONCE** option. See the **-reopt** usage notes.

-reorgs

Returns information and statistics about table and data partition reorganization. See the **-reorgs** usage notes.

-repeat *num sec count*

Specifies that the command is to be repeated after the specified number of seconds. If a value is not specified for the number of seconds, the command repeats every five seconds. You can also specify the number of times the output will be repeated. If you do not specify a value for *count*, the command is repeated until it is interrupted.

-scansharing

Returns scan sharing information about all tables that have table or block index scan sharing in the specified database.

obj=objectID pool=poolID

Returns scan sharing information about the specified table.

all Returns scan sharing information for all tables. For each table, table or range scan sharing information is returned. In addition, for MDC tables, block index scan sharing information is returned.

index=

indexID

Returns scan sharing information for the specified table, and block index scan sharing information for the specified block index.

all Returns table scan sharing information for the specified table, and block index scan sharing information for all block indexes.

See Sample output of the db2pd -scansharing command.

See the **-scansharing** usage notes.

-serviceclasses *serviceclassID*

Returns information about the service classes for a database. *serviceclassID* is an optional parameter to retrieve information for one specific service class. If *serviceclassID* is not specified, information for all service classes is retrieved.

See the **-serviceclasses** usage notes. See also Sample output of the db2pd -serviceclasses command.

-stack In case of an engine hang, the events stack and event history (event flow) can be used to get information about the DB2 state. Produces event stack and history trace files in the **diagpath** directory. With the exception of trapping and panicking EDUs, all other EDUs will dump to a stacktrace file *pid.tid.node.stack.txt*. Use **-stack** on UNIX operating systems, and **-stack all** on Windows operating systems.

all Specify this option to produce stack trace files for all processes in the current database partition.

eduid Limit output to only EDU with a specified ID. Formatted events and data attached will be dumped to the relevant *pid.tid/EDUID.node.trap.txt* files in the db2dump directory.

Event stack will be output in the following order:

Last event (on the top of event stack)

- Event type and short description
- Customer impact
- Object identifier
- ECF ID, probe
- Top event header
- Top event qualifiers (if any)
- Top event data (if present)

First event (on the bottom of event stack)

- Event type and short description
- Customer impact
- Object identifier
- ECF ID, probe
- Bottom event header
- Bottom event qualifiers (if any)
- Bottom event data (if present)

In the above, ECF ID is ECF identifier (will be formatted as *product, component, function*) and probe is a line of code or some unique number (for a function).

Event flow (recorded event “history”) will be output in the following order:

First event record

- Event type and short description
- Customer impact
- Object identifier
- ECF ID, probe
- Event header
- Object data (if not a string or integer)

Last event record

- Event type and short description
- Customer impact

- Object identifier
- ECF ID, probe
- Event header
- Object data (if not a string or integer)

-static Returns information about the execution of static SQL and packages. See the **-static** usage notes.

-statisticscache

Returns information about the statistics cache at the database level.

summary

Summarizes statistics cache. To dump the statistics cache summary for database *sample*, issue the following command:

```
db2pd -db sample -statisticscache summary
```

detail Specify this option to dump detailed statistics information stored in the statistics cache for all tables with the latest statistics collected by real-time statistics gathering. To dump detailed statistics information stored in the statistics cache for all the databases, issue the following command:

```
db2pd -statisticscache detail -alldbs
```

find schema=*schema* object=*object*

Specify this option to dump the detailed statistics information for a specific table with *schema* as schema name and *object* as table name. To dump detailed statistics information for table *USER1.T1* of database *sample*, issue the following command:

```
db2pd -db sample -statisticscache find schema=USER1 object=T1
```

See the **-statisticscache** usage notes.

-storagepaths

Returns information about the automatic storage paths defined for the database.

See the **-storagepaths** usage notes. See also Sample output of the `db2pd -storagepaths` command.

-sysplex

Returns information about the list of servers associated with the database alias indicated by the **db** parameter. If the **-database** command parameter is not specified, information is returned for all databases.

Specify this command parameter with the **-inst** command parameter, if you have chosen a database for which you want scope output.

See the **-sysplex** usage notes.

-tablespaces

Returns information about the table spaces.

Specify with the **group** command parameter to display the information about the containers of a table space grouped with the table space.

Specify with the *Tablespace ID* command parameter to display the information about a specific table space and its containers.

See the **-tablespaces** usage notes. See also Sample output of the `db2pd -tablespaces` command.

-tcbstats

Returns information about tables and indexes. The total number of updates on tables, the UDI and real-time statistics UDI counters (RTSUDI), are returned as well.

TbpaceID=*tablespace_ID*

Specify this option to display the information about a specific table space.

TableID=*table_ID*

Specify this option to display the information about a specific table. The **TbpaceID** option is required when using the **TableID** option.

For temporary table compression, the **-tcbstats** output will include two new columns in the TCB Table Stats section of the output.

1. **StoredBytes**: This corresponds to the “Total stored temp bytes” from the db2pd -temptable output.
2. **BytesSaved**: This corresponds to the “Total bytes saved” value from the db2pd -temptable output.

See the **-tcbstats** usage notes.

-temptable

By default, returns the following information about temporary tables:

- **Number of Temp Tables** The total number of temporary tables created and dropped since the database manager was started or since the last reset of the counters.
- **Comp Eligible Temps** Temporary tables that the data base manager has determined is eligible for compression based on these three properties: *query type*, *minimum row size*, and *minimum expected table size*.
- **Compressed Temps** The total number of temporary tables that were actually compressed. This implies that the table has enough data so that a compression dictionary is created for the temporary table.
- **Total Stored Temp Bytes** The total number of actual row data for temporary tables that is stored on disk. This can be from both compressed and non-compressed temporary tables.
- **Total Bytes Saved** The total bytes saved by compressing rows.
- **Total Compressed Rows** A cumulative count of the number of rows that saved at least one byte using compression.
- **Total Temp Table Rows** The total number of rows inserted into all the temporary tables, whether they are compressed or not. Not all rows inserted into a compressed temporary table are necessarily compressed.

See the **-temptable** usage notes. See also Sample output of the db2pd -temptable command.

-thresholds *thresholdID*

Returns information about thresholds. *thresholdID* is optional, but specifying a threshold ID returns information about a specific threshold. If *thresholdID* is not specified, information for all enabled and disabled thresholds is retrieved.

See the **-thresholds** usage notes. See Sample output of the db2pd -thresholds command.

-transactions

Returns information about active transactions. If a transaction handle is

specified, information is returned about that transaction handle. If an application handle is specified, information is returned about the application handle of the transaction. See the **-transactions** usage notes.

-utilities

Reports utility information. Descriptions of each reported element can be found in the utilities section of the *Database Monitoring Guide and Reference*.

-v | -version

Displays the current version and service level of the installed DB2 database product.

-wlocks

Displays the owner and waiter information for each lock being waited on. In the Sample output of the db2pd -wlocks command, the lock status (Sts) value of G designates the owner of the lock, while a Sts value of W designates the waiter of that lock.

file=filename

Sends the **-wlocks** output to a specified file.

See the **-wlocks** usage notes.

-workactionsets *workactionsetID*

Returns information about all enabled work action sets and all enabled work actions in these sets.

group Returns the same information grouped by work action set ID.

See the **-workactionsets** usage notes.

-workclasssets *workclasssetID*

Returns information about all work class sets that are referenced by an enabled work action set and all work classes in the work class sets.

group Returns the same information grouped by work class set ID.

See the **-workclasssets** usage notes.

-workloads *workloadID*

Returns the list of workload definitions, user privilege holders, and local partition workload statistics in memory at the time the command is run.

group Returns the same information grouped by workload ID.

See Sample output of the db2pd -workloads command.

See the **-workloads** usage notes.

Examples

Use the db2pd command, from the command line, in the following way to obtain information about agents that are servicing client requests:

```
db2pd -agents
```

Use the db2pd command, from the command line, in the following way to obtain information about agents that are servicing client requests. In this case, the **DB2PDOPT** environment variable is set with the **-agents** parameter before invoking the db2pd command. The command uses the information set in the environment variable when it executes.

```
export DB2PD0PT="-agents"  
db2pd
```

Use the db2pd command, from the command line, in the following way to obtain information about agents that are servicing client requests. In this case, the **-agents** parameter is set in the file file.out before invoking the db2pd command. The **-command** parameter causes the command to use the information in the file.out file when it executes.

```
echo "-agents" > file.out  
db2pd -command file.out
```

Use the db2pd command, from the command line, in the following way to obtain all database and instance-scope information:

```
db2pd -inst -alldbs
```

Use the db2pd -fvp command, from the command line, in the following way to obtain fenced vendor process state information:

For Log Manager:

- A database named SAMPLE has **logarchmeth1** set to TSM. At any time issue:

```
db2pd -db sample -fvp lam1
```

The resulting output is as follows:

```
-----  
Fenced Vendor Process State Information:  
-----
```

```
Log Manager:  
-----
```

```
LOGARCHMETH1 available.
```

```
Vendor EDU is available and running.  
  startTime: 1155581841 20060814145721  
  function: sqluvint
```

This tells you that the fenced vendor process is running in the vendor function sqluvint since August 14, 2006 14:57. Now, if you feel that this has been running too long, or you have determined that this process has hung waiting for TSM resources, you can terminate the fenced vendor process by issuing:

```
db2pd -db sample -fvp lam1 term
```

The resulting output is as follows:

```
-----  
Fenced Vendor Process State Information:  
-----
```

```
Log Manager:  
-----
```

```
LOGARCHMETH1 available.
```

```
Vendor EDU is available and running.  
  startTime: 1155581841 20060814145721  
  function: sqluvint
```

This fenced vendor process has been sent a signal to terminate.

This shows you the same information as above, but also lets you know that the terminate request has been sent. After waiting a few moments, you should notice that the request has taken affect.

- If the fenced vendor process is running, but not running in vendor code, you will see this for a regular display request:

Fenced Vendor Process State Information:

Log Manager:

LOGARCHMETH1 available.

Vendor EDU is available and running.
No vendor code being run.

For Backup:

Note: It should be noted that the FORCE APPLICATION command can be used as an alternative to what is described below.

- A database named SAMPLE is being backed up to TSM using 2 sessions. You need to find out the backup agent EDU ID, which can be found through db2pd -edus or the DB2 diagnostics log. Once found, one can issue:

db2pd -db sample -fvp 149

The resulting output is as follows:

Fenced Vendor Process State Information:

Backup:

Media Controller(s):

EDU ID: 504
mediaSession: 1
mediaSeqNum: 0
Vendor EDU is available and running.
startTime: 1155583315 20060814152155
function: sqluvint

EDU ID: 505
mediaSession: 2
mediaSeqNum: 0
Vendor EDU is available and running.
No vendor code being run.

This says that DB2 Media Controller 0 (EDU ID: 504) is in vendor code, while DB2 Media Controller 1 (EDU ID: 505) has a fenced vendor process, but is not running vendor code. Now, if you feel that this has been running too long, or you have determined that this process has hung waiting for TSM resources, you can terminate the fenced vendor process by issuing:

db2pd -db sample -fvp 149 term

The resulting output is as follows:

Fenced Vendor Process State Information:

Backup:

Media Controller(s):

EDU ID: 504
mediaSession: 1
mediaSeqNum: 0
Vendor EDU is available and running.
startTime: 1155583315 20060814152155
function: sqluvint

This fenced vendor process has been sent a signal to terminate.

```
EDU ID: 505
mediaSession: 2
mediaSeqNum: 0
Vendor EDU is available and running.
No vendor code being run.
This fenced vendor process has been sent a signal to terminate.
```

This tells you the same information as above, but notes that both fenced vendor processes have been sent terminate requests and will be terminated shortly.

Usage notes

The following sections describe the output produced by the different db2pd parameters.

- **-agents**
- **-apinfo**
- **-applications**
- **-bufferpools**
- **-catalogcache**
- **-dbcfg**
- **-dbmcfg**
- **-dynamic**
- **-fcm**
- **-fmp**
- **-locks**
- **-logs**
- **-memblocks**
- **-mempools**
- **-memsets**
- **-osinfo**
- **-pages**
- **-recovery**
- **-reopt**
- **-reorgs**
- **-scansharing**
- **-serviceclasses**
- **-static**
- **-statisticscache**
- **-storagepaths**
- **-sysplex**
- **-tablespaces**
- **-tcbstats**
- **-temptable**
- **-thresholds**
- **-transactions**
- **-wlocks**
- **-workactionsets**
- **-workclasssets**
- **-workloads**

-agents parameter

For the **-agents** parameter, the following information is returned:

AppHand1

The application handle, including the node and the index.

AgentPid

The process ID of the agent process.

Priority

The priority of the agent.

Type The type of agent.

State The state of the agent.

ClientPid

The process ID of the client process.

Userid The user ID running the agent.

ClientNm

The name of the client process.

Rowsread

The number of rows that were read by the agent.

Rowswrtn

The number of rows that were written by the agent.

LkTm0t The lock timeout setting for the agent.

-apinfo parameter

For the **-apinfo** parameter, the following information is returned:

AppHandl

The application handle, including the node and the index.

Application PID

The process ID for the application.

Application Node Name

The name of the application node.

IP Address

The IP address from which the database connection was established.

Connection Start Time

The time stamp at which the application connection started.

Client User ID

The client user ID.

System Auth ID

This is the system authorization ID of the connection.

Coordinator EDU ID

The EDU ID of the coordinator agent for the application.

Coordinator Partition

The partition number of the coordinator agent for the application.

Number of Agents

The number of agents that are working on behalf of the application.

Locks timeout value

The lock timeout value for the application.

Locks Escalation

The locks escalation flag indicates whether the lock, used by the application, has been escalated.

Workload ID

Workload identifier.

Workload Occurrence ID

Workload occurrence identifier.

Trusted Context

The name of the trusted context associated with the connection if the connection is either an implicit trusted connection or an explicit trusted connection.

Connection Trust Type

The connection trust type. This is one of: non-trusted, implicit trusted, or explicit trusted connection.

Role Inherited

This is the role inherited through a trusted connection, if any.

Application Status

The status of the application.

Application Name

The name of the application.

Application ID

The application ID. This value is the same as the **appl_id** monitor element data. For detailed information about how to interpret this value, see the “**appl_id** - Application ID monitor element”.

UOW-ID The ID of the current UOW of the application.

Activity ID

The activity ID within the UOW.

Package Schema

The package schema.

Package Name

The package name.

Package Version

The package version.

Section Number

The section number of the SQL statement.

SQL Type

The type of SQL: dynamic or static.

Isolation

The isolation mode set for the application.

Statement Type

The type of statement operation, such as: DML, DDL.

Statement

The SQL statement.

ClientUserID

Client userid for the transaction, which is the same as **tpmon_client_userid** (TP Monitor Client User ID monitor element).

ClientWrkstnName

Client workstation name for the transaction, which is the same as `tpmon_client_wkstn` (TP Monitor Client Workstation Name monitor element).

ClientApp1Name

Client application name driving the transaction, which is the same as `tpmon_client_app` (TP Monitor Client Application monitor element).

ClientAcctng

Accounting string of the client driving the transaction, which is the same as `tpmon_acc_str` (TP Monitor Client Accounting String monitor element).

See Sample output of the `db2pd -apinfo` command.

-applications parameter

For the **-applications** parameter, the following information is returned:

App1Handle

The application handle, including the node and the index.

NumAgents

The number of agents that are working on behalf of the application.

CoorPid

The process ID of the coordinator agent for the application.

Status The status of the application.

Appid The application ID. This value is the same as the **appl_id** monitor element data. For detailed information about how to interpret this value, see the documentation for the **appl_id** monitor element.

ClientIPAddress

The IP address from which the database connection was established.

EncryptionLvl

The data stream encryption used by the connection. This is one of NONE, LOW or HIGH. NONE implies that no data stream encryption is being used. LOW implies that the database server **authentication** type is set to `DATA_ENCRYPT`. HIGH implies that SSL is being used.

SystemAuthID

This is the system authorization ID of the connection.

ConnTrustType

The connection trust type. This is one of: non-trusted, implicit trusted connection, or explicit trusted connection.

TrustedContext

The name of the trusted context associated with the connection if the connection is either an implicit trusted connection or an explicit trusted connection.

RoleInherited

This is the role inherited through a trusted connection, if any.

-bufferpools parameter

For the **-bufferpools** parameter, the following information is returned:

First Active Pool ID

The ID of the first active buffer pool.

Max Bufferpool ID

The maximum ID of all active buffer pools.

Max Bufferpool ID on Disk

The maximum ID of all buffer pools defined on disk.

Num Bufferpools

The number of available buffer pools.

ID The ID of the buffer pool.

Name The name of the buffer pool.

PageSz The size of the buffer pool pages.

PA-NumPgs

The number of pages in the page area of the buffer pool.

BA-NumPgs

The number of pages in the block area of the buffer pool. This value is 0 if the buffer pool is not enabled for block-based I/O.

BlkSize

The block size of a block in the block area of the buffer pool. This value is 0 if the buffer pool is not enabled for block-based I/O.

NumTbsp

The number of table spaces that are using the buffer pool.

PgsLeft

The number of pages left to remove in the buffer pool if its size is being decreased.

CurrentSz

The current size of the buffer pool in pages.

PostAlter

The size of the buffer pool in pages when the buffer pool is restarted.

SuspdnTSCt

The number of table spaces mapped to the buffer pool that are currently I/O suspended. If 0 is returned for all buffer pools, the database I/O is not suspended.

DatLRds

Buffer Pool Data Logical Reads. Indicates the number of data pages which have been requested from the buffer pool (logical) for regular and large table spaces.

DatPRds

Buffer Pool Data Physical Reads. Indicates the number of data pages read in from the table space containers (physical) for regular and large table spaces.

HitRatio

Hit ratio for data pages in the buffer pool using formula $1 - \text{DatPRds} / \text{DatLRds}$.

TmpDatLRds

Buffer Pool Temporary Data Logical Reads. Indicates the number of data pages which have been requested from the buffer pool (logical) for temporary table spaces.

TmpDatPRds

Buffer Pool Temporary Data Physical Reads. Indicates the number of data pages read in from the table space containers (physical) for temporary table spaces.

HitRatio

Hit ratio for temporary data pages in the buffer pool using formula $1 - \text{TmpDatPRds} / \text{TmpDatLRds}$.

IdxLRds

Buffer Pool Index Logical Reads. Indicates the number of index pages which have been requested from the buffer pool (logical) for regular and large table spaces.

IdxPRds

Buffer Pool Index Physical Reads. Indicates the number of index pages read in from the table space containers (physical) for regular and large table spaces.

HitRatio

Hit ratio for index pages in the buffer pool using formula $1 - \text{IdxPRds} / \text{IdxLRds}$.

TmpIdxLRds

Buffer Pool Temporary Index Logical Reads. Indicates the number of index pages which have been requested from the buffer pool (logical) for temporary table spaces.

TmpIdxPRds

Buffer Pool Temporary Index Physical Reads. Indicates the number of index pages read in from the table space containers (physical) for temporary table spaces.

HitRatio

Hit ratio for temporary index pages in the buffer pool using formula $1 - \text{TmpIdxPRds} / \text{TmpIdxLRds}$.

DataWrts

Buffer Pool Data Writes. Indicates the number of times a buffer pool data page was physically written to disk.

IdxWrts

Buffer Pool Index Writes. Indicates the number of times a buffer pool index page was physically written to disk.

DirRds Direct Reads From Database. The number of read operations that do not use the buffer pool.

DirRdReqs

Direct Read Requests. The number of requests to perform a direct read of one or more sectors of data.

DirRdTime

Direct Read Time. The elapsed time (in milliseconds) required to perform the direct reads.

DirWrts

Direct Writes to Database. The number of write operations that do not use the buffer pool.

DirWrtReqs

Direct Write Requests. The number of requests to perform a direct write of one or more sectors of data.

DirWrtTime

Direct Write Time. The elapsed time (in milliseconds) required to perform the direct writes.

AsDatRds

Buffer Pool Asynchronous Data Reads. Indicates the number of data pages read in from the table space containers (physical) by asynchronous engine dispatchable units (EDUs) for all types of table spaces.

AsDatRdReq

Buffer Pool Asynchronous Read Requests. The number of asynchronous read requests.

AsIdxRds

Buffer Pool Asynchronous Index Reads. Indicates the number of index pages read in from the table space containers (physical) by asynchronous engine dispatchable units (EDUs) for all types of table spaces.

AsIdxRdReq

Buffer Pool Asynchronous Index Read Requests. The number of asynchronous read requests for index pages.

AsRdTime

Buffer Pool Asynchronous Read Time. Indicates the total amount of time spent reading in data and index pages from the table space containers (physical) by asynchronous engine dispatchable units (EDUs) for all types of table spaces. This value is given in microseconds.

AsDatWrts

Buffer Pool Asynchronous Data Writes. The number of times a buffer pool data page was physically written to disk by either an asynchronous page cleaner, or a prefetcher. A prefetcher might have written dirty pages to disk to make space for the pages being prefetched.

AsIdxWrts

Buffer Pool Asynchronous Index Writes. The number of times a buffer pool index page was physically written to disk by either an asynchronous page cleaner, or a prefetcher. A prefetcher might have written dirty pages to disk to make space for the pages being prefetched.

AsWrtTime

Buffer Pool Asynchronous Write Time. The total elapsed time spent writing data or index pages from the buffer pool to disk by database manager page cleaners.

TotRdTime

Total Buffer Pool Physical Read Time. Indicates the total amount of time spent reading in data and index pages from the table space containers (physical) for all types of table spaces. This value is given in microseconds.

TotWrtTime

Total Buffer Pool Physical Write Time. Provides the total amount of time spent physically writing data or index pages from the buffer pool to disk. Elapsed time is given in microseconds.

VectIORds

Total Number of Pages Read by Vectored IO. The total number of pages read by vectored I/O into the page area of the buffer pool.

VectIOReq

Number of Vectored IO Requests. The number of vectored I/O requests.

More specifically, the number of times the DB2 database product performs sequential prefetching of pages into the page area of the buffer pool.

BlockIORds

Total Number of Pages Read by Block IO. The total number of pages read by block I/O into the block area of the bufferpool.

BlockIOReq

Number of Block IO Requests. The number of block I/O requests. More specifically, the number of times the DB2 database product performs sequential prefetching of pages into the block area of the bufferpool.

PhyPgMaps

Number of Physical Page Maps. The number of physical page maps.

FilesClose

Database Files Closed. The total number of database files closed.

NoVictAv1

Buffer Pool No Victim Buffers. Number of times an agent did not have a preselected victim buffer available.

UnRdPFetch

Unread Prefetch Pages. Indicates the number of pages that the prefetcher read in that were never used.

-catalogcache parameter

For the **-catalogcache** parameter, the following information is returned:

Catalog Cache:

Configured Size

The number of bytes as specified by the **catalogcache_sz** database configuration parameter.

Current Size

The current number of bytes used in the catalog cache.

Maximum Size

The maximum amount of memory that is available to the cache (up to the maximum database global memory).

High Water Mark

The largest physical size reached during processing.

SYSTABLES:

Schema The schema qualifier for the table.

Name The name of the table.

Type The type of the table.

TableID

The table identifier.

TbpaceID

The identifier of the table space where the table resides.

LastRefID

The last process identifier that referenced the table.

CatalogCache LoadingLock

The name of the catalog cache loading lock for the cache entry.

CatalogCache UsageLock

The name of the usage lock for the cache entry.

Sts

The status of the entry. The possible values are:

- V (valid).
- I (invalid).
- S (soft invalid. Catalog cache entries become *soft invalid* when statistics have been updated by real-time statistics collection. These catalog cache entries may still be used by a database agent, but they are not valid for use by a new catalog cache request. Once the soft invalid entry is no longer in use, it will be removed. New catalog cache requests will use the valid entry.)

SYSRTNS:**RoutineID**

The routine identifier.

Schema The schema qualifier of the routine.

Name The name of the routine.

LastRefID

The last process identifier that referenced the routine.

CatalogCache LoadingLock

The name of the catalog cache loading lock for the cache entry.

CatalogCache UsageLock

The name of the usage lock for the cache entry.

Sts

The status of the entry. The possible values are:

- V (valid).
- I (invalid).

SYSRTNS_PROCSCHEMAS:**RtnName**

The name of the routine.

ParmCount

The number of parameters in the routine.

LastRefID

The last process identifier that referenced the PROCSCHEMAS entry.

CatalogCache LoadingLock

The name of the catalog cache loading lock for the cache entry.

CatalogCache UsageLock

The name of the usage lock for the cache entry.

Sts

The status of the entry. The possible values are:

- V (valid).
- I (invalid).

SYSDATATYPES:

TypID The type identifier.

LastRefID

The last process identifier that referenced the type.

CatalogCache LoadingLock

The name of the catalog cache loading lock for the cache entry.

CatalogCache UsageLock

The name of the usage lock for the cache entry.

Sts The status of the entry. The possible values are:

- V (valid).
- I (invalid).

SYSCODEPROPERTIES:**LastRefID**

The last process identifier to reference the SYSCODEPROPERTIES entry.

CatalogCache LoadingLock

The name of the catalog cache loading lock for the cache entry.

CatalogCache UsageLock

The name of the usage lock for the cache entry.

Sts The status of the entry. The possible values are:

- V (valid).
- I (invalid).

SYSNODEGROUPS:

PMapID The distribution map identifier.

RBalID The identifier if the distribution map that was used for the data redistribution.

CatalogCache LoadingLock

The name of the catalog cache loading lock for the cache entry.

CatalogCache UsageLock

The name of the usage lock for the cache entry.

Sts The status of the entry. The possible values are:

- V (valid).
- I (invalid).

SYSDBAUTH:

AuthID The authorization identifier (*authid*).

AuthType

The authorization type.

LastRefID

The last process identifier to reference the cache entry.

CatalogCache LoadingLock

The name of the catalog cache loading lock for the cache entry.

SYSRTNAUTH:

AuthID The authorization identifier (*authid*).

AuthType

The authorization type.

Schema The schema qualifier of the routine.

RoutineName

The name of the routine.

RtnType

The type of the routine.

CatalogCache LoadingLock

The name of the catalog cache loading lock for the cache entry.

SYSROLEAUTH:

AuthID The authorization identifier (authid).

AuthType

The authorization type.

Roleid The role identifier if the authorization identifier is a role.

LastRefID

The last process identifier to reference the cache entry.

CatalogCache LoadingLock

The name of the catalog cache loading lock for the cache entry.

See Sample output of the db2pd -catalogcache command.

-dbcfg parameter

For the **-dbcfg** parameter, the current values of the database configuration parameters are returned.

-dbmcfg parameter

For the **-dbmcfg** parameter, current values of the database manager configuration parameters are returned.

-dynamic parameter

For the **-dynamic** parameter, the following information is returned:

Dynamic Cache:**Current Memory Used**

The number of bytes used by the package cache.

Total Heap Size

The number of bytes configured internally for the package cache.

Cache Overflow flag state

A flag to indicate whether the package cache is in an overflow state.

Number of references

The number of times the dynamic portion of the package cache has been referenced.

Number of Statement Inserts

The number of statement inserts into the package cache.

Number of Statement Deletes

The number of statement deletions from the package cache.

Number of Variation Inserts

The number of variation inserts into the package cache.

Number of statements

The number of statements in the package cache.

Dynamic SQL Statements:

AnchID The hash anchor identifier.
StmtID The statement identifier.
NumEnv The number of environments that belong to the statement.
NumVar The number of variations that belong to the statement.
NumRef The number of times that the statement has been referenced.
NumExe The number of times that the statement has been executed.
Text The text of the SQL statement.

Dynamic SQL Environments:

AnchID The hash anchor identifier.
StmtID The statement identifier.
EnvID The environment identifier.
Iso The isolation level of the environment.
QOpt The query optimization level of the environment.
Blk The blocking factor of the environment.

Dynamic SQL Variations:

AnchID The hash anchor identifier.
StmtID The statement identifier for this variation.
EnvID The environment identifier for this variation.
VarID The variation identifier.
NumRef The number of times this variation has been referenced.
Typ The internal statement type value for the variation section.
Lockname
The variation lockname.

-fcm parameter

For the -fcm parameter, the following information is returned:

FCM Usage Statistics:

Total Buffers
Total number of buffers, including all free and in-use ones.

Free Buffers
Number of free buffers.

Buffers LWM
Lowest number of free buffers.

Total Channels
Total number of channels, including all free and in-use ones.

Free Channels
Number of free channels.

Channels LWM
Lowest number of free channels.

Total Sessions

Total number of sessions, including all free and in-use ones.

Free Sessions

Number of free sessions.

Sessions LWM

Lowest number of free sessions.

Partition

The database partition server number.

Bufs Sent

The total number of FCM buffers that are sent from the database partition server where the db2pd command is running to the database partition server that is identified in the output.

Bufs Recv

The total number of FCM buffers that are received by the database partition server where the db2pd command is running from the database partition server that is identified in the output.

Status The logical connection status between the database partition server where the db2pd command is running and the other database partition servers that are listed in the output. The possible values are:

- **Inactive:** The database partition server is defined in the Database Partitioning Feature (DPF) configuration but is currently inactive (for example, the user has stopped the partition).
- **Active:** The database partition server is active.
- **Undefined:** The database partition server is not defined in the Database Partitioning Feature (DPF) configuration. This might indicate an error.
- **Unknown:** The database partition server is in an unknown state. This indicates an error.

Buffers Current Consumption**AppHandl**

The application handle, including the node and the index.

TimeStamp

A unique identifier for the usage of an application handle.

Buffers In-use

The number of buffers currently being used by an application.

Channels Current Consumption**AppHandl**

The application handle, including the node and the index.

TimeStamp

A unique identifier for the usage of an application handle.

Channels In-use

The number of channels currently being used by an application.

Buffers Consumption HWM**AppHandl**

The application handle, including the node and the index.

TimeStamp

A unique identifier for the usage of an application handle.

Buffers Used

The high-watermark number of buffers used by an application since the start of the instance.

Channels Consumption HWM**AppHand1**

The application handle, including the node and the index.

TimeStamp

A unique identifier for the usage of an application handle.

Channels Used

The high-watermark number of channels used by an application since the start of the instance.

-fmp parameter

For the **-fmp** parameter, the following information is returned:

- Pool Size: Current number of FMP processes in the FMP pool.
- Max Pool Size: Maximum number of FMP process in the FMP pool.
- Keep FMP: Value of **keepfenced** database manager configuration parameter.
- Initialized: FMP is initialized. Possible values are Yes and No.
- Trusted Path: Path of trusted procedures
- Fenced User: Fenced user ID

FMP Process:

- FmpPid: Process ID of the FMP process.
- Bit: Bit mode. Values are 32 bit or 64 bit.
- Flags: State flags for the FMP process. Possible values are:
 - 0x00000000 - JVM initialized
 - 0x00000002 - Is threaded
 - 0x00000004 - Used to run federated wrappers
 - 0x00000008 - Used for Health Monitor
 - 0x00000010 - Marked for shutdown and will not accept new tasks
 - 0x00000020 - Marked for cleanup by db2sysc
 - 0x00000040 - Marked for agent cleanup
 - 0x00000100 - All ipc's for the process have been removed
 - 0x00000200 - .NET runtime initialized
 - 0x00000400 - JVM initialized for debugging
 - 0x00000800 - Termination flag
- ActiveTh: Number of active threads running in the FMP process.
- PooledTh: Number of pooled threads held by the FMP process.
- Active: Active state of the FMP process. Values are Yes or No.

Active Threads:

- FmpPid: FMP process ID that owns the active thread.
- EduPid: EDU process ID that this thread is working.
- ThreadId: Active thread ID.

Pooled Threads:

- FmpPid: FMP process ID that owns the pooled thread.
- ThreadId: Pooled thread ID.

-locks parameter

For the **-locks** parameter, the following information is returned:

TranHdl

The transaction handle that is requesting the lock.

Lockname

The name of the lock.

Type The type of lock. The possible values are:

- Row
- Pool
- Partition
- Table
- AlterTab
- ObjectTab
- OnlBackup
- DMS Seq
- Internal P
- Internal V
- Key Value
- No Lock
- Block Lock
- LOG Release
- LF Release
- LFM File
- LOB/LF 4K
- APM Seq
- Tbsp Load
- Table Part
- DJ UserMap
- DF NickNm
- CatCache
- OnlReorg
- Buf Pool

Mode The lock mode. The possible values are:

- IS
- IX
- S
- SIX
- X
- IN
- Z
- U
- NS
- NW

Sts The lock status. The possible values are:

- G (granted)
- C (converting)
- W (waiting)

Owner The transaction handle that owns the lock.

Dur The duration of the lock.

HoldCount

The number of holds placed on the lock. Locks with holds are not released when transactions are committed.

Att The attributes of the lock. Possible values are:

- 0x01 Wait for availability.
- 0x02 Acquired by escalation.
- 0x04 RR lock "in" block.
- 0x08 Insert Lock.
- 0x10 Lock by RR scan.
- 0x20 Update/delete row lock.
- 0x40 Allow new lock requests.
- 0x80 A new lock requestor.

ReleaseFlg

The lock release flags. Possible values are:

- 0x80000000 Locks by SQL compiler.
- 0x40000000 Non-unique, untracked locks.

rrIID The IID of the index through which the RR lock (0x10 attribute above) was acquired. Possible values are:

- 0 Not related to a single, specific index (or not an RR lock).
- <>0 The specific index IID used to acquire the lock.

-logs parameter

For the **-logs** parameter, the following information is returned:

Current Log Number

The number of the current active log.

Pages Written

The current page being written in the current log.

Cur Commit Disk Log Reads

The number of times the currently committed version of a row was retrieved via a log read from disk (versus log buffer).

Cur Commit Total Log Reads

The total number of times the currently committed version of a row was retrieved from the logs (log buffer and disk).

Method 1 Archive Status

The result of the most recent log archive attempt. Possible values are Success or Failure.

Method 1 Next Log to Archive

The next log file to be archived.

Method 1 First Failed

The first log file that was unsuccessfully archived.

Method 2 Archive Status

The result of the most recent log archive attempt. Possible values are Success or Failure.

Method 2 Next Log to Archive

The next log file to be archived.

Method 2 First Failed

The first log file that was unsuccessfully archived.

StartLSN

The starting log sequence number.

State 0x00000020 indicates that the log has been archived.

Size The size of the log's extent, in pages.

Pages The number of pages in the log.

Filename

The file name of the log.

-memblocks parameter

For the **-memblocks** parameter, there are three sections of output: individual blocks for the memory set, sorted totals grouped by memory pool, and sorted totals for the memory set:

Memory blocks:

PoolID The memory pool id that owns the memory block.

PoolName

The memory pool name that owns the memory block.

BlockAge

The block age of the memory block. This is an incremental counter assigned as blocks are allocated.

Size The size of the memory block in bytes.

I The type of allocation. Value 1 means block will be freed individually while value 0 means it will be freed with the pool.

LOC Line of code that allocated the memory block.

File Filename hash value from where the block was allocated.

Sorted totals reported for each memory pool:

PoolID The memory pool id that owns the memory block.

PoolName

The memory pool name that owns the memory block.

TotalSize

The total size of blocks (in bytes) allocated from the same line of code and file.

TotalCount

The number of blocks allocated from the same line of code and file.

LOC Line of code that allocated the memory block.

File Filename hash value from where the block was allocated.

Sorted totals reported for each memory set:

PoolID The memory pool id that owns the memory block.

PoolName

The memory pool name that owns the memory block.

TotalSize

The total size of blocks (in bytes) allocated from the same line of code and file.

%Bytes The percentage bytes allocated from the same line of code and file.

TotalCount

The number of blocks allocated from the same line of code and file.

%Count The percentage count allocated from the same line of code and file.

LOC Line of code that allocated the memory block.

File Filename hash value from where the block was allocated.

-mempools parameter

For the **-mempools** parameter, the following information is returned (All sizes are specified in bytes):

MemSet The memory set that owns the memory pool.

PoolName

The name of the memory pool.

Id The memory pool identifier.

Overhead

The internal overhead required for the pool structures.

LogSz The current total of pool memory requests.

LogUpBnd

The current logical size upper bound.

LogHWM The logical size high water mark.

PhySz The physical memory required for logical size.

PhyUpBnd

The current physical size upper bound.

PhyHWM The largest physical size reached during processing.

Bnd The internal bounding strategy.

BlkCnt The current number of allocated blocks in the memory pool.

CfgParm

The configuration parameter that declares the size of the pool being reported.

-memsets parameter

For the **-memsets** parameter, the following information is returned:

Name The name of the memory set.

Address

The address of the memory set.

Id The memory set identifier.

Size(Kb)

The size of the memory set in kilobytes.

Key The memory set key (for UNIX operating systems only).

DBP The database partition server that owns the memory set.

Type The type of memory set.

Unrsv(Kb)

Memory not reserved for any particular pool. Any pool in the set can use this memory if needed.

Used(Kb)

Memory currently allocated to memory pools.

Cmt(Kb)

All memory that has been committed by the DB2 database, and occupies physical RAM, paging space, or both.

HWM(Kb)

Maximum memory ever allocated to memory pools.

Uncmt(Kb)

Memory not currently being used, and marked by the DB2 database to be uncommitted. Depending on the operating system, this memory could occupy physical RAM, paging space, or both.

-osinfo parameter

For the **-osinfo** parameter, the following information is returned:

CPU information: (On Windows, AIX, HP-UX, Solaris and Linux operating systems)

TotalCPU

Total number of CPUs.

OnlineCPU

Number of CPUs online.

ConfigCPU

Number of CPUs configured.

Speed(MHz)

Speed, in MHz, of CPUs.

HMTDegree

Systems supporting hardware multithreading return a value showing the number of processors that will appear to be present on the operating system. On nonHMT systems, this value is always 1. On HMT systems, TOTAL reflects the number of logical CPUs. To get the number of physical CPUs, divide the total by THREADING DEGREE.

Timebase

Frequency, in Hz, of the timebase register increment. This is supported on Linux PPC only.

Physical memory and swap in megabytes: (On Windows, AIX, HP-UX, Solaris and Linux operating systems)

TotalMemTotal

Size of memory in megabytes.

FreeMem

Amount of free memory in megabytes.

AvailMem

Amount of memory available to the product in megabytes.

TotalSwap

Total amount of swapspace in megabytes.

FreeSwap

Amount of swapspace free in megabytes.

Virtual memory in megabytes (On Windows, AIX, HP-UX, and Solaris operating systems)

Total Total amount of virtual memory on the system in megabytes.

Reserved

Amount of reserved virtual memory in megabytes.

Available

Amount of virtual memory available in megabytes.

Free

Amount of virtual memory free in megabytes.

Operating system information (On Windows, AIX, HP-UX, Solaris and Linux operating systems)

OSName Name of the operating system software.

NodeName

Name of the system.

Version

Version of the operating system.

Machine

Machine hardware identification.

Message queue information (On AIX, HP-UX, and Linux operating systems)

MsgSeg System-wide total of SysV msg segments.

MsgMax System-wide maximum size of a message.

MsgMap System-wide number of entries in message map.

MsgMni System-wide number of message queue identifiers for system.

MsgTql System-wide number of message headers.

MsgMnb Maximum number of bytes on a message queue.

MsgSsz Message segment size.

Shared memory information (On AIX, HP-UX, and Linux operating systems)

ShmMax System-wide maximum size of a shared memory segment in bytes.

ShmMin System-wide minimum size of a shared memory segment in bytes.

ShmIds System-wide number of shared memory identifiers.

ShmSeg Process-wide maximum number of shared memory segments per process.

Semaphore information: (On AIX, HP-UX, and Linux operating systems)

SemMap System-wide number of entries in semaphore map.

SemMni System-wide maximum number of a semaphore identifiers.

SemMns System-wide maximum number of semaphores on system.

- SemMnu** System-wide maximum number of undo structures on system.
- SemMs1** System-wide maximum number of semaphores per ID.
- SemOpm** System-wide maximum number of operations per semop call.
- SemUme** Process-wide maximum number of undo structures per process.
- SemUsz** System-wide size of undo structure. Derived from semume.
- SemVmx** System-wide maximum value of a semaphore.
- SemAem** System-wide maximum adjust on exit value.

CPU load information (On Windows, AIX, HP-UX, Solaris, and Linux operating systems)

shortPeriod

The number of runnable processes over the preceding 1 minute.

mediumPeriod

The number of runnable processes over the preceding 5 minutes.

longPeriod

The number of runnable processes over the preceding 15 minutes.

Disk information

BkSz(bytes)

File system block size in bytes.

Total(bytes)

Total number of bytes on the device in bytes.

Free(bytes)

Number of free bytes on the device in bytes.

Inodes Total number of inodes.

FSID File system ID.

DeviceType

Device type.

FSName File system name.

MountPoint

Mount point of the file system.

-pages parameter

For the **-pages** parameter, the following information is returned for each page:

BPID Bufferpool ID that contains the page.

TbSpaceID

Table space ID that contains the page.

TbSpacePgNum

Logical page number within the table space (DMS only).

ObjID Object ID that contains the page.

ObjPgNum

Logical page number within the object.

ObjClass

Class of object contained in the page. Possible values are Perm, Temp, Reorg, Shadow, and EMP.

ObjType

Type of object contained in the page. Possible values are Data, Index, LongField, XMLData, SMP, LOB, LOBA, and MDC_BMP.

Dirty Indicates if the page is dirty. Possible values are Y and N. In the summary information section of the pages output, the value indicates the number of dirty pages.

Permanent

In the summary information section of the pages output, the value indicates the number of PERMANENT pages.

Temporary

In the summary information section of the pages output, the value indicates the number of TEMPORARY pages.

Prefetched

Indicates if the page has been prefetched. Possible values are Y and N.

See Sample output of the db2pd -pages command.

-recovery parameter

For the **-recovery** parameter, the following information is returned:

Recovery Status

The internal recovery status.

Current Log

The current log being used by the recovery operation.

Current LSN

The current log sequence number.

Job Type

The type of recovery being performed. The possible values are:

- 5: Crash recovery.
- 6: Rollforward recovery on either the database or a table space.

Job ID The job identifier.

Job Start Time

The time the recovery operation started.

Job Description

A description of the recovery activity. The possible values are:

- Tablespace Rollforward Recovery
- Database Rollforward Recovery
- Crash Recovery

Invoker Type

How the recovery operation was invoked. The possible values are:

- User
- DB2

Total Phases

The number of phases required to complete the recovery operation.

Current phase

The current phase of the recovery operation.

Phase The number of the current phase in the recovery operation.

Forward phase

The first phase of rollforward recovery. This phase is also known as the REDO phase.

Backward phase

The second phase of rollforward recovery. This phase is also known as the UNDO phase.

Metric The units of work. The possible values are:

- 1: Bytes.
- 2: Extents.
- 3: Rows.
- 4: Pages.
- 5: Indexes

TotWkUnits

The total number of units of work (UOW) to be done for this phase of the recovery operation.

TotCompUnits

The total number of UOWs that have been completed.

-reopt parameter

For the **-reopt** parameter, the following information is returned:

Dynamic SQL Statements

See **-dynamic**.

Dynamic SQL Environments

See the **-dynamic**.

Dynamic SQL Variations

See the **-dynamic**.

Reopt Values

Displays information about the variables that were used to reoptimize a given SQL statement. Information is not returned for variables that were not used. Valid values are:

AnchID The hash anchor identifier.

StmtID The statement identifier for this variation.

EnvID The environment identifier for this variation.

VarID The variation identifier.

OrderNum

Ordinal number of the variable that was used to reoptimize of the SQL statement

SQLZType

The variable type.

CodPg The variable code page.

Nu1ID The flag indicating whether or not the value is null-terminated.

Len The length in bytes of the variable value.

Data The value used for the variable.

-reorgs parameter

For the **-reorgs** parameter, the following information is returned:

Table Reorg Information:

Address

A hexadecimal value.

TabSpaceID

The table space identifier.

TableID

The table identifier.

PartID The data partition identifier. One row is returned for each data partition, showing the reorganization information.

MasterTbs

For partitioned tables, this is the logical table space identifier to which the partitioned table belongs. For non-partitioned tables, this value corresponds to the TbspaceID.

MasterTab

For partitioned tables, this is the logical table identifier of the partitioned table. For non-partitioned tables, this value corresponds to the TableID.

TableName

The name of the table.

Type The type of reorganization. The possible values are:

- Online
- Offline

IndexID

The identifier of the index that is being used to reorganize the table.

TempSpaceID

The table space in which the table is being reorganized.

Table Reorg Stats:

Address

A hexadecimal value.

TableName

The name of the table.

Start The time that the table reorganization started.

End The time that the table reorganization ended.

PhaseStart

The start time for a phase of table reorganization.

MaxPhase

The maximum number of reorganization phases that will occur during the reorganization. This value only applies to offline table reorganization.

Phase The phase of the table reorganization. This value only applies to offline table reorganization. The possible values are:

- Sort
- Build
- Replace
- InxRecreat

CurCount

A unit of progress that indicates the amount of table reorganization that has been completed. The amount of progress represented by this value is relative to the value of MaxCount, which indicates the total amount of work required to reorganize the table.

MaxCount

A value that indicates the total amount of work required to reorganize the table. This value can be used in conjunction with CurCount to determine the progress of the table reorganization.

Status The status of an online table reorganization. This value does not apply to offline table reorganizations. The possible values are:

- Started
- Paused
- Stopped
- Done
- Truncat

Completion

The success indicator for the table reorganization. The possible values are:

- 0: The table reorganization completed successfully.
- -1: The table reorganization failed.

```
db2pd -db wsdb -reorgs file=reorg_pd.out
```

Table Reorg Information:

Address	TbSpaceID	TableID	PartID	MasterTbs	MasterTab	TableName	Type	IndexID
0x00002B214C24D5A8	2	4	n/a	n/a	n/a	T1	Reclaim	0

Table Reorg Stats:

Address	TableName	Start	End	PhaseStart
0x00002B214C24D5A8	T1	10/21/2008 13:24:05	10/21/2008 13:24:05	10/21/2008 13:24:05

-scansharing parameter

For the **-scansharing** parameter, the following fields are returned, specific to the headings:

Individual shared scan

- Agent ID
- Application ID
- ScanMode (prewrap or postwrap)
- IsScanWrappable
- Scan speed
- Time spent getting throttled
- Relative location of scan in pages within group (for block index scans).
Absolute location of scan in pages (for table and range scans)
- Predicted speed category (SLOW or FAST)

- Remaining pages to process (accurate for table and range scans). For block index scans, the optimizer estimate is returned instead.

See Sample output of the db2pd -scansharing command.

Sharing set

- Tablespace ID
- Table ID
- Scan object (0 for table scans or ID of block index)
- Number of groups
- Sharing set footprint in pages
- Table size in pages (for table scans and block index scans on nonpartitioned tables, and for range scans on partitioned tables; for block index scans on partitioned tables the value is unknown)
- Fast scan speed (speed at which FAST scans are going)
- Slow scan speed (speed at which SLOW scans are going)

Sharing group

- Number of scans in the group
- Group footprint (in number of pages)

-serviceclasses parameter

For the **-serviceclasses** parameter, the following fields are returned, specific to the headings:

Service class fields:

- Service Class Name: Name of service class
- Service Class ID: System generated ID of service class
- Service Class Type: Type of service class: superclass or subclass
- Service Class State (Effective and Catalog): State of service class: enabled or disabled
- Effective Agent Priority and Catalog Agent Priority: Effective agent priority setting for service class that maps to priority recorded in SYSCAT.SERVICECLASSES
- Effective Prefetch Priority and Catalog Prefetch Priority: Effective prefetch priority setting for service class that maps to priority recorded in SYSCAT.SERVICECLASSES
- Effective Bufferpool Priority and Catalog Bufferpool Priority: Effective buffer pool priority setting for service class that maps to priority recorded in SYSCAT.SERVICECLASSES
- Effective Outbound Correlator and Catalog Outbound Correlator: Effective outbound correlator setting for service class that maps to correlator recorded in SYSCAT.SERVICECLASSES)
- Last Statistics Reset Time: Timestamp of last statistics reset for service class

Service superclass fields:

- Default Subclass ID: Service class ID of Default Subclass
- Work Action Set ID: ID of work action set associated with service superclass
- Collect Request Metrics: Setting of COLLECT REQUEST METRICS option for service class

- Num Connections: Current number of coordinator and remote connections in service superclass
- Num Coordinator Connections: Current number of coordinator connections in service superclass
- Coordinator Connections HWM: High water mark for coordinator connections since last statistics reset
- Associated Workload Occurrences (WLO): List of workload occurrences currently in service superclass

Service subclass fields:

- Parent Superclass ID: Service class ID of parent superclass
- Collect Activity Opt: Setting of COLLECT ACTIVITY DATA option for service subclass
- Collect Aggr Activity Opt: Setting of COLLECT AGGREGATE ACTIVITY option for service subclass
- Collect Aggr Request Opt: Setting of COLLECT AGGREGATE REQUEST option for service subclass
- Act Lifetime Histogram Template ID: ID of Activity Lifetime Histogram Template
- Act Queue Time Histogram Template ID: ID of Activity Queue Time Histogram Template
- Act Execute Time Histogram Template ID: ID of Activity Execute Time Histogram Template
- Act Estimated Cost Histogram Template ID: ID of Activity Estimated Cost Histogram Template
- Act Interarrival Time Histogram Template ID: ID of Activity Interarrival Time Histogram Template
- Request Execute Time Histogram Template ID: ID of Request Execute Time Histogram Template
- Access Count: Current number of activities in service subclass
- Activities HWM: High water mark for activities since last statistics reset, counting both activities that entered the system through this subclass and activities that you remap into this subclass by a REMAP ACTIVITY threshold action.
- Activities Completed: Total number of activities completed since last statistics reset. If you remap an activity to a different subclass with a REMAP ACTIVITY action before it completes, then this activity counts only towards the total of the subclass it completes in.
- Activities Rejected: Total number of activities rejected since last statistics reset
- Activities Aborted: Total number of activities aborted since last statistics reset. If you remap an activity to a different subclass with a REMAP ACTIVITY action before it aborts, then this activity counts only towards the total of the subclass it aborts in.
- Associated Agents: List of agent currently working in service subclass
- Associated Non-agent threads: List of non-agent entities currently working in service subclass

See Sample output of the db2pd -serviceclasses command.

-static parameter

For the **-static** parameter, the following information is returned:

Static Cache:

Current Memory Used

The number of bytes used by the package cache.

Total Heap Size

The number of bytes internally configured for the package cache.

Cache Overflow flag state

A flag to indicate whether the package cache is in an overflow state.

Number of References

The number of references to packages in the package cache.

Number of Package Inserts

The number of package inserts into the package cache.

Number of Section Inserts

The number of static section inserts into the package cache.

Packages:

Schema The qualifier of the package.

PkgName

The name of the package.

Version

The version identifier of the package.

UniqueID

The consistency token associated with the package.

NumSec The number of sections that have been loaded.

UseCount

The usage count of the cached package.

NumRef The number of times the cached package has been referenced.

Iso The isolation level of the package.

QOpt The query optimization of the package.

Blk The blocking factor of the package.

Lockname

The lockname of the package.

Sections:

Schema The qualifier of the package that the section belongs to.

PkgName

The package name that the section belongs to.

UniqueID

The consistency token associated with the package that the section belongs to.

SecNo The section number.

NumRef The number of times the cached section has been referenced.

UseCount

The usage count of the cached section.

StmtType

The internal statement type value for the cached section.

Cursor The cursor name (if applicable).

W-Hld Indicates whether the cursor is a WITH HOLD cursor.

-statisticscache parameter

For the **-statisticscache** parameter, the following information is returned:

Current Size

The current number of bytes used in the statistics cache.

Address

The address of the entry in the statistics cache.

Schema The schema qualifier for the table.

Name The name of the table.

LastRefID

The last process identifier that referenced the table.

LastStatsTime

The time for the latest statistics collection for the table.

Sts The status of the entry. The possible values are:

- V (valid).
- I (invalid).

For additional details about the returned information using the **-statisticscache** command parameter, see the topic “Catalog statistics tables” in *Troubleshooting and Tuning Database Performance*

-storagepaths parameter

For the **-storagepaths** parameter, the following information is returned:

Number of Storage Paths

The number of automatic storage paths defined for the database.

PathName

The name of an automatic storage path defined for the database. If the path contains a database partition expression, it is included, in parentheses, after the expanded path.

PathID The storage path identifier.

PathState

Current state of the storage path: NotInUse, InUse, or DropPending.

See Sample output of the db2pd -storagepaths command.

-sysplex parameter

For the **-sysplex** parameter, the following information is returned:

Alias The database alias.

Location Name

The unique name of the database server.

Count The number of entries found in the list of servers.

IP Address

The IP address of the server

Port The IP port being used by the server.

Priority

The normalized Workload Manager (WLM) weight.

Connections

The number of active connections to this server.

Status The status of the connection. The possible values are:

- 0: Healthy.
- 1: Unhealthy. The server is in the list but a connection cannot be established. This entry currently is not considered when establishing connections.
- 2: Unhealthy. The server was previously unavailable, but currently it will be considered when establishing connections.

PRDID The product identifier of the server as of the last connection.

-tablespaces parameter

For the **-tablespaces** parameter, the output is organized into four segments:

Table space Configuration:

Id The table space ID.

Type The type of table space. The possible values are:

- SMS
- DMS

Content

The type of content. The possible values are:

- Regular
- Large
- SysTmp
- UsrTmp

PageSz The page size used for the table space.

ExtentSz

The size of an extent in pages.

Auto Indicates whether the prefetch size is set to AUTOMATIC. The possible values are:

- Yes
- No

Prefetch

The number of pages read from the table space for each range prefetch request.

BufID The ID of the buffer pool that this table space is mapped to.

BufIDDisk

The ID of the buffer pool that this table space will be mapped to at next startup.

FSC

File system caching, indicates whether buffered I/O was specified by the user at CREATE TABLESPACE or ALTER TABLESPACE time. The possible values are:

- Yes
- No

NumCntrs

The number of containers owned by a table space.

MaxStripe

The maximum stripe set currently defined in the table space (applicable to DMS table spaces only).

LastConsecPg

The last consecutive object table extent.

Name

The name of the table space.

Table space Statistics:**Id**

The table space ID.

TotalPages

For DMS table spaces, the sum of the gross size of each of the table space's containers (reported in the total pages field of the container).

For SMS table spaces, this value reflects the number of pages in the filesystem owned by the table space.

UsablePgs

For DMS table spaces, the sum of the net size of each of the table space's containers (reported in the usable pages field of the container).

For SMS table spaces, this value reflects the number of pages in the filesystem owned by the table space.

UsedPgs

For DMS table spaces, the total number of pages currently in use in the table space.

For SMS table spaces, this value reflects the number of pages in the filesystem owned by the table space.

PndFreePgs

The number of pages that are not available for use but will be available if all the currently outstanding transactions commit.

FreePgs

For DMS table spaces, the number of pages available for use in the table space.

For SMS table spaces, this value is always 0.

HWM

The highest allocated page in the table space.

State

- 0x00000000 - NORMAL
- 0x00000001 - QUIESCED: SHARE
- 0x00000002 - QUIESCED: UPDATE
- 0x00000004 - QUIESCED: EXCLUSIVE

- 0x00000008 - LOAD PENDING
- 0x00000010 - DELETE PENDING
- 0x00000020 - BACKUP PENDING
- 0x00000040 - ROLLFORWARD IN PROGRESS
- 0x00000080 - ROLLFORWARD PENDING
- 0x00000100 - RESTORE PENDING
- 0x00000200 - DISABLE PENDING
- 0x00000400 - REORG IN PROGRESS
- 0x00000800 - BACKUP IN PROGRESS
- 0x00010000 - STORAGE MUST BE DEFINED
- 0x00020000 - RESTORE IN PROGRESS
- 0x00040000 - OFFLINE
- 0x00080000 - DROP PENDING
- 0x00100000 - WRITE SUSPENDED
- 0x00200000 - LOAD IN PROGRESS
- 0x02000000 - STORAGE MAY BE DEFINED
- 0x04000000 - STORAGE DEFINITION IS IN FINAL STATE
- 0x08000000 - STORAGE DEFINITION CHANGED PRIOR TO ROLLFORWARD
- 0x10000000 - DMS REBALANCER IS ACTIVE
- 0x20000000 - DELETION IN PROGRESS
- 0x40000000 - CREATION IN PROGRESS

MinRecTime

The minimum recovery time for the table space.

NQuiescers

The number of quiescers.

PathsDropped

For automatic storage table spaces, specifies whether one or more containers reside on a storage path that has been dropped. The possible values are:

- Yes
- No

Table space Autoresize Statistics:

Id The table space ID.

AS Indicates whether or not the table space is using automatic storage. The possible values are:

- Yes
- No

AR Indicates whether or not the table space is enabled to be automatically resized. The possible values are:

- Yes
- No

InitSize

For automatic storage table spaces, the value of this parameter is the initial size of the table space in bytes.

IncSize

For automatically resized table spaces, if the value of the IIP field is No, the value of this parameter is the size, in bytes, that the table space will automatically be increased by (per database partition) when the table space is full and a request for space is made. If the value of the IIP field is Yes, the value of this parameter is a percentage.

IIP For automatically resized table spaces, the value of this parameter indicates whether the increment value in the IncSize field is a percent or not. The possible values are:

- Yes
- No

MaxSize

For automatically resized table spaces, the value of this parameter specifies the maximum size, in bytes, to which the table space can automatically be increased (per database partition). A value of NONE indicates that there is no maximum size.

LastResize

The timestamp of the last successful automatic resize operation.

LRF Last resize failed indicates whether the last automatic resizing operation was successful or not. The possible values are:

- Yes
- No

Table space Containers:

TspID The ID of the table space that owns the container.

ContainNum

The number assigned to the container in the table space.

Type The type of container. The possible values are:

- Path
- Disk
- File
- Striped Disk
- Striped File

TotalPgs

The number of pages in the container.

UsablePgs

The number of usable pages in the container.

StripeSet

The stripe set where the container resides (applicable to DMS table spaces only).

Container

The name of the container.

PathID For automatic storage table spaces, the identifier of the storage path on which the container resides.

See Sample output of the db2pd -tablespaces command.

-tcbstats parameter

For the -tcbstats parameter, the following information is returned:

TCB Table Information:

TbSpaceID

The table space identifier.

TableID

The table identifier.

PartID For partitioned tables, this is the data partition identifier. For non-partitioned table this will display 'n/a'.

MasterTbs

For partitioned tables, this is the logical table space identifier to which the partitioned table belongs. For non-partitioned tables, this value corresponds to the TbspaceID.

MasterTab

For partitioned tables, this is the logical table identifier of the partitioned table. For non-partitioned tables, this value corresponds to the TableID.

TableName

The name of the table.

SchemaNm

The schema that qualifies the table name.

ObjClass

The object class. The possible values are:

- Perm (permanent).
- Temp (temporary).

DataSize

The number of pages in the data object.

LfSize The number of pages in the long field object.

LobSize

The number of pages in the large object.

XMLSize

The number of pages in the XML object.

TCB Table Stats:

TableName

The name of the table.

SchemaNm

The schema that qualifies the table name.

Scans The number of scans that have been performed against the table.

UDI The number of update, delete, and insert operations that have been performed against the table since the last time that the table statistics were updated through the background statistics collection process or manually using the RUNSTATS command.

RTSUDI The number of update, delete, and insert operations that have been performed against the table since the last time that the table statistics were updated by real-time statistics gathering, background statistics collection process, or manual RUNSTATS.

PgReorgs

The number of page reorganizations performed.

NoChgUpdts

The number of updates that did not change any columns in the table.

Reads The number of rows read from the table when the table switch was on for monitoring.

FscrUpdates

The number of updates to a free space control record.

Inserts

The number of insert operations performed on the table.

Updates

The number of update operations performed on the table.

Deletes

The number of delete operations performed on the table.

OVFLReads

The number of overflows read on the table when the table switch was on for monitoring.

OVFLCrtes

The number of new overflows that were created.

RowsComp

The total number of rows that were compressed.

RowsUNcomp

The total number of rows that were uncompressed.

CCLogReads

The number of times the currently committed version of a row was retrieved for the table.

StoredBytes

This column corresponds to the "Total stored temp bytes" from the `db2pd -temptable` output.

BytesSaved

This column corresponds to the "Total bytes saved" value from the `db2pd -temptable` output.

Note The following data is only displayed when the `-all` or `-index` option is specified with the `-tcbstats` parameter.

TCB Index Information:**InxTbpace**

The table space where the index resides.

ObjectID

The object identifier of the index.

PartID For partitioned tables, the data partition identifier. For nonpartitioned tables, N/A is displayed.

TbpaceID

The table space identifier.

TableID

The table identifier.

MasterTbs

For partitioned tables, this is the logical table space identifier to which the partitioned table belongs. For non-partitioned tables, this value corresponds to the `TbpaceID`.

MasterTab

For partitioned tables, this is the logical table identifier of the partitioned table. For non-partitioned tables, this value corresponds to the TableID.

TableName

The name of the table.

SchemaNm

The schema that qualifies the table name.

IID

The index identifier.

IndexObjSize

The number of pages in the index object.

TCB Index Stats:**TableName**

The name of the table.

IID

The index identifier.

PartID

For partitioned tables, the data partition identifier. For nonpartitioned tables, N/A is displayed.

EmpPgDel

The number of empty leaf nodes that were deleted.

RootSplits

The number of key insert or update operations that caused the index tree depth to increase.

BndrySplits

The number of boundary leaf splits that result in an insert operation into either the lowest or the highest key.

PseuEmptPg

The number of leaf nodes that are marked as being pseudo empty.

EmpPgMkdUsd

The number of pseudo empty pages that have been reused.

Scans

The number of scans against the index.

IxOnlyScns

The number of index only scans (result of scan satisfied by access to index only).

KeyUpdates

The number of updates to the key.

InclUpdats

The number of included column updates.

NonBndSpts

The number of non-boundary leaf splits.

PgAllocs

The number of allocated pages.

Merges

The number merges performed on index pages.

PseuDels

The number of keys that are marked as pseudo deleted.

DelClean

The number of pseudo deleted keys that have been deleted.

IntNodSpl

The number of intermediate level splits.

-temptable parameter

In order to calculate the cumulative compression ratio across all of the temporary tables, the following formula can be used:

$$\% \text{ Compression} = \frac{\text{Total Bytes Saved}}{\text{Total Bytes Saved} + \text{Total Stored Temp Bytes}}$$

Note:

- The term Eligible indicates temporary tables that meet the compression criteria.
- The term Compressed indicates temporary tables that finally have sufficient data inserted to be compressed.

```
hotel26:/home/billyp> db2pd -db billdb -temptable
db_state1 db_state2 db_state3 db_state4 use_count dbname dbpath
-----
000000001 000000000 000000000 000000000 000000009 BILL /home/billyp/billyp/NODE0000/SQL00011/
```

System Temp Table Stats:

```
Number of Temp Tables : 0
Comp Eligible Temps : 0
Compressed Temps : 0
Total Temp Bytes : 0
Total Bytes Saved : 0
Total Compressed Rows : 0
Total Temp Table Rows: : 0
```

User Temp Table Stats:

```
Number of Temp Tables : 0
Comp Eligible Temps : 0
Compressed Temps : 0
Total Stored Temp Bytes : 0
Total Bytes Saved : 0
Total Compressed Rows : 0
Total Temp Table Rows : 0
```

All of the counters can be reset to zero by using the hidden reset option.

```
hotel26:/home/billyp> db2pd -db bill -temptable -reset
Resetting counters to 0.
```

See Sample output of the db2pd -temptable command.

-thresholds parameter

For the **-thresholds** parameter, the following information is returned:

- Threshold Name: Threshold name
- Threshold ID: Threshold identifier
- Domain: Threshold domain
- Domain ID: Threshold domain identifier
- Predicate ID: Threshold predicate identifier
- Maximum Value: Threshold maximum value
- Enforcement: Threshold enforcement scope
- Queuing: Threshold is a queuing threshold

- Queue Size: Threshold queue size setting
- Collect Flags: Setting of COLLECT ACTIVITY DATA option for threshold
- Partition Flags: Partitions where COLLECT ACTIVITY option setting applies
- Execute Flags: Threshold action setting
- Enabled: State of threshold, enabled or disabled
- Check Interval (seconds): Frequency setting for threshold condition checks
- Remap Target Serv. Subclass: Target service subclass setting for remapping threshold action
- Log Violation Evmon Record: THRESHOLD VIOLATIONS event monitor log setting

If the threshold is a queuing threshold, the queue section will also show:

- Queue information for threshold: Threshold Name
- Max Concurrency: Maximum concurrency setting
- Concurrency: Actual concurrency value
- Max Queue Size: Maximum threshold queue size setting
- Agents Currently Queued: At the catalog node, the list of all agents waiting in the threshold queue (shown only when agents are queued)

See Sample output of the db2pd -thresholds command.

-transactions parameter

For the **-transactions** parameter, the following information is returned:

App1Hand1

The application handle of the transaction.

TranHdl1

The transaction handle of the transaction.

Locks The number of locks held by the transaction.

State The transaction state.

Tflag The transaction flag. The possible values are:

- 0x00000002. This value is only written to the coordinator node of a two-phase commit application, and it indicates that all subordinate nodes have sent a "prepare to commit" request.
- 0x00000020. The transaction must change a capture source table (used for data replication only).
- 0x00000040. Crash recovery considers the transaction to be in the prepare state.
- 0x00010000. This value is only written to the coordinator partition in a partitioned database environment, and it indicates that the coordinator partition has not received a commit request from all subordinate partitions in a two-phase commit transaction.
- 0x00040000. The rolling back of the transaction is pending.
- 0x01000000. The transaction resulted in an update on a database partition server that is not the coordinator partition.
- 0x04000000. Loosely coupled XA transactions are supported.
- 0x08000000. Multiple branches are associated with this transaction and are using the loosely coupled XA protocol.

- 0x10000000. A data definition language (DDL) statement has been issued, indicating that the loosely coupled XA protocol cannot be used by the branches participating in the transaction.

Tflag2 Transaction flag 2. The possible values are:

- 0x00000004. The transaction has exceeded the limit specified by the **num_log_span** database configuration parameter.
- 0x00000008. The transaction resulted because of the running of a DB2 utility.
- 0x00000020. The transaction will cede its locks to an application with a higher priority (this value ordinarily occurs for jobs that the DB2 database system automatically starts for self tuning and self management).
- 0x00000040. The transaction will not cede its row-level locks to an application with a higher priority (this value ordinarily occurs for jobs that the DB2 database system automatically starts for self-tuning and self-management)

Firstlsn

First LSN of the transaction.

Lastlsn

Last LSN of the transaction.

LogSpace

The amount of log space that is reserved for the transaction.

SpaceReserved

The total log space that is reserved for the transaction, including the used space and all compensation records.

TID Transaction ID.

AxRegCnt

The number of applications that are registered for a global transaction. For local transactions, the value is 1.

GXID Global transaction ID. For local transactions, the value is 0.

ClientUserID

Client userid for the transaction, which is the same as tpmon_client_userid (TP Monitor Client User ID monitor element).

ClientWrkstnName

Client workstation name for the transaction, which is the same as tpmon_client_wkstn (TP Monitor Client Workstation Name monitor element).

ClientApp1Name

Client application name driving the transaction, which is the same as tpmon_client_app (TP Monitor Client Application monitor element).

ClientAcctng

Accounting string of the client driving the transaction, which is the same as tpmon_acc_str (TP Monitor Client Accounting String monitor element).

-wlocks parameter

For the **-wlocks** parameter, the following information is returned:

App1Hand1

The application handle, including the node and the index.

TranHd1

The transaction handle that is requesting the lock.

LockName

The name of the lock.

Type The type of lock.

Mode The lock mode. The possible values are:

- IS
- IX
- S
- SIX
- X
- IN
- Z
- U
- NS
- NW

Conv The lock mode to which the lock will be converted after the lock wait ends.

Sts The lock status. The possible values are:

- G (granted)
- C (converting)
- W (waiting)

CoorEDU

The EDU ID of the coordinator agent for the application.

AppName

The name of the application.

AuthID The authorization identifier.

AppID The application ID. This value is the same as the **appl_id** monitor element data.

See Sample output of the `db2pd -wlocks` command.

-workactionsets parameter

For the **-workactionsets** parameter, the following information is returned:

- Address
- Work action set ID
- Work action set name
- Associated work class set ID
- Type of object work action set is associated (database or service class)
- ID of the object (service class or database) work action set is associated with
- All the work actions within the work action set:
 - address
 - action ID
 - action type

- reference object ID (threshold ID or service class ID or null depending on the action type)

-workclasssets parameter

For the **-workclasssets** parameter, the following information is returned:

- address
- work class ID
- reference counter (number of different work action sets that reference this work class set)
- All the work classes within the work class set (shown in their evaluation order):
 - address
 - class ID
 - class name
 - class type
 - schema name
 - from value
 - to value
 - range units

-workloads parameter

For the **-workloads** parameter, the following information is returned, specific to the headings:

Workload definitions

- Workload ID and name
- Database access permission for workload occurrences
- The number of concurrent workload occurrences
- Workload thresholds
- Associated service class
- Statistics collection settings
- Histogram template IDs

Usage privilege holders

- Workload ID
- Type of holder
- Authorization ID

Local partition workload statistics

- Workload ID and name
- Workload occurrence statistics
- Time since last statistics reset
- Activity statistics

See Sample output of the db2pd -workloads command.

Sample output

-addnode

The following is a sample of the output of the db2pd -addnode command:

```

-----
Summary of add partition processing done for partition[50]
-----
00:Creating database partitions : True
01:Database partitions are created : True
08:Collecting storage information : True
09:Storage information is collected : True
11:FCM Send & Receive daemons are blocked : True
12:FCM Send & Receive daemons are reactivated : True
13:db2start processing is complete : True

```

Conflicting states or activities for add partition for partition[50]

```

-----
[14] Messages found for partition [50]
-----

```

```

[Fri Oct 24 16:16:27 2008]:Addnode agent:Got automatic storage details
[Fri Oct 24 16:16:28 2008]:Addnode agent:Skeleton database is created
[Fri Oct 24 16:16:28 2008]:Addnode agent:Scanning for db alias=[PE      ] name=[PE      ]
[Fri Oct 24 16:16:28 2008]:Addnode agent:Found db alias=[PE      ] name=[PE      ]
[Fri Oct 24 16:16:28 2008]:Addnode agent:Instance directory already exists
[Fri Oct 24 16:16:28 2008]:Addnode agent:Node directory already exists
[Fri Oct 24 16:16:28 2008]:Addnode agent:Node directory is created
[Fri Oct 24 16:16:29 2008]:Addnode agent:Getting automatic storage details
[Fri Oct 24 16:16:29 2008]:Addnode agent:Got automatic storage details
[Fri Oct 24 16:16:30 2008]:Addnode agent:Skeleton database is created
[Fri Oct 24 16:16:30 2008]:Addnode agent:Database activation is not required
[Fri Oct 24 16:16:30 2008]:Addnode agent:Database activation is complete
[Fri Oct 24 16:16:30 2008]:Addnode agent:Online mode processing is complete
[Fri Oct 24 16:16:30 2008]:db2start is complete

```

oldviewapps

Returns information about which applications see the number of database partition servers (nodes) in the instance before the add database partition server operation occurred.

The following is a sample of the output of the db2pd -addnode oldviewsapps command:

```

-----
Summary of add partition processing done for partition[0]
-----

Conflicting states or activities for add partition for partition[0]
-----

Applications with old view of instance for partition [0]
-----
App.Handle(00000000,00000072) view has [3] nodes, instance has [4] nodes
App.Handle(00000000,00000065) view has [3] nodes, instance has [4] nodes
App.Handle(00000000,00000071) view has [3] nodes, instance has [4] nodes
App.Handle(00000000,00000005) view has [3] nodes, instance has [4] nodes
App.Handle(00000000,00000051) view has [3] nodes, instance has [4] nodes
App.Handle(00000000,00000070) view has [3] nodes, instance has [4] nodes
App.Handle(00000000,00000069) view has [3] nodes, instance has [4] nodes
App.Handle(00000000,00000068) view has [3] nodes, instance has [4] nodes
App.Handle(00000001,00000058) view has [3] nodes, instance has [4] nodes
App.Handle(00000000,00000067) view has [3] nodes, instance has [4] nodes
App.Handle(00000000,00000073) view has [3] nodes, instance has [4] nodes

```

detail When used with the db2pd command, returns detailed information about the add database partition server operation, including the step in progress and events that are incompatible with the add database partition server operation. When used with the **oldviewapps** option, also returns information about which

applications have a view of the instance that does not include recently added database partition servers.

The following is a sample of the output of the db2pd -addnode detail command:

```
-----  
Add partition processing with detail for partition[50]  
-----  
00:Creating database partitions : True  
01:Database partitions are created : True  
02:Dropping database entries : False  
03:Dropping db entries are completed : False  
04:Activating databases explicitly : False  
05:Database explicit activation is completed : False  
06:Updating database configuration : False  
07:Database configuration is updated : False  
08:Collecting storage information : True  
09:Storage information is collected : True  
10:Add partition operation is complete : False  
11:FCM Send & Receive daemons are blocked : True  
12:FCM Send & Receive daemons are reactivated : True  
13:db2start processing is complete : True
```

Conflicting states or activities for add partition for partition[50]

```
-----  
restricted :False  
db2start :False  
db2stop :False  
instance quiesced :False  
database quiesced :False  
quiesce instance :False  
unquiesce instance :False  
quiesce db :False  
unquiesce db :False  
activate db :False  
deactivate db :False  
exclusive use of db :False  
create db :False  
drop db :False  
create tablespace :False  
alter tablespace :False  
drop tablespace :False  
add partition :False  
backup database :False  
restore database :False  
snapshot restore :False
```

[14] Messages found for partition [50]

```
-----  
[Fri Oct 24 16:16:27 2008]:Addnode agent:Got automatic storage details  
[Fri Oct 24 16:16:28 2008]:Addnode agent:Skeleton database is created  
[Fri Oct 24 16:16:28 2008]:Addnode agent:Scanning for db alias=[PE ] name=[PE ]  
[Fri Oct 24 16:16:28 2008]:Addnode agent:Found db alias=[PE ] name=[PE ]  
[Fri Oct 24 16:16:28 2008]:Addnode agent:Instance directory already exists  
[Fri Oct 24 16:16:28 2008]:Addnode agent:Node directory already exists  
[Fri Oct 24 16:16:28 2008]:Addnode agent:Node directory is created  
[Fri Oct 24 16:16:29 2008]:Addnode agent:Getting automatic storage details  
[Fri Oct 24 16:16:29 2008]:Addnode agent:Got automatic storage details  
[Fri Oct 24 16:16:30 2008]:Addnode agent:Skeleton database is created  
[Fri Oct 24 16:16:30 2008]:Addnode agent:Database activation is not required  
[Fri Oct 24 16:16:30 2008]:Addnode agent:Database activation is complete  
[Fri Oct 24 16:16:30 2008]:Addnode agent:Online mode processing is complete  
[Fri Oct 24 16:16:30 2008]:db2start is complete
```

Total [00] Conflicting application handles for partition [50]

Conflicting operations are shown as in the following example:

Total [01] Conflicting application handles for partition [20]

Agents for app_handle 00000000 00000052 : Activity occurrence:[1] time(s) ActivityName

The following is a sample of the output of the db2pd -addnode
oldviewapps detail command:

Add partition processing with detail for partition[0]

00:Creating database partitions : False
01:Database partitions are created : False
02:Dropping database entries : False
03:Dropping db entries are completed : False
04:Activating databases explicitly : False
05:Database explicit activation is completed : False
06:Updating database configuration : False
07:Database configuration is updated : False
08:Collecting storage information : False
09:Storage information is collected : False
10:Add partition operation is complete : False
11:FCM Send & Receive daemons are blocked : False
12:FCM Send & Receive daemons are reactivated : False
13:db2start processing is complete : False

Conflicting states or activities for add partition for partition[0]

restricted :False
db2start :False
db2stop :False
instance quiesced :False
database quiesced :False
quiesce instance :False
unquiesce instance :False
quiesce db :False
unquiesce db :False
activate db :False
deactivate db :False
exclusive use of db :False
create db :False
drop db :False
create tablespace :False
alter tablespace :False
drop tablespace :False
add partition :False
backup database :False
restore database :False
snapshot restore :False
create/alter nodegroup :False
drop nodegroup :False
add storage :False
redistribute :False

Total [00] Conflicting application handles for partition [0]

Applications with old view of instance for partition [0]

App.Handle(00000000,00000072) view has [3] nodes, instance has[4] nodes
[Viewnodes:0:1:2:]
App.Handle(00000000,00000065) view has [3] nodes, instance has[4] nodes
[Viewnodes:0:1:2:]
App.Handle(00000000,00000071) view has [3] nodes, instance has[4] nodes

```

[Viewnodes:0:1:2:]
App.Handle(00000000,00000005) view has [3] nodes, instance has[4] nodes
[Viewnodes:0:1:2:]
App.Handle(00000000,00000051) view has [3] nodes, instance has[4] nodes
[Viewnodes:0:1:2:]
App.Handle(00000000,00000070) view has [3] nodes, instance has[4] nodes
[Viewnodes:0:1:2:]
App.Handle(00000000,00000069) view has [3] nodes, instance has[4] nodes
[Viewnodes:0:1:2:]
App.Handle(00000000,00000068) view has [3] nodes, instance has[4] nodes
[Viewnodes:0:1:2:]
App.Handle(00000001,00000058) view has [3] nodes, instance has[4] nodes
[Viewnodes:0:1:2:]
App.Handle(00000000,00000067) view has [3] nodes, instance has[4] nodes
[Viewnodes:0:1:2:]
App.Handle(00000000,00000073) view has [3] nodes, instance has[4] nodes
[Viewnodes:0:1:2:]

```

-apinfo

The following is a sample of the output of the db2pd -apinfo command:

```
db2pd -apinfo 12 -db mydb10
```

```
Database Partition 0 -- Database MYDB10 -- Active -- Up 0 days 00:03:28
```

Application :

```

Address : 0x0780000000D76EE0
AppHandl [nod-index] : 12 [000-00012]
Application PID : 1384708
Application Node Name : boson
IP Address: n/a
Connection Start Time : (1195265036)Fri Nov 16 21:03:56 2007
Client User ID : venus
System Auth ID : VENUS
Coordinator EDU ID : 1801
Coordinator Partition : 0
Number of Agents : 1
Locks timeout value : 4294967294 seconds
Locks Escalation : No
Workload ID : 1
Workload Occurrence ID : 1
Trusted Context : n/a
Connection Trust Type : non trusted
Role Inherited : n/a
Application Status : Lock-wait
Application Name : db2bp
Application ID : *LOCAL.venus.071117020356
ClientUserID : n/a
ClientWrkstnName : n/a
ClientApplName : n/a
ClientAcctng : n/a

```

List of active statements :

```

*UOW-ID : 8
Activity ID : 2
Package Schema : NULLID
Package Name : SQLC2G13
Package Version :
Section Number : 201
SQL Type : Dynamic
Isolation : CS
Statement Type : DML, Select (blockable)
Statement : select * from t2

```

List of inactive statements of current UOW :

```

UOW-ID : 8
Activity ID : 1

```

```

Package Schema : NULLID
Package Name   : SQLC2G13
Package Version :
Section Number : 203
SQL Type      : Dynamic
Isolation     : CS
Statement Type : DML, Insert/Update/Delete
Statement      : insert into t1 values 1

```

-catalogcache

The following is a sample of the SYSTABLES output of the db2pd -catalogcache command:

Database Partition 0 -- Database SAMPLE -- Active -- Up 0 days 00:05:34

```

Catalog Cache:
Configured Size      1064960
Current Size         78272
Maximum Size         4294901760
High Water Mark      131072

```

```

SYSTABLES:
Address      Schema  Name      Type TableID TbspaceID LastRefID CatalogCacheLoadingLock CatalogCacheUsageLock Sts
0x07800000232FF820 SYSIBM  SYSTABLES T 5 0 19288214 0001000007800000232FF82043 0000000500001804232FF82043 V
0x07800000232FD360 SYSCAT  TABLES  V 0 0 19288214 0001000007800000232FD36043 000000050000CC907232FD36043 V
0x07800000232FFB60 KEON014 EMPLOYEE 0 0 0 19288214 0001000007800000232FFB6043 000000050013AE07232FFB6043 I
0x07800000232FC500 SYSTOOLS POLICY 0 0 0 19288214 0001000007800000232FC50043 00000000000000000000000000000000 I
0x07800000232FCF40 KEON014 DEPT T 4 2 19288214 0001000007800000232FCF4043 000000050013AE06232FCF0343 V
0x07800000238FCF40 KEON014 DEPT T 4 2 19288214 0001000007800000238FCF4043 000000050013AE06238FCF0143 S
0x07800000234433A0 KEON014 SALARY 0 0 0 19288214 0001000007800000234433A043 000000050013AF00234433A043 I

```

-edus The following is a sample of the output of the db2pd -edus command:

Database Partition 0 -- Active -- Up 0 days 01:14:05

List of all EDUs for database partition 0

```

db2sysc PID: 18485
db2wdog PID: 18483
db2acd PID: 18504

```

EDU ID	TID	Kernel TID	EDU Name	USR
24	47155322546496	12108	db2pfchr (TESTDB)	0.010000
23	47155326740800	12107	db2pclnr (TESTDB)	0.000000
22	47155330935104	12106	db2pclnr (TESTDB)	0.000000
21	47155335129408	12105	db2pclnr (TESTDB)	0.000000
20	47155339323712	12104	db2dlock (TESTDB)	0.000000
19	47155343518016	12103	db2lfr (TESTDB)	0.000000
18	47155347712320	12102	db2loggw (TESTDB)	0.000000
17	47155351906624	12101	db2loggr (TESTDB)	0.080000
16	47155356100928	27704	db2agent (TESTDB) (suspended)	0.930000
15	47155360295232	18502	db2resync	0.080000
14	47155364489536	18500	db2ipccm	0.030000
13	47155368683840	18499	db2licc	0.000000
12	47155372878144	18498	db2thc1n	0.000000
11	47155377072448	18497	db2alarm	0.000000
1	47155117025600	18493	db2sysc	3.340000

-pages

The following is a sample of the output of the db2pd -pages command without specifying the summary parameter:

venus@baryon:/home/venus =>db2pd -pages -db pdtest

Database Partition 0 -- Database PDTEST -- Active -- Up 0 days 00:01:28

```

Bufferpool Pages:
First Active Pool ID 1
Max Bufferpool ID 1
Max Bufferpool ID on Disk 1
Num Bufferpools 5

```

```

Pages for all bufferpools:
Address      BPID TbspaceID TbspacePgNum ObjID ObjPgNum ObjClass ObjType Dirty Prefetched
0x0000002AC22ABAC0 1 0 92 10 0 EMP Data N N
0x0000002AC22ABB80 1 0 2503 10 11 Perm Index N N
0x0000002AC22ABC40 1 0 2501 10 9 Perm Index Y N

```

```

0x0000002AC22ABD00 1 0 2494 10 2 Perm Index N N
0x0000002AC22ABDC0 1 0 3437 5 17 Perm Data N N
0x0000002AC22ABE80 1 0 2504 10 12 Perm Index Y N
0x0000002AC22ABF40 1 0 2505 10 13 Perm Index N N
0x0000002AC22AC000 1 0 2506 10 14 Perm Index N N
0x0000002AC22AC0C0 1 0 28 5 0 EMP LOB N N
0x0000002AC22AC180 1 0 2509 10 17 Perm Index N N
0x0000002AC22AC240 1 0 2495 10 3 Perm Index Y N
0x0000002AC22AC300 1 0 2498 10 6 Perm Index Y N
0x0000002AC22AC3C0 1 2 128 4 0 Perm Data Y N
0x0000002AC22AC480 1 0 2499 10 7 Perm Index N N
0x0000002AC22AC540 1 0 99 10 3 Perm Data Y N
0x0000002AC22AC600 1 0 96 10 0 Perm Data Y N
0x0000002AC22AC6C0 1 0 110 5 2 Perm Index N N
0x0000002AC22AC780 1 0 2500 10 8 Perm Index N N
0x0000002AC22AC840 1 0 2740 5 16 Perm Index N N
0x0000002AC22AC900 1 0 2507 10 15 Perm Index Y N
Total number of pages: 20

```

```

Summary info for all bufferpools:
BPID TbspaceID ObjID Total Dirty Permanent Temporary Data Index LongField XMLData SMP LOB LOBA BMP
1 0 5 4 0 3 0 1 2 0 0 0 1 0 0
1 0 10 15 7 14 0 3 12 0 0 0 0 0 0
1 2 4 1 1 1 0 1 0 0 0 0 0 0 0
Total number of pages: 20

```

The following is a sample of the output of the `thedb2pd -pages` command specifying the **summary** parameter:

```
venus@baryon:/home/venus =>db2pd -pages summary -db pdtest
```

```
Database Partition 0 -- Database PDTEST -- Active -- Up 0 days 00:02:07
```

```

Bufferpool Pages:
First Active Pool ID 1
Max Bufferpool ID 1
Max Bufferpool ID on Disk 1
Num Bufferpools 5

```

```
Total number of pages: 20
```

```

Summary info for all bufferpools:
BPID TbspaceID ObjID Total Dirty Permanent Temporary Data Index LongField XMLData SMP LOB LOBA BMP
1 0 5 4 0 3 0 1 2 0 0 0 1 0 0
1 0 10 15 7 14 0 3 12 0 0 0 0 0 0
1 2 4 1 1 1 0 1 0 0 0 0 0 0 0
Total number of pages: 20

```

-scansharing

Following is an example of output using the **-scansharing** parameter. The output shows two sharing sets. The table scan set has two groups and the block index scan set has one group.

```
Database Partition 0 -- Database TPCD -- Active -- Up 0 days 00:00:45
```

```
Scan Sets:
```

```
TbspaceID TableID ScanObject NumGroups Footprint TableSize FastScanRate SlowScanRate
2 3 0 2 11520 22752 2486 1000
```

```

Group Information:
FootPrint NumScannersInGroup
8288 3

```

```
Scans In Group :
```

```

AgentID ApplID Mode Wrappable Fast/Slow Speed ThrottleTime Absolute Location Remaining Pages
9768 1173 0 0 1 2486 0 32 22751
11332 1165 0 0 1 2486 0 5056 17727
15466 1155 0 0 1 2486 0 8288 14495

```

```

Group Information:
FootPrint NumScannersInGroup
3232 2

```

```
Scans In Group :
```

```

AgentID ApplID Mode Wrappable Fast/Slow Speed ThrottleTime Absolute Location Remaining Pages
15209 1150 0 0 1 2486 0 14080 8703
12103 1148 0 0 1 2486 0 17280 5503

```

```
Scan Sets:
```

```
TbspaceID TableID ScanObject NumGroups Footprint TableSize FastScanRate SlowScanRate
2 3 1 1 9056 22752 1000 1000
```

```

Group Information:
FootPrint NumScannersInGroup
9056 3

```

```
Scans In Group :
```

```

AgentID ApplID Mode Wrappable Fast/Slow Speed ThrottleTime Relative Location Estimated Remaining Pages
6170 1209 0 0 1 1000 0 896 13535
13645 1215 0 0 1 1000 0 3552 10879
4371 1204 0 0 1 1000 0 9920 4511

```

-serviceclasses

The following is a sample of the service classes information output for one service superclass and its subclass.

Sample service superclass output:

```

Service Class Name      = SYSDEFAULTSYSTEMCLASS
Service Class ID       = 1
Service Class Type     = Service Superclass
Default Subclass ID   = 11
Effective Service Class State = Enabled
Catalog Service Class State = Enabled
Effective Agent Priority = 0
Catalog Agent Priority = Default
Effective Prefetch Priority = Medium
Catalog Prefetch Priority = Default
Effective Bufferpool Priority = Low
Catalog Bufferpool Priority = Default
Effective Outbound Correlator = None
Catalog Outbound Correlator = None
Work Action Set ID    = N/A
Collect Activity Opt  = None
Collect Request Metrics = Base

Num Connections      = 5
Last Statistics Reset Time = 12/16/2008 15:27:42.000000
Num Coordinator Connections = 5
Coordinator Connections HWM = 5

```

Associated Workload Occurrences (WLO):

AppHandl	[nod-index]	WL ID	WLO ID	UOW ID	WLO State
10	[000-00010]	0	0	1	UOWWAIT
11	[000-00011]	0	0	1	UOWWAIT
12	[000-00012]	0	0	1	UOWWAIT
13	[000-00013]	0	0	1	UOWWAIT
14	[000-00014]	0	0	1	UOWWAIT

Sample service subclass output:

```

Service Class Name      = SYSDEFAULTSUBCLASS
Service Class ID       = 11
Service Class Type     = Service Subclass
Parent Superclass ID   = 1
Effective Service Class State = Enabled
Catalog Service Class State = Enabled
Effective Agent Priority = 0
Catalog Agent Priority = Default
Effective Prefetch Priority = Medium
Catalog Prefetch Priority = Default
Effective Bufferpool Priority = Low
Catalog Bufferpool Priority = Default
Effective Outbound Correlator = None
Catalog Outbound Correlator = None
Collect Activity Opt    = None
Collect Request Metrics = None
Collect Aggr Activity Opt = None
Collect Aggr Request Opt = None
Act Lifetime Histogram Template ID = 1
Act Queue Time Histogram Template ID = 1
Act Execute Time Histogram Template ID = 1
Act Estimated Cost Histogram Template ID = 1
Act Interarrival Time Histogram Template ID = 1
Request Execute Time Histogram Template ID = 1

Access Count          = 0
Last Stats Reset Time = 12/16/2008 15:27:42.000000
Activities HWM        = 0
Activities Completed  = 0
Activities Rejected   = 0
Activities Aborted    = 0

```

Associated Agents:

EDU ID	AppHandl	[nod-index]	WL ID	WLO ID	UOW ID	Activity ID
--------	----------	-------------	-------	--------	--------	-------------

26	10	[000-00010]	0	0	0	0
29	11	[000-00011]	0	0	0	0
28	12	[000-00012]	0	0	0	0
27	13	[000-00013]	0	0	0	0
30	14	[000-00014]	0	0	0	0

Associated Non-agent threads:

PID	TID	Thread Name
6834	2948590480	db2loggr
6834	2947541904	db2loggw
6834	2946493328	db2lfr
6834	2945444752	db2dlock
6834	2944396176	db2pclnr
6834	2943347600	db2pfchr
6834	2942299024	db2pfchr
6834	2941250448	db2pfchr

-storagepaths

Following is an example of output using the **-storagepaths** parameter.

Database Storage Paths:

Number of Storage Paths 3

Address	PathID	PathState	PathName
0x07000000400101C0	0	InUse	/dataPath1
0x0700000040010540	1	DropPending	/dataPath2
0x07000000400108C0	2	NotInUse	/PathWithDPE_0 (/PathWithDPE_ \$N)

-tablespaces

The following is a sample of the output of the **db2pd -tablespaces** command showing information such as **PathsDropped** and **PathID** that is applicable to automatic storage databases (some of the columns have been left out for readability):

Tablespace Configuration:

...

Tablespace Statistics:

Address	Id	...	State	MinRecTime	NQuiescers	PathsDropped
0x070000004108AB40	0	...	0x00000000	0	0	Yes
0x070000004108B520	1	...	0x00000000	0	0	Yes
0x0700000041078100	2	...	0x00000000	0	0	Yes

Tablespace Autoresize Statistics:

...

Containers:

Address	TspId	...	PathID	StripeSet	Container
0x070000004108B240	0	...	0	0	/dataPath1/inst/NODE0000/TESTDB/T0000000/
0x070000004108B398	0	...	1	0	/dataPath2/inst/NODE0000/TESTDB/T0000000/
0x070000004108BBC0	1	...	0	0	/dataPath1/inst/NODE0000/TESTDB/T0000001/
0x070000004108BD18	1	...	1	0	/dataPath2/inst/NODE0000/TESTDB/T0000001/
0x07000000410787A0	2	...	0	0	/dataPath1/inst/NODE0000/TESTDB/T0000002/
0x07000000410788F8	2	...	1	0	/dataPath2/inst/NODE0000/TESTDB/T0000002/

A new 'Max HWM' column is added to the **db2pd -tablespaces** output to indicate the maximum HWM for a DMS table space since the instance was started. The 'HWM' column in the output is the current HWM, which for a temporary DMS table space, represents the point-in-time value of the amount of disk space used. For SMS table spaces, the HWM and Max HWM will not have any value.

After a query has been issued, in-memory information about the temporary tables used in the last transaction will be available using **db2pd**.

The example below shows the new column in **bold**. The value of the Max HWM will always be equal to, or greater than, the HWM.

```
hotel26:/home/billyp> db2pd -db bill -tablespaces
```

```
Database Partition 0 -- Database BILL -- Active -- Up 0 days 00:02:15
```

Tablespace Configuration:

Address	Id	Type	Content	PageSz	ExtentSz	Auto	Prefetch	BufID	BufIDDisk	FSC	NumC
0x00002B9DCA582720	0	DMS	Regular	4096	4	Yes	4	1	1	Off	1
0x00002B9DCA583560	1	DMS	UsrTmp	4096	2	Yes	2	1	1	Off	1
0x00002B9DCA5863E0	2	DMS	Large	4096	32	Yes	32	1	1	Off	1
0x00002B9DCA587220	3	DMS	SysTmp	4096	2	Yes	2	1	1	Off	1
0x00002B9DCA58A0A0	4	DMS	Large	4096	4	Yes	4	1	1	Off	1

Tablespace Statistics:

Address	Id	TotalPgs	UsablePgs	UsedPgs	PndFreePgs	FreePgs	HWM	Max H
0x00002B9DCA582720	0	12544	12540	12308	0	232	12308	12308
0x00002B9DCA583560	1	20000	19998	3266	0	16732	3266	3266
0x00002B9DCA5863E0	2	7168	7136	3232	0	3904	7072	7072
0x00002B9DCA587220	3	20000	19998	1700	0	18298	1700	2000
0x00002B9DCA58A0A0	4	256	252	144	0	108	144	200

-temptable

The system monitor elements could also be used to determine the effectiveness of temporary table compression by examining the amount of buffer pool reads and writes. The following is a sample of the output of the db2pd -temptable command:

```
hotel26:/home/billyp> db2pd -db billdb -temptable
```

db_state1	db_state2	db_state3	db_state4	use_count	dbname	dbpath
000000001	000000000	000000000	000000000	000000009	BILL	/home/billyp/billyp/NODE0000/SQL

System Temp Table Stats:

```
Number of Temp Tables : 0
Comp Eligible Temps : 0
Compressed Temps : 0

Total Stored Temp Bytes : 0
Total Bytes Saved : 0
Total Compressed Rows : 0
Total Temp Table Rows : 0
```

User Temp Table Stats:

```
Number of Temp Tables : 0
Comp Eligible Temps : 0
Compressed Temps : 0

Total Stored Temp Bytes : 0
Total Bytes Saved : 0
Total Compressed Rows : 0
Total Temp Table Rows : 0
```

The same information is stored for system temporary tables as well as user temporary tables. However, all of the counters above are cumulative, and are updated as temporary tables are dropped. As such, these counters represent only historical information.

-thresholds

The following is a sample of the threshold information output for a database threshold and its queue.

Sample threshold output:

```

Threshold Name           = MAXDBACTIVITIES
Threshold ID            = 6
Domain                  = 10
Domain ID               = 10
Predicate ID           = 90
Maximum Value           = 2
Enforcement             = D
Queueing                = Y
Queue Size              = 0
Collect Flags           = V
Partition Flags        = C
Execute Flags           = C
Enabled                 = Y
Check Interval (seconds) = -1
Remap Target Serv. Subclass = 0
Log Violation Evmon Record = Y

```

Sample database threshold queue output:

Database Threshold Tickets:

Ticket information for threshold: TH1 with threshold ID 1

```

Activity ID  UOW ID      Classification  AppHndl  [nod-index]
1            6              READ_DML      51       [000-00051]

```

Queue information for threshold: MAXDBACTIVITIES

```

Max Concurrency      = 2
Concurrency          = 2
Max Queue Size       = 0

```

Agents Currently Queued:

```

EDU ID      AppHndl  [nod-index]      Agent Type  Activity ID  UOW ID
36          14994    [000-14994]     1          4            1

```

-wlocks

The following is a sample of the output of the db2pd -wlocks command:

```
db2pd -wlocks -db mydb2
```

```
Database Partition 0 -- Database MYDB2 -- Active -- Up 0 days 00:02:17
```

Locks being waited on :

AppHndl	[nod-index]	TranHdl	Lockname	Type	Mode	Conv	Sts	CoorEDU	AppName	AuthID	AppID
13	[000-00013]	7	0002000B000000000340000452	Row	..X	G	352614	db2bp	VENUS		*LOCAL.venus.071117030309
15	[000-00015]	9	0002000B000000000340000452	Row	.NS	W	1176046	db2bp	VENUS		*LOCAL.venus.071117030358
12	[000-00012]	2	0002000B000000000340000452	Row	.NS	W	1052748	db2bp	VENUS		*LOCAL.venus.071117030231
12	[000-00012]	2	0002000400000000080001652	Row	..X	G	1052748	db2bp	VENUS		*LOCAL.venus.071117030231
14	[000-00014]	8	0002000400000000080001652	Row	.NS	W	634900	db2bp	VENUS		*LOCAL.venus.071117030340

-workloads

The following is a sample of the output for the default workloads SYSDEFAULTUSERWORKLOAD and SYSDEFAULTADMWORKLOAD:

```
Database Partition 0 -- Database SB -- Active -- Up 0 days 00:00:57
```

Workload Definitions:

```

Address              = 0x00002B3E772ACB40
WorkloadID           = 1
WorkloadName         = SYSDEFAULTUSERWORKLOAD
DBAccess             = ALLOW
ConcWLOThresID      = 0
ConcWLOThresName    = ^H
MaxConcWLOs         = 9223372036854775806
WLOActsThresName    = ^H
WLOActsThresID      = 0
MaxWLOActs          = 9223372036854775806
ServiceClassID      = 13
Collect Activity Opt = None
Collect Lock Timeout = Without History
Collect Deadlock     = Without History

```

```

Collect Lock Wait           = None
Collect Aggr Activity Opt   = None
Collect Activity Metrics    = Base
Collect Unit of Work Data   = None
Act Lifetime Histogram Template ID = 1
Act Queue Time Histogram Template ID = 1
Act Execute Time Histogram Template ID = 1
Act Estimated Cost Histogram Template ID = 1
Act Interarrival Time Histogram Template ID = 1

Address                     = 0x00002B3E772ACD50
WorkloadID                  = 2
WorkloadName                 = SYSDEFAULTADMWORKLOAD
DBAccess                     = ALLOW
ConcWLOThresID              = 0
ConcWLOThresName            = ^H
MaxConcWLOs                 = 9223372036854775806
WLOActsThresName            = ^H
WLOActsThresID              = 0
MaxWLOActs                  = 9223372036854775806
ServiceClassID              = 13
Collect Activity Opt         = None
Collect Lock Timeout         = Without History
Collect Deadlock             = Without History
Collect Lock Wait           = None
Collect Aggr Activity Opt    = None
Collect Activity Metrics     = Base
Collect Unit of Work Data    = None
Act Lifetime Histogram Template ID = 1
Act Queue Time Histogram Template ID = 1
Act Execute Time Histogram Template ID = 1
Act Estimated Cost Histogram Template ID = 1
Act Interarrival Time Histogram Template ID = 1

```

```

Usage Privilege Holders:
Address      WorkloadID  Type      AuthID
0x00002B3E772BCD60 1          GROUP     PUBLIC

```

```

Local Partition Workload Statistics:
Address                     = 0x00002B3E772DA0C0
WorkloadID                  = 1
WorkloadName                 = SYSDEFAULTUSERWORKLOAD
NumWLO                      = 0
LastResetTime               = 10/07/2008 16:34:43.000000
WLO HWM                     = 0
WLOActHWM                   = 0
WLOCompleted                = 0
ActCompleted                 = 0
ActAborted                   = 0
ActRejected                  = 0

```

```

Address                     = 0x00002B3E7730A0C0
WorkloadID                  = 2
WorkloadName                 = SYSDEFAULTADMWORKLOAD
NumWLO                      = 0
LastResetTime               = 10/07/2008 16:34:43.000000
WLO HWM                     = 0
WLOActHWM                   = 0
WLOCompleted                = 0
ActCompleted                 = 0
ActAborted                   = 0
ActRejected                  = 0

```

Chapter 240. db2pdcfg - Configure DB2 database for problem determination behavior

Sets flags in the DB2 database memory sets to influence the database system behavior for problem determination purposes.

Authorization

One of the following authority levels is required:

- The SYSADM authority level.
- The SYSCTRL authority level.
- The SYSMANT authority level.
- The SYSMON authority level.

When the SYSMON authorization level is granted, the following options are not available:

- **catch**
- **cos**
- **dbcfg**
- **dbmcfg**
- **fodc**
- **trapresilience**

Required connection

There is no minimum connection requirement. However, if a database scope option is specified, that database must be active before the command can return the requested information.

Command syntax

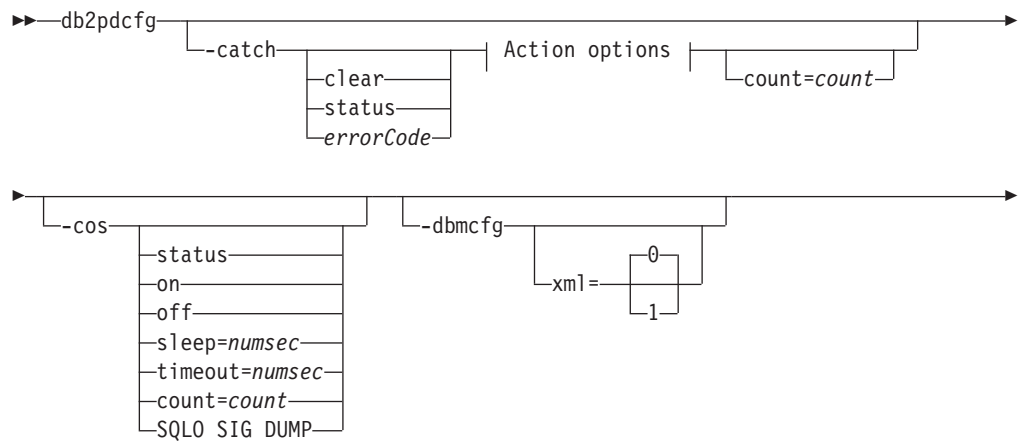

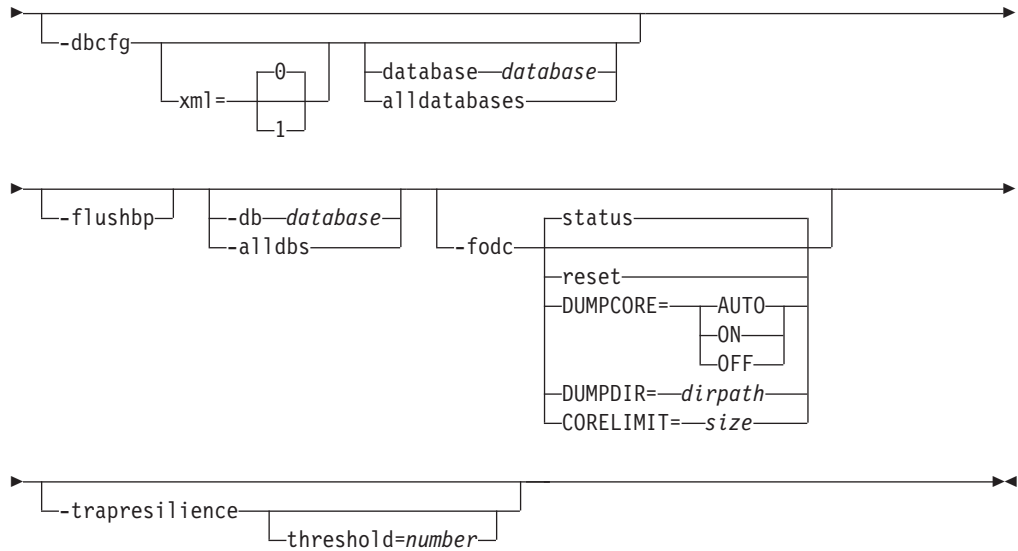

Action options:

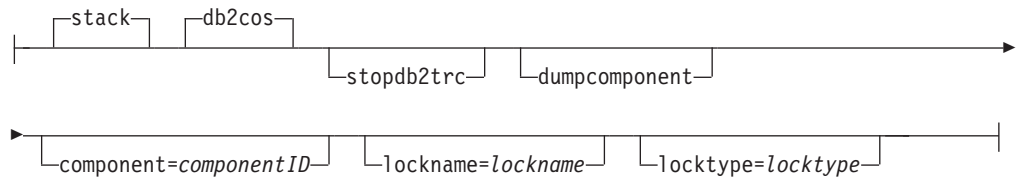

Command parameters

-catch Instructs the database manager to catch an error or warning.

clear Clear any catch flags that are set.

status Display any catch flags that are set.

errorCode

Catch specific flags that are set.

Possible *errorCode* options are:

- *sqlCode[,reasonCode]* / *sqlCode=sqlCode[,reasonCode]*
- ZRC (hex or integer)
- ZRC #define (such as SQLP_LTIMEOUT)
- ECF (hex or integer)
- "deadlock" or "locktimeout"

stack Produce stack trace in db2diag log file. Default.

db2cos

Run the db2cos callout script found in the bin directory. Default.

stopdb2trc

Stop db2trc command.

dumpcomponent

Dump component flag.

component=componentID
Component ID.

lockname=lockname
Lockname for catching specific lock
(lockname=000200030000001F0000000052).

locktype=locktype
Locktype for catching specific lock (locktype=R or locktype=52).

count=count
The number of times the database manager executes db2cos during a database manager trap. The default is 255.

-cos Instructs the database manager how to invoke the db2cos callout script upon a database manager trap.

status Print the status.

off Turn off the database manager call to db2cos during a database manager trap.

on Turn on the database manager call to db2cos during a database manager trap.

sleep=numsec
Amount of time to sleep between checking the size of the output file generated by db2cos. The default is 3 seconds.

timeout=numsec
Amount of time to wait before assuming db2cos script has completed. The default is 30 seconds.

count=count
The number of times to execute db2cos during a database manager trap. The default is 255.

SQLQ_SIG_DUMP
Enable db2cos execution when SQLQ_SIG_DUMP signal is received.

-dbmcfg
Sets DBM Config Reserved Bitmap. This option is password protected which can be obtained from IBM DB2 Service.

xml=0 | 1
Values 0 (default) or 1 (instance has xml data).

-dbcfg Sets Database Config Reserved Bitmap. This option is password protected which can be obtained from IBM DB2 Service.

xml=0 | 1
Values 0 (default) or 1 (database has xml data).

-fodc Sets flags in the DB2 database memory sets. This influences the database system behavior during problem determination situations involving first occurrence data collection (FODC).

The supported -fodc options with their potential values and defaults are:

reset Restore all the FODC options to their defaults.

status Display status of all FODC options. This is a default option, i.e. FODC status will be displayed when db2pdcfg is invoked without parameters.

DUMPCORE=

Enables or disables core file generation on only UNIX and Linux platforms.

AUTO

Core file is generated if trap cannot be sustained and instance is shut down.

ON Enables core file generation and overrides **DB2RESILIENCE** registry variable setting.

OFF Disables core file generation.

DUMPDIR=*dirpath*

Specifies absolute pathname of the directory where core file or shared memory dump will be created. This option may be used for other large binary dumps that have to be stored outside of the FODC package, not only core file and shared memory dumps. Default is **DIAGPATH** directory or the default diagnostic directory if **DIAGPATH** is not defined.

CORELIMIT=*size*

The maximum size of core files created. This value will override current core file size limit setting. Consideration should be given to the available file system space because core files can be quite large. The size is dependent on the DB2 configuration and the state of the process at the time the problem occurs. If **CORELIMIT** is not set, DB2 will set the core file size to the value equal to the current **ulimit** setting. One exception is AIX where an 8 GB value will be used to override the core **ulimit** setting of unlimited.

If **CORELIMIT** is to be changed using **db2pdcfg**, it is subject to the usual UNIX access permissions and in some cases **CORELIMIT** will not be able to exceed your **ulimit** setting. Use **DB2FODC** registry variable to change that value on **db2start** or use large **ulimit** setting before starting DB2 product.

On AIX, a user core limit of "unlimited" will be overridden with a value of 8 GB for DB2 server processes only. This is to prevent the dumping of the large Fast Communications Manager (FCM) memory area in DPF or Intra-parallel-enabled environments. On AIX, a large portion of this memory area, which is rarely required in problem diagnosis, is also preallocated/uncommitted (not backed by system memory). While this preallocation supports dynamic memory requirements for FCM, dumping this memory to a core file would result in the immediate committing of that memory, and, in many cases, an unnecessarily large corefile. If a coredump of larger than 8 GB is required, the user core limit should be set to some large value other than unlimited, eg., the size of RAM. Alternatively, **CORELIMIT** can be set to a sufficiently large value. Note that any changes in the user core limit or **CORELIMIT** are not effective until the next recycling of the DB2 instance.

-flushbp

This option flushes dirty pages from the buffer pool to disk. You can specify the **-db** keyword followed by an active database name, as follows:

```
db2pdcfg -flushbp -db <dbname>
```

If you want to flush dirty pages from all buffer pools for all active databases, specify the **-alldb**s keyword, as follows:

```
db2pdcfg -flushbp -alldb
```

-trapresilience

This option displays or modifies trap resilience parameters for problem determination purposes.

The following is a sample output when this option is specified:

```
DB2 trap resilience is enabled.  
Current threshold setting : 0 (threshold disabled)  
Number of traps sustained : 0
```

threshold=number

Default value: 0 (threshold disabled)

Minimum value: 0

Maximum value: 4294967295

Specifying a number after the **threshold=** option sets the upper limit of traps which will be sustained for the life of the instance. When this threshold is surpassed, the instance will be stopped regardless if the next trap could have been sustained.

The following is a sample output when this option is specified:

```
db2pdcfg -trapresilience threshold=1
```

```
DB2 trap resilience threshold is set to 1
```

Usage notes

db2pdcfg is a method for dynamically changing (online) the FODC options.

Since db2pdcfg sets flags in the DB2 database memory, changes done with the db2pdcfg tool will be active only while the instance is up. In order to make the changes permanent, use the DB2FODC registry variable.

In the **-fodc** option, some of the settings are specified with the format **variable=value**. Multiple options can be specified in a single command line:

```
db2pdcfg -fodc DUMPCORE=ON -fodc CORELIMIT=8GB
```

Alternatively, several settings can be concatenated in a single command line string using spaces:

```
db2pdcfg -fodc DUMPCORE=ON CORELIMIT=8GB
```

Executing the db2pdcfg command, without any options, provides the following informative summary output with respect to trap resilience (highlighted in bold):

```
quark:/home/quark/marvin> db2pdcfg  
Current PD Control Block Settings:
```

```
All error catch flag settings cleared.
```

```
db2cos is enabled for engine traps.
```

```
PD Bitmap:    0x1000  
Sleep Time:   3  
Timeout:      30
```

```
Current bitmap value: 0x0
```

```
Instance is not in a sleep state
```

DB2 trap resilience is enabled.
Current threshold setting : 0 (threshold disabled)
Number of traps sustained : 0
FODC (First Occurrence Data Capture) options:
Dump directory for large objects (DUMPDIR)= /home/quark/marvin/sql1lib/db2dump/
Dump Core files (DUMPCORE)= ON

Chapter 241. db2perfc - Reset database performance values

Resets the performance values for one or more databases. It is used with the Performance Monitor on Windows operating systems.

Authorization

Local Administrator

Required connection

None

Command syntax



Command parameters

-d Specifies that performance values for DCS databases should be reset.

dbalias Specifies the databases for which the performance values should be reset. If no databases are specified, the performance values for all active databases will be reset.

Examples

The following example resets performance values for all active DB2 databases:

```
db2perfc
```

The following example resets performance values for specific DB2 databases:

```
db2perfc dbalias1 dbalias2
```

The following example resets performance values for all active DB2 DCS databases:

```
db2perfc -d
```

The following example resets performance values for specific DB2 DCS databases:

```
db2perfc -d dbalias1 dbalias2
```

Usage notes

When an application calls the DB2 monitor APIs, the information returned is normally the cumulative values since the DB2 server was started. However, it is often useful to reset performance values, run a test, reset the values again, and then rerun the test.

The program resets the values for all programs currently accessing database performance information for the relevant DB2 server instance (that is, the one held

in db2instance in the session in which you run db2perf). Invoking db2perf also resets the values seen by anyone remotely accessing DB2 performance information when the command is executed.

The db2ResetMonitor API allows an application to reset the values it sees locally, not globally, for particular databases.

Chapter 242. db2perfi - Performance counters registration utility

Adds the DB2 Performance Counters to the Windows operating system. This must be done to make DB2 and DB2 Connect performance information accessible to the Windows Performance Monitor.

Authorization

Local Administrator

Required connection

None

Command syntax

►► db2perfi [-i] [-u] ◀◀

Command parameters

- i Registers the DB2 performance counters.
- u Deregisters the DB2 performance counters.

Usage notes

The db2perfi -i command will do the following:

1. Add the names and descriptions of the DB2 counter objects to the Windows registry.
2. Create a registry key in the Services key in the Windows registry as follows:

```
HKEY_LOCAL_MACHINE
  \System
    \CurrentControlSet
      \Services
        \DB2_NT_Performance
          \Performance
            Library=Name of the DB2 performance support DLL
            Open=Open function name, called when the DLL is
              first loaded
            Collect=Collect function name, called to request
              performance information
            Close=Close function name, called when the DLL is
              unloaded
```

Chapter 243. db2perfr - Performance monitor registration tool

Used with the Performance Monitor on Windows operating systems. The db2perfr command is used to register an administrator user name and password with DB2 with DB2 when accessing the performance counters. This allows a remote Performance Monitor request to correctly identify itself to the DB2 database manager, and be allowed access to the relevant DB2 performance information. You also need to register an administrator user name and password if you want to log counter information into a file using the Performance Logs function.

Authorization

Local Administrator

Required connection

None

Command syntax

```
▶▶ db2perfr [-r username password] [-u] ▶▶
```

Command parameters

- r Registers the user name and password.
- u Deregisters the user name and password.

Usage notes

- Once a user name and password combination has been registered with DB2, even local instances of the Performance Monitor will explicitly log on using that user name and password. This means that if the user name information registered with DB2 does not match, local sessions of the Performance Monitor will not show DB2 performance information.
- The user name and password combination must be maintained to match the user name and password values stored in the Windows security database. If the user name or password is changed in the Windows security database, the user name and password combination used for remote performance monitoring must be reset.
- The default Windows Performance Monitor user name, SYSTEM, is a DB2 reserved word and cannot be used.

Chapter 244. db2rbind - Rebind all packages

Rebinds packages in a database.

Authorization

dbadm

Required connection

None

Command syntax

```
db2rbind database -l logfile [all] [-u userid -p password]
[-r [conservative|any]]
```

Command parameters

database

Specifies an alias name for the database whose packages are to be revalidated.

-l *logfile*

Specifies the (optional) path and the (mandatory) file name to be used for recording errors that result from the package revalidation procedure.

all

Specifies that rebinding of all valid and invalid packages is to be done. If this option is not specified, all packages in the database are examined, but only those packages that are marked as invalid are rebound, so that they are not rebound implicitly during application execution.

-u *userid*

User ID. This parameter must be specified if a password is specified.

-p *password*

Password. This parameter must be specified if a user ID is specified.

-r

Resolve. Specifies whether rebinding of the package is to be performed with or without conservative binding semantics. This affects whether new objects that use the SQL path for resolution are considered during resolution on static DML statements in the package. This option is not supported by DRDA. Valid values are:

conservative

Only those objects in the SQL path that were defined before the last explicit bind time stamp are considered for resolving references to any objects that use the SQL path for object resolution. Conservative binding semantics are used. This is the default. This option is not supported for an inoperative package.

any

All possible matches in the SQL path are considered for resolving

references to any objects that use the SQL path for object resolution. Conservative binding semantics are not used.

Usage notes

- This command uses the rebind API (sqlarbind) to attempt the re-validation of all packages in a database.
- Use of db2rbind is not mandatory.
- For packages that are invalid, you can choose to allow package revalidation to occur implicitly when the package is first used. You can choose to selectively revalidate packages with either the REBIND or the BIND command.
- If the rebind of any of the packages encounters a deadlock or a lock timeout the rebind of all the packages will be rolled back.

Chapter 245. db2relocatedb - Relocate database

This command renames a database, or relocates a database or part of a database (for example, the container and the log directory) as specified in the configuration file provided by the user. This tool makes the necessary changes to the DB2 instance and database support files.

Authorization

None

Command syntax

```
db2relocatedb -f configFilename
```

Command parameters

-f *configFilename*

Specifies the name of the file containing the configuration information necessary for relocating the database. This can be a relative or absolute file name. The format of the configuration file is:

```
DB_NAME=oldName,newName
DB_PATH=oldPath,newPath
INSTANCE=oldInst,newInst
NODENUM=nodeNumber
LOG_DIR=oldDirPath,newDirPath
CONT_PATH=oldContPath1,newContPath1
CONT_PATH=oldContPath2,newContPath2
...
STORAGE_PATH=oldStoragePath1,newStoragePath1
STORAGE_PATH=oldStoragePath2,newStoragePath2
...
```

Where:

DB_NAME

Specifies the name of the database being relocated. If the database name is being changed, both the old name and the new name must be specified. This is a required field.

DB_PATH

Specifies the original path of the database being relocated. If the database path is changing, both the old path and new path must be specified. This is a required field.

INSTANCE

Specifies the instance where the database exists. If the database is being moved to a new instance, both the old instance and new instance must be specified. This is a required field.

NODENUM

Specifies the node number for the database node being changed. The default is 0.

LOG_DIR

Specifies a change in the location of the log path. If the log path is being changed, both the old path and new path must be specified.

This specification is optional if the log path resides under the database path, in which case the path is updated automatically.

CONT_PATH

Specifies a change in the location of table space containers. Both the old and new container path must be specified. Multiple CONT_PATH lines can be provided if there are multiple container path changes to be made. This specification is optional if the container paths reside under the database path, in which case the paths are updated automatically. If you are making changes to more than one container where the same old path is being replaced by a common new path, a single CONT_PATH entry can be used. In such a case, an asterisk (*) could be used both in the old and new paths as a wildcard.

STORAGE_PATH

This is only applicable to databases with automatic storage enabled. It specifies a change in the location of one of the storage paths for the database. Both the old storage path and the new storage path must be specified. Multiple STORAGE_PATH lines can be given if there are several storage path changes to be made.

Blank lines or lines beginning with a comment character (#) are ignored.

Examples

Example 1

To change the name of the database TESTDB to PRODDB in the instance db2inst1 that resides on the path /home/db2inst1, create the following configuration file:

```
DB_NAME=TESTDB,PRODDB
DB_PATH=/home/db2inst1
INSTANCE=db2inst1
NODENUM=0
```

Save the configuration file as relocate.cfg and use the following command to make the changes to the database files:

```
db2relocatedb -f relocate.cfg
```

Example 2

To move the database DATAB1 from the instance jsmith on the path /dbpath to the instance prodinst do the following:

1. Move the files in the directory /dbpath/jsmith to /dbpath/prodinst.
2. Use the following configuration file with the db2relocatedb command to make the changes to the database files:

```
DB_NAME=DATAB1
DB_PATH=/dbpath
INSTANCE=jsmith,prodinst
NODENUM=0
```

Example 3

The database PRODDB exists in the instance inst1 on the path /databases/PRODDB. The location of two table space containers needs to be changed as follows:

- SMS container /data/SMS1 needs to be moved to /DATA/NewSMS1.

- DMS container /data/DMS1 needs to be moved to /DATA/DMS1.

After the physical directories and files have been moved to the new locations, the following configuration file can be used with the db2relocatedb command to make changes to the database files so that they recognize the new locations:

```
DB_NAME=PRODDB
DB_PATH=/databases/PRODDB
INSTANCE=inst1
NODENUM=0
CONT_PATH=/data/SMS1,/DATA/NewSMS1
CONT_PATH=/data/DMS1,/DATA/DMS1
```

Example 4

The database TESTDB exists in the instance db2inst1 and was created on the path /databases/TESTDB. Table spaces were then created with the following containers:

```
TS1
TS2_Cont0
TS2_Cont1
/databases/TESTDB/TS3_Cont0
/databases/TESTDB/TS4_Cont0
/Data/TS5_Cont0
/dev/rTS5_Cont1
```

TESTDB is to be moved to a new system. The instance on the new system will be newinst and the location of the database will be /DB2.

When moving the database, all of the files that exist in the /databases/TESTDB/db2inst1 directory must be moved to the /DB2/newinst directory. This means that the first 5 containers will be relocated as part of this move. (The first 3 are relative to the database directory and the next 2 are relative to the database path.) Since these containers are located within the database directory or database path, they do not need to be listed in the configuration file. If the 2 remaining containers are to be moved to different locations on the new system, they must be listed in the configuration file.

After the physical directories and files have been moved to their new locations, the following configuration file can be used with db2relocatedb to make changes to the database files so that they recognize the new locations:

```
DB_NAME=TESTDB
DB_PATH=/databases/TESTDB,/DB2
INSTANCE=db2inst1,newinst
NODENUM=0
CONT_PATH=/Data/TS5_Cont0,/DB2/TESTDB/TS5_Cont0
CONT_PATH=/dev/rTS5_Cont1,/dev/rTESTDB_TS5_Cont1
```

Example 5

The database TESTDB has two database partitions on database partition servers 10 and 20. The instance is servinst and the database path is /home/servinst on both database partition servers. The name of the database is being changed to SERVDB and the database path is being changed to /databases on both database partition servers. In addition, the log directory is being changed on database partition server 20 from /testdb_logdir to /servdb_logdir.

Since changes are being made to both database partitions, a configuration file must be created for each database partition and db2relocatedb must be run on each database partition server with the corresponding configuration file.

On database partition server 10, the following configuration file will be used:

```
DB_NAME=TESTDB,SERVDB
DB_PATH=/home/servinst,/databases
INSTANCE=servinst
NODE_NUM=10
```

On database partition server 20, the following configuration file will be used:

```
DB_NAME=TESTDB,SERVDB
DB_PATH=/home/servinst,/databases
INSTANCE=servinst
NODE_NUM=20
LOG_DIR=/testdb_logdir,/servdb_logdir
```

Example 6

The database MAINDB exists in the instance maininst on the path /home/maininst. The location of four table space containers needs to be changed as follows:

```
/maininst_files/allconts/C0 needs to be moved to /MAINDB/C0
/maininst_files/allconts/C1 needs to be moved to /MAINDB/C1
/maininst_files/allconts/C2 needs to be moved to /MAINDB/C2
/maininst_files/allconts/C3 needs to be moved to /MAINDB/C3
```

After the physical directories and files are moved to the new locations, the following configuration file can be used with the db2relocatedb command to make changes to the database files so that they recognize the new locations.

A similar change is being made to all of the containers; that is, /maininst_files/allconts/ is being replaced by /MAINDB/ so that a single entry with the wildcard character can be used:

```
DB_NAME=MAINDB
DB_PATH=/home/maininst
INSTANCE=maininst
NODE_NUM=0
CONT_PATH=/maininst_files/allconts/*, /MAINDB/*
```

Usage notes

If the instance that a database belongs to is changing, the following must be done before running this command to ensure that changes to the instance and database support files are made:

- If a database is being moved to another instance, create the new instance. The new instance must be at the same release level as the instance where the database currently resides.
- Copy the files and devices belonging to the databases being copied onto the system where the new instance resides. The path names must be changed as necessary. However, if there are already databases in the directory where the database files are moved to, you can mistakenly overwrite the existing sqldbdir file, thereby removing the references to the existing databases. In this scenario, the db2relocatedb utility cannot be used. Instead of db2relocatedb, an alternative is a redirected restore operation.
- Change the permission of the files/devices that were copied so that they are owned by the instance owner.

The db2relocatedb command cannot be used to move existing user created containers for a table space that was converted to use automatic storage using the ALTER TABLESPACE MANAGED BY AUTOMATIC STORAGE statement.

If the instance is changing, the tool must be run by the new instance owner.

In a partitioned database environment, this tool must be run against every database partition that requires changes. A separate configuration file must be supplied for each database partition, that includes the NODENUM value of the database partition being changed. For example, if the name of a database is being changed, every database partition will be affected and the db2relocatedb command must be run with a separate configuration file on each database partition. If containers belonging to a single database partition are being moved, the db2relocatedb command only needs to be run once on that database partition.

You cannot use the db2relocatedb command to relocate a database that has a load in progress or is waiting for the completion of a LOAD RESTART or LOAD TERMINATE command.

Limitation: In a partitioned database environment, you cannot relocate an entire node if that node is one of two or more logical partitions that reside on the same device.

Chapter 246. db2rfpen - Reset rollforward pending state

Puts a database in rollforward pending state. If you are using high availability disaster recovery (HADR), the database is reset to a standard database.

Authorization

None

Required connection

None

Command syntax

```
db2rfpen -ON database_alias
           -file log_control_file
           -path log_control_files_dir
```

Command parameters

database_alias

Specifies the name of the database to be placed in rollforward pending state. If you are using high availability disaster recovery (HADR), the database is reset to a standard database.

-file *log_control_file*

Specifies the log control file path and file name.

-path *log_control_files_dir*

Specifies the full path to the directory where the log control files, SQLLOGCTL.LFH.1 and its mirror copy SQLLOGCTL.LFH.2, reside.

Usage notes

With the **-file** parameter, only the specified log control file, for example either SQLLOGCTL.LFH.1 or SQLLOGCTL.LFH.2, will be updated. This will cause the two files to be out of synchronization. For this reason, it is recommended that the *database_alias* or the **-path** option be used whenever possible, rather than the **-file** option.

Chapter 247. db2rmicons - Remove DB2 tools from main menu command

Removes main menu entries for DB2 tools.

On Linux operating systems, the db2rmicons command removes main menu entries for DB2 tools for the current user. The main menu entries for DB2 tools are removed by manually running the db2rmicons command, or are removed automatically when specific DB2 commands are run (for example, db2_deinstall or db2idrop.) For non-root installations, the db2_deinstall command removes the entries for the DB2 instance related to the non-root installation.

Authorization

None

Command syntax

►► db2rmicons -h ◀◀

Command parameters

-h Displays usage information.

Chapter 248. db2rspgn - Response file generator

Generates response files and instance configuration profiles for the current copy. These generated files are used to recreate an exact setup on other machines.

Command syntax

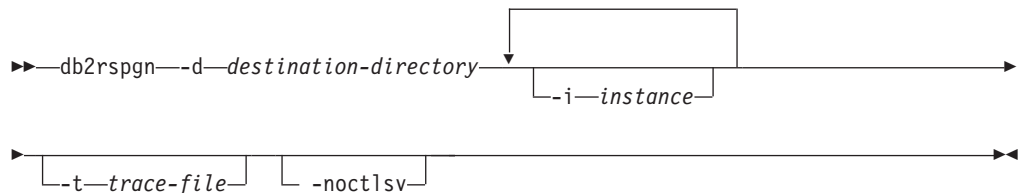

Command parameters

-d *destination-directory*

Specifies the full path to the output directory for generated files. If the output directory specified is an existing directory, the directory must be empty and writable. If the output directory specified does not exist, the new directory is created if the location is writable. This parameter is mandatory.

-i *instance*

Generates the specified instance configuration and saves this information in the generated response file and instance configuration profile. This parameter is optional. By default, all instances are selected. To specify multiple instances, specify this parameter multiple times. For example, `-i db2inst1 -i db2inst3`.

-t *trace-file*

Linux and UNIX operating systems only. Turns on the debug mode. The debug information is written to the file name specified as `trace-file`.

-noctlsv

Windows operating systems only. Indicates that an instance configuration profile file will not be generated for the Control Server instance. This parameter is optional.

Chapter 249. db2sampl - Create sample database

Creates a sample database named SAMPLE.

This database will not be automatically configured when it is first created. Users can issue the AUTOCONFIGURE command against the SAMPLE database at a later time.

Authorization

One of the following:

- *sysadm*
- *sysctrl*

Required Connection

None

Command syntax

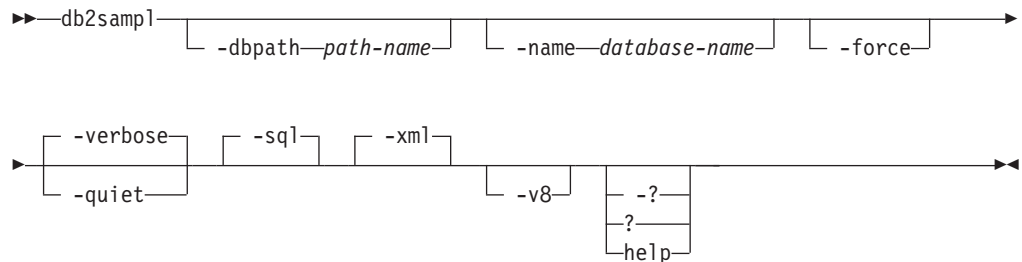

Command parameters

-dbpath *path-name*

Specifies the path on which to create the database. On Windows operating systems, specifies the letter of the drive on which to create the database. The maximum length for *path-name* is 175 characters. By default, *path-name* is the default path specified in the database manager configuration file (`dftdbpath` parameter).

-name *database-name*

Specifies a name for the sample database. The database name must adhere to the naming conventions for databases. By default, *database-name* is SAMPLE.

-force Forces the drop and recreation of any existing database in the instance with the same name as specified for the sample database.

-verbose

Prints status messages to standard output.

-quiet Suppresses the printing of status messages to standard output.

-sql Creates tables, triggers, functions, procedures, and populates the tables with data.

-xml Creates tables with columns of data type XML, creates indexes on the XML columns, registers XML schemas, and populates these tables with data including XML document values.

This option is only supported where XML is supported. If XML is not supported, this option is ignored.

-v8 Creates the DB2 Universal Database Version 8 sample database, database objects and data. The Version 8 sample database is a non-unicode database named SAMPLE that is created in the default path specified in the database manager configuration file (dftdbpath parameter).

-? | ? | help

Returns the db2sampl command syntax help.

Default behavior of db2sampl

When the db2sampl command is issued without any optional arguments, depending on whether the environment is partitioned or not, it behaves differently:

In non-partitioned database environments:

- Creates a database named SAMPLE with a Unicode (UTF-8) codeset and a UCA400_NO collation and a C (POSIX) territory in the default database path.
- Creates relational database objects including tables, indexes, constraints, triggers, functions, procedures, multi-dimensional clustered tables and materialized query tables.
- Populates relational tables with data.
- Creates tables with XML data type columns.
- Creates indexes over XML data.
- Creates an XML schema repository that contains XML schema documents.
- All database object names are qualified with the value of the CURRENT_SCHEMA special register.

In partitioned database environments:

- Creates a database named SAMPLE with a Unicode (UTF-8) codeset and a UCA400_NO collation and a C (POSIX) territory in the default database path.
- Creates relational database objects including tables, indexes, constraints, triggers, functions, procedures, multi-dimensional clustered tables and materialized query tables.
- Populates tables with data.
- All database object names are qualified with the value of the CURRENT_SCHEMA special register.

Usage notes

- The db2sampl command can only be issued on a computer where a DB2 database server is installed. It cannot be issued from a remote IBM Data Server Client.
- The sample database is created with the instance authentication type that is specified by the database manager configuration parameter, authentication.

Examples

- To create a sample database with the default characteristics, issue:
db2sampl

- On Windows operating systems, to create a sample database named *mysample* on the E: drive containing only SQL database objects in default schema and to view status messages, issue:
`db2sampl -dbpath E -name mysample -sql -force -verbose`
- To create the DB2 Version 8 sample database, issue:
`db2sampl -v8`

Chapter 250. db2schex - Active Directory schema extension command

If you plan to use the Lightweight Directory Access Protocol (LDAP) directory server feature with Windows Server 2003 and above, the Microsoft Active Directory schema needs to be extended to include the new DB2 object classes and attribute definitions. The process of adding new object classes and attributes to the directory schema is called *schema extension*.

You must extend the schema in Active Directory by running the DB2 schema extension command called db2schex from a machine that already has a version of DB2 V9.5 installed. Alternatively, run db2schex.exe from a DB2 V9.1 or DB2 V8.2 installation image/CD.

The db2schex command is included on the product DVD. The location of this command on the DVD is in the path x:\db2\windows\utilities, where x: specifies the DVD drive.

Authorization

To update the Active Directory schema, you must be a member of the Schema Administrators group or have been delegated the rights to update the schema.

Required connection

Access to a Windows Domain Controller server in the target domain.

Command syntax

```
db2schex [-b bindDN] [-w password] [-k] [-u] [-x filename]
```

Command parameters

-b *bindDN*

Specifies the user Distinguished Name.

-w *password*

Specifies the bind password.

-k

Forces the uninstall to continue, ignoring errors.

-u

Uninstall the schema.

-x *filename*

Specify this parameter to write the changes to the Active Directory schema, performed by the utility, to a file.

Examples

To install the DB2 schema, execute the following command:

```
db2schex
```

To install the DB2 schema and specify a bind DN and password, execute the following command:

```
db2schex -b "cn=A_Name,dc=toronto1,dc=ibm,dc=com" -w password
```

or,

```
db2schex -b Administrator -w password
```

To uninstall the DB2 schema, execute the following command:

```
db2schex -u
```

To uninstall the DB2 schema and ignore errors, execute the following command:

```
db2schex -u -k
```

Usage notes

If *bindDN* and *password* are not specified, db2schex binds as the currently logged in user.

The *bindDN* parameter can be specified as a Windows username.

The DB2 schema extension command carries out the following tasks:

- Detects which server is the Schema Master
- Binds to the Domain Controller that is the Schema Master
- Ensures that the user has sufficient rights to add classes and attributes to the schema
- Ensures that the Schema Master is writable (that is, the safety interlock in the registry is removed)
- Creates all the new attributes
- Creates all the new object classes
- Detects errors and, if they occur, the program will roll back any changes to the schema.

Chapter 251. db2set - DB2 profile registry

Displays, sets, or removes DB2 profile variables. An external environment registry command that supports local and remote administration, via the DB2 Administration Server, of DB2's environment variables stored in the DB2 profile registry.

Authorization

sysadm

Required connection

None

Command syntax

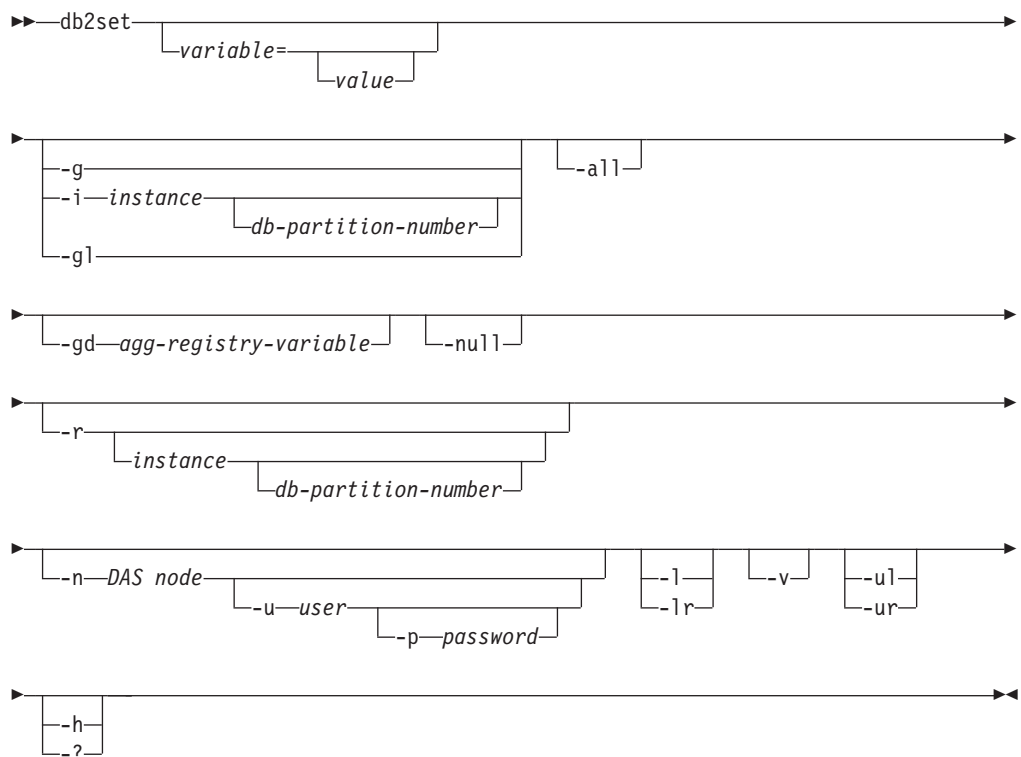

Command parameters

variable=

Displays the specified variable's value.

value

Sets the specified variable to the entered value. To delete a variable, do not specify a value for the specified variable after the equal sign (=). Changes to settings take effect after the instance has been restarted.

-g

Accesses the global profile registry variables for all instances pertaining to a particular DB2 copy.

- i** Specifies the instance profile to use instead of the current, or default.
- db-partition-number***
Specifies a number listed in the `db2nodes.cfg` file.
- gl** Accesses the global profile variables stored in LDAP. This option is only effective if the registry variable `DB2_ENABLE_LDAP` has been set to YES.
- all** Displays all occurrences of the local environment variables as defined in:
 - The environment, denoted by [e]
 - The node level registry, denoted by [n]
 - The instance level registry, denoted by [i]
 - The global level registry, denoted by [g].
- gd *agg-registry-variable***
Displays the group definition of an aggregate registry variable. For additional information, see “Aggregate registry variables” in the *Data Servers, Databases, and Database Objects Guide*.
- null** Sets the value of the variable at the specified registry level to NULL. This avoids having to look up the value in the next registry level, as defined by the search order.
- r *instance***
Resets the profile registry for the given instance. If no instance is specified, and an instance attachment exists, resets the profile for the current instance. If no instance is specified, and no attachment exists, resets the profile for the instance specified by the `DB2INSTANCE` environment variable.
- n *DAS node***
Specifies the remote DB2 administration server node name.
- u *user*** Specifies the user ID to use for the administration server attachment.
- p *password***
Specifies the password to use for the administration server attachment.
- l** Lists all instance profiles for the current DB2 product installation.
- lr** Lists all supported registry variables.
- v** Specifies verbose mode.
- ul** Accesses the user profile variables. This parameter is supported on Windows operating systems only.
- ur** Refreshes the user profile variables. This parameter is supported on Windows operating systems only.
- h | -?** Displays help information. When this option is specified, all other options are ignored, and only the help information is displayed.

Examples

- Display all defined profiles (DB2 instances) pertaining to a particular installation
:

```
db2set -l
```
- Display all supported registry variables:

```
db2set -lr
```
- Display all defined global variables which are visible by all instances pertaining to a particular installation:

- ```
db2set -g
```
- Display all defined variables for the current instance:
 

```
db2set
```
- Display all defined values for the current instance:
 

```
db2set -all
```
- Display all defined values for DB2COMM for the current instance:
 

```
db2set -all DB2COMM
```
- Reset all defined variables for the instance INST on node 3:
 

```
db2set -r -i INST 3
```
- Unset the variable DB2CHKPTR on the remote instance RMTINST through the DAS node RMTDAS using user ID MYID and password MYPASSWD:
 

```
db2set -i RMTINST -n RMTDAS -u MYID -p MYPASSWD DB2CHKPTR=
```
- Set the variable DB2COMM to be TCPIP globally for all instances pertaining to a particular installation:
 

```
db2set -g DB2COMM=TCPIP
```
- Set the variable DB2COMM to be only TCPIP for instance MYINST:
 

```
db2set -i MYINST DB2COMM=TCPIP
```
- Set the variable DB2COMM to null at the given instance level:
 

```
db2set -null DB2COMM
```

## Usage notes

If no variable name is specified, the values of all defined variables are displayed. If a variable name *is* specified, only the value of that variable is displayed. To display all the defined values of a variable, specify *variable* -all. To display all the defined variables in all registries, specify -all.

To modify the value of a variable, specify *variable*=, followed by its new value. To set the value of a variable to NULL, specify *variable* -null. Changes to settings take effect after the instance has been restarted.

To delete a variable, specify *variable*=, followed by no value.

Although the command behaves the same for non-root installations of DB2, not all parameters are available, such as the one specifying the DAS node name.



---

## Chapter 252. db2setup - Install DB2

Installs DB2 products. This command is only available on Linux and UNIX systems. The command for Windows operating systems is setup.

This utility is located on the DB2 installation media. It launches the DB2 Setup wizard to define the installation and install DB2 products. If invoked with the `-r` option, it performs an installation without further input, taking installation configuration information from a response file.

### Authorization

On Linux and UNIX systems, root installations require root authority. For non-root installations, you must log on with the user ID that owns the non-root installation.

### Command syntax

```
db2setup [-i language] [-l log_file] [-t trace_file]
 [-r response_file] [-f nobackup] [--?] [-h]
```

### Command parameters

**-i** *language*

Two-letter language code of the language in which to perform the installation.

**-l** *log\_file*

Writes the log to the file name specified. For root installations, the default log file is `/tmp/db2setup.log`. For non-root installations, the default log file is `/tmp/db2setup_userID.log`, where *userID* represents the user ID that owns the non-root installation. If the IBM Tivoli System Automation for Multiplatforms (SA MP) is being installed with `db2setup`, the install log file for SA MP will be located in the same directory as the DB2 log files.

**-t** *trace\_file*

Generates a file with install trace information.

**-r** *response\_file*

Full path and file name of the response file to use.

**-f** *nobackup*

This applies to the non-root upgrade only. Force `db2setup` to not backup installation files when the components are updated. If you choose not to backup the files, the space requirement of the installation directory is reduced. However, choosing not to backup the files also means that if any errors occur, the DB2 installer will not be able to perform a rollback operation. In this case, you will need to manually clean up the files and reinstall the product.

**-?** | **-h** Generates usage information.

## Usage notes

You must log on with the ID that has proper authority or use su with the "-" flag (su -) to set the process environment as if you had logged in with the ID that has proper authority. If the process environment is not set with the ID that has proper authority, the installation process finishes without errors but you will encounter errors when you run the DB2 copy.



---

## Chapter 253. db2sqljbind - SQLJ profile binder

db2sqljbind binds DB2 packages for a serialized profile that was previously customized with the db2sqljcustomize command.

Applications that run with the IBM Data Server Driver for JDBC and SQLJ require packages but no plans. If the db2sqljcustomize -automaticbind option is specified as YES or defaults to YES, db2sqljcustomize binds packages for you at the data source that you specify in the -url parameter. However, if -automaticbind is NO, if a bind fails when db2sqljcustomize runs, or if you want to create identical packages at multiple locations for the same serialized profile, you can use the db2sqljbind command to bind packages.

### Authorization

The privilege set of the process must include one of the following authorities:

- DBADM authority
- If the package does not exist, the BINDADD privilege, and one of the following privileges:
  - CREATEIN privilege
  - IMPLICIT\_SCHEMA authority on the database if the schema name of the package does not exist
- If the package exists:
  - ALTERIN privilege on the schema
  - BIND privilege on the package

The user also needs all privileges that are required to compile any static SQL statements in the application. Privileges that are granted to groups are not used for authorization checking of static statements.

### Command syntax

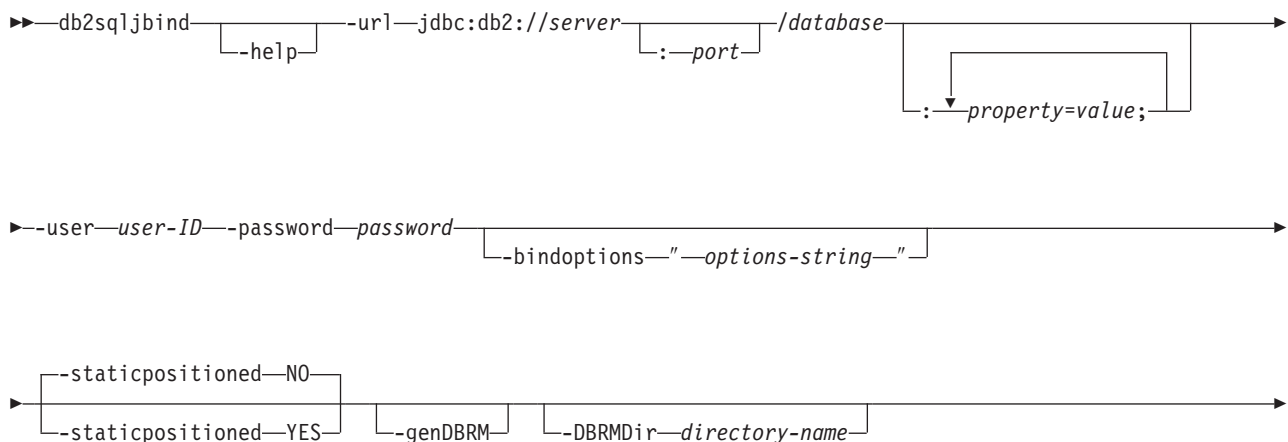

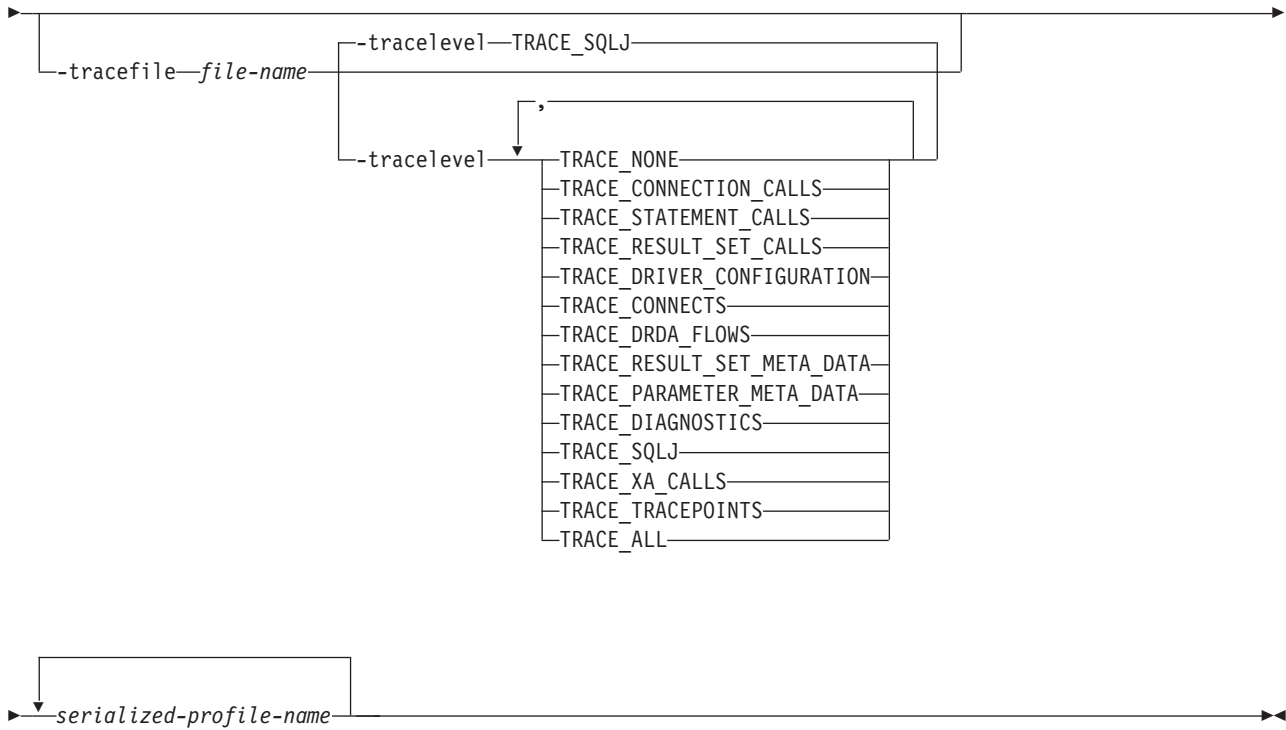

**options-string:**

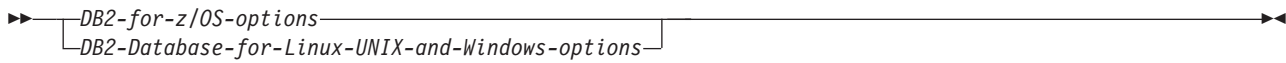

**DB2 for z/OS options:**

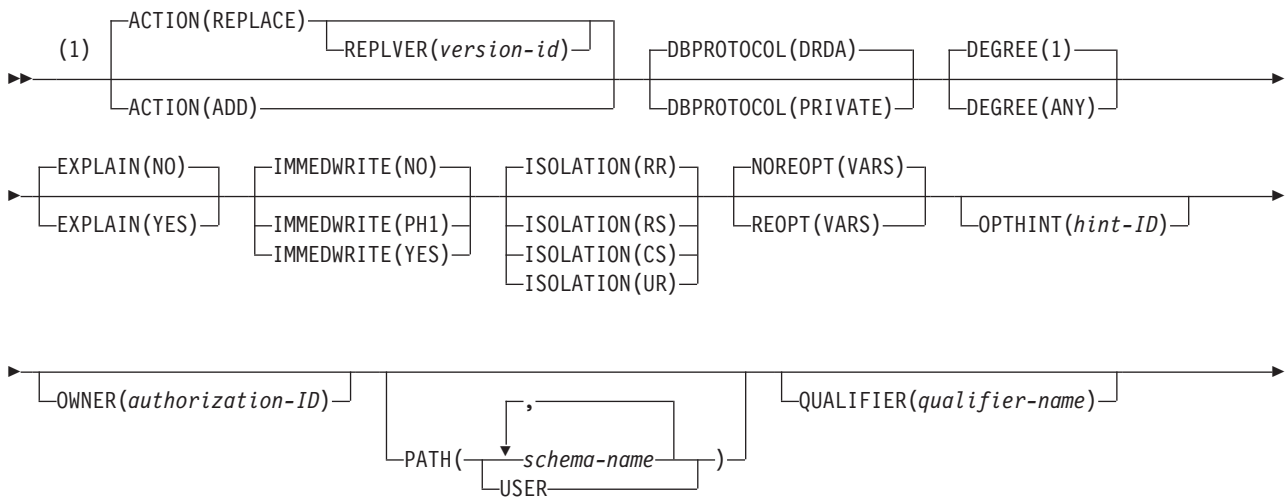

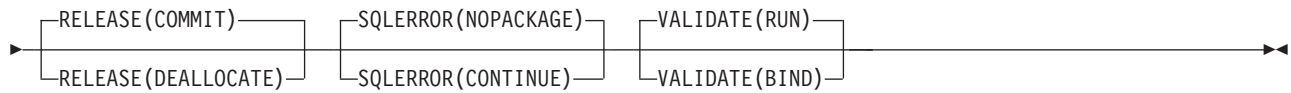

**Notes:**

- 1 These options can be specified in any order.

*DB2 Database for Linux, UNIX, and Windows options*

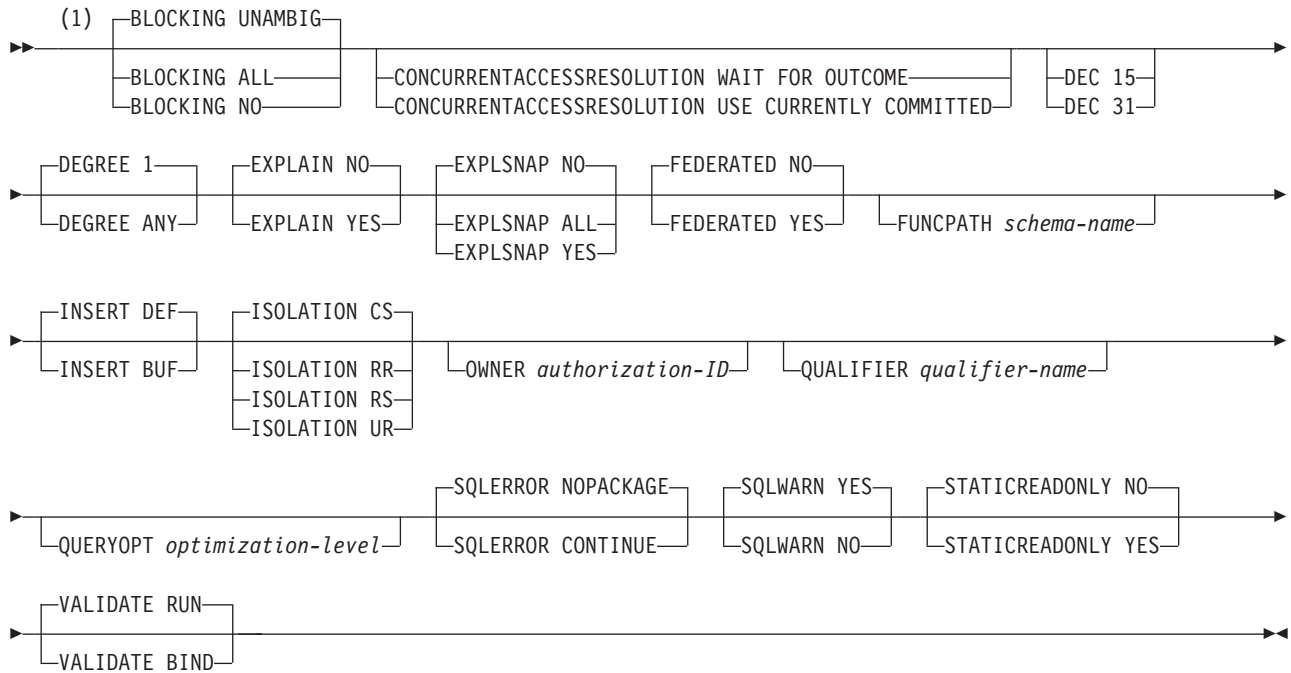

**Notes:**

- 1 These options can be specified in any order.

**Command parameters**

**-help**

Specifies that db2sqljbind describes each of the options that it supports. If any other options are specified with -help, they are ignored.

**-url**

Specifies the URL for the data source for which the profile is to be customized. A connection is established to the data source that this URL represents if the -automaticbind or -onlinecheck option is specified as YES or defaults to YES. The variable parts of the -url value are:

**server**

The domain name or IP address of the operating system on which the database server resides.

**port**

The TCP/IP server port number that is assigned to the database server. The default is 446.

## database

A name for the database server for which the profile is to be customized.

If the connection is to a DB2 for z/OS server, *database* is the DB2 location name that is defined during installation. All characters in this value must be uppercase characters. You can determine the location name by executing the following SQL statement on the server:

```
SELECT CURRENT SERVER FROM SYSIBM.SYSDUMMY1;
```

If the connection is to a DB2 Database for Linux, UNIX, and Windows server, *database* is the database name that is defined during installation.

If the connection is to an IBM Cloudscape® server, the *database* is the fully-qualified name of the file that contains the database. This name must be enclosed in double quotation marks ("). For example:

```
"c:/databases/testdb"
```

*property=value;*

A property for the JDBC connection.

## -user *user-ID*

Specifies the user ID to be used to connect to the data source for binding the package.

## -password *password*

Specifies the password to be used to connect to the data source for binding the package.

## -bindoptions *options-string*

Specifies a list of options, separated by spaces. These options have the same function as DB2 precompile and bind options with the same names. If you are preparing your program to run on a DB2 for z/OS system, specify DB2 for z/OS options. If you are preparing your program to run on a DB2 Database for Linux, UNIX, and Windows system, specify DB2 Database for Linux, UNIX, and Windows options.

### *Notes on bind options:*

- Specify VERSION only if the following conditions are true:
  - If you are binding a package at a DB2 Database for Linux, UNIX, and Windows system, the system is at Version 8 or later.
  - You rerun the translator on a program before you bind the associated package with a new VERSION value.
- The value for STATICREADONLY is YES for servers that support STATICREADONLY, and NO for other servers. When you specify STATICREADONLY YES, DB2 processes ambiguous cursors as if they were read-only cursors. For troubleshooting iterator declaration errors, you need to explicitly specify STATICREADONLY NO, or declare iterators so that they are unambiguous. For example, if you want an iterator to be unambiguously updatable, declare the iterator to implement sqlj.runtime.ForUpdate. If you want an iterator to be read-only, include the FOR READ ONLY clause in SELECT statements that use the iterator.

**Important:** Specify only those program preparation options that are appropriate for the data source at which you are binding a package. Some values and defaults for the IBM Data Server Driver for JDBC and SQLJ are different from the values and defaults for DB2.

## -staticpositioned NO|YES

For iterators that are declared in the same source file as positioned UPDATE statements that use the iterators, specifies whether the positioned UPDATES

are executed as statically bound statements. The default is NO. NO means that the positioned UPDATES are executed as dynamically prepared statements. This value must be the same as the -staticpositioned value for the previous db2sqljcustomize invocation for the serialized profile.

#### **-genDBRM**

Specifies that db2sqljbind generates database request modules (DBRMs) from the serialized profile, and that db2sqljbind does not perform remote bind operations.

-genDBRM applies to programs that are to be run on DB2 for z/OS database servers only.

#### **-DBRMDir** *directory-name*

When -genDBRM is specified, -DBRMDir specifies the local directory into which db2sqljbind puts the generated DBRM files. The default is the current directory.

-DBRMdir applies to programs that are to be run on DB2 for z/OS database servers only.

#### **-tracefile** *file-name*

Enables tracing and identifies the output file for trace information. This option should be specified only under the direction of IBM Software Support.

#### **-tracelevel**

If -tracefile is specified, indicates what to trace while db2sqljcustomize runs. The default is TRACE\_SQLJ. This option should be specified only under the direction of IBM Software Support.

#### *serialized-profile-name*

Specifies the name of one or more serialized profiles from which the package is bound. A serialized profile name is of the following form:

*program-name*\_SJProfileIDNumber.ser

*program-name* is the name of the SQLJ source program, without the extension .sqlj. *n* is an integer between 0 and *m*-1, where *m* is the number of serialized profiles that the SQLJ translator generated from the SQLJ source program.

If you specify more than one serialized profile name to bind a single DB2 package from several serialized profiles, you must have specified the same serialized profile names, in the same order, when you ran db2sqljcustomize.

## **Examples**

```
db2sqljbind -user richler -password mordecai
 -url jdbc:db2://server:50000/sample -bindoptions "EXPLAIN YES"
 pgmname_SJProfile0.ser
```

## **Usage notes**

**Package names produced by db2sqljbind:** The names of the packages that are created by db2sqljbind are the names that you specified using the-rootpkgname or -singlepkgname parameter when you ran db2sqljcustomize. If you did not specify -rootpkgname or -singlepkgname, the package names are the first seven bytes of the profile name, appended with the isolation level character.

**DYNAMICRULES value for db2sqljbind:** The DYNAMICRULES bind option determines a number of run-time attributes for the DB2 package. Two of those attributes are the authorization ID that is used to check authorization, and the

qualifier that is used for unqualified objects. To ensure the correct authorization for dynamically executed positioned UPDATE and DELETE statements in SQLJ programs, db2sqljbind always binds the DB2 packages with the DYNAMICRULES(BIND) option. You cannot modify this option. The DYNAMICRULES(BIND) option causes the SET CURRENT SQLID statement and the SET CURRENT SCHEMA statement to have no impact on an SQLJ program, because those statements affect only dynamic statements that are bound with DYNAMICRULES values other than BIND.

With DYNAMICRULES(BIND), unqualified table, view, index, and alias names in dynamic SQL statements are implicitly qualified with value of the bind option QUALIFIER. If you do not specify QUALIFIER, DB2 uses the authorization ID of the package owner as the implicit qualifier. If this behavior is not suitable for your program, you can use one of the following techniques to set the correct qualifier:

- Force positioned UPDATE and DELETE statements to execute statically. You can use the -staticpositioned YES option of db2sqljcustomize or db2sqljbind to do this if the cursor (iterator) for a positioned UPDATE or DELETE statement is in the same package as the positioned UPDATE or DELETE statement.
- Fully qualify DB2 table names in positioned UPDATE and positioned DELETE statements.

---

## Chapter 254. db2sqljcustomize - SQLJ profile customizer

db2sqljcustomize processes an SQLJ profile, which contains embedded SQL statements.

By default, db2sqljcustomize produces four DB2 packages: one for each isolation level. db2sqljcustomize augments the profile with DB2-specific information for use at run time.

### Authorization

The privilege set of the process must include one of the following authorities:

- DBADM authority
- If the package does not exist, the BINDADD privilege, and one of the following privileges:
  - CREATEIN privilege
  - IMPLICIT\_SCHEMA authority on the database if the schema name of the package does not exist
- If the package exists:
  - ALTERIN privilege on the schema
  - BIND privilege on the package

The user also needs all privileges that are required to compile any static SQL statements in the application. Privileges that are granted to groups are not used for authorization checking of static statements.

### Command syntax

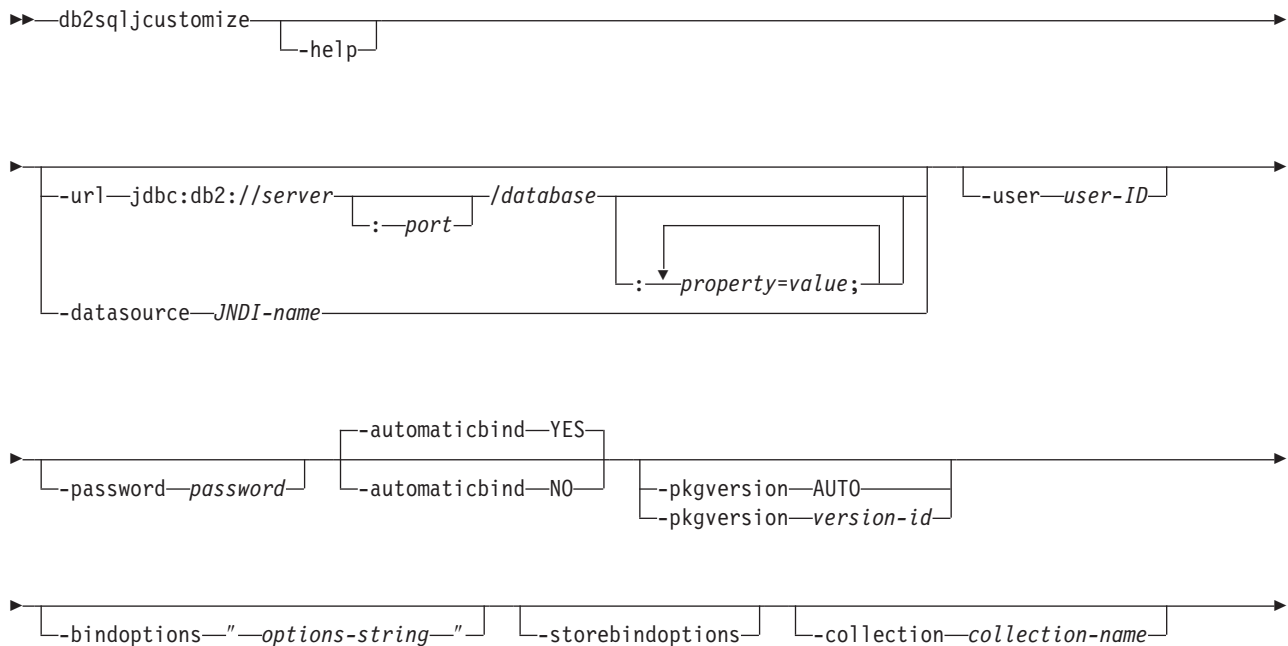

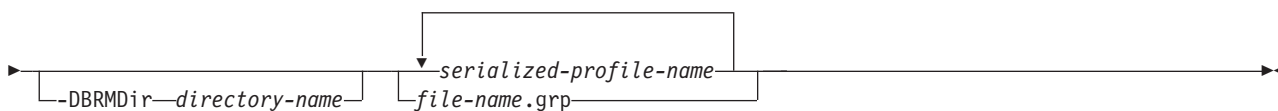
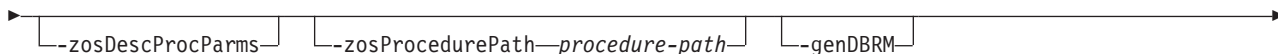
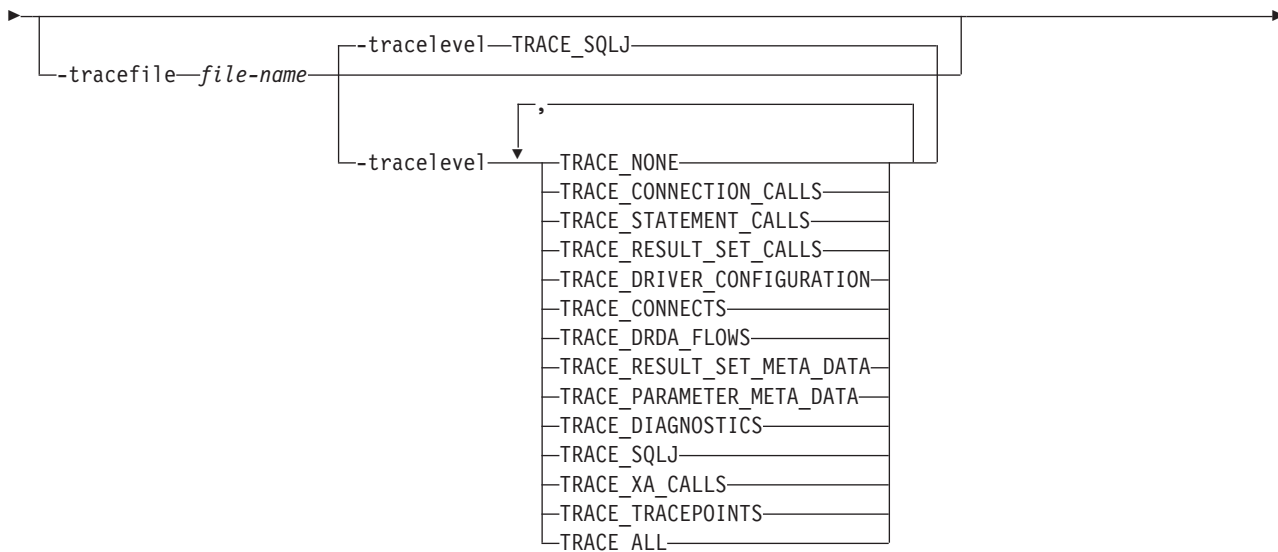
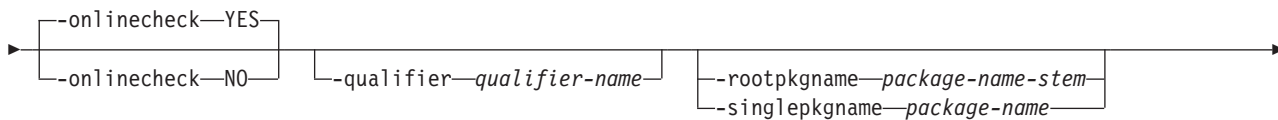

**options-string:**



**DB2 for z/OS options:**

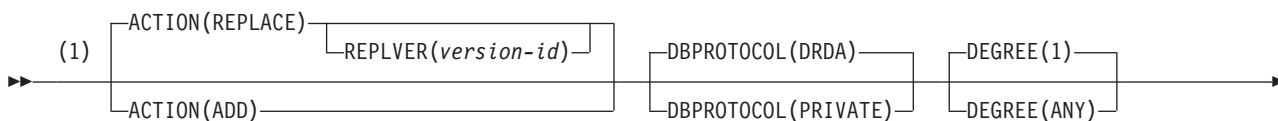



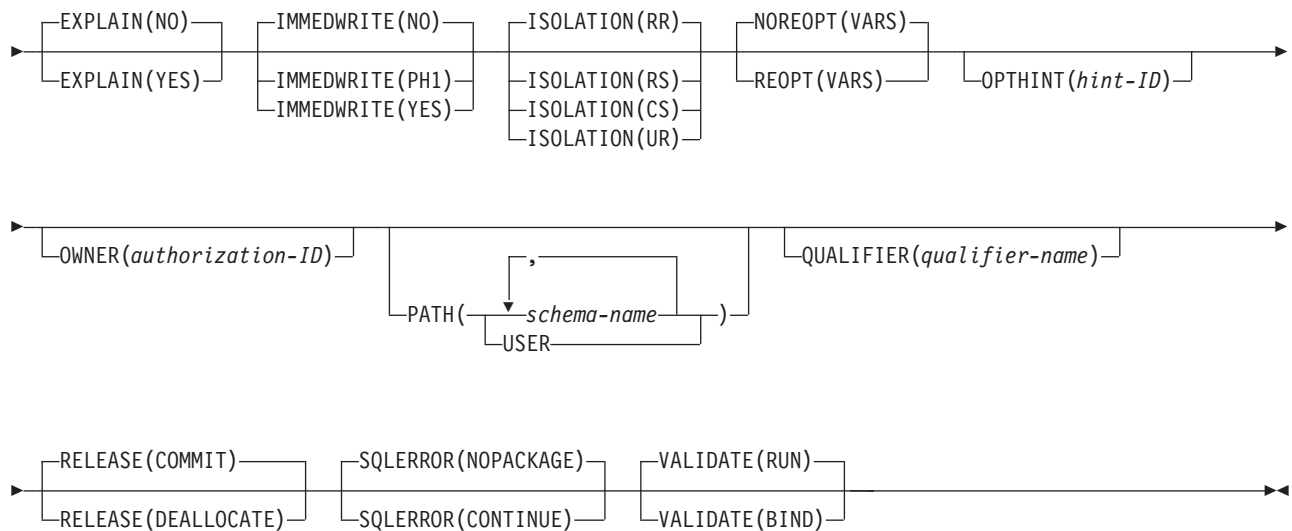

**Notes:**

- 1 These options can be specified in any order.

**DB2 Database for Linux, UNIX, and Windows options**

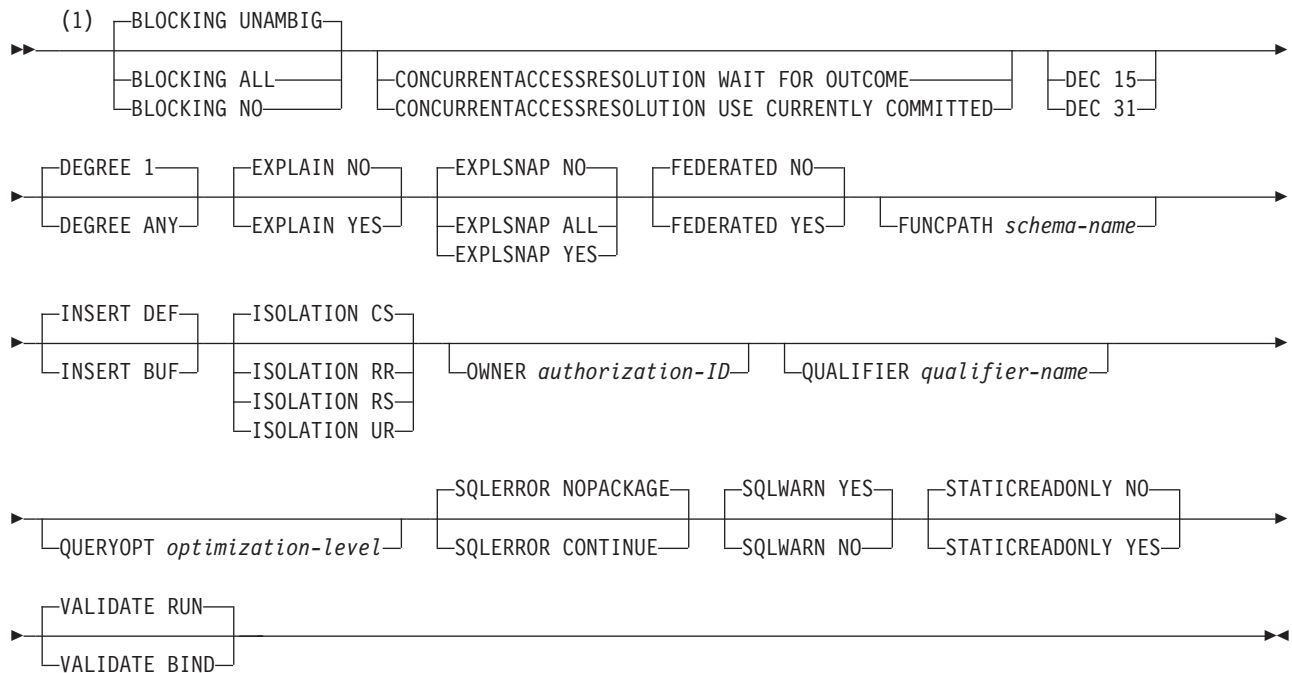

**Notes:**

- 1 These options can be specified in any order.

**Command parameters**

**-help**

Specifies that the SQLJ customizer describes each of the options that the customizer supports. If any other options are specified with -help, they are ignored.

**-url**

Specifies the URL for the data source for which the profile is to be customized. A connection is established to the data source that this URL represents if the `-automaticbind` or `-onlinecheck` option is specified as YES or defaults to YES. The variable parts of the `-url` value are:

**server**

The domain name or IP address of the z/OS system on which the DB2 subsystem resides.

**port**

The TCP/IP server port number that is assigned to the DB2 subsystem. The default is 446.

**-url**

Specifies the URL for the data source for which the profile is to be customized. A connection is established to the data source that this URL represents if the `-automaticbind` or `-onlinecheck` option is specified as YES or defaults to YES. The variable parts of the `-url` value are:

**server**

The domain name or IP address of the operating system on which the database server resides.

**port**

The TCP/IP server port number that is assigned to the database server. The default is 446.

**database**

A name for the database server for which the profile is to be customized.

If the connection is to a DB2 for z/OS server, *database* is the DB2 location name that is defined during installation. All characters in this value must be uppercase characters. You can determine the location name by executing the following SQL statement on the server:

```
SELECT CURRENT SERVER FROM SYSIBM.SYSDUMMY1;
```

If the connection is to a DB2 Database for Linux, UNIX, and Windows server, *database* is the database name that is defined during installation.

If the connection is to an IBM Cloudscape server, the *database* is the fully-qualified name of the file that contains the database. This name must be enclosed in double quotation marks ("). For example:

```
"c:/databases/testdb"
```

```
property=value;
```

A property for the JDBC connection.

```
property=value;
```

A property for the JDBC connection.

**-datasource** *JNDI-name*

Specifies the logical name of a DataSource object that was registered with JNDI. The DataSource object represents the data source for which the profile is to be customized. A connection is established to the data source if the `-automaticbind` or `-onlinecheck` option is specified as YES or defaults to YES. Specifying `-datasource` is an alternative to specifying `-url`. The DataSource object must represent a connection that uses IBM Data Server Driver for JDBC and SQLJ type 4 connectivity.

**-user** *user-ID*

Specifies the user ID to be used to connect to the data source for online checking or binding a package. You must specify `-user` if you specify `-url`. You must specify `-user` if you specify `-datasource`, and the DataSource object that *JNDI-name* represents does not contain a user ID.

**-password** *password*

Specifies the password to be used to connect to the data source for online checking or binding a package. You must specify `-password` if you specify `-url`. You must specify `-password` if you specify `-datasource`, and the DataSource object that *JNDI-name* represents does not contain a password.

**-automaticbind** YES|NO

Specifies whether the customizer binds DB2 packages at the data source that is specified by the `-url` parameter.

The default is YES.

The number of packages and the isolation levels of those packages are controlled by the `-rootpkgname` and `-singlepkgname` options.

Before the bind operation can work, the following conditions need to be met:

- TCP/IP and DRDA must be installed at the target data source.
- Valid `-url`, `-username`, and `-password` values must be specified.
- The `-username` value must have authorization to bind a package at the target data source.

**-pkgversion** AUTO|*version-id*

Specifies the package version that is to be used when packages are bound at the server for the serialized profile that is being customized. `db2sqljcustomize` stores the version ID in the serialized profile and in the DB2 package. Run-time version verification is based on the consistency token, not the version name. To automatically generate a version name that is based on the consistency token, specify `-pkgversion AUTO`.

The default is that there is no version.

**-bindoptions** *options-string*

Specifies a list of options, separated by spaces. These options have the same function as DB2 precompile and bind options with the same names. If you are preparing your program to run on a DB2 for z/OS system, specify DB2 for z/OS options. If you are preparing your program to run on a DB2 Database for Linux, UNIX, and Windows system, specify DB2 Database for Linux, UNIX, and Windows options.

**Notes on bind options:**

- Specify ISOLATION only if you also specify the `-singlepkgname` option.
- The value for STATICREADONLY is YES for servers that support STATICREADONLY, and NO for other servers. When you specify STATICREADONLY YES, DB2 processes ambiguous cursors as if they were read-only cursors. For troubleshooting iterator declaration errors, you need to explicitly specify STATICREADONLY NO, or declare iterators so that they are unambiguous. For example, if you want an iterator to be unambiguously updatable, declare the iterator to implement `sqlj.runtime.ForUpdate`. If you want an iterator to be read-only, include the FOR READ ONLY clause in SELECT statements that use the iterator.

**Important:** Specify only those program preparation options that are appropriate for the data source at which you are binding a package. Some

values and defaults for the IBM Data Server Driver for JDBC and SQLJ are different from the values and defaults for DB2.

**-storebindoptions**

Specifies that values for the `-bindoptions` and `-staticpositioned` parameters are stored in the serialized profile. If `db2sqljbind` is invoked without the `-bindoptions` or `-staticpositioned` parameter, the values that are stored in the serialized profile are used during the bind operation. When multiple serialized profiles are specified for one invocation of `db2sqljcustomize`, the parameter values are stored in each serialized profile. The stored values are displayed in the output from the `db2sqljprint` utility.

**-collection** *collection-name*

The qualifier for the packages that `db2sqljcustomize` binds. `db2sqljcustomize` stores this value in the customized serialized profile, and it is used when the associated packages are bound. If you do not specify this parameter, `db2sqljcustomize` uses a collection ID of NULLID.

**-onlinecheck** YES|NO

Specifies whether online checking of data types in the SQLJ program is to be performed. The `-url` or `-datasource` option determines the data source that is to be used for online checking. The default is YES if the `-url` or `-datasource` parameter is specified. Otherwise, the default is NO.

**-qualifier** *qualifier-name*

Specifies the qualifier that is to be used for unqualified objects in the SQLJ program during online checking. This value is not used as the qualifier when the packages are bound.

**-rootpkgname** | **-singlepkgname**

Specifies the names for the packages that are associated with the program. If `-automaticbind` is NO, these package names are used when `db2sqljbind` runs. The meanings of the parameters are:

**-rootpkgname** *package-name-stem*

Specifies that the customizer creates four packages, one for each of the four DB2 isolation levels. The names for the four packages are:

*package-name-stem1*

For isolation level UR

*package-name-stem2*

For isolation level CS

*package-name-stem3*

For isolation level RS

*package-name-stem4*

For isolation level RR

If `-longpkgname` is not specified, *package-name-stem* must be an alphanumeric string of seven or fewer bytes.

If `-longpkgname` is specified, *package-name-stem* must be an alphanumeric string of 127 or fewer bytes.

**-singlepkgname** *package-name*

Specifies that the customizer creates one package, with the name *package-name*. If you specify this option, your program can run at only one isolation level. You specify the isolation level for the package by specifying the ISOLATION option in the `-bindoptions` options string.

If `-longpkgname` is not specified, *package-name* must be an alphanumeric string of eight or fewer bytes.

If `-longpkgname` is specified, *package-name* must be an alphanumeric string of 128 or fewer bytes.

Using the `-singlepkgname` option is not recommended.

**Recommendation:** If the target data source is DB2 for z/OS, use uppercase characters for the *package-name-stem* or *package-name* value. DB2 for z/OS systems that are defined with certain CCSID values cannot tolerate lowercase characters in package names or collection names.

If you do not specify `-rootpkgname` or `-singlepkgname`, `db2sqljcustomize` generates four package names that are based on the serialized profile name. A serialized profile name is of the following form:

*program-name\_SJProfileIDNumber.ser*

The four generated package names are of the following form:

*Bytes-from-program-nameIDNumberPkgIsolation*

Table 38 shows the parts of a generated package name and the number of bytes for each part.

The maximum length of a package name is *maxlen*. *maxlen* is 8 if `-longpkgname` is not specified. *maxlen* is 128 if `-longpkgname` is specified.

Table 38. Parts of a package name that is generated by `db2sqljcustomize`

| Package name part              | Number of bytes                                                                                    | Value                                                                                               |
|--------------------------------|----------------------------------------------------------------------------------------------------|-----------------------------------------------------------------------------------------------------|
| <i>Bytes-from-program-name</i> | $m = \min(\text{Length}(\text{program-name}), \text{maxlen} - 1 - \text{Length}(\text{IDNumber}))$ | First <i>m</i> bytes of <i>program-name</i> , in uppercase                                          |
| <i>IDNumber</i>                | $\text{Length}(\text{IDNumber})$                                                                   | <i>IDNumber</i>                                                                                     |
| <i>PkgIsolation</i>            | 1                                                                                                  | 1, 2, 3, or 4. This value represents the transaction isolation level for the package. See Table 39. |

Table 39 shows the values of the *PkgIsolation* portion of a package name that is generated by `db2sqljcustomize`.

Table 39. *PkgIsolation* values and associated isolation levels

| <i>PkgNumber</i> value | Isolation level for package |
|------------------------|-----------------------------|
| 1                      | Uncommitted read (UR)       |
| 2                      | Cursor stability (CS)       |
| 3                      | Read stability (RS)         |
| 4                      | Repeatable read (RR)        |

*Example:* Suppose that a profile name is `ThisIsMyProg_SJProfile111.ser`. The `db2sqljcustomize` option `-longpkgname` is not specified. Therefore, *Bytes-from-program-name* is the first four bytes of `ThisIsMyProg`, translated to uppercase, or `THIS`. *IDNumber* is 111. The four package names are:

```
THIS1111
THIS1112
THIS1113
THIS1114
```

*Example:* Suppose that a profile name is ThisIsMyProg\_SJProfile111.ser. The db2sqljcustomize option -longpkgname is specified. Therefore, *Bytes-from-program-name* is ThisIsMyProg, translated to uppercase, or THISISMYPROG. *IDNumber* is 111. The four package names are:

```
THISISMYPROG1111
THISISMYPROG1112
THISISMYPROG1113
THISISMYPROG1114
```

*Example:* Suppose that a profile name is A\_SJProfile0.ser. *Bytes-from-program-name* is A. *IDNumber* is 0. Therefore, the four package names are:

```
A01
A02
A03
A04
```

Letting db2sqljcustomize generate package names is not recommended. If any generated package names are the same as the names of existing packages, db2sqljcustomize overwrites the existing packages. To ensure uniqueness of package names, specify -rootpkgname.

#### **-longpkgname**

Specifies that the names of the DB2 packages that db2sqljcustomize generates can be up to 128 bytes. Use this option only if you are binding packages at a server that supports long package names. If you specify -singlepkgname or -rootpkgname, you must also specify -longpkgname under the following conditions:

- The argument of -singlepkgname is longer than eight bytes.
- The argument of -rootpkgname is longer than seven bytes.

#### **-staticpositioned NO|YES**

For iterators that are declared in the same source file as positioned UPDATE statements that use the iterators, specifies whether the positioned UPDATES are executed as statically bound statements. The default is NO. NO means that the positioned UPDATES are executed as dynamically prepared statements.

#### **-zosDescProcParms**

Specifies that DB2 for z/OS performs a DESCRIBE operation on stored procedure parameters.

-zosDescProcParms applies to programs that are to be run on DB2 for z/OS database servers only.

If DESCRIBE information is available, SQLJ has information about the length and precision of INOUT and OUT parameters, so it allocates only the amount of memory that is needed for those parameters. Availability of DESCRIBE information can have the biggest impact on storage usage for character INOUT parameters, LOB OUT parameters, and decimal OUT parameters.

When -zosDescProcParms is specified, the DB2 database server uses the specified or default value of -zosProcedurePath to resolve unqualified names of stored procedures for which DESCRIBE information is requested.

#### **-zosProcedurePath** *procedure-path*

Specifies a list of schema names that DB2 for z/OS uses to resolve unqualified stored procedure names during online checking of an SQLJ program.

-zosProcedurePath applies to programs that are to be run on DB2 for z/OS database servers only.

The list is a String value that is a comma-separated list of schema names that is enclosed in double quotation marks. The DB2 database server inserts that list into the SQL path for resolution of unqualified stored procedure names. The SQL path is:

SYSIBM, SYSFUN, SYSPROC, *procedure-path*, *qualifier-name*, *user-ID*

*qualifier-name* is the value of the *-qualifier* parameter, and *user-ID* is the value of the *-user* parameter.

The DB2 database server tries the schema names in the SQL path from left to right until it finds a match with the name of a stored procedure that exists on that database server. If the DB2 database server finds a match, it obtains the information about the parameters for that stored procedure from the DB2 catalog. If the DB2 database server does not find a match, SQLJ sets the parameter data without any DB2 catalog information.

If *-zosProcedurePath* is not specified, the DB2 database server uses this SQL path:

SYSIBM, SYSFUN, SYSPROC, *qualifier-name*, *user-ID*

If the *-qualifier* parameter is not specified, the SQL path does not include *qualifier-name*.

#### **-genDBRM**

Specifies that *db2sqljcustomize* generates database request modules (DBRMs). Those DBRMs can be used to create DB2 for z/OS plans and packages.

*-genDBRM* applies to programs that are to be run on DB2 for z/OS database servers only.

If *-genDBRM* and *-automaticbind NO* are specified, *db2sqljcustomize* creates the DBRMs but does not bind them into DB2 packages. If *-genDBRM* and *-automaticbind YES* are specified, *db2sqljcustomize* creates the DBRMs and binds them into DB2 packages.

One DBRM is created for each DB2 isolation level. The naming convention for the generated DBRM files is the same as the naming convention for packages. For example, if *-rootpkgname SQLJSA0* is specified, and *-genDBRM* is also specified, the names of the four DBRM files are:

- SQLJSA01
- SQLJSA02
- SQLJSA03
- SQLJSA04

#### **-DBRMDir** *directory-name*

When *-genDBRM* is specified, *-DBRMDir* specifies the local directory into which *db2sqljcustomize* puts the generated DBRM files. The default is the current directory.

*-DBRMDir* applies to programs that are to be run on DB2 for z/OS database servers only.

#### **-tracefile** *file-name*

Enables tracing and identifies the output file for trace information. This option should be specified only under the direction of IBM Software Support.

#### **-tracelevel**

If *-tracefile* is specified, indicates what to trace while *db2sqljcustomize* runs. The default is *TRACE\_SQLJ*. This option should be specified only under the direction of IBM Software Support.

*serialized-profile-name* | *file-name.grp*

Specifies the names of one or more serialized profiles that are to be customized. The specified serialized profile must be in a directory that is named in the CLASSPATH environment variable.

A serialized profile name is of the following form:

*program-name\_SJProfileIDNumber.ser*

You can specify the serialized profile name with or without the .ser extension.

*program-name* is the name of the SQLJ source program, without the extension .sqlj. *n* is an integer between 0 and *m-1*, where *m* is the number of serialized profiles that the SQLJ translator generated from the SQLJ source program.

You can specify serialized profile names in one of the following ways:

- List the names in the db2sqljcustomize command. Multiple serialized profile names must be separated by spaces.
- Specify the serialized profile names, one on each line, in a file with the name *file-name.grp*, and specify *file-name.grp* in the db2sqljcustomize command.

If you specify more than one serialized profile name, and if you specify or use the default value of -automaticbind YES, db2sqljcustomize binds a single DB2 package from the profiles. When you use db2sqljcustomize to create a single DB2 package from multiple serialized profiles, you must also specify the -rootpkgname or -singlepkgname option.

If you specify more than one serialized profile name, and you specify -automaticbind NO, if you want to bind the serialized profiles into a single DB2 package when you run db2sqljbind, you need to specify the same list of serialized profile names, in the same order, in db2sqljcustomize and db2sqljbind.

## Output

When db2sqljcustomize runs, it creates a customized serialized profile. It also creates DB2 packages, if the automaticbind value is YES.

## Examples

```
db2sqljcustomize -user richler -password mordecai
 -url jdbc:db2:/server:50000/sample -collection duddy
 -bindoptions "EXPLAIN YES" pgmname_SJProfile0.ser
```

## Usage notes

**Online checking is always recommended:** It is highly recommended that you use online checking when you customize your serialized profiles. Online checking determines information about the data types and lengths of DB2 host variables, and is especially important for the following items:

- Predicates with java.lang.String host variables and CHAR columns

Unlike character variables in other host languages, Java String host variables are not declared with a length attribute. To optimize a query properly that contains character host variables, DB2 needs the length of the host variables. For example, suppose that a query has a predicate in which a String host variable is compared to a CHAR column, and an index is defined on the CHAR column. If DB2 cannot determine the length of the host variable, it might do a table space scan instead of an index scan. Online checking avoids this problem by providing the lengths of the corresponding character columns.



- Predicates with java.lang.String host variables and GRAPHIC columns  
Without online checking, DB2 might issue a bind error (SQLCODE -134) when it encounters a predicate in which a String host variable is compared to a GRAPHIC column.
- Column names in the result table of an SQLJ SELECT statement at a remote server:  
Without online checking, the driver cannot determine the column names for the result table of a remote SELECT.

**Customizing multiple serialized profiles together:** Multiple serialized profiles can be customized together to create a single DB2 package. If you do this, and if you specify `-staticpositioned YES`, any positioned UPDATE or DELETE statement that references a cursor that is declared *earlier in the package* executes statically, even if the UPDATE or DELETE statement is in a different source file from the cursor declaration. If you want `-staticpositioned YES` behavior when your program consists of multiple source files, you need to order the profiles in the `db2sqljcustomize` command to cause cursor declarations to be ahead of positioned UPDATE or DELETE statements in the package. To do that, list profiles that contain SELECT statements that assign result tables to iterators *before* profiles that contain the positioned UPDATE or DELETE statements that reference those iterators.

**Using a customized serialized profile at one data source that was customized at another data source:** You can run `db2sqljcustomize` to produce a customized serialized profile for an SQLJ program at one data source, and then use that profile at another data source. You do this by running `db2sqljbind` multiple times on customized serialized profiles that you created by running `db2sqljcustomize` once. When you run the programs at these data sources, the DB2 objects that the programs access must be identical at every data source. For example, tables at all data sources must have the same encoding schemes and the same columns with the same data types.

**Using the `-collection` parameter:** `db2sqljcustomize` stores the DB2 collection name in each customized serialized profile that it produces. When an SQLJ program is executed, the driver uses the collection name that is stored in the customized serialized profile to search for packages to execute. The name that is stored in the customized serialized profile is determined by the value of the `-collection` parameter. Only one collection ID can be stored in the serialized profile. However, you can bind the same serialized profile into multiple package collections by specifying the `COLLECTION` option in the `-bindoptions` parameter. To execute a package that is in a collection other than the collection that is specified in the serialized profile, include a `SET CURRENT PACKAGESET` statement in the program.

**Using the `VERSION` parameter:** Use the `VERSION` parameter to bind two or more versions of a package for the same SQLJ program into the same collection. You might do this if you have changed an SQLJ source program, and you want to run the old and new versions of the program.

To maintain two versions of a package, follow these steps:

1. Change the code in your source program.
2. Translate the source program to create a new serialized profile. Ensure that you do not overwrite your original serialized profile.

3. Run `db2sqljcustomize` to customize the serialized profile and create DB2 packages with the same package names and in the same collection as the original packages. Do this by using the same values for `-rootpkgname` and `-collection` when you bind the new packages that you used when you created the original packages. Specify the `VERSION` option in the `-bindoptions` parameter to put a version ID in the new customized serialized profile and in the new packages.

It is essential that you specify the `VERSION` option when you perform this step. If you do not, you overwrite your original packages.

When you run the old version of the program, DB2 loads the old versions of the packages. When you run the new version of the program, DB2 loads the new versions of the packages.

***Binding packages and plans on DB2 for z/OS:*** You can use the `db2sqljcustomize -genDBRM` parameter to create DBRMs on your local system. You can then transfer those DBRMs to a DB2 for z/OS system, and bind them into packages or plans there. If you plan to use this technique, you need to transfer the DBRM files to the z/OS system as **binary** files, to a partitioned data set with record format FB and record length 80. When you bind the packages or plans, you need to specify the following bind option values:

**ENCODING(EBCDIC)**

The IBM Data Server Driver for JDBC and SQLJ on DB2 for z/OS requires EBCDIC encoding for your packages and plans.

**DYNAMICRULES(BIND)**

This option ensures consistent authorization rules when SQLJ uses dynamic SQL. SQLJ uses dynamic SQL for positioned UPDATE or DELETE operations that involve multiple SQLJ programs.

**DBPROTOCOL(DRDA)**

Private protocol is deprecated, so you should use `DBPROTOCOL(DRDA)` for all applications. However, for SQLJ applications that use remote three-part table names, you must use `DBPROTOCOL(DRDA)`. Otherwise, those applications might fail.

---

## Chapter 255. db2sqljprint - SQLJ profile printer

db2sqljprint prints the contents of the customized version of a profile as plain text.

### Authorization

None

### Command syntax

▶▶—db2sqljprint—*profilename*—————▶▶

### Command parameters

*profilename*

Specifies the relative or absolute name of an SQLJ profile file. When an SQLJ file is translated into a Java source file, information about the SQL operations it contains is stored in SQLJ-generated resource files called profiles. Profiles are identified by the suffix \_SJProfileN (where N is an integer) following the name of the original input file. They have a .ser extension. Profile names can be specified with or without the .ser extension.

### Examples

```
db2sqljprint pgmname_SJProfile0.ser
```



---

## Chapter 256. db2start - Start DB2

Starts the current database manager instance background processes on a single database partition or on all the database partitions defined in a partitioned database environment. Start DB2 at the server before connecting to a database, precompiling an application, or binding a package to a database. db2start can be executed as a system command or a CLP command.

The db2start command launches the DB2 product installation as a Windows service. The DB2 product installation on Windows can still be run as a process by specifying the /D switch when invoking db2start. The DB2 product installation can also be started as a service using the Control Panel or the NET START command.

Since db2start launches a Windows service, you must meet Windows requirements for starting a service. If Extended Security is disabled, you must be a member of the Administrators, Server Operators or Power Users group. If Extended Security is enabled, you must be a member of either the Administrators group or the DB2ADMNS group to start the database.

If a db2start operation in a multi-partition database is not completed within the value specified by the start\_stop\_time database manager configuration parameter, the database partitions that have timed out will not have the database manager instance background processes started (all resources associated with the database partition will be removed). Environments with many database partitions with a low value for start\_stop\_timeout might experience this behavior. To resolve this behavior, increase the value of start\_stop\_time database manager configuration parameter.

For root-install DB2 copies on Linux and UNIX operating systems, the db2start command sets the ulimit value required by the database manager without changing the permanent setting of ulimit for the instance owner ID.

For non-root install, you should set the ulimit for 'data' to 'unlimited' and 'nofiles' to 'unlimited' or the maximum value allowed on the system.



---

## Chapter 257. db2stat - DB2 process status for Windows

On Windows systems, all of the DB2 processes running under an instance can be displayed using the db2stat command.

### Authorization

None

### Required connection

None

### Command syntax

►►—db2stat—◄◄

### Command parameters

#### db2stat

Outputs all of the DB2 processes running under an instance.

### Examples

```
C:\Program Files\IBM\SQLLIB\BIN>db2stat
```

```
Environment Strings
--> DB2CLP=DB20FADE
--> DB2INSTANCE=DB2
--> DB2PATH=C:\Program Files\IBM\SQLLIB
```

```
DB2 Processes
DB2DASRRM 1960 x7A8
DB2MGMTSVC 2012 x7DC
DB2RCMD 1212 x4BC
DB2DASSTM 2044 x7FC
DB2SYSTRAY 724 x2D4
DB2 3100 xC1C
DB2BP 3180 xC6C
DB2SYSCS 1592 x638
DB2FMP 3468 xD8C
DB2STAT 1748 x6D4
```

### Usage notes

One thing to note in the Windows case is that because DB2 is thread-based, not process-based, you will only see one process (DB2SYSCS) for all of an instance's EDUs. It is obvious that the same degree of information is not returned in Windows as is returned in Linux/UNIX systems, but it is still useful, at times, to know the process ID for a running instance. For example, you can use the Windows Task Manager utility to determine the CPU and memory usage for a given process ID.





---

## Chapter 258. db2stop - Stop DB2

Stops the current database manager instance. db2stop can be executed as a system command or a CLP command.

If a db2stop operation in a multi-partition database is not completed within the value specified by the start\_stop\_time database manager configuration parameter, the database partitions that have timed out will be killed internally (all resources associated with the database partition will be removed). Environments with many database partitions with a low value for start\_stop\_time might experience this behavior. To resolve this behavior, increase the value of start\_stop\_time.



---

## Chapter 259. db2support - Problem analysis and environment collection tool

Collects environment data about either a client or server machine and places the files containing system data into a compressed file archive.

This tool can also collect basic data about the nature of a problem through an interactive question and answer process with the user.

### Authorization

For the most complete output, this utility should be invoked by the instance owner. Users with more limited privileges on the system can run this tool, however some of the data collection actions will result in reduced reporting and reduced output.

### Required connection

None

### Command syntax

```
▶▶ db2support output path
 [-a] [-cd current degree]
 [-r]
 [-cl collect level] [-co] [-cs current schema]
 [-d database name] [-c] [-f]
 [-u userid] [-p password]
 [-fp function path] [-g] [-h] [-il isolation level] [-l]
 [-m] [-n] [-ol optimization level] [-op optimization profile]
 [-ot optimization tables] [-q] [-ra refresh age] [-ro] [-s]
 [-se embedded SQL file] [-sf SQL file] [-st SQL statement]
 [-td termination character delimiter] [-v] [-x]
```

### Note:

1. There is no separate option for invoking this tool in optimizer mode.

2. The db2support tool collects bad query-related information only if `-st`, `-sf`, or `-se` options are specified. In case there is an error or trap during optimization, `-cl 0` (collect level zero) should be used to collect all catalog tables and db2look table definitions without trying to explain a bad query. One of the four options mentioned here must be specified to work with optimizer problems.
3. In case special registers have been set to values other than the default during the statement execution, it is very important for correct problem analysis that the same values should be passed as parameters to the db2support tool.

## Command parameters

### *output path*

Specifies the path where the archived library is to be created. This is the directory where user created files must be placed for inclusion in the archive.

### **-a | -all\_core**

Specifies that all the core files are to be captured.

### **-r | -recent\_core**

Specifies that the most recent core files are to be captured. This option is ignored if the `-a` option is specified.

### **-c | -connect**

Specifies that an attempt be made to connect to the specified database.

### **-cd | -curdegree**

Specifies the value of the current degree special register to use. The default is the value of the **dft\_degree** database configuration parameter.

### **-cl | -collect**

Specifies the value of the level of performance information to be returned. Valid values are:

- 0 = collect only catalogs, db2look, dbcfg, dbmcfg, db2set
- 1 = collect 0 plus exfmt
- 2 = collect 1 plus .db2service (this is the default)
- 3 = collect 2 plus db2batch

**-co** Collect catalogs for all tables in the database. The default is to only collect catalog information for the tables used in a query that has a problem.

### **-cs | -curschema**

Specifies the value of the current schema to use to qualify any unqualified table names in the statement. The default value is the authorization ID of the current session user.

### **-d database\_name | -database database\_name**

Specifies the name of the database for which data is being collected.

### **-f | -flow**

Ignores pauses when requests are made for the user to Press <Enter> key to continue. This option is useful when running or calling the db2support tool via a script or some other automated procedure where unattended execution is desired.

### **-fp | -funcpath**

Specifies value of the function path special register to be used to resolve unqualified user defined functions and types. The default value is "SYSIBM", "SYSFUN", "SYSPROC", X, where X is the value of the USER special register, delimited by double quotation marks.

- g | -get\_dump**  
Specifies that all files in a dump directory, excluding core files, are to be captured.
- h | -help**  
Displays help information. When this option is specified, all other options are ignored, and only the help information is displayed.
- il | -isolation**  
Specifies the isolation level to use to determine how data is locked and isolated from other processes while the data is being accessed. By default, the CURRENT ISOLATION special register is set to blanks.
- l | -logs**  
Specifies that active logs are to be captured.
- m | -html**  
Specifies that all system output is dumped into HTML formatted files. By default, all system related information is dumped into flat text files if this parameter is not used.
- n | -number**  
Specifies the problem management report (PMR) number or identifier for the current problem.
- ol | -optlevel**  
Specifies the value of the optimization level special register to use. The default is the value of the *dft\_queryopt* database configuration parameter.
- op | -optprofile**  
Specifies value of the optimization profile special register to use. It is needed only if there was an optimization profile in effect when the statement was bound. The default is "" (an empty string).
- ot | -opttables**  
Specifies the value of the special register called "CURRENT MAINTAINED TABLE TYPES FOR OPTIMIZATION" that is used to identify the types of tables that can be considered when optimizing the processing of dynamic SQL queries. The initial value of CURRENT MAINTAINED TABLE TYPES FOR OPTIMIZATION is "SYSTEM".
- p *password* | -password *password***  
Specifies the password for the user ID.
- q | -question\_response**  
Specifies that interactive problem analysis mode is to be used.
- ra | -refreshage**  
Specifies the value of the refresh age special register. It applies only if there are materialized query tables (MQTs) that reference tables in the statement. The default value of CURRENT REFRESH AGE is zero.
- ro | -reopt**  
Specifies whether EXPLAIN with REOPT ONCE should be used when explaining the query. The default is to ignore the REOPT ONCE option.
- s | -system\_detail**  
Specifies that detailed hardware and operating system information is to be gathered.
- se *embedded SQL file* | -sqlembd *embedded SQL file***  
Specifies the path of the embedded SQL file containing the SQL statement for which data is being collected.

- sf** *SQL file* | **-sqlfile** *SQL file*  
Specifies the file path containing the SQL statement for which data is being collected.
- st** *SQL statement* | **-sqlstmt** *SQL statement*  
Specifies the SQL statement for which data is being collected.
- td** | **-delimiter**  
Specifies the statement termination character. This command parameter works in the same way as the -td option of the db2 command. The default is a semicolon.
- u** *userid* | **-user** *userid*  
Specifies the user ID to connect to the database.
- v** | **-verbose**  
Specifies that verbose output is to be used while this tool is running.
- x** | **-xml\_generate**  
Specifies that an XML document containing the entire decision tree logic used during the interactive problem analysis mode (-q mode) is to be generated.

## Examples

The db2support tool is invoked in the optimizer mode in one of the following ways:

- As an SQL statement from a command line.  

```
db2support <output_directory> -d <database name> -st <sql_statement>
```

The db2support tool stores the query in the optimizer directory by copying the query into the file called "bad\_query.sql".
- As an SQL statement stored in a file.  

```
db2support <output_directory> -d <database name> -sf <sql_file>
```

The file containing the query is copied by the tool into the optimizer directory.

- As a file containing an embedded static SQL statement with the query having the problem.  

```
db2support <output_directory> -d <database name> -se <embedded_sql_file>
```

The file containing the query is copied by the tool into the optimizer directory. The file does not need to be in the current directory but should be readable by an invoking userID.

- While returning different levels of performance information.  

```
db2support <output_directory> -d <database name> -collect 0
```

The db2support tool collects different levels of performance information based on the level of detail requested. The values 0 to 3 collect increasing amounts of detail. Catalog information and table definitions to enable you to reproduce the database objects for a production database are collected when a level of 0 is used.

To collect information to diagnose a slow query using optimizer-related special registers that were set by default, use:

```
db2support . -d sample -st "SELECT * FROM EMPLOYEE"
```

This example returns all the data to the db2support.zip file. Diagnostic files are created in the current directory and its subdirectories (since . is specified as the output path). The system information and diagnostic files are collected as well.

To collect the same information shown in the previous example but with the user-specified values for the optimizer-related special registers, use:

```
db2support . -d sample -st "SELECT * FROM EMPLOYEE" -cs db2usr -cd 3
 -ol 5 -ra ANY -fp MYSCHEMA -op MYPROFSCHEMA.MYPROFILE -ot ALL -il CS
```

This example sets the following special registers: current schema to db2usr, current degree to 3, optimization level to 5, refresh age to ANY, function path to schema MYSCHEMA, optimization profile to MYPROFSCHEMA.MYPROFILE, current maintained table types to ALL, and the isolation level to CS. These values are set only for the connection that db2support establishes to the specified database and does not affect your entire environment. Providing the same special registry variables as used when the query was run is very important when correcting diagnostics.

## Usage notes

In order to protect the security of business data, this tool does not collect table data, schema (DDL), or logs. Some of the options do allow for the inclusion of some aspects of schema and data (such as archived logs). Options that expose database schema or data should be used carefully. When this tool is invoked, a message is displayed that indicates how sensitive data is dealt with.

Data collected from the db2support tool will be from the machine where the tool runs. In a client-server environment, database-related information will be from the machine where the database resides via an instance attachment or connection to the database. For example, operating system or hardware information (-s option) and files from the diagnostic directory (DIAGPATH) will be from the local machine where the db2support tool is running. Data such as buffer pool information, database configuration, and table space information will be from the machine where the database physically resides.

There are some limitations on the type of queries accepted by the db2support optimizer tool:

- Multiple queries are not supported. If you place several queries in a file, the tool gathers all the objects necessary for each of the queries. However, only the last query is explained. This is also true for files containing embedded static SQL statements.
- The tool does not run customer applications. However, you can run the application at the same time you are running db2support provided you are using one of the three methods discussed to evaluate a particular bad or slow query.
- Stored procedures are not supported.

db2support does not collect explain data for dynamic SQL.





---

## Chapter 260. db2swtch - Switch default DB2 copy and database client interface copy

Switches both the default DB2 copy and the default database client interface copy. The default DB2 copy is the copy that is used by applications that are not targeted at a specific DB2 copy. Issuing db2swtch launches the Default DB2 and IBM Database Client Interface Selection wizard which you can follow to set a new default DB2 Copy and set the default database client interface copy. This command is only available on Windows operating systems.

### Authorization

*sysadm*

### Required connection

None

### Command syntax

```
db2swtch [-l] [-db2] [-client]
 [-d name of DB2 copy or IBM data server driver copy]
 [--IDS common]
 [--IDS SQLI]
 [-h]
 [-?]
```

### Command parameters

#### no arguments

Launches the utility in graphical mode.

**-l** Displays a list of DB2 copies and IBM data server driver copies on the system.

**-db2 -d name of DB2 copy**  
Switch the default DB2 copy to the name specified.  
*db2swtch -db2 -d name of DB2 copy*

**-client -d name of DB2 copy or IBM data server driver copy**  
Switch the default client interface copy to the name specified.  
*db2swtch -client -d name of DB2 copy or IBM data server driver copy*

**-d name of DB2 copy**  
Switches both default DB2 copy and client interface copy to the name specified.  
*db2swtch -d name of DB2 copy*

**-IDS**

**common**

Redirects the IDS .NET data provider reference in machine.config to common IDS .NET data provider.

**SQLI** Redirects the IDS .NET data provider reference in machine.config to SQLI IDS .NET data provider.

**-h | -?** Displays help information.

---

## Chapter 261. db2sync - Start DB2 synchronizer

Facilitates the initial configuration of a satellite as well as changes to the configuration. This command can also be used to start, stop and monitor the progress of a synchronization session and to upload a satellite's configuration information (for example, communications parameters) to its control server.

### Authorization

None

### Required connection

None

### Command syntax

```
▶▶ db2sync [-t] [-s application_version] [-g]
```

### Command parameters

- t Displays a graphical user interface that allows an administrator to change either the application version or synchronization credentials for a satellite.
- s *application\_version*  
Sets the application version on the satellite.
- g Displays the application version currently set on the satellite.



---

## Chapter 262. db2sysstray - Start DB2 system tray

Starts the DB2 system tray tool. It is a Windows operating system notify icon which monitors the status of a DB2 database service on Windows operating systems. db2sysstray provides a visual indication of when the service is started and stopped, as well as the ability to start and stop the service. It also provides a launch point for the DB2 Control Center.

The db2sysstray icon has two modes, started and stopped. When the monitored instance is stopped, the icon contains an overlay with a red square. When the instance is started, the red square disappears.

In partitioned database environments, the db2sysstray icon will be in started mode only when all partitions are started. If one or more partitions are stopped, the db2sysstray icon will be in stopped mode.

When multiple DB2 copies are installed on a single Windows operating system, db2sysstray can monitor DB2 instances for each DB2 copy that is installed. To monitor a non-default DB2 copy, you can execute the db2sysstray.exe application from the SQLLIB/bin of the DB2 copy you want to monitor.

You can monitor a single DB2 instance or multiple instances at the same time. Multiple instances can be monitored using multiple db2sysstray processes. A separate icon will appear in the system tray for each instance monitored by db2sysstray. Hovering over each icon with your mouse will display the name of the DB2 copy that is being monitored followed by the DB2 instance name monitored by that db2sysstray icon.

The db2sysstray icon can be launched manually from the DB2 command window by issuing the db2sysstray command, or automatically when the Windows operating system starts. db2sysstray is configured to start automatically when you install the DB2 database. However, having db2sysstray configured to start automatically when the system starts, does not mean that it will attempt to start the DB2 service as well. All it means is that it will start monitoring the status of the DB2 database automatically.

Issuing the db2idrop command against an instance monitored by a running db2sysstray process will force the db2sysstray application to clean up its registry entries and exit.

db2sysstray is only available on Windows platforms.

### **Authorization**

No special authority is required for starting db2sysstray. Appropriate authority is required for taking actions.

### **Required connection**

None

## Command syntax

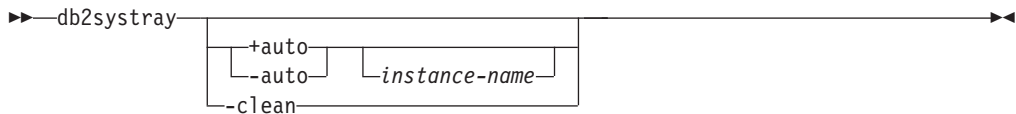

## Command parameters

**+auto** Start db2sysray automatically for the specified instance when the Windows operating system starts. db2sysray can also be configured to launch automatically by enabling the Launch Tool at Startup db2sysray menu option.

**-auto** Disable db2sysray from starting automatically for the specified instance when the Windows operating system starts.

### *instance-name*

Name of the DB2 instance to be monitored. If no instance name is specified, db2sysray will monitor the default local DB2 instance. If no instance exists, or the specified instance is not found, db2sysray will exit quietly.

**-clean** Clean up all registry entries for all DB2 instances monitored by db2sysray and stop all running db2sysray.exe processes.

## Examples

1. C:\SQLLIB\bin> db2sysray  
Starts db2sysray for the default DB2 instance specified by the DB2INSTANCE environment variable.
2. C:\SQLLIB\bin\> db2sysray DB2INST1  
Starts db2sysray for the instance named DB2INST1.
3. C:\SQLLIB\bin\> db2sysray +auto  
Starts db2sysray for the default DB2 instance, and configures db2sysray to start monitoring this instance automatically when the Windows operating system starts.
4. C:\SQLLIB\bin\> db2sysray +auto DB2INST1  
Starts db2sysray for the instance named DB2INST1, and configures db2sysray to start monitoring this instance automatically when the Windows operating system starts.
5. C:\SQLLIB\bin\> db2sysray -auto  
Disables the auto start option for the default instance defined by the DB2INSTANCE environment variable.
6. C:\SQLLIB\bin\> db2sysray -auto DB2INST1  
Disables the auto start option for instance DB2INST1.
7. C:\SQLLIB\bin\> db2sysray -clean  
Removes all registry entries created by db2sysray and stops all running db2sysray.exe processes. If db2sysray.exe processes are running for other installed DB2 copies, they will not be cleaned up. You must execute db2sysray -clean from the SQLLIB/bin for each DB2 copy you want to clean up.

## Chapter 263. db2tapemgr - Manage log files on tape

Allows the storage and retrieval of DB2 log files to and from tape. The location on tape is stored in the history file.

### Authorization

One of the following:

- *sysadm*
- *sysctrl*
- *sysmaint*

### Command syntax

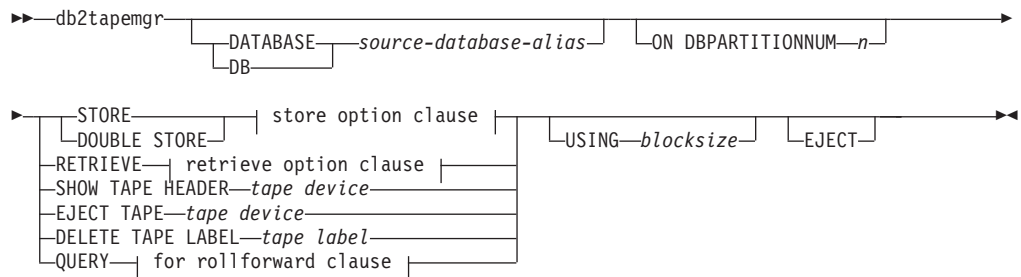

#### store option clause:

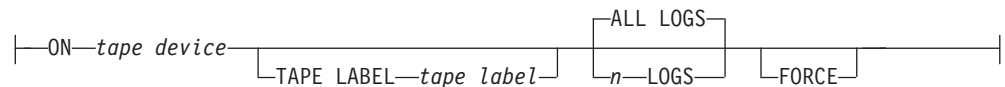

#### retrieve option clause:

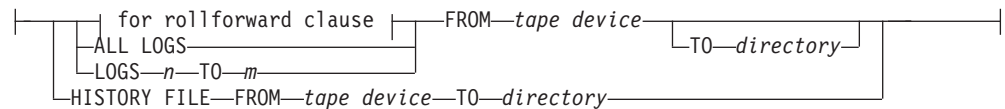

#### for rollforward clause:

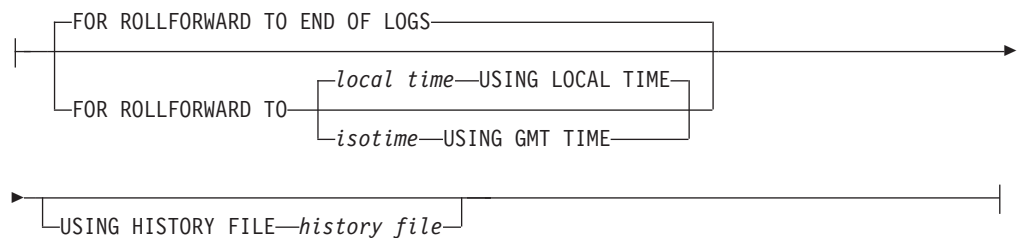

## Command parameters

### **DATABASE** *source-database-alias*

Specifies the name of the database. If no value is specified, DB2DBDFT will be used. If no value is specified, and DB2DBDFT is not set, the operation fails.

### **ON DBPARTITIONNUM**

Specifies the database partition number to work on. If no value is specified, DB2NODE is used.

### **STORE ON** *tape device*

Stores log file to tape and deletes it.

### **DOUBLE STORE ON** *tape device*

Stores all log files that have been stored only once and those log files never stored. Deletes only the log files that have been stored twice to tape; others are kept on disk.

### **TAPE LABEL**

Specifies a label to be applied to the tape. If tape label is not specified, one will be generated automatically in the following format: *database-alias | timestamp* (up to 22 characters, up to 8 characters for the database alias and 14 characters for the time stamp in seconds).

### **ALL LOGS** or *n LOGS*

Specifies that the command applies to all logs or a specified number of logs.

### **FORCE**

Specifies that if the tape has not expired, then over write it.

### **USING** *blocksize*

Specifies the block size for tape access. The default size is 5120, and it must be a multiple of 512. The minimum is 512.

**EJECT** Specifies that the tape is to be ejected after the operation completes.

### **RETRIEVE FOR ROLLFORWARD TO**

Specifies that the utility will interactively prompt for all logs that are required for the specified rollforward and retrieve them from tape. If a directory is not specified, the path specified by the **overflowlogpath** configuration parameter is used. If a directory is not specified and **overflowlogpath** is not set, the operation fails.

### **END OF LOGS**

Specifies that log files up to the end of the log will be retrieved.

### *isotime* **USING GMT TIME**

Specifies that log files up to the time specified will be retrieved.

### *local time* **USING LOCAL TIME**

Specifies that log files up to the time specified will be retrieved.

### **USING HISTORY FILE** *history file*

Specifies an alternate history file to be used.

### **FROM** *tape device*

Specifies the tape device to retrieve log files from.

### **TO** *directory*

Specifies a directory to copy retrieved log files to.



**RETRIEVE ALL LOGS or LOGS *n* TO *m***

Specifies that the command applies to all logs or a specified number of logs on a tape.

**FROM *tape device***

Specifies the tape device to retrieve log files from.

**TO *directory***

Specifies a directory to copy retrieved log files to.

**RETRIEVE HISTORY FILE**

Retrieves the history file

**FROM *tape device***

Specifies the tape device to retrieve log files from.

**TO *directory***

Specifies a directory to copy retrieved log files to.

**SHOW TAPE HEADER *tape device***

Shows the content of the tape header file DB2TAPEMGR.HEADER

**EJECT TAPE *tape device***

Ejects the tape.

**DELETE TAPE LABEL *tape label***

Deletes all locations from the history file that refer to the specified tape label.

**QUERY FOR ROLLFORWARD TO**

Displays the location of the log files that are required for rollforward.

**END OF LOGS**

*isotime* **USING GMT TIME**

Specifies that the operation should query the logs up to the time specified.

*local time* **USING LOCAL TIME**

Specifies that the operation should query the logs up to the time specified.

**USING HISTORY FILE *history file***

Specifies an alternate history file to be used.



---

## Chapter 264. db2tbst - Get table space state

Accepts a hexadecimal table space state value, and returns the state. The state value is part of the output from LIST TABLESPACES.

### Authorization

None

### Required connection

None

### Command syntax

►►—db2tbst—*tablespace-state*—————►►

### Command parameters

*tablespace-state*

A hexadecimal table space state value.

### Examples

The request db2tbst 0x0000 produces the following output:

State = Normal



---

## Chapter 265. db2tdbmgr - Migrate tools catalog database command

The db2tdbmgr command migrates specific tools catalog database objects after running the UPGRADE DATABASE command on the tools catalog database.

### Authorization

*sysadm*

### Required connection

This command establishes a database connection.

### Command syntax

```
▶▶ db2tdbmgr --d db_name --s schema_name --u user_name --p password
```

### Command parameters

- d *db\_name*  
Tools catalog database name.
- s *schema\_name*  
Tools catalog schema name.
- u *user\_name*  
User name used to connect the tools catalog database.
- p *password*  
Password used to connect the tools catalog database.

### Examples

The following example migrates the tools catalog tables, under the database alias toolsdb and schema systools:

```
db2tdbmgr -d toolsdb -s systools -u db2inst1 -p *****
```

### Usage notes

This command will only migrate tools catalog tables to a newer version, and cannot be used to convert migrated tools catalog tables to its previous version.

The database must be cataloged before migration. Most of the time, a migration error message is self explanatory, clearly stating the location of the error. If the error message complains about any of the objects such as tables or column names, then the reported objects might be corrupted or missing under the database name submitted for migration.



---

## Chapter 266. db2trc - Trace

db2trc controls the trace facility of a DB2 instance or the DB2 Administration Server (DAS). The trace facility records information about operations and formats this information into readable form. Enabling the trace facility (OFF by default) might impact your system's performance. As a result, only use the trace facility when directed by a DB2 technical support representative; otherwise, turn off the trace once enough information has been recorded.

DB2 traces can be especially useful when analyzing recurring and reproducible problems, which greatly facilitates the support representative's job of problem determination.

When using DB2, you might on occasion encounter an error message that directs you to "get a trace and call IBM Support", "turn on trace and examine the trace record", or to "contact your technical support representative with the following information: problem description, SQLCODE, SQLCA contents (if possible), and trace file (if possible)". Or, when you report a problem to IBM Support, you might be asked to perform a trace to capture detailed information about your environment.

### Authorization

To trace a DB2 instance on a UNIX operating system, you must possess one of the following authorizations:

- *sysadm*
- *sysctrl*
- *sysmaint*

To trace the DB2 Administration Server on a UNIX operating system:

- *dasadm*

On a Windows operating system, no authorization is required.

### Required connection

None

### Command syntax

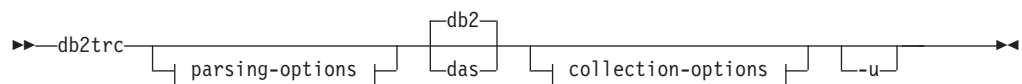

## collection-options:

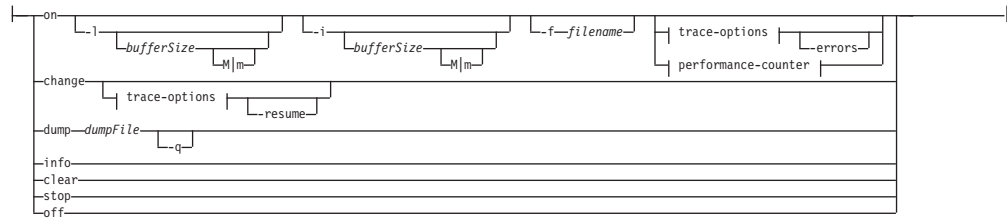

## trace-options:

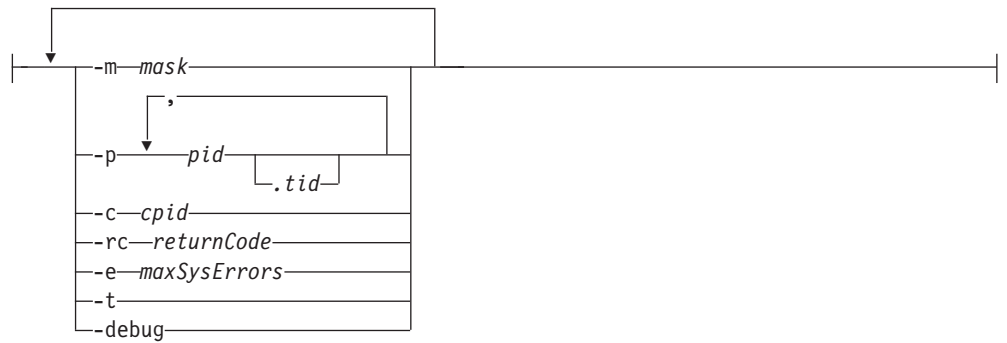

## performance-counter:

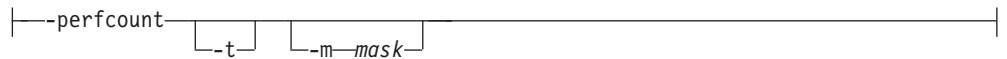

## parsing-options:

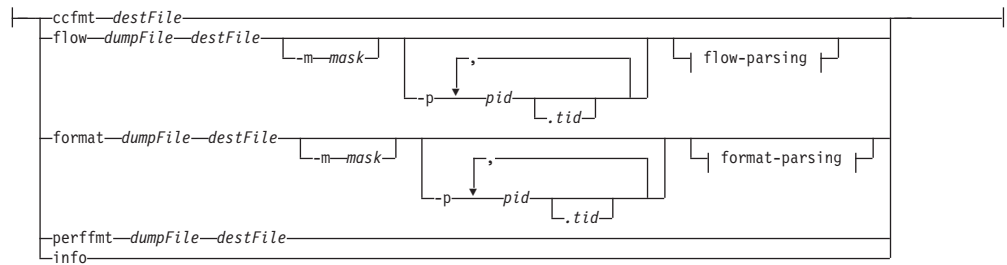

## flow-parsing:

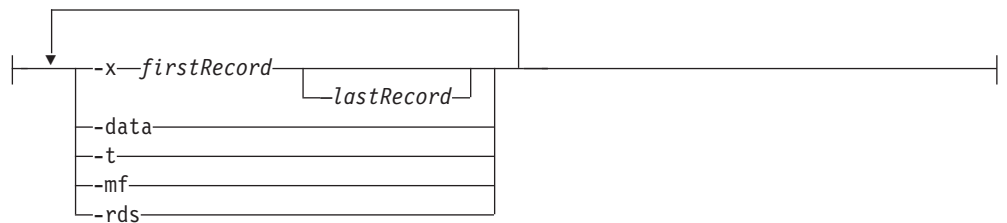



## format-parsing:

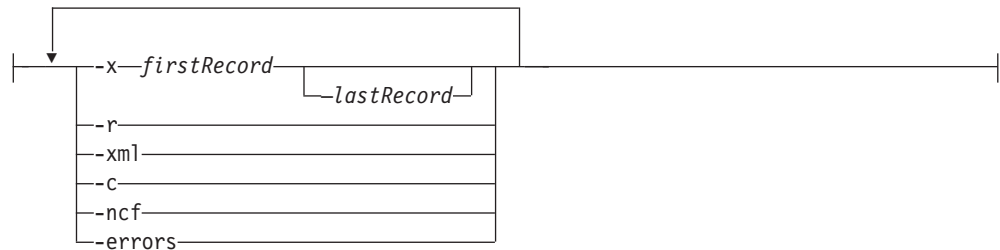

## Command parameters

**db2** Specifies that all trace operations will be performed on the DB2 instance. This is the default.

**das** Specifies that all trace operations will be performed on the DB2 Administration Server instance.

**on** Use this parameter to start the trace facility. See *Shared trace-options* section below for a list of parameters.

### **-l** [*bufferSize*]

This option specifies the size and behavior of the trace buffer. **-l** specifies that the last trace records are retained (that is, the first records are overwritten when the buffer is full). The buffer size can be specified in either bytes or megabytes. To specify the buffer size in megabytes, add the character **M** | **m** to the buffer size. For example, to start `db2trc` with a 4-megabyte buffer:

```
db2trc on -l 4m
```

The default and maximum trace buffer sizes vary by platform. The minimum buffer size is 1 MB. The buffer size must be a power of 2.

### **-i** [*bufferSize*]

This option specifies the size and behavior of the trace buffer. **-i** specifies that the initial trace records are retained (that is, no more records are written to the buffer once it is full). The buffer size can be specified in either bytes or megabytes. To specify the buffer size in megabytes, add the character **M** | **m** to the buffer size.

### **-f** *filename*

When tracing to a file, a fully-qualified file name must be specified, and if **-l** or **-i** is used with **-f** option, their *buffersize* values will limit the size of the file on disk. **-l** will preserve the last trace records and will be allowed to wrap within the file. **-i** will preserve the initial trace records and will stop tracing when the file size limit is reached. To specify the file size in megabytes, add the character **M** | **m**, and for gigabytes, add the character **G** | **g** after the value specified for **-i** and/or **-l buffersize**.

**-errors** Trace only errors and nonzero return codes on function exit. This option cannot be specified at the same time with the **-debug** or **-perfcount** options.

## change

This collection option lets you change the trace options that are in effect. See *Shared trace-options* section below for a list of parameters.

### -resume

This option lets you resume execution of a suspended process. You cannot resume if `-suspend` was not enabled.

## Shared trace-options

Common trace options shared between `on` and `change`.

### -m *mask*

Reduces the amount of data collected or formatted. The trace mask has the following format:

*types.products.components.functions.categories*

Values for the mask would be provided by IBM Support.

The mask consists of five parts (trace record types, products, components, functions, and function categories). Each part can consist of comma separated lists, hyphen separated ranges, or single entries. An asterisk (\*) can be used to match anything. Field values may be specified by their names or corresponding numbers. Short form of mask specifying names of either *products*, *components* or *functions* parts of the full format may be used. Setting the mask to `"*.*.*.*"` is equivalent to not specifying a mask.

Example: `-m *.*.SQL0,SQL0.*.entry,exit`

### -p *pid* [*.tid*]

Only enables the trace facility for the specified process IDs (*pid*) and thread IDs (*tid*). The period (.) must be included if a *tid* is specified. A maximum of five *pid.tid* combinations is supported.

For example, to enable tracing for processes 10, 20, and 30 the syntax is:

```
db2trc on -p 10,20,30
```

To enable tracing only for thread 33 of process 100 and thread 66 of process 200 the syntax is:

```
db2trc on -p 100.33,200.66
```

**-c *cpid*** Trace or format only this companion process.

### -rc *returnCode*

Treat *returnCode* as a system error. *returnCode* must be specified as a signed integer.

### -e *maxSysErrors*

Stop trace after *maxSysErrors* system errors occurred.

**-t** Include timestamps.

### -debug

This is an internal option used for debugging purposes by IBM Support. Usage is not recommended.

**info** The following is an example of environment information listed with this parameter:

```
D:\Program Files\IBM\SQLLIB\BIN>db2trc info
Marker : @TRACE@
Trace version : 7.0
Platform : NT
```

```

Build level : s060629
maxBufferSize : 2097152 bytes (2 MB)
auxBufferSize : 6291456 bytes (6 MB)
allocationCount : 1
DB2TRCD pid : 2384
DB2TRCD64 pid : 0
Trace destination : <shared memory buffer>
debug : disabled
debug runtime passno : 0
numSuspended : 0

Buffer size : 2097152 bytes (2 MB)
Allow buffer to wrap : yes
Mask : *.*.*.*.*
Timestamps : enabled
PID.TID mask : all
Fixed data mask #1 : all
Fixed data mask #2 : all
Max system errors : infinite
Treat this rc as sys err: none

```

### **dump** *dumpFile*

Dumps the binary format trace information, stored in the buffer, to a file. The following command will put the information in the current directory in a file called `db2trc.dmp`:

```
db2trc dump db2trc.dmp
```

Specify a dump file name with this parameter. The binary format dump file is saved in the current directory unless the path is explicitly specified.

**-q** Quiet mode.

### **ccfmt** *destFile*

Dump and format a code coverage trace. Specify a destination file name for the dump.

### **flow** *dumpFile destFile*

After the trace is dumped to a binary file, format it into a readable text file. Use the flow option to format records sorted by process or thread. Specify the name of the dump file and the name of the destination file that will be generated. For example:

```
db2trc flow db2trc.dmp db2trc.flw
```

**-x** *firstRecord* [**—***lastRecord*]

Only show record numbers *firstRecord* to *lastRecord*.

**-data** Include any trace record data in the flow.

**-t** Include timestamps (in sec:nsec format), if available.

**-mf** Generate a separate destination file for each distinct flow.

**-rds** Include RDS operators information, if available.

### **format** *dumpFile destFile*

After the trace is dumped to a binary file, format it into a readable text file. Use the format option to format records chronologically.

**-x** *firstRecord* [**—***lastRecord*]

Only show record numbers *firstRecord* to *lastRecord*.

**-r** Output in reverse order.

**-xml** Output data in xml parsable format.

**-c** Format communications buffers.

**-ncf** Do not use component custom formatting.

**-errors** Trace only errors and nonzero return codes on function exit.

**perffmt** *dumpFile destFile*

The performance trace formatter is a parsing option that formats a dump file containing performance counter data into readable text

**clear** Clears the contents of the trace buffer, particularly just before connecting to a specific database. This option can be used to reduce the amount of collected information by clearing the buffers of accumulated useless information before a connection to the desired database is established.

**stop** This collection option stops tracing on demand; all processes suspend tracing, but the contents of the trace buffer are preserved so that they can be dumped later. This action is in contrast to the off option, which disables the trace facility altogether.

**off** Disables the trace facility. After the trace is dumped to a file, disable the trace facility by typing:

```
db2trc off
```

**-u** Provides additional information about most of the command line options. General form of the command line entry is shown in *Usage notes* below. Here is an example to obtain more information about the dump command for the DAS instance:

```
db2trc das dump -u
```

## Usage notes

The db2trc command must be issued several times in the course of conducting a trace. With the DB2 instance stopped, the general sequence would be to first turn tracing on, which immediately begins the collection of the specified data and storage of it in the buffer after the DB2 instance is started, then to clear the buffer before connecting to the database, followed by dumping the binary format data into a dump file, then to turn tracing off, and, finally, to format the dump file into an easily readable text destination file. Here's an example of the commands executed to conduct a trace of the SAMPLE database, with the contents of the trace buffer written to file dmp:

```
db2trc on -i 8m -m "*.*.2.*.*" -t
db2start
db2trc clear
db2 connect to sample
db2trc dump dmp
db2trc off
```

The general syntax of the db2trc command is shown below. The command options can be grouped into two broad stages: collection and parsing.

- *Collection* options include turning a trace on or off; specifying the trace buffer size; specifying or changing trace options; dumping a trace; and clearing the trace buffer.
- *Parsing* options include sorting the formatted trace records chronologically, or by process, or by thread.

STAGE #1 - COLLECTION

Usage: db2trc [*facility*] <command> [-u]

[*facility*]

db2 - DB2 instance (default)

das - DB2 Administration Server instance

```
<command>
 change - Change trace options
 clear - Clear the trace buffer
 dump - Generate trace dump file
 info - Information
 off - Disable the trace facility
 on - Enable the trace facility
 stop - Stop tracing
```

#### STAGE #2 - PARSING

Usage: db2trc <command> [-u]

```
<command>
 ccfmt - Dump and format a code coverage trace
 flow - Generate control flow diagram
 format - Format
 info - Information
 perfmt - Format a performance trace
```

For more information add the "-u" option to any of the above commands

In Stage #2 - Parsing section above, the command `ccfmt` dumps and formats a "code coverage trace". The code coverage trace is an extension of `db2trc` that keeps a count of function entries, exits, probe points, and codepaths. It can be used to gather statistics on what functions are being heavily used, or which functions are not being touched during tests.

When tracing the database server, it is recommended that the trace facility be turned on prior to starting the database manager. This is the most reliable method for the database manager, running on any UNIX and Linux platform, to be immediately aware of trace changes.

To turn tracing ON and receive information specific to DB2 Text Search, a mask with component code for `cie` (155) can be used:

```
db2trc on -m "*.*.155.*.*"
```



---

## Chapter 267. db2unins - Uninstall DB2 database products, features, or languages

Uninstalls one or more DB2 database products, features, or languages. db2unins can be found both in the installation media and in a DB2 install copy on the system. If run from the installation media, only the -f, -l, -t and -? parameters can be used. If run from a DB2 install copy, all the options except -f can be used.

### Authorization

*sysadm*

### Required connection

None

### Command syntax

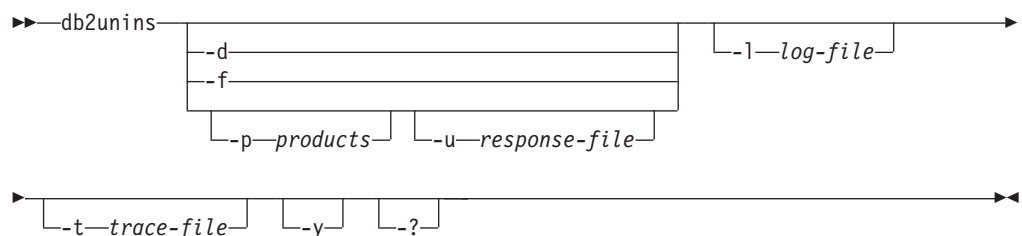

### Command parameters

Running the db2unins command without any of the -?, -d, -p or -u parameters will result in the removal of all DB2 database products under the current installation directory.

**-d** Displays the products that are installed in the current DB2 copy on the system. This option is only available when executed from an installed copy of a DB2 database product.

**-f** Performs a brute force uninstallation of all DB2 database products on the system. The db2unins -f command can only be issued from the installation media. Your system will reboot when you successfully issue db2unins -f. It can only be issued if there are no other DB2 products prior to version 9 installed on the system.

**-p** *products*

Specifies the products to be uninstalled. This parameter is only available when run from an installed DB2 copy. To uninstall multiple products, separate a list of products by a semicolon and enclosed in double quotation marks. When both parameters -p and -u are specified, the products specified in -p override the products specified in the response file. For example, db2unins -p "ESE;QP" -u db2un.rsp uninstalls both DB2 ESE and QP regardless of the REMOVE\_PROD keyword value in db2un.rsp.

**-u** *response-file*

Performs an uninstallation of products, features, or languages based on

what is specified in the response file. For example, `db2unins -u db2un.rsp`. This parameter is only available when run from an installed DB2 copy. If both parameters `-p` and `-u` are specified, the DB2 products specified in the `-p` parameter override the `REMOVE_PROD` keyword in the response file.

If you have a clustered environment, before uninstalling your DB2 product using a response file, you must first run the `db2mscs` command, with the `-u` option, from the same server that originally ran the `db2mscs` command to create the failover infrastructure. For details, see the `db2mscs` command.

**-l** *log-file*

Specifies the location of the log file. The default log file location is `My Documents\DB2LOG\db2un_<timestamp>.log`.

**-t** *trace-file*

Turns on the trace functionality. The trace file will be used for debugging problems with the `db2unins` command.

**-y** Ensures that no confirmation is done during the uninstallation process.

**-?** Displays help for the `db2unins` command.

## Usage notes

If you want to use `db2unins -f` to manually remove all the DB2 database products on the system, you should use the utility from the version which is equal to the highest DB2 product version on the system. For example, if you have 2 copies installed, `DB2COPY1` which is DB2 V9.1 and `DB2COPY2` which is DB2 V9.5, run `db2unins -f` to remove both DB2 versions from the DB2 V9.5 product image. If you run `db2unins -f` from the DB2 V9.1 product image, it will not clean the machine completely.



---

## Chapter 268. db2untag - Release container tag

Removes the DB2 tag on a table space container. The tag is used to prevent DB2 from reusing a container in more than one table space. Displays information about the container tag, identifying the database with which the container is associated. Useful when it is necessary to release a container last used by a database that has since been deleted. If the tag is left behind, DB2 is prevented from using the resource in future.

**Attention:** This tool should only be used by informed system administrators.

### Authorization

The user needs read/write access to the container for a table space that is owned by the ID that created the database.

### Required connection

None

### Command syntax

```
▶▶ db2untag -f filename ▶▶
```

### Command parameters

**-f** *filename*

Specifies the fully qualified name of the table space container from which the DB2 tag is to be removed.

### Usage notes

An SQLCODE -294 (Container in Use error) is sometimes returned from create database or from create or alter table space operations, usually indicating a specification error on the operating system resource name when the container is already in use by another table space. A container can be used by only one table space at a time.

A system or database administrator who finds that the database which last used the container has been deleted, can use the db2untag tool if the container's tag was not removed. If the container is to be released, do one of the following:

- For SMS containers, remove the directory and its contents using the appropriate delete commands.
- For DMS raw containers, either delete the file or device, or let db2untag remove the container tag. The tool will leave such a DMS container otherwise unmodified.



---

## Chapter 269. db2updserv - Show product updates

Shows the product updates and enhancements available for DB2 products. On Windows, the output from this command goes to a Web page, on UNIX, it goes to a Java application .

### Authorization

None

### Required Connection

Internet connection required.

### Command Syntax

▶▶—db2updserv—————▶▶

### Command parameters

None



---

## Chapter 270. db2val - DB2 copy validation tool command

Verifies the basic functions of a DB2 copy by checking the state of installation files, instance setup, and local database connections.

### Authorization

SYSADM

### Required Connection

None.

### Command syntax

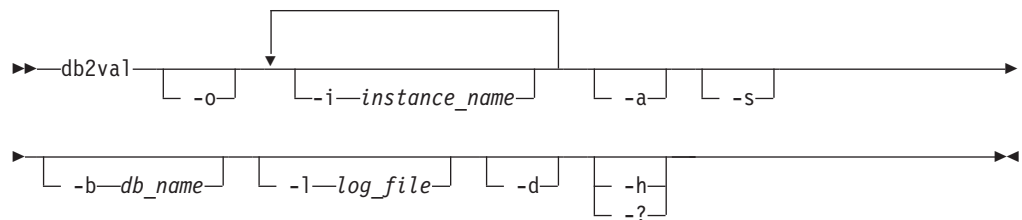

### Command parameters

- o** Specifies that only the installation files will be validated; validation of the instance, database, and extended security will not be performed. If this parameter is specified, the `-i`, `-a`, `-b`, and `-s` parameters are ignored.
- i *instance\_name***  
Specifies that the name of the instance to validate. To specify multiple instances are to be validated, specify this parameter multiple times. For example, `-i inst1 -i inst2`. On Windows operating systems, if this parameter is not specified, the current instance will be used as the default value. On Linux and UNIX operating systems, this parameter can only be used by root users in a root installation of a DB2 copy.
- a** Validates all instances in the DB2 copy. On Linux and UNIX operating systems, this parameter can only be used by root users in a root installation of a DB2 copy. This parameter overrides parameter `-i`.
- b <db\_name>**  
Validates database creation and connections to the database specified. This parameter will be ignored for DB2 client instances.
- d** Valid only on Linux and UNIX operating systems. Use this parameter only when instructed by DB2 Support. Turns the debug mode on.
- s** Starts the DB2 database manager for the specified instance that is part of a DPF environment.
- l <log\_file>**  
Writes the log to the file name specified. Unless the `-l` parameter is

specified, the default log path on Linux and UNIX operating systems is /tmp/db2valxx.log and on Windows operating systems is My Documents\DB2LOG\db2valxx.log, where xx is a generated value.

-? | -h Displays usage information for the db2val command.

## Examples

To validate the instance TEST1 and the database DATA1, run the following command:

```
db2val -i TEST1 -b DATA1
```

To validate all the instances for the DB2 copy, run the following command:

```
db2val -a
```

To validate only the DB2 installation files, run the following command:

```
db2val -o
```

---

## Chapter 271. db2xdbmig - Migrate XSR objects command

Migrates all XML schema repository (XSR) objects that are enabled for decomposition to the current version and service level of the DB2 copy where you are running the command.

This command is located in the *DB2DIR/bin* directory, where *DB2DIR* represents the installation location where the current version of the DB2 database system is installed.

### Authorization

CREATE, ALTER and DROP privileges on all of the XSR objects in the database.

### Command syntax

▶▶—db2xdbmig—*database-alias*—————▶▶

### Command parameters

*database-alias*

Specifies the alias of the database that contains the XSR objects.

### Usage notes

- The db2xdbmig command affects only decomposition-enabled XML schemas.
- When migrating to DB2 Version 9.7 from a DB2 Version 9.1 GA or Fix Pack 1 copy, the UPGRADE DATABASE command implicitly runs the db2xdbmig command. You do not need to run this command in DB2 Version 9.7.





---

## Chapter 272. db2xprt - Format trap file

Formats the DB2 database binary trap files into a human readable ASCII file. Trap files (\*.TRP) are located in the instance directory (DB2INSTPROF) by default or in the diagnostic data directory path if the **DIAGPATH** database manager configuration parameter is set. It can be found under the SQLLIB/BIN directory. The db2xprt command uses DB2 symbol files (.PDB) in order to format the trap files.

### Authorization

You must have access to the DIAGPATH directory.

### Command syntax

```
db2xprt [/p path /n] infile [outfile]
```

### Command parameters

*/p path* A semicolon (;) separated path that points to the location or locations where the binary files and PDB files are located.

*/v* Displays version information.

*/n* Formats data without regard to line number information.

*infile* Specifies the input file.

*outfile* Specifies the output file.

### Examples

If a trap file called DB30882416.TRP had been produced in your DIAGPATH, you could format it as follows:

```
db2xprt DB30882416.TRP DB30882416.FMT
```



---

## Chapter 273. `disable_MQFunctions` - Disable WebSphere MQ functions command

Disables the use of DB2 WebSphere MQ functions for the specified database.

### Authorization

One of the following:

- `sysadm`
- `dbadm`
- IMPLICIT\_SCHEMA on the database, if the implicit or explicit schema name of the function does not exist
- CREATEIN privilege on the schema, if the schema name, DB2MQ or DB2MQ1C exists

### Command syntax

```
▶▶ disable_MQFunctions --n database --u userid --p password ▶▶▶▶
```

```
▶▶▶▶
```

### Command Parameters

`-n database`

Specifies the name of the database.

`-u userid`

Specifies the user ID used to connect to the database.

`-p password`

Specifies the password for the user ID.

`-v` Optional. This is used for transactional and non-transactional user-defined function support. The values can be either `all`, `0pc`, or `1pc`. When you specify `0pc`, the disablement deletes from schema `db2mq`. If you specify `1pc`, then the disablement deletes from schema `db2mq1c`. If you specify `all`, then the disablement deletes from both schemas (`db2mq` and `db2mq1c`). If you do not specify this option, the disablement defaults to the `all` option.

### Example

In the following example, DB2MQ and DB2MQ1C functions are disabled for the database SAMPLE.

```
disable_MQFunctions -n sample -u user1 -p password1
```



---

## Chapter 274. doce\_deinstall - Uninstall DB2 Information Center

Uninstalls the DB2 Information Center that is in the same install path as the doce\_deinstall tool. This command is only available on the Linux operating systems.

The doce\_deinstall command is located at DB2DIR/install, where DB2DIR is the location where the current version of the DB2 Information Center is installed. The doce\_deinstall command is also available from the DOCE DVD. If run from the DVD, the doce\_deinstall command requires a -b option.

### Authorization

Root

### Required Connection

None

### Command syntax

```
doce_deinstall --a installpath log-file trace-file response_file h | ?
```

### Command parameters

- a** Removes the Information Center from its current location.
- b** This option is valid if the command is run from the DB2 media. It specifies the absolute path where the DB2 product was installed and will be uninstalled. The command will prompt for the path if the option is not specified.
- l *log-file*** Specifies the log file. The default log file is /tmp/doce\_deinstall.log\$\$, where \$\$ is the process ID.
- t *trace-file*** Turns on the debug mode. The debug information is written to the file name specified as *trace-file*.
- r *response\_file*** Removes the Information Center using a response file. For example, doce\_deinstall -r db2un.rsp. Cannot be combined with the -a parameter.
- h | -?** Displays usage information.

### Examples

- To uninstall DB2 Information Center that is installed in /opt/ibm/db2/doce, issue:

```
cd /opt/ibm/db2/doce
doce_deinstall -a
```

---

## Chapter 275. doce\_install - Install DB2 Information Center

Installs the DB2 Information Center. If no path is specified, the DB2 Information Center is installed by default in /opt/ibm/db2ic/V9.7. This command applies only to the Linux operating systems.

### Authorization

Root

### Required Connection

None

### Command syntax

```
doce_install [-b install-path] [-p product]
 [-c image-location] [-n] [-L language] [-l log-file]
 [-t trace-file] [-h] [-?]
 <...>
```

### Command parameters

#### **-b** *install-path*

Specifies the path where the DB2 Information Center is to be installed. *install-path* must be a full path name and its maximum length is limited to 128 characters. The default installation path is /opt/ibm/db2ic/V9.7. This parameter is mandatory when the -n parameter is specified.

#### **-p** *productID*

Specifies the *productID* of the DB2 Information Center. *productID* does not require DB2 as a prefix. This parameter is mandatory when the -n parameter is specified.

#### **-c** *image-location*

Specifies the product image location. To indicate multiple image locations, specify this parameter multiple times. For example, -c CD1 -c CD2. This parameter is only mandatory if the -n parameter is specified, your install requires more than one CD, and your images are not set up for automatic discovery. Otherwise, you are prompted for the location of the next CD at the time it is needed.

#### **-n** Specifies non-interactive mode.

#### **-L** *language*

Specifies national language support. The default is English. To install multiple languages at the same time, this parameter can be specified multiple times. For example, to install both English and German, specify -L EN -L DE.

- l** *log-file*  
Specifies the log file. The default log file is `/tmp/doce_install.log$$`, where `$$` is the process ID.
- t** *trace-file*  
Turns on the debug mode. The debug information is written to the file name specified as *trace-file*.
- h | -?** Displays usage information.

## Examples

- To install from an image in `/mnt/cdrom`, and to be prompted for all needed input, issue:

```
cd /mnt/cdrom
./doce_install
```
- To install DB2 Information Center to `/db2/v9.7`, from an image in `/mnt/cdrom`, non-interactively in English, issue:

```
cd /mnt/cdrom
./doce_install -p doce -b /db2/v9.7 -n
```



---

## Chapter 276. enable\_MQFunctions - Enable WebSphere MQ functions command

Enables DB2 WebSphere MQ functions for the specified database and validates that the DB2 WebSphere MQ functions can be executed properly. The command fails if WebSphere MQ and WebSphere MQ AMI have not been installed and configured.

### Authorization

One of the following:

- CREATE\_EXTERNAL\_ROUTINE authority on the database and at least one of the following:
  - If the schema name of the function does not refer to an existing schema, IMPLICIT\_SCHEMA authority on the database
  - If the schema name DB2MQ or DB2MQ1C exists, CREATEIN privilege on the schema
- *dbadm*

### Command syntax

```
enable_MQFunctions -n database -u userid -p password
-q queueManager -force -xml xmlSize -c clobSize
-novalidate -v all | 0pc | 1pc
```

### Command parameters

**-n** *database*

Specifies the name of the database that you want to enable.

**-u** *userid*

Specifies the user ID to connect to the database.

**-p** *password*

Specifies the password for the user ID.

**-q** *queueManager*

Optional. The queue manager name that supports the transactional MQ user-defined functions. If you do not specify a name, it is the default queue manager, DB2MQ\_DEFAULT\_MQM. If you use this option, the function assumes the use of a **-novalidate** parameter.

**-echo** Optional. Prints the detailed SQL used to create the UDFs or diagnostic information.

**-force** Optional. The use of this option allows the utility program to ignore the existing MQ UDFs. In other words, the program drops any existing

functions, before recreating any MQ UDFs. Without this option, the command will not proceed after it finds that the MQ UDFs already exist.

**-novalidate**

Optional. This specifies that there will not be any validation of the DB2 MQSeries<sup>®</sup> functions.

**-xml *xmlSize***

Optional. This is for defining the XML versions of the 0pc functions. This option has no effect if the “-v 1pc” option is specified.

The *xmlSize* specifies the length of XML data. The minimum length is 1 byte. The maximum length is 100M. The default is 1M. You can specify the length as *n* (number of bytes), *nK* (length in kilobytes), or *nM* (length in megabytes).

**-c *clobSize***

Optional. Specifies the length of CLOB data. The minimum length is 1 byte; this is the default. The maximum length is 100M. You can specify the length as *n* (number of bytes), *nK* (length in kilobytes), or *nM* (length in megabytes).

**-v**

Optional. This is used for transactional and non-transactional user-defined function support. The values can be either all, 0pc, or 1pc. When you specify 0pc, the enablement creates schema db2mq. If you specify 1pc, then the enablement creates schema db2mq1c. If you specify all, then the enablement creates all schemas under user-defined functions (db2mq and db2mq1c). If you do not specify this option, the enablement defaults to the all option.

## Examples

The following example enables the transactional and non-transactional user-defined functions. The user connects to the database SAMPLE.

```
enable_MQFunctions -n sample -u user1 -p password1
```

In the next example, the user connects to the database SAMPLE. The example creates DB2MQ1C functions with schema DB2MQ1C.

```
enable_MQFunctions -n sample -u user1 -p password1 -v 1pc
```

## Usage notes

The DB2 MQ user-defined functions run under the schemas DB2MQ or DB2MQ1C which are automatically created by this command. Before executing this command:

- Ensure that WebSphere MQ and WebSphere Application Messaging Interface (AMI) are installed, and that the version of WebSphere MQ is 5.1 or higher.
- Ensure that the environment variable \$AMT\_DATA\_PATH is defined.
- If you want to use transactional MQ UDFs, make sure that the database is configured for federated operations. Do this with the following command

```
update dbm cfg using federated yes
```

- Change the directory to the cfg subdirectory of the DB2PATH

On UNIX:

- Use db2set to add AMT\_DATA\_PATH to the DB2ENVLIST.
- Ensure that the user account associated with UDF execution is a member of the mqm group.

- Ensure that the user who will be calling this command is a member of the mqm group.

**Note:** AIX 4.2 is not supported by MQSeries 5.2.



---

## Chapter 277. installFixPack - Update installed DB2 products

Update the installed DB2 product(s) in a given location, on all UNIX and Linux platforms, to the same level as the image. If there are multi-copy DB2 products installed, the installFixPack command updates one copy at a time according to the path specified. This command can be found at the top directory in the image.

Fix pack installation will proceed when the database manager (DBM) of every instance (and in DPF, every node) related to the installation path is stopped, and all DB2 libraries are unloaded. If all the preconditions are satisfied, installFixPack will update those instances and DAS related to the installation path. An additional manual update is not required. For all UNIX and Linux platforms, the djsxlink bind command will be launched automatically when the database is reconnected or when applications are restarted.

In some cases, you may specify different force options to continue the fix pack installation, for example, when not all DBMs are stopped, or DB2 libraries remain loaded. installFixPack will continue, but you may need to manually update the instances and DAS, as well as restart the applications.

For a DPF instance, install the fix pack on all the nodes, while the instance update is only needed on the instance owning node. To keep the instance fully functional after the update, it is recommended to install all the products and features on all the nodes, at least on the instance owning node.

### Authorization

Root installations require root authority. For non-root installations, you must log on with the user ID that owns the non-root installation.

### Required Connection

None

### Command syntax

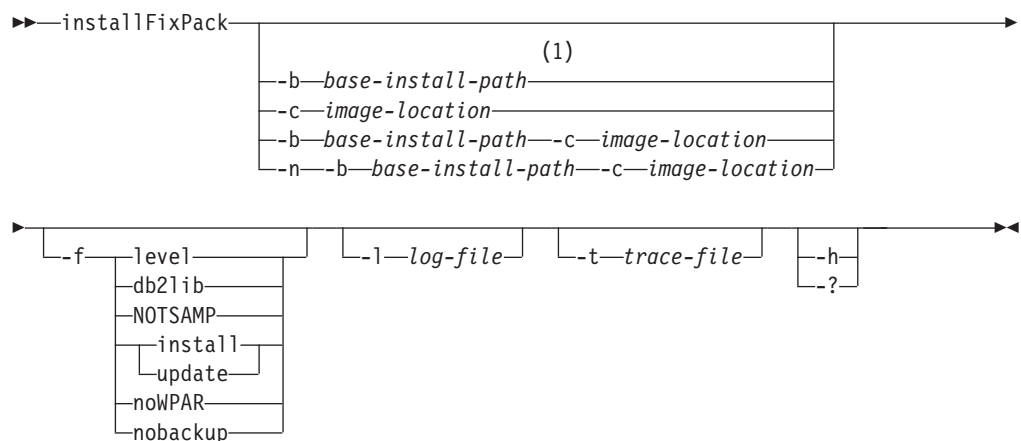

## Notes:

- 1 If you omit this option, you will be prompted for the required information without an error message halt.

## Command parameters

- n** Specifies non-interactive mode. When specified, you must also specify **-b**, and/or **-c**. This mode can be used for applications to provide all the required information at the command line in an unattended mode.
- b** *base-install-path*  
Specifies the path where the DB2 product will be installed. Mandatory when **-n** is specified. The length of the path is limited to 128 characters and is a full path name.
- The **-b** option is not required for a non-root installation of DB2, but it is still mandatory for a root installation. If **-b** is used in a non-root install, the value of *base-install-path* must be the user's HOME/sqllib directory, or else the path is considered invalid. If **-b** is not provided in a non-root install, the DB2 installer will use the user's HOME/sqllib as the install path and continue. But, if **-b** is used and the provided install path has a DB2 copy installed by a root user, the path is considered invalid since the DB2 copy can only be updated by the user who installed it.
- c** *NLPACK\_location*  
Specifies the location of the related DB2 National Language Pack (NLPACK). This parameter is mandatory when **-n** is specified. The DB2 NLPACK location needs to be provided explicitly if all of the following conditions are met:
- The **-n** option is specified.
  - The installation requires National Language (non-English) support.
  - The DB2 NLPACK is neither on the DB2 DVD nor in the same subdirectory as the DB2 product being installed.
- f** Force option. **-f** with no argument is not supported. The force arguments below can be combined. For example, **-f level -f db2lib**.
- f level**  
Force a down level or same level fix pack install. If the fix pack image is at a higher level than the installed DB2 product, this option is ignored.
- f db2lib**  
Force installFixPack to bypass the checking on DB2 library loading. To ensure that the instances or applications work properly after the installation, the DBM must be stopped for all the related instances (including all nodes for the related DPF instances), and all DB2 libraries related to the installation path must be unloaded.
- f NOTSAMP**  
Specifies that the SA MP should not be updated (applicable only to root installation).
- f install**  
Force installFixPack to bypass all the checking on DB2 library loading, instance and DAS properly stopped or not. To ensure that the instances or applications work properly after the installation, the DBM must be stopped for all the related instances (including all nodes for the related DPF instances), and all DB2 libraries related to the installation path must be unloaded. If this option is specified, instance/DAS will not be updated.

User needs to do the instance/DAS update manually after the installation. Also, note that the options update and install are mutually exclusive and cannot be specified in the same installation.

**-f update**

Force installFixPack to bypass all the checking on DB2 library loading, instance and DAS properly stopped or not. To ensure that the instances or applications work properly after the installation, the DBM must be stopped for all the related instances (including all nodes for the related DPF instances), and all DB2 libraries related to the installation path must be unloaded. If this option is specified, instance/DAS will be updated. Also, note that the options update and install are mutually exclusive and cannot be specified in the same installation.

**-f noWPAR**

Applicable to AIX 6.1 or later in a global environment. Force installFixPack not to do any checking or any actions on the AIX system workload partitions (WPARs) which share the DB2 copy being updated on the global environment. If -f noWPAR is specified, you must manually update the instances and DAS on each system WPAR that shares this DB2 copy.

**-f nobackup**

Force installFixPack to not backup installation files when the components are updated. If you choose not to backup the files, the space requirement of the installation directory is reduced. However, choosing not to backup the files also means that if any errors occur, the DB2 installer will not be able to perform a rollback operation. In this case, you will need to manually clean up the files and reinstall the fix pack.

**-l log-file**

Specifies the log file. For root installations, the default log file is /tmp/installFixPack.log\$\$, where \$\$ represents the process ID. For non-root installations, the default log file is /tmp/installFixPack\_userID.log, where userID represents the user ID that owns the non-root installation. If the IBM Tivoli System Automation for Multiplatforms (SA MP) is being installed or updated with the installFixPack command, the corresponding log file will be located in the same directory as DB2 log files.

**-t trace-file**

Turns on the debug mode. The debug information is written to the file name specified.

**-h | -?** Displays help information.

## Usage notes

- If you have DB2 Text Search installed and Text Search is running on any instances related to the DB2 copy, you will receive an error message indicating you must first stop the Text Search instance service. Stop the Text Search instance service, then rerun the command.

## Examples

- To perform an interactive update from GA to Fix Pack 1 when DB2 Enterprise Server Edition German is installed on /opt/ibm/db2/COPY1, from the Fix Pack 1 image, issue:  
./installFixPack -b /opt/ibm/db2/COPY1

- To perform a silent update from GA to Fix Pack 1 when DB2 Enterprise Server Edition German is installed on /opt/ibm/db2/COPY1, from the Fix Pack 1 image, issue:  
`./installFixPack -b /opt/ibm/db2/COPY1 -c full_path_to_NLPACK_image -n`
- If for any reason the installed DB2 product files get corrupted, instead of uninstalling and installing again to refresh the installation, issue:  
`./installFixPack -f level -b full_path_where_DB2_product_installed`
- To reduce the space requirement of the installation directory, issue:  
`./installFixPack -f nobackup -b full_path_where_DB2_product_installed`



---

## Chapter 278. setup - Install DB2

Installs DB2 products. This command is only available on Windows operating systems. The command for UNIX operating systems is db2setup.

This utility is located on the DB2 installation media. It launches the DB2 Setup wizard to define the installation and install DB2 products. If invoked with the `-u` option, it performs an installation without further input, taking installation configuration information from a response file.

When installing the IBM Data Server Runtime Client on Windows, the setup options are different from DB2 product installation. Refer to “IBM Data Server Runtime Client installation command line options (Windows)” for the appropriate options.

### Command syntax

```
setup [-c] [-f] [-i language] [-l log-file] [-m]
 [-p install-directory] [-t trace-file] [-u response-file]
 [-n DB2-copy-name] [-o] [--?] [-h]
```

### Command parameters

#### Note:

The install DB2 setup command can use the `/` or `-` switch symbols interchangeably.

- c** Ensures that the setup.exe exits immediately after starting the installation. By selecting this option, the return code of the installation is not available when monitoring the exit code of setup.exe.
- f** Forces any DB2 processes to stop before installing.
- i language**  
Specifies the two-letter language code of the language in which to perform the installation.
- l log-file**  
Full path and file name of the log file to use.
- m** Used with `-u` option to show the progress dialog during the installation. However, it will not prompt for any input.
- p install-directory**  
Changes the installation path of the product. Specifying this option overrides the installation path that is specified in the response file.
- t trace-file**  
Generates a file with install trace information.

- u** *response-file*  
Specifies the full path and file name of the response file to use.
- n** *DB2-copy-name*  
Specifies the DB2 copy name that you want the install to use. Specifying this option overrides the copy name that is specified in the response file.
- o** Always perform a new copy installation with a generated default copy name. This option is only available for installing the IBM Data Server Driver Package on Windows.
- ? | -h** Generates usage information.

---

## Chapter 279. sqlj - SQLJ translator

The sqlj command translates an SQLJ source file into a Java source file and zero or more SQLJ serialized profiles. By default, the sqlj command also compiles the Java source file.

### Authorization

None

### Command syntax

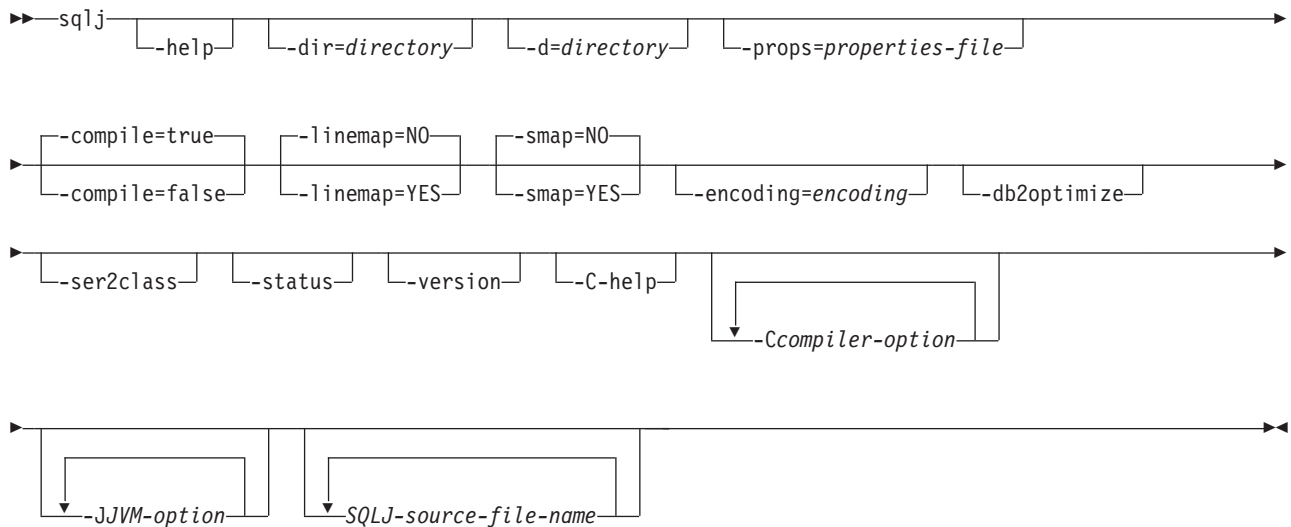

### Command parameters

#### **-help**

Specifies that the SQLJ translator describes each of the options that the translator supports. If any other options are specified with `-help`, they are ignored.

#### **-dir=directory**

Specifies the name of the directory into which SQLJ puts `.java` files that are generated by the translator and `.class` files that are generated by the compiler. The default is the directory that contains the SQLJ source files.

The translator uses the directory structure of the SQLJ source files when it puts the generated files in directories. For example, suppose that you want the translator to process two files:

- `file1.sqlj`, which is not in a Java package
- `file2.sqlj`, which is in Java package `sqlj.test`

Also suppose that you specify the parameter `-dir=/src` when you invoke the translator. The translator puts the Java source file for `file1.sqlj` in directory `/src` and puts the Java source file for `file2.sqlj` in directory `/src/sqlj/test`.

#### **-d=directory**

Specifies the name of the directory into which SQLJ puts the binary files that

are generated by the translator and compiler. These files include the .ser files, the *name\_SJProfileKeys.class* files, and the .class files that are generated by the compiler.

The default is the directory that contains the SQLJ source files.

The translator uses the directory structure of the SQLJ source files when it puts the generated files in directories. For example, suppose that you want the translator to process two files:

- file1.sqlj, which is not in a Java package
- file2.sqlj, which is in Java package sqlj.test

Also suppose that you specify the parameter `-d=/src` when you invoke the translator. The translator puts the serialized profiles for file1.sqlj in directory `/src` and puts the serialized profiles for file2.sqlj in directory `/src/sqlj/test`.

**-compile=true | false**

Specifies whether the SQLJ translator compiles the generated Java source into bytecodes.

**true**

The translator compiles the generated Java source code. This is the default.

**false**

The translator does not compile the generated Java source code.

**-linemap=no | yes**

Specifies whether line numbers in Java exceptions match line numbers in the SQLJ source file (the .sqlj file), or line numbers in the Java source file that is generated by the SQLJ translator (the .java file).

**no** Line numbers in Java exceptions match line numbers in the Java source file. This is the default.

**yes**

Line numbers in Java exceptions match line numbers in the SQLJ source file.

**-smap=no | yes**

Specifies whether the SQLJ translator generates a source map (SMAP) file for each SQLJ source file. An SMAP file is used by some Java language debug tools. This file maps lines in the SQLJ source file to lines in the Java source file that is generated by the SQLJ translator. The file is in the Unicode UTF-8 encoding scheme. Its format is described by Original Java Specification Request (JSR) 45, which is available from this web site:

<http://www.jcp.org>

**no** Do not generate SMAP files. This is the default.

**yes**

Generate SMAP files. An SMAP file name is *SQLJ-source-file-name.java.smap*. The SQLJ translator places the SMAP file in the same directory as the generated Java source file.

**-encoding=encoding-name**

Specifies the encoding of the source file. Examples are JIS or EUC. If this option is not specified, the default converter for the operating system is used.

**-db2optimize**

Specifies that the SQLJ translator generates code for a connection context class that is optimized for DB2. `-db2optimize` optimizes the code for the user-defined context but not the default context.

When you run the SQLJ translator with the `-db2optimize` option, if your applications use JDBC 3.0 or earlier functions, the IBM Data Server Driver for JDBC and SQLJ file `db2jcc.jar` must be in the CLASSPATH for compiling the generated Java application. If your applications use JDBC 4.0 or earlier functions, the IBM Data Server Driver for JDBC and SQLJ file `db2jcc4.jar` must be in the CLASSPATH for compiling the generated Java application.

**-ser2class**

Specifies that the SQLJ translator converts `.ser` files to `.class` files.

**-status**

Specifies that the SQLJ translator displays status messages as it runs.

**-version**

Specifies that the SQLJ translator displays the version of the IBM Data Server Driver for JDBC and SQLJ. The information is in this form:

IBM SQLJ *xxxx.xxxx.xx*

**-C-help**

Specifies that the SQLJ translator displays help information for the Java compiler.

**-Ccompiler-option**

Specifies a valid Java compiler option that begins with a dash (-). Do not include spaces between `-C` and the compiler option. If you need to specify multiple compiler options, precede each compiler option with `-C`. For example:

`-C-g -C-verbose`

All options are passed to the Java compiler and are not used by the SQLJ translator, **except** for the following options:

**-classpath**

Specifies the user class path that is to be used by the SQLJ translator and the Java compiler. This value overrides the CLASSPATH environment variable.

**-sourcepath**

Specifies the source code path that the SQLJ translator and the Java compiler search for class or interface definitions. The SQLJ translator searches for `.sqlj` and `.java` files only in directories, not in JAR or zip files.

**-JVM-option**

Specifies an option that is to be passed to the Java virtual machine (JVM) in which the `sqlj` command runs. The option must be a valid JVM option that begins with a dash (-). Do not include spaces between `-J` and the JVM option. If you need to specify multiple JVM options, precede each compiler option with `-J`. For example:

`-J-Xmx128m -J-Xmine2M`

**SQLJ-source-file-name**

Specifies a list of SQLJ source files to be translated. This is a required parameter. All SQLJ source file names must have the extension `.sqlj`.

## Output

For each source file, `program-name.sqlj`, the SQLJ translator produces the following files:

- The generated source program

The generated source file is named `program-name.java`.

- A serialized profile file for each connection context class that is used in an SQLJ executable clause

A serialized profile name is of the following form:

*program-name\_SJProfileIDNumber.ser*

- If the SQLJ translator invokes the Java compiler, the class files that the compiler generates.

## **Examples**

```
sqlj -encoding=UTF8 -C-0 MyApp.sqlj
```

---

## Part 6. DB2 Text Search commands







## incremental update characteristics:

```
|-----|
| UPDATE MINIMUM—minchanges |-----|
```

## connection options:

```
|-----|
| CONNECT TO—database-name |-----|
| USER—username—USING—password |-----|
```

## Command parameters

### ALTER INDEX *index-name*

The schema and name of the index as specified in the CREATE INDEX command. It uniquely identifies the text search index in a database.

### UPDATE FREQUENCY

Specifies the frequency with which index updates are made. The index will be updated, if the number of changes is at least the value set for UPDATE MINIMUM. The update frequency NONE indicates that no further index updates will be made. This can be useful for a text column in a table with data that will not change. It is also useful when the user intends to manually update the index (using the UPDATE INDEX command). Automatic updates can only be done if the START FOR TEXT command has been run and the DB2 Text Search instance services are running.

The default frequency value is taken from the view SYSIBMTS.TSDEFAULTS, where DEFAULTNAME='UPDATEFREQUENCY'.

### NONE

No automatic updates will be applied to the text index. Any further index update will have to be started manually.

**D** The day(s) of the week when the index is updated.

\* Every day of the week.

*integer1*

Specific days of the week, from Sunday to Saturday: 0 to 6

**H** The hour(s) of the specified day(s) when the index is updated.

\* Every hour of the day.

*integer2*

Specific hours of the day, from midnight to 11 pm: 0 to 23

**M** The minute(s) of the specified hour(s) when the index is updated.

*integer3*

Specified as top of the hour (0), or in multiples of 5 minute increments after the hour: 0, 5, 10, 15, 20, 25, 30, 35, 40, 45, 50 or 55

If you do not specify the UPDATE FREQUENCY option, the frequency settings are left unchanged.

### UPDATE MINIMUM *minchanges*

Specifies the minimum number of changes to text documents that must occur before the index is incrementally updated. Multiple changes to the same text

document are treated as separate changes. If you do not specify the UPDATE MINIMUM option, the setting is left unchanged.

**CONNECT TO** *database-name*

This clause specifies the database to which a connection will be established. The database must be on the local system. If specified, this clause takes precedence over the environment variable DB2DBDFT. This clause can be omitted if the following are all true:

- The DB2DBDFT environment variable is set to a valid database name.
- The user running the command has the required authorization to connect to the database server.

**USER** *username* **USING** *password*

This clause specifies the username and password that will be used to establish the connection.

## Usage notes

All limits and naming conventions, that apply to DB2 database objects and queries, also apply to DB2 Text Search features and queries. DB2 Text Search related identifiers must conform to the DB2 naming conventions. In addition, there are some additional restrictions. For example, these identifiers can only be of the form:

[A-Za-z][A-Za-z0-9@#\$\_]\*

or

"[A-Za-z ][A-Za-z0-9@#\$\_ ]\*"

Note that multiple commands cannot be executed concurrently on a text search index if they may conflict. If this command is issued while a conflicting command is running, an error will occur and the command will fail, after which you can try to run the command again. Some of the conflicting commands are:

- ALTER INDEX
- CLEAR EVENTS FOR INDEX
- DROP INDEX
- UPDATE INDEX
- DISABLE DATABASE FOR TEXT
- STOP FOR TEXT

Changes to the database: Updates the DB2 Text Search catalog information.



---

## Chapter 281. db2ts CLEANUP FOR TEXT

This command cleans up any DB2 Text Search collections within the instance that are obsolete. A collection can become obsolete if:

- A database with text search indexes is dropped before DB2 Text Search has been disabled for the database.
- A table is dropped before the text search indexes, associated with it, have been dropped.

**Note:** A text search collection refers to the underlying representation of a text search index. There is a one-to-one relationship between a text search collection and a text search index. While the commands operate on text search indexes, tools operate on text search collections. Query the SYSIBMTS.TSCOLLECTIONNAMES catalog table to determine the text search collection for a text search index. See “Administration Tool for DB2 Text Search” for additional information.

For execution, the command needs to be prefixed with db2ts at the command line.

### Authorization

To issue the command successfully, the user must be the DB2 instance owner with DBADM and DATAACCESS authority.

### Required connection

This command must be issued from the DB2 database server.

### Command syntax

▶▶—CLEANUP FOR TEXT—▶▶

### Command parameters

None



---

## Chapter 282. db2ts CLEAR COMMAND LOCKS

Removes all command locks for a specific text search index or for all text search indexes in the database. A command lock is created at the beginning of a text search index command, and is destroyed when it is done. It prevents undesirable conflict between different commands.

A cleanup is done automatically of all locks associated with processes that are no longer alive. This is done to make a text search index accessible to a new search request.

Use of this command is required in the rare case that locks remain in place due to an unexpected system behavior, and need to be cleaned up explicitly.

For execution, the command needs to be prefixed with db2ts at the command line.

### Authorization

The *username* for the database connection must have DBADM authority if an index name is not specified. For clearing a command lock on a specific index, the *username* for the database connection must have CONTROL privilege on the table for which the text search index was created.

### Prerequisite

Instance owner must hold DBADM with DATAACCESS authority. The SYSADM no longer holds SECADM nor DBADM privilege in Version 9.7. SECADM must explicitly grant DBADM with DATAACCESS authority to the instance owner before running the CLEAR COMMAND LOCKS command.

### Required connection

Database

### Command syntax

```
▶▶ CLEAR COMMAND LOCKS [FOR INDEX index-name] FOR TEXT ▶▶
▶ | connection options | ▶▶
```

### connection options:

```
| [CONNECT TO database-name] [USER username USING password] |
```

### Command parameters

**FOR INDEX** *index-name*

The name of the index as specified in the CREATE INDEX command.

**CONNECT TO** *database-name*

This clause specifies the database to which a connection will be established. The database must be on the local system. If specified, this clause takes precedence over the environment variable DB2DBDFT. This clause can be omitted if the following are all true:

- The DB2DBDFT environment variable is set to a valid database name.
- The user running the command has the required authorization to connect to the database server.

**USER** *username* **USING** *password*

This clause specifies the authorization name and password that will be used to establish the connection.

**Usage notes**

You would invoke this command because the process owning the command lock is dead. In this case, the command (represented by the lock) may not have completed, and the index may not be operational. You need to take appropriate action. For example, the process executing the DROP INDEX command dies suddenly. It has deleted some index data, but not all the catalog and collection information. The command lock is left intact. After clearing the DROP INDEX command lock, you may wish to re-execute the DROP INDEX command. In another example, the process executing the CREATE INDEX command dies suddenly. It has created some index catalog and collection information, but not all. The command lock is left intact. After clearing the CREATE INDEX command lock, you can execute the DROP INDEX and CREATE INDEX commands.

When this command is issued, the content of the DB2 Text Search view SYSIBMTS.TSLOCKS is updated.



---

## Chapter 283. db2ts CLEAR EVENTS FOR INDEX

This command deletes indexing events from an index's event table used for administration. The name of this table can be found in the view SYSIBMTS.TSINDEXES in column EVENTVIEWNAME.

Every index update operation produces informational and, in some cases, error entries in the event table. For automatic updates, this table has to be regularly inspected. Document specific errors have to be corrected (by changing the document content). After correcting the errors, the events can be cleared (and should be, in order not to consume too much space).

For execution, the command needs to be prefixed with db2ts at the command line.

### Authorization

The privileges held by the authorization ID of the statement must include at least one of the following:

- CONTROL privilege on the table on which the index is defined
- DBADM authority

### Prerequisite

Instance owner must hold DBADM with DATAACCESS authority. The SYSADM no longer holds SECADM nor DBADM privilege in Version 9.7. SECADM must explicitly grant DBADM with DATAACCESS authority to the instance owner before running the CLEAR EVENTS command.

### Required connection

Database

### Command syntax

```
►►—CLEAR EVENTS FOR INDEX—index-name—FOR TEXT—| connection options |————►►
```

#### connection options:

```
|—————|
|—CONNECT TO—database-name—|
|—USER—username—USING—password—|
```

### Command parameters

*index-name*

The name of the index as specified in the CREATE INDEX command. The index name must adhere to the naming restrictions for DB2 indexes.

CONNECT TO *database-name*

This clause specifies the database to which a connection will be established.

The database must be on the local system. If specified, this clause takes precedence over the environment variable DB2DBDFT. This clause can be omitted if the following are all true:

- The DB2DBDFT environment variable is set to a valid database name.
- The user running the command has the required authorization to connect to the database server.

**USER** *username* **USING** *password*

This clause specifies the authorization name and password that will be used to establish the connection.

## Usage notes

All limits and naming conventions, that apply to DB2 database objects and queries, also apply to DB2 Text Search features and queries. DB2 Text Search related identifiers must conform to the DB2 naming conventions. In addition, there are some additional restrictions. For example, these identifiers can only be of the form:

[A-Za-z][A-Za-z0-9@#\$\_]\*

or

"[A-Za-z ][A-Za-z0-9@#\$\_ ]\*"

When regular updates are scheduled (see UPDATE FREQUENCY options in CREATE INDEX or ALTER INDEX commands), the event table should be regularly checked. To cleanup the DB2 Text Search event table for a text search index, use CLEAR EVENTS FOR INDEX command after you have checked the reason for the event and removed the source of the error.

Be sure to make changes to all rows referenced in the event table. By changing the rows in the user table, you ensure that the next UPDATE INDEX attempt can be made to successfully re-index the once erroneous documents.

Note that multiple commands cannot be executed concurrently on a text search index if they may conflict. If this command is issued while a conflicting command is running, an error will occur and the command will fail, after which you can try to run the command again. Some of the conflicting commands are:

- CLEAR EVENTS FOR INDEX
- UPDATE INDEX
- ALTER INDEX
- DROP INDEX
- DISABLE DATABASE FOR TEXT
- STOP FOR TEXT

Changes to the database: The event table is cleared.

---

## Chapter 284. db2ts CREATE INDEX

Creates a text search index for a text column which allows the column data to be searched using text search functions.

The index will not contain any data until the text search UPDATE INDEX command is explicitly executed by the user, or implicitly issued by the text search service, according to the defined update frequency for the index.

For execution, the command needs to be prefixed with db2ts at the command line.

### Authorization

The privileges held by the authorization ID of the statement must include at least one of the following:

One of:

- CONTROL privilege on the table on which the index is defined
- INDEX privilege on the table on which the index is defined  
and one of the following:
  - IMPLICIT\_SCHEMA authority on the database, if the implicit or explicit schema name of the index does not exist
  - CREATEIN privilege on the schema, if the schema name of the index refers to an existing schema
- DBADM authority

### Prerequisite

Instance owner must hold DBADM with DATAACCESS authority. The SYSADM no longer holds SECADM nor DBADM privilege in Version 9.7. SECADM must explicitly grant DBADM with DATAACCESS authority to the instance owner before running the CREATE INDEX command.

### Required connection

Database

### Command syntax

```
▶▶ CREATE INDEX index-name FOR TEXT ON table-name
▶ | (text-column-name)
 | (function-name (text-column-name))
▶ | text default information | update characteristics |
▶ | storage options | index configuration options | connection options |▶▶
```

### text default information:

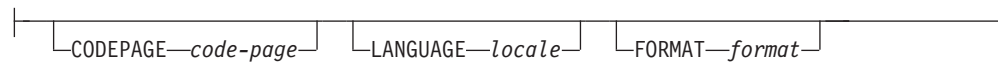

### update characteristics:

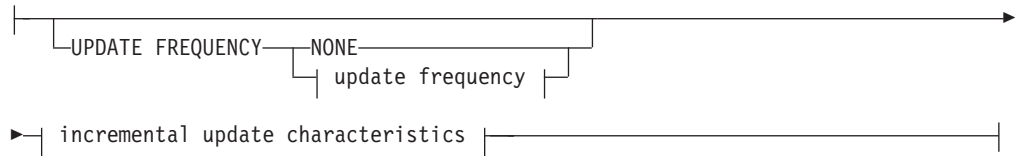

### update frequency:

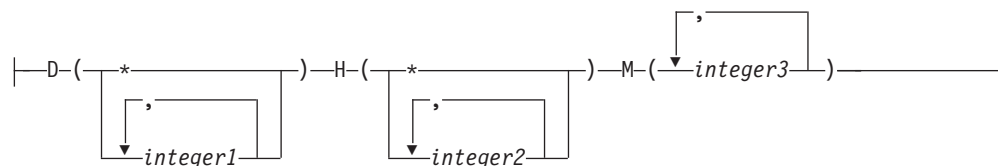

### incremental update characteristics:

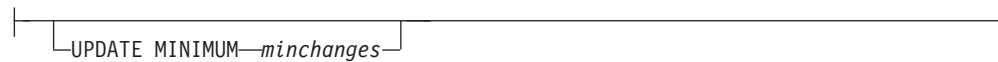

### storage options:

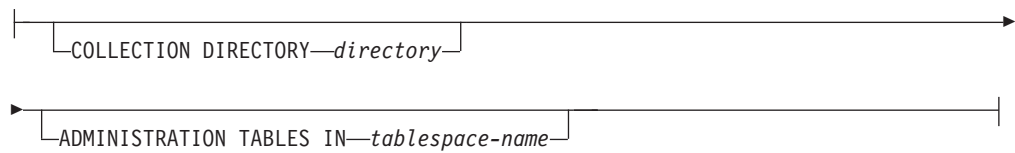

### index configuration options:

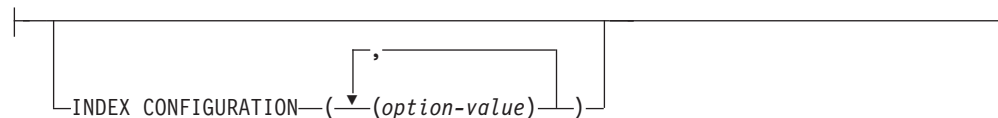

### connection options:

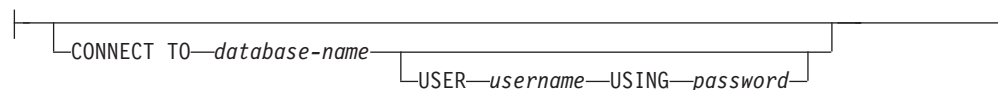

## Command parameters

### CREATE INDEX *index-name*

Specifies the name of the index (optionally schema qualified) to be created,

that will uniquely identify the text search index within the database. The index name must adhere to the naming restrictions for DB2 indexes.

**ON** *table-name*

The table name containing the text column. Text search indexes cannot be created on the following tables:

- range-partitioned tables
- federated tables
- materialized query tables
- views

*text-column-name*

The column name of the column to be indexed. The column must be of one of the following data types: CHAR, VARCHAR, LONG VARCHAR, CLOB, DBCLOB, BLOB, GRAPHIC, VARGRAPHIC, LONG VARGRAPHIC, or XML. If the data type of the column is not one of these, use a transformation function specified with *function-schema.function-name* to convert the column type to one of the valid types. Alternatively, you can specify a user-defined external function that accesses the text documents to be indexed. Only a single text search index can be created for a column.

*function-name(text-column-name)*

Specifies the schema qualified name, conforming to DB2 naming conventions, of an external scalar function that accesses text documents in a column that is not of a supported type for text searching. Performs a data type conversion of that value and returns the value as one of the supported data types for text searching. Its task is to perform a column type conversion. This function must take only one parameter and return only one value.

**CODEPAGE** *code-page*

Specifies the DB2 code page (CODEPAGE) to be used when indexing text documents. The default value is specified by the value in the view SYSIBMTS.TSDEFAULTS, where DEFAULTNAME='CODEPAGE' (which happens to be the database code page). This argument only applies to binary data types, i.e., the column type or return type from a transformation function must be BLOB or character-type FOR BIT DATA.

**LANGUAGE** *locale*

Specifies the language to be used by DB2 Text Search for language specific processing of a document during indexing. If you do not specify a locale, the database territory will be used to determine the default setting for LANGUAGE. If you would like to have your documents automatically scanned to determine the locale, specify *locale* as AUTO.

**FORMAT** *format*

Specifies the format of text documents in the column. The supported formats include: TEXT, XML, and HTML. DB2 Text Search needs this information when indexing documents. If the format is not specified, the default value is used. The default value is in the view SYSIBMTS.TSDEFAULTS, where DEFAULTNAME='FORMAT'. For columns of data type XML, the default format 'XML' is used, regardless of the value of DEFAULTNAME.

**UPDATE FREQUENCY**

Specifies the frequency with which index updates are made. The index will be updated, if the number of changes is at least the value set for UPDATE MINIMUM. The update frequency NONE indicates that no further index updates will be made. This can be useful for a text column in a table with data that will not change. It is also useful when the user intends to manually

update the index (using the UPDATE INDEX command). Automatic updates can only be done if the START FOR TEXT command has been run and the DB2 Text Search instance services are running.

The default frequency value is taken from the view SYSIBMTS.TSDEFAULTS, where DEFAULTNAME='UPDATEFREQUENCY'.

**NONE**

No further index updates are made. The update has to be started manually.

**D** The day(s) of the week when the index is updated.

\* Every day of the week.

*integer1*

Specific days of the week, from Sunday to Saturday: 0 to 6

**H** The hour(s) of the specified day(s) when the index is updated.

\* Every hour of the day.

*integer2*

Specific hours of the day, from midnight to 11 pm: 0 to 23

**M** The minute(s) of the specified hour(s) when the index is updated.

*integer3*

Specified as top of the hour (0), or in multiples of 5 minute increments after the hour: 0, 5, 10, 15, 20, 25, 30, 35, 40, 45, 50 or 55

**UPDATE MINIMUM** *minchanges*

Specifies the minimum number of changes to text documents before the index is updated incrementally at the time specified in UPDATE FREQUENCY. Positive integer values only are allowed. The default value is taken from the view SYSIBMTS.TSDEFAULTS, where DEFAULTNAME='UPDATEMINIMUM'.

**Note:** This value is ignored during an UPDATE INDEX command (unless the USING UPDATE MINIMUM option is used there). A small value increases consistency between the table column and the text search index. However, it also causes higher performance overhead.

**COLLECTION DIRECTORY** *directory*

The directory in which the text search index is stored. By default, the collection data will be located in *DBPATH/NODExxxx/SQLxxxx/db2collections/index identifier/data*. You must specify the absolute path. The maximum length of the absolute path name is 215 characters.

**ADMINISTRATION TABLES IN** *tablespace-name*

Specifies the name of an existing regular table space for the administration tables created for the index. If not specified, the table space of the base table for which the index is being created is used.

**INDEX CONFIGURATION** (*option-value*)

Specifies additional index related values as option value string pairs. These values must be enclosed in single quotes.

**Note:** A single quote character within a string value must be represented by two consecutive single quotes. The following values are supported:

Table 40. Specifications for option-value

Option	Allowed values (Default)	Meaning
COMMENT	String value shorter than 512 bytes.	Adds a string comment value to the REMARKS column in the DB2 Text Search catalog view TSINDEXES. It also adds the string comment value as the description of the collection.

**Example:**

```
INDEX CONFIGURATION (COMMENT 'Index on User''s Guide column')
```

**CONNECT TO** *database-name*

This clause specifies the database to which a connection will be established. The database must be on the local system. If specified, this clause takes precedence over the environment variable DB2DBDFT. This clause can be omitted if the following are all true:

- The DB2DBDFT environment variable is set to a valid database name.
- The user running the command has the required authorization to connect to the database server.

**USER** *username* **USING** *password*

This clause specifies the authorization name and password that will be used to establish the connection.

**Usage notes**

All limits and naming conventions, that apply to DB2 database objects and queries, also apply to DB2 Text Search features and queries. DB2 Text related identifiers must conform to the DB2 naming conventions. In addition, there are some additional restrictions. For example, these identifiers can only be of the form:

```
[A-Za-z][A-Za-z0-9@#$_]*
```

or

```
"[A-Za-z][A-Za-z0-9@#$_]*"
```

With the successful execution of the CREATE INDEX command:

- DB2 Text Search server data is updated. A collection of name *instance\_database-name\_index-identifier\_number* is created, as in the following example:

```
tigertail_MYTSDB_TS250517_0000
```

The collection name can be retrieved from the SYSIBMTS.TSCOLLECTIONNAMES view (column COLLECTIONNAME).

- DB2 Text Search catalog information is updated. An index staging table is created in the specified table space with appropriate DB2 indexes. In addition, an index event table is created in the specified table space.
- The newly created text search index is not automatically populated. The UPDATE INDEX command must be executed either manually or automatically (as a result of an update schedule having been defined for the index through the specification of the UPDATE FREQUENCY option) for the text search index to be populated.
- The Text Search index data file on the DB2 database server is updated. Scheduled update information is recorded for each index in the instance.

Usage restrictions:

- A primary key must be defined for the table. In DB2 Text Search, a multi-column DB2 primary key can be used without type limitations. The number of primary key columns is limited to 2 columns less than the number of primary key columns allowed by DB2.
- The total length of all primary key columns for a table with DB2 Text Search indexes is limited to 15 bytes less than the maximum total primary key length allowed by DB2. Refer to the restrictions of the DB2 CREATE INDEX statement.

Note that multiple commands cannot be executed concurrently on a text search index if they may conflict. If this command is issued while a conflicting command is running, an error will occur and the command will fail, after which you can try to run the command again. Some of the conflicting commands are:

- DROP INDEX
- UPDATE INDEX
- CLEAR EVENTS FOR INDEX
- ALTER INDEX
- DISABLE DATABASE FOR TEXT
- STOP FOR TEXT



---

## Chapter 285. db2ts DISABLE DATABASE FOR TEXT

This command somewhat reverses the changes (e.g., drops the text-search related tables and view) done by the command ENABLE DATABASE FOR TEXT.

When issued, this command:

- Disables the DB2 Text Search feature for the database.
- Will delete tables and views such as:
  - SYSIBMTS.TSDEFAULTS
  - SYSIBMTS.TSLOCKS
  - SYSIBMTS.TSINDEXES
  - SYSIBMTS.TSCONFIGURATION
  - SYSIBMTS.TSCOLLECTIONNAMES

The tables are removed from the default table space (IBMDEFAULTGROUP) of the database.

- If the FORCE option is specified, all text index information is removed from the database and all associated collections are deleted. In addition, the text service is updated to remove any remaining update schedule information. See the “db2ts DROP INDEX command” for reference.

For execution, the command needs to be prefixed with db2ts at the command line.

### Authorization

The privileges held by the authorization ID of the statement must include DBADM authority.

### Prerequisite

Instance owner must hold DBADM with DATAACCESS authority. The SYSADM no longer holds SECADM nor DBADM privilege in Version 9.7. SECADM must explicitly grant DBADM with DATAACCESS authority to the instance owner before running the DISABLE DATABASE command.

### Required connection

Database

### Command syntax

```
▶▶—DISABLE DATABASE FOR TEXT—FORCE—| connection options —▶▶
```

### connection options:

```
|—CONNECT TO—database-name—USER—username—USING—password—|
```

## Command parameters

### FORCE

Specifies that all text search indexes be forcibly dropped from the database.

If this option is not specified and text search indexes are defined for this database, the command will fail.

If this option is specified and DB2 Text Search service has not been started (the db2ts START FOR TEXT command has not been issued), the text search indexes (collections) are not dropped.

### CONNECT TO *database-name*

This clause specifies the database to which a connection will be established.

The database must be on the local system. If specified, this clause takes precedence over the environment variable DB2DBDFT. This clause can be omitted if the following are all true:

- The DB2DBDFT environment variable is set to a valid database name.
- The user running the command has the required authorization to connect to the database server.

### USER *username* USING *password*

This clause specifies the authorization name and password that will be used to establish the connection.

## Usage notes

This command does not influence the DB2 Net Search Extender enablement status of the database. It deletes the DB2 Text Search catalog tables and views that are created by the ENABLE FOR TEXT command.

Before dropping a DB2 database that has text search index definitions, issue this command and make sure that the text indexes and collections have been removed successfully.

If some indexes could not be deleted using the FORCE option, the collection names are written to the db2diag log file. If the text search index command DISABLE DATABASE FOR TEXT is not executed before the CLP command DROP DATABASE, the text search index services must also be cleaned up using the CLEANUP FOR TEXT command. See the DROP INDEX command for more about dropping indexes, and the CLEANUP FOR TEXT command for information about text search collections and their relationship to text search indexes.

**Note:** The user is discouraged from usage that results in orphaned collections, i.e., collections that remain defined on the text search server but are not used by DB2. Here are some cases that cause orphaned collections:

- When a DROP DATABASE CLP command or DROP TABLE statement is executed without running a DISABLE DATABASE FOR TEXT command.
- When a DISABLE DATABASE FOR TEXT command is executed using the FORCE option.
- Some other error conditions. The CLEANUP FOR TEXT command can be used in some scenarios.

Note that multiple commands cannot be executed concurrently on a text search index if they may conflict. If this command is issued while a conflicting command is running, an error will occur and the command will fail, after which you can try to run the command again. Some of the conflicting commands are:

- DROP INDEX
- UPDATE INDEX
- CLEAR EVENTS FOR INDEX
- ALTER INDEX
- DISABLE DATABASE FOR TEXT
- STOP FOR TEXT



---

## Chapter 286. db2ts DROP INDEX

Drops an existing text search index.

For execution, the command needs to be prefixed with db2ts at the command line.

### Authorization

The privileges held by the authorization ID of the statement must include at least one of the following:

- CONTROL privilege on the table on which the index is defined
- DBADM authority

### Prerequisite

Instance owner must hold DBADM with DATAACCESS authority. The SYSADM no longer holds SECADM nor DBADM privilege in Version 9.7. SECADM must explicitly grant DBADM with DATAACCESS authority to the instance owner before running the DROP INDEX command.

### Required connection

Database

### Command syntax

```
▶▶ DROP INDEX index-name FOR TEXT | connection options |▶▶
```

#### connection options:

```
|
└─CONNECT TO database-name ┌
└─USER username USING password ┘
```

### Command parameters

#### DROP INDEX *index-name*

The schema and name of the index as specified in the CREATE INDEX command. It uniquely identifies the text search index in a database.

#### CONNECT TO *database-name*

This clause specifies the database to which a connection will be established. The database must be on the local system. If specified, this clause takes precedence over the environment variable DB2DBDFT. This clause can be omitted if the following are all true:

- The DB2DBDFT environment variable is set to a valid database name.
- The user running the command has the required authorization to connect to the database server.

#### USER *username* USING *password*

This clause specifies the authorization name and password that will be used to establish the connection.

## Usage notes

Note that multiple commands cannot be executed concurrently on a text search index if they may conflict. If this command is issued while a conflicting command is running, an error will occur and the command will fail, after which you can try to run the command again. Some of the conflicting commands are:

- DROP INDEX
- UPDATE INDEX
- CLEAR EVENTS FOR INDEX
- ALTER INDEX
- DISABLE DATABASE FOR TEXT
- STOP FOR TEXT

Dropping the user table in DB2 does not trigger the dropping of text search indexes. They must be dropped manually before or after dropping the table (preferably before dropping the table). After a text search index is dropped, text search is no longer possible on the corresponding text column. If you plan to create a new text search on the same text column, you must first disconnect from the database and then reconnect before creating the new text search index.

Changes to the database:

- Update the DB2 Text Search catalog information.
- Drop the index staging/event tables.
- Delete triggers on the user text table.
- The collection associated with the DB2 Text Search index definition is destroyed.

---

## Chapter 287. db2ts ENABLE DATABASE FOR TEXT

Enables DB2 Text Search for the current database. This command must be issued successfully before it will be possible to create text search indexes on columns in tables within the database.

For execution, the command needs to be prefixed with db2ts at the command line.

### Authorization

The user must have DBADM privilege to execute the ENABLE DATABASE command.

### Prerequisite

Instance owner must hold DBADM with DATAACCESS authority. The SYSADM no longer holds SECADM nor DBADM privilege in Version 9.7. SECADM must explicitly grant DBADM with DATAACCESS authority to instance owner before running the ENABLE DATABASE command.

### Required connection

Database

### Command syntax

►►—ENABLE DATABASE FOR TEXT—| connection options |—————►

#### connection options:

|—————|  
|—CONNECT TO—*database-name*—|  
|—USER—*username*—USING—*password*—|

### Command parameters

#### CONNECT TO *database-name*

This clause specifies the database to which a connection will be established. The database must be on the local system. If specified, this clause takes precedence over the environment variable DB2DBDFT. This clause can be omitted if the following are all true:

- The DB2DBDFT environment variable is set to a valid database name.
- The user running the command has the required authorization to connect to the database server.

#### USER *username* USING *password*

This clause specifies the authorization name and password that will be used to establish the connection.

## Usage notes

When executed successfully, this command:

- Enables the DB2 Text Search feature for the database.
- Establishes DB2 Text Search database configuration default values in the view SYSIBMTS.TSDEFAULTS.
- Creates the following DB2 Text Search administrative views in the SYSIBMTS schema:
  - SYSIBMTS.TSDEFAULTS
  - SYSIBMTS.TSLOCKS
  - SYSIBMTS.TSINDEXES
  - SYSIBMTS.TSCONFIGURATION
  - SYSIBMTS.TSCOLLECTIONNAMES

The tables are created in the default table space (IBMDEFAULTGROUP) of the database.

Changes to the file system on the DB2 server: None.



---

## Chapter 288. db2ts HELP

HELP displays the list of available DB2 Text Search commands, or the syntax of an individual command.

Use the db2ts HELP command to get help on specific error messages as well.

For execution, the command needs to be prefixed with db2ts at the command line.

### Authorization

None.

### Command syntax

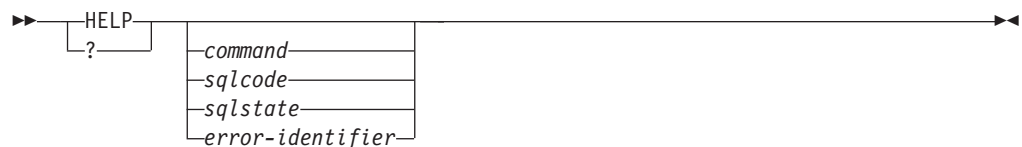

### Command parameters

**HELP | ?**

Provides help information for a command or a reason code.

*command*

The first keywords that identify a DB2 Text Search command:

- ENABLE
- DISABLE
- CREATE
- DROP
- ALTER
- UPDATE
- CLEAR (for both CLEAR COMMAND LOCKS and CLEAR EVENTS FOR INDEX)
- CLEANUP
- START
- STOP

*sqlcode* SQLCODE for message returned by db2ts command (within or outside the administration stored procedure) or text search query.

*sqlstate* Sqlstate returned by command, administration stored procedure, or text search query.

*error-identifier*

An identifier is part of the *text-search-error-msg* that is embedded in error messages. This identifier starts with 'CIE' and is of the form CIE*nnnnn* where *nnnnn* is a number. This identifier represents the specific error that is returned upon an error during text search. It may also be returned in an informational message upon completion of a text search command or in

the message printed at the completion of a text search administration procedure. If the identifier does not start with 'CIE', then db2ts help cannot provide information about the *error-identifier*. For example, db2ts cannot provide help for a message with an *error-identifier* such as IQQR0012E.

## Usage notes

When using a UNIX shell, it might be necessary to supply the arguments to db2ts using double-quotes, as in the following example:

```
db2ts "? CIE00323"
```

Without the quotes, the shell tries to match the wildcard with the contents of the working directory and it may give unexpected results.

If the first keyword of any db2ts command is specified, the syntax of the identified command is displayed. For the two db2ts commands that share the same first keyword (CLEAR COMMAND LOCKS and CLEAR EVENTS FOR INDEX), the syntax of both commands will be displayed when db2ts help clear is issued, but each command may be specifically displayed by adding the second keyword to distinguish them, for example db2ts help clear events. If a parameter is not specified after ? or HELP, db2ts lists all available db2ts commands.

Specifying a *sqlcode*, *sqlstate*, or CIE *error-identifier* will return information about that code, state, or error identifier. For example,

```
db2ts help SQL20423
```

or

```
db2ts ? 38H10
```

or

```
db2ts ? CIE00323
```

**Note:** For the following Text Search commands, the command help options listed are not valid at this time:

```
db2ts DISABLE DATABASE FOR TEXT
[SERVER]
```

```
db2ts ENABLE DATABASE FOR TEXT
[SERVER]
```

```
db2ts UPDATE INDEX
[REORGANIZE] and [PARSE ONLY]
```

---

## Chapter 289. db2ts START FOR TEXT

This command:

- Starts the DB2 Text Search instance services that support other DB2 Text Search administration commands and the ability to reference text search indexes in SQL queries.
- Starts services (daemons on UNIX) on the host machine running the DB2 database server. These services are responsible for the scheduling of text search index updates on the DB2 database server and for text search engine processing. Instance services are started under the authorization-name of the DB2 instance owner. If the instance services are already running, the command has no effect.

For execution, the command needs to be prefixed with db2ts at the command line.

### Authorization

Instance owner must hold DBADM with DATAACCESS authority for the current DB2 instance.

### Required connection

This command must be issued from the DB2 database server.

### Command syntax

▶▶—START FOR TEXT—▶▶

### Command parameters

None



---

## Chapter 290. db2ts STOP FOR TEXT

This command stops the DB2 Text Search instance services.

For execution, the command needs to be prefixed with db2ts at the command line.

### Authorization

Instance owner must hold DBADM with DATAACCESS authority for the current DB2 instance.

### Required connection

This command must be issued from the DB2 database server.

### Command syntax

»—STOP FOR TEXT—«

### Command parameters

None

### Usage notes

Note that multiple commands cannot be executed concurrently on a text search index if they may conflict. If this command is issued while a conflicting command is running, an error will occur and the command will fail, after which you can try to run the command again. To avoid interrupting the execution of currently running commands, make sure no other administrative commands like update index are still active before issuing the stop command. Some of the conflicting commands are:

- DROP INDEX
- UPDATE INDEX
- CLEAR EVENTS FOR INDEX
- ALTER INDEX
- DISABLE DATABASE FOR TEXT
- STOP FOR TEXT



---

## Chapter 291. db2ts UPDATE INDEX

This command updates the text search index (collection in DB2 Text Search) to reflect the current contents of the text column with which the index is associated. While the update is being performed, a search is possible. Until completion of the update, the search operates on a partially updated index.

For execution, the command needs to be prefixed with db2ts at the command line.

### Authorization

The privileges held by the authorization ID of the statement must include at least one of the following:

- CONTROL privilege on the table on which the text index is defined
- DATAACCESS authority

### Prerequisite

Instance owner must hold DBADM with DATAACCESS authority. The SYSADM no longer holds SECADM nor DBADM privilege in Version 9.7. SECADM must explicitly grant DBADM with DATAACCESS authority to the instance owner before running the UPDATE INDEX command.

### Required connection

Database

### Command syntax

```
►► UPDATE INDEX index-name FOR TEXT USING UPDATE MINIMUM
connection options ►►
```

#### connection options:

```
CONNECT TO database-name USER username USING password
```

### Command parameters

#### UPDATE INDEX *index-name*

Specifies the name of the text search index to be updated. The index name must adhere to the naming restrictions for DB2 indexes.

#### USING UPDATE MINIMUM

Specifies that the UPDATE MINIMUM *minchange* settings, specified in the CREATE INDEX command used to create the index, should be used, and starts an incremental update if the specified minimum number of changes have occurred. By default the update is started unconditionally.

### **CONNECT TO** *database-name*

This clause specifies the database to which a connection will be established. The database must be on the local system. If specified, this clause takes precedence over the environment variable DB2DBDFT. This clause can be omitted if the following are all true:

- The DB2DBDFT environment variable is set to a valid database name.
- The user running the command has the required authorization to connect to the database server.

### **USER** *username* **USING** *password*

This clause specifies the authorization name and password that will be used to establish the connection.

## **Usage notes**

All limits and naming conventions, that apply to DB2 database objects and queries, also apply to DB2 Text Search features and queries. DB2 Text Search related identifiers must conform to the DB2 naming conventions. In addition, there are some additional restrictions. For example, these identifiers can only be of the form:

[A-Za-z][A-Za-z0-9@#\$\_]\*

or

"[A-Za-z ][A-Za-z0-9@#\$\_ ]\*"

This command does not return until all index update processing is completed. The duration depends on the number of documents to be indexed and the number of documents already indexed. The collection name for the index can be retrieved from the SYSIBMTS.TSCOLLECTIONNAMES view (column COLLECTIONNAME).

Note that multiple commands cannot be executed concurrently on a text search index if they may conflict. If this command is issued while a conflicting command is running, an error will occur and the command will fail, after which you can try to run the command again. Some of the conflicting commands are:

- UPDATE INDEX
- CLEAR EVENTS FOR INDEX
- ALTER INDEX
- DROP INDEX
- DISABLE DATABASE FOR TEXT
- STOP FOR TEXT

**Note:** In cases of individual document errors, the documents must be corrected. The primary keys of the erroneous documents can be looked up in the event table for the index. The next UPDATE INDEX command will reprocess these documents if the corresponding rows in the user table are modified.

Changes to the database:

- Insert rows to the event table (including parser error information from DB2 Text Search).
- Delete from the index staging table in case of incremental updates.
- Before first update, create triggers on the user text table.
- The collection is updated.



- New or changed documents are parsed and indexed.
- Deleted documents are discarded from the index.



---

## Part 7. Appendixes



---

## Appendix A. Naming conventions

---

### Naming conventions

The following conventions apply when naming database manager objects, such as databases and tables:

- Character strings that represent names of database manager objects can contain any of the following: a-z, A-Z, 0-9, @, #, and \$.
- Unless otherwise noted, names can be entered in lowercase letters; however, the database manager processes them as if they were uppercase.

The exception to this convention is character strings that represent names under the systems network architecture (SNA) which, as a communications protocol, is no longer supported. Many values are case sensitive, such as logical unit names (partner\_lu and local\_lu). The name must be entered exactly as it appears in the SNA definitions that correspond to those terms.

- A database name or database alias is a unique character string containing from one to eight letters, numbers, or keyboard characters from the set described above.

Databases are cataloged in the system and local database directories by their aliases in one field, and their original name in another. For most functions, the database manager uses the name entered in the alias field of the database directories. (The exceptions are CHANGE DATABASE COMMENT and CREATE DATABASE, where a directory path must be specified.)

- The name or the alias name of a table or a view is an SQL identifier that is a unique character string 1 to 128 bytes in length. Column names can be 1 to 128 bytes in length.

A fully qualified table name consists of the *schema.tablename*. The schema is the unique user ID under which the table was created. The schema name for a declared temporary table must be SESSION.

- Local aliases for remote nodes that are to be cataloged in the node directory cannot exceed eight characters in length.
- The first character in the string must be an alphabetic character, @, #, or \$; it cannot be a number or the letter sequences SYS, DBM, or IBM.

The following conventions apply when naming user IDs and authentication IDs:

- Character strings that represent names of database manager objects can contain any of the following: a-z, A-Z, 0-9, @, #, and \$.
- User IDs and groups may also contain any of the following additional characters when supported by the security plug-in: `_`, `!`, `%`, `(`, `)`, `{`, `}`, `-`, `.`, `^`.
- User IDs and groups containing any of the following characters must be delimited with quotations when entered through the command line processor: `!`, `%`, `(`, `)`, `{`, `}`, `-`, `.`, `^`.
- The first character in the string must be an alphabetic character, @, #, or \$; it cannot be a number or the letter sequences SYS, DBM, or IBM.
- Authentication IDs cannot exceed 128 bytes in length.
- Group IDs cannot exceed 128 bytes in length.



---

## Appendix B. File type modifiers and delimiters

---

### File type modifiers for the export, import and load utilities

The links below will take you to the top of a command topic, where you'll then find a quick link to the respective file type modifier section.

Chapter 43, "EXPORT," on page 177

Chapter 65, "IMPORT," on page 263

Chapter 85, "LOAD," on page 357

---

### Delimiter considerations for moving data

When moving delimited ASCII (DEL) files, it is important to ensure that the data being moved is not unintentionally altered because of problems with delimiter character recognition. To help prevent these errors, DB2 enforces several restrictions and provides a number of file type modifiers.

#### Delimiter restrictions

There are a number of restrictions in place that help prevent the chosen delimiter character from being treated as a part of the data being moved. First, delimiters are mutually exclusive. Second, a delimiter cannot be binary zero, a line-feed character, a carriage-return, or a blank space. As well, the default decimal point (.) cannot be a string delimiter. Finally, in a DBCS environment, the pipe (|) character delimiter is not supported.

The following characters are specified differently by an ASCII-family code page and an EBCDIC-family code page:

- The Shift-In (0x0F) and the Shift-Out (0x0E) character cannot be delimiters for an EBCDIC MBCS data file.
- Delimiters for MBCS, EUC, or DBCS code pages cannot be greater than 0x40, except the default decimal point for EBCDIC MBCS data, which is 0x4b.
- Default delimiters for data files in ASCII code pages or EBCDIC MBCS code pages are:
  - string delimiter: "(0x22, double quotation mark)
  - column delimiter: ,(0x2c, comma)
- Default delimiters for data files in EBCDIC SBCS code pages are:
  - string delimiter: "(0x7F, double quotation mark)
  - column delimiter: ,(0x6B, comma)
- The default decimal point for ASCII data files is 0x2e (period).
- The default decimal point for EBCDIC data files is 0x4B (period).
- If the code page of the server is different from the code page of the client, it is recommended that the hex representation of non-default delimiters be specified. For example,

```
db2 load from ... modified by charde10x0C colde1X1e ...
```

## Issues with delimiters during data movement

### Double character delimiters

By default, for character-based fields of a DEL file, any instance of the character delimiter found within the field is represented by double character delimiters. For example, assuming that the character delimiter is the double quote, if you export the text I am 6" tall., the output text in the DEL file reads "I am 6"" tall." Conversely, if the input text in a DEL file reads "What a ""nice"" day!", the text is imported as What a "nice" day!

### **nodoubledel**

Double character delimiter behavior can be disabled for the import, export, and load utilities by specifying the `nodoubledel` file type modifier. However, be aware that double character delimiter behavior exists in order to avoid parsing errors. When you use `nodoubledel` with export, the character delimiter is not doubled if it is present in character fields. When you use `nodoubledel` with import and load, the double character delimiter is not interpreted as a literal instance of the character delimiter.

### **nochar-del**

When you use the `nochar-del` file type modifier with export, the character fields are not surrounded by character delimiters. When `nochar-del` is used import and load, the character delimiters are not treated as special characters and are interpreted as actual data.

### **char-del**

Other file type modifiers can be used to manually prevent confusion between default delimiters and the data. The `char-del` file type modifier specifies `x`, a single character, as the character string delimiter to be used instead of double quotation marks (as is the default).

### **col-del**

Similarly, if you wanted to avoid using the default comma as a column delimiter, you could use `col-del`, which specifies `x`, a single character, as the column data delimiter.

### **del-priority-char**

Another concern in regards to moving DEL files is maintaining the correct precedence order for delimiters. The default priority for delimiters is: row, character, column. However, some applications depend on the priority: character, row, column. For example, using the default priority, the DEL data file:

```
"Vincent <row delimiter> is a manager",<row delimiter>
```

would be interpreted as having two rows: Vincent, and is a manager, since `<row delimiter>` takes precedence over the character delimiter (`"`). Using `del-priority-char` gives the character delimiter (`"`) precedence over the row delimiter (`<row delimiter>`), meaning that the same DEL file would be interpreted (correctly) as having one row: Vincent is a manager.



---

## Appendix C. Overview of the DB2 technical information

DB2 technical information is available through the following tools and methods:

- DB2 Information Center
  - Topics (Task, concept and reference topics)
  - Help for DB2 tools
  - Sample programs
  - Tutorials
- DB2 books
  - PDF files (downloadable)
  - PDF files (from the DB2 PDF DVD)
  - printed books
- Command line help
  - Command help
  - Message help

**Note:** The DB2 Information Center topics are updated more frequently than either the PDF or the hardcopy books. To get the most current information, install the documentation updates as they become available, or refer to the DB2 Information Center at [ibm.com](http://ibm.com).

You can access additional DB2 technical information such as technotes, white papers, and IBM Redbooks® publications online at [ibm.com](http://ibm.com). Access the DB2 Information Management software library site at <http://www.ibm.com/software/data/sw-library/>.

### Documentation feedback

We value your feedback on the DB2 documentation. If you have suggestions for how to improve the DB2 documentation, send an e-mail to [db2docs@ca.ibm.com](mailto:db2docs@ca.ibm.com). The DB2 documentation team reads all of your feedback, but cannot respond to you directly. Provide specific examples wherever possible so that we can better understand your concerns. If you are providing feedback on a specific topic or help file, include the topic title and URL.

Do not use this e-mail address to contact DB2 Customer Support. If you have a DB2 technical issue that the documentation does not resolve, contact your local IBM service center for assistance.

---

## DB2 technical library in hardcopy or PDF format

The following tables describe the DB2 library available from the IBM Publications Center at [www.ibm.com/shop/publications/order](http://www.ibm.com/shop/publications/order). English and translated DB2 Version 9.7 manuals in PDF format can be downloaded from [www.ibm.com/support/docview.wss?rs=71&uid=swg2700947](http://www.ibm.com/support/docview.wss?rs=71&uid=swg2700947).

Although the tables identify books available in print, the books might not be available in your country or region.

The form number increases each time a manual is updated. Ensure that you are reading the most recent version of the manuals, as listed below.

**Note:** The *DB2 Information Center* is updated more frequently than either the PDF or the hard-copy books.

*Table 41. DB2 technical information*

<b>Name</b>	<b>Form Number</b>	<b>Available in print</b>	<b>Last updated</b>
<i>Administrative API Reference</i>	SC27-2435-00	Yes	August, 2009
<i>Administrative Routines and Views</i>	SC27-2436-00	No	August, 2009
<i>Call Level Interface Guide and Reference, Volume 1</i>	SC27-2437-00	Yes	August, 2009
<i>Call Level Interface Guide and Reference, Volume 2</i>	SC27-2438-00	Yes	August, 2009
<i>Command Reference</i>	SC27-2439-00	Yes	August, 2009
<i>Data Movement Utilities Guide and Reference</i>	SC27-2440-00	Yes	August, 2009
<i>Data Recovery and High Availability Guide and Reference</i>	SC27-2441-00	Yes	August, 2009
<i>Database Administration Concepts and Configuration Reference</i>	SC27-2442-00	Yes	August, 2009
<i>Database Monitoring Guide and Reference</i>	SC27-2458-00	Yes	August, 2009
<i>Database Security Guide</i>	SC27-2443-00	Yes	August, 2009
<i>DB2 Text Search Guide</i>	SC27-2459-00	Yes	August, 2009
<i>Developing ADO.NET and OLE DB Applications</i>	SC27-2444-00	Yes	August, 2009
<i>Developing Embedded SQL Applications</i>	SC27-2445-00	Yes	August, 2009
<i>Developing Java Applications</i>	SC27-2446-00	Yes	August, 2009
<i>Developing Perl, PHP, Python, and Ruby on Rails Applications</i>	SC27-2447-00	No	August, 2009
<i>Developing User-defined Routines (SQL and External)</i>	SC27-2448-00	Yes	August, 2009
<i>Getting Started with Database Application Development</i>	GI11-9410-00	Yes	August, 2009
<i>Getting Started with DB2 Installation and Administration on Linux and Windows</i>	GI11-9411-00	Yes	August, 2009

*Table 41. DB2 technical information (continued)*

<b>Name</b>	<b>Form Number</b>	<b>Available in print</b>	<b>Last updated</b>
<i>Globalization Guide</i>	SC27-2449-00	Yes	August, 2009
<i>Installing DB2 Servers</i>	GC27-2455-00	Yes	August, 2009
<i>Installing IBM Data Server Clients</i>	GC27-2454-00	No	August, 2009
<i>Message Reference Volume 1</i>	SC27-2450-00	No	August, 2009
<i>Message Reference Volume 2</i>	SC27-2451-00	No	August, 2009
<i>Net Search Extender Administration and User's Guide</i>	SC27-2469-00	No	August, 2009
<i>Partitioning and Clustering Guide</i>	SC27-2453-00	Yes	August, 2009
<i>pureXML Guide</i>	SC27-2465-00	Yes	August, 2009
<i>Query Patroller Administration and User's Guide</i>	SC27-2467-00	No	August, 2009
<i>Spatial Extender and Geodetic Data Management Feature User's Guide and Reference</i>	SC27-2468-00	No	August, 2009
<i>SQL Procedural Languages: Application Enablement and Support</i>	SC27-2470-00	Yes	August, 2009
<i>SQL Reference, Volume 1</i>	SC27-2456-00	Yes	August, 2009
<i>SQL Reference, Volume 2</i>	SC27-2457-00	Yes	August, 2009
<i>Troubleshooting and Tuning Database Performance</i>	SC27-2461-00	Yes	August, 2009
<i>Upgrading to DB2 Version 9.7</i>	SC27-2452-00	Yes	August, 2009
<i>Visual Explain Tutorial</i>	SC27-2462-00	No	August, 2009
<i>What's New for DB2 Version 9.7</i>	SC27-2463-00	Yes	August, 2009
<i>Workload Manager Guide and Reference</i>	SC27-2464-00	Yes	August, 2009
<i>XQuery Reference</i>	SC27-2466-00	No	August, 2009

*Table 42. DB2 Connect-specific technical information*

<b>Name</b>	<b>Form Number</b>	<b>Available in print</b>	<b>Last updated</b>
<i>Installing and Configuring DB2 Connect Personal Edition</i>	SC27-2432-00	Yes	August, 2009
<i>Installing and Configuring DB2 Connect Servers</i>	SC27-2433-00	Yes	August, 2009

Table 42. DB2 Connect-specific technical information (continued)

Name	Form Number	Available in print	Last updated
DB2 Connect User's Guide	SC27-2434-00	Yes	August, 2009

Table 43. Information Integration technical information

Name	Form Number	Available in print	Last updated
Information Integration: Administration Guide for Federated Systems	SC19-1020-02	Yes	August, 2009
Information Integration: ASNCLP Program Reference for Replication and Event Publishing	SC19-1018-04	Yes	August, 2009
Information Integration: Configuration Guide for Federated Data Sources	SC19-1034-02	No	August, 2009
Information Integration: SQL Replication Guide and Reference	SC19-1030-02	Yes	August, 2009
Information Integration: Introduction to Replication and Event Publishing	GC19-1028-02	Yes	August, 2009

## Ordering printed DB2 books

If you require printed DB2 books, you can buy them online in many but not all countries or regions. You can always order printed DB2 books from your local IBM representative. Keep in mind that some softcopy books on the *DB2 PDF Documentation DVD* are unavailable in print. For example, neither volume of the *DB2 Message Reference* is available as a printed book.

Printed versions of many of the DB2 books available on the *DB2 PDF Documentation DVD* can be ordered for a fee from IBM. Depending on where you are placing your order from, you may be able to order books online, from the IBM Publications Center. If online ordering is not available in your country or region, you can always order printed DB2 books from your local IBM representative. Note that not all books on the *DB2 PDF Documentation DVD* are available in print.

**Note:** The most up-to-date and complete DB2 documentation is maintained in the DB2 Information Center at <http://publib.boulder.ibm.com/infocenter/db2luw/v9r7>.

To order printed DB2 books:

- To find out whether you can order printed DB2 books online in your country or region, check the IBM Publications Center at <http://www.ibm.com/shop/publications/order>. You must select a country, region, or language to access publication ordering information and then follow the ordering instructions for your location.
- To order printed DB2 books from your local IBM representative:

1. Locate the contact information for your local representative from one of the following Web sites:
  - The IBM directory of world wide contacts at [www.ibm.com/planetwide](http://www.ibm.com/planetwide)
  - The IBM Publications Web site at <http://www.ibm.com/shop/publications/order>. You will need to select your country, region, or language to the access appropriate publications home page for your location. From this page, follow the "About this site" link.
2. When you call, specify that you want to order a DB2 publication.
3. Provide your representative with the titles and form numbers of the books that you want to order. For titles and form numbers, see "DB2 technical library in hardcopy or PDF format" on page 1175.

---

## Displaying SQL state help from the command line processor

DB2 products return an SQLSTATE value for conditions that can be the result of an SQL statement. SQLSTATE help explains the meanings of SQL states and SQL state class codes.

To start SQL state help, open the command line processor and enter:

```
? sqlstate or ? class code
```

where *sqlstate* represents a valid five-digit SQL state and *class code* represents the first two digits of the SQL state.

For example, ? 08003 displays help for the 08003 SQL state, and ? 08 displays help for the 08 class code.

---

## Accessing different versions of the DB2 Information Center

For DB2 Version 9.7 topics, the DB2 Information Center URL is <http://publib.boulder.ibm.com/infocenter/db2luw/v9r7/>

For DB2 Version 9.5 topics, the DB2 Information Center URL is <http://publib.boulder.ibm.com/infocenter/db2luw/v9r5/>

For DB2 Version 9 topics, the DB2 Information Center URL is <http://publib.boulder.ibm.com/infocenter/db2luw/v9/>

For DB2 Version 8 topics, go to the Version 8 Information Center URL at: <http://publib.boulder.ibm.com/infocenter/db2luw/v8/>

---

## Displaying topics in your preferred language in the DB2 Information Center

The DB2 Information Center attempts to display topics in the language specified in your browser preferences. If a topic has not been translated into your preferred language, the DB2 Information Center displays the topic in English.

- To display topics in your preferred language in the Internet Explorer browser:
  1. In Internet Explorer, click the **Tools** —> **Internet Options** —> **Languages...** button. The Language Preferences window opens.
  2. Ensure your preferred language is specified as the first entry in the list of languages.
    - To add a new language to the list, click the **Add...** button.

**Note:** Adding a language does not guarantee that the computer has the fonts required to display the topics in the preferred language.

- To move a language to the top of the list, select the language and click the **Move Up** button until the language is first in the list of languages.
- 3. Clear the browser cache and then refresh the page to display the DB2 Information Center in your preferred language.
- To display topics in your preferred language in a Firefox or Mozilla browser:
  1. Select the button in the **Languages** section of the **Tools** —> **Options** —> **Advanced** dialog. The Languages panel is displayed in the Preferences window.
  2. Ensure your preferred language is specified as the first entry in the list of languages.
    - To add a new language to the list, click the **Add...** button to select a language from the Add Languages window.
    - To move a language to the top of the list, select the language and click the **Move Up** button until the language is first in the list of languages.
  3. Clear the browser cache and then refresh the page to display the DB2 Information Center in your preferred language.

On some browser and operating system combinations, you must also change the regional settings of your operating system to the locale and language of your choice.

---

## Updating the DB2 Information Center installed on your computer or intranet server

A locally installed DB2 Information Center must be updated periodically.

### Before you begin

A DB2 Version 9.7 Information Center must already be installed. For details, see the “Installing the DB2 Information Center using the DB2 Setup wizard” topic in *Installing DB2 Servers*. All prerequisites and restrictions that applied to installing the Information Center also apply to updating the Information Center.

### About this task

An existing DB2 Information Center can be updated automatically or manually:

- Automatic updates - updates existing Information Center features and languages. An additional benefit of automatic updates is that the Information Center is unavailable for a minimal period of time during the update. In addition, automatic updates can be set to run as part of other batch jobs that run periodically.
- Manual updates - should be used when you want to add features or languages during the update process. For example, a local Information Center was originally installed with both English and French languages, and now you want to also install the German language; a manual update will install German, as well as, update the existing Information Center features and languages. However, a manual update requires you to manually stop, update, and restart the Information Center. The Information Center is unavailable during the entire update process.

### Procedure

This topic details the process for automatic updates. For manual update instructions, see the “Manually updating the DB2 Information Center installed on your computer or intranet server” topic.

To automatically update the DB2 Information Center installed on your computer or intranet server:

1. On Linux operating systems,
  - a. Navigate to the path where the Information Center is installed. By default, the DB2 Information Center is installed in the /opt/ibm/db2ic/V9.7 directory.
  - b. Navigate from the installation directory to the doc/bin directory.
  - c. Run the ic-update script:

```
ic-update
```
2. On Windows operating systems,
  - a. Open a command window.
  - b. Navigate to the path where the Information Center is installed. By default, the DB2 Information Center is installed in the <Program Files>\IBM\DB2 Information Center\Version 9.7 directory, where <Program Files> represents the location of the Program Files directory.
  - c. Navigate from the installation directory to the doc\bin directory.
  - d. Run the ic-update.bat file:

```
ic-update.bat
```

## Results

The DB2 Information Center restarts automatically. If updates were available, the Information Center displays the new and updated topics. If Information Center updates were not available, a message is added to the log. The log file is located in doc\eclipse\configuration directory. The log file name is a randomly generated number. For example, 1239053440785.log.

---

## Manually updating the DB2 Information Center installed on your computer or intranet server

If you have installed the DB2 Information Center locally, you can obtain and install documentation updates from IBM.

Updating your locally-installed DB2 Information Center manually requires that you:

1. Stop the DB2 Information Center on your computer, and restart the Information Center in stand-alone mode. Running the Information Center in stand-alone mode prevents other users on your network from accessing the Information Center, and allows you to apply updates. The Workstation version of the DB2 Information Center always runs in stand-alone mode. .
2. Use the Update feature to see what updates are available. If there are updates that you must install, you can use the Update feature to obtain and install them

**Note:** If your environment requires installing the DB2 Information Center updates on a machine that is not connected to the internet, mirror the update site to a local file system using a machine that is connected to the internet and has the DB2 Information Center installed. If many users on your network will be installing the documentation updates, you can reduce the time required for

individuals to perform the updates by also mirroring the update site locally and creating a proxy for the update site.

If update packages are available, use the Update feature to get the packages. However, the Update feature is only available in stand-alone mode.

3. Stop the stand-alone Information Center, and restart the DB2 Information Center on your computer.

**Note:** On Windows 2008, Windows Vista (and higher), the commands listed later in this section must be run as an administrator. To open a command prompt or graphical tool with full administrator privileges, right-click the shortcut and then select **Run as administrator**.

To update the DB2 Information Center installed on your computer or intranet server:

1. Stop the DB2 Information Center.
  - On Windows, click **Start** → **Control Panel** → **Administrative Tools** → **Services**. Then right-click **DB2 Information Center** service and select **Stop**.
  - On Linux, enter the following command:  

```
/etc/init.d/db2icdv97 stop
```

2. Start the Information Center in stand-alone mode.
  - On Windows:
    - a. Open a command window.
    - b. Navigate to the path where the Information Center is installed. By default, the DB2 Information Center is installed in the <Program Files>\IBM\DB2 Information Center\Version 9.7 directory, where <Program Files> represents the location of the Program Files directory.
    - c. Navigate from the installation directory to the doc\bin directory.
    - d. Run the help\_start.bat file:  

```
help_start.bat
```
  - On Linux:
    - a. Navigate to the path where the Information Center is installed. By default, the DB2 Information Center is installed in the /opt/ibm/db2ic/V9.7 directory.
    - b. Navigate from the installation directory to the doc/bin directory.
    - c. Run the help\_start script:  

```
help_start
```

The systems default Web browser opens to display the stand-alone Information Center.

3. Click the **Update** button (🔧). (JavaScript™ must be enabled in your browser.) On the right panel of the Information Center, click **Find Updates**. A list of updates for existing documentation displays.
4. To initiate the installation process, check the selections you want to install, then click **Install Updates**.
5. After the installation process has completed, click **Finish**.
6. Stop the stand-alone Information Center:
  - On Windows, navigate to the installation directory's doc\bin directory, and run the help\_end.bat file:  

```
help_end.bat
```



**Note:** The help\_end batch file contains the commands required to safely stop the processes that were started with the help\_start batch file. Do not use Ctrl-C or any other method to stop help\_start.bat.

- On Linux, navigate to the installation directory's doc/bin directory, and run the help\_end script:  
help\_end

**Note:** The help\_end script contains the commands required to safely stop the processes that were started with the help\_start script. Do not use any other method to stop the help\_start script.

7. Restart the DB2 Information Center.

- On Windows, click **Start** → **Control Panel** → **Administrative Tools** → **Services**. Then right-click **DB2 Information Center** service and select **Start**.
- On Linux, enter the following command:  
/etc/init.d/db2icdv97 start

The updated DB2 Information Center displays the new and updated topics.

---

## DB2 tutorials

The DB2 tutorials help you learn about various aspects of DB2 products. Lessons provide step-by-step instructions.

### Before you begin

You can view the XHTML version of the tutorial from the Information Center at <http://publib.boulder.ibm.com/infocenter/db2help/>.

Some lessons use sample data or code. See the tutorial for a description of any prerequisites for its specific tasks.

### DB2 tutorials

To view the tutorial, click the title.

**“pureXML®” in *pureXML Guide***

Set up a DB2 database to store XML data and to perform basic operations with the native XML data store.

**“Visual Explain” in *Visual Explain Tutorial***

Analyze, optimize, and tune SQL statements for better performance using Visual Explain.

---

## DB2 troubleshooting information

A wide variety of troubleshooting and problem determination information is available to assist you in using DB2 database products.

### DB2 documentation

Troubleshooting information can be found in the *DB2 Troubleshooting Guide* or the Database fundamentals section of the *DB2 Information Center*. There you will find information about how to isolate and identify problems using DB2 diagnostic tools and utilities, solutions to some of the most common problems, and other advice on how to solve problems you might encounter with your DB2 database products.

### DB2 Technical Support Web site

Refer to the DB2 Technical Support Web site if you are experiencing problems and want help finding possible causes and solutions. The Technical Support site has links to the latest DB2 publications, TechNotes, Authorized Program Analysis Reports (APARs or bug fixes), fix packs, and other resources. You can search through this knowledge base to find possible solutions to your problems.

Access the DB2 Technical Support Web site at [http://www.ibm.com/software/data/db2/support/db2\\_9/](http://www.ibm.com/software/data/db2/support/db2_9/)

---

## Terms and Conditions

Permissions for the use of these publications is granted subject to the following terms and conditions.

**Personal use:** You may reproduce these Publications for your personal, non commercial use provided that all proprietary notices are preserved. You may not distribute, display or make derivative work of these Publications, or any portion thereof, without the express consent of IBM.

**Commercial use:** You may reproduce, distribute and display these Publications solely within your enterprise provided that all proprietary notices are preserved. You may not make derivative works of these Publications, or reproduce, distribute or display these Publications or any portion thereof outside your enterprise, without the express consent of IBM.

Except as expressly granted in this permission, no other permissions, licenses or rights are granted, either express or implied, to the Publications or any information, data, software or other intellectual property contained therein.

IBM reserves the right to withdraw the permissions granted herein whenever, in its discretion, the use of the Publications is detrimental to its interest or, as determined by IBM, the above instructions are not being properly followed.

You may not download, export or re-export this information except in full compliance with all applicable laws and regulations, including all United States export laws and regulations.

IBM MAKES NO GUARANTEE ABOUT THE CONTENT OF THESE PUBLICATIONS. THE PUBLICATIONS ARE PROVIDED "AS-IS" AND WITHOUT WARRANTY OF ANY KIND, EITHER EXPRESSED OR IMPLIED, INCLUDING BUT NOT LIMITED TO IMPLIED WARRANTIES OF MERCHANTABILITY, NON-INFRINGEMENT, AND FITNESS FOR A PARTICULAR PURPOSE.

---

## Appendix D. Notices

This information was developed for products and services offered in the U.S.A. Information about non-IBM products is based on information available at the time of first publication of this document and is subject to change.

IBM may not offer the products, services, or features discussed in this document in other countries. Consult your local IBM representative for information on the products and services currently available in your area. Any reference to an IBM product, program, or service is not intended to state or imply that only that IBM product, program, or service may be used. Any functionally equivalent product, program, or service that does not infringe any IBM intellectual property right may be used instead. However, it is the user's responsibility to evaluate and verify the operation of any non-IBM product, program, or service.

IBM may have patents or pending patent applications covering subject matter described in this document. The furnishing of this document does not grant you any license to these patents. You can send license inquiries, in writing, to:

IBM Director of Licensing  
IBM Corporation  
North Castle Drive  
Armonk, NY 10504-1785  
U.S.A.

For license inquiries regarding double-byte character set (DBCS) information, contact the IBM Intellectual Property Department in your country or send inquiries, in writing, to:

Intellectual Property Licensing  
Legal and Intellectual Property Law  
IBM Japan, Ltd.  
3-2-12, Roppongi, Minato-ku, Tokyo 106-8711 Japan

**The following paragraph does not apply to the United Kingdom or any other country/region where such provisions are inconsistent with local law:**  
INTERNATIONAL BUSINESS MACHINES CORPORATION PROVIDES THIS PUBLICATION "AS IS" WITHOUT WARRANTY OF ANY KIND, EITHER EXPRESS OR IMPLIED, INCLUDING, BUT NOT LIMITED TO, THE IMPLIED WARRANTIES OF NON-INFRINGEMENT, MERCHANTABILITY, OR FITNESS FOR A PARTICULAR PURPOSE. Some states do not allow disclaimer of express or implied warranties in certain transactions; therefore, this statement may not apply to you.

This information could include technical inaccuracies or typographical errors. Changes are periodically made to the information herein; these changes will be incorporated in new editions of the publication. IBM may make improvements and/or changes in the product(s) and/or the program(s) described in this publication at any time without notice.

Any references in this information to non-IBM Web sites are provided for convenience only and do not in any manner serve as an endorsement of those Web

sites. The materials at those Web sites are not part of the materials for this IBM product and use of those Web sites is at your own risk.

IBM may use or distribute any of the information you supply in any way it believes appropriate without incurring any obligation to you.

Licensees of this program who wish to have information about it for the purpose of enabling: (i) the exchange of information between independently created programs and other programs (including this one) and (ii) the mutual use of the information that has been exchanged, should contact:

IBM Canada Limited  
Office of the Lab Director  
8200 Warden Avenue  
Markham, Ontario  
L6G 1C7  
CANADA

Such information may be available, subject to appropriate terms and conditions, including, in some cases, payment of a fee.

The licensed program described in this document and all licensed material available for it are provided by IBM under terms of the IBM Customer Agreement, IBM International Program License Agreement, or any equivalent agreement between us.

Any performance data contained herein was determined in a controlled environment. Therefore, the results obtained in other operating environments may vary significantly. Some measurements may have been made on development-level systems, and there is no guarantee that these measurements will be the same on generally available systems. Furthermore, some measurements may have been estimated through extrapolation. Actual results may vary. Users of this document should verify the applicable data for their specific environment.

Information concerning non-IBM products was obtained from the suppliers of those products, their published announcements, or other publicly available sources. IBM has not tested those products and cannot confirm the accuracy of performance, compatibility, or any other claims related to non-IBM products. Questions on the capabilities of non-IBM products should be addressed to the suppliers of those products.

All statements regarding IBM's future direction or intent are subject to change or withdrawal without notice, and represent goals and objectives only.

This information may contain examples of data and reports used in daily business operations. To illustrate them as completely as possible, the examples include the names of individuals, companies, brands, and products. All of these names are fictitious, and any similarity to the names and addresses used by an actual business enterprise is entirely coincidental.

#### COPYRIGHT LICENSE:

This information contains sample application programs in source language, which illustrate programming techniques on various operating platforms. You may copy, modify, and distribute these sample programs in any form without payment to IBM, for the purposes of developing, using, marketing or distributing application

programs conforming to the application programming interface for the operating platform for which the sample programs are written. These examples have not been thoroughly tested under all conditions. IBM, therefore, cannot guarantee or imply reliability, serviceability, or function of these programs. The sample programs are provided "AS IS", without warranty of any kind. IBM shall not be liable for any damages arising out of your use of the sample programs.

Each copy or any portion of these sample programs or any derivative work must include a copyright notice as follows:

© (*your company name*) (*year*). Portions of this code are derived from IBM Corp. Sample Programs. © Copyright IBM Corp. *\_enter the year or years\_*. All rights reserved.

## Trademarks

IBM, the IBM logo, and [ibm.com](http://www.ibm.com)<sup>®</sup> are trademarks or registered trademarks of International Business Machines Corp., registered in many jurisdictions worldwide. Other product and service names might be trademarks of IBM or other companies. A current list of IBM trademarks is available on the Web at "Copyright and trademark information" at [www.ibm.com/legal/copytrade.shtml](http://www.ibm.com/legal/copytrade.shtml).

The following terms are trademarks or registered trademarks of other companies

- Linux is a registered trademark of Linus Torvalds in the United States, other countries, or both.
- Java and all Java-based trademarks and logos are trademarks of Sun Microsystems, Inc. in the United States, other countries, or both.
- UNIX is a registered trademark of The Open Group in the United States and other countries.
- Intel, Intel logo, Intel Inside<sup>®</sup>, Intel Inside logo, Intel<sup>®</sup> Centrino<sup>®</sup>, Intel Centrino logo, Celeron<sup>®</sup>, Intel<sup>®</sup> Xeon<sup>®</sup>, Intel SpeedStep<sup>®</sup>, Itanium<sup>®</sup>, and Pentium<sup>®</sup> are trademarks or registered trademarks of Intel Corporation or its subsidiaries in the United States and other countries.
- Microsoft, Windows, Windows NT<sup>®</sup>, and the Windows logo are trademarks of Microsoft Corporation in the United States, other countries, or both.

Other company, product, or service names may be trademarks or service marks of others.



---

# Index

## A

- abnormal termination
  - restart command 517
- access paths
  - optimizing 551
- action precompile/bind option 71, 409
- ACTIVATE DATABASE command
  - syntax description 39
- active directory
  - schema extension
    - command 1039
- ADD CONTACT command
  - syntax description 41
- ADD CONTACTGROUP command
  - syntax description 43
- Add Database Partition Server to an Instance command 927
- ADD DBPARTITIONNUM command 45
- ADD XMLSCHEMA DOCUMENT command
  - syntax 49
- admin configuration
  - file 189
  - network parameter values 623
  - resetting to default 507
  - sample 189
- administration server
  - configuration 189
  - creating 683
  - dropping 683
- advisors
  - db2advis 693
  - Design Advisor 693
- anyorder file type modifier 357
- APPC (Advanced Program-to-Program Communication)
  - node
    - uncataloging 617
- ARCHIVE LOG command 51
- ASC import file type 263
- ATTACH command 55
- Audit Facility Administrator Tool command 701
- Auto-start instance command 843
- AUTOCONFIGURE command 57
- Autostart DAS command 661

## B

- backup
  - objects 721
- BACKUP DATABASE command 61
- Benchmark Tool command 711
- binary files 1093
- binarynumerics file type modifier 357
- BIND command
  - syntax 71
- Bind File Description Tool command 725
- bindfile precompile option 409
- binding
  - errors 119
  - implicitly created schema 71, 409
- blocking precompile/bind option 71, 409

- books
  - printed
  - ordering 1178

## C

- CALL statement
  - run through the CLP 25
- case sensitivity
  - commands 3
  - in naming conventions 1171
- CATALOG DATABASE command
  - syntax 91
- CATALOG DCS DATABASE command 95
- CATALOG LDAP DATABASE command 97
- CATALOG LDAP NODE command 101
- CATALOG LOCAL NODE command 103
- CATALOG NAMED PIPE NODE command 105
- CATALOG ODBC DATA SOURCE command 107
- CATALOG TCP/IP NODE command 109
- cataloging
  - databases 91
  - host database 95
- CCSIDG precompile/bind option 71, 409
- CCSIDM precompile/bind option 71, 409
- CCSIDS precompile/bind option 71, 409
- CHANGE DATABASE COMMENT command 113
- change database partition server configuration command 925
- CHANGE ISOLATION LEVEL command 115
- Change search path command 741
- chardel file type modifier
  - export 177
  - import 263
  - load 357
- charsub precompile/bind option 71, 409
- check backup command 743
- check database for upgrade command 747
- check incremental restore image sequence command 751
- CLI (call level interface)
  - configuration 197
- CLI/ODBC static package binding tool command 729
- CLIPKG precompile/bind option 71
- CLOSE statement
  - run through the CLP 25
- CLP (command line processor)
  - commands
    - syntax 9
    - quitting 449
    - terminating 607
- cnulreqd precompile/bind option 71, 409
- code page file type modifier 357
- code pages
  - EXPORT command 177
  - IMPORT command 263
- codel file type modifier
  - export
    - EXPORT command 177
  - import
    - IMPORT command 263
  - load
    - LOAD command 357

- collection precompile/bind option 71, 409
- command
  - syntax help 33
- command line processor (CLP)
  - accessing help 9
  - back-end process
    - terminating 607
  - invocation command 9
  - line continuation character 3
  - options 11
  - quitting 9, 449
  - return codes 19
  - shell command 9
  - SQL statements 25
  - terminating 9, 607
  - using 3
- command syntax
  - CLP commands 9
- commands
  - ACTIVATE DATABASE 39
  - ADD CONTACT 41
  - ADD CONTACTGROUP 43
  - ADD DBPARTITIONNUM 45
  - ARCHIVE LOG 51
  - ATTACH 55
  - AUTOCONFIGURE 57
  - BACKUP DATABASE 61
  - BIND 71
  - CATALOG DATABASE 91
  - CATALOG DCS DATABASE 95
  - CATALOG LDAP DATABASE 97
  - CATALOG LDAP NODE 101
  - CATALOG LOCAL NODE 103
  - CATALOG NAMED PIPE NODE 105
  - CATALOG ODBC DATA SOURCE 107
  - CATALOG TCP/IP NODE 109
  - CHANGE DATABASE COMMENT 113
  - CHANGE ISOLATION LEVEL 115
  - CREATE DATABASE 119
  - CREATE TOOLS CATALOG 139
  - dasauto 661
  - dasprt 663
  - dasdrop 665
  - dasmigr 667
  - dasupdt 669
  - db2 9
  - DB2 JDBC Package Binder Utility 877
  - db2\_deinstall 671
  - db2\_install 675
  - db2\_local\_ps 679
  - db2acsutil 721
  - db2addicons 681
  - db2admin 683
  - db2adutl 685
  - db2advis 693
  - db2audit 701
  - db2batch 711
  - db2bfd 725
  - db2cap 729
  - db2cc 733
  - db2cfexp 735
  - db2cfimp 737
  - db2chglibpath 739
  - db2chgpath 741
  - db2ckbkp 743
  - db2ckrst 751
  - db2ckupgrade 747

- commands (*continued*)
  - db2cli 753
  - db2cmd 755
  - db2cptsa 757
  - db2dart 759
  - db2daslevel 765
  - db2dclgn 767
  - db2diag 771
  - db2drdat 785
  - db2drvmp 787
  - db2empfa 789
  - db2envar.bat 791
  - db2eva 793
  - db2evmon 795
  - db2evtbl 797
  - db2exmig 803
  - db2expln 805
  - db2extsec 815
  - db2flsn 817
  - db2fm 819
  - db2fmcu 821
  - db2fodc 823
  - db2fs 829
  - db2gcf 831
  - db2gov 835
  - db2govlg 837
  - db2gpmap 839
  - db2hc 841
  - db2iauto 843
  - db2iclus 845
  - db2icrt 849
  - db2IdentifyType1 855
  - db2idrop 853
  - db2ilist 859
  - db2inidb 865
  - db2inspf 867
  - db2iprune 869
  - db2isetup 871
  - db2iupdt 873
  - db2iupgrade 861
  - db2jdbcbind 877
  - db2ldcfg 879
  - db2level 881
  - db2licm 883
  - db2listvolumes 885
  - db2logsforrwd 887
  - db2look 889
  - db2ls 899
  - db2move 903
  - db2mqsln 913
  - db2mscs 917
  - db2mtrk 921
  - db2nchg 925
  - db2ncrt 927
  - db2ndrop 929
  - db2nrcfg 931
  - db2nrupdt 935
  - db2nrupgrade 937
  - db2osconf 939
  - db2pd 943
  - db2pdcfg 1009
  - db2perfc 1015
  - db2perfi 1017
  - db2perfr 1019
  - db2rbind 1021
  - db2relocatedb 1023
  - db2rfe 933



commands (continued)

db2rmicons 1031  
 db2sampl 1035  
 db2schex 1039  
 db2set 1041  
 db2setup 1045  
 db2sqljbind 1047  
 db2sqljprint 1065  
 db2start 1067  
 db2stat 1069  
 db2stop 1071  
 db2support 1073  
 db2swtch 1079  
 db2sync 1081  
 db2systray 1083  
 db2tapemgr 1085  
 db2tbst 1089  
 db2tdbmgr 1091  
 db2trc 1093  
 db2ts ALTER INDEX 1135  
 db2ts CLEANUP FOR TEXT 1139  
 db2ts CLEAR COMMAND LOCKS 1141  
 db2ts CLEAR EVENTS FOR INDEX 1143  
 db2ts CREATE INDEX 1145  
 db2ts DISABLE DATABASE FOR TEXT 1151  
 db2ts DROP INDEX 1155  
 db2ts ENABLE DATABASE FOR TEXT 1157  
 db2ts HELP 1159  
 db2ts START FOR TEXT 1161  
 db2ts STOP FOR TEXT 1163  
 db2ts UPDATE INDEX 1165  
 db2unins 1101  
 db2untag 1103  
 db2updserv 1105  
 db2xdbmig 1109  
 db2xpirt 1111  
 DEACTIVATE DATABASE 143  
 DECOMPOSE XML DOCUMENT 145, 147  
 DEREGISTER 149  
 DESCRIBE 151  
 DETACH 161  
 disable\_MQFunctions 1113  
 doce\_deinstall 1115  
 doce\_install 1117  
 DROP CONTACT 163  
 DROP CONTACTGROUP 165  
 DROP DATABASE 167  
 DROP DBPARTITIONNUM VERIFY 169  
 DROP TOOLS CATALOG 171  
 ECHO 173  
 EDIT 175  
 enable\_MQFunctions 1119  
 EXPORT 177  
 FORCE APPLICATION 187  
 GET ADMIN CONFIGURATION 189  
 GET ALERT CONFIGURATION 191  
 GET CLI CONFIGURATION 197  
 GET CONNECTION STATE 199  
 GET CONTACTGROUP 201  
 GET CONTACTGROUPS 203  
 GET CONTACTS 205  
 GET DATABASE CONFIGURATION 207  
 GET DATABASE MANAGER CONFIGURATION 213  
 GET DATABASE MANAGER MONITOR SWITCHES 219  
 GET DESCRIPTION FOR HEALTH INDICATOR 223  
 GET HEALTH NOTIFICATION CONTACT LIST 225  
 GET HEALTH SNAPSHOT 227

commands (continued)

GET INSTANCE 231  
 GET MONITOR SWITCHES 233  
 GET RECOMMENDATIONS 237  
 GET ROUTINE 241  
 GET SNAPSHOT 243  
 HELP 259  
 HISTORY 261  
 IMPORT 263  
 INITIALIZE TAPE 291  
 INSPECT 293  
 installFixPack 1123  
 invoking help 21  
 LIST ACTIVE DATABASES 301  
 LIST APPLICATIONS 303  
 LIST COMMAND OPTIONS 305  
 LIST DATABASE DIRECTORY 307  
 LIST DATABASE PARTITION GROUPS 311  
 LIST DBPARTITIONNUMS 313  
 LIST DCS APPLICATIONS 315  
 LIST DCS DIRECTORY 317  
 LIST DRDA INDOUBT TRANSACTIONS 319  
 LIST HISTORY 321  
 LIST INDOUBT TRANSACTIONS 325  
 LIST NODE DIRECTORY 329  
 LIST ODBC DATA SOURCES 333  
 LIST PACKAGES/TABLES 335  
 LIST TABLESPACE CONTAINERS 339  
 LIST TABLESPACES 341  
 LIST UTILITIES 355  
 LOAD 357  
 LOAD QUERY 399  
 Microsoft Cluster Server 845  
 MQ Listener 913  
 PING 407  
 PRECOMPILE 409  
 PRUNE HISTORY/LOGFILE 435  
 PUT ROUTINE 437  
 QUERY CLIENT 439  
 QUIESCE 441  
 QUIESCE TABLESPACES FOR TABLE 445  
 QUIT 449  
 REBIND 451  
 RECOVER DATABASE 455  
 redirecting output 3  
 REDISTRIBUTE DATABASE PARTITION GROUP 461  
 REFRESH LDAP 473  
 REGISTER 475  
 REORG INDEXES/TABLE 483  
 REORGCHK 497  
 RESET ADMIN CONFIGURATION 507  
 RESET ALERT CONFIGURATION 509  
 RESET DATABASE CONFIGURATION 511  
 RESET DATABASE MANAGER CONFIGURATION 513  
 RESET MONITOR 515  
 RESTART DATABASE 517  
 RESTORE DATABASE 519  
 REWIND TAPE 537  
 ROLLFORWARD DATABASE 539  
 RUNCMD 549  
 RUNSTATS 551  
 SET CLIENT 567  
 SET RUNTIME DEGREE 571  
 SET SERVEROUTPUT 573  
 SET TABLESPACE CONTAINERS 575  
 SET TAPE POSITION 579  
 SET UTIL\_IMPACT\_PRIORITY 581

commands (*continued*)  
 SET WORKLOAD 583  
 SET WRITE 585  
 setup 1127  
 sqlj 1129  
 SQLJ Profile Binder 1047  
 SQLJ Translator 1129  
 START DATABASE MANAGER 587  
 START HADR 595  
 STOP DATABASE MANAGER 597  
 STOP HADR 601  
 TAKEOVER HADR 603  
 TERMINATE 607  
 UNCATALOG DATABASE 609  
 UNCATALOG DCS DATABASE 611  
 UNCATALOG LDAP DATABASE 613  
 UNCATALOG LDAP NODE 615  
 UNCATALOG NODE 617  
 UNCATALOG ODBC DATA SOURCE 619  
 UNQUIESCE 621  
 UPDATE ADMIN CONFIGURATION 623  
 UPDATE ALERT CONFIGURATION 625  
 UPDATE ALTERNATE SERVER FOR DATABASE 631  
 UPDATE ALTERNATE SERVER FOR LDAP  
 DATABASE 633  
 UPDATE CLI CONFIGURATION 635  
 UPDATE COMMAND OPTIONS 637  
 UPDATE CONTACT 639  
 UPDATE CONTACTGROUP 641  
 UPDATE DATABASE CONFIGURATION 643  
 UPDATE DATABASE MANAGER CONFIGURATION 647  
 UPDATE HEALTH NOTIFICATION CONTACT LIST 649  
 UPDATE HISTORY FILE 651  
 UPDATE LDAP NODE 653  
 UPDATE MONITOR SWITCHES 655  
 UPDATE XMLSCHEMA 657  
 UPGRADE DATABASE 405  
 COMPLETE XMLSCHEMA command  
 syntax 117  
 compound file type modifier 263  
 configuration  
 administration  
 resetting to default 507  
 sample 189  
 CLI  
 sample 197  
 database  
 resetting to default 511  
 sample 207  
 updating 643  
 database manager  
 sample 213  
 Configuration Assistant (CA)  
 starting 727  
 Configure DB2 database for problem determination behavior  
 command 1009  
 configure LDAP environment command 879  
 connect precompile option 409  
 CONNECT statement  
 run through the CLP 25  
 connectivity configuration export tool command 735  
 connectivity configuration import tool command 737  
 continuation character  
 command line processor (CLP) 3  
 Control Center  
 starting 733  
 Control DB2 instance command 831

CREATE DATABASE command  
 description 119  
 create instance command 849  
 Create main menu entries for DB2 tools command 681  
 create sample database command 1035  
 CREATE TOOLS CATALOG command 139  
 cursor stability (CS)  
 changing 115

## D

dasauto command 661  
 dasCRT command 663  
 dasdrop command 665  
 dasmigr command  
 description 667  
 dasupdt command 669  
 data  
 fragmentation  
 eliminating using table reorganization 483  
 integrity  
 isolation levels 115  
 redistribution  
 REDISTRIBUTE DATABASE PARTITION GROUP  
 command 461  
 database analysis and reporting tool command  
 description 759  
 database configuration file  
 resetting values 511  
 retrieving values 207  
 sample 207  
 updating 643  
 Database Connection Services (DCS) directory  
 removing entries 611  
 database directories  
 changing comments 113  
 description 307  
 sample content 307  
 database manager  
 monitor switches  
 GET DATABASE MANAGER MONITOR SWITCHES  
 command 219  
 GET MONITOR SWITCHES command 233  
 starting 587  
 statistics 243  
 stopping 597  
 database manager configuration file  
 retrieving values with GET DATABASE MANAGER  
 CONFIGURATION command 213  
 sample file 213  
 database movement tool command 903  
 database system monitor  
 GET DATABASE MANAGER MONITOR SWITCHES  
 command 219  
 GET MONITOR SWITCHES command 233  
 GET SNAPSHOT command 243  
 RESET MONITOR command 515  
 UPDATE MONITOR SWITCHES command 655  
 updating recording switches 655  
 databases  
 backups  
 history file 435  
 cataloging  
 CATALOG DATABASE command 91  
 creating  
 CREATE DATABASE command 119

databases (*continued*)

- deleting
  - Database Connection Services (DCS) 611
  - DROP DATABASE command 167
  - system database directory 609
- dropping
  - DROP DATABASE command 167
- exporting from table into file
  - EXPORT command 177
- home directory entry 307
- importing from file into table
  - IMPORT command 263
- indirect directory entry 307
- information collection 243
- loading data into tables 357
- monitoring 515
- rebuilding
  - RESTORE DATABASE command 519
- recovery
  - ROLLFORWARD DATABASE command 539
- remote directory entry 307
- reorganizing 497
- restarting 517
- restoring 519
- rollforward recovery
  - ROLLFORWARD DATABASE command 539
- statistics 551
- uncataloging
  - Database Connection Services (DCS) 611
  - system database directory 609
- upgrading
  - UPGRADE DATABASE command 405

dateformat file type modifier

- IMPORT command 263
- LOAD command 357

DB2 administration server (DAS)

- command
  - creating 663
  - description 683
- configuring 189
- creating
  - db2admin command 683
- dropping 683
- managing 683

db2 command 9

DB2 Connect

- connections supported 95

DB2 copy

- validation tool 1107

DB2 copy validation tool 1107

DB2 database drive map command 787

DB2 fault monitor command 819

DB2 for z/OS

- binding plans and packages 1053

DB2 governor

- command 835
- log query command 837

DB2 Information Center

- languages 1179
- updating 1180, 1181
- versions 1179
- viewing in different languages 1179

DB2 process status for Linux/UNIX command 679

DB2 process status for Windows command 1069

DB2 profile registry command 1041

DB2 statistics and DDL extraction tool command 889

db2\_deinstall command

- description 671

db2\_install command

- description 675

db2\_local\_ps command 679

db2acsutil command 721

db2addicons command

- description 681

db2admin command 683

db2adutl command

- description 685

db2advis command

- description 693

db2audit command

- description 701

db2batch command

- description 711

db2bfd command

- description 725

db2ca command 727

db2cap command 729

db2cat command 731

db2cc command 733

db2cfexp command 735

db2cfimp command 737

db2chglbpath command 739

db2chgpath command 741

db2ckbkp command 743

db2ckrst command 751

db2ckupgrade command

- description 747

db2cli command 753

db2cmd command 755

db2cpts command 757

db2dart command

- description 759

db2daslevel command 765

db2dclgn command

- description 767

db2diag command

- description 771

db2diag log analysis tool command 771

db2drdat command

- description 785

db2drvmp command 787

db2empfa command 789

db2envar.bat command 791

db2eva command 793

db2evmon command 795

db2evtbl command 797

db2exfmt command

- description 799

db2exmig command

- description 803

db2expln command

- description 805

db2extsec command 815

db2flsn command 817

db2fm command

- description 819

db2fmcu command 821

db2fodc command 823

db2fs command 829

db2gcf command 831

db2gov command

- description 835

db2govlg command 837

db2gpmap command 839  
 db2hc command 841  
 db2iauto command 843  
 db2iclus command 845  
 db2icrt command  
     description 849  
 db2IdentifyType1 command 855  
 db2idrop command  
     description 853  
 db2ilist command  
     description 859  
 db2inidb command  
     description 865  
 db2inspf command  
     description 867  
 db2iprune command 869  
 db2isetup command 871  
 db2iupdt command  
     description 873  
 db2iupgrade command  
     description 861  
 db2jdbcbind command 877  
 db2ldcfg command  
     description 879  
 db2level command  
     description 881  
 db2licm command  
     description 883  
 db2listvolumes command 885  
 db2logsforrwd command 887  
 db2look command  
     description 889  
 db2ls command  
     description 899  
 db2move command  
     description 903  
 db2mqlsn command 913  
 db2mscs command 917  
 db2mtrk command  
     description 921  
 db2nchg command  
     description 925  
 db2nrcrt command  
     description 927  
 db2ndrop command  
     description 929  
 db2nrcfg command 931  
 db2nrupdt command 935  
 db2nrupgrade command  
     description 937  
 DB2OPTIONS environment variable  
     setting CLP options 11  
 db2osconf command  
     description 939  
 db2pd command  
     description 943  
 db2pdcfg command  
     description 1009  
 db2perfc command  
     description 1015  
 db2perfi command  
     description 1017  
 db2perfr command  
     description 1019  
 db2rbind command  
     description 1021  
 db2relocatedb command  
     description 1023  
 db2rfe command  
     description 933  
 db2rfpen command 1029  
 db2rmicons command  
     description 1031  
 db2rspgn response file generator 1033  
 db2sampl command 1035  
 db2schex command 1039  
 db2set command  
     description 1041  
 db2setup command  
     description 1045  
 db2sqljbind command 1047  
 db2sqljcustomize command 1053  
 db2sqljprint command  
     description 1065  
 db2start command  
     description 587, 1067  
 db2stat command 1069  
 db2stop command  
     description 597, 1071  
 db2swtch command 1079  
 db2sync command 1081  
 db2systray command 1083  
 db2tapemgr command  
     description 1085  
 db2tbt command 1089  
 db2tdbmgr command  
     description 1091  
 db2trc command  
     description 1093  
 db2ts commands  
     ALTER INDEX 1135  
     CLEANUP FOR TEXT 1139  
     CLEAR COMMAND LOCKS 1141  
     CLEAR EVENTS FOR INDEX 1143  
     CREATE INDEX 1145  
     DISABLE DATABASE FOR TEXT 1151  
     DROP INDEX 1155  
     ENABLE DATABASE FOR TEXT 1157  
     HELP 1159  
     START FOR TEXT 1161  
     STOP FOR TEXT 1163  
     UPDATE INDEX 1165  
 db2unins command 1101  
 db2untag command 1103  
 db2updsvr command 1105  
 db2val 1107  
 db2xdbmig command 1109  
 db2xpvt command 1111  
 DCLGEN command 767  
 DEACTIVATE DATABASE command 143  
 declaration generator command 767  
 DECLARE CURSOR statement  
     running in CLP 25  
 DECOMPOSE XML DOCUMENT command  
     description 145, 147  
 decplusblank file type modifier  
     EXPORT command 177  
     IMPORT command 263  
     LOAD command 357  
 decpt file type modifier  
     EXPORT command 177  
     IMPORT command 263  
     LOAD command 357

- default configuration resetting
  - databases 511
  - DB2 administration server (DAS) 507
- delimiters
  - modifying 1173
  - restrictions on moving data 1173
- delprioritychar file type modifier
  - IMPORT command 263
  - LOAD command 357
- DEREGISTER command 149
- DESCRIBE command
  - description
    - without ADMIN\_CMD procedure 151
- Design Advisor
  - db2adviz command 693
- DETACH command
  - description 161
- directories
  - Database Connection Services (DCS)
    - deleting entries 611
  - local database
    - changing comments 113
  - node
    - deleting entries 617
  - system database
    - changing comments 113
    - deleting entries 609
    - uncataloguing database (API) 609
- disable\_MQFunctions command 1113
- display GUIDs for all disk volumes command 885
- doce\_deinstall command
  - description 1115
- doce\_install command
  - description 1117
- documentation
  - overview 1175
  - PDF 1175
  - printed 1175
  - terms and conditions of use 1184
- DRDA trace command 785
- DROP CONTACT command
  - description 163
- DROP CONTACTGROUP command
  - description 165
- DROP DATABASE command
  - description 167
- drop database partition server from an instance
  - command 929
- DROP DBPARTITIONNUM VERIFY command 169
- DROP TOOLS CATALOG command 171
- dumpfile file type modifier 357
- dumping a trace to file
  - db2trc command 1093
- DYNAMICRULES precompile/bind option
  - BIND command 71
  - PRECOMPILE command 409

## E

- ECHO command 173
- EDIT command 175
- embedded runtime library search path
  - changing 739
- enable\_MQFunctions command 1119
- environment variables
  - DB2OPTIONS 11

- error messages
  - checksum
    - database configuration file 511, 643
    - database manager configuration file 507
    - database configuration files 207
    - remote database dropping
      - DROP DATABASE command 167
  - event analyzer command 793
  - event monitor command 795
  - exit codes
    - CLP 19
  - explain tables
    - formatting contents 799
  - EXPORT command
    - description
      - without ADMIN\_CMD procedure 177
  - exporting
    - data
      - EXPORT command 177
      - file type modifiers 177

## F

- fastparse file type modifier 357
- fault monitor controller utility 821
- federated precompile/bind option 71, 409
- federated\_asynchrony precompile/bind option 71, 409
- FETCH statement
  - run through the CLP 25
- file formats
  - exporting table to file 177
  - importing file to table 263
- file type modifiers
  - EXPORT utility 177
  - exportimportload 1173
  - IMPORT command 263
  - LOAD command 357
- Find Log Sequence Number command 817
- first occurrence data collection 823
- First Steps 829
- FODC (first occurrence data capture)
  - option in db2pdcfg command 1009
- FORCE APPLICATION command 187
- forcein file type modifier 263, 357
- Format inspect results command 867
- Format trap file command 1111
- funcpath precompile/bind option 71, 409

## G

- Generate Event Monitor Target Table Definitions
  - command 797
- generatedignore file type modifier 263, 357
- generatedmissing file type modifier 263, 357
- generatedoverride file type modifier 357
- generic precompile/bind option 71, 409
- GET ADMIN CONFIGURATION command 189
- GET ALERT CONFIGURATION command 191
- GET CLI CONFIGURATION command 197
- GET CONNECTION STATE command 199
- GET CONTACTGROUP command 201
- GET CONTACTGROUPS command 203
- GET CONTACTS command 205
- GET DATABASE CONFIGURATION command 207
- GET DATABASE MANAGER CONFIGURATION
  - command 213

- GET DATABASE MANAGER MONITOR SWITCHES
  - command 219
- GET DESCRIPTION FOR HEALTH INDICATOR
  - command 223
- Get distribution map command 839
- GET HEALTH NOTIFICATION CONTACT LIST
  - command 225
- GET HEALTH SNAPSHOT command 227
- GET INSTANCE command 231
- GET MONITOR SWITCHES command 233
- GET RECOMMENDATIONS
  - command 237
- GET ROUTINE command 241
- GET SNAPSHOT command 243
  - effect on UPDATE MONITOR SWITCHES 655
- Get Tablespace State command 1089
- grant bind option 71
- grantgroup bind option 71
- grantuser bind option 71

## H

- help
  - commands 21
  - configuring language 1179
  - messages 23
  - SQL statements 1179
- HELP command
  - DB2 Database for Linux, UNIX, and Windows 259
- highlighting conventions xii
- HISTORY command 261
- host systems
  - cataloging databases 95
  - connections supported by DB2 Connect
    - CATALOG DCS DATABASE command 95
    - removing DCS catalog entries 611
- how this book is structured xi

## I

- identityignore 263
  - file type modifier 357
- identitymissing
  - file type modifier 263, 357
- identityoverride
  - file type modifier 357
- images 869
- implicit connections 3
- implieddecimal file type modifier 263, 357
- IMPORT command 263
- importing
  - data 263
- indexes
  - REORGCHK command 497
  - statistics
    - RUNSTATS command 551
- indexfreespace file type modifier 357
- indexixf file type modifier 263
- indexschema file type modifier 263
- indoubt transaction field 325
- Initialize a Mirrored Database command 865
- INITIALIZE TAPE command 291
- insert precompile/bind option 71, 409
- INSPECT command 293
- install DB2 command 869, 1045, 1127
- Install DB2 Information Center command 1117

- Install DB2 product command 675
- Install or update DB2 HA scripts 757
- installation images
  - reduce image size 869
- installFixPack command 1123
- interactive CLI command 753
- invoking 23
  - command help 21
- IPX/SPX node
  - uncataloging 617
- isolation levels
  - CHANGE ISOLATION LEVEL command 115
- isolation precompile/bind option 71, 409

## J

- Java Database Connectivity (JDBC)
  - package binder utility command 877

## K

- keepblanks file type modifier
  - IMPORT command 263
  - loading
    - LOAD command 357

## L

- LANGLEVEL precompile option
  - SQL92E 409
- level precompile option 409
- licenses
  - License Management Tool command 883
- line continuation character
  - command line processor (CLP) 3
- LIST ACTIVE DATABASES command 301
- LIST APPLICATIONS command 303
- LIST COMMAND OPTIONS command 305
- LIST DATABASE DIRECTORY command 307
- LIST DATABASE PARTITION GROUPS command 311
- LIST DBPARTITIONNUMS command 313
- LIST DCS APPLICATIONS command 315
- LIST DCS DIRECTORY command 317
- LIST DRDA INDOUBT TRANSACTIONS command 319
- LIST HISTORY command 321
- LIST INDOUBT TRANSACTIONS command 325
- List installed DB2 products and features command 899
- List Instances command 859
- List Logs Required for Rollforward Recovery command 887
- LIST NODE DIRECTORY command 329
- LIST ODBC DATA SOURCES command 333
- LIST PACKAGES command 335
- LIST PACKAGES/TABLES command 335
- LIST TABLES command 335
- LIST TABLESPACE CONTAINERS command 339
- LIST TABLESPACES command 341
- LIST UTILITIES command 355
- LOAD command
  - overview 357
- LOAD QUERY command 399
- load utility
  - temporary files
    - LOAD command 357
- loading
  - file to database table 357
  - file type modifiers for 357

- lobsinfile file type modifier
  - exporting 177
  - importing 263
  - loading 357
- local database directory
  - changing comments 113
- locks
  - resetting maximum to default 511
- logs
  - listing during roll forward 539
- longerror precompile option 409

## M

- Manage DB2 snapshot backup objects 721
- manage log files on tape command 1085
- Memory Tracker command 921
- message help
  - invoking 23
- messages
  - accessing help 9
  - precompile/bind option 71, 409
- Microsoft Cluster Server command 845
- Migrate explain tables command 803
- Migrate the DB2 Administration Server command 667
- migrate tools catalog database
  - db2tdbmgr command 1091
- Migrate XSR objects command 1109
- modifiers
  - file type
    - EXPORT command 177
    - IMPORT command 263
    - LOAD command 357
- monitoring
  - databases 219, 233
  - db2pd command 943
- moving data
  - between databases 263
  - delimiter restrictions 1173
- MQ Listener command 913
- multipage file allocation 789

## N

- naming conventions
  - database manager objects 1171
- NetBIOS
  - nodes
    - uncataloging 617
- no commit (NC) 115
- nochecklengths file type modifier
  - importing 263
  - loading 357
- node directories
  - deleting entries 617
- nodefaults file type modifier
  - importing 263
- nodes
  - SOCKS
    - CATALOG TCP/IP/TCP/IP4/TCP/IP6 NODE command 109
- nodoubledel file type modifier
  - exporting 177
  - importing 263
  - loading 357

- noeofchar file type modifier
  - importing 263
  - loading 357
- noheader file type modifier
  - loading 357
- NOLINEMACRO precompile option 409
- non-root-installed DB2 commands
  - configure
    - db2nrcfg 931
  - enable root features
    - db2rfe 933
  - instance update
    - db2nrupdt 935
- norowwarnings file type modifier
  - LOAD command 357
- notices 1185
- notypeid file type modifier
  - IMPORT command 263
- NULL string 3
- NULL value
  - SQL
    - command line processor representation 3
- nullindchar file type modifier
  - IMPORT command 357
  - LOAD command 263

## O

- online checking
  - for better optimization 1053
  - needed during customization 1053
  - restriction 1053
- Open DB2 Command Window command 755
- OPEN statement
  - run through the CLP 25
- optimization
  - REORG INDEXES/TABLE command 483
- optlevel precompile option 409
- ordering DB2 books 1178
- output precompile option 409
- owner precompile/bind option 71, 409

## P

- packages
  - precompile option 409
  - re-creating 451
- packeddecimal file type modifier 357
- pagefreespace file type modifier 357
- passwords
  - changing
    - ATTACH command 55
    - CONNECT statement 25
- performance
  - indexes
    - REORGCHK command 497
  - tables
    - reorganizing 483
    - REORGCHK command 497
- Windows
  - Performance Monitor registration tool command 1019
- performance counters registration utility command 1017
- phantom quiesce 445
- PING command
  - description 407

- PRECOMPILE command
  - description 409
- PREP command 409
- privileges
  - database
    - granted when creating 119
- problem determination
  - diagnostic tools
    - db2fodc 823
    - db2support 1073
  - information available 1183
  - tutorials 1183
- PRUNE HISTORY/LOGFILE command
  - without ADMIN\_CMD procedure 435
- PUT ROUTINE command 437

## Q

- qualifier precompile/bind option 71, 409
- QUERY CLIENT command 439
- queryopt precompile/bind option
  - BIND command 71
  - PRECOMPILE command 409
- quiesce
  - phantom 445
- QUIESCE command 441
- QUIESCE TABLESPACES FOR TABLE command 445
- QUIT command 449

## R

- read stability (RS)
  - changing 115
- Rebind all Packages command 1021
- REBIND command 451
- reclen file type modifier 263
  - loading 357
- RECOVER DATABASE command 455
- recovery
  - database 519
    - with roll forward 539
    - without roll forward 519
- REDISTRIBUTE DATABASE PARTITION GROUP
  - command 461
- REFRESH LDAP command 473
- REGISTER command 475
- REGISTER XMLSCHEMA command
  - syntax 479
- REGISTER XSROBJECT command
  - syntax 481
- Release Container Tag command 1103
- release precompile/bind option 71, 409
- Relocate Database command 1023
- Remove a DB2 Administration Server command 665
- Remove Instance command 853
- Remove main menu entries for DB2 tools command 1031
- REORG TABLE command 483
- REORGCHK command 497
- repeatable read (RR)
  - changing 115
- RESET ADMIN CONFIGURATION command 507
- RESET ALERT CONFIGURATION command 509
- RESET DATABASE CONFIGURATION command 511
- RESET DATABASE MANAGER CONFIGURATION
  - command 513
- Reset Database Performance Values command 1015

- RESET MONITOR command 515
- Reset rollforward pending state command 1029
- response files
  - generator
    - db2rspgn 1033
- RESTART DATABASE command 517
- RESTORE DATABASE command 519
- restoring
  - earlier versions of DB2 databases 519
- RESTRICTIVE clause of CREATE DATABASE statement 119
- return codes
  - command line processor (CLP) 19
- REWIND TAPE command 537
- ROLLFORWARD DATABASE command 539
- RUNCMD command 549
- RUNSTATS command
  - syntax 551

## S

- schemas
  - new databases 119
- SELECT statement
  - in EXPORT command 177
  - run through the CLP 25
- SET CLIENT command 567
- Set permissions for DB2 objects command 815
- SET RUNTIME DEGREE command 571
- SET SERVEROUTPUT command 573
- SET TABLESPACE CONTAINERS command 575
- SET TAPE POSITION command 579
- Set Up Windows Failover utility command 917
- SET UTIL\_IMPACT\_PRIORITY command 581
- SET WORKLOAD command 583
- SET WRITE command 585
- setup command 1127
- show current DAS level command 765
- Show DB2 Service Level command 881
- show product updates command 1105
- SIGALRM signal
  - starting database manager 587
- SIGINT signal
  - starting database manager 587
- SOCKS
  - node
    - parameter 109
- SQL and XQuery Explain Command 805
- SQL statements
  - accessing help 9
  - displaying help 1179
  - using command line 25
- sqlca precompile option 409
- sqlerror precompile/bind option 71, 409
- sqlflag precompile option 409
- sqlj command 1129
- SQLJ Profile Binder command 1047
- SQLJ Profile Printer command 1065
- SQLJ Translator command 1129
- sqlrules precompile option 409
- sqlwarn precompile/bind option 71, 409
- Start Control Center command 733
- START DATABASE MANAGER command 587
- Start DB2 command 1067
- Start DB2 Synchronizer command 1081
- Start DB2 system tray command 1083
- START HADR command 595
- Start Health Center command 841



- Start Instance Creation Interface command 871
- starting
  - DB2
    - db2start command 1067
- statistics
  - database 551
  - database manager 243
  - reorganizing indexes 497
  - REORGCHK 497
- STOP DATABASE MANAGER command 597
- Stop DB2 command 1071
- STOP HADR command 601
- stopping
  - DB2
    - db2stop command 1071
- storage
  - physical 483
- strdel precompile/bind option 71, 409
- striptblanks file type modifier 263, 357
- striptnulls file type modifier 263, 357
- subtableconvert file type modifier 357
- Switch default DB2 copy and database client interface copy command 1079
- syncpoint precompile option 409
- syntax 1135, 1139, 1141, 1143, 1145, 1151, 1155, 1157, 1159, 1161, 1163, 1165
  - description xiii
  - for command line processor SQL statements 25
- system catalogs
  - analyzing 731
- system database directory
  - changing comments 113
  - deleting entries 609
  - uncataloging 609

**T**

- tables
  - exporting to files 177
  - importing files 263
  - loading files to 357
  - reorganization
    - determining need for 497
    - REORG INDEXES/TABLE command 483
  - statistics
    - description 551
- TAKEOVER HADR command 603
- tape backup 61
- target precompile option 409
- TCP/IP
  - node
    - uncataloging 617
- temporary files
  - LOAD command 357
- TERMINATE command 607
- termination
  - abnormal 517
  - command line processor back-end process 607
  - normal 597
- terms and conditions
  - use of publications 1184
- text precompile/bind option 71, 409
- text search 1135, 1141, 1143, 1145, 1151, 1155, 1157, 1159, 1161, 1163, 1165
  - commands
    - ALTER INDEX 1135
    - CLEANUP FOR TEXT 1139

- text search (*continued*)
  - commands (*continued*)
    - CLEAR COMMAND LOCKS 1141
    - CLEAR EVENTS FOR INDEX 1143
    - CREATE INDEX 1145
    - DISABLE DATABASE FOR TEXT 1151
    - DROP INDEX 1155
    - ENABLE DATABASE FOR TEXT 1157
    - HELP 1159
    - START FOR TEXT 1161
    - STOP FOR TEXT 1163
    - UPDATE INDEX 1165
  - timeformat file type modifier 263, 357
  - timestampformat file type modifier
    - IMPORT command 263
    - LOAD command 357
  - totalfreepace file type modifier 357
  - Trace command 1093
  - traces
    - activating 1093
  - transform group precompile/bind option 71, 409
  - troubleshooting
    - db2pd command 943
    - online information 1183
    - tutorials 1183
  - true type font
    - requirement for command line processor 3
  - TSM
    - archived images 685
  - tutorials
    - problem determination 1183
    - troubleshooting 1183
    - Visual Explain 1183
  - Type-1 Index Identification Tool command 855

**U**

- UNCATALOG DATABASE command 609
- UNCATALOG DCS DATABASE command 611
- UNCATALOG LDAP DATABASE command 613
- UNCATALOG LDAP NODE command 615
- UNCATALOG NODE command 617
- UNCATALOG ODBC DATA SOURCE command 619
- uncataloging
  - database entries 609
  - host DCS database entries 611
  - system database directory 609
- uncommitted reads (UR)
  - changing 115
- Uninstall DB2 Information Center command 1115
- Uninstall DB2 products command 1101
- Uninstall DB2 products, features, or languages command 671
- UNQUIESCE command 621
- UPDATE ADMIN CONFIGURATION command 623
- UPDATE ALERT CONFIGURATION command 625
- UPDATE ALTERNATE SERVER FOR DATABASE command 631
- UPDATE ALTERNATE SERVER FOR LDAP DATABASE command 633
- UPDATE CLI CONFIGURATION command 635
- UPDATE COMMAND OPTIONS command 637
- UPDATE CONTACT command 639
- UPDATE CONTACTGROUP command 641
- UPDATE DATABASE CONFIGURATION command 643
- UPDATE DATABASE MANAGER CONFIGURATION command 647

- UPDATE HEALTH NOTIFICATION CONTACT LIST
  - command 649
- UPDATE HISTORY FILE command 651
- Update installed DB2 products command 1123
- update instances command 873
- UPDATE LDAP NODE command 653
- UPDATE MONITOR SWITCHES command 655
- UPDATE XMLSCHEMA command
  - syntax 657
- updates
  - DB2 Information Center 1180, 1181
  - Update DAS command 669
- UPGRADE DATABASE command 405
- upgrade instance command 861
- upgrade non-root instance command 937
- usedefaults file type modifier 263, 357
- Utility for Kernel Parameter Values command 939

## V

- validate precompile/bind option
  - BIND command 71
  - PRECOMPILE command 409
- versions
  - precompile option 409
- Visual Explain
  - tutorial 1183

## W

- WCHARTYPE precompiler option
  - description 409
- who should use this book xi
- workload management
  - SET WORKLOAD command 583
- workstations
  - remote
    - cataloging databases 91
    - uncataloging databases 609
    - uncataloging nodes 617

## X

- X/Open Backup Services API (XBSA)
  - interface 61
- XBSA (Backup Services APIs) option
  - BACKUP DATABASE command 61
- XML schemas
  - repository
    - ADD XMLSCHEMA DOCUMENT command 49
    - COMPLETE XMLSCHEMA command 117
    - REGISTER XMLSCHEMA command 479
    - REGISTER XSROBJECT command 481
    - UPDATE XMLSCHEMA command 657

## Z

- zoned decimal file type modifier 357





Printed in USA

SC27-2439-00



Spine information:

IBM DB2 9.7 for Linux, UNIX, and Windows

Command Reference

