

**DB2**

**IBM**

**DB2 Version 9**  
for Linux, UNIX, and Windows



**SQL Reference Volume 1**



**DB2®**

**IBM**

**DB2 Version 9**  
for Linux, UNIX, and Windows



**SQL Reference Volume 1**

Before using this information and the product it supports, be sure to read the general information under *Notices*.

#### **Edition Notice**

This document contains proprietary information of IBM. It is provided under a license agreement and is protected by copyright law. The information contained in this publication does not include any product warranties, and any statements provided in this manual should not be interpreted as such.

You can order IBM publications online or through your local IBM representative.

- To order publications online, go to the IBM Publications Center at [www.ibm.com/shop/publications/order](http://www.ibm.com/shop/publications/order)
- To find your local IBM representative, go to the IBM Directory of Worldwide Contacts at [www.ibm.com/planetwide](http://www.ibm.com/planetwide)

To order DB2 publications from DB2 Marketing and Sales in the United States or Canada, call 1-800-IBM-4YOU (426-4968).

When you send information to IBM, you grant IBM a nonexclusive right to use or distribute the information in any way it believes appropriate without incurring any obligation to you.

© Copyright International Business Machines Corporation 1993, 2006. All rights reserved.

US Government Users Restricted Rights – Use, duplication or disclosure restricted by GSA ADP Schedule Contract with IBM Corp.

DB2 9 BETA

---

# Contents

|   |           |
|---|-----------|
| <b>About this book.</b>   | <b>xv</b> |
| Who should use this book  | xv        |
| How this book is structured.  | xv        |
| A brief overview of Volume 2  | xvi       |
| How to read the syntax diagrams.  | xvi       |
| Conventions used in this manual   | xviii     |
| Error conditions  | xviii     |
| Highlighting conventions  | xviii     |
| Related documentation   | xix       |
| <br>  |           |
| <b>Chapter 1. Concepts</b>  | <b>1</b>  |
| Relational databases  | 1         |
| Structured Query Language (SQL)   | 1         |
| Queries and table expressions   | 1         |
| DB2 Call level interface (CLI) and open database connectivity (ODBC)        | 2         |
| Java database connectivity (JDBC) and embedded SQL for Java (SQLJ) programs | 2         |
| Schemas   | 3         |
| Tables  | 4         |
| Keys  | 5         |
| Constraints   | 5         |
| Unique constraints  | 6         |
| Referential constraints   | 6         |
| Table check constraints   | 9         |
| Informational constraints   | 9         |
| Indexes   | 10        |
| Triggers  | 10        |
| Views   | 12        |
| Aliases   | 12        |
| Packages  | 13        |
| Authorization, privileges, and object ownership                             | 13        |
| Catalog views   | 18        |
| Application processes, concurrency, and recovery.                           | 18        |
| Isolation levels  | 20        |
| Comparison of isolation levels  | 22        |
| Table spaces and other storage structures                                   | 23        |
| Character conversion  | 25        |
| Distributed relational databases.   | 27        |
| Remote unit of work   | 28        |
| Application-directed distributed unit of work                               | 31        |
| Data representation considerations.   | 35        |
| Event monitors  | 35        |
| Database partitioning across multiple database partitions                   | 36        |
| Large object behavior in partitioned tables                                 | 37        |
| DB2 federated systems   | 39        |
| Federated systems   | 39        |
| What is a data source?.   | 40        |
| The federated database  | 40        |
| The SQL compiler  | 40        |
| Wrappers and wrapper modules  | 41        |
| Server definitions and server options.                                      | 42        |
| User mappings   | 42        |
| Nicknames and data source objects   | 43        |
| Nickname column options   | 43        |
| Data type mappings  | 44        |
| The federated server  | 45        |

|  |           |
|--|-----------|
| Supported data sources . . . . .                                     | 45        |
| The federated database system catalog . . . . .                      | 48        |
| The query optimizer . . . . .  | 49        |
| Collating sequences. . . . .   | 49        |
| <b>Chapter 2. Language elements . . . . .</b>                        | <b>53</b> |
| Characters . . . . .   | 53        |
| Tokens . . . . .   | 55        |
| Identifiers . . . . .  | 57        |
| Naming conventions and implicit object name qualifications . . . . . | 57        |
| Aliases . . . . .  | 61        |
| Authorization IDs and authorization names . . . . .                  | 62        |
| Column names . . . . .   | 66        |
| References to host variables . . . . .                               | 71        |
| Data types. . . . .  | 78        |
| Data types. . . . .  | 78        |
| Numbers . . . . .  | 80        |
| Character strings . . . . .  | 81        |
| Graphic strings . . . . .  | 85        |
| Binary strings . . . . .   | 86        |
| Large objects (LOBs) . . . . .                                       | 87        |
| Datetime values . . . . .  | 88        |
| DATALINK values . . . . .  | 91        |
| XML values . . . . .   | 93        |
| User-defined types . . . . .   | 94        |
| Promotion of data types . . . . .                                    | 97        |
| Casting between data types . . . . .                                 | 99        |
| Assignments and comparisons. . . . .                                 | 105       |
| Rules for result data types . . . . .                                | 116       |
| Rules for string conversions . . . . .                               | 120       |
| Database partition-compatible data types . . . . .                   | 122       |
| Constants . . . . .  | 124       |
| Integer constants . . . . .  | 124       |
| Floating-point constants . . . . .                                   | 124       |
| Decimal constants . . . . .  | 125       |
| Character string constants . . . . .                                 | 125       |
| Hexadecimal constants . . . . .                                      | 125       |
| Graphic string constants. . . . .                                    | 126       |
| Special registers . . . . .  | 127       |
| Special registers . . . . .  | 127       |
| CURRENT CLIENT_ACCTNG . . . . .                                      | 129       |
| CURRENT CLIENT_APPLNAME . . . . .                                    | 130       |
| CURRENT CLIENT_USERID . . . . .                                      | 131       |
| CURRENT CLIENT_WRKSTNNAME . . . . .                                  | 132       |
| CURRENT DATE . . . . .   | 133       |
| CURRENT DBPARTITIONNUM . . . . .                                     | 134       |
| CURRENT DEFAULT TRANSFORM GROUP . . . . .                            | 135       |
| CURRENT DEGREE . . . . .   | 136       |
| CURRENT EXPLAIN MODE . . . . .                                       | 137       |
| CURRENT EXPLAIN SNAPSHOT . . . . .                                   | 138       |
| CURRENT FEDERATED ASYNCHRONY . . . . .                               | 139       |
| CURRENT IMPLICIT XMLPARSE OPTION . . . . .                           | 140       |
| CURRENT ISOLATION . . . . .  | 141       |
| CURRENT LOCK TIMEOUT . . . . .                                       | 142       |
| CURRENT MAINTAINED TABLE TYPES FOR OPTIMIZATION . . . . .            | 143       |
| CURRENT PACKAGE PATH . . . . .                                       | 144       |
| CURRENT PATH . . . . .   | 145       |
| CURRENT QUERY OPTIMIZATION . . . . .                                 | 146       |
| CURRENT REFRESH AGE . . . . .  | 147       |
| CURRENT SCHEMA . . . . .   | 148       |
| CURRENT SERVER . . . . .   | 149       |

|   |            |
|---|------------|
| CURRENT TIME . . . . .  | 150        |
| CURRENT TIMESTAMP . . . . .   | 151        |
| CURRENT TIMEZONE . . . . .  | 152        |
| CURRENT USER . . . . .  | 153        |
| SESSION_USER . . . . .  | 154        |
| SYSTEM_USER . . . . .   | 155        |
| USER . . . . .  | 156        |
| Functions . . . . .   | 157        |
| External, SQL, and sourced user-defined functions . . . . .             | 157        |
| Scalar, column, row, and table user-defined functions . . . . .         | 157        |
| Function signatures . . . . .   | 158        |
| Function resolution . . . . .   | 158        |
| Function invocation . . . . .   | 162        |
| Conservative binding semantics . . . . .                                | 162        |
| Methods . . . . .   | 165        |
| External and SQL user-defined methods . . . . .                         | 165        |
| Method signatures. . . . .  | 165        |
| Method resolution. . . . .  | 166        |
| Method invocation . . . . .   | 169        |
| Dynamic dispatch of methods . . . . .                                   | 170        |
| Expressions . . . . .   | 173        |
| Expressions . . . . .   | 173        |
| Datetime operations and durations . . . . .                             | 180        |
| CASE expressions . . . . .  | 185        |
| CAST specifications . . . . .   | 187        |
| XMLCAST specifications . . . . .  | 190        |
| Dereference operations . . . . .  | 192        |
| OLAP functions . . . . .  | 194        |
| Method invocation . . . . .   | 200        |
| Subtype treatment. . . . .  | 202        |
| Sequence reference . . . . .  | 203        |
| Predicates . . . . .  | 207        |
| Predicates . . . . .  | 207        |
| Search conditions . . . . .   | 208        |
| Basic predicate . . . . .   | 211        |
| Quantified predicate . . . . .  | 212        |
| BETWEEN predicate . . . . .   | 215        |
| EXISTS predicate . . . . .  | 216        |
| IN predicate. . . . .   | 217        |
| LIKE predicate . . . . .  | 219        |
| NULL predicate . . . . .  | 224        |
| TYPE predicate. . . . .   | 225        |
| VALIDATED predicate . . . . .   | 227        |
| XMLEXISTS predicate . . . . .   | 228        |
| <b>Chapter 3. Functions . . . . .</b>                                   | <b>231</b> |
| Functions overview . . . . .  | 231        |
| Supported functions and administrative SQL routines and views . . . . . | 233        |
| Aggregate functions . . . . .   | 258        |
| AVG . . . . .   | 259        |
| CORRELATION . . . . .   | 261        |
| COUNT . . . . .   | 262        |
| COUNT_BIG . . . . .   | 263        |
| COVARIANCE . . . . .  | 265        |
| GROUPING . . . . .  | 266        |
| MAX . . . . .   | 268        |
| MIN . . . . .   | 270        |
| XMLAGG . . . . .  | 271        |
| Regression functions . . . . .  | 273        |
| STDDEV . . . . .  | 276        |
| SUM . . . . .   | 277        |

|  |     |
|--|-----|
| VARIANCE . . . . .                     | 278 |
| Scalar functions . . . . .             | 279 |
| ABS or ABSVAL . . . . .                | 280 |
| ACOS . . . . .                         | 281 |
| ASCII . . . . .                        | 282 |
| ASIN . . . . .                         | 283 |
| ATAN . . . . .                         | 284 |
| ATAN2 . . . . .                        | 285 |
| ATANH . . . . .                        | 286 |
| BIGINT . . . . .                       | 287 |
| BLOB . . . . .                         | 289 |
| CEILING or CEIL . . . . .              | 290 |
| CHAR . . . . .                         | 291 |
| CHARACTER_LENGTH . . . . .             | 295 |
| CHR . . . . .                          | 297 |
| CLOB . . . . .                         | 298 |
| COALESCE . . . . .                     | 299 |
| CONCAT . . . . .                       | 300 |
| COS . . . . .                          | 301 |
| COSH . . . . .                         | 302 |
| COT . . . . .                          | 303 |
| DATAPARTITIONNUM . . . . .             | 304 |
| DATE . . . . .                         | 305 |
| DAY . . . . .                          | 306 |
| DAYNAME . . . . .                      | 307 |
| DAYOFWEEK . . . . .                    | 308 |
| DAYOFWEEK_ISO . . . . .                | 309 |
| DAYOFYEAR . . . . .                    | 310 |
| DAYS . . . . .                         | 311 |
| DBCLOB . . . . .                       | 312 |
| DBPARTITIONNUM . . . . .               | 313 |
| DECIMAL . . . . .                      | 315 |
| DECRYPT_BIN and DECRYPT_CHAR . . . . . | 319 |
| DEGREES . . . . .                      | 321 |
| DEREF . . . . .                        | 322 |
| DIFFERENCE . . . . .                   | 323 |
| DIGITS . . . . .                       | 324 |
| DOUBLE . . . . .                       | 325 |
| ENCRYPT . . . . .                      | 327 |
| EVENT_MON_STATE . . . . .              | 329 |
| EXP . . . . .                          | 330 |
| FLOAT . . . . .                        | 331 |
| FLOOR . . . . .                        | 332 |
| GETHINT . . . . .                      | 333 |
| GENERATE_UNIQUE . . . . .              | 334 |
| GRAPHIC . . . . .                      | 336 |
| HASHEDVALUE . . . . .                  | 338 |
| HEX . . . . .                          | 340 |
| HOURL . . . . .                        | 342 |
| IDENTITY_VAL_LOCAL . . . . .           | 343 |
| INSERT . . . . .                       | 347 |
| INTEGER . . . . .                      | 348 |
| JULIAN_DAY . . . . .                   | 350 |
| LCASE or LOWER . . . . .               | 351 |
| LCASE (SYSFUN schema) . . . . .        | 352 |
| LEFT . . . . .                         | 353 |
| LENGTH . . . . .                       | 354 |
| LN . . . . .                           | 356 |
| LOCATE . . . . .                       | 357 |
| LOG . . . . .                          | 360 |
| LOG10 . . . . .                        | 361 |



|                                 |     |
|---------------------------------|-----|
| LONG_VARCHAR . . . . .          | 362 |
| LONG_VARGRAPHIC . . . . .       | 363 |
| LTRIM . . . . .                 | 364 |
| LTRIM (SYSFUN schema) . . . . . | 365 |
| MICROSECOND . . . . .           | 366 |
| MIDNIGHT_SECONDS . . . . .      | 367 |
| MINUTE . . . . .                | 368 |
| MOD . . . . .                   | 369 |
| MONTH . . . . .                 | 370 |
| MONTHNAME . . . . .             | 371 |
| MULTIPLY_ALT . . . . .          | 372 |
| NULLIF . . . . .                | 374 |
| OCTET_LENGTH . . . . .          | 375 |
| POSITION . . . . .              | 376 |
| POSSTR . . . . .                | 379 |
| POWER . . . . .                 | 381 |
| QUARTER . . . . .               | 382 |
| RADIANS . . . . .               | 383 |
| RAISE_ERROR . . . . .           | 384 |
| RAND . . . . .                  | 385 |
| REAL . . . . .                  | 386 |
| REC2XML . . . . .               | 387 |
| REPEAT . . . . .                | 391 |
| REPLACE . . . . .               | 392 |
| RIGHT . . . . .                 | 393 |
| ROUND . . . . .                 | 394 |
| RTRIM . . . . .                 | 396 |
| RTRIM (SYSFUN schema) . . . . . | 397 |
| SECLABEL . . . . .              | 398 |
| SECLABEL_BY_NAME . . . . .      | 399 |
| SECLABEL_TO_CHAR . . . . .      | 400 |
| SECOND . . . . .                | 402 |
| SIGN . . . . .                  | 403 |
| SIN . . . . .                   | 404 |
| SINH . . . . .                  | 405 |
| SMALLINT . . . . .              | 406 |
| SOUNDEX . . . . .               | 407 |
| SPACE . . . . .                 | 408 |
| SQRT . . . . .                  | 409 |
| STRIP . . . . .                 | 410 |
| SUBSTR . . . . .                | 411 |
| SUBSTRING . . . . .             | 414 |
| TABLE_NAME . . . . .            | 417 |
| TABLE_SCHEMA . . . . .          | 418 |
| TAN . . . . .                   | 420 |
| TANH . . . . .                  | 421 |
| TIME . . . . .                  | 422 |
| TIMESTAMP . . . . .             | 423 |
| TIMESTAMP_FORMAT . . . . .      | 424 |
| TIMESTAMP_ISO . . . . .         | 426 |
| TIMESTAMPDIFF . . . . .         | 427 |
| TO_CHAR . . . . .               | 429 |
| TO_DATE . . . . .               | 430 |
| TRANSLATE . . . . .             | 431 |
| TRIM . . . . .                  | 433 |
| TRUNCATE or TRUNC . . . . .     | 435 |
| TYPE_ID . . . . .               | 436 |
| TYPE_NAME . . . . .             | 437 |
| TYPE_SCHEMA . . . . .           | 438 |
| UCASE or UPPER . . . . .        | 439 |
| VALUE . . . . .                 | 440 |

|   |            |
|---|------------|
| VARCHAR . . . . .                                     | 441        |
| VARCHAR_FORMAT . . . . .                              | 443        |
| VARGRAPHIC . . . . .                                  | 445        |
| WEEK . . . . .  | 447        |
| WEEK_ISO . . . . .                                    | 448        |
| XMLATTRIBUTES . . . . .                               | 449        |
| XMLCOMMENT . . . . .                                  | 451        |
| XMLCONCAT . . . . .                                   | 452        |
| XMLDOCUMENT . . . . .                                 | 454        |
| XMLELEMENT . . . . .                                  | 456        |
| XMLFOREST . . . . .                                   | 462        |
| XMLNAMESPACES . . . . .                               | 466        |
| XMLPARSE . . . . .                                    | 469        |
| XMLPI . . . . .                                       | 471        |
| XMLQUERY . . . . .                                    | 473        |
| XMLSERIALIZE . . . . .                                | 476        |
| XMLTEXT . . . . .                                     | 479        |
| XMLVALIDATE . . . . .                                 | 481        |
| XMLXSROBJECTID . . . . .                              | 485        |
| YEAR . . . . .  | 486        |
| Table functions . . . . .                             | 487        |
| XMLTABLE . . . . .                                    | 488        |
| User-defined functions . . . . .                      | 492        |
| <b>Chapter 4. Procedures . . . . .</b>                | <b>495</b> |
| Procedures overview . . . . .                         | 495        |
| XSR_ADDSCHEMADOC procedure . . . . .                  | 496        |
| XSR_COMPLETE procedure . . . . .                      | 498        |
| XSR_DTD procedure . . . . .                           | 499        |
| XSR_EXTENTITY procedure . . . . .                     | 501        |
| XSR_REGISTER procedure . . . . .                      | 503        |
| <b>Chapter 5. Queries . . . . .</b>                   | <b>505</b> |
| SQL queries . . . . .                                 | 505        |
| Subselect . . . . .                                   | 506        |
| select-clause . . . . .                               | 507        |
| from-clause . . . . .                                 | 510        |
| table-reference . . . . .                             | 510        |
| joined-table . . . . .                                | 518        |
| where-clause . . . . .                                | 520        |
| group-by-clause . . . . .                             | 521        |
| having-clause . . . . .                               | 526        |
| order-by-clause . . . . .                             | 527        |
| fetch-first-clause . . . . .                          | 530        |
| Examples of subselects . . . . .                      | 530        |
| Examples of joins . . . . .                           | 532        |
| Examples of grouping sets, cube, and rollup . . . . . | 535        |
| Fullselect . . . . .                                  | 543        |
| Examples of a fullselect . . . . .                    | 545        |
| Select-statement . . . . .                            | 548        |
| common-table-expression . . . . .                     | 548        |
| update-clause . . . . .                               | 553        |
| read-only-clause . . . . .                            | 554        |
| optimize-for-clause . . . . .                         | 554        |
| isolation-clause . . . . .                            | 555        |
| lock-request-clause . . . . .                         | 555        |
| Examples of a select-statement . . . . .              | 556        |
| <b>Appendix A. SQL and XQuery limits . . . . .</b>    | <b>559</b> |

|  |            |
|--|------------|
| <b>Appendix B. SQLCA (SQL communications area)</b> . . . . . | <b>567</b> |
| SQLCA field descriptions . . . . .                           | 567        |
| Error reporting . . . . .                                    | 570        |
| SQLCA usage in partitioned database systems . . . . .        | 571        |
| <br>   |            |
| <b>Appendix C. SQLDA (SQL descriptor area)</b> . . . . .     | <b>573</b> |
| SQLDA field descriptions . . . . .                           | 573        |
| Fields in the SQLDA header . . . . .                         | 574        |
| Fields in an occurrence of a base SQLVAR. . . . .            | 575        |
| Fields in an occurrence of a secondary SQLVAR. . . . .       | 576        |
| Effect of DESCRIBE on the SQLDA . . . . .                    | 578        |
| SQLTYPE and SQLLEN . . . . .                                 | 579        |
| Unrecognized and unsupported SQLTYPEs . . . . .              | 580        |
| Packed decimal numbers . . . . .                             | 581        |
| SQLLEN field for decimal . . . . .                           | 581        |
| <br>   |            |
| <b>Appendix D. Catalog views</b> . . . . .                   | <b>583</b> |
| System catalog views. . . . .                                | 583        |
| Road map to the catalog views . . . . .                      | 585        |
| SYSIBM.SYSDUMMY1 . . . . .                                   | 589        |
| SYSCAT.ATTRIBUTES . . . . .                                  | 590        |
| SYSCAT.BUFFERPOOLDBPARTITIONS . . . . .                      | 592        |
| SYSCAT.BUFFERPOOLS . . . . .                                 | 593        |
| SYSCAT.CASTFUNCTIONS . . . . .                               | 594        |
| SYSCAT.CHECKS . . . . .                                      | 595        |
| SYSCAT.COLAUTH . . . . .                                     | 596        |
| SYSCAT.COLCHECKS . . . . .                                   | 597        |
| SYSCAT.COLDIST . . . . .                                     | 598        |
| SYSCAT.COLGROUPCOLS . . . . .                                | 599        |
| SYSCAT.COLGROUPDIST . . . . .                                | 600        |
| SYSCAT.COLGROUPDISTCOUNTS . . . . .                          | 601        |
| SYSCAT.COLGROUPS . . . . .                                   | 602        |
| SYSCAT.COLIDENTATTRIBUTES . . . . .                          | 603        |
| SYSCAT.COLOPTIONS . . . . .                                  | 604        |
| SYSCAT.COLUMNS . . . . .                                     | 605        |
| SYSCAT.COLUSE . . . . .                                      | 610        |
| SYSCAT.CONSTDEP . . . . .                                    | 611        |
| SYSCAT.DATAPARTITIONEXPRESSION . . . . .                     | 612        |
| SYSCAT.DATAPARTITIONS . . . . .                              | 613        |
| SYSCAT.DATATYPES . . . . .                                   | 615        |
| SYSCAT.DBAUTH . . . . .                                      | 617        |
| SYSCAT.DBPARTITIONGROUPDEF . . . . .                         | 618        |
| SYSCAT.DBPARTITIONGROUPS . . . . .                           | 619        |
| SYSCAT.EVENTMONITORS . . . . .                               | 620        |
| SYSCAT.EVENTS . . . . .                                      | 622        |
| SYSCAT.EVENTTABLES . . . . .                                 | 623        |
| SYSCAT.FULLHIERARCHIES . . . . .                             | 624        |
| SYSCAT.FUNCMAPOPTIONS . . . . .                              | 625        |
| SYSCAT.FUNCMAPPARMOPTIONS . . . . .                          | 626        |
| SYSCAT.FUNCMAPPINGS . . . . .                                | 627        |
| SYSCAT.HIERARCHIES . . . . .                                 | 628        |
| SYSCAT.INDEXAUTH . . . . .                                   | 629        |
| SYSCAT.INDEXCOLUSE . . . . .                                 | 630        |
| SYSCAT.INDEXDEP . . . . .                                    | 631        |
| SYSCAT.INDEXES . . . . .                                     | 632        |
| SYSCAT.INDEXEXPLOITRULES . . . . .                           | 637        |
| SYSCAT.INDEXEXTENSIONDEP . . . . .                           | 638        |
| SYSCAT.INDEXEXTENSIONMETHODS . . . . .                       | 639        |
| SYSCAT.INDEXEXTENSIONPARMS . . . . .                         | 640        |
| SYSCAT.INDEXEXTENSIONS . . . . .                             | 641        |

|   |     |
|---|-----|
| SYSCAT.INDEXOPTIONS . . . . .                   | 642 |
| SYSCAT.INDEXXMLPATTERNS . . . . .               | 643 |
| SYSCAT.KEYCOLUSE . . . . .                      | 644 |
| SYSCAT.NAMEMAPPINGS . . . . .                   | 645 |
| SYSCAT.NICKNAMES . . . . .                      | 646 |
| SYSCAT.PACKAGEAUTH . . . . .                    | 649 |
| SYSCAT.PACKAGEDEP . . . . .                     | 650 |
| SYSCAT.PACKAGES . . . . .                       | 651 |
| SYSCAT.PARTITIONMAPS . . . . .                  | 656 |
| SYSCAT.PASSTHROUGH . . . . .                    | 657 |
| SYSCAT.PREDICATESPECS . . . . .                 | 658 |
| SYSCAT.REFERENCES . . . . .                     | 659 |
| SYSCAT.ROUTINEAUTH . . . . .                    | 660 |
| SYSCAT.ROUTINEDEP . . . . .                     | 661 |
| SYSCAT.ROUTINEOPTIONS . . . . .                 | 662 |
| SYSCAT.ROUTINEPARMOPTIONS . . . . .             | 663 |
| SYSCAT.ROUTINEPARMS . . . . .                   | 664 |
| SYSCAT.ROUTINES . . . . .                       | 666 |
| SYSCAT.ROUTINESFEDERATED . . . . .              | 674 |
| SYSCAT.SCHEMAAUTH . . . . .                     | 676 |
| SYSCAT.SCHEMATA . . . . .                       | 677 |
| SYSCAT.SECURITYLABELACCESS . . . . .            | 678 |
| SYSCAT.SECURITYLABELCOMPONENTELEMENTS . . . . . | 679 |
| SYSCAT.SECURITYLABELCOMPONENTS . . . . .        | 680 |
| SYSCAT.SECURITYLABELS . . . . .                 | 681 |
| SYSCAT.SECURITYPOLICIES . . . . .               | 682 |
| SYSCAT.SECURITYPOLICYCOMPONENTRULES . . . . .   | 683 |
| SYSCAT.SECURITYPOLICYEXEMPTIONS . . . . .       | 684 |
| SYSCAT.SURROGATEAUTHIDS . . . . .               | 685 |
| SYSCAT.SEQUENCEAUTH . . . . .                   | 686 |
| SYSCAT.SEQUENCES . . . . .                      | 687 |
| SYSCAT.SERVEROPTIONS . . . . .                  | 689 |
| SYSCAT.SERVERS . . . . .                        | 690 |
| SYSCAT.STATEMENTS . . . . .                     | 691 |
| SYSCAT.TABAUTH . . . . .                        | 692 |
| SYSCAT.TABCONST . . . . .                       | 694 |
| SYSCAT.TABDEP . . . . .                         | 695 |
| SYSCAT.TABDETACHEDDEP . . . . .                 | 697 |
| SYSCAT.TABLES . . . . .                         | 698 |
| SYSCAT.TABLESPACES . . . . .                    | 704 |
| SYSCAT.TABOPTIONS . . . . .                     | 706 |
| SYSCAT.TBSPACEAUTH . . . . .                    | 707 |
| SYSCAT.TRANSFORMS . . . . .                     | 708 |
| SYSCAT.TRIGDEP . . . . .                        | 709 |
| SYSCAT.TRIGGERS . . . . .                       | 710 |
| SYSCAT.TYPEMAPPINGS . . . . .                   | 712 |
| SYSCAT.USEROPTIONS . . . . .                    | 715 |
| SYSCAT.VIEWS . . . . .                          | 716 |
| SYSCAT.WRAPOPTIONS . . . . .                    | 717 |
| SYSCAT.WRAPPERS . . . . .                       | 718 |
| SYSCAT.XDBMAPGRAPHS . . . . .                   | 719 |
| SYSCAT.XDBMAPSHREDTREES . . . . .               | 720 |
| SYSCAT.XSROBJECTAUTH . . . . .                  | 721 |
| SYSCAT.XSROBJECTCOMPONENTS . . . . .            | 722 |
| SYSCAT.XSROBJECTDEP . . . . .                   | 723 |
| SYSCAT.XSROBJECTHIERARCHIES . . . . .           | 724 |
| SYSCAT.XSROBJECTS . . . . .                     | 725 |
| SYSSTAT.COLDIST . . . . .                       | 726 |
| SYSSTAT.COLGROUPDIST . . . . .                  | 727 |
| SYSSTAT.COLGROUPDISTCOUNTS . . . . .            | 728 |
| SYSSTAT.COLGROUPS . . . . .                     | 729 |

|   |            |
|---|------------|
| SYSSTAT.COLUMNS . . . . .   | 730        |
| SYSSTAT.INDEXES . . . . .   | 731        |
| SYSSTAT.ROUTINES . . . . .  | 734        |
| SYSSTAT.TABLES . . . . .  | 735        |
| <b>Appendix E. Federated systems . . . . .</b>                              | <b>737</b> |
| Valid server types in SQL statements . . . . .                              | 737        |
| BioRS wrapper . . . . .   | 737        |
| BLAST wrapper . . . . .   | 737        |
| CTLIB wrapper. . . . .  | 738        |
| DRDA wrapper. . . . .   | 738        |
| Entrez wrapper. . . . .   | 738        |
| Excel wrapper . . . . .   | 738        |
| HMMER wrapper . . . . .   | 738        |
| Informix wrapper . . . . .  | 739        |
| MSSQLODBC3 wrapper. . . . .   | 739        |
| NET8 wrapper . . . . .  | 739        |
| ODBC wrapper. . . . .   | 739        |
| OLE DB wrapper . . . . .  | 739        |
| Table-structured files wrapper. . . . .                                     | 739        |
| Teradata wrapper . . . . .  | 739        |
| Web services wrapper . . . . .  | 740        |
| WebSphere Business Integration wrapper . . . . .                            | 740        |
| XML wrapper . . . . .   | 740        |
| Nickname column options for federated systems . . . . .                     | 740        |
| Function mapping options for federated systems . . . . .                    | 747        |
| Server options for federated systems . . . . .                              | 748        |
| User mapping options for federated systems . . . . .                        | 763        |
| Wrapper options for federated systems. . . . .                              | 765        |
| Default forward data type mappings . . . . .                                | 767        |
| DB2 Database for Linux, UNIX, and Windows data sources . . . . .            | 767        |
| DB2 for iSeries data sources . . . . .                                      | 768        |
| DB2 for VM and VSE data sources . . . . .                                   | 768        |
| DB2 for z/OS data sources . . . . .   | 769        |
| Informix data sources . . . . .   | 769        |
| Microsoft SQL Server data sources . . . . .                                 | 770        |
| ODBC data sources . . . . .   | 772        |
| Oracle NET8 data sources . . . . .  | 773        |
| Sybase data sources . . . . .   | 773        |
| Teradata data sources. . . . .  | 774        |
| Default reverse data type mappings . . . . .                                | 775        |
| DB2 Database for Linux, UNIX, and Windows data sources . . . . .            | 775        |
| DB2 for iSeries data sources . . . . .                                      | 776        |
| DB2 for VM and VSE data sources . . . . .                                   | 776        |
| DB2 for z/OS data sources . . . . .   | 777        |
| Informix data sources . . . . .   | 777        |
| Microsoft SQL Server data sources . . . . .                                 | 778        |
| Oracle NET8 data sources . . . . .  | 779        |
| Sybase data sources . . . . .   | 779        |
| Teradata data sources. . . . .  | 780        |
| <b>Appendix F. The SAMPLE database and SQL Reference examples . . . . .</b> | <b>781</b> |
| <b>Appendix G. Reserved schema names and reserved words . . . . .</b>       | <b>783</b> |
| <b>Appendix H. Interaction of triggers and constraints . . . . .</b>        | <b>787</b> |
| <b>Appendix I. Explain tables . . . . .</b>                                 | <b>789</b> |
| Explain tables . . . . .  | 789        |
| EXPLAIN_ARGUMENT table . . . . .  | 790        |

|   |            |
|---|------------|
| EXPLAIN_DIAGNOSTIC table . . . . .  | 795        |
| EXPLAIN_DIAGNOSTIC_DATA table . . . . .   | 796        |
| EXPLAIN_INSTANCE table . . . . .  | 797        |
| EXPLAIN_OBJECT table. . . . .   | 800        |
| EXPLAIN_OPERATOR table . . . . .  | 803        |
| EXPLAIN_PREDICATE table . . . . .   | 805        |
| EXPLAIN_STATEMENT table . . . . .   | 808        |
| EXPLAIN_STREAM table . . . . .  | 810        |
| ADVISE_INDEX table . . . . .  | 812        |
| ADVISE_INSTANCE table . . . . .   | 815        |
| ADVISE_MQT table . . . . .  | 816        |
| ADVISE_PARTITION table . . . . .  | 817        |
| ADVISE_TABLE table . . . . .  | 818        |
| ADVISE_WORKLOAD table . . . . .   | 819        |
| <b>Appendix J. Explain register values. . . . .</b>   | <b>821</b> |
| <b>Appendix K. Exception tables . . . . .</b>   | <b>827</b> |
| Rules for creating an exception table . . . . .   | 827        |
| Handling rows in an exception table . . . . .   | 828        |
| Querying exception tables . . . . .   | 829        |
| <b>Appendix L. SQL statements allowed in routines . . . . .</b>                                       | <b>831</b> |
| <b>Appendix M. CALL invoked from a compiled statement . . . . .</b>                                   | <b>835</b> |
| <b>Appendix N. Japanese and traditional-Chinese extended UNIX code (EUC) considerations . . . . .</b> | <b>841</b> |
| Language elements . . . . .   | 841        |
| Characters . . . . .  | 841        |
| Tokens . . . . .  | 841        |
| Identifiers . . . . .   | 841        |
| Data types . . . . .  | 841        |
| Constants . . . . .   | 843        |
| Functions. . . . .  | 844        |
| Expressions . . . . .   | 844        |
| Predicates . . . . .  | 844        |
| Functions. . . . .  | 845        |
| LENGTH. . . . .   | 845        |
| SUBSTR . . . . .  | 845        |
| TRANSLATE . . . . .   | 845        |
| VARGRAPHIC . . . . .  | 845        |
| Statements . . . . .  | 846        |
| CONNECT . . . . .   | 846        |
| PREPARE . . . . .   | 846        |
| <b>Appendix O. Backus-Naur form (BNF) specifications for DATALINKs . . . . .</b>                      | <b>847</b> |
| <b>Appendix P. DB2 Database technical information . . . . .</b>                                       | <b>849</b> |
| Overview of the DB2 technical information . . . . .   | 849        |
| Documentation feedback . . . . .  | 849        |
| DB2 technical library in PDF format. . . . .  | 850        |
| Ordering printed DB2 books . . . . .  | 852        |
| Displaying SQL state help from the command line processor . . . . .                                   | 853        |
| Accessing different versions of the DB2 Information Center . . . . .                                  | 853        |
| Displaying topics in your preferred language in the DB2 Information Center . . . . .                  | 854        |
| Updating the DB2 Information Center installed on your computer or intranet server . . . . .           | 855        |
| DB2 Visual Explain tutorial. . . . .  | 856        |
| DB2 troubleshooting information . . . . .   | 857        |

|                                      |            |
|--------------------------------------|------------|
| Terms and Conditions . . . . .       | 857        |
| <b>Appendix Q. Notices . . . . .</b> | <b>859</b> |
| Trademarks . . . . .                 | 861        |
| <b>Index . . . . .</b>               | <b>863</b> |
| <b>Contacting IBM . . . . .</b>      | <b>883</b> |





---

## About this book

The SQL Reference in its two volumes defines the SQL language used by DB2<sup>®</sup> Database for Linux<sup>™</sup>, UNIX<sup>®</sup>, and Windows<sup>®</sup>. It includes:

- Information about relational database concepts, language elements, functions, and the forms of queries (Volume 1).
- Information about the syntax and semantics of SQL statements (Volume 2).

---

## Who should use this book

This book is intended for anyone who wants to use the Structured Query Language (SQL) to access a database. It is primarily for programmers and database administrators, but it can also be used by those who access databases through the command line processor (CLP).

This book is a reference rather than a tutorial. It assumes that you will be writing application programs and therefore presents the full functions of the database manager.

---

## How this book is structured

This book contains information about the following major topics:

- Chapter 1, "Concepts," on page 1 discusses the basic concepts of relational databases and SQL.
- Chapter 2, "Language elements," on page 53 describes the basic syntax of SQL and the language elements that are common to many SQL statements.
- Chapter 3, "Functions," on page 231 contains syntax diagrams, semantic descriptions, rules, and usage examples of SQL column and scalar functions.
- Chapter 4, "Procedures," on page 495 contains syntax diagrams, semantic descriptions, rules, and usage examples of procedures.
- Chapter 5, "Queries," on page 505 describes the various forms of a query.
- Appendix A, "SQL and XQuery limits," on page 559 lists SQL limitations.
- Appendix B, "SQLCA (SQL communications area)," on page 567 describes the SQLCA structure.
- Appendix C, "SQLDA (SQL descriptor area)," on page 573 describes the SQLDA structure.
- Appendix D, "Catalog views," on page 583 describes the system catalog views.
- Appendix E, "Federated systems," on page 737 describes options and type mappings for federated systems.
- Appendix F, "The SAMPLE database and SQL Reference examples," on page 781 introduces the SAMPLE database, which contains the tables that are used in many examples.
- Appendix G, "Reserved schema names and reserved words," on page 783 contains the reserved schema names and the reserved words for the IBM SQL and ISO/ANSI SQL99 and SQL2003 standards.
- Appendix H, "Interaction of triggers and constraints," on page 787 discusses the interaction of triggers and referential constraints.
- Appendix I, "Explain tables," on page 789 describes the explain tables.

## How this book is structured

- Appendix J, “Explain register values,” on page 821 describes the interaction of the CURRENT EXPLAIN MODE and CURRENT EXPLAIN SNAPSHOT special register values with each other and with the PREP and BIND commands.
- Appendix K, “Exception tables,” on page 827 contains information about user-created tables that are used with the SET INTEGRITY statement.
- Appendix L, “SQL statements allowed in routines,” on page 831 lists the SQL statements that are allowed to execute in routines with different SQL data access contexts.
- Appendix M, “CALL invoked from a compiled statement,” on page 835 describes the CALL statement that can be invoked from a compiled statement.
- Appendix N, “Japanese and traditional-Chinese extended UNIX code (EUC) considerations,” on page 841 lists considerations when using extended UNIX code (EUC) character sets.
- Appendix O, “Backus-Naur form (BNF) specifications for DATALINKs,” on page 847 contains the Backus-Naur form (BNF) specifications for DATALINKs.

## A brief overview of Volume 2

The second volume of the SQL Reference contains information about the syntax and semantics of SQL statements.

- “Statements” contains syntax diagrams, semantic descriptions, rules, and examples of all SQL statements.

---

## How to read the syntax diagrams

Throughout this book, syntax is described using the structure defined as follows:

Read the syntax diagrams from left to right and top to bottom, following the path of the line.

The ►— symbol indicates the beginning of a syntax diagram.

The —► symbol indicates that the syntax is continued on the next line.

The ►— symbol indicates that the syntax is continued from the previous line.

The —◄ symbol indicates the end of a syntax diagram.

Syntax fragments start with the |— symbol and end with the —| symbol.

Required items appear on the horizontal line (the main path).

►—*required\_item*—◄

Optional items appear below the main path.

►—*required\_item*—  
    └—*optional\_item*—┘

If an optional item appears above the main path, that item has no effect on execution, and is used only for readability.

## How to read the syntax diagrams



If you can choose from two or more items, they appear in a stack.

If you *must* choose one of the items, one item of the stack appears on the main path.

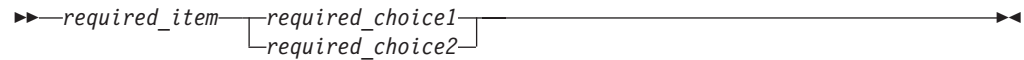

If choosing one of the items is optional, the entire stack appears below the main path.

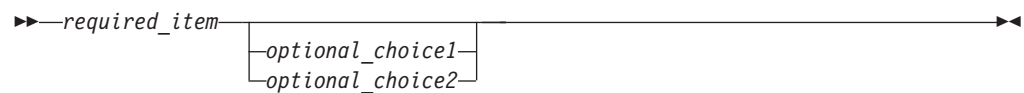

If one of the items is the default, it will appear above the main path, and the remaining choices will be shown below.

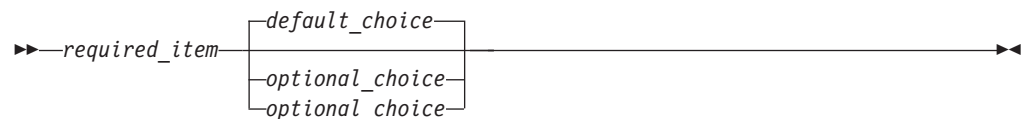

An arrow returning to the left, above the main line, indicates an item that can be repeated. In this case, repeated items must be separated by one or more blanks.

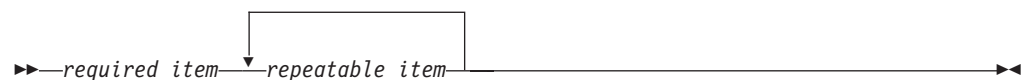

If the repeat arrow contains a comma, you must separate repeated items with a comma.



A repeat arrow above a stack indicates that you can make more than one choice from the stacked items or repeat a single choice.

Keywords appear in uppercase (for example, `FROM`). They must be spelled exactly as shown. Variables appear in lowercase (for example, `column-name`). They represent user-supplied names or values in the syntax.

If punctuation marks, parentheses, arithmetic operators, or other such symbols are shown, you must enter them as part of the syntax.

## How to read the syntax diagrams

Sometimes a single variable represents a larger fragment of the syntax. For example, in the following diagram, the variable `parameter-block` represents the whole syntax fragment that is labeled **parameter-block**:



### parameter-block:



Adjacent segments occurring between “large bullets” (●) may be specified in any sequence.



The above diagram shows that `item2` and `item3` may be specified in either order. Both of the following are valid:

```
required_item item1 item2 item3 item4
required_item item1 item3 item2 item4
```

---

## Conventions used in this manual

This section specifies some conventions that are used consistently throughout this manual.

### Error conditions

An error condition is indicated within the text of the manual by listing the SQLSTATE associated with the error in parentheses. For example:

A duplicate signature returns an SQL error (SQLSTATE 42723).

### Highlighting conventions

The following conventions are used in this book.

|                |   |
|----------------|---|
| <b>Bold</b>    | Indicates commands, keywords, and other items whose names are predefined by the system.   |
| <i>Italics</i> | Indicates one of the following: <ul style="list-style-type: none"><li>Names or values (variables) that must be supplied by the user</li><li>General emphasis</li><li>The introduction of a new term</li><li>A reference to another source of information</li></ul>  |
| Monospace      | Indicates one of the following: <ul style="list-style-type: none"><li>Files and directories</li><li>Information that you are instructed to type at a command prompt or in a window</li><li>Examples of specific data values</li><li>Examples of text similar to what might be displayed by the system</li><li>Examples of system messages</li></ul> |

---

## Related documentation

The following publications might prove useful when you are preparing applications:

- *Administration Guide*
  - Contains information required to design, implement, and maintain a database that is to be accessed either locally or in a client/server environment
- *Getting Started with Database Application Development*
  - Provides an introduction to DB2 application development, including platform prerequisites; supported development software; and guidance on the benefits and limitations of the supported programming APIs.
- *SQL Guide*
  - Contains information that explains how to design and create databases and database objects including tables, constraints, triggers, views, and user-defined SQL stored procedures and functions. It also explains how to query and modify data, and how to control access to database objects.
- *DB2 Universal Database for iSeries™ SQL Reference*
  - This book defines SQL as supported by DB2 Query Manager and SQL Development Kit on iSeries (AS/400®). It contains reference information for the tasks of system administration, database administration, application programming, and operation. This manual includes syntax, usage notes, keywords, and examples for each of the SQL statements used on iSeries (AS/400) systems running DB2.
- *DB2 Universal Database for z/OS® and OS/390® SQL Reference*
  - This book defines SQL used in DB2 for z/OS (OS/390). It provides query forms, SQL statements, SQL procedure statements, DB2 limits, SQLCA, SQLDA, catalog tables, and SQL reserved words for z/OS systems running DB2.
- *DB2 Spatial Extender User's Guide and Reference*
  - This book discusses how to write applications to create and use a geographic information system (GIS). Creating and using a GIS involves supplying a database with resources and then querying the data to obtain information such as locations, distances, and distributions within areas.
- *IBM SQL Reference*
  - This book contains all the common elements of SQL that span IBM's database products. It provides limits and rules that assist in preparing portable programs using IBM databases. This manual provides a list of SQL extensions and incompatibilities among the following standards and products: SQL92E, XPG4-SQL, IBM-SQL, and the IBM relational database products.
- *American National Standard X3.135-1992, Database Language SQL*
  - Contains the ANSI standard definition of SQL.
- *ISO/IEC 9075:1992, Database Language SQL*
  - Contains the 1992 ISO standard definition of SQL.
- *ISO/IEC 9075-2:1999, Database Language SQL -- Part 2: Foundation (SQL/Foundation)*
  - Contains a large portion of the 1999 ISO standard definition of SQL.
- *ISO/IEC 9075-4:1999, Database Language SQL -- Part 4: Persistent Stored Modules (SQL/PSM)*
  - Contains the 1999 ISO standard definition for SQL procedure control statements.

## Related documentation

- *ISO/IEC 9075-5:1999, Database Language SQL -- Part 4: Host Language Bindings (SQL/Bindings)*
  - Contains the 1999 ISO standard definition for host language bindings and dynamic SQL.

---

## Chapter 1. Concepts

This chapter provides a high-level view of concepts that are important to understand when using Structured Query Language (SQL). The reference material contained in the rest of this manual provides a more detailed view.

---

### Relational databases

A *relational database* is a database that is treated as a set of tables and manipulated in accordance with the relational model of data. It contains a set of objects used to store, manage, and access data. Examples of such objects are tables, views, indexes, functions, triggers, and packages. Objects can be either defined by the system (system-defined objects) or defined by the user (user-defined objects).

A *partitioned* relational database is a relational database whose data is managed across multiple database partitions. This separation of data across database partitions is transparent to users of most SQL statements. However, some data definition language (DDL) statements take database partition information into consideration (for example, CREATE DATABASE PARTITION GROUP). Data definition language is the subset of SQL statements used to describe data relationships in a database.

A *federated* database is a relational database whose data is stored in multiple data sources (such as separate relational databases). The data appears as if it were all in a single large database and can be accessed through traditional SQL queries. Changes to the data can be explicitly directed to the appropriate data source.

---

### Structured Query Language (SQL)

SQL is a standardized language for defining and manipulating data in a relational database. In accordance with the relational model of data, the database is treated as a set of tables, relationships are represented by values in tables, and data is retrieved by specifying a result table that can be derived from one or more base tables.

SQL statements are executed by a database manager. One of the functions of the database manager is to transform the specification of a result table into a sequence of internal operations that optimize data retrieval. The transformation occurs in two phases: preparation and binding.

All executable SQL statements must be prepared before they can be executed. The result of preparation is the executable or operational form of the statement. The method of preparing an SQL statement and the persistence of its operational form distinguish static SQL from dynamic SQL.

---

### Queries and table expressions

A *query* is a component of certain SQL statements; it specifies a (temporary) result table.

## Queries and table expressions

A *table expression* creates a temporary result table from a simple query. Clauses further refine the result table. For example, you can use a table expression as a query to select all of the managers from several departments, specify that they must have over 15 years of working experience, and be located at the New York branch office.

A *common table expression* is like a temporary view within a complex query. It can be referenced in other places within the query, and can be used in place of a view. Each use of a specific common table expression within a complex query shares the same temporary view.

Recursive use of a common table expression within a query can be used to support applications such as airline reservation systems, bill of materials (BOM) generators, and network planning.

### Related reference:

- “Select-statement” on page 548
- “SQL queries” on page 505

---

## DB2 Call level interface (CLI) and open database connectivity (ODBC)

The DB2 call level interface is an application programming interface that provides functions for processing dynamic SQL statements to application programs. CLI programs can also be compiled using an open database connectivity Software Developer’s Kit (available from Microsoft® or other vendors), which enables access to ODBC data sources. Unlike embedded SQL, this interface requires no precompilation. Applications can be run against a variety of databases without having to be compiled against each of these databases. Applications use procedure calls at run time to connect to databases, issue SQL statements, and retrieve data and status information.

The DB2 CLI interface provides many features not available in embedded SQL. For example:

- CLI provides function calls that support a way of querying database catalogs that is consistent across the DB2 family. This reduces the need to write catalog queries that must be tailored to specific database servers.
- CLI provides the ability to scroll through a cursor:
  - Forward by one or more rows
  - Backward by one or more rows
  - Forward from the first row by one or more rows
  - Backward from the last row by one or more rows
  - From a previously stored location in the cursor.
- Stored procedures called from application programs that were written using CLI can return result sets to those programs.

---

## Java database connectivity (JDBC) and embedded SQL for Java (SQLJ) programs

DB2 implements two standards-based Java™ programming APIs: Java database connectivity (JDBC) and embedded SQL for Java (SQLJ). Both can be used to create Java applications and applets that access DB2:



## Java database connectivity (JDBC) and embedded SQL for Java (SQLJ) programs

- JDBC calls are translated into DB2 CLI calls through Java native methods. JDBC requests flow from the DB2 client through DB2 CLI to the DB2 server. JDBC cannot use static SQL.
- SQLJ applications use JDBC as a foundation for such tasks as connecting to databases and handling SQL errors, but can also contain embedded static SQL statements in the SQLJ source files. An SQLJ source file must be translated by the SQLJ translator before the resulting Java source code can be compiled.

---

## Schemas

A *schema* is a collection of named objects; it provides a way to group those objects logically. A schema is also a name qualifier; it provides a way to use the same natural name for several objects, and to prevent ambiguous references to those objects; for example, the schema names 'INTERNAL' and 'EXTERNAL' make it easy to distinguish two different SALES tables (INTERNAL.SALES, EXTERNAL.SALES).

Schemas also enable multiple applications to store data in a single database without encountering namespace collisions.

A schema is distinct from, and should not be confused with, an *XML schema*, which is a standard that describes the structure and validates the content of XML documents.

A schema can contain tables, views, nicknames, triggers, functions, packages, and other objects. A schema is itself a database object. It is explicitly created using the CREATE SCHEMA statement, with the current user or a specified authorization ID recorded as the schema owner. It can also be implicitly created when another object is created, if the user has IMPLICIT\_SCHEMA database authority.

A *schema name* is used as the high order part of a two-part object name. If the object is specifically qualified with a schema name when created, the object is assigned to that schema. If no schema name is specified when the object is created, the default schema name is used.

For example, a user with DBADM authority creates a schema called C for user A:

```
CREATE SCHEMA C AUTHORIZATION A
```

User A can then issue the following statement to create a table called X in schema C (provided that user A has the CREATETAB database authority):

```
CREATE TABLE C.X (COL1 INT)
```

Some schema names are reserved. For example, built-in functions belong to the SYSIBM schema, and the pre-installed user-defined functions belong to the SYSFUN schema.

When a database is created, all users have IMPLICIT\_SCHEMA authority. This allows any user to create objects in any schema that does not already exist. An implicitly-created schema allows any user to create other objects in this schema. The ability to create aliases, distinct types, functions, and triggers is extended to implicitly-created schemas. The default privileges on an implicitly-created schema provide backward compatibility with previous versions.

If IMPLICIT\_SCHEMA authority is revoked from PUBLIC, schemas can be explicitly created using the CREATE SCHEMA statement, or implicitly created by

## Schemas

users (such as those with DBADM authority) who have been granted IMPLICIT\_SCHEMA authority. Although revoking IMPLICIT\_SCHEMA authority from PUBLIC increases control over the use of schema names, it can result in authorization errors when existing applications attempt to create objects.

Schemas also have privileges, allowing the schema owner to control which users have the privilege to create, alter, copy, and drop objects in the schema. This provides a way to control the manipulation of a subset of objects in the database. A schema owner is initially given all of these privileges on the schema, with the ability to grant the privileges to others. An implicitly-created schema is owned by the system, and all users are initially given the privilege to create objects in such a schema. A user with SYSADM or DBADM authority can change the privileges that are held by users on any schema. Therefore, access to create, alter, copy, and drop objects in any schema (even one that was implicitly created) can be controlled.

### Related concepts:

- “Grouping objects by schema” in *Administration Guide: Implementation*
- “Schema privileges” in *Administration Guide: Implementation*

### Related tasks:

- “Creating a schema” in *Administration Guide: Implementation*

### Related reference:

- Appendix G, “Reserved schema names and reserved words,” on page 783

---

## Tables

Tables are logical structures maintained by the database manager. Tables are made up of columns and rows. The rows are not necessarily ordered within a table (order is determined by the application program). At the intersection of every column and row is a specific data item called a *value*. A *column* is a set of values of the same type or one of its subtypes. A *row* is a sequence of values arranged so that the *n*th value is a value of the *n*th column of the table.

A *base table* is created with the CREATE TABLE statement and is used to hold persistent user data. A *result table* is a set of rows that the database manager selects or generates from one or more base tables to satisfy a query.

A *summary table* is a table defined by a query that is also used to determine the data in the table. Summary tables can be used to improve the performance of queries. If the database manager determines that a portion of a query can be resolved using a summary table, the database manager can rewrite the query to use the summary table. This decision is based on database configuration settings, such as the CURRENT REFRESH AGE and the CURRENT QUERY OPTIMIZATION special registers.

A table can define the data type of each column separately, or base the types on the attributes of a user-defined structured type. This is called a *typed table*. A user-defined structured type may be part of a type hierarchy. A *subtype* inherits attributes from its *supertype*. Similarly, a typed table can be part of a table hierarchy. A *subtable* inherits columns from its *supertable*. Note that the term *subtype* applies to a user-defined structured type and all user-defined structured types that are below it in the type hierarchy. A *proper subtype* of a structured type T is a structured type below T in the type hierarchy. Similarly, the term *subtable* applies to

a typed table and all typed tables that are below it in the table hierarchy. A *proper subtable* of a table T is a table below T in the table hierarchy.

A *declared temporary table* is created with a DECLARE GLOBAL TEMPORARY TABLE statement and is used to hold temporary data on behalf of a single application. This table is dropped implicitly when the application disconnects from the database.

---

## Keys

A *key* is a set of columns that can be used to identify or access a particular row or rows. The key is identified in the description of a table, index, or referential constraint. The same column can be part of more than one key.

A key that is composed of more than one column is called a *composite key*. In a table with a composite key, the order of the columns within the composite key is not constrained by the order of the columns within the table. The *value* of a composite key denotes a composite value. Thus, a rule such as “the value of the foreign key must be equal to the value of the primary key” means that each component of the value of the foreign key must be equal to the corresponding component of the value of the primary key.

A *unique key* is a key that is constrained so that no two of its values are equal. The columns of a unique key cannot contain null values. The constraint is enforced by the database manager during the execution of any operation that changes data values, such as INSERT or UPDATE. The mechanism used to enforce the constraint is called a *unique index*. Thus, every unique key is a key of a unique index. Such an index is also said to have the UNIQUE attribute.

A *primary key* is a special case of a unique key. A table cannot have more than one primary key.

A *foreign key* is a key that is specified in the definition of a referential constraint.

A *distribution key* is a key that is part of the definition of a table in a partitioned database. The distribution key is used to determine the database partition on which the row of data is stored. If a distribution key is defined, unique keys and primary keys must include the same columns as the distribution key, but can have additional columns. A table cannot have more than one distribution key.

A *table partitioning key* is an ordered set of one or more columns in a table. The values in the table partitioning key columns are used to determine the data partition to which each table row belongs.

---

## Constraints

A *constraint* is a rule that the database manager enforces.

There are four types of constraints:

- A *unique constraint* is a rule that forbids duplicate values in one or more columns within a table. Unique and primary keys are the supported unique constraints. For example, a unique constraint can be defined on the supplier identifier in the supplier table to ensure that the same supplier identifier is not given to two suppliers.

## Constraints

- A *referential constraint* is a logical rule about values in one or more columns in one or more tables. For example, a set of tables shares information about a corporation's suppliers. Occasionally, a supplier's name changes. You can define a referential constraint stating that the ID of the supplier in a table must match a supplier ID in the supplier information. This constraint prevents insert, update, or delete operations that would otherwise result in missing supplier information.
- A *table check constraint* sets restrictions on data added to a specific table. For example, a table check constraint can ensure that the salary level for an employee is at least \$20,000 whenever salary data is added or updated in a table containing personnel information.
- An *informational constraint* is a rule that can be used by the SQL compiler, but that is not enforced by the database manager.

Referential and table check constraints can be turned on or off. It is generally a good idea, for example, to turn off the enforcement of a constraint when large amounts of data are loaded into a database.

## Unique constraints

A *unique constraint* is the rule that the values of a key are valid only if they are unique within a table. Unique constraints are optional and can be defined in the CREATE TABLE or ALTER TABLE statement using the PRIMARY KEY clause or the UNIQUE clause. The columns specified in a unique constraint must be defined as NOT NULL. The database manager uses a unique index to enforce the uniqueness of the key during changes to the columns of the unique constraint.

A table can have an arbitrary number of unique constraints, with at most one unique constraint defined as the primary key. A table cannot have more than one unique constraint on the same set of columns.

A unique constraint that is referenced by the foreign key of a referential constraint is called the *parent key*.

When a unique constraint is defined in a CREATE TABLE statement, a unique index is automatically created by the database manager and designated as a primary or unique system-required index.

When a unique constraint is defined in an ALTER TABLE statement and an index exists on the same columns, that index is designated as unique and system-required. If such an index does not exist, the unique index is automatically created by the database manager and designated as a primary or unique system-required index.

Note that there is a distinction between defining a unique constraint and creating a unique index. Although both enforce uniqueness, a unique index allows nullable columns and generally cannot be used as a parent key.

## Referential constraints

*Referential integrity* is the state of a database in which all values of all foreign keys are valid. A *foreign key* is a column or a set of columns in a table whose values are required to match at least one primary key or unique key value of a row in its parent table. A *referential constraint* is the rule that the values of the foreign key are valid only if one of the following conditions is true:

- They appear as values of a parent key.
- Some component of the foreign key is null.

The table containing the parent key is called the *parent table* of the referential constraint, and the table containing the foreign key is said to be a *dependent* of that table.

Referential constraints are optional and can be defined in the CREATE TABLE statement or the ALTER TABLE statement. Referential constraints are enforced by the database manager during the execution of INSERT, UPDATE, DELETE, ALTER TABLE, ADD CONSTRAINT, and SET INTEGRITY statements.

Referential constraints with a delete or an update rule of RESTRICT are enforced before all other referential constraints. Referential constraints with a delete or an update rule of NO ACTION behave like RESTRICT in most cases.

Note that referential constraints, check constraints, and triggers can be combined.

Referential integrity rules involve the following concepts and terminology:

**Parent key**

A primary key or a unique key of a referential constraint.

**Parent row**

A row that has at least one dependent row.

**Parent table**

A table that contains the parent key of a referential constraint. A table can be a parent in an arbitrary number of referential constraints. A table that is the parent in a referential constraint can also be the dependent in a referential constraint.

**Dependent table**

A table that contains at least one referential constraint in its definition. A table can be a dependent in an arbitrary number of referential constraints. A table that is the dependent in a referential constraint can also be the parent in a referential constraint.

**Descendent table**

A table is a descendent of table T if it is a dependent of T or a descendent of a dependent of T.

**Dependent row**

A row that has at least one parent row.

**Descendent row**

A row is a descendent of row r if it is a dependent of r or a descendent of a dependent of r.

**Referential cycle**

A set of referential constraints such that each table in the set is a descendent of itself.

**Self-referencing table**

A table that is a parent and a dependent in the same referential constraint. The constraint is called a *self-referencing constraint*.

**Self-referencing row**

A row that is a parent of itself.

**Insert rule**

The insert rule of a referential constraint is that a non-null insert value of the foreign key must match some value of the parent key of the parent table. The

## Constraints

value of a composite foreign key is null if any component of the value is null. This rule is implicit when a foreign key is specified.

### Update rule

The update rule of a referential constraint is specified when the referential constraint is defined. The choices are `NO ACTION` and `RESTRICT`. The update rule applies when a row of the parent or a row of the dependent table is updated.

In the case of a parent row, when a value in a column of the parent key is updated, the following rules apply:

- If any row in the dependent table matches the original value of the key, the update is rejected when the update rule is `RESTRICT`.
- If any row in the dependent table does not have a corresponding parent key when the update statement is completed (excluding `AFTER` triggers), the update is rejected when the update rule is `NO ACTION`.

In the case of a dependent row, the `NO ACTION` update rule is implicit when a foreign key is specified. `NO ACTION` means that a non-null update value of a foreign key must match some value of the parent key of the parent table when the update statement is completed.

The value of a composite foreign key is null if any component of the value is null.

### Delete rule

The delete rule of a referential constraint is specified when the referential constraint is defined. The choices are `NO ACTION`, `RESTRICT`, `CASCADE`, or `SET NULL`. `SET NULL` can be specified only if some column of the foreign key allows null values.

The delete rule of a referential constraint applies when a row of the parent table is deleted. More precisely, the rule applies when a row of the parent table is the object of a delete or propagated delete operation (defined below), and that row has dependents in the dependent table of the referential constraint. Consider an example where `P` is the parent table, `D` is the dependent table, and `p` is a parent row that is the object of a delete or propagated delete operation. The delete rule works as follows:

- With `RESTRICT` or `NO ACTION`, an error occurs and no rows are deleted.
- With `CASCADE`, the delete operation is propagated to the dependents of `p` in table `D`.
- With `SET NULL`, each nullable column of the foreign key of each dependent of `p` in table `D` is set to null.

Each referential constraint in which a table is a parent has its own delete rule, and all applicable delete rules are used to determine the result of a delete operation. Thus, a row cannot be deleted if it has dependents in a referential constraint with a delete rule of `RESTRICT` or `NO ACTION`, or the deletion cascades to any of its descendents that are dependents in a referential constraint with the delete rule of `RESTRICT` or `NO ACTION`.

The deletion of a row from parent table `P` involves other tables and can affect rows of these tables:

- If table `D` is a dependent of `P` and the delete rule is `RESTRICT` or `NO ACTION`, then `D` is involved in the operation but is not affected by the operation.

- If D is a dependent of P and the delete rule is SET NULL, then D is involved in the operation, and rows of D can be updated during the operation.
- If D is a dependent of P and the delete rule is CASCADE, then D is involved in the operation and rows of D can be deleted during the operation.  
If rows of D are deleted, then the delete operation on P is said to be propagated to D. If D is also a parent table, then the actions described in this list apply, in turn, to the dependents of D.

Any table that can be involved in a delete operation on P is said to be *delete-connected* to P. Thus, a table is delete-connected to table P if it is a dependent of P, or a dependent of a table to which delete operations from P cascade.

The following restrictions apply to delete-connected relationships:

- When a table is delete-connected to itself in a referential cycle of more than one table, the cycle must not contain a delete rule of either RESTRICT or SET NULL.
- A table must not both be a dependent table in a CASCADE relationship (self-referencing or referencing another table) and have a self-referencing relationship with a delete rule of either RESTRICT or SET NULL.
- When a table is delete-connected to another table through multiple relationships where such relationships have overlapping foreign keys, these relationships must have the same delete rule and none of these can be SET NULL.
- When a table is delete-connected to another table through multiple relationships where one of the relationships is specified with delete rule SET NULL, the foreign key definition of this relationship must not contain any distribution key or MDC key column.
- When two tables are delete-connected to the same table through CASCADE relationships, the two tables must not be delete-connected to each other where the delete connected paths end with delete rule RESTRICT or SET NULL.

### Table check constraints

A *table check constraint* is a rule that specifies the values allowed in one or more columns of every row in a table. A constraint is optional, and can be defined using the CREATE TABLE or the ALTER TABLE statement. Specifying table check constraints is done through a restricted form of a search condition. One of the restrictions is that a column name in a table check constraint on table T must identify a column of table T.

A table can have an arbitrary number of table check constraints. A table check constraint is enforced by applying its search condition to each row that is inserted or updated. An error occurs if the result of the search condition is false for any row.

When one or more table check constraints is defined in the ALTER TABLE statement for a table with existing data, the existing data is checked against the new condition before the ALTER TABLE statement completes. The SET INTEGRITY statement can be used to put the table in *set integrity pending* state, which allows the ALTER TABLE statement to proceed without checking the data.

### Informational constraints

An *informational constraint* is a rule that can be used by the SQL compiler to improve the access path to data. Informational constraints are not enforced by the database manager, and are not used for additional verification of data; rather, they are used to improve query performance.

## Constraints

Use the CREATE TABLE or ALTER TABLE statement to define a referential or table check constraint, specifying constraint attributes that determine whether or not the database manager is to enforce the constraint and whether or not the constraint is to be used for query optimization.

### Related reference:

- Appendix H, “Interaction of triggers and constraints,” on page 787
- “SET INTEGRITY statement” in *SQL Reference, Volume 2*

---

## Indexes

An *index* is an ordered set of pointers to rows in a base table. Each index is based on the values of data in one or more table columns. An index is an object that is separate from the data in the table. When an index is created, the database manager builds this object and maintains it automatically.

Indexes are used by the database manager to:

- Improve performance. In most cases, access to data is faster with an index. Although an index cannot be created for a view, an index created for the table on which a view is based can sometimes improve the performance of operations on that view.
- Ensure uniqueness. A table with a unique index cannot have rows with identical keys.

---

## Triggers

A *trigger* defines a set of actions that are performed in response to an insert, update, or delete operation on a specified table. When such an SQL operation is executed, the trigger is said to have been *activated*.

Triggers are optional and are defined using the CREATE TRIGGER statement.

Triggers can be used, along with referential constraints and check constraints, to enforce data integrity rules. Triggers can also be used to cause updates to other tables, automatically generate or transform values for inserted or updated rows, or invoke functions to perform tasks such as issuing alerts.

Triggers are a useful mechanism for defining and enforcing *transitional* business rules, which are rules that involve different states of the data (for example, a salary that cannot be increased by more than 10 percent).

Using triggers places the logic that enforces business rules inside the database. This means that applications are not responsible for enforcing these rules. Centralized logic that is enforced on all of the tables means easier maintenance, because changes to application programs are not required when the logic changes.

The following are specified when creating a trigger:

- The *subject table* specifies the table for which the trigger is defined.
- The *trigger event* defines a specific SQL operation that modifies the subject table. The event can be an insert, update, or delete operation.
- The *trigger activation time* specifies whether the trigger should be activated before or after the trigger event occurs.



The statement that causes a trigger to be activated includes a *set of affected rows*. These are the rows of the subject table that are being inserted, updated, or deleted. The *trigger granularity* specifies whether the actions of the trigger are performed once for the statement or once for each of the affected rows.

The *triggered action* consists of an optional search condition and a set of SQL statements that are executed whenever the trigger is activated. The SQL statements are only executed if the search condition evaluates to true. If the trigger activation time is before the trigger event, triggered actions can include statements that select, set transition variables, or signal SQLstates. If the trigger activation time is after the trigger event, triggered actions can include statements that select, insert, update, delete, or signal SQLstates.

The triggered action can refer to the values in the set of affected rows using *transition variables*. Transition variables use the names of the columns in the subject table, qualified by a specified name that identifies whether the reference is to the old value (before the update) or the new value (after the update). The new value can also be changed using the SET Variable statement in before, insert, or update triggers.

Another means of referring to the values in the set of affected rows is to use *transition tables*. Transition tables also use the names of the columns in the subject table, but specify a name to allow the complete set of affected rows to be treated as a table. Transition tables can only be used in after triggers, and separate transition tables can be defined for old and new values.

Multiple triggers can be specified for a combination of table, event, or activation time. The order in which the triggers are activated is the same as the order in which they were created. Thus, the most recently created trigger is the last trigger to be activated.

The activation of a trigger might cause *trigger cascading*, which is the result of the activation of one trigger that executes SQL statements that cause the activation of other triggers or even the same trigger again. The triggered actions might also cause updates resulting from the application of referential integrity rules for deletions that can, in turn, result in the activation of additional triggers. With trigger cascading, a chain of triggers and referential integrity delete rules can be activated, causing significant change to the database as a result of a single INSERT, UPDATE, or DELETE statement.

When multiple triggers have insert, update, or delete actions against the same object, temporary tables are used to avoid access conflicts, and this can have a noticeable impact on performance, particularly in partitioned database environments.

### Related concepts:

- “Triggers in application development” in *SQL Guide*

### Related tasks:

- “Creating triggers” in *Administration Guide: Implementation*

### Related reference:

- Appendix H, “Interaction of triggers and constraints,” on page 787

### Views

A *view* provides a different way of looking at the data in one or more tables; it is a named specification of a result table. The specification is a SELECT statement that is run whenever the view is referenced in an SQL statement. A view has columns and rows just like a base table. All views can be used just like base tables for data retrieval. Whether a view can be used in an insert, update, or delete operation depends on its definition.

You can use views to control access to sensitive data, because views allow multiple users to see different presentations of the same data. For example, several users may be accessing a table of data about employees. A manager sees data about his or her employees but not employees in another department. A recruitment officer sees the hire dates of all employees, but not their salaries; a financial officer sees the salaries, but not the hire dates. Each of these users works with a view derived from the base table. Each view appears to be a table and has its own name.

When the column of a view is directly derived from the column of a base table, that view column inherits any constraints that apply to the base table column. For example, if a view includes a foreign key of its base table, insert and update operations using that view are subject to the same referential constraints as is the base table. Also, if the base table of a view is a parent table, delete and update operations using that view are subject to the same rules as are delete and update operations on the base table.

A view can derive the data type of each column from the result table, or base the types on the attributes of a user-defined structured type. This is called a *typed view*. Similar to a typed table, a typed view can be part of a view hierarchy. A *subview* inherits columns from its *superview*. The term *subview* applies to a typed view and to all typed views that are below it in the view hierarchy. A *proper subview* of a view V is a view below V in the typed view hierarchy.

A view can become inoperative (for example, if the base table is dropped); if this occurs, the view is no longer available for SQL operations.

---

### Aliases

An *alias* is an alternative name for a table or a view. It can be used to reference a table or a view if an existing table or view *can* be referenced. An alias cannot be used in all contexts; for example, it cannot be used in the check condition of a check constraint. An alias cannot reference a declared temporary table.

Like tables or views, an alias can be created, dropped, and have comments associated with it. However, unlike tables, aliases can refer to each other in a process called *chaining*. Aliases are publicly referenced names, so no special authority or privilege is required to use them. Access to the table or the view referred to by an alias, however, does require the authorization associated with these objects.

There are other types of aliases, such as database and network aliases. Aliases can also be created for *nicknames* that refer to data tables or views located on federated systems.

---

## Packages

A *package* is an object produced during program preparation that contains all of the sections in a single source file. A *section* is the compiled form of an SQL statement. Although every section corresponds to one statement, not every statement has a section. The sections created for static SQL are comparable to the bound, or operational, form of SQL statements. The sections created for dynamic SQL are comparable to placeholder control structures used at run time.

---

## Authorization, privileges, and object ownership

Users (identified by an authorization ID) can successfully execute SQL or XQuery statements only if they have the authority to perform the specified function. To create a table, a user must be authorized to create tables; to alter a table, a user must be authorized to alter the table; and so forth.

There are two forms of authorization, *administrative authority* and *privileges*, discussed below.

The database manager requires that each user be specifically authorized, either implicitly or explicitly, to use each database function needed to perform a specific task. *Explicit* authorities or privileges are granted to the user (GRANTEETYPE of U in the database catalogs). *Implicit* authorities or privileges are granted to a group to which the user belongs (GRANTEETYPE of G in the database catalogs).

### Administrative authority:

The person or persons holding administrative authority are charged with the task of controlling the database manager and are responsible for the safety and integrity of the data. Those with administrative authority levels of SYSADM and DBADM implicitly have all privileges on all objects except objects pertaining to database security and control who will have access to the database manager and the extent of this access.

*Authority levels* provide a method of grouping privileges and higher-level database manager maintenance and utility operations. *Database authorities* enable users to perform activities at the database level. A user or group can have one or more of the following authorities:

- Administrative authority level that operates at the instance level, SYSADM (system administrator)

The SYSADM authority level provides control over all the resources created and maintained by the database manager. The system administrator possesses all the authorities of DBADM, SYSCTRL, SYSMANT, and SYSMON, and the authority to grant and revoke DBADM authority and SECADM authority.

The user who possesses SYSADM authority is responsible both for controlling the database manager, and for ensuring the safety and integrity of the data. SYSADM authority provides implicit DBADM authority within a database but does not provide implicit SECADM authority within a database.

- Administrative authority levels that operate at the database level:
  - DBADM (database administrator)

The DBADM authority level applies at the database level and provides administrative authority over a single database. This database administrator

## Privileges, authority levels, and database authorities

possesses the privileges required to create objects, issue database commands, and access table data. The database administrator can also grant and revoke CONTROL and individual privileges.

- SECADM (security administrator)

The SECADM authority level applies at the database level and is the authority required to create and drop security label components, security policies, and security labels, which are used to protect tables. It is also the authority required to grant and revoke security labels and exemptions as well as to grant and revoke the SETSESSIONUSER privilege. A user with the SECADM authority can transfer the ownership of objects that they do not own. The SECADM authority has no inherent privilege to access data stored in tables and has no other additional inherent privilege. It can only be granted by a user with SYSADM authority. The SECADM authority can be granted to a user but cannot be granted to a group or to PUBLIC.

- System control authority levels that operate at the instance level:

- SYSCTRL (system control)

The SYSCTRL authority level provides control over operations that affect system resources. For example, a user with SYSCTRL authority can create, update, start, stop, or drop a database. This user can also start or stop an instance, but cannot access table data. Users with SYSCTRL authority also have SYSMON authority.

- SYSMANT (system maintenance)

The SYSMANT authority level provides the authority required to perform maintenance operations on all databases associated with an instance. A user with SYSMANT authority can update the database configuration, backup a database or table space, restore an existing database, and monitor a database. Like SYSCTRL, SYSMANT does not provide access to table data. Users with SYSMANT authority also have SYSMON authority.

- The SYSMON (system monitor) authority level

SYSMON provides the authority required to use the database system monitor. It operates at the instance level.

- Database authorities

To perform activities such as creating a table or a routine, or for loading data into a table, specific database authorities are required. For example, the LOAD database authority is required for use of the load utility to load data into tables (a user must also have INSERT privilege on the table).

Figure 1 on page 15 illustrates the relationship between authorities and their span of control (database, database manager).

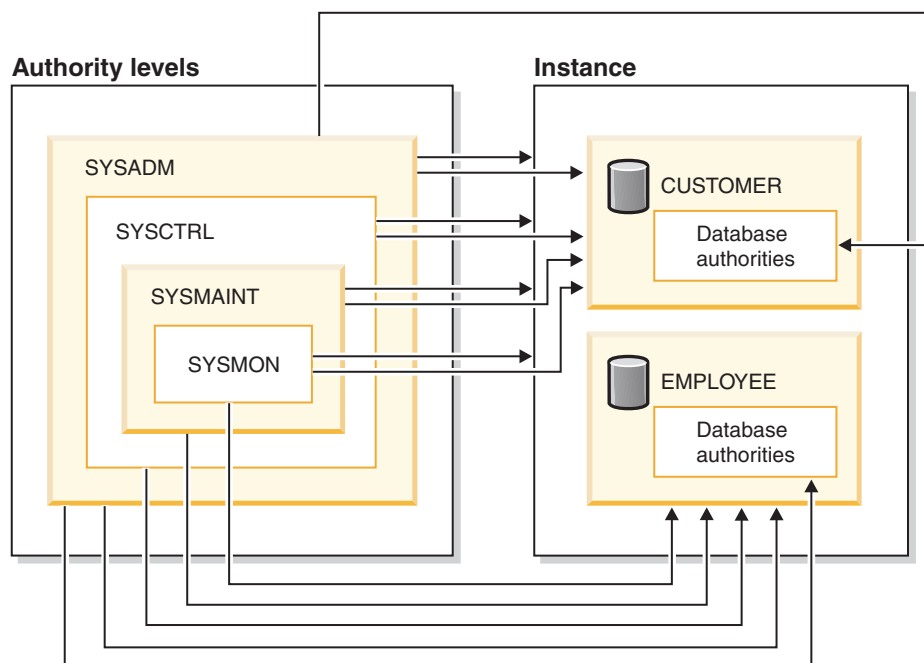

Figure 1. Hierarchy of Authorities

**Privileges:**

*Privileges* are those activities that a user is allowed to perform. Authorized users can create objects, have access to objects they own, and can pass on privileges on their own objects to other users by using the GRANT statement.

Privileges may be granted to individual users, to groups, or to PUBLIC. PUBLIC is a special group that consists of all users, including future users. Users that are members of a group will indirectly take advantage of the privileges granted to the group, where groups are supported.

*The CONTROL privilege:* Possessing the CONTROL privilege on an object allows a user to access that database object, and to grant and revoke privileges to or from other users on that object.

**Note:** The CONTROL privilege only applies to tables, views, nicknames, indexes, and packages.

If a different user requires the CONTROL privilege to that object, a user with SYSADM or DBADM authority could grant the CONTROL privilege to that object. The CONTROL privilege cannot be revoked from the object owner, however, the object owner can be changed by using the TRANSFER OWNERSHIP statement.

In some situations, the creator of an object automatically obtains the CONTROL privilege on that object.

*Individual privileges:* Individual privileges can be granted to allow a user to carry out specific tasks on specific objects. Users with administrative authority (SYSADM or DBADM) or the CONTROL privilege can grant and revoke privileges to and from users.

## Privileges, authority levels, and database authorities

Individual privileges and database authorities allow a specific function, but do not include the right to grant the same privileges or authorities to other users. The right to grant table, view, schema, package, routine, and sequence privileges to others can be extended to other users through the WITH GRANT OPTION on the GRANT statement. However, the WITH GRANT OPTION does not allow the person granting the privilege to revoke the privilege once granted. You must have SYSADM authority, DBADM authority, or the CONTROL privilege to revoke the privilege.

*Privileges on objects in a package or routine:* When a user has the privilege to execute a package or routine, they do not necessarily require specific privileges on the objects used in the package or routine. If the package or routine contains static SQL or XQuery statements, the privileges of the owner of the package are used for those statements. If the package or routine contains dynamic SQL or XQuery statements, the authorization ID used for privilege checking depends on the setting of the DYNAMICRULES bind option of the package issuing the dynamic query statements, and whether those statements are issued when the package is being used in the context of a routine.

A user or group can be authorized for any combination of individual privileges or authorities. When a privilege is associated with an object, that object must exist. For example, a user cannot be given the SELECT privilege on a table unless that table has previously been created.

**Note:** Care must be taken when an authorization name representing a user or group is granted authorities and privileges and there is no user or group created with that name. At some later time, a user or group can be created with that name and automatically receive all of the authorities and privileges associated with that authorization name.

The REVOKE statement is used to revoke previously granted privileges. The revoking of a privilege from an authorization name revokes the privilege granted by all authorization names.

Revoking a privilege from an authorization name does not revoke that same privilege from any other authorization names that were granted the privilege by that authorization name. For example, assume that CLAIRE grants SELECT WITH GRANT OPTION to RICK, then RICK grants SELECT to BOBBY and CHRIS. If CLAIRE revokes the SELECT privilege from RICK, BOBBY and CHRIS still retain the SELECT privilege.

### Object ownership:

When an object is created, one authorization ID is assigned *ownership* of the object. Ownership means the user is authorized to reference the object in any applicable SQL or XQuery statement.

When an object is created within a schema, the authorization ID of the statement must have the required privilege to create objects in the implicitly or explicitly specified schema. That is, the authorization name must either be the owner of the schema, or possess the CREATEIN privilege on the schema.

**Note:** This requirement is not applicable when creating table spaces, buffer pools or database partition groups. These objects are not created in schemas.

## Privileges, authority levels, and database authorities

When an object is created, the authorization ID of the statement is the owner of that object.

**Note:** One exception exists. If the `AUTHORIZATION` option is specified for the `CREATE SCHEMA` statement, any other object that is created as part of the `CREATE SCHEMA` operation is owned by the authorization ID specified by the `AUTHORIZATION` option. Any objects that are created in the schema after the initial `CREATE SCHEMA` operation, however, are owned by the authorization ID associated with the specific `CREATE` statement.

For example, the statement `CREATE SCHEMA SCOTTSTUFF AUTHORIZATION SCOTT CREATE TABLE T1 (C1 INT)` creates the schema `SCOTTSTUFF` and the table `SCOTTSTUFF.T1`, which are both owned by `SCOTT`. Assume that the user `BOBBY` is granted the `CREATEIN` privilege on the `SCOTTSTUFF` schema and creates an index on the `SCOTTSTUFF.T1` table. Because the index is created after the schema, `BOBBY` owns the index on `SCOTTSTUFF.T1`.

Privileges are assigned to the object owner based on the type of object being created:

- The `CONTROL` privilege is implicitly granted on newly created tables, indexes, and packages. This privilege allows the object creator to access the database object, and to grant and revoke privileges to or from other users on that object. If a different user requires the `CONTROL` privilege to that object, a user with `SYSADM` or `DBADM` authority must grant the `CONTROL` privilege to that object. The `CONTROL` privilege cannot be revoked by the object owner.
- The `CONTROL` privilege is implicitly granted on newly created views if the object owner has the `CONTROL` privilege on all the tables, views, and nicknames referenced by the view definition.
- Other objects like triggers, routines, sequences, table spaces, and buffer pools do not have a `CONTROL` privilege associated with them. The object owner does, however, automatically receive each of the privileges associated with the object (and can provide these privileges to other users, where supported, by using the `WITH GRANT` option of the `GRANT` statement). In addition, the object owner can alter, add a comment on, or drop the object. These authorizations are implicit for the object owner and cannot be revoked.

Certain privileges on the object, such as altering a table, can be granted by the owner, and can be revoked from the owner by a user who has `SYSADM` or `DBADM` authority. Certain privileges on the object, such as commenting on a table, cannot be granted by the owner and cannot be revoked from the owner. Use the `TRANSFER OWNERSHIP` statement to move these privileges to another user. When an object is created, the authorization ID of the statement is the owner of the object. However, when a package is created and the `OWNER bind` option is specified, the owner of objects created by the static SQL statements in the package is the value of the `OWNER bind` option. In addition, if the `AUTHORIZATION` clause is specified on a `CREATE SCHEMA` statement, the authorization name specified after the `AUTHORIZATION` keyword is the owner of the schema.

A security administrator (`SECADM`) or the object owner can use the `TRANSFER OWNERSHIP` statement to change the ownership of a database object. An administrator can therefore create an object on behalf of an authorization ID, by creating the object using the authorization ID as the qualifier, and then using the `TRANSFER OWNERSHIP` statement to transfer the ownership that the administrator has on the object to the authorization ID.

## Privileges, authority levels, and database authorities

### Related concepts:

- “Controlling access to database objects” in *Administration Guide: Implementation*
- “Database administration authority (DBADM)” in *Administration Guide: Implementation*
- “Database authorities” in *Administration Guide: Implementation*
- “Index privileges” in *Administration Guide: Implementation*
- “Indirect privileges through a package” in *Administration Guide: Implementation*
- “LOAD authority” in *Administration Guide: Implementation*
- “Package privileges” in *Administration Guide: Implementation*
- “Routine privileges” in *Administration Guide: Implementation*
- “Schema privileges” in *Administration Guide: Implementation*
- “Security administration authority (SECADM)” in *Administration Guide: Implementation*
- “Sequence privileges” in *Administration Guide: Implementation*
- “System administration authority (SYSADM)” in *Administration Guide: Implementation*
- “System control authority (SYSCTRL)” in *Administration Guide: Implementation*
- “System maintenance authority (SYSMAINT)” in *Administration Guide: Implementation*
- “System monitor authority (SYSMON)” in *Administration Guide: Implementation*
- “Table and view privileges” in *Administration Guide: Implementation*
- “Table space privileges” in *Administration Guide: Implementation*

### Related reference:

- “GRANT (Database Authorities) statement” in *SQL Reference, Volume 2*

---

## Catalog views

The database manager maintains a set of base tables and views that contain information about the data under its control. These base tables and views are collectively known as the *catalog*. The catalog contains information about the logical and physical structure of database objects such as tables, views, indexes, packages, and functions. It also contains statistical information. The database manager ensures that the descriptions in the catalog are always accurate.

The catalog views are like any other database view. SQL statements can be used to look at the data in the catalog views. A set of updatable catalog views can be used to modify certain values in the catalog.

### Related reference:

- “System catalog views” on page 583

---

## Application processes, concurrency, and recovery

All SQL programs execute as part of an *application process* or agent. An application process involves the execution of one or more programs, and is the unit to which the database manager allocates resources and locks. Different application processes may involve the execution of different programs, or different executions of the same program.



## Application processes, concurrency, and recovery

More than one application process may request access to the same data at the same time. *Locking* is the mechanism used to maintain data integrity under such conditions, preventing, for example, two application processes from updating the same row of data simultaneously.

The database manager acquires locks to prevent uncommitted changes made by one application process from being accidentally perceived by any other process. The database manager releases all locks it has acquired and retained on behalf of an application process when that process ends. However, an application process can explicitly request that locks be released sooner. This is done using a *commit* operation, which releases locks acquired during the unit of work and also commits database changes made during the unit of work.

The database manager provides a means of backing out uncommitted changes made by an application process. This might be necessary in the event of a failure on the part of an application process, or in the case of a deadlock, or a lock time-out situation. An application process can explicitly request that its database changes be backed out. This is done using a *rollback* operation.

A *unit of work* is a recoverable sequence of operations within an application process. A unit of work is initiated when an application process is started, or when the previous unit of work is ended by something other than the termination of the application process. A unit of work is ended by a commit operation, a rollback operation, or the end of an application process. A commit or rollback operation affects only the database changes made within the unit of work it is ending.

As long as these changes remain uncommitted, other application processes are unable to perceive them, and they can be backed out. This is not true, however, when the isolation level is uncommitted read (UR). Once committed, these database changes are accessible by other application processes and can no longer be backed out through a rollback.

Both DB2 call level interface (CLI) and embedded SQL allow for a connection mode called *concurrent transactions*, which supports multiple connections, each of which is an independent transaction. An application can have multiple concurrent connections to the same database.

Locks acquired by the database manager on behalf of an application process are held until the end of a unit of work. This is not true, however, when the isolation level is cursor stability (CS, in which the lock is released as the cursor moves from row to row) or uncommitted read (UR, in which locks are not obtained).

An application process is never prevented from performing operations because of its own locks. However, if an application uses concurrent transactions, the locks from one transaction may affect the operation of a concurrent transaction.

The initiation and the termination of a unit of work define points of consistency within an application process. For example, a banking transaction may involve the transfer of funds from one account to another. Such a transaction would require that these funds be subtracted from the first account, and then added to the second account. Following the subtraction step, the data is inconsistent. Only after the funds have been added to the second account is consistency reestablished. When both steps are complete, the commit operation can be used to end the unit of work, thereby making the changes available to other application processes. If a failure occurs before the unit of work ends, the database manager will roll back

## Application processes, concurrency, and recovery

uncommitted changes to restore the data consistency that it assumes existed when the unit of work was initiated.

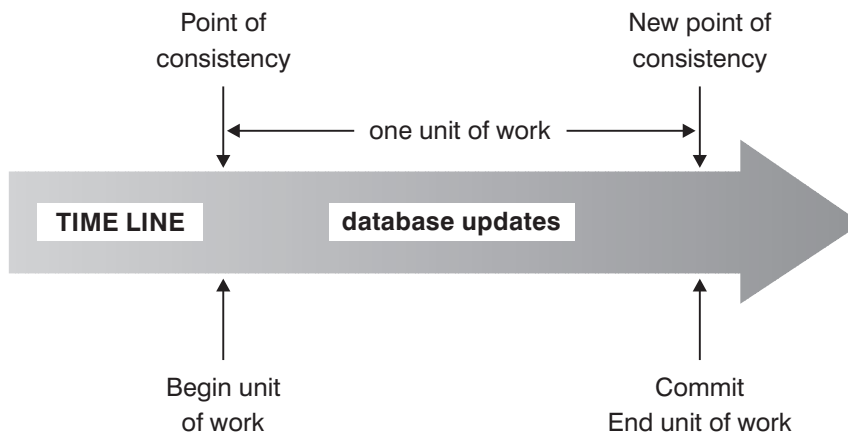

Figure 2. Unit of Work with a COMMIT Statement

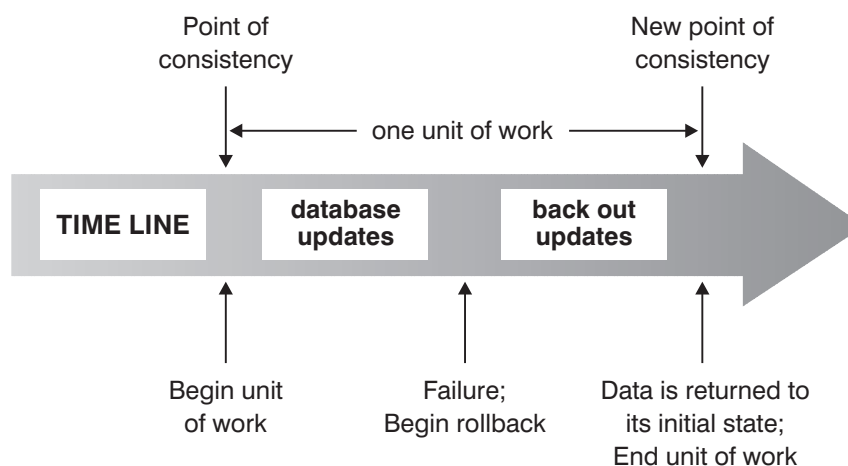

Figure 3. Unit of Work with a ROLLBACK Statement

### Related concepts:

- "Isolation levels" on page 20

---

## Isolation levels

The *isolation level* associated with an application process defines the degree of isolation of that application process from other concurrently executing application processes. The isolation level of an application process therefore specifies:

- The degree to which the rows read and updated by the application are available to other concurrently executing application processes.
- The degree to which the update activity of other concurrently executing application processes can affect the application.

The isolation level for static SQL statements is specified as an attribute of a package and applies to the application processes that use the package. The isolation level is specified in the program preparation process. For dynamic SQL statements, the default isolation level is the isolation level specified for the package preparing the statement. Use of the SET CURRENT ISOLATION statement allows

for alternate isolation levels to be specified for dynamic SQL issued within a session. Depending on the type of lock, this limits or prevents access to the data by concurrent application processes. Declared temporary tables and their rows cannot be locked because they are only accessible to the application that declared them.

The database manager supports three general categories of locks:

**Share** Limits concurrent application processes to read-only operations on the data.

**Update**

Limits concurrent application processes to read-only operations on the data, if these processes have not declared that they might update the row. The database manager assumes that the process currently looking at a row may update it.

**Exclusive**

Prevents concurrent application processes from accessing the data in any way. Does not apply to application processes with an isolation level of *uncommitted read*, which can read but not modify the data.

Locking occurs at the base table row. The database manager, however, can replace multiple row locks with a single table lock. This is called *lock escalation*. An application process is guaranteed at least the minimum requested lock level.

The database manager supports four isolation levels. Regardless of the isolation level, the database manager places exclusive locks on every row that is inserted, updated, or deleted. Thus, all isolation levels ensure that any row that is changed by this application process during a unit of work is not changed by any other application processes until the unit of work is complete. The isolation levels are:

- Repeatable Read (RR)

This level ensures that:

- Any row read during a unit of work is not changed by other application processes until the unit of work is complete. The rows are read in the same unit of work as the corresponding OPEN statement. Use of the optional WITH RELEASE clause on the CLOSE statement means that any guarantees against non-repeatable reads and phantom reads no longer apply to any previously accessed rows if the cursor is reopened.
- Any row changed by another application process cannot be read until it is committed by that application process.

The Repeatable Read level does not allow phantom rows to be viewed (see Read Stability).

In addition to any exclusive locks, an application process running at the RR level acquires at least share locks on all the rows it references. Furthermore, the locking is performed so that the application process is completely isolated from the effects of concurrent application processes.

- Read Stability (RS)

Like the Repeatable Read level, the Read Stability level ensures that:

- Any row read during a unit of work is not changed by other application processes until the unit of work is complete. The rows are read in the same unit of work as the corresponding OPEN statement. Use of the optional WITH RELEASE clause on the CLOSE statement means that any guarantees against non-repeatable reads no longer apply to any previously accessed rows if the cursor is reopened.

## Isolation levels

- Any row changed by another application process cannot be read until it is committed by that application process.

Unlike Repeatable Read, Read Stability does not completely isolate the application process from the effects of concurrent application processes. At the RS level, application processes that issue the same query more than once may see additional rows caused by other application processes appending new information to the database. These additional rows are called *phantom rows*.

For example, a phantom row can occur in the following situation:

1. Application process P1 reads the set of rows *n* that satisfy some search condition.
2. Application process P2 then inserts one or more rows that satisfy the search condition and commits those new inserts.
3. P1 reads the set of rows again with the same search condition and obtains both the original rows and the rows inserted by P2.

In addition to any exclusive locks, an application process running at the RS isolation level acquires at least share locks on all the qualifying rows.

- **Cursor Stability (CS)**

Like the Repeatable Read level, the Cursor Stability level ensures that any row that was changed by another application process cannot be read until it is committed by that application process.

Unlike Repeatable Read, Cursor Stability only ensures that the current row of every updatable cursor is not changed by other application processes. Thus, the rows that were read during a unit of work can be changed by other application processes.

In addition to any exclusive locks, an application process running at the CS isolation level acquires at least a share lock on the current row of every cursor.

- **Uncommitted Read (UR)**

For SELECT INTO, FETCH with a read-only cursor, fullselect in an INSERT, row fullselect in an UPDATE, or scalar fullselect (wherever it is used), the Uncommitted Read level allows:

- Any row read during a unit of work to be changed by other application processes.
- Any row changed by another application process to be read, even if the change has not been committed by that application process.

For other operations, rules associated with the CS level apply.

## Comparison of isolation levels

The following table summarizes information about isolation levels.

|   | UR  | CS  | RS  | RR              |
|---|-----|-----|-----|-----------------|
| Can the application see uncommitted changes made by other application processes?  | Yes | No  | No  | No              |
| Can the application update uncommitted changes made by other application processes?                                       | No  | No  | No  | No              |
| Can the re-execution of a statement be affected by other application processes? See <i>phenomenon P3 (phantom)</i> below. | Yes | Yes | Yes | No <sup>3</sup> |
| Can “updated” rows be updated by other application processes? See Note 1 below.   | No  | No  | No  | No              |

|  | UR                | CS                | RS  | RR  |
|--|-------------------|-------------------|-----|-----|
| Can “updated” rows be read by other application processes that are running at an isolation level other than UR?      | No                | No                | No  | No  |
| Can “updated” rows be read by other application processes that are running at the UR isolation level?                | Yes               | Yes               | Yes | Yes |
| Can “accessed” rows be updated by other application processes? <i>See phenomenon P2 (nonrepeatable read) below.</i>  | Yes               | Yes               | No  | No  |
| Can “accessed” rows be read by other application processes?  | Yes               | Yes               | Yes | Yes |
| Can “current” row be updated or deleted by other application processes? <i>See phenomenon P1 (dirty-read) below.</i> | See Note 2 below. | See Note 2 below. | No  | No  |

**Notes:**

1. The isolation level offers no protection to the application if the application is both reading and writing a table. For example, an application opens a cursor on a table and then performs an insert, update, or delete operation on the same table. The application may see inconsistent data when more rows are fetched from the open cursor.
2. If the cursor is not updatable, with CS the current row may be updated or deleted by other application processes in some cases. For example, buffering may cause the current row at the client to be different than what the current row actually is at the server.
3. If your label-based access control (LBAC) credentials change between reads, the results of the second read might be different because you have access to different rows.

**Examples of Phenomena:**

- P1** *Dirty Read.* Unit of work UW1 modifies a row. Unit of work UW2 reads that row before UW1 performs a COMMIT. If UW1 then performs a ROLLBACK, UW2 has read a nonexistent row.
- P2** *Nonrepeatable Read.* Unit of work UW1 reads a row. Unit of work UW2 modifies that row and performs a COMMIT. If UW1 then re-reads the row, it might receive a modified value.
- P3** *Phantom.* Unit of work UW1 reads the set of  $n$  rows that satisfies some search condition. Unit of work UW2 then INSERTs one or more rows that satisfies the search condition and performs a COMMIT. If UW1 then repeats the initial read with the same search condition, it obtains the original rows plus the inserted rows.

**Related reference:**

- “DECLARE CURSOR statement” in *SQL Reference, Volume 2*

---

## Table spaces and other storage structures

Storage structures contain database objects. The basic storage structure is the *table space*; it contains tables, indexes, large objects, and data defined with a LONG data type. There are two types of table spaces:

**Database managed space (DMS)**

A table space that is managed by the database manager.

**System managed space (SMS)**

A table space that is managed by the operating system.

## Table spaces and other storage structures

All table spaces consist of containers. A *container* describes where objects are stored. A subdirectory in a file system is an example of a container.

When data is read from table space containers, it is placed in an area of memory called a buffer pool. A *buffer pool* is associated with a specific table space, thereby allowing control over which data will share the same memory areas for data buffering.

In a partitioned database, data is spread across different database partitions. Exactly which database partitions are included is determined by the database partition group that is assigned to the table space. A *database partition group* is a group of one or more database partitions that are defined as part of the database. A table space includes one or more containers for each partition in the database partition group. A *distribution map*, associated with each database partition group, is used by the database manager to determine on which database partition a given row of data is to be stored. The distribution map is an array of 4096 database partition numbers. The distribution map index produced by the partitioning function for each row in a table is used as an index into the distribution map to determine the database partition on which a row is to be stored. As an example, the following figure shows how a row with distribution key value (c1, c2, c3) is mapped to distribution map index 2 which, in turn, references database partition p5.

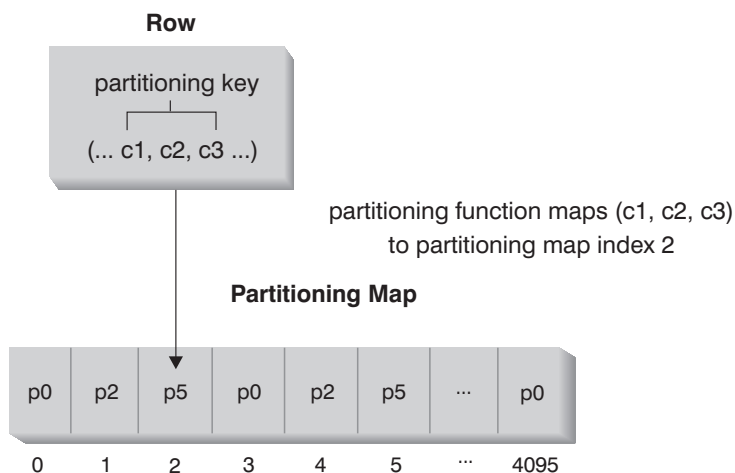

Nodegroup partitions are p0, p2, and p5

**Note:** Partition numbers start at 0.

Figure 4. Data Distribution

The distribution map can be changed, allowing the data distribution to be changed without modifying the distribution key or the actual data. The new distribution map is specified as part of the REDISTRIBUTE DATABASE PARTITION GROUP command or the sqludrtd application programming interface (API), which use it to redistribute the tables in the database partition group.

The DB2 Data Links Manager product provides functionality that supports additional storage capabilities. A normal user table can include columns (defined with the DATALINK data type) that register links to data stored in external files. DATALINK values point to data files that are stored on an external file server.

**Related concepts:**

- “Database partitioning across multiple database partitions” on page 36

### Related reference:

- “CREATE BUFFERPOOL statement” in *SQL Reference, Volume 2*
- “CREATE DATABASE PARTITION GROUP statement” in *SQL Reference, Volume 2*
- “CREATE TABLESPACE statement” in *SQL Reference, Volume 2*

---

## Character conversion

A *string* is a sequence of bytes that may represent characters. All the characters within a string have a common coding representation. In some cases, it may be necessary to convert these characters to a different coding representation, a process known as *character conversion*. Character conversion, when required, is automatic, and when successful, it is transparent to the application.

Character conversion can occur when an SQL statement is executed remotely. Consider, for example, the following scenarios in which the coding representations may be different at the sending and receiving systems:

- The values of host variables are sent from the application requester to the application server.
- The values of result columns are sent from the application server to the application requester.

Following is a list of terms used when discussing character conversion:

### character set

A defined set of characters. For example, the following character set appears in several code pages:

- 26 non-accented letters A through Z
- 26 non-accented letters a through z
- digits 0 through 9
- . , ; ? ( ) ' " / - \_ & + % \* = < >

### code page

A set of assignments of characters to code points. In the ASCII encoding scheme for code page 850, for example, "A" is assigned code point X'41', and "B" is assigned code point X'42'. Within a code page, each code point has only one specific meaning. A code page is an attribute of the database. When an application program connects to the database, the database manager determines the code page of the application.

### code point

A unique bit pattern that represents a character.

### encoding scheme

A set of rules used to represent character data, for example:

- Single-Byte ASCII
- Single-Byte EBCDIC
- Double-Byte ASCII
- Mixed single- and double-byte ASCII

The following figure shows how a typical character set might map to different code points in two different code pages. Even with the same encoding scheme,

## Character conversion

there are many different code pages, and the same code point can represent a different character in different code pages. Furthermore, a byte in a character string does not necessarily represent a character from a single-byte character set (SBCS). Character strings are also used for mixed and bit data. *Mixed data* is a mixture of single-byte, double-byte, or multi-byte characters. *Bit data* (columns defined as FOR BIT DATA, or BLOBs, or binary strings) is not associated with any character set.

| code page: pp1 (ASCII) |   |   |   |   |   |   |  | code page: pp2 (EBCDIC) |   |   |   |   |  |   |    |   |   |   |   |
|------------------------|---|---|---|---|---|---|--|-------------------------|---|---|---|---|--|---|----|---|---|---|---|
|                        | 0 | 1 | 2 | 3 | 4 | 5 |  | E                       | F |   | 0 | 1 |  | A | B  | C | D | E | F |
| 0                      |   |   |   | 0 | @ | P |  | Â                       |   | 0 |   |   |  |   | #  |   |   |   | 0 |
| 1                      |   |   |   | 1 | A | Q |  | À                       | α | 1 |   |   |  |   | \$ | A | J |   | 1 |
| 2                      |   |   | " | 2 | B | R |  | Å                       | β | 2 |   |   |  | s | %  | B | K | S | 2 |
| 3                      |   |   |   | 3 | C | S |  | Á                       | γ | 3 |   |   |  | t | ¬  | C | L | T | 3 |
| 4                      |   |   |   | 4 | D | T |  | Ã                       | δ | 4 |   |   |  | u | *  | D | M | U | 4 |
| 5                      |   |   | % | 5 | E | U |  | Ä                       | ε | 5 |   |   |  | v | (  | E | N | V | 5 |
|                        |   |   |   |   |   |   |  |                         |   |   |   |   |  |   |    |   |   |   |   |
|                        |   |   |   |   |   |   |  |                         |   |   |   |   |  |   |    |   |   |   |   |
| E                      |   |   | . | > | N |   |  | 5/8                     | Ö | E |   |   |  |   | !  | : | Â | } |   |
| F                      |   |   | / | * | 0 |   |  | ®                       |   | F |   |   |  | À | ¢  | ; | Á | { |   |

code point: 2F      character set ss1 (in code page pp1)      character set ss1 (in code page pp2)

Figure 5. Mapping a Character Set in Different Code Pages

The database manager determines code page attributes for all character strings when an application is bound to a database. The possible code page attributes are:

### Database code page

The database code page is stored in the database configuration file. The value is specified when the database is created and cannot be altered.

### Application code page

The code page under which the application runs. This is not necessarily the same code page under which the application was bound.

### Section code page

The code page under which the SQL statement runs. Typically, the section code page is the database code page. However, the Unicode code page (UTF-8) is used as the section code page if:

- The statement references a table that is created with the Unicode encoding scheme in a non-Unicode database



- The statement references a table function that is defined with PARAMETER CCSID UNICODE in a non-Unicode database

### Code Page 0

This represents a string that is derived from an expression that contains a FOR BIT DATA value or a BLOB value.

Character string code pages have the following attributes:

- Columns can be in the database code page, the Unicode code page (UTF-8), or code page 0 (if defined as FOR BIT DATA or BLOB).
- Constants and special registers (for example, USER, CURRENT SERVER) are in the section code page. Constants are converted, if necessary, from the application code page to the database code page, and then to the section code page when an SQL statement is bound to the database.
- Input host variables are in the application code page. As of Version 8, string data in input host variables is converted, if necessary, from the application code page to the section code page before being used. The exception occurs when a host variable is used in a context where it is to be interpreted as bit data; for example, when the host variable is to be assigned to a column that is defined as FOR BIT DATA.

A set of rules is used to determine code page attributes for operations that combine string objects, such as scalar operations, set operations, or concatenation. Code page attributes are used to determine requirements for code page conversion of strings at run time.

### Related reference:

- “Assignments and comparisons” on page 105
- “Rules for string conversions” on page 120

---

## Distributed relational databases

A *distributed relational database* consists of a set of tables and other objects that are spread across different but interconnected computer systems. Each computer system has a relational database manager to manage the tables in its environment. The database managers communicate and cooperate with each other in a way that allows a given database manager to execute SQL statements on another computer system.

Distributed relational databases are built on formal requester-server protocols and functions. An *application requester* supports the application end of a connection. It transforms a database request from the application into communication protocols suitable for use in the distributed database network. These requests are received and processed by a *database server* at the other end of the connection. Working together, the application requester and the database server handle communication and location considerations, so that the application can operate as if it were accessing a local database.

An application process must connect to a database manager’s application server before SQL statements that reference tables or views can be executed. The CONNECT statement establishes a connection between an application process and its server.

There are two types of CONNECT statements:

## Distributed relational databases

- CONNECT (Type 1) supports the single database per unit of work (Remote Unit of Work) semantics.
- CONNECT (Type 2) supports the multiple databases per unit of work (Application-Directed Distributed Unit of Work) semantics.

The DB2 call level interface (CLI) and embedded SQL support a connection mode called *concurrent transactions*, which allows multiple connections, each of which is an independent transaction. An application can have multiple concurrent connections to the same database.

The application server can be local to or remote from the environment in which the process is initiated. An application server is present, even if the environment is not using distributed relational databases. This environment includes a local directory that describes the application servers that can be identified in a CONNECT statement.

The application server runs the bound form of a static SQL statement that references tables or views. The bound statement is taken from a package that the database manager has previously created through a bind operation.

For the most part, an application connected to an application server can use statements and clauses that are supported by the application server's database manager. This is true even if an application is running through the application requester of a database manager that does *not* support some of those statements and clauses.

## Remote unit of work

The *remote unit of work facility* provides for the remote preparation and execution of SQL statements. An application process at computer system A can connect to an application server at computer system B and, within one or more units of work, execute any number of static or dynamic SQL statements that reference objects at B. After ending a unit of work at B, the application process can connect to an application server at computer system C, and so on.

Most SQL statements can be remotely prepared and executed, with the following restrictions:

- All objects referenced in a single SQL statement must be managed by the same application server.
- All of the SQL statements in a unit of work must be executed by the same application server.

At any given time, an application process is in one of four possible *connection states*:

- Connectable and connected

An application process is connected to an application server, and CONNECT statements can be executed.

If implicit connect is available:

- The application process enters this state when a CONNECT TO statement or a CONNECT without operands statement is successfully executed from the connectable and unconnected state.
- The application process may enter this state from the implicitly connectable state if any SQL statement other than CONNECT RESET, DISCONNECT, SET CONNECTION, or RELEASE is issued.

Whether or not implicit connect is available, this state is entered when:

- A CONNECT TO statement is successfully executed from the connectable and unconnected state.
- A COMMIT or ROLLBACK statement is successfully issued, or a forced rollback occurs from the unconnectable and connected state.

- Unconnectable and connected

An application process is connected to an application server, but a CONNECT TO statement cannot be successfully executed to change application servers. The application process enters this state from the connectable and connected state when it executes any SQL statement other than the following: CONNECT TO, CONNECT with no operand, CONNECT RESET, DISCONNECT, SET CONNECTION, RELEASE, COMMIT, or ROLLBACK.

- Connectable and unconnected

An application process is not connected to an application server. CONNECT TO is the only SQL statement that can be executed; otherwise, an error (SQLSTATE 08003) is raised.

Whether or not implicit connect is available, the application process enters this state if an error occurs when a CONNECT TO statement is issued, or an error occurs within a unit of work, causing the loss of a connection and a rollback. An error that occurs because the application process is not in the connectable state, or because the server name is not listed in the local directory, does not cause a transition to this state.

If implicit connect is not available:

- The application process is initially in this state
  - The CONNECT RESET and DISCONNECT statements cause a transition to this state.
- Implicitly connectable (if implicit connect is available).

If implicit connect is available, this is the initial state of an application process. The CONNECT RESET statement causes a transition to this state. Issuing a COMMIT or ROLLBACK statement in the unconnectable and connected state, followed by a DISCONNECT statement in the connectable and connected state, also results in this state.

Availability of implicit connect is determined by installation options, environment variables, and authentication settings.

It is not an error to execute consecutive CONNECT statements, because CONNECT itself does not remove the application process from the connectable state. It is, however, an error to execute consecutive CONNECT RESET statements. It is also an error to execute any SQL statement other than CONNECT TO, CONNECT RESET, CONNECT with no operand, SET CONNECTION, RELEASE, COMMIT, or ROLLBACK, and then to execute a CONNECT TO statement. To avoid this error, a CONNECT RESET, DISCONNECT (preceded by a COMMIT or ROLLBACK statement), COMMIT, or ROLLBACK statement should be executed before the CONNECT TO statement.

## Remote unit of work

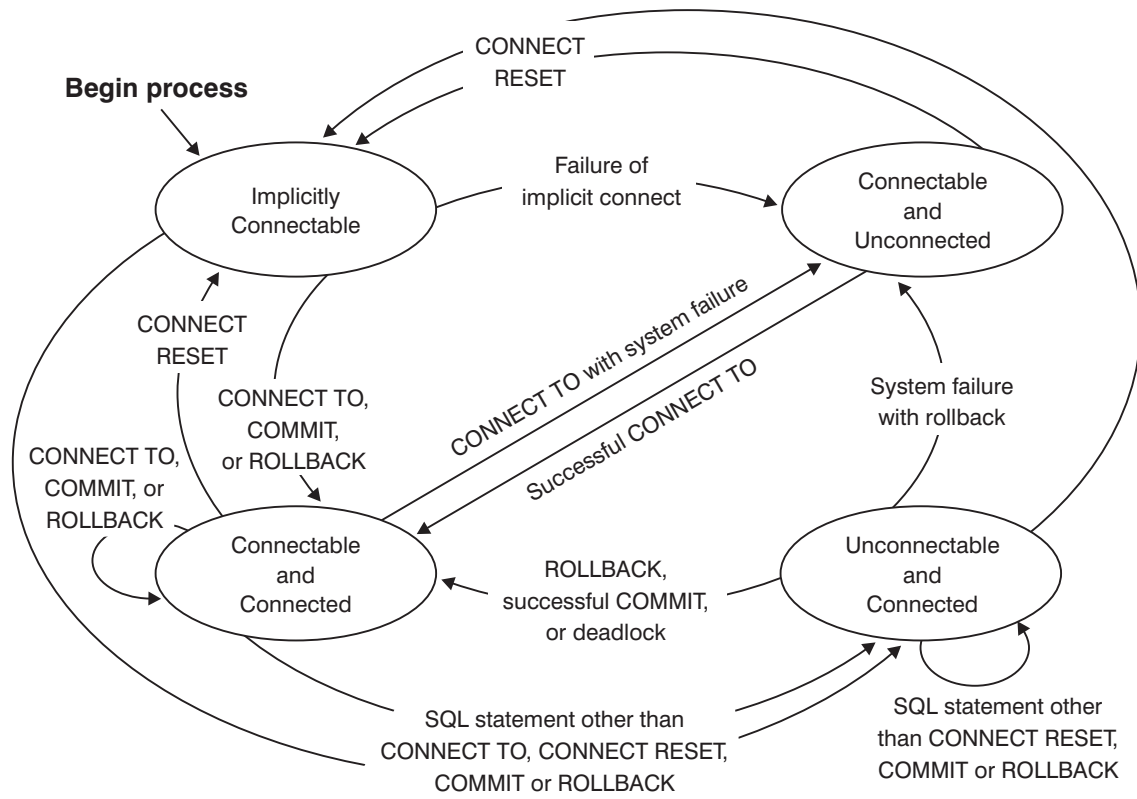

Figure 6. Connection State Transitions If Implicit Connect Is Available

## Application-directed distributed unit of work

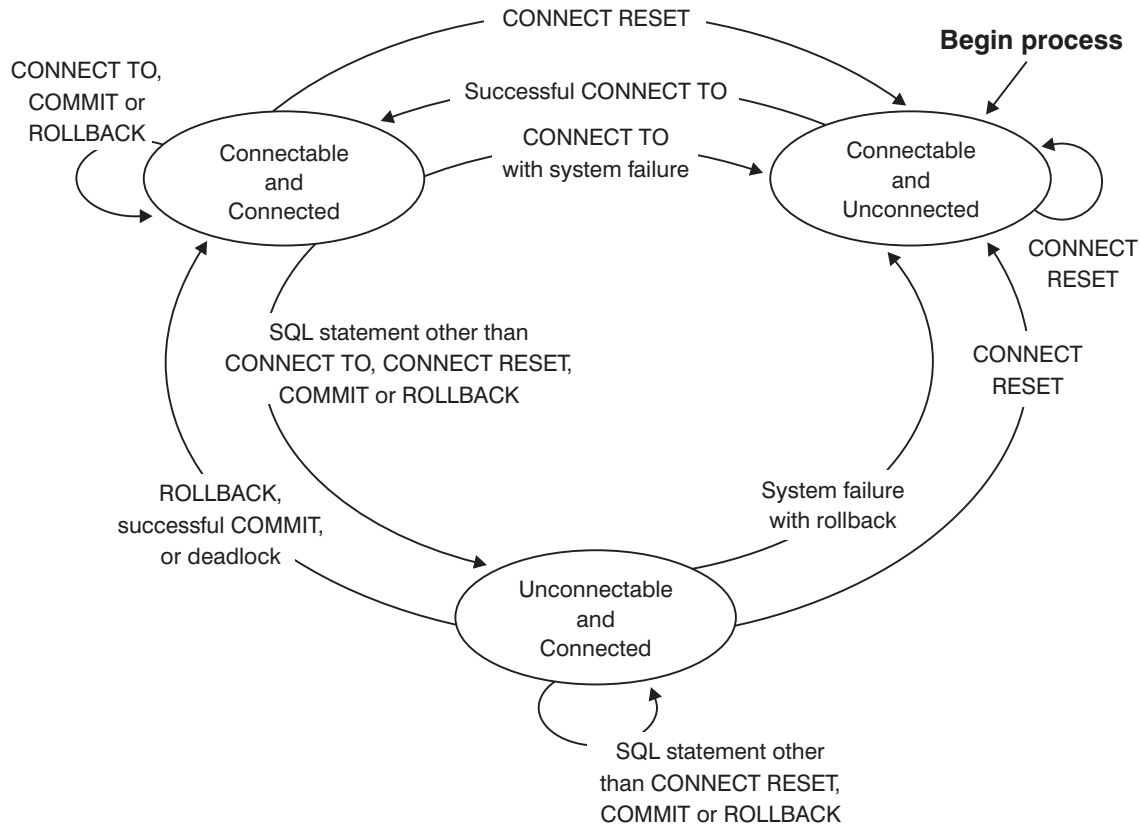

Figure 7. Connection State Transitions If Implicit Connect Is Not Available

## Application-directed distributed unit of work

The *application-directed distributed unit of work facility* also provides for the remote preparation and execution of SQL statements. An application process at computer system A can connect to an application server at computer system B by issuing a `CONNECT` or a `SET CONNECTION` statement. The application process can then execute any number of static and dynamic SQL statements that reference objects at B before ending the unit of work. All objects referenced in a single SQL statement must be managed by the same application server. However, unlike the remote unit of work facility, any number of application servers can participate in the same unit of work. A commit or a rollback operation ends the unit of work.

An application-directed distributed unit of work uses a type 2 connection. A *type 2* connection connects an application process to the identified application server, and establishes the rules for application-directed distributed units of work.

A type 2 application process:

- Is always connectable
- Is either in the connected state or in the unconnected state
- Has zero or more connections.

Each connection of an application process is uniquely identified by the database alias of the application server for the connection.

An individual connection always has one of the following connection states:

- current and held

## Application-directed distributed unit of work

- current and release-pending
- dormant and held
- dormant and release-pending

A type 2 application process is initially in the unconnected state, and does not have any connections. A connection is initially in the current and held state.

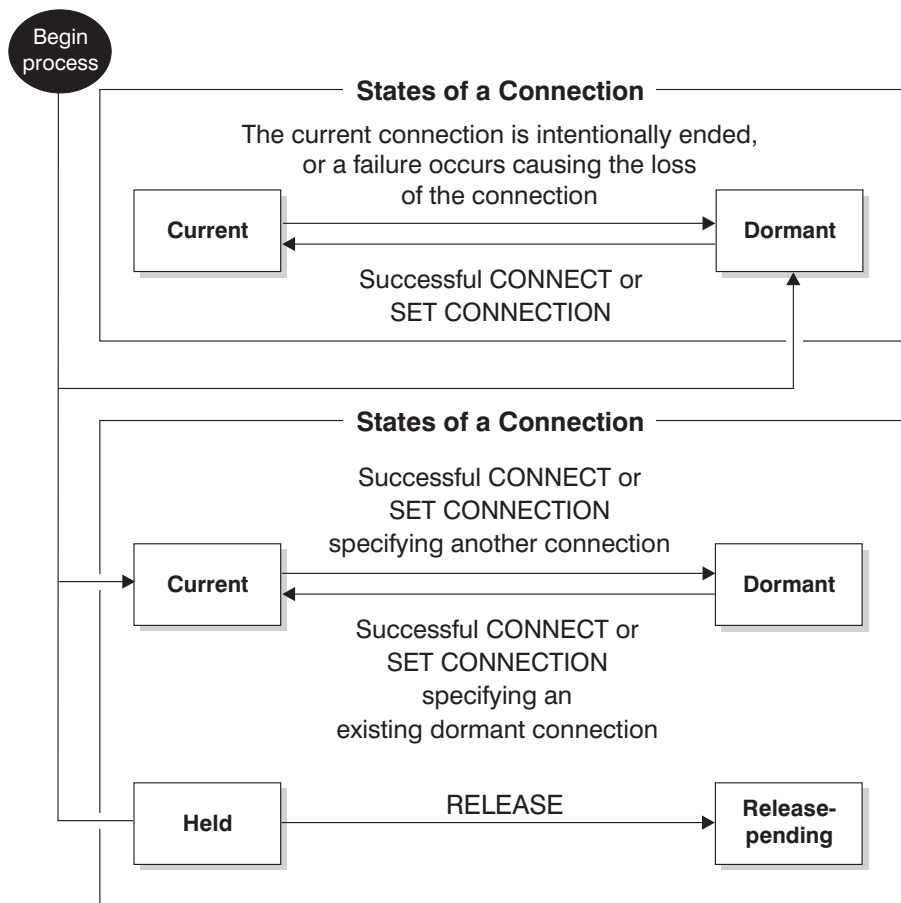

Figure 8. Application-Directed Distributed Unit of Work Connection State Transitions

### Application process connection states

The following rules apply to the execution of a `CONNECT` statement:

- A context cannot have more than one connection to the same application server at the same time.
- When an application process executes a `SET CONNECTION` statement, the specified location name must be an existing connection in the set of connections for the application process.
- When an application process executes a `CONNECT` statement, and the `SQLRULES(STD)` option is in effect, the specified server name must *not* be an existing connection in the set of connections for the application process. For a description of the `SQLRULES` option, see "Options that govern distributed unit of work semantics" on page 34.

**If an application process has a current connection**, the application process is in the *connected* state. The `CURRENT SERVER` special register contains the name of

the application server for the current connection. The application process can execute SQL statements that refer to objects managed by that application server.

An application process that is in the unconnected state enters the connected state when it successfully executes a CONNECT or a SET CONNECTION statement. If there is no connection, but SQL statements are issued, an implicit connect is made, provided the DB2DBDFT environment variable has been set with the name of a default database.

**If an application process does not have a current connection**, the application process is in the *unconnected* state. The only SQL statements that can be executed are CONNECT, DISCONNECT ALL, DISCONNECT (specifying a database), SET CONNECTION, RELEASE, COMMIT, ROLLBACK, and local SET statements.

An application process in the *connected state* enters the *unconnected state* when its current connection intentionally ends, or when an SQL statement fails, causing a rollback operation at the application server and loss of the connection. Connections end intentionally following the successful execution of a DISCONNECT statement, or a COMMIT statement when the connection is in release-pending state. (If the DISCONNECT precompiler option is set to AUTOMATIC, all connections end. If it is set to CONDITIONAL, all connections that do not have open WITH HOLD cursors end.)

### Connection states

If an application process executes a CONNECT statement, and the server name is known to the application requester but is not in the set of existing connections for the application process:

- The current connection is placed into the *dormant connection state*, and
- The server name is added to the set of connections, and
- The new connection is placed into both the *current connection state* and the *held connection state*.

If the server name is already in the set of existing connections for the application process, and the application is precompiled with the SQLRULES(STD) option, an error (SQLSTATE 08002) is raised.

**Held and release-pending states.** The RELEASE statement controls whether a connection is in the held or the release-pending state. The *release-pending* state means that a disconnect is to occur at the next successful commit operation. (A rollback has no effect on connections.) The *held* state means that a disconnect is *not* to occur at the next commit operation.

All connections are initially in the held state and can be moved to the release-pending state using the RELEASE statement. Once in the release-pending state, a connection cannot be moved back to the held state. A connection remains in release-pending state across unit of work boundaries if a ROLLBACK statement is issued, or if an unsuccessful commit operation results in a rollback operation.

Even if a connection is not explicitly marked for release, it may still be disconnected by a commit operation if the commit operation satisfies the conditions of the DISCONNECT precompiler option.

**Current and dormant states.** Regardless of whether a connection is in the held state or the release-pending state, it can also be in the current state or the dormant

## Connection states

state. A connection in the *current* state is the connection being used to execute SQL statements while in this state. A connection in the *dormant* state is a connection that is not current.

The only SQL statements that can flow on a dormant connection are COMMIT, ROLLBACK, DISCONNECT, or RELEASE. The SET CONNECTION and CONNECT statements change the connection state of the specified server to current, and any existing connections are placed or remain in dormant state. At any point in time, only one connection can be in current state. If a dormant connection becomes current in the same unit of work, the state of all locks, cursors, and prepared statements is the same as the state they were in the last time that the connection was current.

### When a connection ends

When a connection ends, all resources that were acquired by the application process through the connection, and all resources that were used to create and maintain the connection are de-allocated. For example, if the application process executes a RELEASE statement, any open cursors are closed when the connection ends during the next commit operation.

A connection can also end because of a communications failure. If this connection is in current state, the application process is placed in unconnected state.

All connections for an application process end when the process ends.

### Options that govern distributed unit of work semantics

The semantics of type 2 connection management are determined by a set of precompiler options. These options are summarized below with default values indicated by bold and underlined text.

- CONNECT (1 | 2). Specifies whether CONNECT statements are to be processed as type 1 or type 2.
- SQLRULES (DB2 | STD). Specifies whether type 2 CONNECTs are to be processed according to the DB2 rules, which allow CONNECT to switch to a dormant connection, or the SQL92 Standard rules, which do not allow this.
- DISCONNECT (EXPLICIT | CONDITIONAL | AUTOMATIC). Specifies what database connections are to be disconnected when a commit operation occurs:
  - Those that have been explicitly marked for release by the SQL RELEASE statement (EXPLICIT)
  - Those that have no open WITH HOLD cursors, and those that are marked for release (CONDITIONAL)
  - All connections (AUTOMATIC).
- SYNCPOINT (ONEPHASE | TWOPHASE | NONE). Specifies how COMMITS or ROLLBACKs are to be coordinated among multiple database connections. This option is ignored, and is included for backwards compatibility only.
  - Updates can only occur against one database in the unit of work, and all other databases are read-only (ONEPHASE). Any update attempts to other databases raise an error (SQLSTATE 25000).
  - A transaction manager (TM) is used at run time to coordinate two-phase COMMITS among those databases that support this protocol (TWOPHASE).
  - Does not use a TM to perform two-phase COMMITS, and does not enforce single updater, multiple reader (NONE). When a COMMIT or a ROLLBACK statement is executed, individual COMMITS or ROLLBACKs are posted to all



## Options that govern distributed unit of work semantics

databases. If one or more ROLLBACKs fail, an error (SQLSTATE 58005) is raised. If one or more COMMITs fail, another error (SQLSTATE 40003) is raised.

To override any of the above options at run time, use the SET CLIENT command or the sqlesetc application programming interface (API). Their current settings can be obtained using the QUERY CLIENT command or the sqleqryc API. Note that these are not SQL statements; they are APIs defined in the various host languages and in the command line processor (CLP).

## Data representation considerations

Different systems represent data in different ways. When data is moved from one system to another, data conversion must sometimes be performed. Products supporting DRDA<sup>®</sup> automatically perform any necessary conversions at the receiving system. To perform conversions of numeric data, the system needs to know the data type and how it is represented by the sending system. Additional information is needed to convert character strings. String conversion depends on both the code page of the data and the operation that is to be performed on that data. Character conversions are performed in accordance with the IBM<sup>®</sup> Character Data Representation Architecture (CDRA). For more information about character conversion, see the *Character Data Representation Architecture: Reference & Registry* (SC09-2190-00) manual.

### Related reference:

- “CONNECT (Type 1) statement” in *SQL Reference, Volume 2*
- “CONNECT (Type 2) statement” in *SQL Reference, Volume 2*

---

## Event monitors

Event monitors are used to collect information about the database and any connected applications when specified events occur. Events represent transitions in database activity such as connections, deadlocks, statements, or transactions. You can define an event monitor by the type of event or events you want it to monitor. For example, a deadlock event monitor waits for a deadlock to occur; when one does, it collects information about the applications involved and the locks in contention.

By default, all databases have an event monitor defined named DB2DETAILDEADLOCK, which records detailed information about deadlock events. The DB2DETAILDEADLOCK event monitor starts automatically when the database starts.

Whereas the snapshot monitor is typically used for preventative maintenance and problem analysis, event monitors are used to alert administrators to immediate problems or to track impending ones.

To create an event monitor, use the CREATE EVENT MONITOR SQL statement. Event monitors collect event data only when they are active. To activate or deactivate an event monitor, use the SET EVENT MONITOR STATE SQL statement. The status of an event monitor (whether it is active or inactive) can be determined by the SQL function EVENT\_MON\_STATE.

## Data representation considerations

When the CREATE EVENT MONITOR SQL statement is executed, the definition of the event monitor it creates is stored in the following database system catalog tables:

- SYSCAT.EVENTMONITORS: event monitors defined for the database.
- SYSCAT.EVENTS: events monitored for the database.
- SYSCAT.EVENTTABLES: target tables for table event monitors.

Each event monitor has its own private logical view of the instance's data in the monitor elements. If a particular event monitor is deactivated and then reactivated, its view of these counters is reset. Only the newly activated event monitor is affected; all other event monitors will continue to use their view of the counter values (plus any new additions).

Event monitor output can be directed to non-partitioned SQL tables, a file, or a named pipe.

### Related concepts:

- "Database system monitor" in *System Monitor Guide and Reference*

### Related tasks:

- "Collecting information about database system events" in *System Monitor Guide and Reference*
- "Creating an event monitor" in *System Monitor Guide and Reference*

### Related reference:

- "Event monitor sample output" in *System Monitor Guide and Reference*
- "Event types" in *System Monitor Guide and Reference*

---

## Database partitioning across multiple database partitions

DB2 allows great flexibility in spreading data across multiple database partitions (nodes) of a partitioned database. Users can choose how to distribute their data by declaring distribution keys, and can determine which and how many database partitions their table data can be spread across by selecting the database partition group and table space in which the data should be stored. In addition, a distribution map (which is updatable) specifies the mapping of distribution key values to database partitions. This makes it possible for flexible workload parallelization across a partitioned database for large tables, while allowing smaller tables to be stored on one or a small number of database partitions if the application designer so chooses. Each local database partition may have local indexes on the data it stores to provide high performance local data access.

In a partitioned database, the distribution key is used to distribute table data across a set of database partitions. Index data is also partitioned with its corresponding tables, and stored locally at each database partition.

Before database partitions can be used to store data, they must be defined to the database manager. Database partitions are defined in a file called db2nodes.cfg.

The distribution key for a table in a table space on a partitioned database partition group is specified in the CREATE TABLE statement or the ALTER TABLE statement. If not specified, a distribution key for a table is created by default from the first column of the primary key. If no primary key is defined, the default

## Database partitioning across multiple database partitions

distribution key is the first column defined in that table that has a data type other than a long or a LOB data type. Tables in partitioned databases must have at least one column that is neither a long nor a LOB data type. A table in a table space that is in a single partition database partition group will have a distribution key only if it is explicitly specified.

Rows are placed in a database partition as follows:

1. A hashing algorithm (database partitioning function) is applied to all of the columns of the distribution key, which results in the generation of a distribution map index value.
2. The database partition number at that index value in the distribution map identifies the database partition in which the row is to be stored.

DB2 supports *partial declustering*, which means that a table can be distributed across a subset of database partitions in the system (that is, a database partition group). Tables do not have to be distributed across all of the database partitions in the system.

DB2 has the capability of recognizing when data being accessed for a join or a subquery is located at the same database partition in the same database partition group. This is known as *table collocation*. Rows in collocated tables with the same distribution key values are located on the same database partition. DB2 can choose to perform join or subquery processing at the database partition in which the data is stored. This can have significant performance advantages.

Collocated tables must:

- Be in the same database partition group, one that is not being redistributed. (During redistribution, tables in the database partition group may be using different distribution maps – they are not collocated.)
- Have distribution keys with the same number of columns.
- Have the corresponding columns of the distribution key be database partition-compatible.
- Be in a single partition database partition group defined on the same database partition.

**Related reference:**

- “Database partition-compatible data types” on page 122

---

## Large object behavior in partitioned tables

A partitioned table uses a data organization scheme in which table data is divided across multiple storage objects, called data partitions or ranges, according to values in one or more table partitioning key columns of the table. Data from a given table is partitioned into multiple storage objects based on the specifications provided in the PARTITION BY clause of the CREATE TABLE statement. These storage objects can be in different table spaces, in the same table space, or a combination of both.

A large object for a partitioned table is, by default, stored in the same table space as its corresponding data object. This applies to partitioned tables that use only one table space or use multiple table spaces. When a partitioned table’s data is stored in multiple table spaces, the large object data is also stored in multiple table spaces.

## Database partitioning across multiple database partitions

Use the LONG IN clause of the CREATE TABLE statement to override this default behavior. You can specify a list of table spaces for the table where long data is to be stored. If you choose to override the default behavior, the table space specified in the LONG IN clause must be a large table space. If you specify that long data be stored in a separate table space for one or more data partitions, you must do so for all the data partitions of the table. That is, you cannot have long data stored remotely for some data partitions and stored locally for others. Whether you are using the default behavior or the LONG IN clause to override the default behavior, a long object is created to correspond to each data partition. For SMS table spaces, the long data must reside in the same table space as the data object it belongs to. All the table spaces used to store long data objects corresponding to each data partition must have the same: pagesize, extensize, storage mechanism (DMS or SMS), and type (regular or large). Remote long table spaces must be of type LARGE and cannot be SMS.

For example, the following CREATE TABLE statement creates objects for the CLOB data for each data partition in the same table space as the data:

```
CREATE TABLE document(id INT, contents CLOB)
PARTITION BY RANGE(id)
(STARTING FROM 1 ENDING AT 100 IN tbsp1,
 STARTING FROM 101 ENDING AT 200 IN tbsp2,
 STARTING FROM 201 ENDING AT 300 IN tbsp3,
 STARTING FROM 301 ENDING AT 400 IN tbsp4);
```

You can use LONG IN to place the CLOB data in one or more large table spaces, distinct from those the data is in.

```
CREATE TABLE document(id INT, contents CLOB)
PARTITION BY RANGE(id)
(STARTING FROM 1 ENDING AT 100 IN tbsp1 LONG IN large1,
 STARTING FROM 101 ENDING AT 200 IN tbsp2 LONG IN large1,
 STARTING FROM 201 ENDING AT 300 IN tbsp3 LONG IN large2,
 STARTING FROM 301 ENDING AT 400 IN tbsp4 LONG IN large2);
```

**Note:** Only a single LONG IN clause is allowed at the table level and for each data partition.

### Related concepts:

- “Data partitions” in *Administration Guide: Planning*
- “Understanding index behavior on partitioned tables” in *Performance Guide*
- “Large object (LOB) column considerations” in *Administration Guide: Implementation*
- “Partitioned materialized query table behavior” in *Administration Guide: Implementation*
- “Optimization strategies for partitioned tables” in *Performance Guide*
- “Partitioned tables” in *Administration Guide: Planning*
- “Space requirements for large object data” in *Administration Guide: Planning*
- “Table partitioning” in *Administration Guide: Planning*

### Related tasks:

- “Creating partitioned tables” in *Administration Guide: Implementation*

### Related reference:

- “CREATE TABLE statement” in *SQL Reference, Volume 2*
- “Large objects (LOBs)” on page 87

## DB2 federated systems

### Federated systems

A *federated system* is a special type of distributed database management system (DBMS). A federated system consists of a DB2 instance that operates as a federated server, a database that acts as the federated database, one or more data sources, and clients (users and applications) that access the database and data sources.

With a federated system, you can send distributed requests to multiple data sources within a single SQL statement. For example, you can join data that is located in a DB2 table, an Oracle table, and an XML tagged file in a single SQL statement. The following figure shows the components of a federated system and a sample of the data sources you can access.

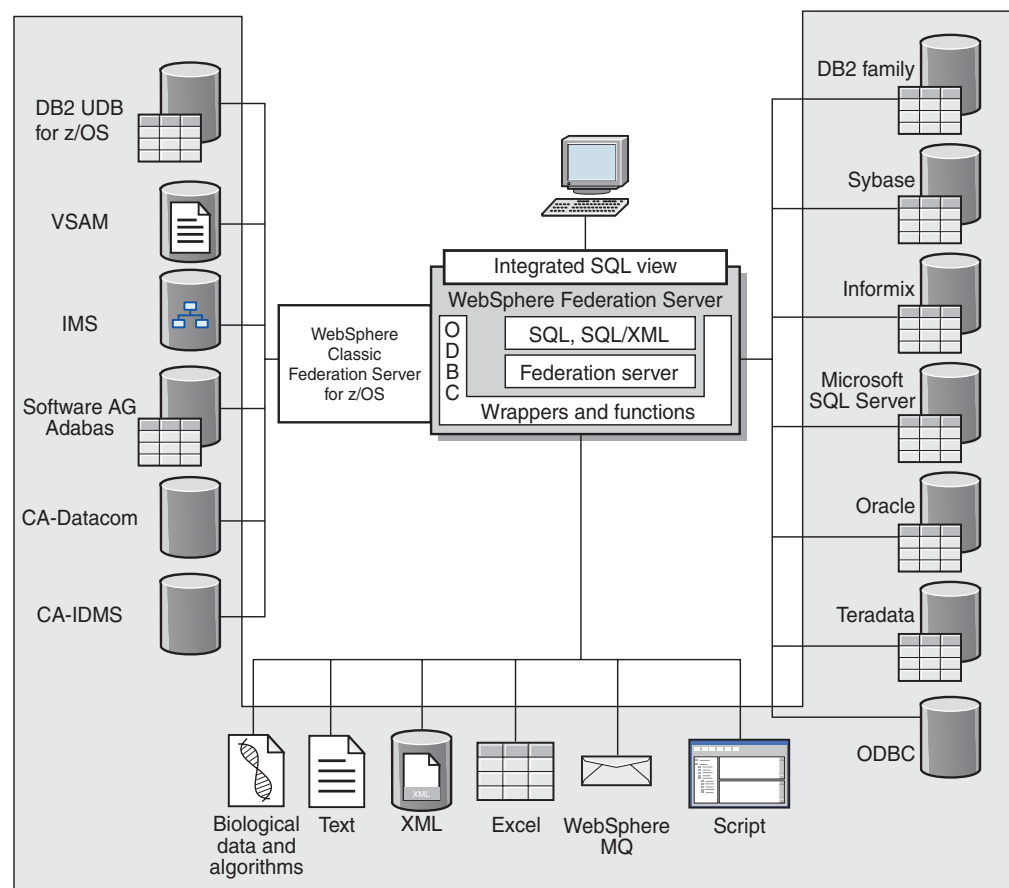

Figure 9. The components of a federated system

The power of a federated system is in its ability to:

- Correlate data from local tables and remote data sources, as if all the data is stored locally in the federated database
- Update data in relational data sources, as if the data is stored in the federated database
- Move data to and from relational data sources
- Take advantage of the data source processing strengths, by sending requests to the data sources for processing

## DB2 federated systems

- Compensate for SQL limitations at the data source by processing parts of a distributed request at the federated server

### What is a data source?

In a federated system, a *data source* can be a relational database (such as Oracle or Sybase) or a nonrelational data source (such as a BLAST search algorithm or an XML tagged file).

Through some data sources you can access other data sources. For example, with the ODBC wrapper you can access WebSphere® Classic Federation server for z/OS data sources such as DB2 UDB for z/OS, IMS™, CA-IDMS, CA-Datcom, Software AG Adabas, and VSAM.

The method, or protocol, used to access a data source depends on the type of data source. For example, DRDA® is used to access DB2® for z/OS™ data sources.

Data sources are autonomous. For example, the federated server can send queries to Oracle data sources at the same time that Oracle applications can access these data sources. A federated system does not monopolize or restrict access to the other data sources, beyond integrity and locking constraints.

### The federated database

To end users and client applications, data sources appear as a single collective database in DB2®. Users and applications interface with the *federated database* that is managed by the federated server.

The federated database contains a system catalog that stores information about data. The federated database system catalog contains entries that identify data sources and their characteristics. The federated server consults the information stored in the federated database system catalog and the data source wrapper to determine the best plan for processing SQL statements.

The federated system processes SQL statements as if the data from the data sources were ordinary relational tables or views within the federated database. As a result:

- The federated system can correlate relational data with data in nonrelational formats. This is true even when the data sources use different SQL dialects, or do not support SQL at all.
- The characteristics of the federated database take precedence when there are differences between the characteristics of the federated database and the characteristics of the data sources. Query results conform to DB2 semantics, even if data from other non-DB2 data sources is used to compute the query result.

Examples:

- The code page that the federated server uses is different than the code page used that the data source uses. In this case, character data from the data source is converted based on the code page used by the federated database, when that data is returned to a federated user.
- The collating sequence that the federated server uses is different than the collating sequence that the data source uses. In this case, any sort operations on character data are performed at the federated server instead of at the data source.

### The SQL compiler

The DB2 SQL compiler gathers information to help it process queries.

To obtain data from data sources, users and applications submit queries in SQL to the federated database. When a query is submitted, the DB2 SQL compiler consults information in the global catalog and the data source wrapper to help it process the query. This includes information about connecting to the data source, server information, mappings, index information, and processing statistics.

## Wrappers and wrapper modules

*Wrappers* are mechanisms by which the federated database interacts with data sources. The federated database uses routines stored in a library called a *wrapper module* to implement a wrapper.

These routines allow the federated database to perform operations such as connecting to a data source and retrieving data from it iteratively. Typically, the federated instance owner uses the CREATE WRAPPER statement to register a wrapper in the federated database. You can register a wrapper as fenced or trusted using the DB2\_FENCED wrapper option.

You create one wrapper for each type of data source that you want to access. For example, you want to access three DB2 for z/OS™ database tables, one DB2 for iSeries™ table, two Informix® tables, and one Informix view. In this case, you need to create one wrapper for the DB2 data source objects and one wrapper for the Informix data source objects. After these wrappers are registered in the federated database, you can use these wrappers to access other objects from those data sources. For example, you can use the DRDA® wrapper with all DB2 family data source objects—DB2 Version 9.1 for Linux, UNIX®, and Windows®, DB2 for z/OS, DB2 for iSeries, and DB2 Server for VM and VSE.

You use the server definitions and nicknames to identify the specifics (name, location, and so forth) of each data source object.

A wrapper performs many tasks. Some of these tasks are:

- It connects to the data source. The wrapper uses the standard connection API of the data source.
- It submits queries to the data source.
  - For data sources that support SQL, the query is submitted in SQL.
  - For data sources that do not support SQL, the query is translated into the native query language of the source or into a series of source API calls.
- It receives results sets from the data source. The wrapper uses the data source standard APIs for receiving results set.
- It responds to federated database queries about the default data type mappings for a data source. The wrapper contains the default type mappings that are used when nicknames are created for a data source object. For relational wrappers, data type mappings that you create override the default data type mappings. User-defined data type mappings are stored in the global catalog.
- It responds to federated database queries about the default function mappings for a data source. The federated database needs data type mapping information for query planning purposes. The wrapper contains information that the federated database needs to determine if DB2 functions are mapped to functions of the data source, and how the functions are mapped. This information is used by the SQL Compiler to determine if the data source is able to perform the query operations. For relational wrappers, function mappings that you create override the default function type mappings. User-defined function mappings are stored in the global catalog.

*Wrapper options* are used to configure the wrapper or to define how WebSphere Federation Server uses the wrapper.

### Server definitions and server options

After wrappers are created for the data sources, the federated instance owner defines the data sources to the federated database.

The instance owner supplies a name to identify the data source, and other information that pertains to the data source. This information includes:

- The type and version of the data source
- The database name for the data source (RDBMS only)
- Metadata that is specific to the data source

For example, a DB2<sup>®</sup> family data source can have multiple databases. The definition must specify which database the federated server can connect to. In contrast, an Oracle data source has one database, and the federated server can connect to the database without knowing its name. The database name is not included in the federated server definition of an Oracle data source.

The name and other information that the instance owner supplies to the federated server are collectively called a *server definition*. Data sources answer requests for data and are servers in their own right.

The CREATE SERVER and ALTER SERVER statements are used to create and modify a server definition.

Some of the information within a server definition is stored as *server options*. When you create server definitions, it is important to understand the options that you can specify about the server.

Server options can be set to persist over successive connections to the data source, or set for the duration of a single connection.

### User mappings

Typically, you need to define an association between the federated server and a data source.

When a federated server needs to pushdown a request to a data source, the server must first establish a connection to the data source. For most data sources, the federated server does this by using a valid user ID and password to that data source. When a user ID and password is required to connect to a data source, you can define an association between the federated server authorization ID and the data source user ID and password. This association can be created for each user ID that will be using the federated system to send distributed requests. This association is called a *user mapping*.

In some cases, you do not need to create a user mapping if the user ID and password that you use to connect to the federated database are the same as those that you use to access the remote data source. You can create and store the user mappings in the federated database, or you can store the user mappings in an external repository, such as LDAP.



## Nicknames and data source objects

After you create the server definitions and user mappings, the federated instance owner creates the nicknames. A nickname is an identifier that is used to reference the object located at the data sources that you want to access. The objects that nicknames identify are referred to as data source objects.

Nicknames are not alternative names for data source objects in the same way that aliases are alternative names. They are pointers by which the federated server references these objects. Nicknames are typically defined with the CREATE NICKNAME statement along with specific nickname column options and nickname options.

When an end user or a client application submits a distributed request to the federated server, the request does not need to specify the data sources. Instead, the request references the data source objects by their nicknames. The nicknames are mapped to specific objects at the data source. These mappings eliminate the need to qualify the nicknames by data source names. The location of the data source objects is transparent to the end user or the client application.

Suppose that you define the nickname *DEPT* to represent an Informix® database table called *NFX1.PERSON*. The statement `SELECT * FROM DEPT` is allowed from the federated server. However, the statement `SELECT * FROM NFX1.PERSON` is not allowed from the federated server (except in a pass-through session) unless there is a local table on the federated server named *NFX1.PERSON*.

When you create a nickname for a data source object, metadata about the object is added to the global catalog. The query optimizer uses this metadata, and the information in the wrapper, to facilitate access to the data source object. For example, if the nickname is for a table that has an index, the global catalog contains information about the index. The wrapper contains the mappings between the DB2® data types and the data source data types.

Nickname data based on data source objects that use a labeling security system are not ordinarily cached, so data in the object remains secure. For example with the Oracle Net8 wrapper, if you create a nickname on an Oracle table that uses Oracle Label Security, the table is automatically identified as secure. The resulting nickname data cannot be cached which means that materialized query tables cannot be created on it. This setting ensures that the information is viewed only by users with the appropriate authority on the Oracle system. Nicknames that were created on data source objects that use Oracle Label Security before this feature was available need to be changed to disallow caching. You can use the ALTER NICKNAME statement to allow or disallow caching on a nickname. All other nicknames based on wrappers other than Oracle Net8 must use the ALTER NICKNAME statement to disable data caching on the federated server.

Currently, you cannot execute some DB2 utility operations on nicknames, such as RUNSTATS.

You cannot use the Cross Loader utility to cross load into a nickname.

## Nickname column options

You can supply the global catalog with additional metadata information about the nicknamed object. This metadata describes values in certain columns of the data source object. You assign this metadata to parameters that are called *nickname column options*.

## DB2 federated systems

The nickname column options tell the wrapper to handle the data in a column differently than it normally would handle it. The SQL compiler and query optimizer use the metadata to develop better plans for accessing the data.

Nickname column options are used to provide other information to the wrapper as well. For example for XML data sources, a nickname column option is used to tell the wrapper the XPath expression to use when the wrapper parses the column out of the XML document.

With federation, the DB2® server treats the data source object that a nickname references as if it is a local DB2 table. As a result, you can set nickname column options for any data source object that you create a nickname for. Some nickname column options are designed for specific types of data sources and can be applied only to those data sources.

Suppose that a data source has a collating sequence that differs from the federated database collating sequence. The federated server typically would not sort any columns containing character data at the data source. It would return the data to the federated database and perform the sort locally. However, suppose that the column is a character data type (CHAR or VARCHAR) and contains only numeric characters ('0','1',...,'9'). You can indicate this by assigning a value of 'Y' to the NUMERIC\_STRING nickname column option. This gives the DB2 query optimizer the option of performing the sort at the data source. If the sort is performed remotely, you can avoid the overhead of porting the data to the federated server and performing the sort locally.

You can define nickname column options for relational nicknames using the ALTER NICKNAME statements. You can define nickname column options for nonrelational nicknames using the CREATE NICKNAME and ALTER NICKNAME statements.

## Data type mappings

The data types at the data source must map to corresponding DB2® data types so that the federated server can retrieve data from data sources.

Some examples of default data type mappings are:

- The Oracle type FLOAT maps to the DB2 type DOUBLE
- The Oracle type DATE maps to the DB2 type TIMESTAMP
- The DB2 for z/OS™ type DATE maps to the DB2 type DATE

For most data sources, the default type mappings are in the wrappers. The default type mappings for DB2 data sources are in the DRDA® wrapper. The default type mappings for Informix® are in the INFORMIX wrapper, and so forth.

For some nonrelational data sources, you must specify data type information in the CREATE NICKNAME statement. The corresponding DB2 data types must be specified for each column of the data source object when the nickname is created. Each column must be mapped to a particular field or column in the data source object.

For relational data sources, you can override the default data type mappings. For example, by default the Informix INTEGER data type maps to the DB2 INTEGER data type. You could override the default mappings and map Informix's INTEGER data type to DB2 DECIMAL(10,0) data type.

## The federated server

The DB2<sup>®</sup> server in a federated system is referred to as the federated server. Any number of DB2 instances can be configured to function as federated servers. You can use existing DB2 instances as your federated servers, or you can create new ones specifically for the federated system.

The DB2 instance that manages the federated system is called a server because it responds to requests from end users and client applications. The federated server often sends parts of the requests it receives to the data sources for processing. A pushdown operation is an operation that is processed remotely. The DB2 instance that manages the federated system is referred to as the federated server, even though it acts as a client when it pushes down requests to the data sources.

Like any other application server, the federated server is a database manager instance. Application processes connect and submit requests to the database within the federated server. However, two main features distinguish it from other application servers:

- A federated server is configured to receive requests that might be partially or entirely intended for data sources. The federated server distributes these requests to the data sources.
- Like other application servers, a federated server uses DRDA<sup>®</sup> communication protocols (over TCP/IP) to communicate with DB2 family instances. However, unlike other application servers, a federated server uses the native client of the data source to access the data source. For example, a federated server uses the Sybase Open Client to access Sybase data sources and an Microsoft<sup>®</sup> SQL Server ODBC Driver to access Microsoft SQL Server data sources.

## Supported data sources

There are many data sources that you can access using a federated system.

The following table lists the supported data sources:

*Table 1. Supported data source versions and access methods.*

| Data source                                  | Supported versions  | Access methods and requirements          |
|--|---|--|
| BLAST  | 2.2.3 through 2.2.8<br>fixpacks supported   | BLAST daemon (supplied with the wrapper) |
| BioRS  | 5.2.x.x   | HTTP                                     |
| DB2 Database for Linux, UNIX, and Windows    | 8.1, 8.2, 9.1   | DRDA                                     |
| DB2 Universal Database <sup>™</sup> for z/OS | 6.1, 7.1 with the following APARs applied: <ul style="list-style-type: none"> <li>• PQ62695</li> <li>• PQ55393</li> <li>• PQ56616</li> <li>• PQ54605</li> <li>• PQ46183</li> <li>• PQ62139</li> </ul> | DRDA                                     |
|  | 8.1   |  |

## DB2 federated systems

Table 1. Supported data source versions and access methods. (continued)

| Data source                        | Supported versions  | Access methods and requirements  |
|------------------------------------|---|--|
| DB2 Universal Database for iSeries | 5.2 with the following APARs and PTFs applied: <ul style="list-style-type: none"> <li>• APAR SE06003, PTF SI04582</li> <li>• APAR SE07533, PTF SI05991</li> <li>• APAR SE08416, PTF SI07135</li> <li>• APAR II13348, PTFs SF99502, SI11626, SI11378</li> </ul> 5.3<br>5.4 with APAR SE23546, PTF SI21661 applied. | DRDA   |
| DB2 Server for VM and VSE          | 7.1 (or later) with fixes for APARs for schema functions applied.   | DRDA   |
| Entrez                             | Supported   | HTTP.  |
| GenBank                            | Supported   | HTTP. Connection to the NCBI through the Web. Use the Entrez wrapper to access this data source.   |
| HMMER                              | 2.2g, 2.3   | HMMER daemon (supplied with the wrapper)   |
| Informix®                          | 7.31, 8.4, 8.5, 9.4, 10.0   | Informix Client SDK V2.81 (or later)<br><br>On Solaris, the Informix client SDK version 2.81.FC2 is not supported. If you are using the Informix client version 2.81.FC2, update the client to version 2.81.FC2R1 or later.<br><br>On Windows, the Informix client SDK version 2.81.TC2 or later.<br><br>On the 64-bit mode zLinux operating system, the Informix client version 2.81.FC1 or 2.81.FC2 is not supported. If you are using one of those client versions, update the client to version 2.81.FC3 or later. |
| KEGG                               | KEGG API 3.2  | User-defined functions for KEGG  |

Table 1. Supported data source versions and access methods. (continued)

| Data source          | Supported versions                                     | Access methods and requirements  |
|----------------------|--|--|
| Microsoft Excel      | 97, 2000, 2002, 2003                                   | Excel 97, 2000, 2002, or 2003 installed on the federated server  |
| Microsoft SQL Server | 2000 SP3 and later service packs on that release, 2005 | On Windows, the Microsoft SQL Server Client ODBC 3.0 (or later) driver.<br><br>On UNIX:<br><ul style="list-style-type: none"> <li>• DataDirect Technologies (formerly MERANT) Connect ODBC 4.2 (or later) driver.</li> <li>• Microsoft SQL Server wrapper with a UTF-8 database requires DataDirect Connect for ODBC 4.2 Service Pack 2 or later.</li> </ul> |
| ODBC                 | 3.x  | ODBC driver for the data source. ODBC driver access to Redbrick and ODBC driver access to WebSphere Classic Federation Server for z/OS data sources, such as IMS, VSAM, CA-Datcom, CA-IDMS, and Software AG Adabas.  |
| OLE DB               | 2.7, 2.8   | OLE DB 2.0 (or later)  |
| OMIM                 | Supported  | HTTP. Connection to the NCBI through the Web and the OMIM query.fcgi utility. Use the Entrez wrapper to access this data source.   |
| Oracle               | 8.1.7, 9.0, 9.1, 9.2, 9i, 10g                          | Oracle net client or NET8 client software  |
| PeopleSoft           | 8.x  | IBM WebSphere Business Integration Adapter for PeopleSoft v2.3.1, 2.4. Requires WebSphere MQ Series.   |
| PubMed               | Supported  | HTTP. Connection to the NCBI through the Web. Use the Entrez wrapper to access this data source.   |
| SAP                  | 3.x, 4.x   | IBM WebSphere Business Integration Adapter for mySAP.com v2.3.1, 2.4. Requires WebSphere MQ Series.  |
| Script               |  | Script daemon (supplied with the wrapper)  |

## DB2 federated systems

Table 1. Supported data source versions and access methods. (continued)

| Data source            | Supported versions                           | Access methods and requirements  |
|------------------------|--|--|
| Siebel                 | 7, 7.5, 2000                                 | IBM WebSphere Business Integration Adapter for Siebel eBusiness Applications v2.3.1, 2.4. Requires WebSphere MQ Series.  |
| Sybase                 | 12.0, 12.5                                   | Sybase Open Client ctlib interface   |
| Table-structured files |  | None   |
| Teradata               | V2R4, V2R5, V2R6                             | Teradata Call-Level Interface, Version 2 (CLIV2) Release 04.06 (or later)<br><br>On Windows, the Teradata client TTU 7.0 or later and the Teradata API library CLIV2 4.7.0 or later on the federated server. |
| Web services           | SOAP 1.0., 1.1, WSDL 1.0, 1.1 specifications | HTTP, HTTPS. SOAP user-defined functions consume Web services.   |
| WebSphere MQ           | Server edition 6.0                           | WebSphere MQ user-defined functions in schemas DB2MQ, DB2MQ1C, and DB2MQT.   |
| XML                    | 1.0 specification                            | None   |

## The federated database system catalog

The federated database system catalog contains information about the objects in the federated database and information about objects at the data sources.

The catalog in a federated database is called the global catalog because it contains information about the entire federated system. DB2<sup>®</sup> query optimizer uses the information in the global catalog and the data source wrapper to plan the best way to process SQL statements. The information stored in the global catalog includes remote and local information, such as column names, column data types, column default values, index information, and statistics information.

Remote catalog information is the information or name used by the data source. Local catalog information is the information or name used by the federated database. For example, suppose a remote table includes a column with the name of *EMPNO*. The global catalog would store the remote column name as *EMPNO*. Unless you designate a different name, the local column name will be stored as *EMPNO*. You can change the local column name to *Employee\_Number*. Users submitting queries which include this column will use *Employee\_Number* in their queries instead of *EMPNO*. You use the ALTER NICKNAME statement to change the local name of the data source columns.

For relational and nonrelational data sources, the information stored in the global catalog includes both remote and local information.

To see the data source table information that is stored in the global catalog, query the SYSCAT.TABLES, SYSCAT.NICKNAMES, SYSCAT.TABOPTIONS, SYSCAT.INDEXES, SYSCAT.INDEXOPTIONS, SYSCAT.COLUMNS, and SYSCAT.COLOPTIONS catalog views in the federated database.

The global catalog also includes other information about the data sources. For example, the global catalog includes information that the federated server uses to connect to the data source and map the federated user authorizations to the data source user authorizations. The global catalog contains attributes about the data source that you explicitly set, such as server options.

## The query optimizer

As part of the SQL compiler process, the query optimizer analyzes a query. The compiler develops alternative strategies, called access plans, for processing the query.

Access plans might call for the query to be:

- Processed by the data sources
- Processed by the federated server
- Processed partly by the data sources and partly by the federated server

The query optimizer evaluates the access plans primarily on the basis of information about the data source capabilities and the data. The wrapper and the global catalog contain this information. The query optimizer decomposes the query into segments that are called query fragments. Typically it is more efficient to pushdown a query fragment to a data source, if the data source can process the fragment. However, the query optimizer takes into account other factors such as:

- The amount of data that needs to be processed
- The processing speed of the data source
- The amount of data that the fragment will return
- The communication bandwidth
- Whether there is a usable materialized query table on the federated server that represents the same query result

The query optimizer generates access plan alternatives for processing a query fragment. The plan alternatives perform varying amounts of work locally on the federated server and on the remote data sources. Because the query optimizer is cost-based, it assigns resource consumption costs to the access plan alternatives. The query optimizer then chooses the plan that will process the query with the least resource consumption cost.

If any of the fragments are to be processed by data sources, the federated database submits these fragments to the data sources. After the data sources process the fragments, the results are retrieved and returned to the federated database. If the federated database performed any part of the processing, it combines its results with the results retrieved from the data source. The federated database then returns all results to the client.

## Collating sequences

The order in which character data is sorted in a database depends on the structure of the data and the collating sequence defined for the database.

## DB2 federated systems

Suppose that the data in a database is all uppercase letters and does not contain any numeric or special characters. A sort of the data should result in the same output, regardless of whether the data is sorted at the data source or at the federated database. The collating sequence used by each database should not impact the sort results. Likewise, if the data in the database is all lowercase letters or all numeric characters, a sort of the data should produce the same results regardless of where the sort actually is performed.

If the data consists of any of the following structures:

- A combination of letters and numeric characters
- Both uppercase and lowercase letters
- Special characters such as @, #, €

Sorting this data can result in different outputs, if the federated database and the data source use different collating sequences.

In general terms, a collating sequence is a defined ordering for character data that determines whether a particular character sorts higher, lower, or the same as another character.

### How collating sequences determine sort orders

A collating sequence determines the sort order of the characters in a coded character set.

A character set is the aggregate of characters that are used in a computer system or programming language. In a coded character set, each character is assigned to a different number within the range of 0 to 255 (or the hexadecimal equivalent thereof). The numbers are called code points; the assignments of numbers to characters in a set are collectively called a code page.

In addition to being assigned to a character, a code point can be mapped to the character's position in a sort order. In technical terms, then, a collating sequence is the collective mapping of a character set's code points to the sort order positions of the set's characters. A character's position is represented by a number; this number is called the weight of the character. In the simplest collating sequence, called an identity sequence, the weights are identical to the code points.

Suppose that database ALPHA uses the default collating sequence of the EBCDIC code page, and that database BETA uses the default collating sequence of the ASCII code page. Sort orders for character strings at these two databases would differ, as shown in the following example:

```
SELECT.....  
ORDER BY COL2
```

| EBCDIC-Based Sort | ASCII-Based Sort |
|-------------------|------------------|
| COL2              | COL2             |
| ----              | ----             |
| V1G               | 7AB              |
| Y2W               | V1G              |
| 7AB               | Y2W              |

Similarly, character comparisons in a database depend on the collating sequence defined for that database. In this example, database ALPHA uses the default collating sequence of the EBCDIC code page. Database BETA uses the default collating sequence of the ASCII code page. Character comparisons at these two databases would yield different results, as shown in the following example:



```
SELECT.....
  WHERE COL2 > 'TT3'
```

| EBCDIC-Based Results | ASCII-Based Results |
|----------------------|---------------------|
| COL2                 | COL2                |
| ----                 | ----                |
| TW4                  | TW4                 |
| X82                  | X82                 |
| 39G                  |                     |

### Setting the local collating sequence to optimize queries

Administrators can create federated databases with a particular collating sequence that matches a data source collating sequence.

Then for each data source server definition, the `COLLATING_SEQUENCE` server option is set to 'Y'. This setting tells the federated database that the collating sequences of the federated database and the data source match.

You set the federated database collating sequence as part of the `CREATE DATABASE` API. Through this API, you can specify one of the following sequences:

- An identity sequence
- A system sequence (the sequence used by the operating system that supports the database)
- A customized sequence (a predefined sequence that DB2 supplies or that you define yourself)

Suppose that the data source is DB2 for z/OS. Sorts that are defined in an `ORDER BY` clause are implemented by a collating sequence based on an EBCDIC code page. To retrieve DB2 for z/OS data sorted in accordance with `ORDER BY` clauses, configure the federated database so that it uses the predefined collating sequence based on the appropriate EBCDIC code page.



---

## Chapter 2. Language elements

This chapter describes the language elements that are common to many SQL statements:

- “Characters”
- “Tokens” on page 55
- “Identifiers” on page 57
- “Data types” on page 78
- “Constants” on page 124
- “Special registers” on page 127
- “Functions” on page 157
- “Methods” on page 165
- “Expressions” on page 173
- “Predicates” on page 207

---

### Characters

The basic symbols of keywords and operators in the SQL language are single-byte characters that are part of all IBM character sets. Characters of the language are classified as letters, digits, or special characters.

A *letter* is any of the 26 uppercase (A through Z) or 26 lowercase (a through z) letters, plus the three characters \$, #, and @, which are included for compatibility with host database products. For example, in code page 850, \$ is at X'24', # is at X'23', and @ is at X'40'). Letters also include the alphabets from the extended character sets. Extended character sets contain additional alphabetic characters; for example, those with diacritical marks (´ is an example of a diacritical mark). The available characters depend on the code page in use.

A *digit* is any of the characters 0 through 9.

A *special character* is any of the characters listed below:

| Character | Description   | Character | Description             |
|-----------|---|-----------|-------------------------|
|           | space or blank  | –         | minus sign              |
| "         | quotation mark or double quote or double quotation mark | .         | period                  |
| %         | percent   | /         | slash                   |
| &         | ampersand   | :         | colon                   |
| '         | apostrophe or single quote or single quotation mark     | ;         | semicolon               |
| (         | left parenthesis  | <         | less than               |
| )         | right parenthesis                                       | =         | equals                  |
| *         | asterisk  | >         | greater than            |
| +         | plus sign   | ?         | question mark           |
| ,         | comma   | _         | underline or underscore |

## Characters

| Character | Description               | Character | Description   |
|-----------|---------------------------|-----------|---------------|
|           | vertical bar <sup>1</sup> | ^         | caret         |
| !         | exclamation mark          | [         | left bracket  |
| {         | left brace                | ]         | right bracket |
| }         | right brace               |           |               |

<sup>1</sup> Using the vertical bar (|) character might inhibit code portability between IBM relational products. Use the CONCAT operator in place of the || operator.

All multi-byte characters are treated as letters, except for the double-byte blank, which is a special character.

## Tokens

Tokens are the basic syntactical units of SQL. A *token* is a sequence of one or more characters. A token cannot contain blank characters, unless it is a string constant or a delimited identifier, which may contain blanks.

Tokens are classified as ordinary or delimiter:

- An *ordinary token* is a numeric constant, an ordinary identifier, a host identifier, or a keyword.

*Examples*

```
1      .1      +2      SELECT      E      3
```

- A *delimiter token* is a string constant, a delimited identifier, an operator symbol, or any of the special characters shown in the syntax diagrams. A question mark is also a delimiter token when it serves as a parameter marker.

*Examples*

```
,      'string'      "fld1"      =      .
```

**Spaces:** A space is a sequence of one or more blank characters. Tokens other than string constants and delimited identifiers must not include a space. Any token may be followed by a space. Every ordinary token must be followed by a space or a delimiter token if allowed by the syntax.

**Comments:** SQL comments are either bracketed (introduced by `/*` and end with `*/`) or simple (introduced by two consecutive hyphens and end with the end of line). Static SQL statements can include host language comments or SQL comments. Comments can be specified wherever a space can be specified, except within a delimiter token or between the keywords EXEC and SQL.

**Case sensitivity:** Any token may include lowercase letters, but a lowercase letter in an ordinary token is folded to uppercase, except for host variables in the C language, which has case-sensitive identifiers. Delimiter tokens are never folded to uppercase. Thus, the statement:

```
select * from EMPLOYEE where lastname = 'Smith';
```

is equivalent, after folding, to:

```
SELECT * FROM EMPLOYEE WHERE LASTNAME = 'Smith';
```

Multi-byte alphabetic letters are not folded to uppercase. Single-byte characters (a to z) *are* folded to uppercase.

For characters in Unicode:

- A character is folded to uppercase, if applicable, if the uppercase character in UTF-8 has the same length as the lowercase character in UTF-8. For example, the Turkish lowercase dotless 'i' is not folded, because in UTF-8, that character has the value X'C4B1', but the uppercase dotless 'I' has the value X'49'.
- The folding is done in a locale-insensitive manner. For example, the Turkish lowercase dotted 'i' is folded to the English uppercase (dotless) 'I'.
- Both halfwidth and fullwidth alphabetic letters are folded to uppercase. For example, the fullwidth lowercase 'a' (U+FF41) is folded to the fullwidth uppercase 'A' (U+FF21).

**Related reference:**

- "PREPARE statement" in *SQL Reference, Volume 2*

## Tokens

- “How SQL statements are invoked” in *SQL Reference, Volume 2*

## Identifiers

An *identifier* is a token that is used to form a name. An identifier in an SQL statement is either an SQL identifier or a host identifier.

- SQL identifiers

There are two types of *SQL identifiers*: ordinary and delimited.

- An *ordinary identifier* is an uppercase letter followed by zero or more characters, each of which is an uppercase letter, a digit, or the underscore character. An ordinary identifier should not be identical to a reserved word.

*Examples*

```
WKLYSAL    WKLY_SAL
```

- A *delimited identifier* is a sequence of one or more characters enclosed by double quotation marks. Two consecutive quotation marks are used to represent one quotation mark within the delimited identifier. In this way an identifier can include lowercase letters.

*Examples*

```
"WKLY_SAL"    "WKLY SAL"    "UNION"    "wkly_sal"
```

Character conversion of identifiers created on a double-byte code page, but used by an application or database on a multi-byte code page, may require special consideration: After conversion, such identifiers may exceed the length limit for an identifier.

- Host identifiers

A *host identifier* is a name declared in the host program. The rules for forming a host identifier are the rules of the host language. A host identifier should not be greater than 255 bytes in length and should not begin with SQL or DB2 (in uppercase or lowercase characters).

## Naming conventions and implicit object name qualifications

The rules for forming the name of an object depend on the object type. Database object names may be made up of a single identifier, or they may be schema-qualified objects made up of two identifiers. Schema-qualified object names may be specified without the schema name; in such cases, the schema name is implicit.

In dynamic SQL statements, a schema-qualified object name implicitly uses the CURRENT SCHEMA special register value as the qualifier for unqualified object name references. By default it is set to the current authorization ID. If the dynamic SQL statement is contained in a package that exhibits bind, define, or invoke behaviour, the CURRENT SCHEMA special register is not used for qualification. In a bind behaviour package, the package default qualifier is used as the value for implicit qualification of unqualified object references. In a define behaviour package, the authorization ID of the routine definer is used as the value for implicit qualification of unqualified object references within that routine. In an invoke behaviour package, the statement authorization ID in effect when the routine is invoked is used as the value for implicit qualification of unqualified object references within dynamic SQL statements within that routine. For more information, see “Dynamic SQL characteristics at run time” on page 63.

In static SQL statements, the QUALIFIER precompile/bind option implicitly specifies the qualifier for unqualified database object names. By default, this value is set to the package authorization ID.

## Naming conventions and implicit object name qualifications

The following object names, when used in the context of an SQL procedure, are permitted to use only the characters allowed in an ordinary identifier, even if the names are delimited:

- condition-name
- label
- parameter-name
- procedure-name
- SQL-variable-name
- statement-name

The syntax diagrams use different terms for different types of names. The following list defines these terms.

|                           |   |
|---------------------------|---|
| <b>alias-name</b>         | A schema-qualified name that designates an alias.   |
| <b>attribute-name</b>     | An identifier that designates an attribute of a structured data type.   |
| <b>authorization-name</b> | An identifier that designates a user or a group: <ul style="list-style-type: none"><li>• Valid characters are: 'A' through 'Z'; 'a' through 'z'; '0' through '9'; '#'; '@'; '\$'; '_'; '!'; '%'; '('; ')'; '{'; '}'; '-'; '.'; and '^'.</li><li>• The following characters must be delimited with quotation marks when entered through the command line processor: '!' ; '%' ; '(' ; ')' ; '{' ; '}' ; '-' ; '.' ; and '^'.</li><li>• The name must not begin with the characters 'SYS', 'IBM', or 'SQL'.</li><li>• The name must not be: 'ADMINS', 'GUESTS', 'LOCAL', 'PUBLIC', or 'USERS'.</li><li>• A delimited authorization ID must not contain lowercase letters.</li></ul> |
| <b>bufferpool-name</b>    | An identifier that designates a buffer pool.  |
| <b>column-name</b>        | A qualified or unqualified name that designates a column of a table or view. The qualifier is a table name, a view name, a nickname, or a correlation name.   |
| <b>component-name</b>     | An identifier that designates a security label component.   |
| <b>condition-name</b>     | An identifier that designates a condition in an SQL procedure.  |
| <b>constraint-name</b>    | An identifier that designates a referential constraint, primary key constraint, unique constraint, or a table check constraint.   |
| <b>correlation-name</b>   | An identifier that designates a result table.   |
| <b>cursor-name</b>        | An identifier that designates an SQL cursor. For host compatibility, a hyphen character may be used in the name.  |
| <b>data-source-name</b>   | An identifier that designates a data source. This identifier is the first part of a three-part remote object name.  |



## Naming conventions and implicit object name qualifications

|                                |  |
|--------------------------------|--|
| <b>db-partition-group-name</b> | An identifier that designates a database partition group.  |
| <b>descriptor-name</b>         | A colon followed by a host identifier that designates an SQL descriptor area (SQLDA). For the description of a host identifier, see “References to host variables” on page 71. Note that a descriptor name never includes an indicator variable. |
| <b>distinct-type-name</b>      | A qualified or unqualified name that designates a distinct type. An unqualified distinct type name in an SQL statement is implicitly qualified by the database manager, depending on context.  |
| <b>event-monitor-name</b>      | An identifier that designates an event monitor.  |
| <b>function-mapping-name</b>   | An identifier that designates a function mapping.  |
| <b>function-name</b>           | A qualified or unqualified name that designates a function. An unqualified function name in an SQL statement is implicitly qualified by the database manager, depending on context.  |
| <b>group-name</b>              | An unqualified identifier that designates a transform group defined for a structured type.   |
| <b>host-variable</b>           | A sequence of tokens that designates a host variable. A host variable includes at least one host identifier, explained in “References to host variables” on page 71.   |
| <b>index-name</b>              | A schema-qualified name that designates an index or an index specification.  |
| <b>label</b>                   | An identifier that designates a label in an SQL procedure.   |
| <b>method-name</b>             | An identifier that designates a method. The schema context for a method is determined by the schema of the subject type (or a supertype of the subject type) of the method.  |
| <b>nickname</b>                | A schema-qualified name that designates a federated server reference to a table or a view.   |
| <b>package-name</b>            | A schema-qualified name that designates a package. If a package has a version ID that is not the empty string, the package name also includes the version ID at the end of the name, in the form: <code>schema-id.package-id.version-id</code> . |
| <b>parameter-name</b>          | An identifier that designates a parameter that can be referenced in a procedure, user-defined function, method, or index extension.  |
| <b>partition-name</b>          | An identifier that designates a data partition in a partitioned table.   |
| <b>procedure-name</b>          | A qualified or unqualified name that designates a procedure. An unqualified procedure name in an SQL statement is implicitly qualified by the database manager, depending on context.  |

## Naming conventions and implicit object name qualifications

|                                  |   |
|----------------------------------|---|
| <b>remote-authorization-name</b> | An identifier that designates a data source user. The rules for authorization names vary from data source to data source.   |
| <b>remote-function-name</b>      | A name that designates a function registered to a data source database.   |
| <b>remote-object-name</b>        | A three-part name that designates a data source table or view, and that identifies the data source in which the table or view resides. The parts of this name are data-source-name, remote-schema-name, and remote-table-name.  |
| <b>remote-schema-name</b>        | A name that designates the schema to which a data source table or view belongs. This name is the second part of a three-part remote object name.  |
| <b>remote-table-name</b>         | A name that designates a table or view at a data source. This name is the third part of a three-part remote object name.  |
| <b>remote-type-name</b>          | A data type supported by a data source database. Do not use the long form for built-in types (use CHAR instead of CHARACTER, for example).  |
| <b>savepoint-name</b>            | An identifier that designates a savepoint.  |
| <b>schema-name</b>               | <p>An identifier that provides a logical grouping for SQL objects. A schema name used as a qualifier for the name of an object may be implicitly determined:</p> <ul style="list-style-type: none"><li>• from the value of the CURRENT SCHEMA special register</li><li>• from the value of the QUALIFIER precompile/bind option</li><li>• on the basis of a resolution algorithm that uses the CURRENT PATH special register</li><li>• on the basis of the schema name for another object in the same SQL statement.</li></ul> <p>To avoid complications, it is recommended that the name SESSION not be used as a schema, except as the schema for declared global temporary tables (which <i>must</i> use the schema name SESSION).</p> |
| <b>security-label-name</b>       | An identifier that designates a security label.   |
| <b>security-policy-name</b>      | An identifier that designates a security policy.  |
| <b>sequence-name</b>             | An identifier that designates a sequence.   |
| <b>server-name</b>               | An identifier that designates an application server. In a federated system, the server name also designates the local name of a data source.  |
| <b>specific-name</b>             | A qualified or unqualified name that designates a specific name. An unqualified specific name in an SQL statement is implicitly qualified by the database manager, depending on context.  |
| <b>SQL-variable-name</b>         | The name of a local variable in an SQL procedure statement. SQL variable names can be used in   |

## Naming conventions and implicit object name qualifications

|                          |   |
|--------------------------|---|
|                          | other SQL statements where a host variable name is allowed. The name can be qualified by the label of the compound statement that declared the SQL variable.                                      |
| <b>statement-name</b>    | An identifier that designates a prepared SQL statement.   |
| <b>supertype-name</b>    | A qualified or unqualified name that designates the supertype of a type. An unqualified supertype name in an SQL statement is implicitly qualified by the database manager, depending on context. |
| <b>table-name</b>        | A schema-qualified name that designates a table.  |
| <b>tablespace-name</b>   | An identifier that designates a table space.  |
| <b>trigger-name</b>      | A schema-qualified name that designates a trigger.  |
| <b>type-mapping-name</b> | An identifier that designates a data type mapping.  |
| <b>type-name</b>         | A qualified or unqualified name that designates a type. An unqualified type name in an SQL statement is implicitly qualified by the database manager, depending on context.                       |
| <b>typed-table-name</b>  | A schema-qualified name that designates a typed table.  |
| <b>typed-view-name</b>   | A schema-qualified name that designates a typed view.   |
| <b>view-name</b>         | A schema-qualified name that designates a view.   |
| <b>wrapper-name</b>      | An identifier that designates a wrapper.  |
| <b>xmlschema-name</b>    | A qualified or unqualified name that designates an XML schema.  |
| <b>xsobject-name</b>     | A qualified or unqualified name that designates an object in the XML schema repository.   |

## Aliases

A table alias can be thought of as an alternative name for a table or a view. A table or view, therefore, can be referred to in an SQL statement by its name or by a table alias.

An alias can be used wherever a table or a view name can be used. An alias can be created even if the object does not exist (although it must exist by the time a statement referring to it is compiled). It can refer to another alias if no circular or repetitive references are made along the chain of aliases. An alias can only refer to a table, view, or alias within the same database. An alias name cannot be used where a new table or view name is expected, such as in the CREATE TABLE or CREATE VIEW statements; for example, if the alias name PERSONNEL has been created, subsequent statements such as CREATE TABLE PERSONNEL... will return an error.

The option of referring to a table or a view by an alias is not explicitly shown in the syntax diagrams, or mentioned in the descriptions of SQL statements.

A new unqualified alias cannot have the same fully-qualified name as an existing table, view, or alias.

## Aliases

The effect of using an alias in an SQL statement is similar to that of text substitution. The alias, which must be defined by the time that the SQL statement is compiled, is replaced at statement compilation time by the qualified base table or view name. For example, if PBIIRD.SALES is an alias for DSPN014.DIST4\_SALES\_148, then at compilation time:

```
SELECT * FROM PBIIRD.SALES
```

effectively becomes

```
SELECT * FROM DSPN014.DIST4_SALES_148
```

In a federated system, the aforementioned uses and restrictions apply, not only to table aliases, but also to aliases for nicknames. Thus, a nickname's alias can be used instead of the nickname in an SQL statement; an alias can be created for a nickname that does not yet exist, provided that the nickname is created before statements that reference the alias are compiled; an alias for a nickname can refer to another alias for that nickname; and so on.

For syntax toleration of applications running under other relational database management systems, SYNONYM can be used in place of ALIAS in the CREATE ALIAS and DROP ALIAS statements.

## Authorization IDs and authorization names

An *authorization ID* is a character string that is obtained by the database manager when a connection is established between the database manager and either an application process or a program preparation process. It designates a set of privileges. It may also designate a user or a group of users, but this property is not controlled by the database manager.

Authorization IDs are used by the database manager to provide:

- Authorization checking of SQL statements
- A default value for the QUALIFIER precompile/bind option and the CURRENT SCHEMA special register. The authorization ID is also included in the default CURRENT PATH special register and the FUNCPATH precompile/bind option.

An authorization ID applies to every SQL statement. The authorization ID that applies to a static SQL statement is the authorization ID that is used during program binding. The authorization ID that applies to a dynamic SQL statement is based on the DYNAMICRULES option supplied at bind time, and on the current runtime environment for the package issuing the dynamic SQL statement:

- In a package that has bind behavior, the authorization ID used is the authorization ID of the package owner.
- In a package that has define behavior, the authorization ID used is the authorization ID of the corresponding routine's definer.
- In a package that has run behavior, the authorization ID used is the current authorization ID of the user executing the package.
- In a package that has invoke behavior, the authorization ID used is the authorization ID currently in effect when the routine is invoked. This is called the runtime authorization ID.

For more information, see "Dynamic SQL characteristics at run time" on page 63.

An *authorization name* specified in an SQL statement should not be confused with the authorization ID of the statement. An authorization name is an identifier that is used within various SQL statements. An authorization name is used in the

CREATE SCHEMA statement to designate the owner of the schema. An authorization name is used in the GRANT and REVOKE statements to designate a target of the grant or revoke operation. Granting privileges to X means that X (or a member of the group X) will subsequently be the authorization ID of statements that require those privileges.

*Examples:*

- Assume that SMITH is the user ID and the authorization ID that the database manager obtained when a connection was established with the application process. The following statement is executed interactively:

```
GRANT SELECT ON TDEPT TO KEENE
```

SMITH is the authorization ID of the statement. Therefore, in a dynamic SQL statement, the default value of the CURRENT SCHEMA special register is SMITH, and in static SQL, the default value of the QUALIFIER precompile/bind option is SMITH. The authority to execute the statement is checked against SMITH, and SMITH is the *table-name* implicit qualifier based on qualification rules described in “Naming conventions and implicit object name qualifications” on page 57.

KEENE is an authorization name specified in the statement. KEENE is given the SELECT privilege on SMITH.TDEPT.

- Assume that SMITH has administrative authority and is the authorization ID of the following dynamic SQL statements, with no SET SCHEMA statement issued during the session:

```
DROP TABLE TDEPT
```

Removes the SMITH.TDEPT table.

```
DROP TABLE SMITH.TDEPT
```

Removes the SMITH.TDEPT table.

```
DROP TABLE KEENE.TDEPT
```

Removes the KEENE.TDEPT table. Note that KEENE.TDEPT and SMITH.TDEPT are different tables.

```
CREATE SCHEMA PAYROLL AUTHORIZATION KEENE
```

KEENE is the authorization name specified in the statement that creates a schema called PAYROLL. KEENE is the owner of the schema PAYROLL and is given CREATEIN, ALTERIN, and DROPIN privileges, with the ability to grant them to others.

### Dynamic SQL characteristics at run time

The BIND option DYNAMICRULES determines the authorization ID that is used for checking authorization when dynamic SQL statements are processed. In addition, the option also controls other dynamic SQL attributes, such as the implicit qualifier that is used for unqualified object references, and whether certain SQL statements can be invoked dynamically.

The set of values for the authorization ID and other dynamic SQL attributes is called the dynamic SQL statement behavior. The four possible behaviors are run, bind, define, and invoke. As the following table shows, the combination of the value of the DYNAMICRULES BIND option and the runtime environment determines which of the behaviors is used. DYNAMICRULES RUN, which implies run behavior, is the default.

## Dynamic SQL characteristics at run time

Table 2. How DYNAMICRULES and the runtime environment determine dynamic SQL statement behavior

| DYNAMICRULES value | Behavior of dynamic SQL statements |                     |
|--------------------|------------------------------------|---------------------|
|                    | Standalone program environment     | Routine environment |
| BIND               | Bind behavior                      | Bind behavior       |
| RUN                | Run behavior                       | Run behavior        |
| DEFINEBIND         | Bind behavior                      | Define behavior     |
| DEFINERUN          | Run behavior                       | Define behavior     |
| INVOKEBIND         | Bind behavior                      | Invoke behavior     |
| INVOKERUN          | Run behavior                       | Invoke behavior     |

### Run behavior

DB2 uses the authorization ID of the user (the ID that initially connected to DB2) executing the package as the value to be used for authorization checking of dynamic SQL statements and for the initial value used for implicit qualification of unqualified object references within dynamic SQL statements.

### Bind behavior

At run time, DB2 uses all the rules that apply to static SQL for authorization and qualification. It takes the authorization ID of the package owner as the value to be used for authorization checking of dynamic SQL statements, and the package default qualifier for implicit qualification of unqualified object references within dynamic SQL statements.

### Define behavior

Define behavior applies only if the dynamic SQL statement is in a package that is run within a routine context, and the package was bound with DYNAMICRULES DEFINEBIND or DYNAMICRULES DEFINERUN. DB2 uses the authorization ID of the routine definer (not the routine's package binder) as the value to be used for authorization checking of dynamic SQL statements, and for implicit qualification of unqualified object references within dynamic SQL statements within that routine.

### Invoke behavior

Invoke behavior applies only if the dynamic SQL statement is in a package that is run within a routine context, and the package was bound with DYNAMICRULES INVOKEBIND or DYNAMICRULES INVOKERUN. DB2 uses the statement authorization ID in effect when the routine is invoked as the value to be used for authorization checking of dynamic SQL, and for implicit qualification of unqualified object references within dynamic SQL statements within that routine. This is summarized by the following table.

| Invoking Environment | ID Used   |
|----------------------|---|
| any static SQL       | implicit or explicit value of the OWNER of the package the SQL invoking the routine came from |

| Invoking Environment                        | ID Used   |
|---|---|
| used in definition of view or trigger       | definer of the view or trigger  |
| dynamic SQL from a bind behavior package    | implicit or explicit value of the OWNER of the package the SQL invoking the routine came from |
| dynamic SQL from a run behavior package     | ID used to make the initial connection to DB2   |
| dynamic SQL from a define behavior package  | definer of the routine that uses the package that the SQL invoking the routine came from      |
| dynamic SQL from an invoke behavior package | the current authorization ID invoking the routine   |

### *Restricted statements when run behavior does not apply*

When bind, define, or invoke behavior is in effect, you cannot use the following dynamic SQL statements: GRANT, REVOKE, ALTER, CREATE, DROP, COMMENT, RENAME, SET INTEGRITY, SET EVENT MONITOR STATE; or queries that reference a nickname.

### *Considerations regarding the DYNAMICRULES option*

The CURRENT SCHEMA special register cannot be used to qualify unqualified object references within dynamic SQL statements executed from bind, define or invoke behavior packages. This is true even after you issue the SET CURRENT SCHEMA statement to change the CURRENT SCHEMA special register; the register value is changed but not used.

In the event that multiple packages are referenced during a single connection, all dynamic SQL statements prepared by those packages will exhibit the behavior specified by the DYNAMICRULES option for that specific package and the environment in which they are used.

It is important to keep in mind that when a package exhibits bind behavior, the binder of the package should not have any authorities granted that the user of the package should not receive, because a dynamic statement will be using the authorization ID of the package owner. Similarly, when a package exhibits define behavior, the definer of the routine should not have any authorities granted that the user of the package should not receive.

### **Authorization IDs and statement preparation**

If the VALIDATE BIND option is specified at bind time, the privileges required to manipulate tables and views must also exist at bind time. If these privileges or the referenced objects do not exist, and the SQLERROR NOPACKAGE option is in effect, the bind operation will be unsuccessful. If the SQLERROR CONTINUE option is specified, the bind operation will be successful, and any statements in error will be flagged. Any attempt to execute such a statement will result in an error.

If a package is bound with the VALIDATE RUN option, all normal bind processing is completed, but the privileges required to use the tables and views that are referenced in the application need not exist yet. If a required privilege does not exist at bind time, an incremental bind operation is performed whenever the statement is first executed in an application, and all privileges required for the statement must exist. If a required privilege does not exist, execution of the statement is unsuccessful.

## Authorization IDs and statement preparation

Authorization checking at run time is performed using the authorization ID of the package owner.

### Column names

The meaning of a *column name* depends on its context. A column name can be used to:

- Declare the name of a column, as in a CREATE TABLE statement.
- Identify a column, as in a CREATE INDEX statement.
- Specify values of the column, as in the following contexts:
  - In a column function, a column name specifies all values of the column in the group or intermediate result table to which the function is applied. For example, MAX(SALARY) applies the function MAX to all values of the column SALARY in a group.
  - In a GROUP BY or ORDER BY clause, a column name specifies all values in the intermediate result table to which the clause is applied. For example, ORDER BY DEPT orders an intermediate result table by the values of the column DEPT.
  - In an expression, a search condition, or a scalar function, a column name specifies a value for each row or group to which the construct is applied. For example, when the search condition CODE = 20 is applied to some row, the value specified by the column name CODE is the value of the column CODE in that row.
- Temporarily rename a column, as in the *correlation-clause* of a *table-reference* in a FROM clause.

### Qualified column names

A qualifier for a column name may be a table, view, nickname, alias, or correlation name.

Whether a column name may be qualified depends on its context:

- Depending on the form of the COMMENT ON statement, a single column name may need to be qualified. Multiple column names must be unqualified.
- Where the column name specifies values of the column, it may be qualified at the user's option.
- In the assignment-clause of an UPDATE statement, it may be qualified at the user's option.
- In all other contexts, a column name must not be qualified.

Where a qualifier is optional, it can serve two purposes. They are described under "Column name qualifiers to avoid ambiguity" on page 68 and "Column name qualifiers in correlated references" on page 70.

### Correlation names

A *correlation name* can be defined in the FROM clause of a query and in the first clause of an UPDATE or DELETE statement. For example, the clause FROM X.MYTABLE Z establishes Z as a correlation name for X.MYTABLE.

```
FROM X.MYTABLE Z
```

With Z defined as a correlation name for X.MYTABLE, only Z can be used to qualify a reference to a column of that instance of X.MYTABLE in that SELECT statement.



A correlation name is associated with a table, view, nickname, alias, nested table expression or table function only within the context in which it is defined. Hence, the same correlation name can be defined for different purposes in different statements, or in different clauses of the same statement.

As a qualifier, a correlation name can be used to avoid ambiguity or to establish a correlated reference. It can also be used merely as a shorter name for a table, view, nickname, or alias. In the case of a nested table expression or table function, a correlation name is required to identify the result table. In the example, Z might have been used merely to avoid having to enter X.MYTABLE more than once.

If a correlation name is specified for a table, view, nickname, or alias name, any qualified reference to a column of that instance of the table, view, nickname, or alias must use the correlation name, rather than the table, view, nickname, or alias name. For example, the reference to EMPLOYEE.PROJECT in the following example is incorrect, because a correlation name has been specified for EMPLOYEE:

Example

```
FROM EMPLOYEE E
WHERE EMPLOYEE.PROJECT='ABC'      * incorrect*
```

The qualified reference to PROJECT should instead use the correlation name, "E", as shown below:

```
FROM EMPLOYEE E
WHERE E.PROJECT='ABC'
```

Names specified in a FROM clause are either *exposed* or *non-exposed*. A table, view, nickname, or alias name is said to be exposed in the FROM clause if a correlation name is not specified. A correlation name is always an exposed name. For example, in the following FROM clause, a correlation name is specified for EMPLOYEE but not for DEPARTMENT, so DEPARTMENT is an exposed name, and EMPLOYEE is not:

```
FROM EMPLOYEE E, DEPARTMENT
```

A table, view, nickname, or alias name that is exposed in a FROM clause may be the same as any other table name, view name or nickname exposed in that FROM clause or any correlation name in the FROM clause. This may result in ambiguous column name references which returns an error (SQLSTATE 42702).

The first two FROM clauses shown below are correct, because each one contains no more than one reference to EMPLOYEE that is exposed:

1. Given the FROM clause:

```
FROM EMPLOYEE E1, EMPLOYEE
```

a qualified reference such as EMPLOYEE.PROJECT denotes a column of the second instance of EMPLOYEE in the FROM clause. A qualified reference to the first instance of EMPLOYEE must use the correlation name "E1" (E1.PROJECT).

2. Given the FROM clause:

```
FROM EMPLOYEE, EMPLOYEE E2
```

a qualified reference such as EMPLOYEE.PROJECT denotes a column of the first instance of EMPLOYEE in the FROM clause. A qualified reference to the second instance of EMPLOYEE must use the correlation name "E2" (E2.PROJECT).

## Correlation names

3. Given the FROM clause:

```
FROM EMPLOYEE, EMPLOYEE
```

the two exposed table names included in this clause (EMPLOYEE and EMPLOYEE) are the same. This is allowed, but references to specific column names would be ambiguous (SQLSTATE 42702).

4. Given the following statement:

```
SELECT *
FROM EMPLOYEE E1, EMPLOYEE E2          * incorrect *
WHERE EMPLOYEE.PROJECT = 'ABC'
```

the qualified reference EMPLOYEE.PROJECT is incorrect, because both instances of EMPLOYEE in the FROM clause have correlation names. Instead, references to PROJECT must be qualified with either correlation name (E1.PROJECT or E2.PROJECT).

5. Given the FROM clause:

```
FROM EMPLOYEE, X.EMPLOYEE
```

a reference to a column in the second instance of EMPLOYEE must use X.EMPLOYEE (X.EMPLOYEE.PROJECT). If X is the CURRENT SCHEMA special register value in dynamic SQL or the QUALIFIER precompile/bind option in static SQL, then the columns cannot be referenced since any such reference would be ambiguous.

The use of a correlation name in the FROM clause also allows the option of specifying a list of column names to be associated with the columns of the result table. As with a correlation name, these listed column names become the *exposed* names of the columns that must be used for references to the columns throughout the query. If a column name list is specified, then the column names of the underlying table become *non-exposed*.

Given the FROM clause:

```
FROM DEPARTMENT D (NUM,NAME,MGR,ANUM,LOC)
```

a qualified reference such as D.NUM denotes the first column of the DEPARTMENT table that is defined in the table as DEPTNO. A reference to D.DEPTNO using this FROM clause is incorrect since the column name DEPTNO is a non-exposed column name.

### Column name qualifiers to avoid ambiguity

In the context of a function, a GROUP BY clause, ORDER BY clause, an expression, or a search condition, a column name refers to values of a column in some table, view, nickname, nested table expression or table function. The tables, views, nicknames, nested table expressions and table functions that might contain the column are called the *object tables* of the context. Two or more object tables might contain columns with the same name; one reason for qualifying a column name is to designate the table from which the column comes. Qualifiers for column names are also useful in SQL procedures to distinguish column names from SQL variable names used in SQL statements.

A nested table expression or table function will consider *table-references* that precede it in the FROM clause as object tables. The *table-references* that follow are not considered as object tables.

**Table designators:** A qualifier that designates a specific object table is called a *table designator*. The clause that identifies the object tables also establishes the table designators for them. For example, the object tables of an expression in a SELECT clause are named in the FROM clause that follows it:

```
SELECT CORZ.COLA, OWNY.MYTABLE.COLA
FROM OWNX.MYTABLE CORZ, OWNY.MYTABLE
```

Table designators in the FROM clause are established as follows:

- A name that follows a table, view, nickname, alias, nested table expression or table function is both a correlation name and a table designator. Thus, CORZ is a table designator. CORZ is used to qualify the first column name in the select list.
- An exposed table, view name, nickname or alias is a table designator. Thus, OWNY.MYTABLE is a table designator. OWNY.MYTABLE is used to qualify the second column name in the select list.

Each table designator should be unique within a particular FROM clause to avoid the possibility of ambiguous references to columns.

**Avoiding undefined or ambiguous references:** When a column name refers to values of a column, exactly one object table must include a column with that name. The following situations are considered errors:

- No object table contains a column with the specified name. The reference is undefined.
- The column name is qualified by a table designator, but the table designated does not include a column with the specified name. Again the reference is undefined.
- The name is unqualified, and more than one object table includes a column with that name. The reference is ambiguous.
- The column name is qualified by a table designator, but the table designated is not unique in the FROM clause and both occurrences of the designated table include the column. The reference is ambiguous.
- The column name is in a nested table expression which is not preceded by the TABLE keyword or in a table function or nested table expression that is the right operand of a right outer join or a full outer join and the column name does not refer to a column of a *table-reference* within the nested table expression's fullselect. The reference is undefined.

Avoid ambiguous references by qualifying a column name with a uniquely defined table designator. If the column is contained in several object tables with different names, the table names can be used as designators. Ambiguous references can also be avoided without the use of the table designator by giving unique names to the columns of one of the object tables using the column name list following the correlation name.

When qualifying a column with the exposed table name form of a table designator, either the qualified or unqualified form of the exposed table name may be used. However, the qualifier used and the table used must be the same after fully qualifying the table name, view name or nickname and the table designator.

1. If the authorization ID of the statement is CORPDATA:

```
SELECT CORPDATA.EMPLOYEE.WORKDEPT
FROM EMPLOYEE
```

is a valid statement.

2. If the authorization ID of the statement is REGION:

```
SELECT CORPDATA.EMPLOYEE.WORKDEPT
FROM EMPLOYEE * incorrect *
```

is invalid, because EMPLOYEE represents the table REGION.EMPLOYEE, but the qualifier for WORKDEPT represents a different table, CORPDATA.EMPLOYEE.

### Column name qualifiers in correlated references

A *fullselect* is a form of a query that may be used as a component of various SQL statements. A fullselect used within a search condition of any statement is called a *subquery*. A fullselect used to retrieve a single value as an expression within a statement is called a *scalar fullselect* or *scalar subquery*. A fullselect used in the FROM clause of a query is called a *nested table expression*. Subqueries in search conditions, scalar subqueries and nested table expressions are referred to as subqueries through the remainder of this topic.

A subquery may include subqueries of its own, and these may, in turn, include subqueries. Thus an SQL statement may contain a hierarchy of subqueries. Those elements of the hierarchy that contain subqueries are said to be at a higher level than the subqueries they contain.

Every element of the hierarchy contains one or more table designators. A subquery can reference not only the columns of the tables identified at its own level in the hierarchy, but also the columns of the tables identified previously in the hierarchy, back to the highest level of the hierarchy. A reference to a column of a table identified at a higher level is called a *correlated reference*.

For compatibility with existing standards for SQL, both qualified and unqualified column names are allowed as correlated references. However, it is good practice to qualify all column references used in subqueries; otherwise, identical column names may lead to unintended results. For example, if a table in a hierarchy is altered to contain the same column name as the correlated reference and the statement is prepared again, the reference will apply to the altered table.

When a column name in a subquery is qualified, each level of the hierarchy is searched, starting at the same subquery as the qualified column name appears and continuing to the higher levels of the hierarchy until a table designator that matches the qualifier is found. Once found, it is verified that the table contains the given column. If the table is found at a higher level than the level containing column name, then it is a correlated reference to the level where the table designator was found. A nested table expression must be preceded with the optional TABLE keyword in order to search the hierarchy above the fullselect of the nested table expression.

When the column name in a subquery is not qualified, the tables referenced at each level of the hierarchy are searched, starting at the same subquery where the column name appears and continuing to higher levels of the hierarchy, until a match for the column name is found. If the column is found in a table at a higher level than the level containing column name, then it is a correlated reference to the level where the table containing the column was found. If the column name is found in more than one table at a particular level, the reference is ambiguous and considered an error.

In either case, T, used in the following example, refers to the table designator that contains column C. A column name, T.C (where T represents either an implicit or an explicit qualifier), is a correlated reference if, and only if, these conditions are met:

- T.C is used in an expression of a subquery.
- T does not designate a table used in the from clause of the subquery.
- T designates a table used at a higher level of the hierarchy that contains the subquery.

## Column name qualifiers in correlated references

Since the same table, view or nickname can be identified at many levels, unique correlation names are recommended as table designators. If T is used to designate a table at more than one level (T is the table name itself or is a duplicate correlation name), T.C refers to the level where T is used that most directly contains the subquery that includes T.C. If a correlation to a higher level is needed, a unique correlation name must be used.

The correlated reference T.C identifies a value of C in a row or group of T to which two search conditions are being applied: condition 1 in the subquery, and condition 2 at some higher level. If condition 2 is used in a WHERE clause, the subquery is evaluated for each row to which condition 2 is applied. If condition 2 is used in a HAVING clause, the subquery is evaluated for each group to which condition 2 is applied.

For example, in the following statement, the correlated reference X.WORKDEPT (in the last line) refers to the value of WORKDEPT in table EMPLOYEE at the level of the first FROM clause. (That clause establishes X as a correlation name for EMPLOYEE.) The statement lists employees who make less than the average salary for their department.

```
SELECT EMPNO, LASTNAME, WORKDEPT
FROM EMPLOYEE X
WHERE SALARY < (SELECT AVG(SALARY)
                FROM EMPLOYEE
                WHERE WORKDEPT = X.WORKDEPT)
```

The next example uses THIS as a correlation name. The statement deletes rows for departments that have no employees.

```
DELETE FROM DEPARTMENT THIS
WHERE NOT EXISTS(SELECT *
                 FROM EMPLOYEE
                 WHERE WORKDEPT = THIS.DEPTNO)
```

## References to host variables

A *host variable* is either:

- A variable in a host language such as a C variable, a C++ variable, a COBOL data item, a FORTRAN variable, or a Java variable

or:

- A host language construct that was generated by an SQL precompiler from a variable declared using SQL extensions

that is referenced in an SQL statement. Host variables are either directly defined by statements in the host language or are indirectly defined using SQL extensions.

A host variable in an SQL statement must identify a host variable described in the program according to the rules for declaring host variables.

All host variables used in an SQL statement must be declared in an SQL DECLARE section in all host languages except REXX. No variables may be declared outside an SQL DECLARE section with names identical to variables declared inside an SQL DECLARE section. An SQL DECLARE section begins with BEGIN DECLARE SECTION and ends with END DECLARE SECTION.

The meta-variable *host-variable*, as used in the syntax diagrams, shows a reference to a host variable. A host-variable in the VALUES INTO clause or the INTO clause of a FETCH or a SELECT INTO statement, identifies a host variable to which a

## References to host variables

value from a column of a row or an expression is assigned. In all other contexts a host-variable specifies a value to be passed to the database manager from the application program.

### Host variables in dynamic SQL

In dynamic SQL statements, parameter markers are used instead of host variables. A parameter marker is a question mark (?) representing a position in a dynamic SQL statement where the application will provide a value; that is, where a host variable would be found if the statement string were a static SQL statement. The following example shows a static SQL statement using host variables:

```
INSERT INTO DEPARTMENT
VALUES (:hv_deptno, :hv_deptname, :hv_mgrno, :hv_admrdept)
```

This example shows a dynamic SQL statement using parameter markers:

```
INSERT INTO DEPARTMENT VALUES (?, ?, ?, ?)
```

The meta-variable *host-variable* in syntax diagrams can generally be expanded to:

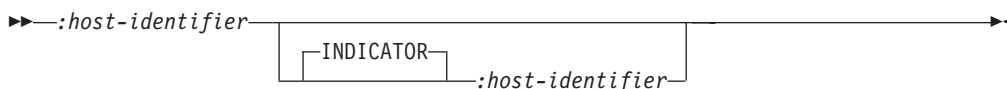

Each *host-identifier* must be declared in the source program. The variable designated by the second host-identifier must have a data type of small integer.

The first host-identifier designates the *main variable*. Depending on the operation, it either provides a value to the database manager or is provided a value from the database manager. An input host variable provides a value in the runtime application code page. An output host variable is provided a value that, if necessary, is converted to the runtime application code page when the data is copied to the output application variable. A given host variable can serve as both an input and an output variable in the same program.

The second host-identifier designates its *indicator variable*. The purposes of the indicator variable are to:

- Specify the null value. A negative value of the indicator variable specifies the null value. A value of -2 indicates a numeric conversion or arithmetic expression error occurred in deriving the result
- Record the original length of a truncated string (if the source of the value is not a large object type)
- Record the seconds portion of a time if the time is truncated on assignment to a host variable.

For example, if `:HV1:HV2` is used to specify an insert or update value, and if HV2 is negative, the value specified is the null value. If HV2 is not negative the value specified is the value of HV1.

Similarly, if `:HV1:HV2` is specified in a VALUES INTO clause or in a FETCH or SELECT INTO statement, and if the value returned is null, HV1 is not changed, and HV2 is set to a negative value. If the database is configured with DFT\_SQLMATHWARN yes (or was during binding of a static SQL statement), HV2 could be -2. If HV2 is -2, a value for HV1 could not be returned because of an error converting to the numeric type of HV1, or an error evaluating an arithmetic expression that is used to determine the value for HV1. When accessing a database

with a client version earlier than DB2 Universal Database Version 5, HV2 will be -1 for arithmetic exceptions. If the value returned is not null, that value is assigned to HV1 and HV2 is set to zero (unless the assignment to HV1 requires string truncation of a non-LOB string; in which case HV2 is set to the original length of the string). If an assignment requires truncation of the seconds part of a time, HV2 is set to the number of seconds.

If the second host identifier is omitted, the host-variable does not have an indicator variable. The value specified by the host-variable reference :HV1 is always the value of HV1, and null values cannot be assigned to the variable. Thus, this form should not be used in an INTO clause unless the corresponding column cannot contain null values. If this form is used and the column contains nulls, the database manager will generate an error at run time.

An SQL statement that references host variables must be within the scope of the declaration of those host variables. For host variables referenced in the SELECT statement of a cursor, that rule applies to the OPEN statement rather than to the DECLARE CURSOR statement.

**Example:** Using the PROJECT table, set the host variable PNAME (VARCHAR(26)) to the project name (PROJNAME), the host variable STAFF (dec(5,2)) to the mean staffing level (PRSTAFF), and the host variable MAJPROJ (char(6)) to the major project (MAJPROJ) for project (PROJNO) 'IF1000'. Columns PRSTAFF and MAJPROJ may contain null values, so provide indicator variables STAFF\_IND (smallint) and MAJPROJ\_IND (smallint).

```
SELECT PROJNAME, PRSTAFF, MAJPROJ
  INTO :PNAME, :STAFF :STAFF_IND, :MAJPROJ :MAJPROJ_IND
  FROM PROJECT
 WHERE PROJNO = 'IF1000'
```

**MBCS Considerations:** Whether multi-byte characters can be used in a host variable name depends on the host language.

### References to BLOB, CLOB, and DBCLOB host variables

Regular BLOB, CLOB, and DBCLOB variables, LOB locator variables (see “References to locator variables”), and LOB file reference variables (see “References to BLOB, CLOB, and DBCLOB file reference variables” on page 74) can be defined in all host languages. Where LOBs are allowed, the term *host-variable* in a syntax diagram can refer to a regular host variable, a locator variable, or a file reference variable. Since these are not native data types, SQL extensions are used and the precompilers generate the host language constructs necessary to represent each variable. In the case of REXX, LOBs are mapped to strings.

It is sometimes possible to define a large enough variable to hold an entire large object value. If this is true and if there is no performance benefit to be gained by deferred transfer of data from the server, a locator is not needed. However, since host language or space restrictions will often dictate against storing an entire large object in temporary storage at one time and/or because of performance benefit, a large object may be referenced via a locator and portions of that object may be selected into or updated from host variables that contain only a portion of the large object at one time.

### References to locator variables

A *locator variable* is a host variable that contains the locator representing a LOB value on the application server.

## References to locator variables

A locator variable in an SQL statement must identify a locator variable described in the program according to the rules for declaring locator variables. This is always indirectly through an SQL statement.

The term locator variable, as used in the syntax diagrams, shows a reference to a locator variable. The meta-variable *locator-variable* can be expanded to include a *host-identifier* the same as that for *host-variable*.

As with all other host variables, a large object locator variable may have an associated indicator variable. Indicator variables for large object locator host variables behave in the same way as indicator variables for other data types. When a null value is returned from the database, the indicator variable is set and the locator host variable is unchanged. This means a locator can never point to a null value.

If a locator-variable that does not currently represent any value is referenced, an error is raised (SQLSTATE 0F001).

At transaction commit, or any transaction termination, all locators acquired by that transaction are released.

## References to BLOB, CLOB, and DBCLOB file reference variables

BLOB, CLOB, and DBCLOB file reference variables are used for direct file input and output for LOBs, and can be defined in all host languages. Since these are not native data types, SQL extensions are used and the precompilers generate the host language constructs necessary to represent each variable. In the case of REXX, LOBs are mapped to strings.

A file reference variable represents (rather than contains) the file, just as a LOB locator represents, rather than contains, the LOB bytes. Database queries, updates and inserts may use file reference variables to store or to retrieve single column values.

A file reference variable has the following properties:

|                  |  |
|------------------|--|
| <b>Data Type</b> | BLOB, CLOB, or DBCLOB. This property is specified when the variable is declared.   |
| <b>Direction</b> | This must be specified by the application program at run time (as part of the File Options value). The direction is one of: <ul style="list-style-type: none"><li>• Input (used as a source of data on an EXECUTE statement, an OPEN statement, an UPDATE statement, an INSERT statement, or a DELETE statement).</li><li>• Output (used as the target of data on a FETCH statement or a SELECT INTO statement).</li></ul> |
| <b>File name</b> | This must be specified by the application program at run time. It is one of: <ul style="list-style-type: none"><li>• The complete path name of the file (which is advised).</li><li>• A relative file name. If a relative file name is provided, it is appended to the current path of the client process.</li></ul>   |



## References to BLOB, CLOB, and DBCLOB file reference variables

Within an application, a file should only be referenced in one file reference variable.

### File Name Length

This must be specified by the application program at run time. It is the length of the file name (in bytes).

### File Options

An application must assign one of a number of options to a file reference variable before it makes use of that variable. Options are set by an INTEGER value in a field in the file reference variable structure. One of the following values must be specified for each file reference variable:

- Input (from client to server)

#### SQL\_FILE\_READ

This is a regular file that can be opened, read and closed. (The option is SQL-FILE-READ in COBOL, `sql_file_read` in FORTRAN, and READ in REXX.)

- Output (from server to client)

#### SQL\_FILE\_CREATE

Create a new file. If the file already exists, an error is returned. (The option is SQL-FILE-CREATE in COBOL, `sql_file_create` in FORTRAN, and CREATE in REXX.)

#### SQL\_FILE\_OVERWRITE (Overwrite)

If an existing file with the specified name exists, it is overwritten; otherwise a new file is created. (The option is SQL-FILE-OVERWRITE in COBOL, `sql_file_overwrite` in FORTRAN, and OVERWRITE in REXX.)

#### SQL\_FILE\_APPEND

If an existing file with the specified name exists, the output is appended to it; otherwise a new file is created. (The option is SQL-FILE-APPEND in COBOL, `sql_file_append` in FORTRAN, and APPEND in REXX.)

### Data Length

This is unused on input. On output, the implementation sets the data length to the length of the new data written to the file. The length is in bytes.

As with all other host variables, a file reference variable may have an associated indicator variable.

## Example of an output file reference variable (in C)

**Example of an output file reference variable (in C):** Given a declare section coded as:

```
EXEC SQL BEGIN DECLARE SECTION
      SQL TYPE IS CLOB_FILE hv_text_file;
      char hv_patent_title[64];
EXEC SQL END DECLARE SECTION
```

Following preprocessing this would be:

```
EXEC SQL BEGIN DECLARE SECTION
/* SQL TYPE IS CLOB_FILE hv_text_file; */
struct {
    unsigned long name_length; // File Name Length
    unsigned long data_length; // Data Length
    unsigned long file_options; // File Options
    char name[255]; // File Name
} hv_text_file;
char hv_patent_title[64];
EXEC SQL END DECLARE SECTION
```

Then, the following code can be used to select from a CLOB column in the database into a new file referenced by :hv\_text\_file.

```
strcpy(hv_text_file.name, "/u/gainer/papers/sigmod.94");
hv_text_file.name_length = strlen("/u/gainer/papers/sigmod.94");
hv_text_file.file_options = SQL_FILE_CREATE;
```

```
EXEC SQL SELECT content INTO :hv_text_file from papers
      WHERE TITLE = 'The Relational Theory behind Juggling';
```

**Example of an input file reference variable (in C):** Given the same declare section as above, the following code can be used to insert the data from a regular file referenced by :hv\_text\_file into a CLOB column.

```
strcpy(hv_text_file.name, "/u/gainer/patents/chips.13");
hv_text_file.name_length = strlen("/u/gainer/patents/chips.13");
hv_text_file.file_options = SQL_FILE_READ;
strcpy(:hv_patent_title, "A Method for Pipelining Chip Consumption");
```

```
EXEC SQL INSERT INTO patents( title, text )
      VALUES(:hv_patent_title, :hv_text_file);
```

## References to structured type host variables

Structured type variables can be defined in all host languages except FORTRAN, REXX, and Java. Since these are not native data types, SQL extensions are used and the precompilers generate the host language constructs necessary to represent each variable.

As with all other host variables, a structured type variable may have an associated indicator variable. Indicator variables for structured type host variables behave in the same way as indicator variables for other data types. When a null value is returned from the database, the indicator variable is set and the structured type host variable is unchanged.

The actual host variable for a structured type is defined as a built-in data type. The built-in data type associated with the structured type must be assignable:

- from the result of the FROM SQL transform function for the structured type as defined by the specified TRANSFORM GROUP option of the precompile command; and
- to the parameter of the TO SQL transform function for the structured type as defined by the specified TRANSFORM GROUP option of the precompile command.

If using a parameter marker instead of a host variable, the appropriate parameter type characteristics must be specified in the SQLDA. This requires a "doubled" set of SQLVAR structures in the SQLDA, and the SQLDATATYPE\_NAME field of the secondary SQLVAR must be filled with the schema and type name of the structured type. If the schema is omitted in the SQLDA structure, an error results (SQLSTATE 07002).

**Example:** Define the host variables *hv\_poly* and *hv\_point* (of type POLYGON, using built-in type BLOB(1048576)) in a C program.

```
EXEC SQL BEGIN DECLARE SECTION;
      static SQL
          TYPE IS POLYGON AS BLOB(1M)
          hv_poly, hv_point;
EXEC SQL END DECLARE SECTION;
```

### Related reference:

- Appendix N, "Japanese and traditional-Chinese extended UNIX code (EUC) considerations," on page 841
- "Large objects (LOBs)" on page 87
- Appendix G, "Reserved schema names and reserved words," on page 783
- Appendix A, "SQL and XQuery limits," on page 559
- "CREATE ALIAS statement" in *SQL Reference, Volume 2*
- "PREPARE statement" in *SQL Reference, Volume 2*
- "SET SCHEMA statement" in *SQL Reference, Volume 2*
- "SQL queries" on page 505
- Appendix C, "SQLDA (SQL descriptor area)," on page 573

## Data types

### Data types

The smallest unit of data that can be manipulated in SQL is called a *value*. Values are interpreted according to the data type of their source. Sources include:

- Constants
- Columns
- Host variables
- Functions
- Expressions
- Special registers.

DB2 supports a number of built-in data types. It also provides support for user-defined data types. Figure 10 on page 79 shows the supported built-in data types.

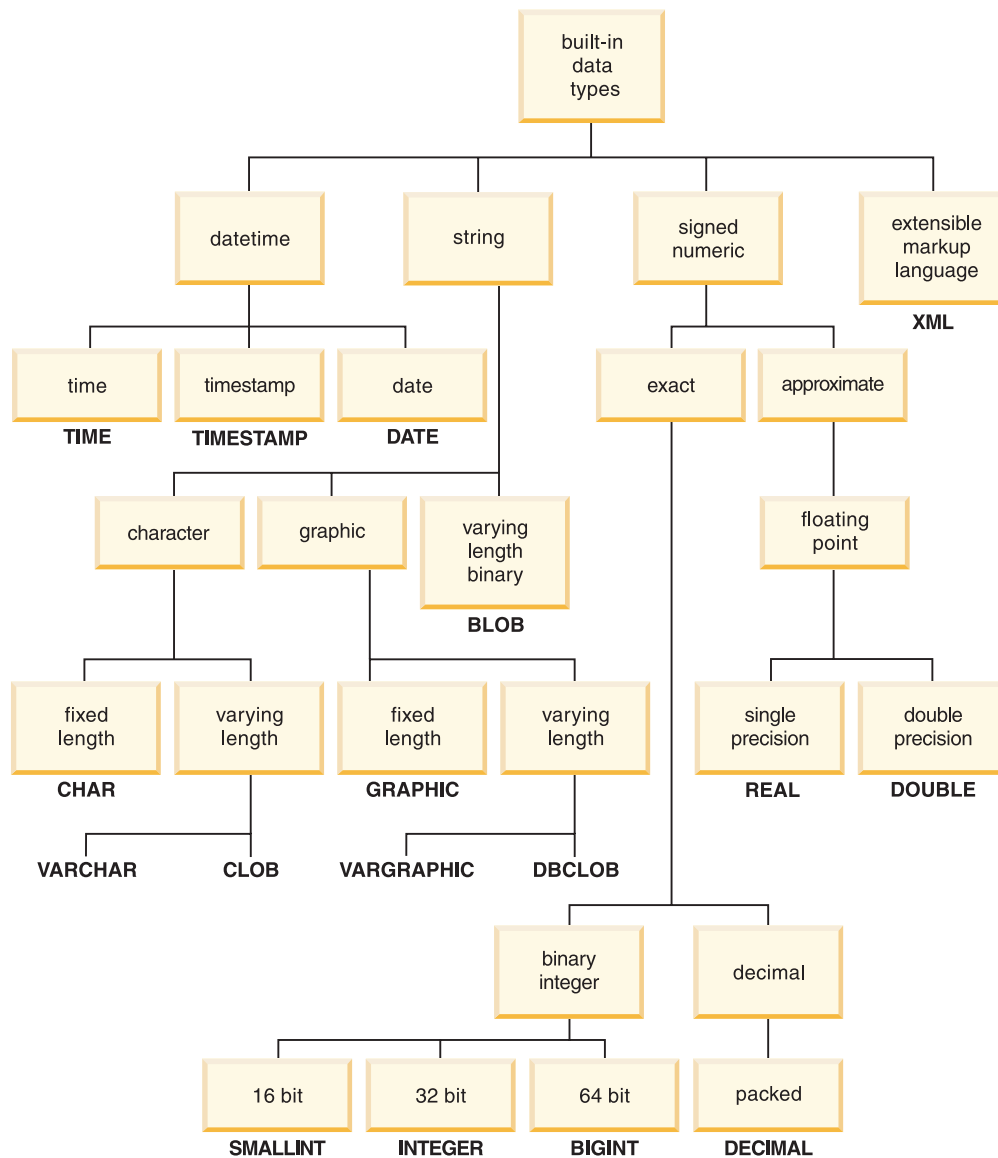

Figure 10. The DB2 Built-in Data Types

All data types include the null value. The null value is a special value that is distinct from all non-null values and thereby denotes the absence of a (non-null) value. Although all data types include the null value, columns defined as NOT NULL cannot contain null values.

**Related reference:**

- “User-defined types” on page 94

### Numbers

All numbers have a sign and a precision. The *sign* is considered positive if the value of a number is zero. The *precision* is the number of bits or digits excluding the sign.

See the data type section in the description of the CREATE TABLE statement.

#### **Small integer (SMALLINT)**

A *small integer* is a two-byte integer with a precision of 5 digits. The range of small integers is -32 768 to 32 767.

#### **Large integer (INTEGER)**

A *large integer* is a four-byte integer with a precision of 10 digits. The range of large integers is -2 147 483 648 to +2 147 483 647.

#### **Big integer (BIGINT)**

A *big integer* is an eight-byte integer with a precision of 19 digits. The range of big integers is -9 223 372 036 854 775 808 to +9 223 372 036 854 775 807.

#### **Single-precision floating-point (REAL)**

A *single-precision floating-point* number is a 32-bit approximation of a real number. The number can be zero or can range from -3.4028234663852886e+38 to -1.1754943508222875e-38, or from 1.1754943508222875e-38 to 3.4028234663852886e+38.

#### **Double-precision floating-point (DOUBLE or FLOAT)**

A *double-precision floating-point* number is a 64-bit approximation of a real number. The number can be zero or can range from -1.7976931348623158e+308 to -2.2250738585072014e-308, or from 2.2250738585072014e-308 to 1.7976931348623158e+308.

#### **Decimal (DECIMAL or NUMERIC)**

A *decimal* value is a packed decimal number with an implicit decimal point. The position of the decimal point is determined by the precision and the scale of the number. The scale, which is the number of digits in the fractional part of the number, cannot be negative or greater than the precision. The maximum precision is 31 digits.

All values in a decimal column have the same precision and scale. The range of a decimal variable or the numbers in a decimal column is  $-n$  to  $+n$ , where the absolute value of  $n$  is the largest number that can be represented with the applicable precision and scale. The maximum range is  $-10^{31}+1$  to  $10^{31}-1$ .

#### **Related reference:**

- "CREATE TABLE statement" in *SQL Reference, Volume 2*
- Appendix C, "SQLDA (SQL descriptor area)," on page 573

## Character strings

A *character string* is a sequence of bytes. The length of the string is the number of bytes in the sequence. If the length is zero, the value is called the *empty string*. This value should not be confused with the null value.

### Fixed-length character string (CHAR)

All values in a fixed-length string column have the same length, which is determined by the length attribute of the column. The length attribute must be between 1 and 254, inclusive.

### Varying-length character strings

There are three types of varying-length character string:

- A VARCHAR value can be up to 32 672 bytes long.
- A LONG VARCHAR value can be up to 32 700 bytes long.
- A CLOB (character large object) value can be up to 2 gigabytes (2 147 483 647 bytes) long. A CLOB is used to store large SBCS or mixed (SBCS and MBCS) character-based data (such as documents written with a single character set) and, therefore, has an SBCS or mixed code page associated with it.

Special restrictions apply to expressions resulting in a LONG VARCHAR or CLOB data type, and to structured type columns; such expressions and columns are not permitted in:

- A SELECT list preceded by the DISTINCT clause
- A GROUP BY clause
- An ORDER BY clause
- A subselect of a set operator other than UNION ALL
- A basic, quantified, BETWEEN, or IN predicate
- A column function
- VARGRAPHIC, TRANSLATE, and datetime scalar functions
- The pattern operand in a LIKE predicate, or the search string operand in a POSSTR function
- The string representation of a datetime value.

The functions in the SYSFUN schema taking a VARCHAR as an argument will not accept VARCHARs greater than 4 000 bytes long as an argument. However, many of these functions also have an alternative signature accepting a CLOB(1M). For these functions, the user may explicitly cast the greater than 4 000 VARCHAR strings into CLOBs and then recast the result back into VARCHARs of desired length.

NUL-terminated character strings found in C are handled differently, depending on the standards level of the precompile option.

Each character string is further defined as one of:

**Bit data**            Data that is not associated with a code page.

#### Single-byte character set (SBCS) data

Data in which every character is represented by a single byte.

**Mixed data**        Data that may contain a mixture of characters from a single-byte character set and a multi-byte character set (MBCS).

### String units in built-in functions

The ability to specify string units for certain built-in functions allows you to process string data in a more "character-based manner" than a "byte-based manner". The *string unit* determines the length in which an operation is to occur. You can specify CODEUNITS16, CODEUNITS32, or OCTETS as the string unit for an operation.

#### CODEUNITS16

Specifies that Unicode UTF-16 is the unit for the operation. CODEUNITS16 is useful when an application is processing data in code units that are two bytes in width. Note that some characters, known as *supplementary characters*, require two UTF-16 code units to be encoded. For example, the musical symbol G clef requires two UTF-16 code units (X'D834' and X'DD1E' in UTF-16BE).

#### CODEUNITS32

Specifies that Unicode UTF-32 is the unit for the operation. CODEUNITS32 is useful for applications that process data in a simple, fixed-length format, and that must return the same answer regardless of the storage format of the data (ASCII, UTF-8, or UTF-16).

#### OCTETS

Specifies that bytes are the units for the operation. OCTETS is often used when an application is interested in allocating buffer space or when operations need to use simple byte processing.

The calculated length of a string computed using OCTETS (bytes) might differ from that computed using CODEUNITS16 or CODEUNITS32. When using OCTETS, the length of the string is determined by simply counting the number of bytes in the string. When using CODEUNITS16 or CODEUNITS32, the length of the string is determined by counting the number of 16-bit or 32-bit code units necessary to represent the string in UTF-16 or UTF-32, respectively. The length determined using CODEUNITS16 and CODEUNITS32 will be identical unless the data contains supplementary characters (see "Difference between CODEUNITS16 and CODEUNITS32" on page 83).

For example, assume that NAME, a VARCHAR(128) column encoded in Unicode UTF-8, contains the value 'Jürgen'. The following two queries, which count the length of the string in CODEUNITS16 and CODEUNITS32, respectively, return the same value (6).

```
SELECT CHARACTER_LENGTH(NAME, CODEUNITS16) FROM T1
WHERE NAME = 'Jürgen'
```

```
SELECT CHARACTER_LENGTH(NAME, CODEUNITS32) FROM T1
WHERE NAME = 'Jürgen'
```

The next query, which counts the length of the string in OCTETS, returns the value 7.

```
SELECT CHARACTER_LENGTH(NAME, OCTETS) FROM T1
WHERE NAME = 'Jürgen'
```

These values represent the length of the string expressed in the specified string unit.

The following table shows the UTF-8, UTF-16BE (big-endian), and UTF-32BE (big-endian) representations of the name 'Jürgen':



```

Format      Representation of the name 'Jürgen'
-----
UTF-8      X'4AC3BC7267656E'
UTF-16BE   X'004A00FC007200670065006E'
UTF-32BE   X'0000004A000000FC0000007200000067000000650000006E'

```

The representation of the character 'ü' differs among the three string units:

- The UTF-8 representation of the character 'ü' is X'C3BC'.
- The UTF-16BE representation of the character 'ü' is X'00FC'.
- The UTF-32BE representation of the character 'ü' is X'000000FC'.

Specifying string units for a built-in function does not affect the data type or the code page of the result of the function. If necessary, DB2 converts the data to Unicode for evaluation when CODEUNITS16 or CODEUNITS32 is specified.

When OCTETS is specified for the LOCATE or POSITION function, and the code pages of the string arguments differ, DB2 converts the data to the code page of the *source-string* argument. In this case, the result of the function is in the code page of the *source-string* argument. When OCTETS is specified for functions that take a single string argument, the data is evaluated in the code page of the string argument, and the result of the function is in the code page of the string argument.

**Difference between CODEUNITS16 and CODEUNITS32:** When CODEUNITS16 or CODEUNITS32 is specified, the result is the same except when the data contains Unicode supplementary characters. This is because a supplementary character is represented by two UTF-16 code units or one UTF-32 code unit. In UTF-8, a non-supplementary character is represented by 1 to 3 bytes, and a supplementary character is represented by 4 bytes. In UTF-16, a non-supplementary character is represented by one CODEUNITS16 code unit or 2 bytes, and a supplementary character is represented by two CODEUNITS16 code units or 4 bytes. In UTF-32, a character is represented by one CODEUNITS32 code unit or 4 bytes.

For example, the following table shows the hexadecimal values for the mathematical bold capital A and the Latin capital letter A. The mathematical bold capital A is a supplementary character that is represented by 4 bytes in UTF-8, UTF-16, and UTF-32.

| Character   | UTF-8 representation | UTF-16BE representation | UTF-32BE representation |
|---|----------------------|-------------------------|-------------------------|
| Unicode value X'1D400' - 'A';<br>mathematical bold<br>capital A | X'F09D9080'          | X'D835DC00'             | X'0001D400'             |
| Unicode value X'0041' - 'A';<br>latin capital<br>letter A       | X'41'                | X'0041'                 | X'00000041'             |

Assume that C1 is a VARCHAR(128) column, encoded in Unicode UTF-8, and that table T1 contains one row with the value of the mathematical bold capital A (X'F09D9080'). The following queries return different results:

| Query   | Returns    |
|---|------------|
| -----<br>SELECT CHARACTER_LENGTH(C1, CODEUNITS16) FROM T1 | -----<br>2 |

## String units in built-in functions

|   |   |
|---|---|
| <code>SELECT CHARACTER_LENGTH(C1, CODEUNITS32) FROM T1</code> | 1 |
| <code>SELECT CHARACTER_LENGTH(C1, OCTETS) FROM T1</code>      | 4 |

## Graphic strings

A *graphic string* is a sequence of bytes that represents double-byte character data. The length of the string is the number of double-byte characters in the sequence. If the length is zero, the value is called the *empty string*. This value should not be confused with the null value.

Graphic strings are not checked to ensure that their values contain only double-byte character code points. (The exception to this rule is an application precompiled with the WCHARTYPE CONVERT option. In this case, validation does occur.) Rather, the database manager assumes that double-byte character data is contained in graphic data fields. The database manager *does* check that a graphic string value is an even number of bytes long.

NUL-terminated graphic strings found in C are handled differently, depending on the standards level of the precompile option. This data type cannot be created in a table. It can only be used to insert data into and retrieve data from the database.

### Fixed-length graphic strings (GRAPHIC)

All values in a fixed-length graphic string column have the same length, which is determined by the length attribute of the column. The length attribute must be between 1 and 127, inclusive.

### Varying-length graphic strings

There are three types of varying-length graphic string:

- A VARCHAR value can be up to 16 384 double-byte characters long.
- A LONG VARCHAR value can be up to 16 384 double-byte characters long.
- A DBCLOB (double-byte character large object) value can be up to 1 073 741 823 double-byte characters long. A DBCLOB is used to store large DBCS character-based data (such as documents written with a single character set) and, therefore, has a DBCS code page associated with it.

Special restrictions apply to an expression that results in a varying-length graphic string whose maximum length is greater than 127 bytes. These restrictions are the same as those specified in “Varying-length character strings” on page 81.

### Binary strings

A *binary string* is a sequence of bytes. Unlike character strings, which usually contain text data, binary strings are used to hold non-traditional data such as pictures, voice, or mixed media. Character strings of the FOR BIT DATA subtype may be used for similar purposes, but the two data types are not compatible. The BLOB scalar function can be used to cast a FOR BIT DATA character string to a binary string. Binary strings are not associated with a code page. They have the same restrictions as character strings (for details, see “Varying-length character strings” on page 81).

#### **Binary large object (BLOB)**

A *binary large object* is a varying-length binary string that can be up to 2 gigabytes (2 147 483 647 bytes) long. BLOBs can hold structured data for exploitation by user-defined types and user-defined functions. Like FOR BIT DATA character strings, BLOB strings are not associated with a code page.

## Large objects (LOBs)

The term *large object* and the generic acronym LOB refer to the BLOB, CLOB, or DBCLOB data type. LOB values are subject to restrictions that apply to LONG VARCHAR values, as described in “Varying-length character strings” on page 81. These restrictions apply even if the length attribute of the LOB string is 254 bytes or less.

LOB values can be very large, and the transfer of these values from the database server to client application program host variables can be time consuming. Because application programs typically process LOB values one piece at a time, rather than as a whole, applications can reference a LOB value by using a large object locator.

A *large object locator*, or LOB locator, is a host variable whose value represents a single LOB value on the database server.

An application program can select a LOB value into a LOB locator. Then, using the LOB locator, the application program can request database operations on the LOB value (such as applying the scalar functions SUBSTR, CONCAT, VALUE, or LENGTH; performing an assignment; searching the LOB with LIKE or POSSTR; or applying user-defined functions against the LOB) by supplying the locator value as input. The resulting output (data assigned to a client host variable) would typically be a small subset of the input LOB value.

LOB locators can represent more than just base values; they can also represent the value associated with a LOB expression. For example, a LOB locator might represent the value associated with:

```
SUBSTR( <lob 1> CONCAT <lob 2> CONCAT <lob 3>, <start>, <length> )
```

When a null value is selected into a normal host variable, the indicator variable is set to -1, signifying that the value is null. In the case of LOB locators, however, the meaning of indicator variables is slightly different. Because a locator host variable can itself never be null, a negative indicator variable value indicates that the LOB value represented by the LOB locator is null. The null information is kept local to the client by virtue of the indicator variable value — the server does not track null values with valid locators.

It is important to understand that a LOB locator represents a value, not a row or a location in the database. Once a value is selected into a locator, there is no operation that one can perform on the original row or table that will affect the value which is referenced by the locator. The value associated with a locator is valid until the transaction ends, or until the locator is explicitly freed, whichever comes first. Locators do not force extra copies of the data to provide this function. Instead, the locator mechanism stores a description of the base LOB value. The materialization of the LOB value (or expression, as shown above) is deferred until it is actually assigned to some location — either a user buffer in the form of a host variable, or another record in the database.

A LOB locator is only a mechanism used to refer to a LOB value during a transaction; it does not persist beyond the transaction in which it was created. It is not a database type; it is never stored in the database and, as a result, cannot participate in views or check constraints. However, because a LOB locator is a client representation of a LOB type, there are SQLTYPEs for LOB locators so that they can be described within an SQLDA structure used by FETCH, OPEN, or EXECUTE statements.

### Datetime values

The datetime data types include DATE, TIME, and TIMESTAMP. Although datetime values can be used in certain arithmetic and string operations, and are compatible with certain strings, they are neither strings nor numbers.

#### Date

A *date* is a three-part value (year, month, and day). The range of the year part is 0001 to 9999. The range of the month part is 1 to 12. The range of the day part is 1 to  $x$ , where  $x$  depends on the month.

The internal representation of a date is a string of 4 bytes. Each byte consists of 2 packed decimal digits. The first 2 bytes represent the year, the third byte the month, and the last byte the day.

The length of a DATE column, as described in the SQLDA, is 10 bytes, which is the appropriate length for a character string representation of the value.

#### Time

A *time* is a three-part value (hour, minute, and second) designating a time of day under a 24-hour clock. The range of the hour part is 0 to 24. The range of the other parts is 0 to 59. If the hour is 24, the minute and second specifications are zero.

The internal representation of a time is a string of 3 bytes. Each byte consists of 2 packed decimal digits. The first byte represents the hour, the second byte the minute, and the last byte the second.

The length of a TIME column, as described in the SQLDA, is 8 bytes, which is the appropriate length for a character string representation of the value.

#### Timestamp

A *timestamp* is a seven-part value (year, month, day, hour, minute, second, and microsecond) designating a date and time as defined above, except that the time includes a fractional specification of microseconds.

The internal representation of a timestamp is a string of 10 bytes. Each byte consists of 2 packed decimal digits. The first 4 bytes represent the date, the next 3 bytes the time, and the last 3 bytes the microseconds.

The length of a TIMESTAMP column, as described in the SQLDA, is 26 bytes, which is the appropriate length for the character string representation of the value.

#### String representations of datetime values

Values whose data types are DATE, TIME, or TIMESTAMP are represented in an internal form that is transparent to the user. Date, time, and timestamp values can, however, also be represented by strings. This is useful because there are no constants or variables whose data types are DATE, TIME, or TIMESTAMP. Before it can be retrieved, a datetime value must be assigned to a string variable. The CHAR function or the GRAPHIC function (for Unicode databases only) can be used to change a datetime value to a string representation. The string representation is normally the default format of datetime values associated with the territory code of the application, unless overridden by specification of the DATETIME option when the program is precompiled or bound to the database.

## String representations of datetime values

No matter what its length, a large object string, a LONG VARCHAR value, or a LONG VARGRAPHIC value cannot be used to represent a datetime value (SQLSTATE 42884).

When a valid string representation of a datetime value is used in an operation with an internal datetime value, the string representation is converted to the internal form of the date, time, or timestamp value before the operation is performed.

Date, time and timestamp strings must contain only characters and digits.

**Date strings:** A string representation of a date is a string that starts with a digit and has a length of at least 8 characters. Trailing blanks may be included; leading zeros may be omitted from the month and day portions.

Valid string formats for dates are listed in the following table. Each format is identified by name and associated abbreviation.

*Table 3. Formats for String Representations of Dates*

| Format Name                                | Abbreviation | Date Format                                      | Example    |
|--|--------------|--|------------|
| International Standards Organization       | ISO          | yyyy-mm-dd                                       | 1991-10-27 |
| IBM USA standard                           | USA          | mm/dd/yyyy                                       | 10/27/1991 |
| IBM European standard                      | EUR          | dd.mm.yyyy                                       | 27.10.1991 |
| Japanese Industrial Standard Christian Era | JIS          | yyyy-mm-dd                                       | 1991-10-27 |
| Site-defined                               | LOC          | Depends on the territory code of the application | —          |

**Time strings:** A string representation of a time is a string that starts with a digit and has a length of at least 4 characters. Trailing blanks can be included; a leading zero can be omitted from the hour part of the time, and seconds can be omitted entirely. If seconds are omitted, an implicit specification of 0 seconds is assumed. Thus, 13:30 is equivalent to 13:30:00.

Valid string formats for times are listed in the following table. Each format is identified by name and associated abbreviation.

*Table 4. Formats for String Representations of Times*

| Format Name                                | Abbreviation | Time Format                                      | Example  |
|--|--------------|--|----------|
| International Standards Organization       | ISO          | hh.mm.ss   | 13.30.05 |
| IBM USA standard                           | USA          | hh:mm AM or PM                                   | 1:30 PM  |
| IBM European standard                      | EUR          | hh.mm.ss   | 13.30.05 |
| Japanese Industrial Standard Christian Era | JIS          | hh:mm:ss   | 13:30:05 |
| Site-defined                               | LOC          | Depends on the territory code of the application | —        |

## Time strings

### Notes:

1. In ISO, EUR, or JIS format, .ss (or :ss) is optional.
2. The International Standards Organization changed the time format so that it is identical to the Japanese Industrial Standard Christian Era format. Therefore, use the JIS format if an application requires the current International Standards Organization format.
3. In the USA time string format, the minutes specification can be omitted, indicating an implicit specification of 00 minutes. Thus, 1 PM is equivalent to 1:00 PM.
4. In the USA time string format, the hour must not be greater than 12 and cannot be 0, except in the special case of 00:00 AM. There is a single space before 'AM' or 'PM'. 'AM' and 'PM' can be represented in lowercase or uppercase characters.

Using the JIS format of the 24-hour clock, the correspondence between the USA format and the 24-hour clock is as follows:

12:01 AM through 12:59 AM corresponds to 00:01:00 through 00:59:00.

01:00 AM through 11:59 AM corresponds to 01:00:00 through 11:59:00.

12:00 PM (noon) through 11:59 PM corresponds to 12:00:00 through 23:59:00.

12:00 AM (midnight) corresponds to 24:00:00 and 00:00 AM (midnight) corresponds to 00:00:00.

**Timestamp strings:** A string representation of a timestamp is a string that starts with a digit and has a length of at least 16 characters. The complete string representation of a timestamp has the form *yyyy-mm-dd-hh.mm.ss.nnnnnnn*. Trailing blanks may be included. Leading zeros may be omitted from the month, day, and hour part of the timestamp, and microseconds may be truncated or entirely omitted. If any trailing zero digits are omitted in the microseconds portion, an implicit specification of 0 is assumed for the missing digits. Thus, 1991-3-2-8.30.00 is equivalent to 1991-03-02-08.30.00.000000.

SQL statements also support the ODBC string representation of a timestamp, but as an input value only. The ODBC string representation of a timestamp has the form *yyyy-mm-dd hh:mm:ss.nnnnnnn*.



## DATALINK values

A DATALINK value is an encapsulated value that contains a logical reference from the database to a file stored outside of the database. The attributes of this encapsulated value are as follows:

### link type

The currently supported type of link is 'URL' (Uniform Resource Locator).

### data location

The location of a file linked with a reference within DB2, in the form of a URL. The allowed scheme names for this URL are:

- HTTP
- FILE
- UNC

The other parts of the URL are:

- the file server name for the HTTP, FILE, and UNC schemes
- the full file path name within the file server

### comment

Up to 200 bytes of descriptive information, *including* the data location attribute. This is intended for application-specific uses, such as further or alternative identification of the location of the data.

Leading and trailing blank characters are trimmed while parsing data location attributes as URLs. Also, the scheme names ('http', 'file', 'unc') and host are case-insensitive and are always stored in the database in uppercase. When a DATALINK value is fetched from a database, an access token is embedded within the URL attribute, if the DATALINK column is defined with READ PERMISSION DB or WRITE PERMISSION ADMIN. The token is generated dynamically, and is not a permanent part of the DATALINK value stored in the database.

It is possible for a DATALINK value to have only a comment attribute and an empty data location attribute. Such a value may even be stored in a column but, of course, no file will be linked to such a column. The total length of the comment and the data location attribute of a DATALINK value is currently limited to 200 bytes.

It is important to distinguish between DATALINK references to files and LOB file reference variables. The similarity is that they both contain a representation of a file. However:

- DATALINKs are retained in the database, and both the links and the data in the linked files can be considered to be a natural extension of data in the database.
- File reference variables exist temporarily on the client and they can be considered to be an alternative to a host program buffer.

Use built-in scalar functions to build a DATALINK value (DLVALUE, DLNEWCOPY, DLPREVIOUSCOPY, and DLREPLACECONTENT) and to extract the encapsulated values from a DATALINK value (DLCOMMENT, DLLINKTYPE, DLURLCOMPLETE, DLURLPATH, DLURLPATHONLY, DLURLSCHEME, DLURLSERVER, DLURLCOMPLETEONLY, DLURLCOMPLETEWRITE, and DLURLPATHWRITE).

### Related reference:

## DATALINK values

- Appendix O, "Backus-Naur form (BNF) specifications for DATALINKs," on page 847
- "Identifiers" on page 57

## XML values

An XML value represents well-formed XML in the form of an XML document, XML content, or a sequence of XML nodes. An XML value that is stored in a table as a value of a column defined with the XML data type must be a well-formed XML document. XML values are processed in an internal representation that is not comparable to any string value. An XML value can be transformed into a serialized string value representing the XML document using the XMLSERIALIZE function. Similarly, a string value that represents an XML document can be transformed into an XML value using the XMLPARSE function. An XML value can be implicitly parsed or serialized when exchanged with application string and binary data types.

Special restrictions apply to expressions that result in an XML data type value; such expressions and columns are not permitted in (SQLSTATE 42818):

- A SELECT list preceded by the DISTINCT clause
- A GROUP BY clause
- An ORDER BY clause
- A subselect of a set operator other than UNION ALL
- A basic, quantified, BETWEEN, IN, or LIKE predicate
- An aggregate function with DISTINCT

**Related reference:**

- “XMLPARSE ” on page 469
- “XMLSERIALIZE ” on page 476

### User-defined types

There are three types of user-defined data type:

- Distinct type
- Structured type
- Reference type

Each of these types is described in the following sections.

#### Distinct types

A *distinct type* is a user-defined data type that shares its internal representation with an existing type (its “source” type), but is considered to be a separate and incompatible type for most operations. For example, one might want to define a picture type, a text type, and an audio type, all of which have quite different semantics, but which use the built-in data type BLOB for their internal representation.

The following example illustrates the creation of a distinct type named AUDIO:

```
CREATE DISTINCT TYPE AUDIO AS BLOB (1M)
```

Although AUDIO has the same representation as the built-in data type BLOB, it is considered to be a separate type; this allows the creation of functions written specifically for AUDIO, and assures that these functions will not be applied to values of any other data type (pictures, text, and so on).

Distinct types have qualified identifiers. If the schema name is not used to qualify the distinct type name when used in other than the CREATE DISTINCT TYPE, DROP DISTINCT TYPE, or COMMENT ON DISTINCT TYPE statements, the SQL path is searched in sequence for the first schema with a distinct type that matches.

Distinct types support strong typing by ensuring that only those functions and operators explicitly defined on a distinct type can be applied to its instances. For this reason, a distinct type does not automatically acquire the functions and operators of its source type, because these may not be meaningful. (For example, the LENGTH function of the AUDIO type might return the length of its object in seconds rather than in bytes.)

Distinct types sourced on LONG VARCHAR, LONG VARGRAPHIC, LOB types, or DATALINK are subject to the same restrictions as their source type.

However, certain functions and operators of the source type can be explicitly specified to apply to the distinct type. This can be done by creating user-defined functions that are sourced on functions defined on the source type of the distinct type. The comparison operators are automatically generated for user-defined distinct types, except those using LONG VARCHAR, LONG VARGRAPHIC, BLOB, CLOB, DBCLOB, or DATALINK as the source type. In addition, functions are generated to support casting from the source type to the distinct type, and from the distinct type to the source type.

#### Structured types

A *structured type* is a user-defined data type that has a structure that is defined in the database. It contains a sequence of named *attributes*, each of which has a data type. A structured type also includes a set of method specifications.

A structured type may be used as the type of a table, view, or column. When used as a type for a table or view, that table or view is known as a *typed table* or *typed view*, respectively. For typed tables and typed views, the names and data types of the attributes of the structured type become the names and data types of the columns of this typed table or typed view. Rows of the typed table or typed view can be thought of as a representation of instances of the structured type. When used as a data type for a column, the column contains values of that structured type (or values of any of that type's subtypes, as defined below). Methods are used to retrieve or manipulate attributes of a structured column object.

*Terminology:* A *supertype* is a structured type for which other structured types, called *subtypes*, have been defined. A subtype inherits all the attributes and methods of its supertype and may have additional attributes and methods defined. The set of structured types that are related to a common supertype is called a *type hierarchy* and the type that does not have any supertype is called the *root type* of the type hierarchy.

The term subtype applies to a user-defined structured type and all user-defined structured types that are below it in the type hierarchy. Therefore, a subtype of a structured type T is T and all structured types below T in the hierarchy. A *proper subtype* of a structured type T is a structured type below T in the type hierarchy.

There are restrictions on having recursive type definitions in a type hierarchy. For this reason, it is necessary to develop a shorthand way of referring to the specific type of recursive definitions that are allowed. The following definitions are used:

- *Directly uses:* A type **A** is said to directly use another type **B**, if and only if one of the following is true:
  1. type **A** has an attribute of type **B**
  2. type **B** is a subtype of **A**, or a supertype of **A**
- *Indirectly uses:* A type **A** is said to indirectly use a type **B**, if one of the following is true:
  1. type **A** directly uses type **B**
  2. type **A** directly uses some type **C**, and type **C** indirectly uses type **B**

A type may not be defined so that one of its attribute types directly or indirectly uses itself. If it is necessary to have such a configuration, consider using a reference as the attribute. For example, with structured type attributes, there cannot be an instance of "employee" with an attribute of "manager" when "manager" is of type "employee". There can, however, be an attribute of "manager" with a type of REF(employee).

A type cannot be dropped if certain other objects use the type, either directly or indirectly. For example, a type cannot be dropped if a table or view column makes direct or indirect use of the type.

## Reference types

A *reference type* is a companion type to a structured type. Similar to a distinct type, a reference type is a scalar type that shares a common representation with one of the built-in data types. This same representation is shared for all types in the type hierarchy. The reference type representation is defined when the root type of a type hierarchy is created. When using a reference type, a structured type is specified as a parameter of the type. This parameter is called the *target type* of the reference.

The target of a reference is always a row in a typed table or a typed view. When a reference type is used, it may have a *scope* defined. The scope identifies a table

## Reference types

(called the *target table*) or view (called the *target view*) that contains the target row of a reference value. The target table or view must have the same type as the target type of the reference type. An instance of a scoped reference type uniquely identifies a row in a typed table or typed view, called the *target row*.

### Related reference:

- “Assignments and comparisons” on page 105
- “Character strings” on page 81
- “CURRENT PATH ” on page 145
- “DROP statement” in *SQL Reference, Volume 2*

## Promotion of data types

Data types can be classified into groups of related data types. Within such groups, a precedence order exists where one data type is considered to precede another data type. This precedence is used to allow the *promotion* of one data type to a data type later in the precedence ordering. For example, the data type CHAR can be promoted to VARCHAR; INTEGER can be promoted to DOUBLE-PRECISION; but CLOB is NOT promotable to VARCHAR.

Promotion of data types is used when:

- Performing function resolution
- Casting user-defined types
- Assigning user-defined types to built-in data types

Table 5 shows the precedence list (in order) for each data type and can be used to determine the data types to which a given data type can be promoted. The table shows that the best choice is always the same data type instead of choosing to promote to another data type.

Table 5. Data Type Precedence Table

| Data Type       | Data Type Precedence List (in best-to-worst order) |
|-----------------|--|
| CHAR            | CHAR, VARCHAR, LONG VARCHAR, CLOB                  |
| VARCHAR         | VARCHAR, LONG VARCHAR, CLOB                        |
| LONG VARCHAR    | LONG VARCHAR, CLOB                                 |
| GRAPHIC         | GRAPHIC, VARGRAPHIC, LONG VARGRAPHIC, DBCLOB       |
| VARGRAPHIC      | VARGRAPHIC, LONG VARGRAPHIC, DBCLOB                |
| LONG VARGRAPHIC | LONG VARGRAPHIC, DBCLOB                            |
| BLOB            | BLOB   |
| CLOB            | CLOB   |
| DBCLOB          | DBCLOB   |
| SMALLINT        | SMALLINT, INTEGER, BIGINT, decimal, real, double   |
| INTEGER         | INTEGER, BIGINT, decimal, real, double             |
| BIGINT          | BIGINT, decimal, real, double                      |
| decimal         | decimal, real, double                              |
| real            | real, double                                       |
| double          | double   |
| DATE            | DATE   |
| TIME            | TIME   |
| TIMESTAMP       | TIMESTAMP  |
| DATALINK        | DATALINK   |
| udt             | udt (same name) or a supertype of udt              |
| REF(T)          | REF(S) (provided that S is a supertype of T)       |

## Promotion of data types

Table 5. Data Type Precedence Table (continued)

| Data Type   | Data Type Precedence List (in best-to-worst order) |
|---|--|
| <b>Notes:</b>   |  |
| 1. The lowercase types above are defined as follows:  |  |
| • decimal = DECIMAL(p,s) or NUMERIC(p,s)  |  |
| • real = REAL or FLOAT( <i>n</i> ), where <i>n</i> is not greater than 24                                   |  |
| • double = DOUBLE, DOUBLE-PRECISION, FLOAT or FLOAT( <i>n</i> ), where <i>n</i> is greater than 24          |  |
| • udt = a user-defined type   |  |
| Shorter and longer form synonyms of the listed data types are considered to be the same as the listed form. |  |
| 2. For a Unicode database, the following are considered to be equivalent data types:                        |  |
| • CHAR and GRAPHIC  |  |
| • VARCHAR and VARCHAR2  |  |
| • LONG VARCHAR and LONG VARCHAR2  |  |
| • CLOB and NCLOB  |  |

### Related reference:

- “Assignments and comparisons” on page 105
- “Casting between data types” on page 99
- “Functions” on page 157



## Casting between data types

There are many occasions where a value with a given data type needs to be *cast* to a different data type or to the same data type with a different length, precision, or scale. Data type promotion is one example where the promotion of one data type to another data type requires that the value be cast to the new data type. A data type that can be cast to another data type is *castable* from the source data type to the target data type.

The casting of one data type to another can occur implicitly or explicitly. The cast functions, CAST specification, or XMLCAST specification can be used to explicitly change a data type, depending on the data types involved. The database manager might implicitly cast data types during assignments that involve a distinct type. In addition, when a sourced user-defined function is created, the data types of the parameters of the source function must be castable to the data types of the function that is being created.

The supported casts between built-in data types are shown in Table 6 on page 100. The first column represents the data type of the cast operand (source data type), and the data types across the top represent the target data type of the cast operation. A 'Y' indicates that the CAST specification can be used for the combination of source and target data types. Cases in which only the XMLCAST specification can be used are noted.

In a Unicode database, if a truncation occurs when a character or graphic string is cast to another data type, a warning returns if any nonblank characters are truncated. This truncation behavior is unlike the assignment of character or graphic strings to a target when an error occurs if any nonblank characters are truncated.

The following casts involving distinct types are supported (using the CAST specification unless noted otherwise):

- Cast from distinct type *DT* to its source data type *S*
- Cast from the source data type *S* of distinct type *DT* to distinct type *DT*
- Cast from distinct type *DT* to the same distinct type *DT*
- Cast from a data type *A* to distinct type *DT* where *A* is promotable to the source data type *S* of distinct type *DT*
- Cast from an INTEGER to distinct type *DT* with a source data type SMALLINT
- Cast from a DOUBLE to distinct type *DT* with a source data type REAL
- Cast from a VARCHAR to distinct type *DT* with a source data type CHAR
- Cast from a VARGRAPHIC to distinct type *DT* with a source data type GRAPHIC
- For a Unicode database, cast from a VARCHAR or a VARGRAPHIC to distinct type *DT* with a source data type CHAR or GRAPHIC
- Cast from a distinct type *DT* with a source data type *S* to XML using the XMLCAST specification
- Cast from an XML to a distinct type *DT* with a source data type of any built-in data type, using the XMLCAST specification depending on the XML schema data type of the XML value

FOR BIT DATA character types cannot be cast to CLOB.

It is not possible to cast a structured type value to something else. A structured type *ST* should not need to be cast to one of its supertypes, because all methods on

## Casting between data types

the supertypes of *ST* are applicable to *ST*. If the desired operation is only applicable to a subtype of *ST*, use the subtype-treatment expression to treat *ST* as one of its subtypes.

When a user-defined data type involved in a cast is not qualified by a schema name, the *SQL path* is used to find the first schema that includes the user-defined data type by that name.

The following casts involving reference types are supported:

- cast from reference type *RT* to its representation data type *S*
- cast from the representation data type *S* of reference type *RT* to reference type *RT*
- cast from reference type *RT* with target type *T* to a reference type *RS* with target type *S* where *S* is a supertype of *T*.
- cast from a data type *A* to reference type *RT*, where *A* is promotable to the representation data type *S* of reference type *RT*.

When the target type of a reference data type involved in a cast is not qualified by a schema name, the *SQL path* is used to find the first schema that includes the user-defined data type by that name.

Table 6. Supported Casts between Built-in Data Types

| Source Data Type | Target Data Type |   |   |   |   |   |                |                |                |                |                |                |                |                |                |                |                |   |                |
|------------------|------------------|---|---|---|---|---|----------------|----------------|----------------|----------------|----------------|----------------|----------------|----------------|----------------|----------------|----------------|---|----------------|
|                  | S                | M | I | D | D | V | L              | V              | G              | V              | R              | A              | L              | T              | I              | M              |                |   |                |
| SMALLINT         | Y                | Y | Y | Y | Y | Y | Y              | -              | -              | -              | -              | -              | -              | -              | -              | -              | Y <sup>3</sup> |   |                |
| INTEGER          | Y                | Y | Y | Y | Y | Y | Y              | -              | -              | -              | -              | -              | -              | -              | -              | -              | Y <sup>3</sup> |   |                |
| BIGINT           | Y                | Y | Y | Y | Y | Y | Y              | -              | -              | -              | -              | -              | -              | -              | -              | -              | Y <sup>3</sup> |   |                |
| DECIMAL          | Y                | Y | Y | Y | Y | Y | Y              | -              | -              | -              | -              | -              | -              | -              | -              | -              | Y <sup>3</sup> |   |                |
| REAL             | Y                | Y | Y | Y | Y | Y | -              | -              | -              | -              | -              | -              | -              | -              | -              | -              | Y <sup>3</sup> |   |                |
| DOUBLE           | Y                | Y | Y | Y | Y | Y | Y              | -              | -              | -              | -              | -              | -              | -              | -              | -              | Y <sup>3</sup> |   |                |
| CHAR             | Y                | Y | Y | Y | - | - | Y              | Y              | Y              | Y <sup>2</sup> | Y <sup>1</sup> | Y <sup>1</sup> | -              | -              | Y              | Y              | Y              | Y | Y <sup>4</sup> |
| VARCHAR          | Y                | Y | Y | Y | - | - | Y              | Y              | Y              | Y <sup>2</sup> | Y <sup>1</sup> | Y <sup>1</sup> | -              | -              | Y              | Y              | Y              | Y | Y <sup>4</sup> |
| LONG VARCHAR     | -                | - | - | - | - | - | Y              | Y              | Y              | Y <sup>2</sup> | -              | -              | Y <sup>1</sup> | Y <sup>1</sup> | -              | -              | -              | Y | Y <sup>3</sup> |
| CLOB             | -                | - | - | - | - | - | Y              | Y              | Y              | Y              | -              | -              | -              | Y <sup>1</sup> | -              | -              | -              | Y | Y <sup>4</sup> |
| GRAPHIC          | -                | - | - | - | - | - | Y <sup>1</sup> | Y <sup>1</sup> | -              | -              | Y              | Y              | Y              | Y              | Y <sup>1</sup> | Y <sup>1</sup> | Y <sup>1</sup> | Y | Y <sup>3</sup> |
| VARGRAPHIC       | -                | - | - | - | - | - | Y <sup>1</sup> | Y <sup>1</sup> | -              | -              | Y              | Y              | Y              | Y              | Y <sup>1</sup> | Y <sup>1</sup> | Y <sup>1</sup> | Y | Y <sup>3</sup> |
| LONG VARGRAPHIC  | -                | - | - | - | - | - | -              | -              | Y <sup>1</sup> | Y <sup>1</sup> | Y              | Y              | Y              | Y              | -              | -              | -              | Y | Y <sup>3</sup> |
| DBCLOB           | -                | - | - | - | - | - | -              | -              | -              | Y <sup>1</sup> | Y              | Y              | Y              | Y              | -              | -              | -              | Y | Y <sup>3</sup> |
| DATE             | -                | Y | Y | Y | - | - | Y              | Y              | -              | -              | Y <sup>1</sup> | Y <sup>1</sup> | -              | -              | Y              | -              | -              | - | Y <sup>3</sup> |
| TIME             | -                | Y | Y | Y | - | - | Y              | Y              | -              | -              | Y <sup>1</sup> | Y <sup>1</sup> | -              | -              | -              | Y              | -              | - | Y <sup>3</sup> |

Table 6. Supported Casts between Built-in Data Types (continued)

| Source Data Type | Target Data Type |                |                |                |                |                |                |                |                |                |                |                |                |                |                |                |                |                |                |                |
|------------------|------------------|----------------|----------------|----------------|----------------|----------------|----------------|----------------|----------------|----------------|----------------|----------------|----------------|----------------|----------------|----------------|----------------|----------------|----------------|----------------|
|                  | S                | M              | I              | D              |                |                |                | V              | V              | G              | G              | L              |                |                |                |                |                |                | T              |                |
| TIMESTAMP        | -                | -              | Y              | Y              | -              | -              | Y              | Y              | -              | -              | Y <sup>1</sup> | Y <sup>1</sup> | -              | -              | Y              | Y              | Y              | -              | Y <sup>3</sup> |                |
| BLOB             | -                | -              | -              | -              | -              | -              | -              | -              | -              | -              | -              | -              | -              | -              | -              | -              | -              | -              | Y              | Y <sup>4</sup> |
| XML              | Y <sup>5</sup>   | Y <sup>5</sup> | Y <sup>5</sup> | Y <sup>5</sup> | Y <sup>5</sup> | Y <sup>5</sup> | Y <sup>5</sup> | Y <sup>5</sup> | Y <sup>5</sup> | Y <sup>5</sup> | Y <sup>5</sup> | Y <sup>5</sup> | Y <sup>5</sup> | Y <sup>5</sup> | Y <sup>5</sup> | Y <sup>5</sup> | Y <sup>5</sup> | Y <sup>5</sup> | Y <sup>5</sup> | Y              |

Notes

- See the description preceding the table for information on supported casts involving user-defined types and reference types.
- Only a DATALINK type can be cast to a DATALINK type.
- It is not possible to cast a structured type value to anything else.

<sup>1</sup> Cast is only supported for Unicode databases.

<sup>2</sup> FOR BIT DATA character types cannot be cast to CLOB.

<sup>3</sup> Cast can only be performed using XMLCAST.

<sup>4</sup> An XMLPARSE function is implicitly processed to convert a string to XML on assignment (INSERT or UPDATE) of a string to an XML column. The string must be a well-formed XML document for the assignment to succeed.

<sup>5</sup> Cast can only be performed using XMLCAST and depends on the underlying XML schema data type of the XML value. For details, see “XMLCAST”.

### Casting non-XML values to XML values

Table 7. Supported Casts from Non-XML Values to XML Values

| Source Data Type   | Target Data Type |                           |
|--------------------|------------------|---------------------------|
|                    | XML              | Resulting XML Schema Type |
| SMALLINT           | Y                | xs:short                  |
| INTEGER            | Y                | xs:int                    |
| BIGINT             | Y                | xs:long                   |
| DECIMAL or NUMERIC | Y                | xs:decimal                |
| REAL               | Y                | xs:float                  |
| DOUBLE             | Y                | xs:double                 |
| CHAR               | Y                | xs:string                 |
| VARCHAR            | Y                | xs:string                 |
| LONG VARCHAR       | Y                | xs:string                 |
| CLOB               | Y                | xs:string                 |
| GRAPHIC            | Y                | xs:string                 |
| VARGRAPHIC         | Y                | xs:string                 |

## Casting between data types

Table 7. Supported Casts from Non-XML Values to XML Values (continued)

| Source Data Type            | Target Data Type |  |
|-----------------------------|------------------|--|
|                             | XML              | Resulting XML Schema Type                                |
| LONG VARCHAR                | Y                | xs:string  |
| DBCLOB                      | Y                | xs:string  |
| DATE                        | Y                | xs:date  |
| TIME                        | Y                | xs:time  |
| TIMESTAMP                   | Y                | xs:dateTime  |
| BLOB                        | Y                | xs:base64Binary  |
| character type FOR BIT DATA | Y                | xs:base64Binary  |
| distinct type               |                  | use this chart with the source type of the distinct type |

When character string values are cast to XML values, the resulting xs:string atomic value cannot contain illegal XML characters (SQLSTATE 0N002). If the input character string is not in Unicode, the input characters are converted to Unicode.

Casting to SQL binary types results in XQuery atomic values with the type xs:base64Binary.

### Casting XML values to non-XML values

An XMLCAST from an XML value to a non-XML value can be described as two casts: an XQuery cast that converts the source XML value to an XQuery type corresponding to the SQL target type, followed by a cast from the corresponding XQuery type to the actual SQL type.

An XMLCAST is supported if the target type has a corresponding XQuery target type that is supported, and if there is a supported XQuery cast from the source value's type to the corresponding XQuery target type. The target type that is used in the XQuery cast is based on the corresponding XQuery target type and might contain some additional restrictions.

The following table lists the XQuery types that result from such conversion.

Table 8. Supported Casts from XML Values to Non-XML Values

| Target Data Type   | Source Data Type |                                  |
|--------------------|------------------|----------------------------------|
|                    | XML              | Corresponding XQuery Target Type |
| SMALLINT           | Y                | xs:short                         |
| INTEGER            | Y                | xs:int                           |
| BIGINT             | Y                | xs:long                          |
| DECIMAL or NUMERIC | Y                | xs:decimal                       |
| REAL               | Y                | xs:float                         |
| DOUBLE             | Y                | xs:double                        |
| FLOAT              | Y                | xs:double or xs:float            |
| CHAR               | Y                | xs:string                        |
| VARCHAR            | Y                | xs:string                        |
| LONG VARCHAR       | N                | not castable                     |
| CLOB               | Y                | xs:string                        |

Table 8. Supported Casts from XML Values to Non-XML Values (continued)

| Target Data Type                     | Source Data Type |  |
|--------------------------------------|------------------|--|
|                                      | XML              | Corresponding XQuery Target Type                         |
| GRAPHIC                              | Y                | xs:string  |
| VARGRAPHIC                           | Y                | xs:string  |
| LONG VARGRAPHIC                      | N                | not castable   |
| DBCLOB                               | Y                | xs:string  |
| DATE                                 | Y                | xs:date  |
| TIME (without time zone)             | Y                | xs:time  |
| TIMESTAMP (without time zone)        | Y                | xs:dateTime  |
| BLOB                                 | Y                | xs:base64Binary  |
| CHAR FOR BIT DATA                    | N                | not castable   |
| VARCHAR FOR BIT DATA                 | Y                | xs:base64Binary  |
| distinct type                        |                  | use this chart with the source type of the distinct type |
| row reference structured / ADT other | N                | not castable   |

In the following restriction cases, a derived by restriction XML schema data type is effectively used as the target data type for the XQuery cast.

- XML values that are to be converted to string types must fit within the length limits of those DB2 types without truncation of any characters or bytes. The name used for the derived XML schema type is the uppercase SQL type name followed by an underscore character and the maximum length of the string; for example, VARCHAR\_20 if the XMLCAST target data type is VARCHAR(20).
- XML values that are to be converted to DECIMAL values must fit within the precision of the specified DECIMAL values, and must not contain more non-zero digits after the decimal point than the scale. The name used for the derived XML schema type is DECIMAL\_precision\_scale, where *precision* is the precision of the target SQL data type, and *scale* is the scale of the target SQL data type; for example, DECIMAL\_9\_2 if the XMLCAST target data type is DECIMAL(9,2).
- XML values that are to be converted to TIME values cannot contain a seconds component with non-zero digits after the decimal point. The name used for the derived XML schema type is TIME.

The derived XML schema type name only appears in a message if an XML value does not conform to one of these restrictions. This type name helps one to understand the error message, and does not correspond to any defined XQuery type. If the input value does not conform to the base type of the derived XML schema type (the corresponding XQuery target type), the error message might indicate that type instead. Because this derived XML schema type name format might change in the future, it should not be used as a programming interface.

Before an XML value is processed by the XQuery cast, any document node in the sequence is removed and each direct child of the removed document node becomes an item in the sequence. If the document node has multiple direct children nodes, the revised sequence will have more items than the original sequence. The XML value without any document nodes is then atomized using the XQuery fn:data function, with the resulting atomized sequence value used in the XQuery cast. If the atomized sequence value is an empty sequence, a null value is

## Casting between data types

returned from the cast without any further processing. If there are multiple items in the atomized sequence value, an error is returned (SQLSTATE 10507).

If the target type of XMLCAST is the SQL data type DATE, TIME, or TIMESTAMP, the resulting XML value from the XQuery cast is also adjusted to UTC, and the time zone component of the value is removed.

When the corresponding XQuery target type value is converted to the SQL target type, binary XML data types, such as xs:base64Binary or xs:hexBinary, are converted from character form to actual binary data.

If an xs:double or xs:float value of INF, -INF, or NaN is cast (using XMLCAST) to an SQL data type DOUBLE or REAL value, an error is returned (SQLSTATE 22003). An xs:double or xs:float value of -0 is converted to +0.

The target type can be a user-defined distinct type if the source operand is not a user-defined distinct type. In this case, the source value is cast to the source type of the user-defined distinct type (that is, the target type) using the XMLCAST specification, and then this value is cast to the user-defined distinct type using the CAST specification.

### Related concepts:

- “Atomization (DB2 XQuery)” in *IBM DB2 XQuery Reference*

### Related reference:

- “CREATE FUNCTION statement” in *SQL Reference, Volume 2*
- “Assignments and comparisons” on page 105
- “CAST specifications” on page 187
- “CURRENT PATH ” on page 145
- “Promotion of data types” on page 97
- “XMLCAST specifications” on page 190
- “Type casting (DB2 XQuery)” in *IBM DB2 XQuery Reference*

## Assignments and comparisons

The basic operations of SQL are assignment and comparison. Assignment operations are performed during the execution of INSERT, UPDATE, FETCH, SELECT INTO, VALUES INTO and SET transition-variable statements. Arguments of functions are also assigned when invoking a function. Comparison operations are performed during the execution of statements that include predicates and other language elements such as MAX, MIN, DISTINCT, GROUP BY, and ORDER BY.

One basic rule for both operations is that the data type of the operands involved must be compatible. The compatibility rule also applies to set operations.

Another basic rule for assignment operations is that a null value cannot be assigned to a column that cannot contain null values, nor to a host variable that does not have an associated indicator variable.

Assignments and comparisons involving both character and graphic data are only supported when one of the strings is a literal.

Following is a compatibility matrix showing the data type compatibilities for assignment and comparison operations.

Table 9. Data Type Compatibility for Assignments and Comparisons

| Operands         | Binary Integer | Decimal Number | Floating Point | Character String   | Graphic String     | Date         | Time         | Time-stamp   | Binary String   | UDT          |
|------------------|----------------|----------------|----------------|--------------------|--------------------|--------------|--------------|--------------|-----------------|--------------|
| Binary Integer   | Yes            | Yes            | Yes            | No                 | No                 | No           | No           | No           | No              | <sup>2</sup> |
| Decimal Number   | Yes            | Yes            | Yes            | No                 | No                 | No           | No           | No           | No              | <sup>2</sup> |
| Floating Point   | Yes            | Yes            | Yes            | No                 | No                 | No           | No           | No           | No              | <sup>2</sup> |
| Character String | No             | No             | No             | Yes                | Yes <sup>6,7</sup> | <sup>1</sup> | <sup>1</sup> | <sup>1</sup> | No <sup>3</sup> | <sup>2</sup> |
| Graphic String   | No             | No             | No             | Yes <sup>6,7</sup> | Yes                | <sup>1</sup> | <sup>1</sup> | <sup>1</sup> | No              | <sup>2</sup> |
| Date             | No             | No             | No             | <sup>1</sup>       | <sup>1</sup>       | Yes          | No           | No           | No              | <sup>2</sup> |
| Time             | No             | No             | No             | <sup>1</sup>       | <sup>1</sup>       | No           | Yes          | No           | No              | <sup>2</sup> |
| Timestamp        | No             | No             | No             | <sup>1</sup>       | <sup>1</sup>       | No           | No           | Yes          | No              | <sup>2</sup> |
| Binary String    | No             | No             | No             | No <sup>3</sup>    | No                 | No           | No           | No           | Yes             | <sup>2</sup> |
| UDT              | <sup>2</sup>   | <sup>2</sup>   | <sup>2</sup>   | <sup>2</sup>       | <sup>2</sup>       | <sup>2</sup> | <sup>2</sup> | <sup>2</sup> | <sup>2</sup>    | Yes          |

## Assignments and comparisons

Table 9. Data Type Compatibility for Assignments and Comparisons (continued)

| Operands | Binary Integer | Decimal Number | Floating Point | Character String | Graphic String | Date | Time | Time-stamp | Binary String | UDT |
|----------|----------------|----------------|----------------|------------------|----------------|------|------|------------|---------------|-----|
|----------|----------------|----------------|----------------|------------------|----------------|------|------|------------|---------------|-----|

<sup>1</sup> The compatibility of datetime values and strings is limited to assignment and comparison:

- Datetime values can be assigned to string columns and to string variables.
- A valid string representation of a date can be assigned to a date column or compared with a date.
- A valid string representation of a time can be assigned to a time column or compared with a time.
- A valid string representation of a timestamp can be assigned to a timestamp column or compared with a timestamp.

(Graphic string support is only available for Unicode databases.)

<sup>2</sup> A user-defined distinct type value is only comparable to a value defined with the same user-defined distinct type. In general, assignments are supported between a distinct type value and its source data type. A user-defined structured type is not comparable and can only be assigned to an operand of the same structured type or one of its supertypes. For additional information see “User-defined type assignments” on page 110.

<sup>3</sup> Note that this means that character strings defined with the FOR BIT DATA attribute are also not compatible with binary strings.

<sup>4</sup> A DATALINK operand can only be assigned to another DATALINK operand. The DATALINK value can only be assigned to a column if the column is defined with NO LINK CONTROL, or the file exists and is not already under file link control.

<sup>5</sup> For information on assignment and comparison of reference types, see “Reference type assignments” on page 110 and “Reference type comparisons” on page 115.

<sup>6</sup> Only supported for Unicode databases.

<sup>7</sup> Bit data and graphic strings are not compatible.

### Numeric assignments

The basic rule for numeric assignments is that the whole part of a decimal or integer number is never truncated. If the scale of the target number is less than the scale of the assigned number the excess digits in the fractional part of a decimal number are truncated.

**Decimal or integer to floating-point:** Floating-point numbers are approximations of real numbers. Hence, when a decimal or integer number is assigned to a floating-point column or variable, the result may not be identical to the original number.

**Floating-point or decimal to integer:** When a floating-point or decimal number is assigned to an integer column or variable, the fractional part of the number is lost.

**Decimal to decimal:** When a decimal number is assigned to a decimal column or variable, the number is converted, if necessary, to the precision and the scale of the target. The necessary number of leading zeros is appended or eliminated, and, in the fractional part of the number, the necessary number of trailing zeros is appended, or the necessary number of trailing digits is eliminated.

**Integer to decimal:** When an integer is assigned to a decimal column or variable, the number is converted first to a temporary decimal number and then, if necessary, to the precision and scale of the target. The precision and scale of the temporary decimal number is 5,0 for a small integer, or 11,0 for a large integer, or 19,0 for a big integer.

**Floating-point to decimal:** When a floating-point number is converted to decimal, the number is first converted to a temporary decimal number of precision 31, and



then, if necessary, truncated to the precision and scale of the target. In this conversion, the number is rounded (using floating-point arithmetic) to a precision of 31 decimal digits. As a result, a number less than  $0.5 \times 10^{-31}$  is reduced to 0. The scale is given the largest possible value that allows the whole part of the number to be represented without loss of significance.

## String assignments

There are two types of assignments:

- In *storage assignment*, a value is assigned and truncation of significant data is not desirable; for example, when assigning a value to a column
- In *retrieval assignment*, a value is assigned and truncation is allowed; for example, when retrieving data from the database

The rules for string assignment differ based on the assignment type.

**Storage assignment:** The basic rule is that the length of the string assigned to the target must not be greater than the length attribute of the target. If the length of the string is greater than the length attribute of the target, the following actions might occur:

- The string is assigned with trailing blanks truncated (from all string types except long strings) to fit the length attribute of the target
- An error is returned (SQLSTATE 22001) when:
  - Non-blank characters would be truncated from other than a long string
  - Any character (or byte) would be truncated from a long string

If a string is assigned to a fixed-length target, and the length of the string is less than the length attribute of the target, the string is padded to the right with the necessary number of single-byte, double-byte, or UCS-2 blanks. The pad character is always a blank, even for columns defined with the FOR BIT DATA attribute. (UCS-2 defines several SPACE characters with different properties. For a Unicode database, the database manager always uses the ASCII SPACE at position `x'0020'` as UCS-2 blank. For an EUC database, the IDEOGRAPHIC SPACE at position `x'3000'` is used for padding GRAPHIC strings.)

**Retrieval assignment:** The length of a string that is assigned to a target can be longer than the length attribute of the target. When a string is assigned to a target, and the length of the string is longer than the length attribute of the target, the string is truncated on the right by the necessary number of characters (or bytes). When this occurs, a warning is returned (SQLSTATE 01004), and the value 'W' is assigned to the SQLWARN1 field of the SQLCA.

Furthermore, if an indicator variable is provided, and the source of the value is not a LOB, the indicator variable is set to the original length of the string.

If a character string is assigned to a fixed-length target, and the length of the string is less than the length attribute of the target, the string is padded to the right with the necessary number of single-byte, double-byte, or UCS-2 blanks. The pad character is always a blank, even for strings defined with the FOR BIT DATA attribute. (UCS-2 defines several SPACE characters with different properties. For a Unicode database, the database manager always uses the ASCII SPACE at position `x'0020'` as UCS-2 blank. For an EUC database, the IDEOGRAPHIC SPACE at position `x'3000'` is used for padding GRAPHIC strings.)

Retrieval assignment of C NUL-terminated host variables is handled on the basis of options that are specified with the PREP or BIND command.

## Conversion rules for string assignments

**Conversion rules for string assignments:** A character string or graphic string assigned to a column or host variable is first converted, if necessary, to the code page of the target. Character conversion is necessary only if all of the following are true:

- The code pages are different.
- The string is neither null nor empty.
- Neither string has a code page value of 0 (FOR BIT DATA).

For Unicode databases, character strings can be assigned to a graphic column, and graphic strings can be assigned to a character column.

**MBCS considerations for character string assignments:** There are several considerations when assigning character strings that could contain both single and multi-byte characters. These considerations apply to all character strings, including those defined as FOR BIT DATA.

- Blank padding is always done using the single-byte blank character (X'20').
- Blank truncation is always done based on the single-byte blank character (X'20'). The double-byte blank character is treated like any other character with respect to truncation.
- Assignment of a character string to a host variable may result in fragmentation of MBCS characters if the target host variable is not large enough to contain the entire source string. If an MBCS character is fragmented, each byte of the MBCS character fragment in the target is set to a single-byte blank character (X'20'), no further bytes are moved from the source, and SQLWARN1 is set to 'W' to indicate truncation. Note that the same MBCS character fragment handling applies even when the character string is defined as FOR BIT DATA.

**DBCS considerations for graphic string assignments:** Graphic string assignments are processed in a manner analogous to that for character strings. For non-Unicode databases, graphic string data types are compatible only with other graphic string data types, and never with numeric, character string, or datetime data types. For Unicode databases, graphic string data types are compatible with character string data types. However, graphic and character string data types cannot be used interchangeably in the SELECT INTO or the VALUES INTO statement.

If a graphic string value is assigned to a graphic string column, the length of the value must not be greater than the length of the column.

If a graphic string value (the 'source' string) is assigned to a fixed length graphic string data type (the 'target', which can be a column or host variable), and the length of the source string is less than that of the target, the target will contain a copy of the source string which has been padded on the right with the necessary number of double-byte blank characters to create a value whose length equals that of the target.

If a graphic string value is assigned to a graphic string host variable and the length of the source string is greater than the length of the host variable, the host variable will contain a copy of the source string which has been truncated on the right by the necessary number of double-byte characters to create a value whose length equals that of the host variable. (Note that for this scenario, truncation need not be concerned with bisection of a double-byte character; if bisection were to occur, either the source value or target host variable would be an ill-defined graphic string data type.) The warning flag SQLWARN1 in the SQLCA will be set to 'W'. The indicator variable, if specified, will contain the original length (in double-byte

characters) of the source string. In the case of DBCLOB, however, the indicator variable does not contain the original length.

Retrieval assignment of C NUL-terminated host variables (declared using `wchar_t`) is handled based on options specified with the PREP or BIND command.

### Datetime assignments

The basic rule for datetime assignments is that a DATE, TIME, or TIMESTAMP value can only be assigned to a column with a matching data type (whether DATE, TIME, or TIMESTAMP) or to a fixed- or varying-length string variable or string column. The assignment must not be to a LONG VARCHAR, CLOB, LONG VARGRAPHIC, DBCLOB, or BLOB variable or column.

When a datetime value is assigned to a string variable or string column, conversion to a string representation is automatic. Leading zeros are not omitted from any part of the date, time, or timestamp. The required length of the target will vary, depending on the format of the string representation. If the length of the target is greater than required, and the target is a fixed-length string, it is padded on the right with blanks. If the length of the target is less than required, the result depends on the type of datetime value involved, and on the type of target.

When the target is a host variable, the following rules apply:

- **For a DATE:** If the variable length is less than 10 characters, an error occurs.
- **For a TIME:** If the USA format is used, the length of the variable must not be less than 8 characters; in other formats the length must not be less than 5 characters.

If ISO or JIS formats are used, and if the length of the host variable is less than 8 characters, the seconds part of the time is omitted from the result and assigned to the indicator variable, if provided. The SQLWARN1 field of the SQLCA is set to indicate the omission.

- **For a TIMESTAMP:** If the host variable is less than 19 characters, an error occurs. If the length is less than 26 characters, but greater than or equal to 19 characters, trailing digits of the microseconds part of the value are omitted. The SQLWARN1 field of the SQLCA is set to indicate the omission.

### XML assignments

The general rule for XML assignments is that only an XML value can be assigned to XML columns or to XML variables. There are exceptions to this rule, as follows.

- **Processing of input XML host variables:** This is a special case of the XML assignment rule, because the host variable is based on a string value. To make the assignment to XML within SQL, the string value is implicitly parsed into an XML value using the setting of the CURRENT IMPLICIT XMLPARSE OPTION special register. This determines whether to preserve or to strip whitespace, unless the host variable is an argument of the XMLVALIDATE function, which always strips unnecessary whitespace.
- **Assigning strings to input parameter markers of data type XML:** If an input parameter marker has an implicit or explicit data type of XML, the value bound (assigned) to that parameter marker could be a character string variable, graphic string variable, or binary string variable. In this case, the string value is implicitly parsed into an XML value using the setting of the CURRENT IMPLICIT XMLPARSE OPTION special register to determine whether to preserve or to strip whitespace, unless the parameter marker is an argument of the XMLVALIDATE function, which always strips unnecessary whitespace.

## XML assignments

- **Assigning strings directly to XML columns in data change statements:** If assigning directly to a column of type XML in a data change statement, the assigned expression can also be a character string or a binary string. In this case, the result of XMLPARSE (DOCUMENT *expression* STRIP WHITESPACE) is assigned to the target column. The supported string data types are defined by the supported arguments for the XMLPARSE function. Note that this XML assignment exception does not allow character or binary string values to be assigned to SQL variables or to SQL parameters of data type XML.
- **Assigning XML to strings on retrieval:** If retrieving XML values into host variables using a FETCH INTO statement or an EXECUTE INTO statement in embedded SQL, the data type of the host variable can be CLOB, DBCLOB, or BLOB. If using other application programming interfaces (such as CLI, JDBC, or .NET), XML values can be retrieved into the character, graphic, or binary string types that are supported by the application programming interface. In all of these cases, the XML value is implicitly serialized to a string encoded in UTF-8 and, for character or graphic string variables, converted into the client code page.

Character string or binary string values cannot be retrieved into XML host variables. Values in XML host variables cannot be assigned to columns, SQL variables, or SQL parameters of a character string data type or a binary string data type.

### User-defined type assignments

With user-defined types, different rules are applied for assignments to host variables than are used for all other assignments.

**Distinct Types:** Assignment to host variables is done based on the source type of the distinct type. That is, it follows the rule:

- A value of a distinct type on the right hand side of an assignment is assignable to a host variable on the left hand side if and only if the source type of this distinct type is assignable to this host variable.

If the target of the assignment is a column based on a distinct type, the source data type must be castable to the target data type.

**Structured Types:** Assignment to and from host variables is based on the declared type of the host variable; that is, it follows the rule:

A value of a structured type on the right hand side of an assignment is assignable to a host variable on the left hand side if and only if the declared type of the host variable is the structured type or a supertype of the structured type.

If the target of the assignment is a column of a structured type, the source data type must be the target data type or a subtype of the target data type.

### Reference type assignments

A reference type with a target type of *T* can be assigned to a reference type column that is also a reference type with target type of *S* where *S* is a supertype of *T*. If an assignment is made to a scoped reference column or variable, no check is performed to ensure that the actual value being assigned exists in the target table or view defined by the scope.

Assignment to host variables is done based on the representation type of the reference type. That is, it follows the rule:

- A value of a reference type on the right hand side of an assignment is assignable to a host variable on the left hand side if and only if the representation type of this reference type is assignable to this host variable.

If the target of the assignment is a column, and the right hand side of the assignment is a host variable, the host variable must be explicitly cast to the reference type of the target column.

### Numeric comparisons

Numbers are compared algebraically; that is, with regard to sign. For example,  $-2$  is less than  $+1$ .

If one number is an integer and the other is decimal, the comparison is made with a temporary copy of the integer, which has been converted to decimal.

When decimal numbers with different scales are compared, the comparison is made with a temporary copy of one of the numbers that has been extended with trailing zeros so that its fractional part has the same number of digits as the other number.

If one number is floating-point and the other is integer or decimal, the comparison is made with a temporary copy of the other number, which has been converted to double-precision floating-point.

Two floating-point numbers are equal only if the bit configurations of their normalized forms are identical.

### String comparisons

Character strings are compared according to the collating sequence specified when the database was created, except those with a FOR BIT DATA attribute, which are always compared according to their bit values.

When comparing character strings of unequal lengths, the comparison is made using a logical copy of the shorter string, which is padded on the right with blanks sufficient to extend its length to that of the longer string. This logical extension is done for all character strings, including those tagged as FOR BIT DATA.

Character strings (except character strings tagged as FOR BIT DATA) are compared according to the collating sequence specified when the database was created. For example, the default collating sequence supplied by the database manager may give lowercase and uppercase versions of the same character the same weight. The database manager performs a two-pass comparison to ensure that only identical strings are considered equal to each other. In the first pass, strings are compared according to the database collating sequence. If the weights of the characters in the strings are equal, a second "tie-breaker" pass is performed to compare the strings on the basis of their actual code point values.

Two strings are equal if they are both empty or if all corresponding bytes are equal. If either operand is null, the result is unknown.

Long strings and LOB strings are not supported in any comparison operations that use the basic comparison operators ( $=$ ,  $<>$ ,  $<$ ,  $>$ ,  $<=$ , and  $>=$ ). They are supported in comparisons using the LIKE predicate and the POSSTR function.

## String comparisons

Portions of long strings and LOB strings of up to 4 000 bytes can be compared using the SUBSTR and VARCHAR scalar functions. For example, given the columns:

```
MY_SHORT_CLOB  CLOB(300)
MY_LONG_VAR    LONG VARCHAR
```

then the following is valid:

```
WHERE VARCHAR(MY_SHORT_CLOB) > VARCHAR(SUBSTR(MY_LONG_VAR,1,300))
```

Examples:

For these examples, 'A', 'Á', 'a', and 'á', have the code point values X'41', X'C1', X'61', and X'E1' respectively.

Consider a collating sequence where the characters 'A', 'Á', 'a', 'á' have weights 136, 139, 135, and 138. Then the characters sort in the order of their weights as follows:

```
'a' < 'A' < 'á' < 'Á'
```

Now consider four DBCS characters D1, D2, D3, and D4 with code points 0xC141, 0xC161, 0xE141, and 0xE161, respectively. If these DBCS characters are in CHAR columns, they sort as a sequence of bytes according to the collation weights of those bytes. First bytes have weights of 138 and 139, therefore D3 and D4 come before D2 and D1; second bytes have weights of 135 and 136. Hence, the order is as follows:

```
D4 < D3 < D2 < D1
```

However, if the values being compared have the FOR BIT DATA attribute, or if these DBCS characters were stored in a GRAPHIC column, the collation weights are ignored, and characters are compared according to their code points as follows:

```
'A' < 'a' < 'Á' < 'á'
```

The DBCS characters sort as sequence of bytes, in the order of code points as follows:

```
D1 < D2 < D3 < D4
```

Now consider a collating sequence where the characters 'A', 'Á', 'a', 'á' have (non-unique) weights 74, 75, 74, and 75. Considering collation weights alone (first pass), 'a' is equal to 'A', and 'á' is equal to 'Á'. The code points of the characters are used to break the tie (second pass) as follows:

```
'A' < 'a' < 'Á' < 'á'
```

DBCS characters in CHAR columns sort a sequence of bytes, according to their weights (first pass) and then according to their code points to break the tie (second pass). First bytes have equal weights, so the code points (0xC1 and 0xE1) break the tie. Therefore, characters D1 and D2 sort before characters D3 and D4. Then the second bytes are compared in similar way, and the final result is as follows:

```
D1 < D2 < D3 < D4
```

Once again, if the data in CHAR columns have the FOR BIT DATA attribute, or if the DBCS characters are stored in a GRAPHIC column, the collation weights are ignored, and characters are compared according to their code points:

```
D1 < D2 < D3 < D4
```

For this particular example, the result happens to be the same as when collation weights were used, but obviously this is not always the case.

**Conversion rules for comparison:** When two strings are compared, one of the strings is first converted, if necessary, to the encoding scheme and code page of the other string.

**Ordering of results:** Results that require sorting are ordered based on the string comparison rules discussed in “String comparisons” on page 111. The comparison is performed at the database server. On returning results to the client application, code page conversion may be performed. This subsequent code page conversion does not affect the order of the server-determined result set.

**MBCS considerations for string comparisons:** Mixed SBCS/MBCS character strings are compared according to the collating sequence specified when the database was created. For databases created with default (SYSTEM) collation sequence, all single-byte ASCII characters are sorted in correct order, but double-byte characters are not necessarily in code point sequence. For databases created with IDENTITY sequence, all double-byte characters are correctly sorted in their code point order, but single-byte ASCII characters are sorted in their code point order as well. For databases created with COMPATIBILITY sequence, a compromise order is used that sorts properly for most double-byte characters, and is almost correct for ASCII. This was the default collation table in DB2 Version 2.

Mixed character strings are compared byte-by-byte. This may result in unusual results for multi-byte characters that occur in mixed strings, because each byte is considered independently.

Example:

For this example, 'A', 'B', 'a', and 'b' double-byte characters have the code point values X'8260', X'8261', X'8281', and X'8282', respectively.

Consider a collating sequence where the code points X'8260', X'8261', X'8281', and X'8282' have weights 96, 65, 193, and 194. Then:

'B' < 'A' < 'a' < 'b'

and

'AB' < 'AA' < 'Aa' < 'Ab' < 'aB' < 'aA' < 'aa' < 'ab'

Graphic string comparisons are processed in a manner analogous to that for character strings.

Graphic string comparisons are valid between all graphic string data types except LONG VARGRAPHIC. LONG VARGRAPHIC and DBCLOB data types are not allowed in a comparison operation.

For graphic strings, the collating sequence of the database is not used. Instead, graphic strings are always compared based on the numeric (binary) values of their corresponding bytes.

Using the previous example, if the literals were graphic strings, then:

'A' < 'B' < 'a' < 'b'

and

'AA' < 'AB' < 'Aa' < 'Ab' < 'aA' < 'aB' < 'aa' < 'ab'

## MBCS considerations for string comparisons

When comparing graphic strings of unequal lengths, the comparison is made using a logical copy of the shorter string which is padded on the right with double-byte blank characters sufficient to extend its length to that of the longer string.

Two graphic values are equal if they are both empty or if all corresponding graphics are equal. If either operand is null, the result is unknown. If two values are not equal, their relation is determined by a simple binary string comparison.

As indicated in this section, comparing strings on a byte by byte basis can produce unusual results; that is, a result that differs from what would be expected in a character by character comparison. The examples shown here assume the same MBCS code page, however, the situation can be further complicated when using different multi-byte code pages with the same national language. For example, consider the case of comparing a string from a Japanese DBCS code page and a Japanese EUC code page.

### Datetime comparisons

A DATE, TIME, or TIMESTAMP value may be compared either with another value of the same data type or with a string representation of that data type. All comparisons are chronological, which means the farther a point in time is from January 1, 0001, the greater the value of that point in time.

Comparisons involving TIME values and string representations of time values always include seconds. If the string representation omits seconds, zero seconds is implied.

Comparisons involving TIMESTAMP values are chronological without regard to representations that might be considered equivalent.

Example:

```
TIMESTAMP('1990-02-23-00.00.00') > '1990-02-22-24.00.00'
```

### User-defined type comparisons

Values with a user-defined distinct type can only be compared with values of exactly the same user-defined distinct type. The user-defined distinct type must have been defined using the WITH COMPARISONS clause.

Example:

Given the following YOUTH distinct type and CAMP\_DB2\_ROSTER table:

```
CREATE DISTINCT TYPE YOUTH AS INTEGER WITH COMPARISONS

CREATE TABLE CAMP_DB2_ROSTER
( NAME          VARCHAR(20),
  ATTENDEE_NUMBER INTEGER NOT NULL,
  AGE           YOUTH,
  HIGH_SCHOOL_LEVEL YOUTH)
```

The following comparison is valid:

```
SELECT * FROM CAMP_DB2_ROSTER
WHERE AGE > HIGH_SCHOOL_LEVEL
```

The following comparison is not valid:

```
SELECT * FROM CAMP_DB2_ROSTER
WHERE AGE > ATTENDEE_NUMBER
```



However, AGE can be compared to ATTENDEE\_NUMBER by using a function or CAST specification to cast between the distinct type and the source type. The following comparisons are all valid:

```
SELECT * FROM CAMP_DB2_ROSTER
WHERE INTEGER(AGE) > ATTENDEE_NUMBER
```

```
SELECT * FROM CAMP_DB2_ROSTER
WHERE CAST( AGE AS INTEGER) > ATTENDEE_NUMBER
```

```
SELECT * FROM CAMP_DB2_ROSTER
WHERE AGE > YOUTH(ATTENDEE_NUMBER)
```

```
SELECT * FROM CAMP_DB2_ROSTER
WHERE AGE > CAST(ATTENDEE_NUMBER AS YOUTH)
```

Values with a user-defined structured type cannot be compared with any other value (the NULL predicate and the TYPE predicate can be used).

### Reference type comparisons

Reference type values can be compared only if their target types have a common supertype. The appropriate comparison function will only be found if the schema name of the common supertype is included in the SQL path. The comparison is performed using the representation type of the reference types. The scope of the reference is not considered in the comparison.

#### Related reference:

- “Casting between data types” on page 99
- “Datetime values” on page 88
- “Identifiers” on page 57
- “LIKE predicate” on page 219
- “POSSTR ” on page 379
- “Rules for result data types” on page 116
- “Rules for string conversions” on page 120

## Rules for result data types

The data types of a result are determined by rules which are applied to the operands in an operation. This section explains those rules.

These rules apply to:

- Corresponding columns in fullselects of set operations (UNION, INTERSECT and EXCEPT)
- Result expressions of a CASE expression
- Arguments of the scalar function COALESCE (or VALUE)
- Expression values of the in list of an IN predicate
- Corresponding expressions of a multiple row VALUES clause.

These rules are applied subject to other restrictions on long strings for the various operations.

The rules involving various data types follow. In some cases, a table is used to show the possible result data types.

These tables identify the data type of the result, including the applicable length or precision and scale. The result type is determined by considering the operands. If there is more than one pair of operands, start by considering the first pair. This gives a result type which is considered with the next operand to determine the next result type, and so on. The last intermediate result type and the last operand determine the result type for the operation. Processing of operations is done from left to right so that the intermediate result types are important when operations are repeated. For example, consider a situation involving:

```
CHAR(2) UNION CHAR(4) UNION VARCHAR(3)
```

The first pair results in a type of CHAR(4). The result values always have 4 bytes. The final result type is VARCHAR(4). Values in the result from the first UNION operation will always have a length of 4.

### Character strings

Character strings are compatible with other character strings. Character strings include data types CHAR, VARCHAR, LONG VARCHAR, and CLOB.

| If one operand is... | And the other operand is...          | The data type of the result is... |
|----------------------|--------------------------------------|-----------------------------------|
| CHAR(x)              | CHAR(y)                              | CHAR(z) where $z = \max(x,y)$     |
| CHAR(x)              | VARCHAR(y)                           | VARCHAR(z) where $z = \max(x,y)$  |
| VARCHAR(x)           | CHAR(y) or VARCHAR(y)                | VARCHAR(z) where $z = \max(x,y)$  |
| LONG VARCHAR         | CHAR(y), VARCHAR(y), or LONG VARCHAR | LONG VARCHAR                      |
| CLOB(x)              | CHAR(y), VARCHAR(y), or CLOB(y)      | CLOB(z) where $z = \max(x,y)$     |
| CLOB(x)              | LONG VARCHAR                         | CLOB(z) where $z = \max(x,32700)$ |

The code page of the result character string will be derived based on the rules for string conversions.

## Graphic strings

Graphic strings are compatible with other graphic strings. Graphic strings include data types GRAPHIC, VARGRAPHIC, LONG VARGRAPHIC, and DBCLOB.

| If one operand is... | And the other operand is...                   | The data type of the result is...   |
|----------------------|---|-------------------------------------|
| GRAPHIC(x)           | GRAPHIC(y)                                    | GRAPHIC(z) where $z = \max(x,y)$    |
| VARGRAPHIC(x)        | GRAPHIC(y) OR VARGRAPHIC(y)                   | VARGRAPHIC(z) where $z = \max(x,y)$ |
| LONG VARGRAPHIC      | GRAPHIC(y), VARGRAPHIC(y), or LONG VARGRAPHIC | LONG VARGRAPHIC                     |
| DBCLOB(x)            | GRAPHIC(y), VARGRAPHIC(y), or DBCLOB(y)       | DBCLOB(z) where $z = \max(x,y)$     |
| DBCLOB(x)            | LONG VARGRAPHIC                               | DBCLOB(z) where $z = \max(x,16350)$ |

The code page of the result graphic string will be derived based on the rules for string conversions.

## Character and graphic strings in a Unicode database

In a Unicode database, character strings and graphic strings are compatible.

| If one operand is... | And the other operand is...           | The data type of the result is...   |
|----------------------|---------------------------------------|-------------------------------------|
| GRAPHIC(x)           | CHAR(y) or GRAPHIC(y)                 | GRAPHIC(z) where $z = \max(x,y)$    |
| VARGRAPHIC(x)        | CHAR(y) or VARCHAR(y)                 | VARGRAPHIC(z) where $z = \max(x,y)$ |
| VARCHAR(x)           | GRAPHIC(y) or VARGRAPHIC              | VARGRAPHIC(z) where $z = \max(x,y)$ |
| LONG VARGRAPHIC      | CHAR(y) or VARCHAR(y) or LONG VARCHAR | LONG VARGRAPHIC                     |
| LONG VARCHAR         | GRAPHIC(y) or VARGRAPHIC(y)           | LONG VARGRAPHIC                     |
| DBCLOB(x)            | CHAR(y) or VARCHAR(y) or CLOB(y)      | DBCLOB(z) where $z = \max(x,y)$     |
| DBCLOB(x)            | LONG VARCHAR                          | DBCLOB(z) where $z = \max(x,16350)$ |
| CLOB(x)              | GRAPHIC(y) or VARGRAPHIC(y)           | DBCLOB(z) where $z = \max(x,y)$     |
| CLOB(x)              | LONG VARGRAPHIC                       | DBCLOB(z) where $z = \max(x,16350)$ |

## Binary large object (BLOB)

A BLOB is compatible only with another BLOB and the result is a BLOB. The BLOB scalar function can be used to cast from other types if they should be treated as BLOB types. The length of the result BLOB is the largest length of all the data types.

## Rules for result data types

### Numeric

Numeric types are compatible with other numeric types. Numeric types include SMALLINT, INTEGER, BIGINT, DECIMAL, REAL and DOUBLE.

| If one operand is... | And the other operand is...              | The data type of the result is...   |
|----------------------|--|---|
| SMALLINT             | SMALLINT                                 | SMALLINT  |
| INTEGER              | INTEGER                                  | INTEGER   |
| INTEGER              | SMALLINT                                 | INTEGER   |
| BIGINT               | BIGINT                                   | BIGINT  |
| BIGINT               | INTEGER                                  | BIGINT  |
| BIGINT               | SMALLINT                                 | BIGINT  |
| DECIMAL(w,x)         | SMALLINT                                 | DECIMAL(p,x) where<br>$p = x + \max(w-x, 5)^1$                              |
| DECIMAL(w,x)         | INTEGER                                  | DECIMAL(p,x) where<br>$p = x + \max(w-x, 11)^1$                             |
| DECIMAL(w,x)         | BIGINT                                   | DECIMAL(p,x) where<br>$p = x + \max(w-x, 19)^1$                             |
| DECIMAL(w,x)         | DECIMAL(y,z)                             | DECIMAL(p,s) where<br>$p = \max(x,z) + \max(w-x, y-z)^1$<br>$s = \max(x,z)$ |
| REAL                 | REAL                                     | REAL  |
| REAL                 | DECIMAL, BIGINT,<br>INTEGER, or SMALLINT | DOUBLE  |
| DOUBLE               | any numeric                              | DOUBLE  |

<sup>1</sup> Precision cannot exceed 31.

### DATE

A date is compatible with another date, or any CHAR or VARCHAR expression that contains a valid string representation of a date. The data type of the result is DATE.

### TIME

A time is compatible with another time, or any CHAR or VARCHAR expression that contains a valid string representation of a time. The data type of the result is TIME.

### TIMESTAMP

A timestamp is compatible with another timestamp, or any CHAR or VARCHAR expression that contains a valid string representation of a timestamp. The data type of the result is TIMESTAMP.

### XML

An XML operand is compatible with another XML operand. The data type of the result is XML.

### User-defined types

**Distinct types:** A user-defined distinct type is compatible only with the same user-defined distinct type. The data type of the result is the user-defined distinct type.

**Reference types:** A reference type is compatible with another reference type provided that their target types have a common supertype. The data type of the result is a reference type having the common supertype as the target type. If all operands have the identical scope table, the result has that scope table. Otherwise the result is unscoped.

**Structured types:** A structured type is compatible with another structured type provided that they have a common supertype. The static data type of the resulting structured type column is the structured type that is the least common supertype of either column.

For example, consider the following structured type hierarchy,



Structured types of the static type E and F are compatible with the resulting static type of B, which is the least common super type of E and F.

### Nullable attribute of result

With the exception of INTERSECT and EXCEPT, the result allows nulls unless both operands do not allow nulls.

- For INTERSECT, if either operand does not allow nulls the result does not allow nulls (the intersection would never be null).
- For EXCEPT, if the first operand does not allow nulls the result does not allow nulls (the result can only be values from the first operand).

### Related reference:

- “BLOB ” on page 289
- “Rules for string conversions” on page 120

### Rules for string conversions

The code page used to perform an operation is determined by rules which are applied to the operands in that operation. This section explains those rules.

These rules apply to:

- Corresponding string columns in fullselects with set operations (UNION, INTERSECT and EXCEPT)
- Operands of concatenation
- Operands of predicates (with the exception of LIKE)
- Result expressions of a CASE expression
- Arguments of the scalar function COALESCE (and VALUE)
- Expression values of the in list of an IN predicate
- Corresponding expressions of a multiple row VALUES clause.

In each case, the code page of the result is determined at bind time, and the execution of the operation may involve conversion of strings to the code page identified by that code page. A character that has no valid conversion is mapped to the substitution character for the character set and SQLWARN10 is set to 'W' in the SQLCA.

The code page of the result is determined by the code pages of the operands. The code pages of the first two operands determine an intermediate result code page, this code page and the code page of the next operand determine a new intermediate result code page (if applicable), and so on. The last intermediate result code page and the code page of the last operand determine the code page of the result string or column. For each pair of code pages, the result is determined by the sequential application of the following rules:

- If the code pages are equal, the result is that code page.
- If either code page is BIT DATA (code page 0), the result code page is BIT DATA.
- In a Unicode database, if one code page denotes data in an encoding scheme that is different from the other code page, the result is UCS-2 over UTF-8 (that is, the graphic data type over the character data type). (In a non-Unicode database, conversion between different encoding schemes is not supported.)
- For operands that are host variables (whose code page is not BIT DATA), the result code page is the database code page. Input data from such host variables is converted from the application code page to the database code page before being used.

Conversions to the code page of the result are performed, if necessary, for:

- An operand of the concatenation operator
- The selected argument of the COALESCE (or VALUE) scalar function
- The selected result expression of the CASE expression
- The expressions of the in list of the IN predicate
- The corresponding expressions of a multiple row VALUES clause
- The corresponding columns involved in set operations.

Character conversion is necessary if all of the following are true:

- The code pages are different
- Neither string is BIT DATA

- The string is neither null nor empty

### Examples

*Example 1:* Given the following in a database created with code page 850:

| Expression | Type          | Code Page |
|------------|---------------|-----------|
| COL_1      | column        | 850       |
| HV_2       | host variable | 437       |

When evaluating the predicate:

```
COL_1 CONCAT :HV_2
```

the result code page of the two operands is 850, because the host variable data will be converted to the database code page before being used.

*Example 2:* Using information from the previous example when evaluating the predicate:

```
COALESCE(COL_1, :HV_2:NULLIND,)
```

the result code page is 850; therefore, the result code page for the COALESCE scalar function will be code page 850.

## Database partition-compatible data types

*Database partition compatibility* is defined between the base data types of corresponding columns of distribution keys. Database partition-compatible data types have the property that two variables, one of each type, with the same value, are mapped to the same distribution map index by the same database partitioning function.

Table 10 shows the compatibility of data types in database partitions.

Database partition compatibility has the following characteristics:

- Internal formats are used for DATE, TIME, and TIMESTAMP. They are not compatible with each other, and none are compatible with CHAR.
- Database partition compatibility is not affected by columns with NOT NULL or FOR BIT DATA definitions.
- NULL values of compatible data types are treated identically. Different results might be produced for NULL values of non-compatible data types.
- Base data type of the UDT is used to analyze database partition compatibility.
- Decimals of the same value in the distribution key are treated identically, even if their scale and precision differ.
- Trailing blanks in character strings (CHAR, VARCHAR, GRAPHIC or VARGRAPHIC) are ignored by the system-provided hashing function.
- CHAR or VARCHAR of different lengths are compatible data types.
- REAL or DOUBLE values that are equal are treated identically even though their precision differs.

Table 10. Database Partition Compatibilities

| Operands                      | Binary Integer | Decimal Number | Floating Point | Character String | Graphic String | Date         | Time         | Time-stamp   | Distinct Type | Structured Type |
|-------------------------------|----------------|----------------|----------------|------------------|----------------|--------------|--------------|--------------|---------------|-----------------|
| Binary Integer                | Yes            | No             | No             | No               | No             | No           | No           | No           | <sup>1</sup>  | No              |
| Decimal Number                | No             | Yes            | No             | No               | No             | No           | No           | No           | <sup>1</sup>  | No              |
| Floating Point                | No             | No             | Yes            | No               | No             | No           | No           | No           | <sup>1</sup>  | No              |
| Character String <sup>3</sup> | No             | No             | No             | Yes <sup>2</sup> | No             | No           | No           | No           | <sup>1</sup>  | No              |
| Graphic String <sup>3</sup>   | No             | No             | No             | No               | Yes            | No           | No           | No           | <sup>1</sup>  | No              |
| Date                          | No             | No             | No             | No               | No             | Yes          | No           | No           | <sup>1</sup>  | No              |
| Time                          | No             | No             | No             | No               | No             | No           | Yes          | No           | <sup>1</sup>  | No              |
| Timestamp                     | No             | No             | No             | No               | No             | No           | No           | Yes          | <sup>1</sup>  | No              |
| Distinct Type                 | <sup>1</sup>   | <sup>1</sup>   | <sup>1</sup>   | <sup>1</sup>     | <sup>1</sup>   | <sup>1</sup> | <sup>1</sup> | <sup>1</sup> | <sup>1</sup>  | No              |
| Structured Type <sup>3</sup>  | No             | No             | No             | No               | No             | No           | No           | No           | No            | No              |



Table 10. Database Partition Compatibilities (continued)

| Operands     | Binary Integer   | Decimal Number | Floating Point | Character String | Graphic String | Date | Time | Time-stamp | Distinct Type | Structured Type |
|--------------|--|----------------|----------------|------------------|----------------|------|------|------------|---------------|-----------------|
| <b>Note:</b> |  |                |                |                  |                |      |      |            |               |                 |
| <sup>1</sup> | A user-defined distinct type (UDT) value is database partition compatible with the source type of the UDT or any other UDT with a database partition compatible source type.   |                |                |                  |                |      |      |            |               |                 |
| <sup>2</sup> | The FOR BIT DATA attribute does not affect the database partition compatibility.   |                |                |                  |                |      |      |            |               |                 |
| <sup>3</sup> | Note that user-defined structured types and data types LONG VARCHAR, LONG VARGRAPHIC, CLOB, DBCLOB, and BLOB are not applicable for database partition compatibility, because they are not supported in distribution keys. |                |                |                  |                |      |      |            |               |                 |

## Constants

A *constant* (sometimes called a *literal*) specifies a value. Constants are classified as string constants or numeric constants. Numeric constants are further classified as integer, floating-point, or decimal.

All constants have the NOT NULL attribute.

A negative zero value in a numeric constant (-0) is the same value as a zero without the sign (0).

User-defined types have strong typing. This means that a user-defined type is only compatible with its own type. A constant, however, has a built-in type. Therefore, an operation involving a user-defined type and a constant is only possible if the user-defined type has been cast to the constant's built-in type, or if the constant has been cast to the user-defined type. For example, using the table and distinct type in "User-defined type comparisons" on page 114, the following comparisons with the constant 14 are valid:

```
SELECT * FROM CAMP_DB2_ROSTER
  WHERE AGE > CAST(14 AS YOUTH)

SELECT * FROM CAMP_DB2_ROSTER
  WHERE CAST(AGE AS INTEGER) > 14
```

The following comparison is not valid:

```
SELECT * FROM CAMP_DB2_ROSTER
  WHERE AGE > 14
```

## Integer constants

An *integer constant* specifies an integer as a signed or unsigned number with a maximum of 19 digits that does not include a decimal point. The data type of an integer constant is large integer if its value is within the range of a large integer. The data type of an integer constant is big integer if its value is outside the range of large integer but within the range of a big integer. A constant that is defined outside the range of big integer values is considered a decimal constant.

Note that the smallest literal representation of a large integer constant is -2 147 483 647, and not -2 147 483 648, which is the limit for integer values. Similarly, the smallest literal representation of a big integer constant is -9 223 372 036 854 775 807, and not -9 223 372 036 854 775 808, which is the limit for big integer values.

Examples:

```
64      -15      +100      32767      720176      12345678901
```

In syntax diagrams, the term 'integer' is used for a large integer constant that must not include a sign.

## Floating-point constants

A *floating-point constant* specifies a floating-point number as two numbers separated by an E. The first number may include a sign and a decimal point; the second number may include a sign but not a decimal point. The data type of a floating-point constant is double-precision. The value of the constant is the product

of the first number and the power of 10 specified by the second number; it must be within the range of floating-point numbers. The number of bytes in the constant must not exceed 30.

*Examples:*

15E1    2.E5    2.2E-1    +5.E+2

## Decimal constants

A *decimal constant* is a signed or unsigned number that consists of no more than 31 digits and either includes a decimal point or is not within the range of binary integers. It must be within the range of decimal numbers. The precision is the total number of digits (including leading and trailing zeros); the scale is the number of digits to the right of the decimal point (including trailing zeros).

*Examples:*

25.5    1000.    -15.    +37589.3333333333

## Character string constants

A *character string constant* specifies a varying-length character string, and consists of a sequence of characters that starts and ends with an apostrophe ('). This form of string constant specifies the character string contained between the string delimiters. The length of the character string must not be greater than 32 672 bytes. Two consecutive string delimiters are used to represent one string delimiter within the character string.

*Examples:*

'12/14/1985'  
'32'  
'DON''T CHANGE'

The constant value is always converted to the database code page when it is bound to the database. It is considered to be in the database code page. Therefore, if used in an expression that combines a constant with a FOR BIT DATA column, and whose result is FOR BIT DATA, the constant value will *not* be converted from its database code page representation when used.

## Hexadecimal constants

A *hexadecimal constant* specifies a varying-length character string in the section code page.

The format of a hexadecimal constant is an X followed by a sequence of characters that starts and ends with an apostrophe ('). The characters between the apostrophes must be an even number of hexadecimal digits. The number of hexadecimal digits must not exceed 16 336, otherwise an error is raised (SQLSTATE -54002). A hexadecimal digit represents 4 bits. It is specified as a digit or any of the letters A through F (uppercase or lowercase), where A represents the bit pattern '1010', B represents '1011', and so on. If a hexadecimal constant is improperly formatted (for example, if it contains an invalid hexadecimal digit or an odd number of hexadecimal digits), an error is raised (SQLSTATE 42606).

*Examples:*

X'FFFF'            representing the bit pattern '1111111111111111'

X'4672616E6B' representing the VARCHAR pattern of the ASCII string 'Frank'

### Graphic string constants

A *graphic string constant* specifies a varying-length graphic string consisting of a sequence of double-byte characters that starts and ends with a single-byte apostrophe ('), and that is preceded by a single-byte G or N. The characters between the apostrophes must represent an even number of bytes, and the length of the graphic string must not exceed 16 336 bytes.

*Examples:*

```
G'double-byte character string'  
N'double-byte character string'
```

The apostrophe must not appear as part of an MBCS character to be considered a delimiter.

In a Unicode database, a hexadecimal graphic string constant that specifies a varying-length graphic string is also supported. The format of a hexadecimal graphic string constant is: GX followed by a sequence of characters that starts and ends with an apostrophe. The characters between the apostrophes must be an even multiple of four hexadecimal digits. The number of hexadecimal digits must not exceed 16 336; otherwise, an error is returned (SQLSTATE -54002). If a hexadecimal graphic string constant is improperly formed, an error is returned (SQLSTATE 42606). Each group of four digits represents a single graphic character. In a Unicode database, this would be a single UCS-2 graphic character.

*Examples:*

```
GX'FFFF'
```

represents the bit pattern '1111111111111111' in a Unicode database.

```
GX'005200690063006B'
```

represents the VARGRAPHIC pattern of the ASCII string 'Rick' in a Unicode database.

### UCS-2 graphic string constants

In a Unicode database, a hexadecimal UCS-2 graphic string that specifies a varying-length UCS-2 graphic string constant is supported. The format of a hexadecimal UCS-2 graphic string constant is: UX followed by a sequence of characters that starts and ends with an apostrophe. The characters between the apostrophes must be an even multiple of four hexadecimal digits. The number of hexadecimal digits must not exceed 16 336; otherwise, an error is returned (SQLSTATE -54002). If a hexadecimal UCS-2 graphic string constant is improperly formed, an error is returned (SQLSTATE 42606). Each group of four digits represents a single UCS-2 graphic character.

*Example:*

```
UX'0042006F006200620079'
```

represents the VARGRAPHIC pattern of the ASCII string 'Bobby'.

#### Related reference:

- "Assignments and comparisons" on page 105
- "Expressions" on page 173

## Special registers

### Special registers

A *special register* is a storage area that is defined for an application process by the database manager. It is used to store information that can be referenced in SQL statements. A reference to a special register is a reference to a value provided by the current server. If the value is a string, its CCSID is a default CCSID of the current server. The special registers can be referenced as follows:

|   |     |
|---|-----|
| CURRENT CLIENT_ACCTNG                           |     |
| CLIENT ACCTNG                                   |     |
| CURRENT CLIENT_APPLNAME                         |     |
| CLIENT APPLNAME                                 |     |
| CURRENT CLIENT_USERID                           |     |
| CLIENT USERID                                   |     |
| CURRENT CLIENT_WRKSTNNAME                       |     |
| CLIENT WRKSTNNAME                               |     |
| CURRENT DATE                                    |     |
| CURRENT_DATE                                    | (1) |
| CURRENT DBPARTITIONNUM                          |     |
| CURRENT DEFAULT TRANSFORM GROUP                 |     |
| CURRENT DEGREE                                  |     |
| CURRENT EXPLAIN MODE                            |     |
| CURRENT EXPLAIN SNAPSHOT                        |     |
| CURRENT FEDERATED ASYNCHRONY                    |     |
| CURRENT IMPLICIT XMLPARSE OPTION                |     |
| CURRENT ISOLATION                               |     |
| CURRENT LOCK TIMEOUT                            |     |
| CURRENT MAINTAINED TABLE TYPES FOR OPTIMIZATION |     |
| CURRENT PACKAGE PATH                            |     |
| CURRENT PATH                                    |     |
| CURRENT_PATH                                    | (1) |
| CURRENT QUERY OPTIMIZATION                      |     |
| CURRENT REFRESH AGE                             |     |
| CURRENT SCHEMA                                  |     |
| CURRENT_SCHEMA                                  | (1) |
| CURRENT SERVER                                  |     |
| CURRENT_SERVER                                  | (1) |
| CURRENT TIME                                    |     |
| CURRENT_TIME                                    | (1) |
| CURRENT TIMESTAMP                               |     |
| CURRENT_TIMESTAMP                               | (1) |
| CURRENT TIMEZONE                                |     |
| CURRENT_TIMEZONE                                | (1) |
| CURRENT USER                                    |     |
| CURRENT_USER                                    | (1) |
| SESSION_USER                                    |     |
| USER  |     |
| SYSTEM_USER                                     |     |

## Special registers

### Notes:

- 1 The SQL 1999 Core standard uses the form with the underscore.

Some special registers can be updated using the SET statement. The following table shows which of the special registers can be updated.

*Table 11. Special Registers*

| <b>Special Register</b>                         | <b>Updatable</b> |
|---|------------------|
| CURRENT CLIENT_ACCTNG                           | No               |
| CURRENT CLIENT_APPLNAME                         | No               |
| CURRENT CLIENT_USERID                           | No               |
| CURRENT CLIENT_WRKSTNNAME                       | No               |
| CURRENT DATE                                    | No               |
| CURRENT DBPARTITIONNUM                          | No               |
| CURRENT DEFAULT TRANSFORM GROUP                 | Yes              |
| CURRENT DEGREE                                  | Yes              |
| CURRENT EXPLAIN MODE                            | Yes              |
| CURRENT EXPLAIN SNAPSHOT                        | Yes              |
| CURRENT FEDERATED ASYNCHRONY                    | Yes              |
| CURRENT IMPLICIT XMLPARSE OPTION                | Yes              |
| CURRENT ISOLATION                               | Yes              |
| CURRENT LOCK TIMEOUT                            | Yes              |
| CURRENT MAINTAINED TABLE TYPES FOR OPTIMIZATION | Yes              |
| CURRENT PACKAGE PATH                            | Yes              |
| CURRENT PATH                                    | Yes              |
| CURRENT QUERY OPTIMIZATION                      | Yes              |
| CURRENT REFRESH AGE                             | Yes              |
| CURRENT SCHEMA                                  | Yes              |
| CURRENT SERVER                                  | No               |
| CURRENT TIME                                    | No               |
| CURRENT TIMESTAMP                               | No               |
| CURRENT TIMEZONE                                | No               |
| CURRENT USER                                    | No               |
| SESSION_USER                                    | Yes              |
| SYSTEM_USER                                     | No               |
| USER  | Yes              |

When a special register is referenced in a routine, the value of the special register in the routine depends on whether the special register is updatable or not. For non-updatable special registers, the value is set to the default value for the special register. For updatable special registers, the initial value is inherited from the invoker of the routine and can be changed with a subsequent SET statement inside the routine.

## CURRENT CLIENT\_ACCTNG

The CURRENT CLIENT\_ACCTNG (or CLIENT ACCTNG) special register contains the value of the accounting string from the client information specified for this connection. The data type of the register is VARCHAR(255). The default value of this register is an empty string.

The value of the accounting string can be changed by using the Set Client Information (**sqlseti**) API.

Note that the value provided via the sqlseti API is in the application code page, and the special register value is stored in the database code page. Depending on the data values used when setting the client information, truncation of the data value stored in the special register may occur during code page conversion.

*Example:* Get the current value of the accounting string for this connection.

```
VALUES (CURRENT CLIENT_ACCTNG)  
INTO :ACCT_STRING
```

### CURRENT CLIENT\_APPLNAME

The CURRENT CLIENT\_APPLNAME (or CLIENT APPLNAME) special register contains the value of the application name from the client information specified for this connection. The data type of the register is VARCHAR(255). The default value of this register is an empty string.

The value of the application name can be changed by using the Set Client Information (**sqleseti**) API.

Note that the value provided via the sqleseti API is in the application code page, and the special register value is stored in the database code page. Depending on the data values used when setting the client information, truncation of the data value stored in the special register may occur during code page conversion.

*Example:* Select which departments are allowed to use the application being used in this connection.

```
SELECT DEPT
FROM DEPT_APPL_MAP
WHERE APPL_NAME = CURRENT CLIENT_APPLNAME
```



## CURRENT\_CLIENT\_USERID

The CURRENT\_CLIENT\_USERID (or CLIENT\_USERID) special register contains the value of the client user ID from the client information specified for this connection. The data type of the register is VARCHAR(255). The default value of this register is an empty string.

The value of the client user ID can be changed by using the Set Client Information (**sqlseti**) API.

Note that the value provided via the sqlseti API is in the application code page, and the special register value is stored in the database code page. Depending on the data values used when setting the client information, truncation of the data value stored in the special register may occur during code page conversion.

*Example:* Find out in which department the current client user ID works.

```
SELECT DEPT
FROM DEPT_USERID_MAP
WHERE USER_ID = CURRENT_CLIENT_USERID
```

### CURRENT CLIENT\_WRKSTNNAME

The CURRENT CLIENT\_WRKSTNNAME (or CLIENT\_WRKSTNNAME) special register contains the value of the workstation name from the client information specified for this connection. The data type of the register is VARCHAR(255). The default value of this register is an empty string.

The value of the workstation name can be changed by using the Set Client Information (**sqlseti**) API.

Note that the value provided via the sqlseti API is in the application code page, and the special register value is stored in the database code page. Depending on the data values used when setting the client information, truncation of the data value stored in the special register may occur during code page conversion.

*Example:* Get the workstation name being used for this connection.

```
VALUES (CURRENT_CLIENT_WRKSTNNAME)
INTO :WS_NAME
```

## CURRENT DATE

The CURRENT DATE (or CURRENT\_DATE) special register specifies a date that is based on a reading of the time-of-day clock when the SQL statement is executed at the application server. If this special register is used more than once within a single SQL statement, or used with CURRENT TIME or CURRENT TIMESTAMP within a single statement, all values are based on a single clock reading.

When used in an SQL statement inside a routine, CURRENT DATE is not inherited from the invoking statement.

In a federated system, CURRENT DATE can be used in a query intended for data sources. When the query is processed, the date returned will be obtained from the CURRENT DATE register at the federated server, not from the data sources.

*Example:* Using the PROJECT table, set the project end date (PRENDATE) of the MA2111 project (PROJNO) to the current date.

```
UPDATE PROJECT
SET PRENDATE = CURRENT DATE
WHERE PROJNO = 'MA2111'
```

### CURRENT DBPARTITIONNUM

The CURRENT DBPARTITIONNUM special register specifies an INTEGER value that identifies the coordinator node number for the statement. For statements issued from an application, the coordinator is the database partition to which the application connects. For statements issued from a routine, the coordinator is the database partition from which the routine is invoked.

When used in an SQL statement inside a routine, CURRENT DBPARTITIONNUM is never inherited from the invoking statement.

CURRENT DBPARTITIONNUM returns 0 if the database instance is not defined to support database partitioning. (In other words, if there is no db2nodes.cfg file. For partitioned databases, the db2nodes.cfg file exists and contains database partition definitions.)

CURRENT DBPARTITIONNUM can be changed through the CONNECT statement, but only under certain conditions.

For compatibility with versions earlier than Version 8, the keyword NODE can be substituted for DBPARTITIONNUM.

*Example:* Set the host variable APPL\_NODE (integer) to the number of the database partition to which the application is connected.

```
VALUES CURRENT DBPARTITIONNUM  
INTO :APPL_NODE
```

**Related reference:**

- “CONNECT (Type 1) statement” in *SQL Reference, Volume 2*

## CURRENT DEFAULT TRANSFORM GROUP

The CURRENT DEFAULT TRANSFORM GROUP special register specifies a VARCHAR(18) value that identifies the name of the transform group used by dynamic SQL statements for exchanging user-defined structured type values with host programs. This special register does not specify the transform groups used in static SQL statements, or in the exchange of parameters and results with external functions or methods.

Its value can be set by the SET CURRENT DEFAULT TRANSFORM GROUP statement. If no value is set, the initial value of the special register is the empty string (a VARCHAR with a length of zero).

In a dynamic SQL statement (that is, one which interacts with host variables), the name of the transform group used for exchanging values is the same as the value of this special register, unless this register contains the empty string. If the register contains the empty string (no value was set by using the SET CURRENT DEFAULT TRANSFORM GROUP statement), the DB2\_PROGRAM transform group is used for the transform. If the DB2\_PROGRAM transform group is not defined for the structured type subject, an error is raised at run time (SQLSTATE 42741).

*Examples:*

Set the default transform group to MYSTRUCT1. The TO SQL and FROM SQL functions defined in the MYSTRUCT1 transform are used to exchange user-defined structured type variables with the host program.

```
SET CURRENT DEFAULT TRANSFORM GROUP = MYSTRUCT1
```

Retrieve the name of the default transform group assigned to this special register.

```
VALUES (CURRENT DEFAULT TRANSFORM GROUP)
```

### CURRENT DEGREE

The CURRENT DEGREE special register specifies the degree of intra-partition parallelism for the execution of dynamic SQL statements. (For static SQL, the DEGREE bind option provides the same control.) The data type of the register is CHAR(5). Valid values are ANY or the string representation of an integer between 1 and 32 767, inclusive.

If the value of CURRENT DEGREE represented as an integer is 1 when an SQL statement is dynamically prepared, the execution of that statement will not use intra-partition parallelism.

If the value of CURRENT DEGREE represented as an integer is greater than 1 and less than or equal to 32 767 when an SQL statement is dynamically prepared, the execution of that statement can involve intra-partition parallelism with the specified degree.

If the value of CURRENT DEGREE is ANY when an SQL statement is dynamically prepared, the execution of that statement can involve intra-partition parallelism using a degree determined by the database manager.

The actual runtime degree of parallelism will be the lower of:

- The value of the maximum query degree (*max\_querydegree*) configuration parameter
- The application runtime degree
- The SQL statement compilation degree.

If the *intra\_parallel* database manager configuration parameter is set to NO, the value of the CURRENT DEGREE special register will be ignored for the purpose of optimization, and the statement will not use intra-partition parallelism.

The value can be changed by invoking the SET CURRENT DEGREE statement.

The initial value of CURRENT DEGREE is determined by the *dft\_degree* database configuration parameter.

**Related reference:**

- “SET CURRENT DEGREE statement” in *SQL Reference, Volume 2*

## CURRENT EXPLAIN MODE

The CURRENT EXPLAIN MODE special register holds a VARCHAR(254) value which controls the behavior of the Explain facility with respect to eligible dynamic SQL statements. This facility generates and inserts Explain information into the Explain tables. This information does not include the Explain snapshot. Possible values are YES, EXPLAIN, NO, REOPT, RECOMMEND INDEXES, and EVALUATE INDEXES. (For static SQL, the EXPLAIN bind option provides the same control. In the case of the PREP and BIND commands, the EXPLAIN option values are: YES, NO, and ALL.)

**YES** Enables the Explain facility and causes Explain information for a dynamic SQL statement to be captured when the statement is compiled.

### EXPLAIN

Enables the facility, but dynamic statements are not executed.

**NO** Disables the Explain facility.

### REOPT

Enables the Explain facility and causes Explain information for a dynamic (or incremental-bind) SQL statement to be captured only when the statement is reoptimized using real values for the input variables (host variables, special registers, or parameter markers).

### RECOMMEND INDEXES

Recommends a set of indexes for each dynamic query. Populates the ADVISE\_INDEX table with the set of indexes.

### EVALUATE INDEXES

Explains dynamic queries as though the recommended indexes existed. The indexes are picked up from the ADVISE\_INDEX table.

The initial value is NO. The value can be changed by invoking the SET CURRENT EXPLAIN MODE statement.

The CURRENT EXPLAIN MODE and CURRENT EXPLAIN SNAPSHOT special register values interact when the Explain facility is invoked. The CURRENT EXPLAIN MODE special register also interacts with the EXPLAIN bind option. RECOMMEND INDEXES and EVALUATE INDEXES can only be set for the CURRENT EXPLAIN MODE register, and must be set using the SET CURRENT EXPLAIN MODE statement.

*Example:* Set the host variable EXPL\_MODE (VARCHAR(254)) to the value currently in the CURRENT EXPLAIN MODE special register.

```
VALUES CURRENT EXPLAIN MODE
INTO :EXPL_MODE
```

### Related reference:

- Appendix J, “Explain register values,” on page 821
- “SET CURRENT EXPLAIN MODE statement” in *SQL Reference, Volume 2*

### CURRENT EXPLAIN SNAPSHOT

The CURRENT EXPLAIN SNAPSHOT special register holds a CHAR(8) value that controls the behavior of the Explain snapshot facility. This facility generates compressed information, including access plan information, operator costs, and bind-time statistics.

Only the following statements consider the value of this register: DELETE, INSERT, SELECT, SELECT INTO, UPDATE, VALUES, or VALUES INTO. Possible values are YES, EXPLAIN, NO, and REOPT. (For static SQL, the EXPLSNAP bind option provides the same control. In the case of the PREP and BIND commands, the EXPLSNAP option values are: YES, NO, and ALL.)

**YES** Enables the Explain snapshot facility and takes a snapshot of the internal representation of a dynamic SQL statement as the statement is compiled.

**EXPLAIN**

Enables the Explain snapshot facility, but dynamic statements are not executed.

**NO** Disables the Explain snapshot facility.

**REOPT**

Enables the Explain facility and causes Explain information for a dynamic (or incremental-bind) SQL statement to be captured only when the statement is reoptimized using real values for the input variables (host variables, special registers, or parameter markers).

The initial value is NO. The value can be changed by invoking the SET CURRENT EXPLAIN SNAPSHOT statement.

The CURRENT EXPLAIN SNAPSHOT and CURRENT EXPLAIN MODE special register values interact when the Explain facility is invoked. The CURRENT EXPLAIN SNAPSHOT special register also interacts with the EXPLSNAP bind option.

*Example:* Set the host variable EXPL\_SNAP (char(8)) to the value currently in the CURRENT EXPLAIN SNAPSHOT special register.

```
VALUES CURRENT EXPLAIN SNAPSHOT
INTO :EXPL_SNAP
```

**Related reference:**

- Appendix J, “Explain register values,” on page 821
- “SET CURRENT EXPLAIN SNAPSHOT statement” in *SQL Reference, Volume 2*



## CURRENT FEDERATED ASYNCHRONY

The CURRENT FEDERATED ASYNCHRONY special register specifies the degree of asynchrony for the execution of dynamic SQL statements. (The FEDERATED\_ASYNCHRONY bind option provides the same control for static SQL.) The data type of the register is INTEGER. Valid values are ANY (representing -1) or an integer between 0 and the value of the *maxagents* database manager configuration parameter divided by 4, inclusive. If, when an SQL statement is dynamically prepared, the value of CURRENT FEDERATED ASYNCHRONY is:

- 0, the execution of that statement will not use asynchrony
- greater than 0 and less than or equal to *maxagents* divided by 4, the execution of that statement can involve asynchrony using the specified degree
- ANY (representing -1), the execution of that statement can involve asynchrony using a degree that is determined by the database manager

The value of the CURRENT FEDERATED ASYNCHRONY special register can be changed by invoking the SET CURRENT FEDERATED ASYNCHRONY statement.

The initial value of the CURRENT FEDERATED ASYNCHRONY special register is determined by the *federated\_async* database manager configuration parameter if the dynamic statement is issued through the command line processor (CLP). The initial value is determined by the FEDERATED\_ASYNCHRONY bind option if the dynamic statement is part of an application that is being bound.

*Example:* Set the host variable FEDASYNC (INTEGER) to the value of the CURRENT FEDERATED ASYNCHRONY special register.

```
VALUES CURRENT FEDERATED ASYNCHRONY INTO :FEDASYNC
```

### Related reference:

- “SET CURRENT FEDERATED ASYNCHRONY statement” in *SQL Reference, Volume 2*

### CURRENT IMPLICIT XMLPARSE OPTION

The CURRENT IMPLICIT XMLPARSE OPTION special register specifies the whitespace handling options that are to be used when serialized XML data is implicitly parsed by the DB2 server, without validation. An implicit non-validating parse operation occurs when an SQL statement is processing an XML host variable or an implicitly or explicitly typed XML parameter marker that is not an argument of the XMLVALIDATE function. The data type of the register is VARCHAR(128).

The value of the CURRENT IMPLICIT XMLPARSE OPTION special register can be changed by invoking the SET CURRENT IMPLICIT XMLPARSE OPTION statement. Its initial value is 'STRIP WHITESPACE'.

*Examples:*

Retrieve the value of the CURRENT IMPLICIT XMLPARSE OPTION special register into a host variable named CURXMLPARSEOPT:

```
EXEC SQL VALUES (CURRENT IMPLICIT XMLPARSE OPTION) INTO :CURXMLPARSEOPT;
```

Set the CURRENT IMPLICIT XMLPARSE OPTION special register to 'PRESERVE WHITESPACE'.

```
SET CURRENT IMPLICIT XMLPARSE OPTION = 'PRESERVE WHITESPACE'
```

Whitespace is then preserved when the following SQL statement executes:

```
INSERT INTO T1 (XMLCOL1) VALUES (?)
```

**Related reference:**

- "SET CURRENT IMPLICIT XMLPARSE OPTION statement" in *SQL Reference, Volume 2*
- "XMLVALIDATE " on page 481

## CURRENT ISOLATION

The CURRENT ISOLATION special register holds a CHAR(2) value that identifies the isolation level (in relation to other concurrent sessions) for any dynamic SQL statements issued within the current session.

The possible values are:

**(blanks)**

Not set; use the isolation attribute of the package.

**UR** Uncommitted Read

**CS** Cursor Stability

**RR** Repeatable Read

**RS** Read Stability

The value of the CURRENT ISOLATION special register can be changed by the SET CURRENT ISOLATION statement.

Until a SET CURRENT ISOLATION statement is issued within a session, or after RESET has been specified for SET CURRENT ISOLATION, the CURRENT ISOLATION special register is set to blanks and is not applied to dynamic SQL statements; the isolation level used is taken from the isolation attribute of the package which issued the dynamic SQL statement. Once a SET CURRENT ISOLATION statement has been issued, the CURRENT ISOLATION special register provides the isolation level for any subsequent dynamic SQL statement compiled within the session, regardless of the settings for the package issuing the statement. This will remain in effect until the session ends or until a SET CURRENT ISOLATION statement is issued with the RESET option.

*Example:* Set the host variable ISOLATION\_MODE (CHAR(2)) to the value currently stored in the CURRENT ISOLATION special register.

```
VALUES CURRENT ISOLATION
INTO :ISOLATION_MODE
```

**Related concepts:**

- “Isolation levels” on page 20

**Related reference:**

- “SET CURRENT ISOLATION statement” in *SQL Reference, Volume 2*

### CURRENT LOCK TIMEOUT

The CURRENT LOCK TIMEOUT special register specifies the number of seconds to wait for a lock before returning an error indicating that a lock cannot be obtained. This special register impacts row, table, index key, MDC block, and XML path (XPath) locks. The data type of the register is INTEGER.

Valid values for the CURRENT LOCK TIMEOUT special register are integers between -1 and 32767, inclusive. This special register can also be set to the null value. A value of -1 specifies that timeouts are not to take place, and that the application is to wait until the lock is released or a deadlock is detected. A value of 0 specifies that the application is not to wait for a lock; if a lock cannot be obtained, an error is to be returned immediately.

The value of the CURRENT LOCK TIMEOUT special register can be changed by invoking the SET CURRENT LOCK TIMEOUT statement. Its initial value is null; in this case, the current value of the *locktimeout* database configuration parameter is used when waiting for a lock, and this value will be returned for the special register.

**Related reference:**

- “SET CURRENT LOCK TIMEOUT statement” in *SQL Reference, Volume 2*

### CURRENT MAINTAINED TABLE TYPES FOR OPTIMIZATION

The CURRENT MAINTAINED TABLE TYPES FOR OPTIMIZATION special register specifies a VARCHAR(254) value that identifies the types of tables that can be considered when optimizing the processing of dynamic SQL queries. Materialized query tables are never considered by static embedded SQL queries.

The initial value of CURRENT MAINTAINED TABLE TYPES FOR OPTIMIZATION is SYSTEM. Its value can be changed by the SET CURRENT MAINTAINED TABLE TYPES FOR OPTIMIZATION statement.

**Related reference:**

- “dft\_mttb\_types - Default maintained table types for optimization configuration parameter” in *Performance Guide*
- “SET CURRENT MAINTAINED TABLE TYPES FOR OPTIMIZATION statement” in *SQL Reference, Volume 2*

### CURRENT PACKAGE PATH

The CURRENT PACKAGE PATH special register specifies a VARCHAR(4096) value that identifies the path to be used when resolving references to packages that are needed when executing SQL statements.

The value can be an empty or a blank string, or a list of one or more schema names that are delimited with double quotation marks and separated by commas. Any double quotation marks appearing as part of the string will need to be represented as two double quotation marks, as is common practice with delimited identifiers. The delimiters and commas contribute to the length of the special register.

This special register applies to both static and dynamic statements.

The initial value of CURRENT PACKAGE PATH in a user-defined function, method, or procedure is inherited from the invoking application. In other contexts, the initial value of CURRENT PACKAGE PATH is an empty string. The value is a list of schemas only if the application process has explicitly specified a list of schemas by means of the SET CURRENT PACKAGE PATH statement.

*Examples:*

An application will be using multiple SQLJ packages (in schemas SQLJ1 and SQLJ2) and a JDBC package (in schema DB2JAVA). Set the CURRENT PACKAGE PATH special register to check SQLJ1, SQLJ2, and DB2JAVA, in that order.

```
SET CURRENT PACKAGE PATH = "SQLJ1", "SQLJ2", "DB2JAVA"
```

Set the host variable HVPKLIST to the value currently stored in the CURRENT PACKAGE PATH special register.

```
VALUES CURRENT PACKAGE PATH INTO :HVPKLIST
```

**Related reference:**

- "CURRENT PATH " on page 145
- "SET CURRENT PACKAGE PATH statement" in *SQL Reference, Volume 2*

## CURRENT PATH

The CURRENT PATH (or CURRENT\_PATH) special register specifies a VARCHAR(254) value that identifies the SQL path to be used when resolving function references and data type references in dynamically prepared SQL statements. CURRENT FUNCTION PATH is a synonym for CURRENT PATH. CURRENT PATH is also used to resolve stored procedure references in CALL statements. The initial value is the default value specified below. For static SQL, the FUNCPATH bind option provides an SQL path that is used for function and data type resolution.

The CURRENT PATH special register contains a list of one or more schema names that are enclosed by double quotation marks and separated by commas. For example, an SQL path specifying that the database manager is to look first in the FERMAT schema, then in the XGRAPHIC schema, and finally in the SYSIBM schema, is returned in the CURRENT PATH special register as:

```
"FERMAT", "XGRAPHIC", "SYSIBM"
```

The default value is "SYSIBM", "SYSFUN", "SYSPROC", "SYSIBMADM", X, where X is the value of the USER special register, delimited by double quotation marks. The value can be changed by invoking the SET CURRENT PATH statement. The schema SYSIBM does not need to be specified. If it is not included in the SQL path, it is implicitly assumed to be the first schema. SYSIBM does not take up any of the 254 bytes if it is implicitly assumed.

A data type that is not qualified with a schema name will be implicitly qualified with the first schema in the SQL path that contains a data type with the same unqualified name. There are exceptions to this rule, as outlined in the descriptions of the following statements: CREATE DISTINCT TYPE, CREATE FUNCTION, COMMENT, and DROP.

*Example:* Using the SYSCAT.VIEWS catalog view, find all views that were created with the same setting as the current value of the CURRENT PATH special register.

```
SELECT VIEWNAME, VIEWSCHEMA FROM SYSCAT.VIEWS
WHERE FUNC_PATH = CURRENT PATH
```

### Related reference:

- "Functions" on page 157
- "SET PATH statement" in *SQL Reference, Volume 2*

### CURRENT QUERY OPTIMIZATION

The CURRENT QUERY OPTIMIZATION special register specifies an INTEGER value that controls the class of query optimization performed by the database manager when binding dynamic SQL statements. The QUERYOPT bind option controls the class of query optimization for static SQL statements. The possible values range from 0 to 9. For example, if the query optimization class is set to 0 (minimal optimization), then the value in the special register is 0. The default value is determined by the *dft\_queryopt* database configuration parameter. The value can be changed by invoking the SET CURRENT QUERY OPTIMIZATION statement.

*Example:* Using the SYSCAT.PACKAGES catalog view, find all plans that were bound with the same setting as the current value of the CURRENT QUERY OPTIMIZATION special register.

```
SELECT PKGNAME, PKGSHEMA FROM SYSCAT.PACKAGES
WHERE QUERYOPT = CURRENT QUERY OPTIMIZATION
```

**Related reference:**

- “SET CURRENT QUERY OPTIMIZATION statement” in *SQL Reference, Volume 2*



## CURRENT REFRESH AGE

The CURRENT REFRESH AGE special register specifies a timestamp duration value with a data type of DECIMAL(20,6). It is the maximum duration since a particular timestamped event occurred to a cached data object (for example, a REFRESH TABLE statement processed on a system-maintained REFRESH DEFERRED materialized query table), such that the cached data object can be used to optimize the processing of a query. If CURRENT REFRESH AGE has a value of 99 999 999 999 999, and the query optimization class is 5 or more, the types of tables specified in CURRENT MAINTAINED TABLE TYPES FOR OPTIMIZATION are considered when optimizing the processing of a dynamic SQL query.

The value of CURRENT REFRESH AGE must be 0 or 99 999 999 999 999. The initial value is 0. The value can be changed by invoking the SET CURRENT REFRESH AGE statement.

**Related reference:**

- “SET CURRENT REFRESH AGE statement” in *SQL Reference, Volume 2*

### CURRENT SCHEMA

The CURRENT SCHEMA (or CURRENT\_SCHEMA) special register specifies a VARCHAR(128) value that identifies the schema name used to qualify database object references, where applicable, in dynamically prepared SQL statements. For compatibility with DB2 for OS/390, CURRENT SQLID (or CURRENT\_SQLID) can be specified in place of CURRENT SCHEMA.

The initial value of CURRENT SCHEMA is the authorization ID of the current session user. The value can be changed by invoking the SET SCHEMA statement.

The QUALIFIER bind option controls the schema name used to qualify database object references, where applicable, for static SQL statements.

*Example:* Set the schema for object qualification to 'D123'.

```
SET CURRENT SCHEMA = 'D123'
```

## CURRENT SERVER

The CURRENT SERVER (or CURRENT\_SERVER) special register specifies a VARCHAR(18) value that identifies the current application server. The register contains the actual name of the application server, not an alias.

CURRENT SERVER can be changed through the CONNECT statement, but only under certain conditions.

When used in an SQL statement inside a routine, CURRENT SERVER is not inherited from the invoking statement.

*Example:* Set the host variable APPL\_SERVE (VARCHAR(18)) to the name of the application server to which the application is connected.

```
VALUES CURRENT SERVER INTO :APPL_SERVE
```

**Related reference:**

- “CONNECT (Type 1) statement” in *SQL Reference, Volume 2*

### CURRENT TIME

The CURRENT TIME (or CURRENT\_TIME) special register specifies a time that is based on a reading of the time-of-day clock when the SQL statement is executed at the application server. If this special register is used more than once within a single SQL statement, or used with CURRENT DATE or CURRENT TIMESTAMP within a single statement, all values are based on a single clock reading.

When used in an SQL statement inside a routine, CURRENT TIME is not inherited from the invoking statement.

In a federated system, CURRENT TIME can be used in a query intended for data sources. When the query is processed, the time returned will be obtained from the CURRENT TIME register at the federated server, not from the data sources.

*Example:* Using the CL\_SCHED table, select all the classes (CLASS\_CODE) that start (STARTING) later today. Today's classes have a value of 3 in the DAY column.

```
SELECT CLASS_CODE FROM CL_SCHED
WHERE STARTING > CURRENT TIME AND DAY = 3
```

## CURRENT\_TIMESTAMP

The CURRENT\_TIMESTAMP (or CURRENT\_TIMESTAMP) special register specifies a timestamp that is based on a reading of the time-of-day clock when the SQL statement is executed at the application server. If this special register is used more than once within a single SQL statement, or used with CURRENT\_DATE or CURRENT\_TIME within a single statement, all values are based on a single clock reading.

When used in an SQL statement inside a routine, CURRENT\_TIMESTAMP is not inherited from the invoking statement.

In a federated system, CURRENT\_TIMESTAMP can be used in a query intended for data sources. When the query is processed, the timestamp returned will be obtained from the CURRENT\_TIMESTAMP register at the federated server, not from the data sources.

*Example:* Insert a row into the IN\_TRAY table. The value of the RECEIVED column should be a timestamp that indicates when the row was inserted. The values for the other three columns come from the host variables SRC (char(8)), SUB (char(64)), and TXT (VARCHAR(200)).

```
INSERT INTO IN_TRAY
VALUES (CURRENT_TIMESTAMP, :SRC, :SUB, :TXT)
```

### CURRENT TIMEZONE

The CURRENT TIMEZONE (or CURRENT\_TIMEZONE) special register specifies the difference between UTC (Coordinated Universal Time, formerly known as GMT) and local time at the application server. The difference is represented by a time duration (a decimal number in which the first two digits are the number of hours, the next two digits are the number of minutes, and the last two digits are the number of seconds). The number of hours is between -24 and 24 exclusive. Subtracting CURRENT TIMEZONE from a local time converts that local time to UTC. The time is calculated from the operating system time at the moment the SQL statement is executed. (The CURRENT TIMEZONE value is determined from C runtime functions.)

The CURRENT TIMEZONE special register can be used wherever an expression of the DECIMAL(6,0) data type is used; for example, in time and timestamp arithmetic.

When used in an SQL statement inside a routine, CURRENT TIMEZONE is not inherited from the invoking statement.

*Example:* Insert a record into the IN\_TRAY table, using a UTC timestamp for the RECEIVED column.

```
INSERT INTO IN_TRAY VALUES (  
    CURRENT_TIMESTAMP - CURRENT_TIMEZONE,  
    :source,  
    :subject,  
    :notetext )
```

## CURRENT USER

The CURRENT USER (or CURRENT\_USER) special register specifies the authorization ID that is to be used for statement authorization. For static SQL statements, the value represents the authorization ID that is used when the package is bound. For dynamic SQL statements, the value is the same as the value of the SESSION\_USER special register for packages bound with the DYNAMICRULES(RUN) bind option. The data type of the register is VARCHAR(128).

*Example:* Select table names whose schema matches the value of the CURRENT USER special register.

```
SELECT TABNAME FROM SYSCAT.TABLES
WHERE TABSCHEMA = CURRENT USER AND TYPE = 'T'
```

If this statement is executed as a static SQL statement, it returns the tables whose schema name matches the binder of the package that includes the statement. If this statement is executed as a dynamic SQL statement, it returns the tables whose schema name matches the current value of the SESSION\_USER special register.

### SESSION\_USER

The SESSION\_USER special register specifies the authorization ID that is to be used for the current session. The value of this register is used for authorization checking of dynamic SQL statements when DYNAMICRULES run behavior is in effect for the package. The data type of the register is VARCHAR(128).

The initial value of SESSION\_USER for a new connection is the same as the value of the SYSTEM\_USER special register. Its value can be changed by invoking the SET SESSION AUTHORIZATION statement.

SESSION\_USER is a synonym for the USER special register.

*Example:* Determine what routines can be executed using dynamic SQL. Assume DYNAMICRULES run behavior is in effect for the package that will issue the dynamic SQL statement that invokes the routine.

```
SELECT SCHEMA, SPECIFICNAME FROM SYSCAT.ROUTINEAUTH
WHERE GRANTEE = SESSION_USER
AND EXECUTEAUTH IN ('Y', 'G')
```

**Related reference:**

- “SET SESSION AUTHORIZATION statement” in *SQL Reference, Volume 2*



## SYSTEM\_USER

The SYSTEM\_USER special register specifies the authorization ID of the user that connected to the database. The value of this register can only be changed by connecting as a user with a different authorization ID. The data type of the register is VARCHAR(128).

See “Example” in the description of the SET SESSION AUTHORIZATION statement.

**Related reference:**

- “SET SESSION AUTHORIZATION statement” in *SQL Reference, Volume 2*

## USER

### USER

The USER special register specifies the run-time authorization ID passed to the database manager when an application starts on a database. The data type of the register is VARCHAR(128).

When used in an SQL statement inside a routine, USER is not inherited from the invoking statement.

*Example:* Select all notes from the IN\_TRAY table that were placed there by the user.

```
SELECT * FROM IN_TRAY  
WHERE SOURCE = USER
```

## Functions

A *function* is an operation denoted by a function name followed by one or more operands that are enclosed in parentheses. For example, the `TIMESTAMP` function can be passed input data values of type `DATE` and `TIME`, and the result is a `TIMESTAMP`. Functions can be either built-in or user-defined.

- *Built-in functions* are provided with the database manager. They return a single result value and are identified as part of the `SYSIBM` schema. Such functions include column functions (for example, `AVG`), operator functions (for example, `+`), and casting functions (for example, `DECIMAL`).
- *User-defined functions* are functions that are registered to a database in `SYSCAT.ROUTINES` (using the `CREATE FUNCTION` statement). User-defined functions are never part of the `SYSIBM` schema. One set of such functions is provided with the database manager in a schema called `SYSFUN`.

User-defined functions extend the capabilities of the database system by adding function definitions (provided by users or third party vendors) that can be applied in the database engine itself. Extending database functions lets the database exploit the same functions in the engine that an application uses, providing more synergy between application and database.

### External, SQL, and sourced user-defined functions

A user-defined function can be an external function, an SQL function, or a sourced function. An *external function* is defined to the database with a reference to an object code library, and a function within that library that will be executed when the function is invoked. External functions cannot be column functions. An *SQL function* is defined to the database using only the `SQL RETURN` statement. It can return either a scalar value, a row, or a table. SQL functions cannot be column functions. A *sourced function* is defined to the database with a reference to another built-in or user-defined function that is already known to the database. Sourced functions can be scalar functions or column functions. They are useful for supporting existing functions with user-defined types.

### Scalar, column, row, and table user-defined functions

Each user-defined function is also categorized as a scalar, column, or table function. A *scalar function* is a function that returns a single-valued answer each time it is called. For example, the built-in function `SUBSTR()` is a scalar function. Scalar UDFs can be either external or sourced.

A *column function* is one which conceptually is passed a set of like values (a column) and returns a single-valued answer. These are also sometimes called *aggregating functions* in DB2. An example of a column function is the built-in function `AVG()`. An external column UDF cannot be defined to DB2, but a column UDF, which is sourced upon one of the built-in column functions, can be defined. This is useful for distinct types. For example, if there is a distinct type `SHOESIZE` defined with base type `INTEGER`, a UDF `AVG(SHOESIZE)`, which is sourced on the built-in function `AVG(INTEGER)`, could be defined, and it would be a column function.

A *row function* is a function that returns one row of values. It may only be used as a transform function, mapping attribute values of a structured type into values in a row. A row function must be defined as an SQL function.

A *table function* is a function that returns a table to the SQL statement which references it. It may only be referenced in the `FROM` clause of a `SELECT`

## Scalar, column, row, and table user-defined functions

statement. Such a function can be used to apply SQL language processing power to data that is not DB2 data, or to convert such data into a DB2 table. It could, for example, take a file and convert it into a table, sample data from the World Wide Web and tabularize it, or access a Lotus® Notes® database and return information about mail messages, such as the date, sender, and the text of the message. This information can be joined with other tables in the database. A table function can be defined as an external function or as an SQL function. (A table function cannot be a sourced function.)

### Function signatures

A function is identified by its schema, a function name, the number of parameters, and the data types of its parameters. This is called a *function signature*, which must be unique within the database. There can be more than one function with the same name in a schema, provided that the number of parameters or the data types of the parameters are different. A function name for which there are multiple function instances is called an *overloaded* function. A function name can be overloaded within a schema, in which case there is more than one function by that name in the schema. These functions must have different parameter types. A function name can also be overloaded in an SQL path, in which case there is more than one function by that name in the path. These functions do not necessarily have different parameter types.

A function can be invoked by referring (in an allowable context) to its qualified name (schema and function name), followed by the list of arguments enclosed in parentheses. A function can also be invoked without the schema name, resulting in a choice of possible functions in different schemas with the same or acceptable parameters. In this case, the *SQL path* is used to assist in function resolution. The SQL path is a list of schemas that are searched to identify a function with the same name, number of parameters and acceptable data types. For static SQL statements, the SQL path is specified using the FUNCSPATH bind option. For dynamic SQL statements, the SQL path is the value of the CURRENT PATH special register.

Access to functions is controlled through the EXECUTE privilege. GRANT and REVOKE statements are used to specify who can or cannot execute a specific function or a set of functions. The EXECUTE privilege (or DBADM authority) is needed to invoke a function. The definer of the function automatically receives the EXECUTE privilege. The definer of an external function or an SQL function having the WITH GRANT option on all underlying objects also receives the WITH GRANT option with the EXECUTE privilege on the function. The definer (or SYSADM or DBADM) must then grant it to the user who wants to invoke the function from any SQL statement, reference the function in any DDL statement (such as CREATE VIEW, CREATE TRIGGER, or when defining a constraint), or create another function sourced on this function. If the EXECUTE privilege is not granted to a user, the function will not be considered by the function resolution algorithm, even if it is a better match. Built-in functions (SYSIBM functions) and SYSFUN functions have the EXECUTE privilege implicitly granted to PUBLIC.

### Function resolution

After function invocation, the database manager must decide which of the possible functions with the same name is the “best fit”. This includes resolving functions from the built-in and user-defined functions.

An *argument* is a value passed to a function upon invocation. When a function is invoked in SQL, it is passed a list of zero or more arguments. They are positional in that the semantics of an argument are determined by its position in the

argument list. A *parameter* is a formal definition of an input to a function. When a function is defined to the database, either internally (a built-in function) or by a user (a user-defined function), its parameters (zero or more) are specified, and the order of their definitions defines their positions and their semantics. Therefore, every parameter is a particular positional input to a function. On invocation, an argument corresponds to a particular parameter by virtue of its position in the list of arguments.

The database manager uses the name of the function given in the invocation, EXECUTE privilege on the function, the number and data types of the arguments, all the functions with the same name in the SQL path, and the data types of their corresponding parameters as the basis for deciding whether or not to select a function. The following are the possible outcomes of the decision process:

- A particular function is deemed to be the best fit. For example, given the functions named RISK in the schema TEST with signatures defined as:

```
TEST.RISK(INTEGER)
TEST.RISK(DOUBLE)
```

an SQL path including the TEST schema and the following function reference (where DB is a DOUBLE column):

```
SELECT ... RISK(DB) ...
```

then, the second RISK will be chosen.

The following function reference (where SI is a SMALLINT column):

```
SELECT ... RISK(SI) ...
```

would choose the first RISK, because SMALLINT can be promoted to INTEGER and is a better match than DOUBLE which is further down the precedence list.

When considering arguments that are structured types, the precedence list includes the supertypes of the static type of the argument. The best fit is the function defined with the supertype parameter that is closest in the structured type hierarchy to the static type of the function argument.

- No function is deemed to be an acceptable fit. For example, given the same two functions in the previous case and the following function reference (where C is a CHAR(5) column):

```
SELECT ... RISK(C) ...
```

the argument is inconsistent with the parameter of both RISK functions.

- A particular function is selected based on the SQL path and the number and data types of the arguments passed on invocation. For example, given functions named RANDOM with signatures defined as:

```
TEST.RANDOM(INTEGER)
PROD.RANDOM(INTEGER)
```

and an SQL path of:

```
"TEST", "PROD"
```

the following function reference:

```
SELECT ... RANDOM(432) ...
```

will choose TEST.RANDOM, because both RANDOM functions are equally good matches (exact matches in this particular case), and both schemas are in the path, but TEST precedes PROD in the SQL path.

### Determining the best fit

A comparison of the data types of the arguments with the defined data types of the parameters of the functions under consideration forms the basis for the decision of which function in a group of like-named functions is the “best fit”. Note that the data types of the results of the functions, or the type of function (column, scalar, or table) under consideration do not enter into this determination.

Function resolution is performed using the following steps:

1. First, find all functions from the catalog (SYSCAT.ROUTINES), and built-in functions, such that all of the following are true:
  - For invocations where the schema name was specified (a qualified reference), the schema name and the function name match the invocation name.
  - For invocations where the schema name was not specified (an unqualified reference), the function name matches the invocation name and has a schema name that matches one of the schemas in the SQL path.
  - The invoker has the EXECUTE privilege on the function.
  - The number of defined parameters matches the invocation.
  - Each invocation argument matches the function’s corresponding defined parameter in data type, or is “promotable” to it.
2. Next, consider each argument of the function invocation, from left to right. For each argument, eliminate all functions that are not the best match for that argument. The best match for a given argument is the first data type appearing in the precedence list corresponding to the argument data type for which there exists a function with a parameter of that data type. Lengths, precisions, scales and the FOR BIT DATA attribute are not considered in this comparison. For example, a DECIMAL(9,1) argument is considered an exact match for a DECIMAL(6,5) parameter, and a VARCHAR(19) argument is an exact match for a VARCHAR(6) parameter.

The best match for a user-defined structured-type argument is itself; the next best match is its immediate supertype, and so on for each supertype of the argument. Note that only the static type (declared type) of the structured-type argument is considered, not the dynamic type (most specific type).
3. If more than one candidate function remains after Step 2, all remaining candidate functions must have identical signatures but be in different schemas. Choose the function whose schema is earliest in the user’s SQL path.
4. If there are no candidate functions remaining after step 2, an error is returned (SQLSTATE 42884).

### SQL path considerations for built-in functions

Built-in functions reside in a special schema called SYSIBM. Additional functions are available in the SYSFUN and SYSPROC schemas, but are not considered built-in functions because they are developed as user-defined functions and have no special processing considerations. Users cannot define additional functions in the SYSIBM, SYSFUN, or SYSPROC schemas (or in any other schema whose name begins with the letters ‘SYS’).

As already stated, the built-in functions participate in the function resolution process exactly as do the user-defined functions. One difference between built-in and user-defined functions, from a function resolution perspective, is that the built-in functions must always be considered during function resolution. Therefore, omission of SYSIBM from the path results in the assumption (for function and data type resolution) that SYSIBM is the first schema on the path.

For example, if a user's SQL path is defined as:

```
"SHAREFUN", "SYSIBM", "SYSFUN"
```

and there is a LENGTH function defined in schema SHAREFUN with the same number and types of arguments as SYSIBM.LENGTH, then an unqualified reference to LENGTH in this user's SQL statement will result in selecting SHAREFUN.LENGTH. However, if the user's SQL path is defined as:

```
"SHAREFUN", "SYSFUN"
```

and the same SHAREFUN.LENGTH function exists, then an unqualified reference to LENGTH in this user's SQL statement will result in selecting SYSIBM.LENGTH, because SYSIBM implicitly appears first in the path.

To minimize potential problems in this area:

- Never use the names of built-in functions for user-defined functions.
- If, for some reason, it is necessary to create a user-defined function with the same name as a built-in function, be sure to qualify any references to it.

### Example of function resolution

Following is an example of successful function resolution. (Note that not all required keywords are shown.)

There are seven ACT functions, in three different schemas, registered as:

```
CREATE FUNCTION AUGUSTUS.ACT (CHAR(5), INT, DOUBLE) SPECIFIC ACT_1 ...
CREATE FUNCTION AUGUSTUS.ACT (INT, INT, DOUBLE) SPECIFIC ACT_2 ...
CREATE FUNCTION AUGUSTUS.ACT (INT, INT, DOUBLE, INT) SPECIFIC ACT_3 ...
CREATE FUNCTION JULIUS.ACT (INT, DOUBLE, DOUBLE) SPECIFIC ACT_4 ...
CREATE FUNCTION JULIUS.ACT (INT, INT, DOUBLE) SPECIFIC ACT_5 ...
CREATE FUNCTION JULIUS.ACT (SMALLINT, INT, DOUBLE) SPECIFIC ACT_6 ...
CREATE FUNCTION NERO.ACT (INT, INT, DEC(7,2)) SPECIFIC ACT_7 ...
```

The function reference is as follows (where I1 and I2 are INTEGER columns, and D is a DECIMAL column):

```
SELECT ... ACT(I1, I2, D) ...
```

Assume that the application making this reference has an SQL path established as:

```
"JULIUS", "AUGUSTUS", "CAESAR"
```

Following through the algorithm...

- The function with specific name ACT\_7 is eliminated as a candidate, because the schema NERO is not included in the SQL path.
- The function with specific name ACT\_3 is eliminated as a candidate, because it has the wrong number of parameters. ACT\_1 and ACT\_6 are eliminated because, in both cases, the first argument cannot be promoted to the data type of the first parameter.
- Because there is more than one candidate remaining, the arguments are considered in order.
- For the first argument, the remaining functions, ACT\_2, ACT\_4, and ACT\_5 are an exact match with the argument type. No functions can be eliminated from consideration; therefore the next argument must be examined.
- For this second argument, ACT\_2 and ACT\_5 are exact matches, but ACT\_4 is not, so it is eliminated from consideration. The next argument is examined to determine some differentiation between ACT\_2 and ACT\_5.

## Example of function resolution

- For the third and last argument, neither ACT\_2 nor ACT\_5 match the argument type exactly, but both are equally good.
- There are two functions remaining, ACT\_2 and ACT\_5, with identical parameter signatures. The final tie-breaker is to see which function's schema comes first in the SQL path, and on this basis, ACT\_5 is the function chosen.

## Function invocation

Once the function is selected, there are still possible reasons why the use of the function may not be permitted. Each function is defined to return a result with a specific data type. If this result data type is not compatible with the context in which the function is invoked, an error will occur. For example, given functions named STEP defined, this time, with different data types as the result:

```
STEP(SMALLINT) returns CHAR(5)
STEP(DOUBLE) returns INTEGER
```

and the following function reference (where S is a SMALLINT column):

```
SELECT ... 3 + STEP(S) ...
```

then, because there is an exact match on argument type, the first STEP is chosen. An error occurs on the statement because the result type is CHAR(5) instead of a numeric type as required for an argument of the addition operator.

A couple of other examples where this can happen are as follows, both of which will result in an error on the statement:

- The function was referenced in a FROM clause, but the function selected by the function resolution step was a scalar or column function.
- The reverse case, where the context calls for a scalar or column function, and function resolution selects a table function.

In cases where the arguments of the function invocation were not an exact match to the data types of the parameters of the selected function, the arguments are converted to the data type of the parameter at execution using the same rules as assignment to columns. This includes the case where precision, scale, or length differs between the argument and the parameter.

## Conservative binding semantics

There are instances in which routines and data types are resolved when a statement is processed, and the database manager must be able to repeat this resolution. This is true in:

- Static DML statements in packages
- Views
- Triggers
- Check constraints
- SQL routines

For static DML statements in packages, the routine and data type references are resolved during a bind operation. Routine and data type references in views, triggers, SQL routines, and check constraints are resolved when the database object is created.

If routine resolution is performed again on any routine references in these objects, it could change the behavior if:



- A new routine has been added with a signature that is a better match, but the actual executable performs different operations.
- The definer has been granted the execute privilege on a routine with a signature that is a better match, but the actual executable performs different operations.

Similarly, if resolution is performed again on any data type in these objects, it could change the behavior if a new data type has been added with the same name in a different schema that is also on the SQL path. To avoid this, the database manager applies *conservative binding semantics* wherever necessary. This ensures that routine and data type references will be resolved using the same SQL path and the set of routines to which it previously resolved when it was bound. The creation timestamp of routines and data types considered during resolution is not later than the time when the statement was bound. (Built-in functions added starting with Version 6.1 have a creation timestamp that is based on the time of database creation or migration.) In this way, only the routines and data types that were considered during routine and data type resolution when the statement was originally processed will be considered. Hence, newly created routines, newly authorized routines, and data types are not considered when conservative binding semantics are applied.

Consider a database with two functions that have the signatures SCHEMA1.BAR(INTEGER) and SCHEMA2.BAR(DOUBLE). Assume the SQL path contains both schemas SCHEMA1 and SCHEMA2 (although their order within the SQL path does not matter). USER1 has been granted the EXECUTE privilege on the function SCHEMA2.BAR(DOUBLE). Suppose USER1 creates a view that calls BAR(INT\_VAL). This will resolve to the function SCHEMA2.BAR(DOUBLE). The view will always use SCHEMA2.BAR(DOUBLE), even if someone grants USER1 the EXECUTE privilege on SCHEMA1.BAR(INTEGER) after the view has been created.

For static DML in packages, the packages can rebind implicitly, or by explicitly issuing the REBIND command (or corresponding API), or the BIND command (or corresponding API). The implicit rebind is always performed to resolve routines and data types with conservative binding semantics. The REBIND command provides the option to resolve with conservative binding semantics (RESOLVE CONSERVATIVE) or to resolve by considering any new routines and data types (RESOLVE ANY, the default option).

Implicit rebind of a package always resolves the same routine. Even if EXECUTE privilege on a better-matched routine was granted, that routine will not be considered. Explicit rebind of a package can result in a different routine being selected. (But if RESOLVE CONSERVATIVE is specified, routine resolution will follow conservative binding semantics).

If a routine is specified during the creation of a view, trigger, constraint, or SQL routine body, the specific instance of the routine to be used is determined by routine resolution at the time the object is created. Subsequent granting of the EXECUTE privilege after the object has been created will not change the specific routine that the object uses.

Consider a database with two functions that have the signatures SCHEMA1.BAR(INTEGER) and SCHEMA2.BAR(DOUBLE). USER1 has been granted the EXECUTE privilege on the function SCHEMA2.BAR(DOUBLE). Suppose USER1 creates a view that calls BAR(INT\_VAL). This will resolve to the function SCHEMA2.BAR(DOUBLE). The view will always use

## Conservative binding semantics

SCHEMA2.BAR(DOUBLE), even if someone grants USER1 the EXECUTE privilege on SCHEMA1.BAR(INTEGER) after the view has been created.

The same behavior occurs in other database objects. For example, if a package is implicitly rebound (perhaps after dropping an index), the package will refer to the same specific routine both before and after the implicit rebound. An *explicit* rebound of a package, however, can result in a different routine being selected.

### Related reference:

- “Assignments and comparisons” on page 105
- “CURRENT PATH ” on page 145
- “Promotion of data types” on page 97

---

## Methods

A database method of a structured type is a relationship between a set of input data values and a set of result values, where the first input value (or *subject argument*) has the same type, or is a subtype of the subject type (also called the *subject parameter*), of the method. For example, a method called CITY, of type ADDRESS, can be passed input data values of type VARCHAR, and the result is an ADDRESS (or a subtype of ADDRESS).

Methods are defined implicitly or explicitly, as part of the definition of a user-defined structured type.

Implicitly defined methods are created for every structured type. *Observer methods* are defined for each attribute of the structured type. Observer methods allow applications to get the value of an attribute for an instance of the type. *Mutator methods* are also defined for each attribute, allowing applications to mutate the type instance by changing the value for an attribute of a type instance. The CITY method described above is an example of a mutator method for the type ADDRESS.

Explicitly defined methods, or *user-defined methods*, are methods that are registered to a database in SYSCAT.ROUTINES, by using a combination of CREATE TYPE (or ALTER TYPE ADD METHOD) and CREATE METHOD statements. All methods defined for a structured type are defined in the same schema as the type.

User-defined methods for structured types extend the function of the database system by adding method definitions (provided by users or third party vendors) that can be applied to structured type instances in the database engine. Defining database methods lets the database exploit the same methods in the engine that an application uses, providing more synergy between application and database.

### External and SQL user-defined methods

A user-defined method can be either external or based on an SQL expression. An external method is defined to the database with a reference to an object code library and a function within that library that will be executed when the method is invoked. A method based on an SQL expression returns the result of the SQL expression when the method is invoked. Such methods do not require any object code library, because they are written completely in SQL.

A user-defined method can return a single-valued answer each time it is called. This value can be a structured type. A method can be defined as *type preserving* (using SELF AS RESULT), to allow the dynamic type of the subject argument to be returned as the returned type of the method. All implicitly defined mutator methods are type preserving.

### Method signatures

A method is identified by its subject type, a method name, the number of parameters, and the data types of its parameters. This is called a *method signature*, and it must be unique within the database.

There can be more than one method with the same name for a structured type, provided that:

- The number of parameters or the data types of the parameters are different, or

## Method signatures

- The methods are part of the same method hierarchy (that is, the methods are in an overriding relationship or override the same original method), or
- The same function signature (using the subject type or any of its subtypes or supertypes as the first parameter) does not exist.

A method name that has multiple method instances is called an *overloaded method*. A method name can be overloaded within a type, in which case there is more than one method by that name for the type (all of which have different parameter types). A method name can also be overloaded in the subject type hierarchy, in which case there is more than one method by that name in the type hierarchy. These methods must have different parameter types.

A method can be invoked by referring (in an allowable context) to the method name, preceded by both a reference to a structured type instance (the subject argument), and the double dot operator. A list of arguments enclosed in parentheses must follow. Which method is actually invoked depends on the static type of the subject type, using the method resolution process described in the following section. Methods defined WITH FUNCTION ACCESS can also be invoked using function invocation, in which case the regular rules for function resolution apply.

If function resolution results in a method defined WITH FUNCTION ACCESS, all subsequent steps of method invocation are processed.

Access to methods is controlled through the EXECUTE privilege. GRANT and REVOKE statements are used to specify who can or cannot execute a specific method or a set of methods. The EXECUTE privilege (or DBADM authority) is needed to invoke a method. The definer of the method automatically receives the EXECUTE privilege. The definer of an external method or an SQL method having the WITH GRANT option on all underlying objects also receives the WITH GRANT option with the EXECUTE privilege on the method. The definer (or SYSADM or DBADM) must then grant it to the user who wants to invoke the method from any SQL statement, or reference the method in any DDL statement (such as CREATE VIEW, CREATE TRIGGER, or when defining a constraint). If the EXECUTE privilege is not granted to a user, the method will not be considered by the method resolution algorithm, even if it is a better match.

## Method resolution

After method invocation, the database manager must decide which of the possible methods with the same name is the “best fit”. Functions (built-in or user-defined) are not considered during method resolution.

An *argument* is a value passed to a method upon invocation. When a method is invoked in SQL, it is passed the subject argument (of some structured type) and a list of zero or more arguments. They are positional in that the semantics of an argument are determined by its position in the argument list. A *parameter* is a formal definition of an input to a method. When a method is defined to the database, either implicitly (system-generated for a type) or by a user (a user-defined method), its parameters are specified (with the subject parameter as the first parameter), and the order of their definitions defines their positions and their semantics. Therefore, every parameter is a particular positional input to a method. On invocation, an argument corresponds to a particular parameter by virtue of its position in the list of arguments.

The database manager uses the name of the method given in the invocation, EXECUTE privilege on the method, the number and data types of the arguments, all the methods with the same name for the subject argument's static type (and its supertypes), and the data types of their corresponding parameters as the basis for deciding whether or not to select a method. The following are the possible outcomes of the decision process:

- A particular method is deemed to be the best fit. For example, given the methods named RISK for the type SITE with signatures defined as:

```
PROXIMITY(INTEGER) FOR SITE
PROXIMITY(DOUBLE) FOR SITE
```

the following method invocation (where ST is a SITE column, DB is a DOUBLE column):

```
SELECT ST..PROXIMITY(DB) ...
```

then, the second PROXIMITY will be chosen.

The following method invocation (where SI is a SMALLINT column):

```
SELECT ST..PROXIMITY(SI) ...
```

would choose the first PROXIMITY, because SMALLINT can be promoted to INTEGER and is a better match than DOUBLE, which is further down the precedence list.

When considering arguments that are structured types, the precedence list includes the supertypes of the static type of the argument. The best fit is the function defined with the supertype parameter that is closest in the structured type hierarchy to the static type of the function argument.

- No method is deemed to be an acceptable fit. For example, given the same two functions in the previous case and the following function reference (where C is a CHAR(5) column):

```
SELECT ST..PROXIMITY(C) ...
```

the argument is inconsistent with the parameter of both PROXIMITY functions.

- A particular method is selected based on the methods in the type hierarchy and the number and data types of the arguments passed on invocation. For example, given methods named RISK for the types SITE and DRILLSITE (a subtype of SITE) with signatures defined as:

```
RISK(INTEGER) FOR DRILLSITE
RISK(DOUBLE) FOR SITE
```

and the following method invocation (where DRST is a DRILLSITE column, DB is a DOUBLE column):

```
SELECT DRST..RISK(DB) ...
```

the second RISK will be chosen, because DRILLSITE can be promoted to SITE.

The following method reference (where SI is a SMALLINT column):

```
SELECT DRST..RISK(SI) ...
```

would choose the first RISK, because SMALLINT can be promoted to INTEGER, which is closer on the precedence list than DOUBLE, and DRILLSITE is a better match than SITE, which is a supertype.

Methods within the same type hierarchy cannot have the same signatures, considering parameters other than the subject parameter.

### Determining the best fit

A comparison of the data types of the arguments with the defined data types of the parameters of the methods under consideration forms the basis for the decision of which method in a group of like-named methods is the “best fit”. Note that the data types of the results of the methods under consideration do not enter into this determination.

Method resolution is performed using the following steps:

1. First, find all methods from the catalog (SYSCAT.ROUTINES) such that all of the following are true:
  - The method name matches the invocation name, and the subject parameter is the same type or is a supertype of the static type of the subject argument.
  - The invoker has the EXECUTE privilege on the method.
  - The number of defined parameters matches the invocation.
  - Each invocation argument matches the method’s corresponding defined parameter in data type, or is “promotable” to it.
2. Next, consider each argument of the method invocation, from left to right. The leftmost argument (and thus the first argument) is the implicit SELF parameter. For example, a method defined for type ADDRESS\_T has an implicit first parameter of type ADDRESS\_T. For each argument, eliminate all functions that are not the best match for that argument. The best match for a given argument is the first data type appearing in the precedence list corresponding to the argument data type for which there exists a function with a parameter of that data type. Length, precision, scale and the FOR BIT DATA attribute are not considered in this comparison. For example, a DECIMAL(9,1) argument is considered an exact match for a DECIMAL(6,5) parameter, and a VARCHAR(19) argument is an exact match for a VARCHAR(6) parameter. The best match for a user-defined structured-type argument is itself; the next best match is its immediate supertype, and so on for each supertype of the argument. Note that only the static type (declared type) of the structured-type argument is considered, not the dynamic type (most specific type).
3. At most, one candidate method remains after Step 2. This is the method that is chosen.
4. If there are no candidate methods remaining after step 2, an error is returned (SQLSTATE 42884).

### Example of method resolution

Following is an example of successful method resolution.

There are seven FOO methods for three structured types defined in a hierarchy of GOVERNOR as a subtype of EMPEROR as a subtype of HEADOFSTATE, registered with the following signatures:

```
CREATE METHOD FOO (CHAR(5), INT, DOUBLE) FOR HEADOFSTATE SPECIFIC FOO_1 ...
CREATE METHOD FOO (INT, INT, DOUBLE) FOR HEADOFSTATE SPECIFIC FOO_2 ...
CREATE METHOD FOO (INT, INT, DOUBLE, INT) FOR HEADOFSTATE SPECIFIC FOO_3 ...
CREATE METHOD FOO (INT, DOUBLE, DOUBLE) FOR EMPEROR SPECIFIC FOO_4 ...
CREATE METHOD FOO (INT, INT, DOUBLE) FOR EMPEROR SPECIFIC FOO_5 ...
CREATE METHOD FOO (SMALLINT, INT, DOUBLE) FOR EMPEROR SPECIFIC FOO_6 ...
CREATE METHOD FOO (INT, INT, DEC(7,2)) FOR GOVERNOR SPECIFIC FOO_7 ...
```

The method reference is as follows (where I1 and I2 are INTEGER columns, D is a DECIMAL column and E is an EMPEROR column):

```
SELECT E..FOO(I1, I2, D) ...
```

Following through the algorithm...

- FOO\_7 is eliminated as a candidate, because the type GOVERNOR is a subtype (not a supertype) of EMPEROR.
- FOO\_3 is eliminated as a candidate, because it has the wrong number of parameters.
- FOO\_1 and FOO\_6 are eliminated because, in both cases, the first argument (not the subject argument) cannot be promoted to the data type of the first parameter. Because there is more than one candidate remaining, the arguments are considered in order.
- For the subject argument, FOO\_2 is a supertype, while FOO\_4 and FOO\_5 match the subject argument.
- For the first argument, the remaining methods, FOO\_4 and FOO\_5, are an exact match with the argument type. No methods can be eliminated from consideration; therefore the next argument must be examined.
- For this second argument, FOO\_5 is an exact match, but FOO\_4 is not, so it is eliminated from consideration. This leaves FOO\_5 as the method chosen.

## Method invocation

Once the method is selected, there are still possible reasons why the use of the method may not be permitted.

Each method is defined to return a result with a specific data type. If this result data type is not compatible with the context in which the method is invoked, an error will occur. For example, assume that the following methods named STEP are defined, each with a different data type as the result:

```
STEP(SMALLINT) FOR TYPEA RETURNS CHAR(5)
STEP(DOUBLE) FOR TYPEA RETURNS INTEGER
```

and the following method reference (where S is a SMALLINT column and TA is a column of TYPEA):

```
SELECT 3 + TA..STEP(S) ...
```

then, because there is an exact match on argument type, the first STEP is chosen. An error occurs on the statement, because the result type is CHAR(5) instead of a numeric type, as required for an argument of the addition operator.

Starting from the method that has been chosen, the algorithm described in “Dynamic dispatch of methods” is used to build the set of dispatchable methods at compile time. Exactly which method is invoked is described in “Dynamic dispatch of methods”.

Note that when the selected method is a type preserving method:

- the static result type following function resolution is the same as the static type of the subject argument of the method invocation
- the dynamic result type when the method is invoked is the same as the dynamic type of the subject argument of the method invocation.

This may be a subtype of the result type specified in the type preserving method definition, which in turn may be a supertype of the dynamic type that is actually returned when the method is processed.

In cases where the arguments of the method invocation were not an exact match to the data types of the parameters of the selected method, the arguments are converted to the data type of the parameter at execution using the same rules as

assignment to columns. This includes the case where precision, scale, or length differs between the argument and the parameter, but excludes the case where the dynamic type of the argument is a subtype of the parameter's static type.

### Dynamic dispatch of methods

Methods provide the functionality and encapsulate the data of a type. A method is defined for a type and can always be associated with this type. One of the method's parameters is the implicit SELF parameter. The SELF parameter is of the type for which the method has been declared. The argument that is passed as the SELF argument when the method is invoked in a DML statement is called *subject*.

When a method is chosen using method resolution (see "Method resolution" on page 166), or a method has been specified in a DDL statement, this method is known as the "most specific applicable authorized method". If the subject is of a structured type, that method could have one or more overriding methods. DB2 must then determine which of these methods to invoke, based on the dynamic type (most specific type) of the subject at run time. This determination is called "determining the most specific dispatchable method". That process is described here.

1. Find the original method in the method hierarchy that the most specific applicable authorized method is part of. This is called the *root method*.
2. Create the set of dispatchable methods, which includes the following:
  - The most specific applicable authorized method.
  - Any method that overrides the most specific applicable authorized method, and which is defined for a type that is a subtype of the subject of this invocation.
3. Determine the most specific dispatchable method, as follows:
  - a. Start with an arbitrary method that is an element of the set of dispatchable methods and that is a method of the dynamic type of the subject, or of one of its supertypes. This is the initial most specific dispatchable method.
  - b. Iterate through the elements of the set of dispatchable methods. For each method: If the method is defined for one of the proper subtypes of the type for which the most specific dispatchable method is defined, and if it is defined for one of the supertypes of the most specific type of the subject, then repeat step 2 with this method as the most specific dispatchable method; otherwise, continue iterating.
4. Invoke the most specific dispatchable method.

Example:

Given are three types, "Person", "Employee", and "Manager". There is an original method "income", defined for "Person", which computes a person's income. A person is by default unemployed (a child, a retiree, and so on). Therefore, "income" for type "Person" always returns zero. For type "Employee" and for type "Manager", different algorithms have to be applied to calculate the income. Hence, the method "income" for type "Person" is overridden in "Employee" and "Manager".

Create and populate a table as follows:

```
CREATE TABLE aTable (id integer, personColumn Person);
INSERT INTO aTable VALUES (0, Person()), (1, Employee()), (2, Manager());
```

List all persons who have a minimum income of \$40000:



```
SELECT id, person, name
FROM aTable
WHERE person..income() >= 40000;
```

The method "income" for type "Person" is chosen, using method resolution, to be the most specific applicable authorized method.

1. The root method is "income" for "Person" itself.
2. The second step of the algorithm above is carried out to construct the set of dispatchable methods:

- The method "income" for type "Person" is included, because it is the most specific applicable authorized method.
- The method "income" for type "Employee", and "income" for "Manager" is included, because both methods override the root method, and both "Employee" and "Manager" are subtypes of "Person".

Therefore, the set of dispatchable methods is: {"income" for "Person", "income" for "Employee", "income" for "Manager"}.

3. Determine the most specific dispatchable method:
  - For a subject whose most specific type is "Person":
    - a. Let the initial most specific dispatchable method be "income" for type "Person".
    - b. Because there is no other method in the set of dispatchable methods that is defined for a proper subtype of "Person" and for a supertype of the most specific type of the subject, "income" for type "Person" is the most specific dispatchable method.
  - For a subject whose most specific type is "Employee":
    - a. Let the initial most specific dispatchable method be "income" for type "Person".
    - b. Iterate through the set of dispatchable methods. Because method "income" for type "Employee" is defined for a proper subtype of "Person" and for a supertype of the most specific type of the subject (Note: A type is its own super- and subtype.), method "income" for type "Employee" is a better match for the most specific dispatchable method. Repeat this step with method "income" for type "Employee" as the most specific dispatchable method.
    - c. Because there is no other method in the set of dispatchable methods that is defined for a proper subtype of "Employee" and for a supertype of the most specific type of the subject, method "income" for type "Employee" is the most specific dispatchable method.
  - For a subject whose most specific type is "Manager":
    - a. Let the initial most specific dispatchable method be "income" for type "Person".
    - b. Iterate through the set of dispatchable methods. Because method "income" for type "Manager" is defined for a proper subtype of "Person" and for a supertype of the most specific type of the subject (Note: A type is its own super- and subtype.), method "income" for type "Manager" is a better match for the most specific dispatchable method. Repeat this step with method "income" for type "Manager" as the most specific dispatchable method.
    - c. Because there is no other method in the set of dispatchable methods that is defined for a proper subtype of "Manager" and for a supertype of the most specific type of the subject, method "income" for type "Manager" is the most specific dispatchable method.

## Dynamic dispatch of methods

4. Invoke the most specific dispatchable method.

**Related reference:**

- “Assignments and comparisons” on page 105
- “Promotion of data types” on page 97

## Expressions

### Expressions

An expression specifies a value. It can be a simple value, consisting of only a constant or a column name, or it can be more complex. When repeatedly using similar complex expressions, an SQL function to encapsulate a common expression can be considered.

In a Unicode database, an expression that accepts a character or graphic string will accept any string types for which conversion is supported.

**expression:**

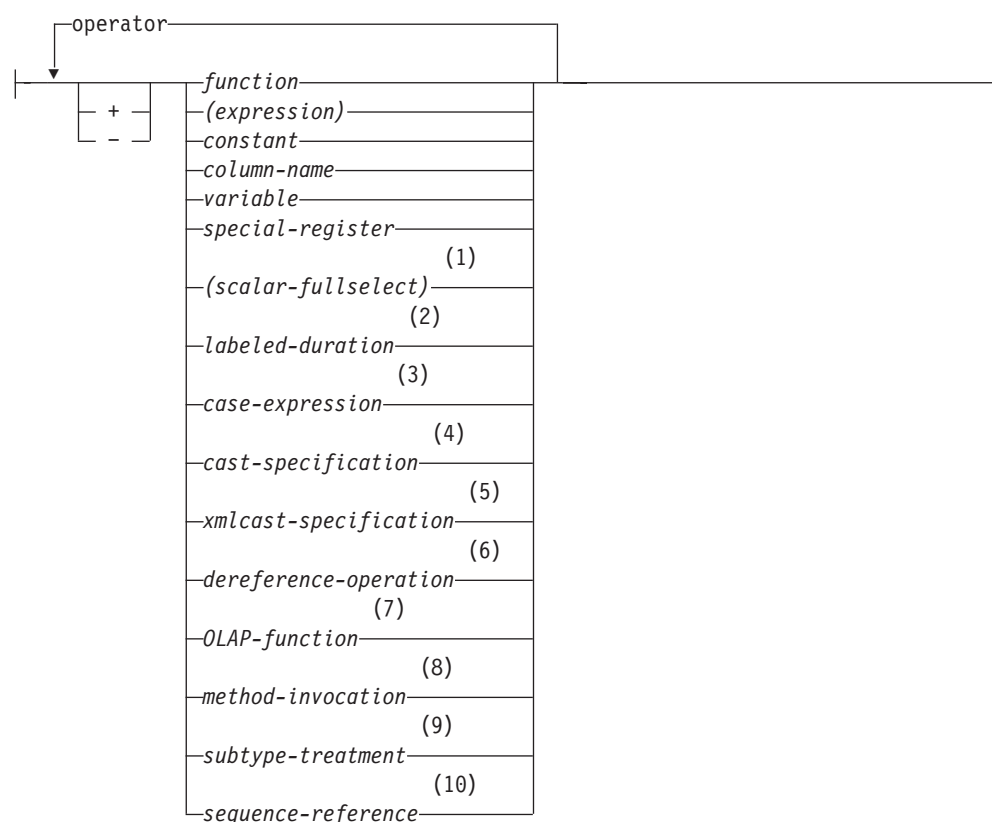

**operator:**

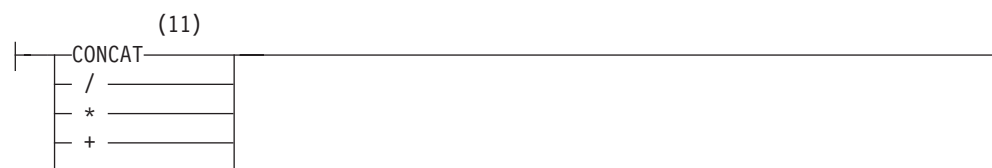

**Notes:**

- 1 See “Scalar fullselect” on page 179 for more information.
- 2 See “Labeled durations” on page 180 for more information.

## Expressions

- 3 See “CASE expressions” on page 185 for more information.
- 4 See “CAST specifications” on page 187 for more information.
- 5 See “XMLCAST specifications” on page 190 for more information.
- 6 See “Dereference operations” on page 192 for more information.
- 7 See “OLAP functions” on page 194 for more information.
- 8 See “Method invocation” on page 200 for more information.
- 9 See “Subtype treatment” on page 202 for more information.
- 10 See “Sequence reference” on page 203 for more information.
- 11 || can be used as a synonym for CONCAT.

### Expressions without operators

If no operators are used, the result of the expression is the specified value.

Examples:

```
SALARY:SALARY'SALARY'MAX(SALARY)
```

### Expressions with the concatenation operator

The concatenation operator (CONCAT) links two string operands to form a *string expression*.

The operands of concatenation must be compatible strings. Note that a binary string cannot be concatenated with a character string, including character strings defined as FOR BIT DATA (SQLSTATE 42884).

In a Unicode database, concatenation involving both character string operands and graphic string operands will first convert the character operands to graphic operands. Note that in a non-Unicode database, concatenation cannot involve both character and graphic operands.

If either operand can be null, the result can be null, and if either is null, the result is the null value. Otherwise, the result consists of the first operand string followed by the second. Note that no check is made for improperly formed mixed data when doing concatenation.

The length of the result is the sum of the lengths of the operands.

The data type and length attribute of the result is determined from that of the operands as shown in the following table:

Table 12. Data Type and Length of Concatenated Operands

| Operands             | Combined Length Attributes | Result       |
|----------------------|----------------------------|--------------|
| CHAR(A) CHAR(B)      | <255                       | CHAR(A+B)    |
| CHAR(A) CHAR(B)      | >254                       | VARCHAR(A+B) |
| CHAR(A) VARCHAR(B)   | <4001                      | VARCHAR(A+B) |
| CHAR(A) VARCHAR(B)   | >4000                      | LONG VARCHAR |
| CHAR(A) LONG VARCHAR | -                          | LONG VARCHAR |
|                      |                            |              |

## Expressions with the concatenation operator

Table 12. Data Type and Length of Concatenated Operands (continued)

| Operands                        | Combined Length Attributes | Result                 |
|---------------------------------|----------------------------|------------------------|
| VARCHAR(A) VARCHAR(B)           | <4001                      | VARCHAR(A+B)           |
| VARCHAR(A) VARCHAR(B)           | >4000                      | LONG VARCHAR           |
| VARCHAR(A) LONG VARCHAR         | -                          | LONG VARCHAR           |
|                                 |                            |                        |
| LONG VARCHAR LONG VARCHAR       | -                          | LONG VARCHAR           |
|                                 |                            |                        |
| CLOB(A) CHAR(B)                 | -                          | CLOB(MIN(A+B, 2G))     |
| CLOB(A) VARCHAR(B)              | -                          | CLOB(MIN(A+B, 2G))     |
| CLOB(A) LONG VARCHAR            | -                          | CLOB(MIN(A+32K, 2G))   |
| CLOB(A) CLOB(B)                 | -                          | CLOB(MIN(A+B, 2G))     |
|                                 |                            |                        |
| GRAPHIC(A) GRAPHIC(B)           | <128                       | GRAPHIC(A+B)           |
| GRAPHIC(A) GRAPHIC(B)           | >127                       | VARGRAPHIC(A+B)        |
| GRAPHIC(A) VARGRAPHIC(B)        | <2001                      | VARGRAPHIC(A+B)        |
| GRAPHIC(A) VARGRAPHIC(B)        | >2000                      | LONG VARGRAPHIC        |
| GRAPHIC(A) LONG VARGRAPHIC      | -                          | LONG VARGRAPHIC        |
|                                 |                            |                        |
| VARGRAPHIC(A) VARGRAPHIC(B)     | <2001                      | VARGRAPHIC(A+B)        |
| VARGRAPHIC(A) VARGRAPHIC(B)     | >2000                      | LONG VARGRAPHIC        |
| VARGRAPHIC(A) LONG VARGRAPHIC   | -                          | LONG VARGRAPHIC        |
|                                 |                            |                        |
| LONG VARGRAPHIC LONG VARGRAPHIC | -                          | LONG VARGRAPHIC        |
|                                 |                            |                        |
| DBCLOB(A) GRAPHIC(B)            | -                          | DBCLOB(MIN(A+B, 1G))   |
| DBCLOB(A) VARGRAPHIC(B)         | -                          | DBCLOB(MIN(A+B, 1G))   |
| DBCLOB(A) LONG VARGRAPHIC       | -                          | DBCLOB(MIN(A+16K, 1G)) |
| DBCLOB(A) DBCLOB(B)             | -                          | DBCLOB(MIN(A+B, 1G))   |
|                                 |                            |                        |
| BLOB(A) BLOB(B)                 | -                          | BLOB(MIN(A+B, 2G))     |

Note that, for compatibility with previous versions, there is no automatic escalation of results involving LONG data types to LOB data types. For example, concatenation of a CHAR(200) value and a completely full LONG VARCHAR value would result in an error rather than in a promotion to a CLOB data type.

The code page of the result is considered a derived code page and is determined by the code page of its operands.

One operand may be a parameter marker. If a parameter marker is used, then the data type and length attributes of that operand are considered to be the same as

## Expressions with the concatenation operator

those for the non-parameter marker operand. The order of operations must be considered to determine these attributes in cases with nested concatenation.

*Example 1:* If FIRSTNAME is Pierre and LASTNAME is Fermat, then the following:

```
FIRSTNAME CONCAT ' ' CONCAT LASTNAME
```

returns the value Pierre Fermat.

*Example 2:* Given:

- COLA defined as VARCHAR(5) with value 'AA'
- :host\_var defined as a character host variable with length 5 and value 'BB'
- COLC defined as CHAR(5) with value 'CC'
- COLD defined as CHAR(5) with value 'DDDDD'

The value of COLA **CONCAT** :host\_var **CONCAT** COLC **CONCAT** COLD is  
'AABB CC DDDDD'

The data type is VARCHAR, the length attribute is 17 and the result code page is the database code page.

*Example 3:* Given:

```
COLA defined as CHAR(10)  
COLB defined as VARCHAR(5)
```

The parameter marker in the expression:

```
COLA CONCAT COLB CONCAT ?
```

is considered VARCHAR(15), because COLA **CONCAT** COLB is evaluated first, giving a result that is the first operand of the second **CONCAT** operation.

**User-defined types:** A user-defined type cannot be used with the concatenation operator, even if it is a distinct type with a source data type that is a string type. To concatenate, create a function with the **CONCAT** operator as its source. For example, if there were distinct types TITLE and TITLE\_DESCRIPTION, both of which had VARCHAR(25) data types, the following user-defined function, ATTACH, could be used to concatenate them.

```
CREATE FUNCTION ATTACH (TITLE, TITLE_DESCRIPTION)  
RETURNS VARCHAR(50) SOURCE CONCAT (VARCHAR(), VARCHAR())
```

Alternately, the concatenation operator could be overloaded using a user-defined function to add the new data types.

```
CREATE FUNCTION CONCAT (TITLE, TITLE_DESCRIPTION)  
RETURNS VARCHAR(50) SOURCE CONCAT (VARCHAR(), VARCHAR())
```

## Expressions with arithmetic operators

If arithmetic operators are used, the result of the expression is a value derived from the application of the operators to the values of the operands.

If any operand can be null, or the database is configured with DFT\_SQLMATHWARN set to yes, the result can be null.

If any operand has the null value, the result of the expression is the null value.

Arithmetic operators can be applied to signed numeric types and datetime types (see “Datetime arithmetic in SQL” on page 181). For example, `USER+2` is invalid. Sourced functions can be defined for arithmetic operations on distinct types with a source type that is a signed numeric type.

The prefix operator `+` (unary plus) does not change its operand. The prefix operator `-` (unary minus) reverses the sign of a nonzero operand; and if the data type of `A` is small integer, the data type of `-A` is large integer. The first character of the token following a prefix operator must not be a plus or minus sign.

The *infix operators* `+`, `-`, `*`, and `/` specify addition, subtraction, multiplication, and division, respectively. The value of the second operand of division must not be zero. These operators can also be treated as functions. Thus, the expression `"+"(a,b)` is equivalent to the expression `a+b`. “operator” function.

**Arithmetic errors:** If an arithmetic error such as zero divide or a numeric overflow occurs during the processing of an expression, an error is returned and the SQL statement processing the expression fails with an error (SQLSTATE 22003 or 22012).

A database can be configured (using `DFT_SQLMATHWARN` set to yes) so that arithmetic errors return a null value for the expression, issue a warning (SQLSTATE 01519 or 01564), and proceed with processing of the SQL statement. When arithmetic errors are treated as nulls, there are implications on the results of SQL statements. The following are some examples of these implications.

- An arithmetic error that occurs in the expression that is the argument of a column function causes the row to be ignored in the determining the result of the column function. If the arithmetic error was an overflow, this may significantly impact the result values.
- An arithmetic error that occurs in the expression of a predicate in a `WHERE` clause can cause rows to not be included in the result.
- An arithmetic error that occurs in the expression of a predicate in a check constraint results in the update or insert proceeding since the constraint is not false.

If these types of impacts are not acceptable, additional steps should be taken to handle the arithmetic error to produce acceptable results. Some examples are:

- add a case expression to check for zero divide and set the desired value for such a situation
- add additional predicates to handle nulls (like a check constraint on not nullable columns could become:

```
check (c1*c2 is not null and c1*c2>5000)
```

to cause the constraint to be violated on an overflow).

### Two-integer operands

If both operands of an arithmetic operator are integers, the operation is performed in binary and the result is a *large integer* unless either (or both) operand is a big integer, in which case the result is a big integer. Any remainder of division is lost. The result of an integer arithmetic operation (including unary minus) must be within the range of the result type.

### Integer and decimal operands

If one operand is an integer and the other is a decimal, the operation is performed in decimal using a temporary copy of the integer that has been converted to a decimal number with precision  $p$  and scale 0;  $p$  is 19 for a big integer, 11 for a large integer, and 5 for a small integer.

### Two-decimal operands

If both operands are decimal, the operation is performed in decimal. The result of any decimal arithmetic operation is a decimal number with a precision and scale that are dependent on the operation and the precision and scale of the operands. If the operation is addition or subtraction and the operands do not have the same scale, the operation is performed with a temporary copy of one of the operands. The copy of the shorter operand is extended with trailing zeros so that its fractional part has the same number of digits as the longer operand.

The result of a decimal operation must not have a precision greater than 31. The result of decimal addition, subtraction, and multiplication is derived from a temporary result which may have a precision greater than 31. If the precision of the temporary result is not greater than 31, the final result is the same as the temporary result.

### Decimal arithmetic in SQL

The following formulas define the precision and scale of the result of decimal operations in SQL. The symbols  $p$  and  $s$  denote the precision and scale of the first operand, and the symbols  $p'$  and  $s'$  denote the precision and scale of the second operand.

**Addition and subtraction:** The precision is  $\min(31, \max(p-s, p'-s') + \max(s, s') + 1)$ . The scale of the result of addition and subtraction is  $\max(s, s')$ .

**Multiplication:** The precision of the result of multiplication is  $\min(31, p + p')$  and the scale is  $\min(31, s + s')$ .

**Division:** The precision of the result of division is 31. The scale is  $31 - p + s'$ . The scale must not be negative.

**Note:** The MIN\_DEC\_DIV\_3 database configuration parameter alters the scale for decimal arithmetic operations involving division. If the parameter value is set to NO, the scale is calculated as  $31 - p + s'$ . If the parameter is set to YES, the scale is calculated as  $\text{MAX}(3, 31 - p + s')$ . This ensures that the result of decimal division always has a scale of at least 3 (precision is always 31).

### Floating-point operands

If either operand of an arithmetic operator is floating-point, the operation is performed in floating-point, the operands having first been converted to double-precision floating-point numbers, if necessary. Thus, if any element of an expression is a floating-point number, the result of the expression is a double-precision floating-point number.

An operation involving a floating-point number and an integer is performed with a temporary copy of the integer which has been converted to double-precision floating-point. An operation involving a floating-point number and a decimal number is performed with a temporary copy of the decimal number which has been converted to double-precision floating-point. The result of a floating-point operation must be within the range of floating-point numbers.



## User-defined types as operands

A user-defined type cannot be used with arithmetic operators, even if its source data type is numeric. To perform an arithmetic operation, create a function with the arithmetic operator as its source. For example, if there were distinct types INCOME and EXPENSES, both of which had DECIMAL(8,2) data types, then the following user-defined function, REVENUE, could be used to subtract one from the other.

```
CREATE FUNCTION REVENUE (INCOME, EXPENSES)
  RETURNS DECIMAL(8,2) SOURCE "-" (DECIMAL, DECIMAL)
```

Alternately, the - (minus) operator could be overloaded using a user-defined function to subtract the new data types.

```
CREATE FUNCTION "-" (INCOME, EXPENSES)
  RETURNS DECIMAL(8,2) SOURCE "-" (DECIMAL, DECIMAL)
```

## Precedence of operations

Expressions within parentheses and dereference operations are evaluated first from left to right. (Parentheses are also used in subselect statements, search conditions, and functions. However, they should not be used to arbitrarily group sections within SQL statements.) When the order of evaluation is not specified by parentheses, prefix operators are applied before multiplication and division, and multiplication and division are applied before addition and subtraction. Operators at the same precedence level are applied from left to right.

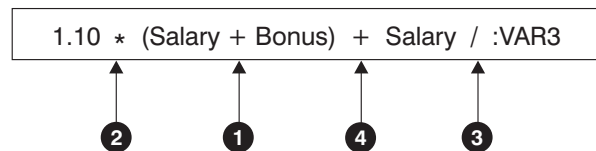

Figure 11. Precedence of Operations

## Scalar fullselect

A *scalar fullselect*, as supported in an expression, is a fullselect, enclosed in parentheses, that returns a single row consisting of a single column value. If the fullselect does not return a row, the result of the expression is the null value. If the select list element is an expression that is simply a column name or a dereference operation, the result column name is based on the name of the column. The authorization required for a scalar fullselect is the same as that required for an SQL query.

### Related reference:

- “CREATE FUNCTION (SQL Scalar, Table, or Row) statement” in *SQL Reference, Volume 2*
- “Assignments and comparisons” on page 105
- “Fullselect” on page 543
- “Rules for string conversions” on page 120
- “SQL queries” on page 505

## Datetime operations and durations

Datetime values can be incremented, decremented, and subtracted. These operations can involve decimal numbers called durations. The following sections describe duration types and detail the rules for datetime arithmetic.

### Durations

A *duration* is a number representing an interval of time. There are four types of durations.

#### Labeled durations:

##### labeled-duration:

|                      |              |
|----------------------|--------------|
| <i>function</i>      | YEAR         |
| <i>(expression)</i>  | YEARS        |
| <i>constant</i>      | MONTH        |
| <i>column-name</i>   | MONTHS       |
| <i>host-variable</i> | DAY          |
|                      | DAYS         |
|                      | HOUR         |
|                      | HOURS        |
|                      | MINUTE       |
|                      | MINUTES      |
|                      | SECOND       |
|                      | SECONDS      |
|                      | MICROSECOND  |
|                      | MICROSECONDS |

A *labeled duration* represents a specific unit of time as expressed by a number (which can be the result of an expression) followed by one of the seven duration keywords: YEARS, MONTHS, DAYS, HOURS, MINUTES, SECONDS, or MICROSECONDS. (The singular form of these keywords is also acceptable: YEAR, MONTH, DAY, HOUR, MINUTE, SECOND, and MICROSECOND.) The number specified is converted as if it were assigned to a DECIMAL(15,0) number. A labeled duration can only be used as an operand of an arithmetic operator in which the other operand is a value of data type DATE, TIME, or TIMESTAMP. Thus, the expression HIREDATE + 2 MONTHS + 14 DAYS is valid, whereas the expression HIREDATE + (2 MONTHS + 14 DAYS) is not. In both of these expressions, the labeled durations are 2 MONTHS and 14 DAYS.

**Date duration:** A *date duration* represents a number of years, months, and days, expressed as a DECIMAL(8,0) number. To be properly interpreted, the number must have the format *yyyymmdd.*, where *yyyy* represents the number of years, *mm* the number of months, and *dd* the number of days. (The period in the format indicates a DECIMAL data type.) The result of subtracting one date value from another, as in the expression HIREDATE - BRTHDATE, is a date duration.

**Time duration:** A *time duration* represents a number of hours, minutes, and seconds, expressed as a DECIMAL(6,0) number. To be properly interpreted, the number must have the format *hhmmss.*, where *hh* represents the number of hours, *mm* the number of minutes, and *ss* the number of seconds. (The period in the format indicates a DECIMAL data type.) The result of subtracting one time value from another is a time duration.

**Timestamp duration:** A *timestamp duration* represents a number of years, months, days, hours, minutes, seconds, and microseconds, expressed as a DECIMAL(20,6) number. To be properly interpreted, the number must have the format *yyyymmddhhmmss.nnnnnn*, where *yyyy*, *mm*, *dd*, *hh*, *mm*, *ss*, and *nnnnnn* represent, respectively, the number of years, months, days, hours, minutes, seconds, and microseconds. The result of subtracting one timestamp value from another is a timestamp duration.

### Datetime arithmetic in SQL

The only arithmetic operations that can be performed on datetime values are addition and subtraction. If a datetime value is the operand of addition, the other operand must be a duration. The specific rules governing the use of the addition operator with datetime values follow.

- If one operand is a date, the other operand must be a date duration or labeled duration of YEARS, MONTHS, or DAYS.
- If one operand is a time, the other operand must be a time duration or a labeled duration of HOURS, MINUTES, or SECONDS.
- If one operand is a timestamp, the other operand must be a duration. Any type of duration is valid.
- Neither operand of the addition operator can be a parameter marker.

The rules for the use of the subtraction operator on datetime values are not the same as those for addition because a datetime value cannot be subtracted from a duration, and because the operation of subtracting two datetime values is not the same as the operation of subtracting a duration from a datetime value. The specific rules governing the use of the subtraction operator with datetime values follow.

- If the first operand is a date, the second operand must be a date, a date duration, a string representation of a date, or a labeled duration of YEARS, MONTHS, or DAYS.
- If the second operand is a date, the first operand must be a date, or a string representation of a date.
- If the first operand is a time, the second operand must be a time, a time duration, a string representation of a time, or a labeled duration of HOURS, MINUTES, or SECONDS.
- If the second operand is a time, the first operand must be a time, or string representation of a time.
- If the first operand is a timestamp, the second operand must be a timestamp, a string representation of a timestamp, or a duration.
- If the second operand is a timestamp, the first operand must be a timestamp or a string representation of a timestamp.
- Neither operand of the subtraction operator can be a parameter marker.

**Date arithmetic:** Dates can be subtracted, incremented, or decremented.

*Subtracting Dates:* The result of subtracting one date (DATE2) from another (DATE1) is a date duration that specifies the number of years, months, and days between the two dates. The data type of the result is DECIMAL(8,0). If DATE1 is greater than or equal to DATE2, DATE2 is subtracted from DATE1. If DATE1 is less than DATE2, however, DATE1 is subtracted from DATE2, and the sign of the result is made negative. The following procedural description clarifies the steps involved in the operation  $\text{result} = \text{DATE1} - \text{DATE2}$ .

```
If DAY(DATE2) <= DAY(DATE1)
then DAY(RESULT) = DAY(DATE1) - DAY(DATE2).
```

## Datetime arithmetic in SQL

```
If DAY (DATE2) > DAY (DATE1)
then DAY (RESULT) = N + DAY (DATE1) - DAY (DATE2)
where N = the last day of MONTH (DATE2).
MONTH (DATE2) is then incremented by 1.

If MONTH (DATE2) <= MONTH (DATE1)
then MONTH (RESULT) = MONTH (DATE1) - MONTH (DATE2).

If MONTH (DATE2) > MONTH (DATE1)
then MONTH (RESULT) = 12 + MONTH (DATE1) - MONTH (DATE2).
YEAR (DATE2) is then incremented by 1.
YEAR (RESULT) = YEAR (DATE1) - YEAR (DATE2).
```

For example, the result of `DATE('3/15/2000') - '12/31/1999'` is 00000215. (or, a duration of 0 years, 2 months, and 15 days).

*Incrementing and decrementing dates:* The result of adding a duration to a date, or of subtracting a duration from a date, is itself a date. (For the purposes of this operation, a month denotes the equivalent of a calendar page. Adding months to a date, then, is like turning the pages of a calendar, starting with the page on which the date appears.) The result must fall between the dates January 1, 0001 and December 31, 9999 inclusive.

If a duration of years is added or subtracted, only the year portion of the date is affected. The month is unchanged, as is the day unless the result would be February 29 of a non-leap-year. In this case, the day is changed to 28, and a warning indicator in the SQLCA is set to indicate the adjustment.

Similarly, if a duration of months is added or subtracted, only months and, if necessary, years are affected. The day portion of the date is unchanged unless the result would be invalid (September 31, for example). In this case, the day is set to the last day of the month, and a warning indicator in the SQLCA is set to indicate the adjustment.

Adding or subtracting a duration of days will, of course, affect the day portion of the date, and potentially the month and year.

Date durations, whether positive or negative, may also be added to and subtracted from dates. As with labeled durations, the result is a valid date, and a warning indicator is set in the SQLCA whenever an end-of-month adjustment is necessary.

When a positive date duration is added to a date, or a negative date duration is subtracted from a date, the date is incremented by the specified number of years, months, and days, in that order. Thus, `DATE1 + X`, where `X` is a positive `DECIMAL(8,0)` number, is equivalent to the expression:

```
DATE1 + YEAR(X) YEARS + MONTH(X) MONTHS + DAY(X) DAYS.
```

When a positive date duration is subtracted from a date, or a negative date duration is added to a date, the date is decremented by the specified number of days, months, and years, in that order. Thus, `DATE1 - X`, where `X` is a positive `DECIMAL(8,0)` number, is equivalent to the expression:

```
DATE1 - DAY(X) DAYS - MONTH(X) MONTHS - YEAR(X) YEARS.
```

When adding durations to dates, adding one month to a given date gives the same date one month later unless that date does not exist in the later month. In that case, the date is set to that of the last day of the later month. For example, January 28 plus one month gives February 28; and one month added to January 29, 30, or 31 results in either February 28 or, for a leap year, February 29.

**Note:** If one or more months is added to a given date and then the same number of months is subtracted from the result, the final date is not necessarily the same as the original date.

**Time arithmetic:** Times can be subtracted, incremented, or decremented.

*Subtracting time values:* The result of subtracting one time (TIME2) from another (TIME1) is a time duration that specifies the number of hours, minutes, and seconds between the two times. The data type of the result is DECIMAL(6,0).

If TIME1 is greater than or equal to TIME2, TIME2 is subtracted from TIME1.

If TIME1 is less than TIME2, however, TIME1 is subtracted from TIME2, and the sign of the result is made negative. The following procedural description clarifies the steps involved in the operation  $\text{result} = \text{TIME1} - \text{TIME2}$ .

```

If SECOND(TIME2) <= SECOND(TIME1)
then SECOND(RESULT) = SECOND(TIME1) - SECOND(TIME2).
If SECOND(TIME2) > SECOND(TIME1)
then SECOND(RESULT) = 60 + SECOND(TIME1) - SECOND(TIME2).
MINUTE(TIME2) is then incremented by 1.
If MINUTE(TIME2) <= MINUTE(TIME1)
then MINUTE(RESULT) = MINUTE(TIME1) - MINUTE(TIME2).
If MINUTE(TIME1) > MINUTE(TIME1)
then MINUTE(RESULT) = 60 + MINUTE(TIME1) - MINUTE(TIME2).
HOUR(TIME2) is then incremented by 1.
HOUR(RESULT) = HOUR(TIME1) - HOUR(TIME2).

```

For example, the result of  $\text{TIME}('11:02:26') - '00:32:56'$  is 102930. (a duration of 10 hours, 29 minutes, and 30 seconds).

*Incrementing and decrementing time values:* The result of adding a duration to a time, or of subtracting a duration from a time, is itself a time. Any overflow or underflow of hours is discarded, thereby ensuring that the result is always a time. If a duration of hours is added or subtracted, only the hours portion of the time is affected. The minutes and seconds are unchanged.

Similarly, if a duration of minutes is added or subtracted, only minutes and, if necessary, hours are affected. The seconds portion of the time is unchanged.

Adding or subtracting a duration of seconds will, of course, affect the seconds portion of the time, and potentially the minutes and hours.

Time durations, whether positive or negative, also can be added to and subtracted from times. The result is a time that has been incremented or decremented by the specified number of hours, minutes, and seconds, in that order.  $\text{TIME1} + X$ , where "X" is a DECIMAL(6,0) number, is equivalent to the expression:

```

TIME1 + HOUR(X) HOURS + MINUTE(X) MINUTES + SECOND(X) SECONDS

```

**Note:** Although the time '24:00:00' is accepted as a valid time, it is never returned as the result of time addition or subtraction, even if the duration operand is zero (for example,  $\text{time}('24:00:00') \pm 0 \text{ seconds} = '00:00:00'$ ).

**Timestamp arithmetic:** Timestamps can be subtracted, incremented, or decremented.

## Datetime arithmetic in SQL

*Subtracting timestamps:* The result of subtracting one timestamp (TS2) from another (TS1) is a timestamp duration that specifies the number of years, months, days, hours, minutes, seconds, and microseconds between the two timestamps. The data type of the result is DECIMAL(20,6).

If TS1 is greater than or equal to TS2, TS2 is subtracted from TS1. If TS1 is less than TS2, however, TS1 is subtracted from TS2 and the sign of the result is made negative. The following procedural description clarifies the steps involved in the operation  $\text{result} = \text{TS1} - \text{TS2}$ :

```
If MICROSECOND(TS2) <= MICROSECOND(TS1)
then MICROSECOND(RESULT) = MICROSECOND(TS1) -
MICROSECOND(TS2).
If MICROSECOND(TS2) > MICROSECOND(TS1)
then MICROSECOND(RESULT) = 1000000 +
MICROSECOND(TS1) - MICROSECOND(TS2)
and SECOND(TS2) is incremented by 1.
```

The seconds and minutes part of the timestamps are subtracted as specified in the rules for subtracting times.

```
If HOUR(TS2) <= HOUR(TS1)
then HOUR(RESULT) = HOUR(TS1) - HOUR(TS2).
If HOUR(TS2) > HOUR(TS1)
then HOUR(RESULT) = 24 + HOUR(TS1) - HOUR(TS2)
and DAY(TS2) is incremented by 1.
```

The date part of the timestamps is subtracted as specified in the rules for subtracting dates.

*Incrementing and decrementing timestamps:* The result of adding a duration to a timestamp, or of subtracting a duration from a timestamp is itself a timestamp. Date and time arithmetic is performed as previously defined, except that an overflow or underflow of hours is carried into the date part of the result, which must be within the range of valid dates. Microseconds overflow into seconds.

## CASE expressions

### case-expression:

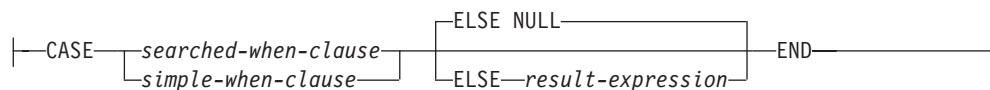

### searched-when-clause:

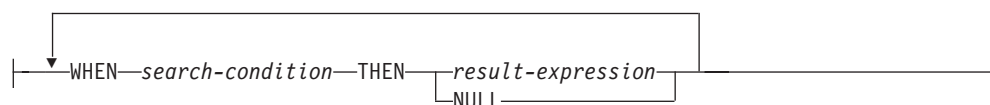

### simple-when-clause:

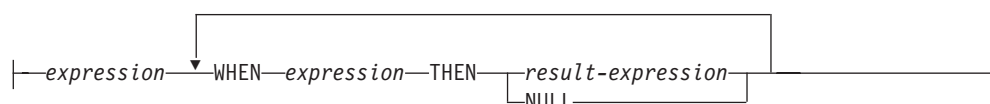

CASE expressions allow an expression to be selected based on the evaluation of one or more conditions. In general, the value of the case-expression is the value of the *result-expression* following the first (leftmost) case that evaluates to true. If no case evaluates to true and the ELSE keyword is present then the result is the value of the *result-expression* or NULL. If no case evaluates to true and the ELSE keyword is not present then the result is NULL. Note that when a case evaluates to unknown (because of NULLs), the case is not true and hence is treated the same way as a case that evaluates to false.

If the CASE expression is in a VALUES clause, an IN predicate, a GROUP BY clause, or an ORDER BY clause, the *search-condition* in a searched-when-clause cannot be a quantified predicate, IN predicate using a fullselect, or an EXISTS predicate (SQLSTATE 42625).

When using the *simple-when-clause*, the value of the *expression* prior to the first WHEN keyword is tested for equality with the value of the *expression* following the WHEN keyword. The data type of the *expression* prior to the first WHEN keyword must therefore be comparable to the data types of each *expression* following the WHEN keyword(s). The *expression* prior to the first WHEN keyword in a *simple-when-clause* cannot include a function that is variant or has an external action (SQLSTATE 42845).

A *result-expression* is an *expression* following the THEN or ELSE keywords. There must be at least one *result-expression* in the CASE expression (NULL cannot be specified for every case) (SQLSTATE 42625). All result expressions must have compatible data types (SQLSTATE 42804).

### Examples:

- If the first character of a department number is a division in the organization, then a CASE expression can be used to list the full name of the division to which each employee belongs:

## CASE expressions

```
SELECT EMPNO, LASTNAME,  
       CASE SUBSTR(WORKDEPT,1,1)  
         WHEN 'A' THEN 'Administration'  
         WHEN 'B' THEN 'Human Resources'  
         WHEN 'C' THEN 'Accounting'  
         WHEN 'D' THEN 'Design'  
         WHEN 'E' THEN 'Operations'  
       END  
FROM EMPLOYEE;
```

- The number of years of education are used in the EMPLOYEE table to give the education level. A CASE expression can be used to group these and to show the level of education.

```
SELECT EMPNO, FIRSTNAME, MIDINIT, LASTNAME,  
       CASE  
         WHEN EDLEVEL < 15 THEN 'SECONDARY'  
         WHEN EDLEVEL < 19 THEN 'COLLEGE'  
         ELSE 'POST GRADUATE'  
       END  
FROM EMPLOYEE
```

- Another interesting example of CASE statement usage is in protecting from division by 0 errors. For example, the following code finds the employees who earn more than 25% of their income from commission, but who are not fully paid on commission:

```
SELECT EMPNO, WORKDEPT, SALARY+COMM FROM EMPLOYEE  
WHERE (CASE WHEN SALARY=0 THEN NULL  
       ELSE COMM/SALARY  
       END) > 0.25;
```

- The following CASE expressions are the same:

```
SELECT LASTNAME,  
       CASE  
         WHEN LASTNAME = 'Haas' THEN 'President'  
         ...  
  
SELECT LASTNAME,  
       CASE LASTNAME  
         WHEN 'Haas' THEN 'President'  
         ...
```

There are two scalar functions, NULLIF and COALESCE, that are specialized to handle a subset of the functionality provided by CASE. Table 13 shows the equivalent expressions using CASE or these functions.

*Table 13. Equivalent CASE Expressions*

| Expression   | Equivalent Expression  |
|--|------------------------|
| CASE WHEN e1=e2 THEN NULL ELSE e1 END                            | NULLIF(e1,e2)          |
| CASE WHEN e1 IS NOT NULL THEN e1 ELSE e2 END                     | COALESCE(e1,e2)        |
| CASE WHEN e1 IS NOT NULL THEN e1 ELSE<br>COALESCE(e2,...,eN) END | COALESCE(e1,e2,...,eN) |

### Related reference:

- “Rules for result data types” on page 116



## CAST specifications

### cast-specification:

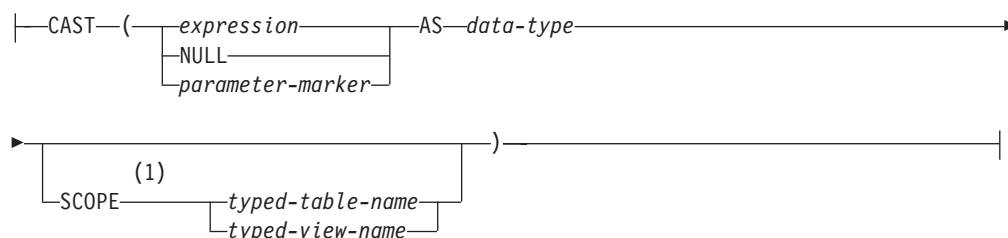

### Notes:

- 1 The SCOPE clause only applies to the REF data type.

The CAST specification returns the cast operand (the first operand) cast to the type specified by the *data-type*. If the cast is not supported, an error is returned (SQLSTATE 42846).

#### *expression*

If the cast operand is an expression (other than parameter marker or NULL), the result is the argument value converted to the specified target *data-type*.

When casting character strings (other than CLOBs) to a character string with a different length, a warning (SQLSTATE 01004) is returned if truncation of other than trailing blanks occurs. When casting graphic character strings (other than DBCLOBs) to a graphic character string with a different length, a warning (SQLSTATE 01004) is returned if truncation of other than trailing blanks occurs. For BLOB, CLOB and DBCLOB cast operands, the warning is issued if any characters are truncated.

#### NULL

If the cast operand is the keyword NULL, the result is a null value that has the specified *data-type*.

#### *parameter-marker*

A parameter marker (specified as a question mark character) is normally considered an expression, but is documented separately in this case because it has a special meaning. If the cast operand is a *parameter-marker*, the specified *data-type* is considered a promise that the replacement will be assignable to the specified data type (using store assignment for strings). Such a parameter marker is considered a *typed parameter marker*. Typed parameter markers will be treated like any other typed value for the purpose of function resolution, DESCRIBE of a select list or for column assignment.

#### *data-type*

The name of an existing data type. If the type name is not qualified, the SQL path is used to do data type resolution. A data type that has an associated attributes like length or precision and scale should include these attributes when specifying *data-type* (CHAR defaults to a length of 1 and DECIMAL defaults to a precision of 5 and scale of 0 if not specified). Restrictions on the supported data types are based on the specified cast operand.

- For a cast operand that is an *expression*, the supported target data types depend on the data type of the cast operand (source data type).
- For a cast operand that is the keyword NULL, any existing data type can be used.

## CAST specifications

- For a cast operand that is a parameter marker, the target data type can be any existing data type. If the data type is a user-defined distinct type, the application using the parameter marker will use the source data type of the user-defined distinct type. If the data type is a user-defined structured type, the application using the parameter marker will use the input parameter type of the TO SQL transform function for the user-defined structured type.

### SCOPE

When the data type is a reference type, a scope may be defined that identifies the target table or target view of the reference.

#### *typed-table-name*

The name of a typed table. The table must already exist (SQLSTATE 42704). The cast must be to *data-type* REF(*S*), where *S* is the type of *typed-table-name* (SQLSTATE 428DM).

#### *typed-view-name*

The name of a typed view. The view must exist or have the same name as the view being created that includes the cast as part of the view definition (SQLSTATE 42704). The cast must be to *data-type* REF(*S*), where *S* is the type of *typed-view-name* (SQLSTATE 428DM).

When numeric data is cast to character data, the result data type is a fixed-length character string. When character data is cast to numeric data, the result data type depends on the type of number specified. For example, if cast to integer, it becomes a large integer.

### Examples:

- An application is only interested in the integer portion of the SALARY (defined as decimal(9,2)) from the EMPLOYEE table. The following query, including the employee number and the integer value of SALARY, could be prepared.

```
SELECT EMPNO, CAST(SALARY AS INTEGER) FROM EMPLOYEE
```

- Assume the existence of a distinct type called T\_AGE that is defined on SMALLINT and used to create column AGE in PERSONNEL table. Also assume the existence of a distinct type called R\_YEAR that is defined on INTEGER and used to create column RETIRE\_YEAR in PERSONNEL table. The following update statement could be prepared.

```
UPDATE PERSONNEL SET RETIRE_YEAR =?  
WHERE AGE = CAST( ? AS T_AGE)
```

The first parameter is an untyped parameter marker that would have a data type of R\_YEAR, although the application will use an integer for this parameter marker. This does not require the explicit CAST specification because it is an assignment.

The second parameter marker is a typed parameter marker that is cast as a distinct type T\_AGE. This satisfies the requirement that the comparison must be performed with compatible data types. The application will use the source data type (which is SMALLINT) for processing this parameter marker.

Successful processing of this statement assumes that the SQL path includes the schema name of the schema (or schemas) where the two distinct types are defined.

- An application supplies a value that is a series of bits, for example an audio stream, and it should not undergo code page conversion before being used in an SQL statement. The application could use the following CAST:

```
CAST( ? AS VARCHAR(10000) FOR BIT DATA)
```

### Related reference:

- “Casting between data types” on page 99
- “CHAR ” on page 291
- “INTEGER ” on page 348
- “XMLCAST specifications” on page 190

## XMLCAST specifications

### xmlcast-specification:

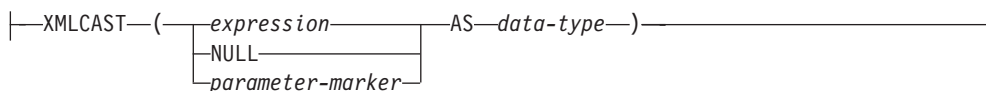

The XMLCAST specification returns the cast operand (the first operand) cast to the type specified by the data type. XMLCAST supports casts involving XML values, including conversions between non-XML data types and the XML data type. If the cast is not supported, an error is returned (SQLSTATE 22003).

The XMLCAST specification is only supported in a Unicode database with a single database partition (SQLSTATE 42997).

#### *expression*

If the cast operand is an expression (other than a parameter marker or NULL), the result is the argument value converted to the specified target data type. The expression or the target data type must be the XML data type (SQLSTATE 42846).

#### NULL

If the cast operand is the keyword NULL, the target data type must be the XML data type (SQLSTATE 42846). The result is a null XML value.

#### *parameter-marker*

If the cast operand is a parameter marker, the target data type must be XML (SQLSTATE 42846). A parameter marker (specified as a question mark character) is normally considered to be an expression, but is documented separately in this case because it has special meaning. If the cast operand is a parameter marker, the specified data type is considered to be a promise that the replacement will be assignable to the specified (XML) data type (using store assignment). Such a parameter marker is considered to be a typed parameter marker, which is treated like any other typed value for the purpose of function resolution, a describe operation on a select list, or column assignment.

#### *data-type*

The name of an existing SQL data type. If the name is not qualified, the SQL path is used to perform data type resolution. If a data type has associated attributes, such as length or precision and scale, these attributes should be included when specifying a value for *data-type*. CHAR defaults to a length of 1, and DECIMAL defaults to a precision of 5 and a scale of 0 if not specified. Restrictions on the supported data types are based on the specified cast operand.

- For a cast operand that is an expression, the supported target data types depend on the data type of the cast operand (source data type).
- For a cast operand that is the keyword NULL, the target data type must be XML.
- For a cast operand that is a parameter marker, the target data type must be XML.

#### Examples:

- Create a null XML value.

```
XMLCAST(NULL AS XML)
```

- Convert a value extracted from an XMLQUERY expression into an INTEGER:  

```
XMLCAST(XMLQUERY('$m/PRODUCT/QUANTITY'  
PASSING BY REF xmlcol AS "m" RETURNING SEQUENCE) AS INTEGER)
```
- Convert a value extracted from an XMLQUERY expression into a varying-length character string:  

```
XMLCAST(XMLQUERY('$m/PRODUCT/ADD-TIMESTAMP'  
PASSING BY REF xmlcol AS "m" RETURNING SEQUENCE) AS VARCHAR(30))
```
- Convert a value extracted from an SQL scalar subquery into an XML value.  

```
XMLCAST((SELECT quantity FROM product AS p  
WHERE p.id = 1077) AS XML)
```

### Related reference:

- “Casting between data types” on page 99
- “CAST specifications” on page 187

## Dereference operations

### dereference-operation:

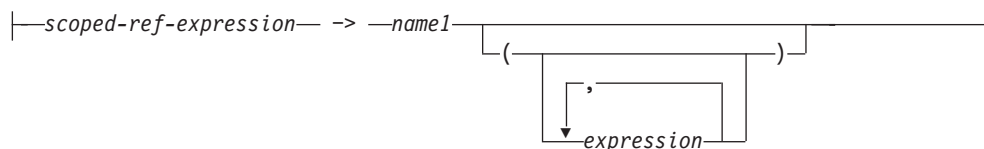

The scope of the scoped reference expression is a table or view called the *target* table or view. The scoped reference expression identifies a *target row*. The *target row* is the row in the target table or view (or in one of its subtables or subviews) whose object identifier (OID) column value matches the reference expression. The dereference operation can be used to access a column of the target row, or to invoke a method, using the target row as the subject of the method. The result of a dereference operation can always be null. The dereference operation takes precedence over all other operators.

#### *scoped-ref-expression*

An expression that is a reference type that has a scope (SQLSTATE 428DT). If the expression is a host variable, parameter marker or other unscoped reference type value, a CAST specification with a SCOPE clause is required to give the reference a scope.

#### *name1*

Specifies an unqualified identifier.

If no parentheses follow *name1*, and *name1* matches the name of an attribute of the target type, then the value of the dereference operation is the value of the named column in the target row. In this case, the data type of the column (made nullable) determines the result type of the dereference operation. If no target row exists whose object identifier matches the reference expression, then the result of the dereference operation is null. If the dereference operation is used in a select list and is not included as part of an expression, *name1* becomes the result column name.

If parentheses follow *name1*, or if *name1* does not match the name of an attribute of the target type, then the dereference operation is treated as a method invocation. The name of the invoked method is *name1*. The subject of the method is the target row, considered as an instance of its structured type. If no target row exists whose object identifier matches the reference expression, the subject of the method is a null value of the target type. The expressions inside parentheses, if any, provide the remaining parameters of the method invocation. The normal process is used for resolution of the method invocation. The result type of the selected method (made nullable) determines the result type of the dereference operation.

The authorization ID of the statement that uses a dereference operation must have SELECT privilege on the target table of the *scoped-ref-expression* (SQLSTATE 42501).

A dereference operation can never modify values in the database. If a dereference operation is used to invoke a mutator method, the mutator method modifies a copy of the target row and returns the copy, leaving the database unchanged.

### Examples:

- Assume the existence of an EMPLOYEE table that contains a column called DEPTREF which is a reference type scoped to a typed table based on a type that includes the attribute DEPTNAME. The values of DEPTREF in the table EMPLOYEE should correspond to the OID column values in the target table of DEPTREF column.

```
SELECT EMPNO, DEPTREF->DEPTNAME
FROM EMPLOYEE
```

- Using the same tables as in the previous example, use a dereference operation to invoke a method named BUDGET, with the target row as subject parameter, and '1997' as an additional parameter.

```
SELECT EMPNO, DEPTREF->BUDGET('1997') AS DEPTBUDGET97
FROM EMPLOYEE
```

### Related reference:

- “CREATE TABLE statement” in *SQL Reference, Volume 2*

## OLAP functions

### OLAP-specification:

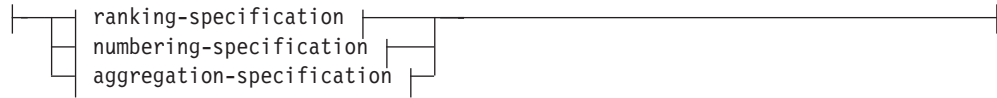

### ranking-specification:

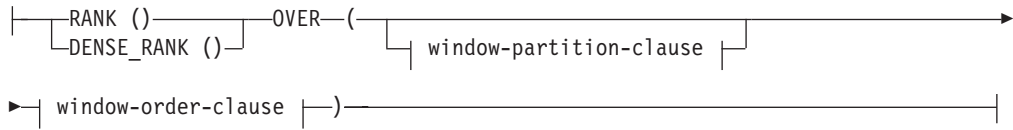

### numbering-specification:

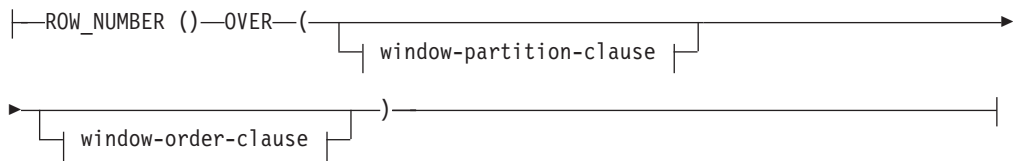

### aggregation-specification:

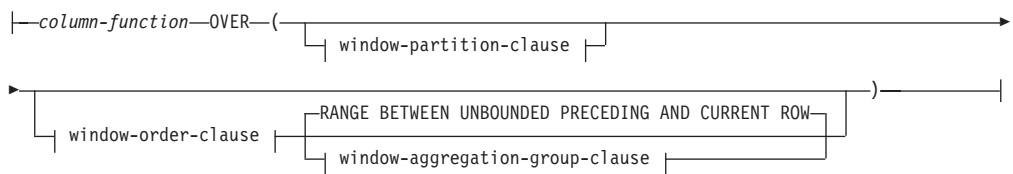

### window-partition-clause:



### window-order-clause:

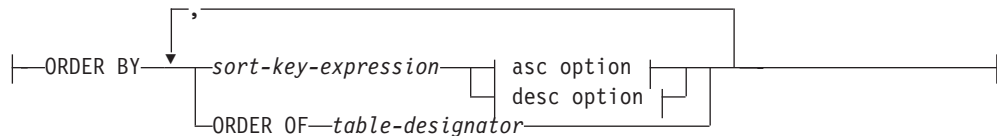

### asc option:



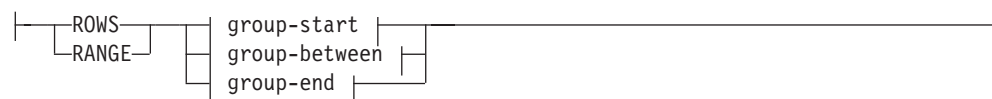
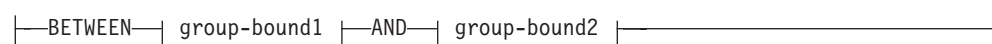
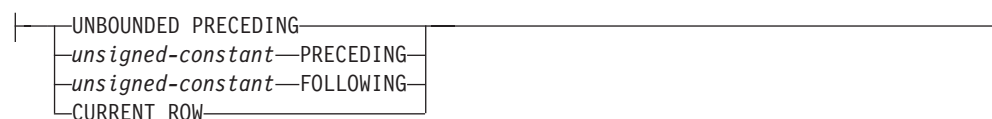

**desc option:****window-aggregation-group-clause:****group-start:****group-between:****group-bound1:****group-bound2:****group-end:**

On-Line Analytical Processing (OLAP) functions provide the ability to return ranking, row numbering and existing column function information as a scalar value in a query result. An OLAP function can be included in expressions in a select-list or the ORDER BY clause of a select-statement (SQLSTATE 42903). An OLAP function cannot be used within an argument to an XMLQUERY or XMLEXISTS expression (SQLSTATE 42903). An OLAP function cannot be used as an argument of a column function (SQLSTATE 42607). The query result to which the OLAP function is applied is the result table of the innermost subselect that includes the OLAP function.

## OLAP functions

When specifying an OLAP function, a window is specified that defines the rows over which the function is applied, and in what order. When used with a column function, the applicable rows can be further refined, relative to the current row, as either a range or a number of rows preceding and following the current row. For example, within a partition by month, an average can be calculated over the previous three month period.

The ranking function computes the ordinal rank of a row within the window. Rows that are not distinct with respect to the ordering within their window are assigned the same rank. The results of ranking may be defined with or without gaps in the numbers resulting from duplicate values.

If RANK is specified, the rank of a row is defined as 1 plus the number of rows that strictly precede the row. Thus, if two or more rows are not distinct with respect to the ordering, then there will be one or more gaps in the sequential rank numbering.

If DENSE\_RANK (or DENSERANK) is specified, the rank of a row is defined as 1 plus the number of preceding rows that are distinct with respect to the ordering. Therefore, there will be no gaps in the sequential rank numbering.

The ROW\_NUMBER (or ROWNUMBER) function computes the sequential row number of the row within the window defined by the ordering, starting with 1 for the first row. If the ORDER BY clause is not specified in the window, the row numbers are assigned to the rows in arbitrary order, as returned by the subselect (not according to any ORDER BY clause in the select-statement).

If the FETCH FIRST *n* ROWS ONLY clause is used along with the ROW\_NUMBER function, the row numbers might not be displayed in order. The FETCH FIRST clause is applied after the result set (including any ROW\_NUMBER assignments) is generated; therefore, if the row number order is not the same as the order of the result set, some assigned numbers might be missing from the sequence.

The data type of the result of RANK, DENSE\_RANK or ROW\_NUMBER is BIGINT. The result cannot be null.

### **PARTITION BY** (*partitioning-expression*,...)

Defines the partition within which the function is applied. A *partitioning-expression* is an expression that is used in defining the partitioning of the result set. Each *column-name* that is referenced in a *partitioning-expression* must unambiguously reference a result set column of the OLAP function subselect statement (SQLSTATE 42702 or 42703). A *partitioning-expression* cannot include a scalar fullselect or an XMLQUERY or XMLEXISTS expression (SQLSTATE 42822), or any function or query that is not deterministic or that has an external action (SQLSTATE 42845).

### **ORDER BY** (*sort-key-expression*,...)

Defines the ordering of rows within a partition that determines the value of the OLAP function or the meaning of the ROW values in the window-aggregation-group-clause (it does not define the ordering of the query result set).

#### *sort-key-expression*

An expression used in defining the ordering of the rows within a window partition. Each column name referenced in a *sort-key-expression* must unambiguously reference a column of the result set of the subselect, including the OLAP function (SQLSTATE 42702 or 42703). A *sort-key-expression* cannot

include a scalar fullselect or an XMLQUERY or XMLEXISTS expression (SQLSTATE 42822), or any function or query that is not deterministic or that has an external action (SQLSTATE 42845). This clause is required for the RANK and DENSE\_RANK functions (SQLSTATE 42601).

**ASC**

Uses the values of the sort-key-expression in ascending order.

**DESC**

Uses the values of the sort-key-expression in descending order.

**NULLS FIRST**

The window ordering considers null values *before* all non-null values in the sort order.

**NULLS LAST**

The window ordering considers null values *after* all non-null values in the sort order.

**ORDER OF *table-designator***

Specifies that the same ordering used in *table-designator* should be applied to the result table of the subselect. There must be a table reference matching *table-designator* in the FROM clause of the subselect that specifies this clause (SQLSTATE 42703). The subselect (or fullselect) corresponding to the specified *table-designator* must include an ORDER BY clause that is dependant on the data (SQLSTATE 428FI). The ordering that is applied is the same as if the columns of the ORDER BY clause in the nested subselect (or fullselect) were included in the outer subselect (or fullselect), and these columns were specified in place of the ORDER OF clause.

**window-aggregation-group-clause**

The aggregation group of a row R is a set of rows defined in relation to R (in the ordering of the rows of R's partition). This clause specifies the aggregation group. If this clause is not specified, the default is the same as RANGE BETWEEN UNBOUNDED PRECEDING AND CURRENT ROW, providing a cumulative aggregation result.

If window-order-clause is specified, the default behavior is different when window-aggregation-group-clause is not specified. The window aggregation group consists of all rows of the partition of R that precede R or that are peers of R in the window ordering of the window partition defined by the window-order-clause.

**ROWS**

Indicates the aggregation group is defined by counting rows.

**RANGE**

Indicates the aggregation group is defined by an offset from a sort key.

**group-start**

Specifies the starting point for the aggregation group. The aggregation group end is the current row. Specification of the group-start clause is equivalent to a group-between clause of the form "BETWEEN group-start AND CURRENT ROW".

**group-between**

Specifies the aggregation group start and end based on either ROWS or RANGE.

**group-end**

Specifies the ending point for the aggregation group. The aggregation

group start is the current row. Specification of the group-end clause is equivalent to a group-between clause of the form "BETWEEN CURRENT ROW AND group-end".

### UNBOUNDED PRECEDING

Includes the entire partition preceding the current row. This can be specified with either ROWS or RANGE. Also, this can be specified with multiple sort-key-expressions in the window-order-clause.

### UNBOUNDED FOLLOWING

Includes the entire partition following the current row. This can be specified with either ROWS or RANGE. Also, this can be specified with multiple sort-key-expressions in the window-order-clause.

### CURRENT ROW

Specifies the start or end of the aggregation group based on the current row. If ROWS is specified, the current row is the aggregation group boundary. If RANGE is specified, the aggregation group boundary includes the set of rows with the same values for the *sort-key-expressions* as the current row. This clause cannot be specified in *group-bound2* if *group-bound1* specifies *value* FOLLOWING.

### *value* PRECEDING

Specifies either the range or number of rows preceding the current row. If ROWS is specified, then *value* is a positive integer indicating a number of rows. If RANGE is specified, then the data type of *value* must be comparable to the type of the sort-key-expression of the window-order-clause. There can only be one sort-key-expression, and the data type of the sort-key-expression must allow subtraction. This clause cannot be specified in *group-bound2* if *group-bound1* is CURRENT ROW or *value* FOLLOWING.

### *value* FOLLOWING

Specifies either the range or number of rows following the current row. If ROWS is specified, then *value* is a positive integer indicating a number of rows. If RANGE is specified, then the data type of *value* must be comparable to the type of the sort-key-expression of the window-order-clause. There can only be one sort-key-expression, and the data type of the sort-key-expression must allow addition.

### Examples:

- Display the ranking of employees, in order by surname, according to their total salary (based on salary plus bonus) that have a total salary more than \$30,000.

```
SELECT EMPNO, LASTNAME, FIRSTNAME, SALARY+BONUS AS TOTAL_SALARY,  
       RANK() OVER (ORDER BY SALARY+BONUS DESC) AS RANK_SALARY  
FROM EMPLOYEE WHERE SALARY+BONUS > 30000  
ORDER BY LASTNAME
```

Note that if the result is to be ordered by the ranking, then replace ORDER BY LASTNAME with:

```
ORDER BY RANK_SALARY
```

or

```
ORDER BY RANK() OVER (ORDER BY SALARY+BONUS DESC)
```

- Rank the departments according to their average total salary.

```

SELECT WORKDEPT, AVG(SALARY+BONUS) AS AVG_TOTAL_SALARY,
       RANK() OVER (ORDER BY AVG(SALARY+BONUS) DESC) AS RANK_AVG_SAL
FROM EMPLOYEE
GROUP BY WORKDEPT
ORDER BY RANK_AVG_SAL

```

- Rank the employees within a department according to their education level. Having multiple employees with the same rank in the department should not increase the next ranking value.

```

SELECT WORKDEPT, EMPNO, LASTNAME, FIRSTNAME, EDLEVEL,
       DENSE_RANK() OVER
       (PARTITION BY WORKDEPT ORDER BY EDLEVEL DESC) AS RANK_EDLEVEL
FROM EMPLOYEE
ORDER BY WORKDEPT, LASTNAME

```

- Provide row numbers in the result of a query.

```

SELECT ROW_NUMBER() OVER (ORDER BY WORKDEPT, LASTNAME) AS NUMBER,
       LASTNAME, SALARY
FROM EMPLOYEE
ORDER BY WORKDEPT, LASTNAME

```

- List the top five wage earners.

```

SELECT EMPNO, LASTNAME, FIRSTNAME, TOTAL_SALARY, RANK_SALARY
FROM (SELECT EMPNO, LASTNAME, FIRSTNAME, SALARY+BONUS AS TOTAL_SALARY,
       RANK() OVER (ORDER BY SALARY+BONUS DESC) AS RANK_SALARY
FROM EMPLOYEE) AS RANKED_EMPLOYEE
WHERE RANK_SALARY < 6
ORDER BY RANK_SALARY

```

Note that a nested table expression was used to first compute the result, including the rankings, before the rank could be used in the WHERE clause. A common table expression could also have been used.

#### Related reference:

- “Identifiers” on page 57

## Method invocation

### method-invocation:

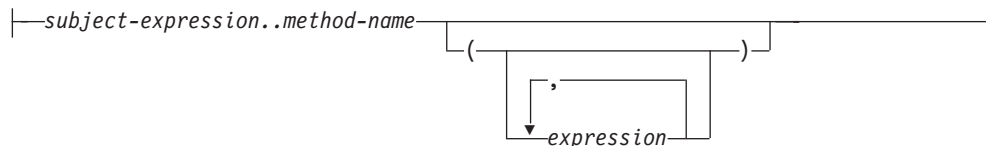

Both system-generated observer and mutator methods, as well as user-defined methods are invoked using the double-dot operator.

#### *subject-expression*

An expression with a static result type that is a user-defined structured type.

#### *method-name*

The unqualified name of a method. The static type of *subject-expression* or one of its supertypes must include a method with the specified name.

#### *(expression,...)*

The arguments of *method-name* are specified within parentheses. Empty parentheses can be used to indicate that there are no arguments. The *method-name* and the data types of the specified argument expressions are used to resolve to the specific method, based on the static type of *subject-expression*.

The double-dot operator used for method invocation is a high precedence left to right infix operator. For example, the following two expressions are equivalent:

`a..b..c + x..y..z`

and

`((a..b)..c) + ((x..y)..z)`

If a method has no parameters other than its subject, it can be invoked with or without parentheses. For example, the following two expressions are equivalent:

`point1..x`  
`point1..x()`

Null subjects in method calls are handled as follows:

- If a system-generated mutator method is invoked with a null subject, an error results (SQLSTATE 2202D)
- If any method other than a system-generated mutator is invoked with a null subject, the method is not executed, and its result is null. This rule includes user-defined methods with SELF AS RESULT.

When a database object (a package, view, or trigger, for example) is created, the best fit method that exists for each of its method invocations is found.

**Note:** Methods of types defined WITH FUNCTION ACCESS can also be invoked using the regular function notation. Function resolution considers all functions, as well as methods with function access as candidate functions. However, functions cannot be invoked using method invocation. Method resolution considers all methods and does not consider functions as candidate methods. Failure to resolve to an appropriate function or method results in an error (SQLSTATE 42884).

### Example:

- Use the double-dot operator to invoke a method called AREA. Assume the existence of a table called RINGS, with a column CIRCLE\_COL of structured type CIRCLE. Also, assume that the method AREA has been defined previously for the CIRCLE type as AREA() RETURNS DOUBLE.

```
SELECT CIRCLE_COL..AREA() FROM RINGS
```

### Related reference:

- “Methods” on page 165

# Subtype treatment

### subtype-treatment:

```
|—TREAT—(—expression—AS—data-type—)|
```

The *subtype-treatment* is used to cast a structured type expression into one of its subtypes. The static type of *expression* must be a user-defined structured type, and that type must be the same type as, or a supertype of, *data-type*. If the type name in *data-type* is unqualified, the SQL path is used to resolve the type reference. The static type of the result of *subtype-treatment* is *data-type*, and the value of the *subtype-treatment* is the value of the expression. At run time, if the dynamic type of the expression is not *data-type* or a subtype of *data-type*, an error is returned (SQLSTATE 0D000).

### Example:

- If an application knows that all column object instances in a column CIRCLE\_COL have the dynamic type COLOREDCIRCLE, use the following query to invoke the method RGB on such objects. Assume the existence of a table called RINGS, with a column CIRCLE\_COL of structured type CIRCLE. Also, assume that COLOREDCIRCLE is a subtype of CIRCLE and that the method RGB has been defined previously for COLOREDCIRCLE as RGB() RETURNS DOUBLE.

```
SELECT TREAT (CIRCLE_COL AS COLOREDCIRCLE)..RGB()  
FROM RINGS
```

At run time, if there are instances of dynamic type CIRCLE, an error is raised (SQLSTATE 0D000). This error can be avoided by using the TYPE predicate in a CASE expression, as follows:

```
SELECT (CASE  
  WHEN CIRCLE_COL IS OF (COLOREDCIRCLE)  
  THEN TREAT (CIRCLE_COL AS COLOREDCIRCLE)..RGB()  
  ELSE NULL  
END)  
FROM RINGS
```

### Related reference:

- “TYPE predicate” on page 225



## Sequence reference

### sequence-reference:

```
| nextval-expression |
| prevval-expression |
```

### nextval-expression:

```
| NEXT VALUE FOR sequence-name |
```

### prevval-expression:

```
| PREVIOUS VALUE FOR sequence-name |
```

### NEXT VALUE FOR *sequence-name*

A NEXT VALUE expression generates and returns the next value for the sequence specified by *sequence-name*.

### PREVIOUS VALUE FOR *sequence-name*

A PREVIOUS VALUE expression returns the most recently generated value for the specified sequence for a previous statement within the current application process. This value can be referenced repeatedly by using PREVIOUS VALUE expressions that specify the name of the sequence. There may be multiple instances of PREVIOUS VALUE expressions specifying the same sequence name within a single statement; they all return the same value. In a partitioned database environment, a PREVIOUS VALUE expression may not return the most recently generated value.

A PREVIOUS VALUE expression can only be used if a NEXT VALUE expression specifying the same sequence name has already been referenced in the current application process, in either the current or a previous transaction (SQLSTATE 51035).

### Notes:

- A new value is generated for a sequence when a NEXT VALUE expression specifies the name of that sequence. However, if there are multiple instances of a NEXT VALUE expression specifying the same sequence name within a query, the counter for the sequence is incremented only once for each row of the result, and all instances of NEXT VALUE return the same value for a row of the result.
- The same sequence number can be used as a unique key value in two separate tables by referencing the sequence number with a NEXT VALUE expression for the first row (this generates the sequence value), and a PREVIOUS VALUE expression for the other rows (the instance of PREVIOUS VALUE refers to the sequence value most recently generated in the current session), as shown below:

```
INSERT INTO order(orderno, cutno)
VALUES (NEXT VALUE FOR order_seq, 123456);
```

```
INSERT INTO line_item (orderno, partno, quantity)
VALUES (PREVIOUS VALUE FOR order_seq, 987654, 1);
```

- NEXT VALUE and PREVIOUS VALUE expressions can be specified in the following places:

## Sequence reference

- select-statement or SELECT INTO statement (within the select-clause, provided that the statement does not contain a DISTINCT keyword, a GROUP BY clause, an ORDER BY clause, a UNION keyword, an INTERSECT keyword, or EXCEPT keyword)
- INSERT statement (within a VALUES clause)
- INSERT statement (within the select-clause of the fullselect)
- UPDATE statement (within the SET clause (either a searched or a positioned UPDATE statement), except that NEXT VALUE cannot be specified in the select-clause of the fullselect of an expression in the SET clause)
- SET Variable statement (except within the select-clause of the fullselect of an expression; a NEXT VALUE expression can be specified in a trigger, but a PREVIOUS VALUE expression cannot)
- VALUES INTO statement (within the select-clause of the fullselect of an expression)
- CREATE PROCEDURE statement (within the routine-body of an SQL procedure)
- CREATE TRIGGER statement within the triggered-action (a NEXT VALUE expression may be specified, but a PREVIOUS VALUE expression cannot)
- NEXT VALUE and PREVIOUS VALUE expressions cannot be specified (SQLSTATE 428F9) in the following places:
  - Join condition of a full outer join
  - DEFAULT value for a column in a CREATE or ALTER TABLE statement
  - Generated column definition in a CREATE OR ALTER TABLE statement
  - Summary table definition in a CREATE TABLE or ALTER TABLE statement
  - Condition of a CHECK constraint
  - CREATE TRIGGER statement (a NEXT VALUE expression may be specified, but a PREVIOUS VALUE expression cannot)
  - CREATE VIEW statement
  - CREATE METHOD statement
  - CREATE FUNCTION statement
  - An argument list of an XMLQUERY, XMLEXISTS, or XMLTABLE expression
- In addition, a NEXT VALUE expression cannot be specified (SQLSTATE 428F9) in the following places:
  - CASE expression
  - Parameter list of an aggregate function
  - Subquery in a context other than those explicitly allowed above
  - SELECT statement for which the outer SELECT contains a DISTINCT operator
  - Join condition of a join
  - SELECT statement for which the outer SELECT contains a GROUP BY clause
  - SELECT statement for which the outer SELECT is combined with another SELECT statement using the UNION, INTERSECT, or EXCEPT set operator
  - Nested table expression
  - Parameter list of a table function
  - WHERE clause of the outer-most SELECT statement, or a DELETE or UPDATE statement
  - ORDER BY clause of the outer-most SELECT statement

- select-clause of the fullselect of an expression, in the SET clause of an UPDATE statement
- IF, WHILE, DO ... UNTIL, or CASE statement in an SQL routine
- When a value is generated for a sequence, that value is consumed, and the next time that a value is requested, a new value will be generated. This is true even when the statement containing the NEXT VALUE expression fails or is rolled back.

If an INSERT statement includes a NEXT VALUE expression in the VALUES list for the column, and if an error occurs at some point during the execution of the INSERT (it could be a problem in generating the next sequence value, or a problem with the value for another column), then an insertion failure occurs (SQLSTATE 23505), and the value generated for the sequence is considered to be consumed. In some cases, reissuing the same INSERT statement might lead to success.

For example, consider an error that is the result of the existence of a unique index for the column for which NEXT VALUE was used and the sequence value generated already exists in the index. It is possible that the next value generated for the sequence is a value that does not exist in the index and so the subsequent INSERT would succeed.

- If in generating a value for a sequence, the maximum value for the sequence is exceeded (or the minimum value for a descending sequence) and cycles are not permitted, then an error occurs (SQLSTATE 23522). In this case, the user could ALTER the sequence to extend the range of acceptable values, or enable cycles for the sequence, or DROP and CREATE a new sequence with a different data type that has a larger range of values.

For example, a sequence may have been defined with a data type of SMALLINT, and eventually the sequence runs out of assignable values. DROP and re-create the sequence with the new definition to redefine the sequence as INTEGER.

- A reference to a NEXT VALUE expression in the select statement of a cursor refers to a value that is generated for a row of the result table. A sequence value is generated for a NEXT VALUE expression for each row that is fetched from the database. If blocking is done at the client, the values may have been generated at the server prior to the processing of the FETCH statement. This can occur when there is blocking of the rows of the result table. If the client application does not explicitly FETCH all the rows that the database has materialized, then the application will not see the results of all the generated sequence values (for the materialized rows that were not returned).
- A reference to a PREVIOUS VALUE expression in the select statement of a cursor refers to a value that was generated for the specified sequence prior to the opening of the cursor. However, closing the cursor can affect the values returned by PREVIOUS VALUE for the specified sequence in subsequent statements, or even for the same statement in the event that the cursor is reopened. This would be the case when the select statement of the cursor included a reference to NEXT VALUE for the same sequence name.
- *Compatibilities*
  - For compatibility with previous versions of DB2:
    - NEXTVAL and PREVVAl can be specified in place of NEXT VALUE and PREVIOUS VALUE.

### Examples:

Assume that there is a table called "order", and that a sequence called "order\_seq" is created as follows:

## Sequence reference

```
CREATE SEQUENCE order_seq
  START WITH 1
  INCREMENT BY 1
  NO MAXVALUE
  NO CYCLE
  CACHE 24
```

Following are some examples of how to generate an "order\_seq" sequence number with a NEXT VALUE expression:

```
INSERT INTO order(orderno, custno)
  VALUES (NEXT VALUE FOR order_seq, 123456);
```

or

```
UPDATE order
  SET orderno = NEXT VALUE FOR order_seq
  WHERE custno = 123456;
```

or

```
VALUES NEXT VALUE FOR order_seq INTO :hv_seq;
```

---

## Predicates

### Predicates

A *predicate* specifies a condition that is true, false, or unknown about a given row or group.

The following rules apply to all types of predicates:

- All values specified in a predicate must be compatible.
- An expression used in a basic, quantified, IN, or BETWEEN predicate must not result in a character string with a length attribute greater than 4 000, a graphic string with a length attribute greater than 2 000, or a LOB string of any size.
- The value of a host variable can be null (that is, the variable may have a negative indicator variable).
- The code page conversion of operands of predicates involving two or more operands, with the exception of LIKE, is done according to the rules for string conversions.
- Use of a DATALINK value is limited to the NULL predicate.
- Use of a structured type value is limited to the NULL predicate and the TYPE predicate.
- In a Unicode database, all predicates that accept a character or graphic string will accept any string type for which conversion is supported.

A fullselect is a form of the SELECT statement that, when used in a predicate, is also called a *subquery*.

**Related reference:**

- “Fullselect” on page 543
- “Rules for string conversions” on page 120

## Search conditions

**search-condition:**

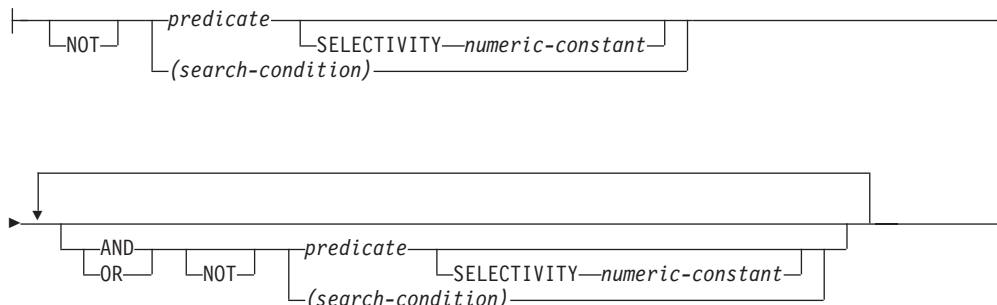

A search condition specifies a condition that is “true,” “false,” or “unknown” about a given row.

The result of a search condition is derived by application of the specified *logical operators* (AND, OR, NOT) to the result of each specified predicate. If logical operators are not specified, the result of the search condition is the result of the specified predicate.

AND and OR are defined in Table 14, in which P and Q are any predicates:

Table 14. Truth Tables for AND and OR

| P       | Q       | P AND Q | P OR Q  |
|---------|---------|---------|---------|
| True    | True    | True    | True    |
| True    | False   | False   | True    |
| True    | Unknown | Unknown | True    |
| False   | True    | False   | True    |
| False   | False   | False   | False   |
| False   | Unknown | False   | Unknown |
| Unknown | True    | Unknown | True    |
| Unknown | False   | False   | Unknown |
| Unknown | Unknown | Unknown | Unknown |

NOT(true) is false, NOT(false) is true, and NOT(unknown) is unknown.

Search conditions within parentheses are evaluated first. If the order of evaluation is not specified by parentheses, NOT is applied before AND, and AND is applied before OR. The order in which operators at the same precedence level are evaluated is undefined to allow for optimization of search conditions.

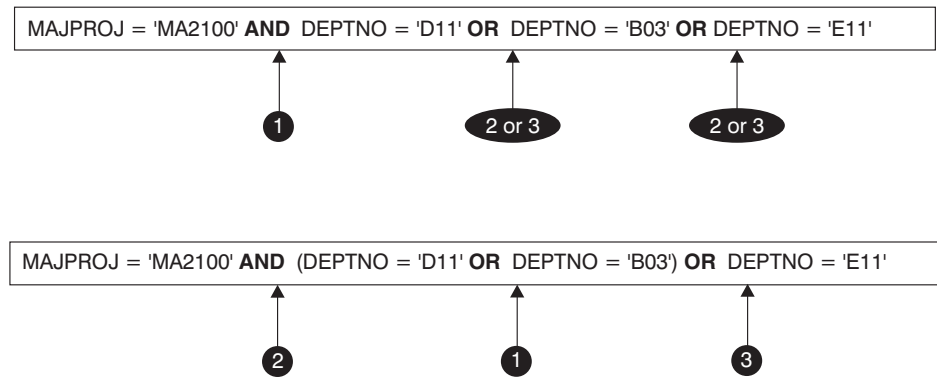

Figure 12. Search Conditions Evaluation Order

### SELECTIVITY *value*

The SELECTIVITY clause is used to indicate to DB2 what the expected selectivity percentage is for the predicate. SELECTIVITY can be specified only when the predicate is a user-defined predicate.

A user-defined predicate is a predicate that consists of a user-defined function invocation, in the context of a predicate specification that matches the predicate specification on the PREDICATES clause of CREATE FUNCTION. For example, if the function foo is defined with PREDICATES WHEN=1..., then the following use of SELECTIVITY is valid:

```
SELECT *
FROM STORES
WHERE foo(parm,parm) = 1 SELECTIVITY 0.004
```

The selectivity value must be a numeric literal value in the inclusive range from 0 to 1 (SQLSTATE 42615). If SELECTIVITY is not specified, the default value is 0.01 (that is, the user-defined predicate is expected to filter out all but one percent of all the rows in the table). The SELECTIVITY default can be changed for any given function by updating its SELECTIVITY column in the SYSSTAT.ROUTINES view. An error will be returned if the SELECTIVITY clause is specified for a non user-defined predicate (SQLSTATE 428E5).

A user-defined function (UDF) can be applied as a user-defined predicate and, hence, is potentially applicable for index exploitation if:

- the predicate specification is present in the CREATE FUNCTION statement
- the UDF is invoked in a WHERE clause being compared (syntactically) in the same way as specified in the predicate specification
- there is no negation (NOT operator)

### Examples:

In the following query, the within UDF specification in the WHERE clause satisfies all three conditions and is considered a user-defined predicate.

```
SELECT *
FROM customers
WHERE within(location, :sanJose) = 1 SELECTIVITY 0.2
```

However, the presence of within in the following query is not index-exploitable due to negation and is not considered a user-defined predicate.

## Search conditions

```
SELECT *
  FROM customers
 WHERE NOT(within(location, :sanJose) = 1) SELECTIVITY 0.3
```

In the next example, consider identifying customers and stores that are within a certain distance of each other. The distance from one store to another is computed by the radius of the city in which the customers live.

```
SELECT *
  FROM customers, stores
 WHERE distance(customers.loc, stores.loc) <
        CityRadius(stores.loc) SELECTIVITY 0.02
```

In the above query, the predicate in the WHERE clause is considered a user-defined predicate. The result produced by CityRadius is used as a search argument to the range producer function.

However, since the result produced by CityRadius is used as a range producer function, the above user-defined predicate will not be able to make use of the index extension defined on the stores.loc column. Therefore, the UDF will make use of only the index defined on the customers.loc column.

### Related reference:

- “CREATE FUNCTION (External Scalar) statement” in *SQL Reference, Volume 2*

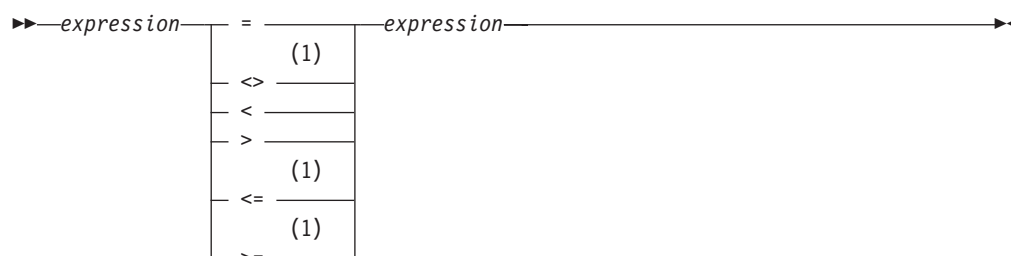

## Basic predicate

**Notes:**

- 1 The following forms of the comparison operators are also supported in basic and quantified predicates:  $\wedge=$ ,  $\wedge<$ ,  $\wedge>$ ,  $\wedge\neq$ ,  $\wedge!<$ , and  $\wedge!>$ . In code pages 437, 819, and 850, the forms  $\neg=$ ,  $\neg<$ , and  $\neg>$  are supported.

All of these product-specific forms of the comparison operators are intended only to support existing SQL that uses these operators, and are not recommended for use when writing new SQL statements.

A *basic predicate* compares two values.

If the value of either operand is null, the result of the predicate is unknown. Otherwise the result is either true or false.

For values  $x$  and  $y$ :

| <b>Predicate</b> | <b>Is True If and Only If...</b>    |
|------------------|-------------------------------------|
| $x = y$          | $x$ is equal to $y$                 |
| $x \neq y$       | $x$ is not equal to $y$             |
| $x < y$          | $x$ is less than $y$                |
| $x > y$          | $x$ is greater than $y$             |
| $x \geq y$       | $x$ is greater than or equal to $y$ |
| $x \leq y$       | $x$ is less than or equal to $y$    |

**Examples:**

```
EMPNO='528671'
SALARY < 20000
PRSTAFF <> :VAR1
SALARY > (SELECT AVG(SALARY) FROM EMPLOYEE)
```

## Quantified predicate

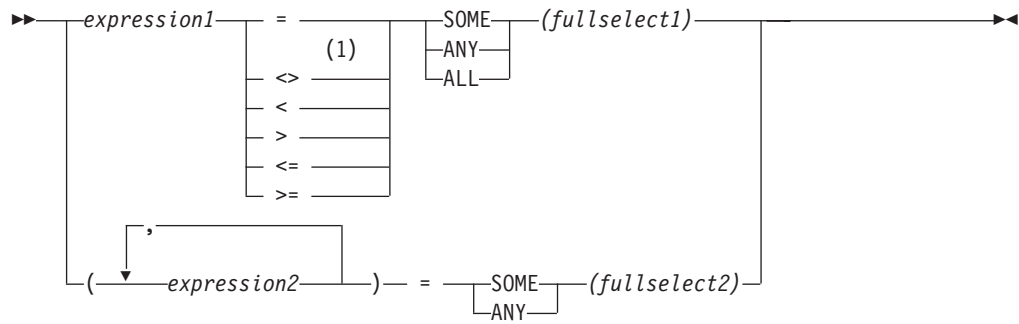

### Notes:

- 1 The following forms of the comparison operators are also supported in basic and quantified predicates: `^=`, `^<`, `^>`, `!=`, `!<`, and `!>`. In code pages 437, 819, and 850, the forms `¬=`, `¬<`, and `¬>` are supported.

All of these product-specific forms of the comparison operators are intended only to support existing SQL that uses these operators, and are not recommended for use when writing new SQL statements.

A *quantified predicate* compares a value or values with a collection of values.

The fullselect must identify a number of columns that is the same as the number of expressions specified to the left of the predicate operator (SQLSTATE 428C4). The fullselect may return any number of rows.

When ALL is specified:

- The result of the predicate is true if the fullselect returns no values or if the specified relationship is true for every value returned by the fullselect.
- The result is false if the specified relationship is false for at least one value returned by the fullselect.
- The result is unknown if the specified relationship is not false for any values returned by the fullselect and at least one comparison is unknown because of the null value.

When SOME or ANY is specified:

- The result of the predicate is true if the specified relationship is true for each value of at least one row returned by the fullselect.
- The result is false if the fullselect returns no rows or if the specified relationship is false for at least one value of every row returned by the fullselect.
- The result is unknown if the specified relationship is not true for any of the rows and at least one comparison is unknown because of a null value.

Examples: Use the following tables when referring to the following examples.

| TBLAB: |      |
|--------|------|
| COLA   | COLB |
| 1      | 12   |
| 2      | 12   |
| 3      | 13   |
| 4      | 14   |
| -      | -    |

| TBLXY: |      |
|--------|------|
| COLX   | COLY |
| 2      | 22   |
| 3      | 23   |

Figure 13.

Example 1

```
SELECT COLA FROM TBLAB
WHERE COLA = ANY(SELECT COLX FROM TBLXY)
```

Results in 2,3. The subselect returns (2,3). COLA in rows 2 and 3 equals at least one of these values.

Example 2

```
SELECT COLA FROM TBLAB
WHERE COLA > ANY(SELECT COLX FROM TBLXY)
```

Results in 3,4. The subselect returns (2,3). COLA in rows 3 and 4 is greater than at least one of these values.

Example 3

```
SELECT COLA FROM TBLAB
WHERE COLA > ALL(SELECT COLX FROM TBLXY)
```

Results in 4. The subselect returns (2,3). COLA in row 4 is the only one that is greater than both these values.

Example 4

```
SELECT COLA FROM TBLAB
WHERE COLA > ALL(SELECT COLX FROM TBLXY
WHERE COLX<0)
```

Results in 1,2,3,4, null. The subselect returns no values. Thus, the predicate is true for all rows in TBLAB.

Example 5

```
SELECT * FROM TBLAB
WHERE (COLA,COLB+10) = SOME (SELECT COLX, COLY FROM TBLXY)
```

The subselect returns all entries from TBLXY. The predicate is true for the subselect, hence the result is as follows:

| COLA | COLB |
|------|------|
| 2    | 12   |
| 3    | 13   |

Example 6

```
SELECT * FROM TBLAB
WHERE (COLA,COLB) = ANY (SELECT COLX,COLY-10 FROM TBLXY)
```

## Quantified predicate

The subselect returns COLX and COLY-10 from TBLXY. The predicate is true for the subselect, hence the result is as follows:

| COLA | COLB |
|------|------|
| 2    | 12   |
| 3    | 13   |

## BETWEEN predicate

$\rightarrow$  *expression* NOT BETWEEN *expression* AND *expression*  $\rightarrow$

The BETWEEN predicate compares a value with a range of values.

The BETWEEN predicate:

`value1 BETWEEN value2 AND value3`

is equivalent to the search condition:

`value1 >= value2 AND value1 <= value3`

The BETWEEN predicate:

`value1 NOT BETWEEN value2 AND value3`

is equivalent to the search condition:

`NOT(value1 BETWEEN value2 AND value3);` that is,  
`value1 < value2 OR value1 > value3.`

The first operand (expression) cannot include a function that is variant or has an external action (SQLSTATE 426804).

Given a mixture of datetime values and string representations of datetime values, all values are converted to the data type of the datetime operand.

### Examples:

#### Example 1

`EMPLOYEE.SALARY BETWEEN 20000 AND 40000`

Results in all salaries between \$20,000.00 and \$40,000.00.

#### Example 2

`SALARY NOT BETWEEN 20000 + :HV1 AND 40000`

Assuming :HV1 is 5000, results in all salaries below \$25,000.00 and above \$40,000.00.

### EXISTS predicate

►►—EXISTS—(*fullselect*)—◄◄

The EXISTS predicate tests for the existence of certain rows.

The fullselect may specify any number of columns, and

- The result is true only if the number of rows specified by the fullselect is not zero.
- The result is false only if the number of rows specified is zero
- The result cannot be unknown.

**Example:**

```
EXISTS (SELECT * FROM TEMPL WHERE SALARY < 10000)
```

## IN predicate

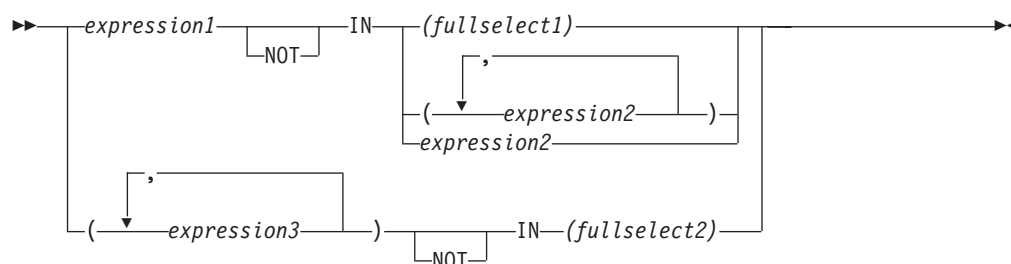

The IN predicate compares a value or values with a collection of values.

The fullselect must identify a number of columns that is the same as the number of expressions specified to the left of the IN keyword (SQLSTATE 428C4). The fullselect may return any number of rows.

- An IN predicate of the form:

expression **IN** expression

is equivalent to a basic predicate of the form:

expression = expression

- An IN predicate of the form:

expression **IN** (fullselect)

is equivalent to a quantified predicate of the form:

expression = **ANY** (fullselect)

- An IN predicate of the form:

expression **NOT IN** (fullselect)

is equivalent to a quantified predicate of the form:

expression <> **ALL** (fullselect)

- An IN predicate of the form:

expression **IN** (expressiona, expressionb, ..., expressionk)

is equivalent to:

expression = **ANY** (fullselect)

where fullselect in the values-clause form is:

**VALUES** (expressiona), (expressionb), ..., (expressionk)

- An IN predicate of the form:

(expressiona, expressionb, ..., expressionk) **IN** (fullselect)

is equivalent to a quantified predicate of the form:

(expressiona, expressionb, ..., expressionk) = **ANY** (fullselect)

The values for *expression1* and *expression2* or the column of *fullselect1* in the IN predicate must be compatible. Each *expression3* value and its corresponding column of *fullselect2* in the IN predicate must be compatible. The rules for result data types can be used to determine the attributes of the result used in the comparison.

## IN predicate

The values for the expressions in the IN predicate (including corresponding columns of a fullselect) can have different code pages. If a conversion is necessary, the code page is determined by applying rules for string conversions to the IN list first, and then to the predicate, using the derived code page for the IN list as the second operand.

### Examples:

*Example 1:* The following evaluates to true if the value in the row under evaluation in the DEPTNO column contains D01, B01, or C01:

```
DEPTNO IN ('D01', 'B01', 'C01')
```

*Example 2:* The following evaluates to true only if the EMPNO (employee number) on the left side matches the EMPNO of an employee in department E11:

```
EMPNO IN (SELECT EMPNO FROM EMPLOYEE WHERE WORKDEPT = 'E11')
```

*Example 3:* Given the following information, this example evaluates to true if the specific value in the row of the COL\_1 column matches any of the values in the list:

Table 15. IN Predicate example

| Expressions | Type          | Code Page |
|-------------|---------------|-----------|
| COL_1       | column        | 850       |
| HV_2        | host variable | 437       |
| HV_3        | host variable | 437       |
| CON_1       | constant      | 850       |

When evaluating the predicate:

```
COL_1 IN (:HV_2, :HV_3, CON_4)
```

the two host variables will be converted to code page 850, based on the rules for string conversions.

*Example 4:* The following evaluates to true if the specified year in EMENDATE (the date an employee activity on a project ended) matches any of the values specified in the list (the current year or the two previous years):

```
YEAR(EMENDATE) IN (YEAR(CURRENT DATE),  
YEAR(CURRENT DATE - 1 YEAR),  
YEAR(CURRENT DATE - 2 YEARS))
```

*Example 5:* The following evaluates to true if both ID and DEPT on the left side match MANAGER and DEPTNUMB respectively for any row of the ORG table.

```
(ID, DEPT) IN (SELECT MANAGER, DEPTNUMB FROM ORG)
```

### Related reference:

- “Rules for result data types” on page 116
- “Rules for string conversions” on page 120



## LIKE predicate

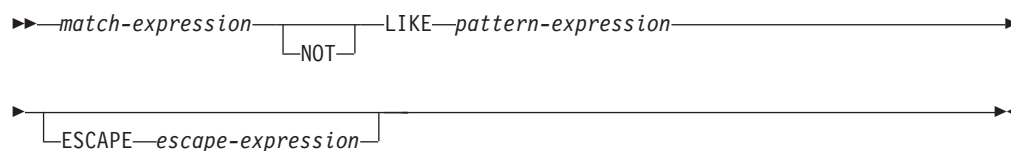

The LIKE predicate searches for strings that have a certain pattern. The pattern is specified by a string in which the underscore and the percent sign may have special meanings. Trailing blanks in a pattern are part of the pattern.

If the value of any of the arguments is null, the result of the LIKE predicate is unknown.

The values for *match-expression*, *pattern-expression*, and *escape-expression* are compatible string expressions. There are slight differences in the types of string expressions supported for each of the arguments. The valid types of expressions are listed under the description of each argument.

None of the expressions can yield a distinct type. However, it can be a function that casts a distinct type to its source type.

### *match-expression*

An expression that specifies the string that is to be examined to see if it conforms to a certain pattern of characters.

The expression can be specified by:

- A constant
- A special register
- A host variable (including a locator variable or a file reference variable)
- A scalar function
- A large object locator
- A column name
- An expression concatenating any of the above

### *pattern-expression*

An expression that specifies the string that is to be matched.

The expression can be specified by:

- A constant
- A special register
- A host variable
- A scalar function whose operands are any of the above
- An expression concatenating any of the above
- An SQL procedure parameter

with the following restrictions:

- No element in the expression can be of type LONG VARCHAR, CLOB, LONG VARGRAPHIC, or DBCLOB. In addition it cannot be a BLOB file reference variable.
- The actual length of *pattern-expression* cannot be more than 32 672 bytes.

The following are examples of invalid string expressions or strings:

## LIKE predicate

- SQL user-defined function parameters
- Trigger transition variables
- Local variables in dynamic compound statements

A **simple description** of the use of the LIKE predicate is that the pattern is used to specify the conformance criteria for values in the *match-expression*, where:

- The underscore character (`_`) represents any single character.
- The percent sign (`%`) represents a string of zero or more characters.
- Any other character represents itself.

If the *pattern-expression* needs to include either the underscore or the percent character, the *escape-expression* is used to specify a character to precede either the underscore or the percent character in the pattern.

A **rigorous description** of the use of the LIKE predicate follows. Note that this description ignores the use of the *escape-expression*; its use is covered later.

- Let  $m$  denote the value of *match-expression* and let  $p$  denote the value of *pattern-expression*. The string  $p$  is interpreted as a sequence of the minimum number of substring specifiers so each character of  $p$  is part of exactly one substring specifier. A substring specifier is an underscore, a percent sign, or any non-empty sequence of characters other than an underscore or a percent sign.

The result of the predicate is unknown if  $m$  or  $p$  is the null value. Otherwise, the result is either true or false. The result is true if  $m$  and  $p$  are both empty strings or there exists a partitioning of  $m$  into substrings such that:

- A substring of  $m$  is a sequence of zero or more contiguous characters and each character of  $m$  is part of exactly one substring.
- If the  $n$ th substring specifier is an underscore, the  $n$ th substring of  $m$  is any single character.
- If the  $n$ th substring specifier is a percent sign, the  $n$ th substring of  $m$  is any sequence of zero or more characters.
- If the  $n$ th substring specifier is neither an underscore nor a percent sign, the  $n$ th substring of  $m$  is equal to that substring specifier and has the same length as that substring specifier.
- The number of substrings of  $m$  is the same as the number of substring specifiers.

Thus, if  $p$  is an empty string and  $m$  is not an empty string, the result is false. Similarly, it follows that if  $m$  is an empty string and  $p$  is not an empty string (except for a string containing only percent signs), the result is false.

The predicate  $m$  NOT LIKE  $p$  is equivalent to the search condition NOT ( $m$  LIKE  $p$ ).

When the *escape-expression* is specified, the *pattern-expression* must not contain the escape character identified by the *escape-expression*, except when immediately followed by the escape character, the underscore character, or the percent sign character (SQLSTATE 22025).

If the *match-expression* is a character string in an MBCS database, it can contain mixed data. In this case, the pattern can include both SBCS and non-SBCS characters. For non-Unicode databases, the special characters in the pattern are interpreted as follows:

- An SBCS halfwidth underscore refers to one SBCS character.
- A non-SBCS fullwidth underscore refers to one non-SBCS character.
- An SBCS halfwidth or non-SBCS fullwidth percent sign refers to zero or more SBCS or non-SBCS characters.

In a Unicode database, there is really no distinction between "single-byte" and "non-single-byte" characters. Although the UTF-8 format is a "mixed-byte" encoding of Unicode characters, there is no real distinction between SBCS and non-SBCS characters in UTF-8. Every character is a Unicode character, regardless of the number of bytes in UTF-8 format.

In a Unicode graphic column, every non-supplementary character, including the halfwidth underscore character (U+005F) and the halfwidth percent sign character (U+0025), is two bytes in width. In a Unicode database, special characters in a pattern are interpreted as follows:

- For character strings, a halfwidth underscore character (X'5F') or a fullwidth underscore character (X'EFBCBF') refers to one Unicode character, and a halfwidth percent sign character (X'25') or a fullwidth percent sign character (X'EFBC85') refers to zero or more Unicode characters.
- For graphic strings, a halfwidth underscore character (U+005F) or a fullwidth underscore character (U+FF3F) refers to one Unicode character, and a halfwidth percent sign character (U+0025) or a fullwidth percent sign character (U+FF05) refers to zero or more Unicode characters.

You need two underscore characters to match a Unicode supplementary graphic character, because such a character is represented by two UCS-2 characters in a graphic column. However, you only need one underscore character to match a Unicode supplementary character in a character column.

#### *escape-expression*

This optional argument is an expression that specifies a character to be used to modify the special meaning of the underscore (\_) and percent (%) characters in the *pattern-expression*. This allows the LIKE predicate to be used to match values that contain the actual percent and underscore characters.

The expression can be specified by any one of:

- A constant
- A special register
- A host variable
- A scalar function whose operands are any of the above
- An expression concatenating any of the above

with the restrictions that:

- No element in the expression can be of type LONG VARCHAR, CLOB, LONG VARGRAPHIC, or DBCLOB. In addition, it cannot be a BLOB file reference variable.
- For character columns, the result of the expression must be one character, or a binary string containing exactly one byte (SQLSTATE 22019).
- For graphic columns, the result of the expression must be one character (SQLSTATE 22019).

When escape characters are present in the pattern string, an underscore, percent sign, or escape character can represent a literal occurrence of itself.

## LIKE predicate

This is true if the character in question is preceded by an odd number of successive escape characters. It is not true otherwise.

In a pattern, a sequence of successive escape characters is treated as follows:

- Let S be such a sequence, and suppose that S is not part of a larger sequence of successive escape characters. Suppose also that S contains a total of n characters. Then the rules governing S depend on the value of n:
  - If n is odd, S must be followed by an underscore or percent sign (SQLSTATE 22025). S and the character that follows it represent (n-1)/2 literal occurrences of the escape character followed by a literal occurrence of the underscore or percent sign.
  - If n is even, S represents n/2 literal occurrences of the escape character. Unlike the case where n is odd, S could end the pattern. If it does not end the pattern, it can be followed by any character (except, of course, an escape character, which would violate the assumption that S is not part of a larger sequence of successive escape characters). If S is followed by an underscore or percent sign, that character has its special meaning.

Following is an illustration of the effect of successive occurrences of the escape character which, in this case, is the back slash (\).

| Pattern string | Actual Pattern   |
|----------------|--|
| \%             | A percent sign   |
| \\%            | A back slash followed by zero or more arbitrary characters |
| \\\%           | A back slash followed by a percent sign                    |

The code page used in the comparison is based on the code page of the *match-expression* value.

- The *match-expression* value is never converted.
- If the code page of *pattern-expression* is different from the code page of *match-expression*, the value of *pattern-expression* is converted to the code page of *match-expression*, unless either operand is defined as FOR BIT DATA (in which case there is no conversion).
- If the code page of *escape-expression* is different from the code page of *match-expression*, the value of *escape-expression* is converted to the code page of *match-expression*, unless either operand is defined as FOR BIT DATA (in which case there is no conversion).

### Notes:

- The number of trailing blanks is significant in both the *match-expression* and the *pattern-expression*. If the strings are not the same length, the shorter string is not padded with blank spaces. For example, the expression 'PADDED' LIKE 'PADDED' would not result in a match.
- If the pattern specified in a LIKE predicate is a parameter marker, and a fixed-length character host variable is used to replace the parameter marker, the value specified for the host variable must have the correct length. If the correct length is not specified, the select operation will not return the intended results. For example, if the host variable is defined as CHAR(10), and the value WYSE% is assigned to that host variable, the host variable is padded with blanks on assignment. The pattern used is:

```
'WYSE%      '
```

The database manager searches for all values that start with WYSE and that end with five blank spaces. If you want to search only for values that start with 'WYSE', assign a value of 'WSYE%%%%%%%%%' to the host variable.

**Examples:**

- Search for the string 'SYSTEMS' appearing anywhere within the PROJNAME column in the PROJECT table.
 

```
SELECT PROJNAME FROM PROJECT
WHERE PROJECT.PROJNAME LIKE '%SYSTEMS%'
```
- Search for a string with a first character of 'J' that is exactly two characters long in the FIRSTNME column of the EMPLOYEE table.
 

```
SELECT FIRSTNME FROM EMPLOYEE
WHERE EMPLOYEE.FIRSTNME LIKE 'J_'
```
- Search for a string of any length, with a first character of 'J', in the FIRSTNME column of the EMPLOYEE table.
 

```
SELECT FIRSTNME FROM EMPLOYEE
WHERE EMPLOYEE.FIRSTNME LIKE 'J%'
```
- In the CORP\_SERVERS table, search for a string in the LA\_SERVERS column that matches the value in the CURRENT SERVER special register.
 

```
SELECT LA_SERVERS FROM CORP_SERVERS
WHERE CORP_SERVERS.LA_SERVERS LIKE CURRENT SERVER
```
- Retrieve all strings that begin with the character sequence '%\_\' in column A of table T.
 

```
SELECT A FROM T
WHERE T.A LIKE '%\_\\%' ESCAPE '\'
```
- Use the BLOB scalar function to obtain a one-byte escape character that is compatible with the match and pattern data types (both BLOBs).
 

```
SELECT COLBLOB FROM TABLET
WHERE COLBLOB LIKE :pattern_var ESCAPE BLOB(X'0E')
```

## NULL predicate

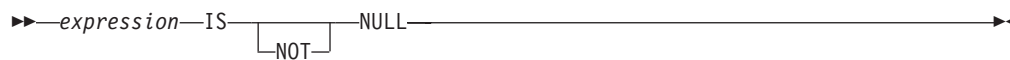

The NULL predicate tests for null values.

The result of a NULL predicate cannot be unknown. If the value of the expression is null, the result is true. If the value is not null, the result is false. If NOT is specified, the result is reversed.

**Examples:**

PHONENO **IS NULL**

SALARY **IS NOT NULL**

## TYPE predicate

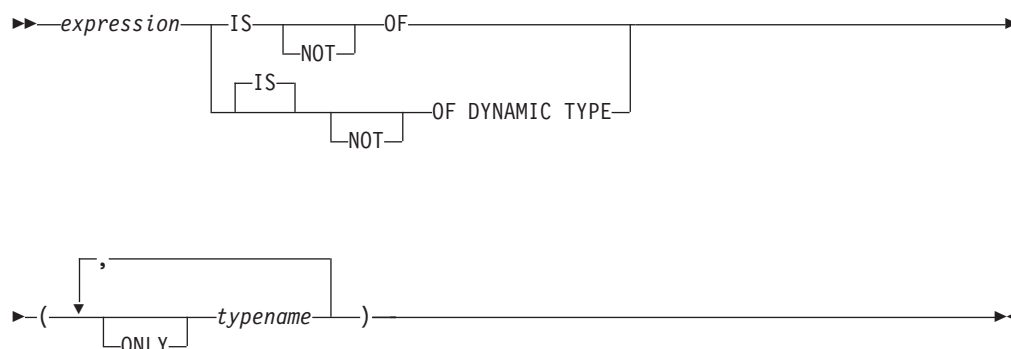

A *TYPE predicate* compares the type of an expression with one or more user-defined structured types.

The dynamic type of an expression involving the dereferencing of a reference type is the actual type of the referenced row from the target typed table or view. This may differ from the target type of an expression involving the reference which is called the static type of the expression.

If the value of *expression* is null, the result of the predicate is unknown. The result of the predicate is true if the dynamic type of the *expression* is a subtype of one of the structured types specified by *typename*, otherwise the result is false. If *ONLY* precedes any *typename* the proper subtypes of that type are not considered.

If *typename* is not qualified, it is resolved using the SQL path. Each *typename* must identify a user-defined type that is in the type hierarchy of the static type of *expression* (SQLSTATE 428DU).

The Deref function should be used whenever the TYPE predicate has an expression involving a reference type value. The static type for this form of *expression* is the target type of the reference.

The syntax IS OF and OF DYNAMIC TYPE are equivalent alternatives for the TYPE predicate. Similarly, IS NOT OF and NOT OF DYNAMIC TYPE are equivalent alternatives.

### Examples:

A table hierarchy exists with root table EMPLOYEE of type EMP and subtable MANAGER of type MGR. Another table, ACTIVITIES, includes a column called WHO\_RESPONSIBLE that is defined as REF(EMP) SCOPE EMPLOYEE. The following is a type predicate that evaluates to true when a row corresponding to WHO\_RESPONSIBLE is a manager:

```
DEREF (WHO_RESPONSIBLE) IS OF (MGR)
```

If a table contains a column EMPLOYEE of type EMP, EMPLOYEE may contain values of type EMP as well as values of its subtypes like MGR. The following predicate

```
EMPL IS OF (MGR)
```

returns true when EMPL is not null and is actually a manager.

## TYPE predicate

### Related reference:

- “DEREF ” on page 322



## VALIDATED predicate

►► *column-name* IS VALIDATED ◀◀

The VALIDATED predicate checks that the value specified by *column-name*, which must have data type XML, has already been validated using the XMLVALIDATE function. The XML schema that was used for validation does not impact the result.

The VALIDATED predicate is only supported in a Unicode database with a single database partition.

If the value of *column-name* is null, the result of the predicate is unknown; otherwise, the result is either true or false. The result of the predicate is true if the value of *column-name* is not null and has been validated. The result of the predicate is false if the value of *column-name* is not null and has not been validated.

### Examples:

*Example 1:* Assume that column XMLCOL is defined in table T1. Retrieve only the XML values that have been validated by any XML schema.

```
SELECT XMLCOL FROM T1
WHERE XMLCOL IS VALIDATED
```

*Example 2:* Assume that column XMLCOL is defined in table T1. Enforce the rule that values cannot be inserted or updated unless they have been validated.

```
ALTER TABLE T1 ADD CONSTRAINT CK_VALIDATED
CHECK (XMLCOL IS VALIDATED)
```

## XMLEXISTS predicate

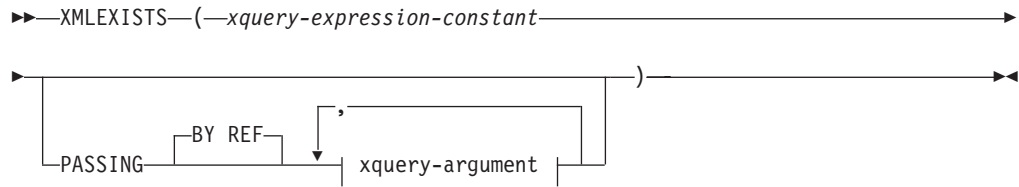

### xquery-argument:

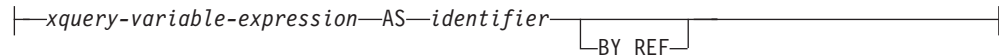

The XMLEXISTS predicate tests whether an XQuery expression returns a sequence of one or more items.

#### *xquery-expression-constant*

Specifies an SQL character string constant that is interpreted as an XQuery expression. The constant string is converted directly to UTF-8 without conversion to the database or section code page. The XQuery expression executes using an optional set of input XML values, and returns an output sequence that is tested to determine the result of the XMLEXISTS predicate. The value for *xquery-expression-constant* must not be an empty string or a string of blank characters (SQLSTATE 10505).

#### PASSING

Specifies input values and the manner in which these values are passed to the XQuery expression specified by *xquery-expression-constant*.

#### BY REF

Specifies that the default passing mechanism is by reference for any *xquery-variable-expression* of data type XML. When XML values are passed by reference, the XQuery evaluation uses the input node trees, if any, directly from the specified input expressions, preserving all properties, including the original node identities and document order. If two arguments pass the same XML value, node identity comparisons and document ordering comparisons involving some nodes contained between the two input arguments might refer to nodes within the same XML node tree.

This clause has no impact on how non-XML values are passed. The non-XML values create a new copy of the value during the cast to XML.

#### xquery-argument

Specifies an argument that is to be passed to the XQuery expression specified by *xquery-expression-constant*. An argument specifies a value and the manner in which that value is to be passed. The argument includes an SQL expression that is evaluated.

- If the resulting value is of type XML, it becomes an *input-xml-value*. A null XML value is converted to an XML empty sequence.
- If the resulting value is not of type XML, it must be castable to the XML data type. A null value is converted to an XML empty sequence. The converted value becomes an *input-xml-value*.

When the *xquery-expression-constant* is evaluated, an XQuery variable is presented with a value equal to *input-xml-value* and a name specified by the AS clause.

*xquery-variable-expression*

Specifies an SQL expression whose value is available to the XQuery expression specified by *xquery-expression-constant* during execution. The expression cannot contain a sequence reference (SQLSTATE 428F9) or an OLAP function (SQLSTATE 42903).

**AS** *identifier*

Specifies that the value generated by *xquery-variable-expression* will be passed to *xquery-expression-constant* as an XQuery variable. The variable name will be *identifier*. The leading dollar sign (\$) that precedes variable names in the XQuery language is not included in *identifier*. The identifier must be a valid XQuery variable name and is restricted to an XML NCName. The identifier must not be greater than 128 bytes in length. Two arguments within the same PASSING clause cannot use the same identifier (SQLSTATE 42711).

**BY REF**

Indicates that an XML input value is to be passed by reference. When XML values are passed by reference, the XQuery evaluation uses the input node trees, if any, directly from the specified input expressions, preserving all properties, including the original node identities and document order. If two arguments pass the same XML value, node identity comparisons and document ordering comparisons involving some nodes contained between the two input arguments might refer to nodes within the same XML node tree. If BY REF is not specified following an *xquery-variable-expression*, XML arguments are passed by way of the default passing mechanism that is provided through the syntax that follows the PASSING keyword. This option cannot be specified for non-XML values. When a non-XML value is passed, the value is converted to XML; this process creates a copy.

**Notes:**

The XMLEXISTS predicate cannot be:

- Part of the ON clause that is associated with a JOIN operator or a MERGE statement (SQLSTATE 42972)
- Part of the GENERATE KEY USING or RANGE THROUGH clause in the CREATE INDEX EXTENSION statement (SQLSTATE 428E3)
- Part of the FILTER USING clause in the CREATE FUNCTION (External Scalar) statement, or the FILTER USING clause in the CREATE INDEX EXTENSION statement (SQLSTATE 428E4)
- Part of a check constraint or a column generation expression (SQLSTATE 42621)
- Part of a group-by-clause (SQLSTATE 42822)
- Part of an argument for a column-function (SQLSTATE 42607)

An XMLEXISTS predicate that involves a subquery might be restricted by statements that restrict subqueries.

The XMLEXISTS predicate can only be used in a Unicode database with a single database partition (SQLSTATE 42997).

**Example:**

## XMLEXISTS predicate

```
SELECT c.custid FROM customer c
WHERE XMLEXISTS('$h/buyHistory/buyItem[ category = "fishing" ]'
PASSING buyHistory AS "h")
```

### Related concepts:

- “XMLEXISTS predicate usage” in *Performance Guide*
- “XMLEXISTS predicate when querying XML data” in *XML Guide*

---

## Chapter 3. Functions

---

### Functions overview

A *function* is an operation that is denoted by a function name followed by a pair of parentheses enclosing the specification of arguments (there may be no arguments).

*Built-in functions* are provided with the database manager; they return a single result value, and are identified as part of the SYSIBM schema. Built-in functions include column functions (such as AVG), operator functions (such as "+"), casting functions (such as DECIMAL), and others (such as SUBSTR).

*User-defined functions* are registered to a database in SYSCAT.ROUTINES (using the CREATE FUNCTION statement). User-defined functions are never part of the SYSIBM schema. One such set of functions is provided with the database manager in a schema called SYSFUN, and another in a schema called SYSPROC.

Functions are classified as aggregate (column) functions, scalar functions, row functions, or table functions.

- The argument of an *column function* is a collection of like values. A column function returns a single value (possibly null), and can be specified in an SQL statement wherever an expression can be used.
- The arguments of a *scalar function* are individual scalar values, which can be of different types and have different meanings. A scalar function returns a single value (possibly null), and can be specified in an SQL statement wherever an expression can be used.
- The argument of a *row function* is a structured type. A row function returns a row of built-in data types and can only be specified as a transform function for a structured type.
- The arguments of a *table function* are individual scalar values, which can be of different types and have different meanings. A table function returns a table to the SQL statement, and can be specified only within the FROM clause of a SELECT statement.

The function name, combined with the schema, gives the fully qualified name of a function. The combination of schema, function name, and input parameters make up a *function signature*.

In some cases, the input parameter type is specified as a specific built-in data type, and in other cases, it is specified through a general variable like *any-numeric-type*. If a particular data type is specified, an exact match will only occur with the specified data type. If a general variable is used, each of the data types associated with that variable results in an exact match.

Additional functions may be available, because user-defined functions can be created in different schemas, using one of the function signatures as a source. You can also create external functions in your applications.

#### Related concepts:

- "Aggregate functions" on page 258

## Functions overview

### Related reference:

- “Functions” on page 157
- “Subselect” on page 506
- “CREATE FUNCTION statement” in *SQL Reference, Volume 2*

## Supported functions and administrative SQL routines and views

Table 16 summarizes information about the supported functions. The function name, combined with the schema, gives the fully qualified name of a function. The “Input” column shows the expected data type for each argument during function invocation. Many of the functions include variations of the input parameters, allowing either different data types or different numbers of arguments to be used. The combination of schema, function name and input parameters makes up a function signature. The “Returns” column shows the possible data types of values returned by the function. For the administrative SQL routines and views, refer to the reference information for the input and return information.

For lists of the supported built-in functions classified by type, see the following tables:

- Aggregate functions (Table 17 on page 250)
- Cast scalar functions (Table 18 on page 251)
- Partitioning scalar functions (Table 19 on page 251)
- Datetime scalar functions (Table 20 on page 252)
- Numeric scalar functions (Table 21 on page 253)
- Security scalar functions (Table 22 on page 254)
- XML functions (Table 23 on page 254)
- String scalar functions (Table 24 on page 255)
- Miscellaneous scalar functions (Table 25 on page 256)

For lists of the supported administrative SQL routines and views classified by functionality, see Supported administrative SQL routines and views. These routines and views are grouped as follows:

- Activity monitor administrative SQL routines
- ADMIN\_CMD stored procedure and associated administrative SQL routines
- Configuration administrative SQL routines and views
- Environment administrative views
- Health snapshot administrative SQL routines
- MQSeries<sup>®</sup> administrative SQL routines
- Security administrative SQL routines and views
- Snapshot administrative SQL routines and views
- SQL procedures administrative SQL routines
- Stepwise redistribute administrative SQL routines
- Storage management tool administrative SQL routines
- Miscellaneous administrative SQL routines and views

Table 16. Supported functions

| Function name                | Schema | Input   | Returns   | Description  |
|------------------------------|--------|---|---|--|
| “ABS or ABSVAL ” on page 280 | SYSIBM | Any expression that returns a built-in numeric data type.   | Same data type and length as the argument.  | This scalar function returns the absolute value of the argument. |
| “ABS or ABSVAL ” on page 280 | SYSFUN | <ul style="list-style-type: none"> <li>• SMALLINT</li> <li>• INTEGER</li> <li>• BIGINT</li> <li>• DOUBLE</li> </ul> | <ul style="list-style-type: none"> <li>• SMALLINT</li> <li>• INTEGER</li> <li>• BIGINT</li> <li>• DOUBLE</li> </ul> | This scalar function returns the absolute value of the argument. |

## Supported functions

Table 16. Supported functions (continued)

| Function name                   | Schema | Input  | Returns   | Description  |
|---------------------------------|--------|--|---|--|
| "ACOS " on page 281             | SYSIBM | • DOUBLE   | • DOUBLE  | This scalar function returns the arccosine of the argument as an angle expressed in radians.   |
| "ASCII " on page 282            | SYSFUN | • CHAR<br>• VARCHAR(4000)<br>• CLOB(1M)  | • INTEGER<br>• INTEGER<br>• INTEGER   | This scalar function returns the ASCII code value of the leftmost character of the argument as an integer.   |
| "ASIN " on page 283             | SYSIBM | • DOUBLE   | • DOUBLE  | This scalar function returns the arcsine of the argument as an angle expressed in radians.   |
| "ATAN " on page 284             | SYSIBM | • DOUBLE   | • DOUBLE  | This scalar function returns the arctangent of the argument as an angle expressed in radians.  |
| "ATANH " on page 286            | SYSIBM | • DOUBLE   | • DOUBLE  | This scalar function returns the hyperbolic arctangent of the argument, where the argument is an angle expressed in radians.   |
| "ATAN2 " on page 285            | SYSIBM | • DOUBLE, DOUBLE   | • DOUBLE  | This scalar function returns the arctangent of $x$ and $y$ coordinates — specified by the first and second arguments — respectively, as an angle expressed in radians. |
| "AVG " on page 259              | SYSIBM | • <i>numeric-type</i> <sup>4</sup>   | • <i>numeric-type</i> <sup>1</sup>  | This aggregate function returns the average of a set of numbers.   |
| "BIGINT " on page 287           | SYSIBM | • <i>numeric-type</i><br>• VARCHAR   | • BIGINT<br>• BIGINT  | This scalar function returns a 64-bit integer representation of a number or a character string in the form of an integer constant.                                     |
| "BLOB " on page 289             | SYSIBM | • <i>string-type</i><br>• <i>string-type</i> , INTEGER   | • BLOB<br>• BLOB  | This scalar function casts from source type to BLOB, with optional length.   |
| "CEILING or CEIL " on page 290  | SYSIBM | • SMALLINT<br>• INTEGER<br>• BIGINT<br>• DOUBLE  | • SMALLINT<br>• INTEGER<br>• BIGINT<br>• DOUBLE   | This scalar function returns the smallest integer that is greater than or equal to the argument.   |
| "CHAR " on page 291             | SYSIBM | • <i>character-type</i><br>• <i>character-type</i> , INTEGER<br>• <i>datetime-type</i><br>• <i>datetime-type</i> , <i>keyword</i> <sup>2</sup><br>• SMALLINT<br>• INTEGER<br>• BIGINT<br>• DECIMAL<br>• DECIMAL, VARCHAR | • CHAR<br>• CHAR( <i>integer</i> )<br>• CHAR<br>• CHAR<br>• CHAR(6)<br>• CHAR(11)<br>• CHAR(20)<br>• CHAR(2+ <i>precision</i> )<br>• CHAR(2+ <i>precision</i> ) | This scalar function returns a string representation of the source type.   |
| "CHAR " on page 291             | SYSFUN | • DOUBLE   | • CHAR(24)  | This scalar function returns a character string representation of a floating-point number.   |
| "CHARACTER_LENGTH " on page 295 | SYSIBM | • <i>string-type</i> , <i>string-unit</i>  | • INTEGER   | This scalar function returns the length of an expression in the specified <i>string-unit</i> .   |



Table 16. Supported functions (continued)

| Function name                        | Schema | Input   | Returns  | Description   |
|--------------------------------------|--------|---|--|---|
| "CHR " on page 297                   | SYSFUN | <ul style="list-style-type: none"> <li>INTEGER</li> </ul>   | <ul style="list-style-type: none"> <li>CHAR(1)</li> </ul>  | This scalar function returns the character that has the ASCII code value specified by the argument. The value of the argument should be between 0 and 255; otherwise, the return value is null. |
| "CLOB " on page 298                  | SYSIBM | <ul style="list-style-type: none"> <li>character-type</li> <li>character-type, INTEGER</li> </ul>           | <ul style="list-style-type: none"> <li>CLOB</li> <li>CLOB</li> </ul>   | This scalar function casts from source type to CLOB, with optional length.  |
| "COALESCE " on page 299 <sup>3</sup> | SYSIBM | <ul style="list-style-type: none"> <li>any-type, any-union-compatible-type,...</li> </ul>                   | <ul style="list-style-type: none"> <li>any-type</li> </ul>   | This scalar function returns the first non-null argument in the set of arguments.   |
| "CONCAT " on page 300                | SYSIBM | <ul style="list-style-type: none"> <li>string-type, compatible-string-type</li> </ul>                       | <ul style="list-style-type: none"> <li>max-string-type</li> </ul>  | This scalar function returns the concatenation of two string arguments.   |
| "CORRELATION " on page 261           | SYSIBM | <ul style="list-style-type: none"> <li>numeric-type, numeric-type</li> </ul>                                | <ul style="list-style-type: none"> <li>DOUBLE</li> </ul>   | This aggregate function returns the coefficient of correlation of a set of number pairs.  |
| "COS " on page 301                   | SYSIBM | <ul style="list-style-type: none"> <li>DOUBLE</li> </ul>  | <ul style="list-style-type: none"> <li>DOUBLE</li> </ul>   | This scalar function returns the cosine of the argument, where the argument is an angle expressed in radians.   |
| "COSH " on page 302                  | SYSIBM | <ul style="list-style-type: none"> <li>DOUBLE</li> </ul>  | <ul style="list-style-type: none"> <li>DOUBLE</li> </ul>   | This scalar function returns the hyperbolic cosine of the argument, where the argument is an angle expressed in radians.  |
| "COT " on page 303                   | SYSIBM | <ul style="list-style-type: none"> <li>DOUBLE</li> </ul>  | <ul style="list-style-type: none"> <li>DOUBLE</li> </ul>   | This scalar function returns the cotangent of the argument, where the argument is an angle expressed in radians.  |
| "COUNT " on page 262                 | SYSIBM | <ul style="list-style-type: none"> <li>any-builtin-type<sup>4</sup></li> </ul>                              | <ul style="list-style-type: none"> <li>INTEGER</li> </ul>  | This aggregate function returns the number of rows or values in a set of rows or values.  |
| "COUNT_BIG " on page 263             | SYSIBM | <ul style="list-style-type: none"> <li>any-builtin-type<sup>4</sup></li> </ul>                              | <ul style="list-style-type: none"> <li>DECIMAL(31,0)</li> </ul>  | This aggregate function returns the number of rows or values in a set of rows or values. The result can be greater than the maximum value of INTEGER.   |
| "COVARIANCE " on page 265            | SYSIBM | <ul style="list-style-type: none"> <li>numeric-type, numeric-type</li> </ul>                                | <ul style="list-style-type: none"> <li>DOUBLE</li> </ul>   | This aggregate function returns the covariance of a set of number pairs.  |
| "DATAPARTITIONNUM " on page 304      | SYSIBM | <ul style="list-style-type: none"> <li>any-type</li> </ul>  | <ul style="list-style-type: none"> <li>INTEGER</li> </ul>  | This scalar function returns the sequence number (SYSDATAPARTITIONS.SEQNO) of the data partition in which the row resides. The argument is any column name within the table.                    |
| "DATE " on page 305                  | SYSIBM | <ul style="list-style-type: none"> <li>DATE</li> <li>TIMESTAMP</li> <li>DOUBLE</li> <li>VARCHAR</li> </ul>  | <ul style="list-style-type: none"> <li>DATE</li> <li>DATE</li> <li>DATE</li> <li>DATE</li> </ul>             | This scalar function returns a date from a single input value.  |
| "DAY " on page 306                   | SYSIBM | <ul style="list-style-type: none"> <li>VARCHAR</li> <li>DATE</li> <li>TIMESTAMP</li> <li>DECIMAL</li> </ul> | <ul style="list-style-type: none"> <li>INTEGER</li> <li>INTEGER</li> <li>INTEGER</li> <li>INTEGER</li> </ul> | This scalar function returns the day part of a value.   |

## Supported functions

Table 16. Supported functions (continued)

| Function name                               | Schema | Input  | Returns  | Description   |
|---|--------|--|--|---|
| "DAYNAME " on page 307                      | SYSFUN | <ul style="list-style-type: none"> <li>• VARCHAR(26)</li> <li>• DATE</li> <li>• TIMESTAMP</li> </ul>   | <ul style="list-style-type: none"> <li>• VARCHAR(100)</li> <li>• VARCHAR(100)</li> <li>• VARCHAR(100)</li> </ul>     | This scalar function returns a mixed case character string containing the name of the day (for example, Friday) for the day portion of the argument, based on what the locale was when db2start was issued. |
| "DAYOFWEEK " on page 308                    | SYSFUN | <ul style="list-style-type: none"> <li>• VARCHAR(26)</li> <li>• DATE</li> <li>• TIMESTAMP</li> </ul>   | <ul style="list-style-type: none"> <li>• INTEGER</li> <li>• INTEGER</li> <li>• INTEGER</li> </ul>                    | This scalar function returns the day of the week in the argument as an integer value in the range 1-7, where 1 represents Sunday.   |
| "DAYOFWEEK_ISO " on page 309                | SYSFUN | <ul style="list-style-type: none"> <li>• VARCHAR(26)</li> <li>• DATE</li> <li>• TIMESTAMP</li> </ul>   | <ul style="list-style-type: none"> <li>• INTEGER</li> <li>• INTEGER</li> <li>• INTEGER</li> </ul>                    | This scalar function returns the day of the week in the argument as an integer value in the range 1-7, where 1 represents Monday.   |
| "DAYOFYEAR " on page 310                    | SYSFUN | <ul style="list-style-type: none"> <li>• VARCHAR(26)</li> <li>• DATE</li> <li>• TIMESTAMP</li> </ul>   | <ul style="list-style-type: none"> <li>• INTEGER</li> <li>• INTEGER</li> <li>• INTEGER</li> </ul>                    | This scalar function returns the day of the year in the argument as an integer value in the range 1-366.  |
| "DAYS " on page 311                         | SYSIBM | <ul style="list-style-type: none"> <li>• VARCHAR</li> <li>• TIMESTAMP</li> <li>• DATE</li> </ul>   | <ul style="list-style-type: none"> <li>• INTEGER</li> <li>• INTEGER</li> <li>• INTEGER</li> </ul>                    | This scalar function returns an integer representation of a date.   |
| "DBCLOB " on page 312                       | SYSIBM | <ul style="list-style-type: none"> <li>• <i>graphic-type</i></li> <li>• <i>graphic-type</i>, INTEGER</li> </ul>  | <ul style="list-style-type: none"> <li>• DBCLOB</li> <li>• DBCLOB</li> </ul>   | This scalar function casts from source type to DBCLOB, with optional length.  |
| "DBPARTITIONNUM " on page 313 <sup>3</sup>  | SYSIBM | <ul style="list-style-type: none"> <li>• <i>any-type</i></li> </ul>  | <ul style="list-style-type: none"> <li>• INTEGER</li> </ul>  | This scalar function returns the database partition number of the row. The argument is any column name within the table.  |
| "DECIMAL " on page 315                      | SYSIBM | <ul style="list-style-type: none"> <li>• <i>numeric-type</i></li> <li>• <i>numeric-type</i>, INTEGER</li> <li>• <i>numeric-type</i> INTEGER, INTEGER</li> </ul>            | <ul style="list-style-type: none"> <li>• DECIMAL</li> <li>• DECIMAL</li> <li>• DECIMAL</li> </ul>                    | This scalar function returns the decimal representation of a number, with optional precision and scale.   |
| "DECIMAL " on page 315                      | SYSIBM | <ul style="list-style-type: none"> <li>• VARCHAR</li> <li>• VARCHAR, INTEGER</li> <li>• VARCHAR, INTEGER, INTEGER</li> <li>• VARCHAR, INTEGER, INTEGER, VARCHAR</li> </ul> | <ul style="list-style-type: none"> <li>• DECIMAL</li> <li>• DECIMAL</li> <li>• DECIMAL</li> <li>• DECIMAL</li> </ul> | This scalar function returns the decimal representation of a character string, with optional precision, scale, and decimal character.   |
| "DECRYPT_BIN and DECRYPT_CHAR " on page 319 | SYSIBM | <ul style="list-style-type: none"> <li>• VARCHAR FOR BIT DATA</li> <li>• VARCHAR FOR BIT DATA, VARCHAR</li> </ul>  | <ul style="list-style-type: none"> <li>• VARCHAR FOR BIT DATA</li> <li>• VARCHAR FOR BIT DATA</li> </ul>             | This scalar function returns a value that is the result of decrypting encrypted data using a password string.   |
| "DECRYPT_BIN and DECRYPT_CHAR " on page 319 | SYSIBM | <ul style="list-style-type: none"> <li>• VARCHAR FOR BIT DATA</li> <li>• VARCHAR FOR BIT DATA, VARCHAR</li> </ul>  | <ul style="list-style-type: none"> <li>• VARCHAR</li> <li>• VARCHAR</li> </ul>                                       | This scalar function returns a value that is the result of decrypting encrypted data using a password string.   |
| "DEGREES " on page 321                      | SYSFUN | <ul style="list-style-type: none"> <li>• DOUBLE</li> </ul>   | <ul style="list-style-type: none"> <li>• DOUBLE</li> </ul>   | This scalar function returns the number of degrees converted from the argument expressed in radians.  |
| "DEREF " on page 322                        | SYSIBM | <ul style="list-style-type: none"> <li>• REF(<i>any-structured-type</i>) with defined scope</li> </ul>   | <ul style="list-style-type: none"> <li>• <i>any-structured-type</i> (same as input target type)</li> </ul>           | This scalar function returns an instance of the target type of the reference type argument.   |

Table 16. Supported functions (continued)

| Function name                  | Schema | Input  | Returns  | Description  |
|--------------------------------|--------|--|--|--|
| "DIFFERENCE " on page 323      | SYSFUN | <ul style="list-style-type: none"> <li>VARCHAR(4000), VARCHAR(4000)</li> </ul>   | <ul style="list-style-type: none"> <li>INTEGER</li> </ul>  | This scalar function returns the difference between the sounds of the words in the two argument strings, as determined by the SOUNDEX function. A value of 4 means the strings sound the same.   |
| "DIGITS " on page 324          | SYSBM  | <ul style="list-style-type: none"> <li>DECIMAL</li> </ul>  | <ul style="list-style-type: none"> <li>CHAR</li> </ul>   | This scalar function returns the character string representation of a number.  |
| "DOUBLE " on page 325          | SYSBM  | <ul style="list-style-type: none"> <li><i>numeric-type</i></li> </ul>  | <ul style="list-style-type: none"> <li>DOUBLE</li> </ul>   | This scalar function returns the floating-point representation of a number.  |
| "DOUBLE " on page 325          | SYSFUN | <ul style="list-style-type: none"> <li>VARCHAR</li> </ul>  | <ul style="list-style-type: none"> <li>DOUBLE</li> </ul>   | This scalar function returns the floating-point number corresponding to the character string representation of a number. Leading and trailing blanks in <i>argument</i> are ignored.   |
| "ENCRYPT " on page 327         | SYSBM  | <ul style="list-style-type: none"> <li>VARCHAR</li> <li>VARCHAR, VARCHAR</li> <li>VARCHAR, VARCHAR, VARCHAR</li> </ul> | <ul style="list-style-type: none"> <li>VARCHAR FOR BIT DATA</li> <li>VARCHAR FOR BIT DATA</li> <li>VARCHAR FOR BIT DATA</li> </ul> | This scalar function returns a value that is the result of encrypting a data string expression.  |
| "EVENT_MON_STATE " on page 329 | SYSBM  | <ul style="list-style-type: none"> <li>VARCHAR</li> </ul>  | <ul style="list-style-type: none"> <li>INTEGER</li> </ul>  | This scalar function returns the operational state of particular event monitor.  |
| "EXP " on page 330             | SYSFUN | <ul style="list-style-type: none"> <li>DOUBLE</li> </ul>   | <ul style="list-style-type: none"> <li>DOUBLE</li> </ul>   | This scalar function returns the exponential function of the argument.   |
| "FLOAT " on page 331           | SYSBM  |  |  | This scalar function is the same as DOUBLE.  |
| "FLOOR " on page 332           | SYSBM  | <ul style="list-style-type: none"> <li>SMALLINT</li> <li>INTEGER</li> <li>BIGINT</li> <li>DOUBLE</li> </ul>            | <ul style="list-style-type: none"> <li>SMALLINT</li> <li>INTEGER</li> <li>BIGINT</li> <li>DOUBLE</li> </ul>                        | This scalar function returns the largest integer that is less than or equal to the argument.   |
| "GENERATE_UNIQUE " on page 334 | SYSBM  | <ul style="list-style-type: none"> <li>no argument</li> </ul>  | <ul style="list-style-type: none"> <li>CHAR(13) FOR BIT DATA</li> </ul>  | This scalar function returns a bit data character string that is unique compared to any other execution of the same function.  |
| "GETHINT " on page 333         | SYSBM  | <ul style="list-style-type: none"> <li>VARCHAR or CLOB</li> </ul>  | <ul style="list-style-type: none"> <li>VARCHAR</li> </ul>  | This scalar function returns the password hint if one is found.  |
| "GRAPHIC " on page 336         | SYSBM  | <ul style="list-style-type: none"> <li><i>graphic-type</i></li> <li><i>graphic-type</i>, INTEGER</li> </ul>            | <ul style="list-style-type: none"> <li>GRAPHIC</li> <li>GRAPHIC</li> </ul>   | This scalar function casts from source type to GRAPHIC, with optional length.  |
| "GROUPING " on page 266        | SYSBM  | <ul style="list-style-type: none"> <li><i>any-type</i></li> </ul>  | <ul style="list-style-type: none"> <li>SMALLINT</li> </ul>   | This aggregate function is used with grouping-sets and super-groups to indicate sub-total rows generated by a grouping set. The value returned is 0 or 1. A value of 1 means that the value of the argument in the returned row is a null value, and the row was generated for a grouping set. This generated row provides a sub-total for a grouping set. |

## Supported functions

Table 16. Supported functions (continued)

| Function name                           | Schema | Input  | Returns  | Description  |
|---|--------|--|--|--|
| "HASHEDVALUE " on page 338 <sup>3</sup> | SYSIBM | <ul style="list-style-type: none"> <li>• <i>any-type</i></li> </ul>  | <ul style="list-style-type: none"> <li>• INTEGER</li> </ul>  | This scalar function returns the distribution map index (0 to 4095) of the row. The argument is a column name within a table.  |
| "HEX " on page 340                      | SYSIBM | <ul style="list-style-type: none"> <li>• <i>any-builtin-type</i></li> </ul>  | <ul style="list-style-type: none"> <li>• VARCHAR</li> </ul>  | This scalar function returns the hexadecimal representation of a value.  |
| "HOUR " on page 342                     | SYSIBM | <ul style="list-style-type: none"> <li>• VARCHAR</li> <li>• TIME</li> <li>• TIMESTAMP</li> <li>• DECIMAL</li> </ul>  | <ul style="list-style-type: none"> <li>• INTEGER</li> <li>• INTEGER</li> <li>• INTEGER</li> <li>• INTEGER</li> </ul> | This scalar function returns the hour part of a value.   |
| "IDENTITY_VAL_LOCAL " on page 343       | SYSIBM |  | <ul style="list-style-type: none"> <li>• DECIMAL</li> </ul>  | This scalar function returns the most recently assigned value for an identity column.  |
| "INSERT " on page 347                   | SYSFUN | <ul style="list-style-type: none"> <li>• VARCHAR(4000), INTEGER, INTEGER, VARCHAR(4000)</li> <li>• CLOB(1M), INTEGER, INTEGER, CLOB(1M)</li> <li>• BLOB(1M), INTEGER, INTEGER, BLOB(1M)</li> </ul> | <ul style="list-style-type: none"> <li>• VARCHAR(4000)</li> <li>• CLOB(1M)</li> <li>• BLOB(1M)</li> </ul>            | This scalar function returns a string, where <i>argument3</i> bytes have been deleted from <i>argument1</i> (beginning at <i>argument2</i> ), and <i>argument4</i> has been inserted into <i>argument1</i> (beginning at <i>argument2</i> ).                         |
| "INTEGER " on page 348                  | SYSIBM | <ul style="list-style-type: none"> <li>• <i>numeric-type</i></li> <li>• VARCHAR</li> </ul>   | <ul style="list-style-type: none"> <li>• INTEGER</li> <li>• INTEGER</li> </ul>                                       | This scalar function returns the integer representation of a number.   |
| "JULIAN_DAY " on page 350               | SYSFUN | <ul style="list-style-type: none"> <li>• VARCHAR(26)</li> <li>• DATE</li> <li>• TIMESTAMP</li> </ul>   | <ul style="list-style-type: none"> <li>• INTEGER</li> <li>• INTEGER</li> <li>• INTEGER</li> </ul>                    | This scalar function returns an integer value representing the number of days from January 1, 4712 B.C. (the start of the Julian date calendar) to the date value specified in the <i>argument</i> .   |
| "LCASE (SYSFUN schema) " on page 352    | SYSFUN | <ul style="list-style-type: none"> <li>• VARCHAR(4000)</li> <li>• CLOB(1M)</li> </ul>  | <ul style="list-style-type: none"> <li>• VARCHAR(4000)</li> <li>• CLOB(1M)</li> </ul>                                | This scalar function returns a string in which all the characters have been converted to lowercase characters. LCASE will only handle characters in the invariant set. Therefore, LCASE(UCASE(string)) will not necessarily return the same result as LCASE(string). |
| "LCASE or LOWER " on page 351           | SYSIBM | <ul style="list-style-type: none"> <li>• CHAR</li> <li>• VARCHAR</li> </ul>  | <ul style="list-style-type: none"> <li>• CHAR</li> <li>• VARCHAR</li> </ul>  | This scalar function returns a string in which all the characters have been converted to lowercase characters.   |
| "LEFT " on page 353                     | SYSFUN | <ul style="list-style-type: none"> <li>• VARCHAR(4000), INTEGER</li> <li>• CLOB(1M), INTEGER</li> <li>• BLOB(1M), INTEGER</li> </ul>   | <ul style="list-style-type: none"> <li>• VARCHAR(4000)</li> <li>• CLOB(1M)</li> <li>• BLOB(1M)</li> </ul>            | This scalar function returns a string consisting of the leftmost <i>argument2</i> bytes in <i>argument1</i> .  |
| "LENGTH " on page 354                   | SYSIBM | <ul style="list-style-type: none"> <li>• <i>any-builtin-type</i></li> <li>• <i>any-builtin-type, string-unit</i></li> </ul>  | <ul style="list-style-type: none"> <li>• INTEGER</li> <li>• INTEGER</li> </ul>                                       | This scalar function returns the length of the operand in bytes (except for double-byte string types, which return the length in double-byte characters).  |
| "LN " on page 356                       | SYSFUN | <ul style="list-style-type: none"> <li>• DOUBLE</li> </ul>   | <ul style="list-style-type: none"> <li>• DOUBLE</li> </ul>   | This scalar function returns the natural logarithm of the argument (same as LOG).  |

Table 16. Supported functions (continued)

| Function name                        | Schema | Input  | Returns  | Description  |
|--------------------------------------|--------|--|--|--|
| "LOCATE " on page 357                | SYSIBM | <ul style="list-style-type: none"> <li>• string-type, compatible-string-type</li> <li>• string-type, compatible-string-type, INTEGER</li> <li>• string-type, compatible-string-type, string-unit</li> <li>• string-type, compatible-string-type, INTEGER, string-unit</li> </ul> | <ul style="list-style-type: none"> <li>• INTEGER</li> <li>• INTEGER</li> <li>• INTEGER</li> <li>• INTEGER</li> </ul>       | This scalar function returns the starting position of the first occurrence of <i>argument1</i> within <i>argument2</i> . If the optional INTEGER argument is specified, it indicates the character position in <i>argument2</i> at which the search is to begin. If <i>argument1</i> is not found within <i>argument2</i> , the value 0 is returned. |
| "LOG " on page 360                   | SYSFUN | • DOUBLE   | • DOUBLE   | This scalar function returns the natural logarithm of the argument (same as LN).   |
| "LOG10 " on page 361                 | SYSFUN | • DOUBLE   | • DOUBLE   | This scalar function returns the base 10 logarithm of the argument.  |
| "LONG_VARCHAR " on page 362          | SYSIBM | • character-type   | • LONG VARCHAR   | This scalar function returns a long string.  |
| "LONG_VARGRAPHIC " on page 363       | SYSIBM | • graphic-type   | • LONG VARGRAPHIC  | This scalar function casts from source type to LONG VARGRAPHIC.  |
| "LTRIM (SYSFUN schema) " on page 365 | SYSFUN | <ul style="list-style-type: none"> <li>• VARCHAR(4000)</li> <li>• CLOB(1M)</li> </ul>  | <ul style="list-style-type: none"> <li>• VARCHAR(4000)</li> <li>• CLOB(1M)</li> </ul>                                      | This scalar function returns the characters of the argument with leading blanks removed.   |
| "LTRIM " on page 364                 | SYSIBM | <ul style="list-style-type: none"> <li>• CHAR</li> <li>• VARCHAR</li> <li>• GRAPHIC</li> <li>• VARGRAPHIC</li> </ul>   | <ul style="list-style-type: none"> <li>• VARCHAR</li> <li>• VARCHAR</li> <li>• VARGRAPHIC</li> <li>• VARGRAPHIC</li> </ul> | This scalar function returns the characters of the argument with leading blanks removed.   |
| "MAX " on page 268                   | SYSIBM | • any-builtin-type <sup>5</sup>  | • same as input type   | This aggregate function returns the maximum value in a set of values.  |
| "MICROSECOND " on page 366           | SYSIBM | <ul style="list-style-type: none"> <li>• VARCHAR</li> <li>• TIMESTAMP</li> <li>• DECIMAL</li> </ul>  | <ul style="list-style-type: none"> <li>• INTEGER</li> <li>• INTEGER</li> <li>• INTEGER</li> </ul>                          | This scalar function returns the microsecond (time-unit) part of a value.  |
| "MIDNIGHT_SECONDS " on page 367      | SYSFUN | <ul style="list-style-type: none"> <li>• VARCHAR(26)</li> <li>• TIME</li> <li>• TIMESTAMP</li> </ul>   | <ul style="list-style-type: none"> <li>• INTEGER</li> <li>• INTEGER</li> <li>• INTEGER</li> </ul>                          | This scalar function returns an integer value in the range 0 to 86 400, representing the number of seconds between midnight and the time value specified in the <i>argument</i> .  |
| "MIN " on page 270                   | SYSIBM | • any-builtin-type <sup>5</sup>  | • same as input type   | This aggregate function returns the minimum value in a set of values.  |
| "MINUTE " on page 368                | SYSIBM | <ul style="list-style-type: none"> <li>• VARCHAR</li> <li>• TIME</li> <li>• TIMESTAMP</li> <li>• DECIMAL</li> </ul>  | <ul style="list-style-type: none"> <li>• INTEGER</li> <li>• INTEGER</li> <li>• INTEGER</li> <li>• INTEGER</li> </ul>       | This scalar function returns the minute part of a value.   |
| "MOD " on page 369                   | SYSFUN | <ul style="list-style-type: none"> <li>• SMALLINT, SMALLINT</li> <li>• INTEGER, INTEGER</li> <li>• BIGINT, BIGINT</li> </ul>   | <ul style="list-style-type: none"> <li>• SMALLINT</li> <li>• INTEGER</li> <li>• BIGINT</li> </ul>                          | This scalar function returns the remainder (modulus) of <i>argument1</i> divided by <i>argument2</i> . The result is negative only if <i>argument1</i> is negative.  |
| "MONTH " on page 370                 | SYSIBM | <ul style="list-style-type: none"> <li>• VARCHAR</li> <li>• DATE</li> <li>• TIMESTAMP</li> <li>• DECIMAL</li> </ul>  | <ul style="list-style-type: none"> <li>• INTEGER</li> <li>• INTEGER</li> <li>• INTEGER</li> <li>• INTEGER</li> </ul>       | This scalar function returns the month part of a value.  |

## Supported functions

Table 16. Supported functions (continued)

| Function name                           | Schema | Input   | Returns   | Description   |
|---|--------|---|---|---|
| "MONTHNAME " on page 371                | SYSFUN | <ul style="list-style-type: none"> <li>• VARCHAR(26)</li> <li>• DATE</li> <li>• TIMESTAMP</li> </ul>  | <ul style="list-style-type: none"> <li>• VARCHAR(100)</li> <li>• VARCHAR(100)</li> <li>• VARCHAR(100)</li> </ul>  | This scalar function returns a mixed case character string containing the name of the month (for example, January) for the month portion of the argument that is a date or a timestamp, based on what the locale was when the database was started. |
| "MULTIPLY_ALT " on page 372             | SYSIBM | <ul style="list-style-type: none"> <li>• <i>exact-numeric-type</i>,</li> <li>• <i>exact-numeric-type</i></li> </ul>                                 | <ul style="list-style-type: none"> <li>• DECIMAL</li> </ul>   | This scalar function returns the product of two arguments as a decimal value. This function is useful when the sum of the argument precisions is greater than 31.   |
| "NULLIF " on page 374 <sup>3</sup>      | SYSIBM | <ul style="list-style-type: none"> <li>• <i>any-type</i><sup>5</sup>,</li> <li>• <i>any-comparable-type</i><sup>5</sup></li> </ul>                  | <ul style="list-style-type: none"> <li>• <i>any-type</i></li> </ul>   | This scalar function returns NULL if the arguments are equal, or returns the first argument if they are not equal.  |
| "OCTET_LENGTH " on page 375             | SYSIBM | <ul style="list-style-type: none"> <li>• <i>string-type</i></li> </ul>  | <ul style="list-style-type: none"> <li>• INTEGER</li> </ul>   | This scalar function returns the length of an expression in octets (bytes).   |
| "POSITION " on page 376                 | SYSIBM | <ul style="list-style-type: none"> <li>• <i>string-type</i>, <i>string-type</i>,</li> <li>• <i>string-unit</i></li> </ul>                           | <ul style="list-style-type: none"> <li>• INTEGER</li> </ul>   | This scalar function returns the starting position of <i>argument2</i> within <i>argument1</i> .  |
| "POSSTR " on page 379                   | SYSIBM | <ul style="list-style-type: none"> <li>• <i>string-type</i>,</li> <li>• <i>compatible-string-type</i></li> </ul>                                    | <ul style="list-style-type: none"> <li>• INTEGER</li> </ul>   | This scalar function returns the position at which one string is contained in another.  |
| "POWER " on page 381                    | SYSFUN | <ul style="list-style-type: none"> <li>• INTEGER, INTEGER</li> <li>• BIGINT, BIGINT</li> <li>• DOUBLE, INTEGER</li> <li>• DOUBLE, DOUBLE</li> </ul> | <ul style="list-style-type: none"> <li>• INTEGER</li> <li>• BIGINT</li> <li>• DOUBLE</li> <li>• DOUBLE</li> </ul> | This scalar function returns the value of <i>argument1</i> to the power of <i>argument2</i> .   |
| "QUARTER " on page 382                  | SYSFUN | <ul style="list-style-type: none"> <li>• VARCHAR(26)</li> <li>• DATE</li> <li>• TIMESTAMP</li> </ul>  | <ul style="list-style-type: none"> <li>• INTEGER</li> <li>• INTEGER</li> <li>• INTEGER</li> </ul>                 | This scalar function returns an integer value in the range 1 to 4, representing the quarter of the year for the date specified in the argument.   |
| "RADIANS " on page 383                  | SYSFUN | <ul style="list-style-type: none"> <li>• DOUBLE</li> </ul>  | <ul style="list-style-type: none"> <li>• DOUBLE</li> </ul>  | This scalar function returns the number of radians converted from the argument, which is expressed in degrees.  |
| "RAISE_ERROR " on page 384 <sup>3</sup> | SYSIBM | <ul style="list-style-type: none"> <li>• VARCHAR,</li> <li>• VARCHAR</li> </ul>   | <ul style="list-style-type: none"> <li>• <i>any-type</i><sup>6</sup></li> </ul>                                   | This scalar function raises an error in the SQLCA. The sqlstate that is to be returned is indicated by <i>argument1</i> . The second argument contains any text that is to be returned.   |
| "RAND " on page 385                     | SYSFUN | <ul style="list-style-type: none"> <li>• no argument</li> <li>• INTEGER</li> </ul>  | <ul style="list-style-type: none"> <li>• DOUBLE</li> <li>• DOUBLE</li> </ul>                                      | This scalar function returns a random floating point value between 0 and 1, using the argument as an optional seed value.   |
| "REAL " on page 386                     | SYSIBM | <ul style="list-style-type: none"> <li>• <i>numeric-type</i></li> </ul>   | <ul style="list-style-type: none"> <li>• REAL</li> </ul>  | This scalar function returns the single-precision floating-point representation of a number.  |
| "REC2XML " on page 387                  | SYSIBM | <ul style="list-style-type: none"> <li>• DECIMAL,</li> <li>• VARCHAR,</li> <li>• VARCHAR, <i>any-type</i><sup>7</sup></li> </ul>                    | <ul style="list-style-type: none"> <li>• VARCHAR</li> </ul>   | This scalar function returns a string formatted with XML tags, containing column names and column data.   |
| "Regression functions" on page 273      | SYSIBM | <ul style="list-style-type: none"> <li>• <i>numeric-type</i>,</li> <li>• <i>numeric-type</i></li> </ul>   | <ul style="list-style-type: none"> <li>• DOUBLE</li> </ul>  | The REGR_AVGX aggregate function returns quantities used to compute diagnostic statistics.  |

Table 16. Supported functions (continued)

| Function name                        | Schema | Input   | Returns   | Description  |
|--------------------------------------|--------|---|---|--|
| "Regression functions" on page 273   | SYSIBM | <ul style="list-style-type: none"> <li>numeric-type,</li> <li>numeric-type</li> </ul>   | <ul style="list-style-type: none"> <li>DOUBLE</li> </ul>  | The REGR_AVGY aggregate function returns quantities used to compute diagnostic statistics.   |
| "Regression functions" on page 273   | SYSIBM | <ul style="list-style-type: none"> <li>numeric-type,</li> <li>numeric-type</li> </ul>   | <ul style="list-style-type: none"> <li>INTEGER</li> </ul>   | The REGR_COUNT aggregate function returns the number of non-null number pairs used to fit the regression line.   |
| "Regression functions" on page 273   | SYSIBM | <ul style="list-style-type: none"> <li>numeric-type,</li> <li>numeric-type</li> </ul>   | <ul style="list-style-type: none"> <li>DOUBLE</li> </ul>  | The REGR_INTERCEPT or REGR_ICPT aggregate function returns the y-intercept of the regression line.   |
| "Regression functions" on page 273   | SYSIBM | <ul style="list-style-type: none"> <li>numeric-type,</li> <li>numeric-type</li> </ul>   | <ul style="list-style-type: none"> <li>DOUBLE</li> </ul>  | The REGR_R2 aggregate function returns the coefficient of determination for the regression.  |
| "Regression functions" on page 273   | SYSIBM | <ul style="list-style-type: none"> <li>numeric-type,</li> <li>numeric-type</li> </ul>   | <ul style="list-style-type: none"> <li>DOUBLE</li> </ul>  | The REGR_SLOPE aggregate function returns the slope of the line.   |
| "Regression functions" on page 273   | SYSIBM | <ul style="list-style-type: none"> <li>numeric-type,</li> <li>numeric-type</li> </ul>   | <ul style="list-style-type: none"> <li>DOUBLE</li> </ul>  | The REGR_SXX aggregate function returns quantities used to compute diagnostic statistics.  |
| "Regression functions" on page 273   | SYSIBM | <ul style="list-style-type: none"> <li>numeric-type,</li> <li>numeric-type</li> </ul>   | <ul style="list-style-type: none"> <li>DOUBLE</li> </ul>  | The REGR_SXY aggregate function returns quantities used to compute diagnostic statistics.  |
| "Regression functions" on page 273   | SYSIBM | <ul style="list-style-type: none"> <li>numeric-type,</li> <li>numeric-type</li> </ul>   | <ul style="list-style-type: none"> <li>DOUBLE</li> </ul>  | The REGR_SYY aggregate function returns quantities used to compute diagnostic statistics.  |
| "REPEAT " on page 391                | SYSFUN | <ul style="list-style-type: none"> <li>VARCHAR(4000), INTEGER</li> <li>CLOB(1M), INTEGER</li> <li>BLOB(1M), INTEGER</li> </ul>  | <ul style="list-style-type: none"> <li>VARCHAR(4000)</li> <li>CLOB(1M)</li> <li>BLOB(1M)</li> </ul> | This scalar function returns a character string composed of <i>argument1</i> repeated <i>argument2</i> times.  |
| "REPLACE " on page 392               | SYSFUN | <ul style="list-style-type: none"> <li>VARCHAR(4000), VARCHAR(4000), VARCHAR(4000)</li> <li>CLOB(1M), CLOB(1M), CLOB(1M)</li> <li>BLOB(1M), BLOB(1M), BLOB(1M)</li> </ul> | <ul style="list-style-type: none"> <li>VARCHAR(4000)</li> <li>CLOB(1M)</li> <li>BLOB(1M)</li> </ul> | This scalar function replaces all occurrences of <i>argument2</i> in <i>argument1</i> with <i>argument3</i> .  |
| "RIGHT " on page 393                 | SYSFUN | <ul style="list-style-type: none"> <li>VARCHAR(4000), INTEGER</li> <li>CLOB(1M), INTEGER</li> <li>BLOB(1M), INTEGER</li> </ul>  | <ul style="list-style-type: none"> <li>VARCHAR(4000)</li> <li>CLOB(1M)</li> <li>BLOB(1M)</li> </ul> | This scalar function returns a string consisting of the rightmost <i>argument2</i> bytes in <i>argument1</i> .   |
| "ROUND " on page 394                 | SYSIBM | <ul style="list-style-type: none"> <li>INTEGER, INTEGER</li> <li>BIGINT, INTEGER</li> <li>DOUBLE, INTEGER</li> </ul>  | <ul style="list-style-type: none"> <li>INTEGER</li> <li>BIGINT</li> <li>DOUBLE</li> </ul>           | This scalar function returns the first argument rounded to <i>argument2</i> places right of the decimal point. If <i>argument2</i> is negative, <i>argument1</i> is rounded to the absolute value of <i>argument2</i> places to the left of the decimal point. |
| "RTRIM (SYSFUN schema) " on page 397 | SYSFUN | <ul style="list-style-type: none"> <li>VARCHAR(4000)</li> <li>CLOB(1M)</li> </ul>   | <ul style="list-style-type: none"> <li>VARCHAR(4000)</li> <li>CLOB(1M)</li> </ul>                   | This scalar function returns the characters of the argument with trailing blanks removed.  |

## Supported functions

Table 16. Supported functions (continued)

| Function name                   | Schema | Input  | Returns  | Description  |
|---------------------------------|--------|--|--|--|
| "RTRIM " on page 396            | SYSIBM | <ul style="list-style-type: none"> <li>CHAR</li> <li>VARCHAR</li> <li>GRAPHIC</li> <li>VARGRAPHIC</li> </ul>   | <ul style="list-style-type: none"> <li>VARCHAR</li> <li>VARCHAR</li> <li>VARGRAPHIC</li> <li>VARGRAPHIC</li> </ul> | This scalar function returns the characters of the argument with trailing blanks removed.  |
| "SECLABEL " on page 398         | SYSIBM | <ul style="list-style-type: none"> <li>CHAR, a string in security label string format</li> <li>VARCHAR, a string in security label string format</li> <li>GRAPHIC, a string in security label string format</li> <li>VARGRAPHIC, a string in security label string format</li> </ul> | <ul style="list-style-type: none"> <li>DB2SECURITYLABEL</li> </ul>   | This scalar function returns an unnamed security label.  |
| "SECLABEL_BY_NAME " on page 399 | SYSIBM | <ul style="list-style-type: none"> <li>CHAR, DB2SECURITYLABEL</li> <li>VARCHAR, DB2SECURITYLABEL</li> <li>GRAPHIC, DB2SECURITYLABEL</li> <li>VARGRAPHIC, DB2SECURITYLABEL</li> </ul>   | <ul style="list-style-type: none"> <li>DB2SECURITYLABEL</li> </ul>   | This scalar function returns a specific security label.  |
| "SECLABEL_TO_CHAR " on page 400 | SYSIBM | <ul style="list-style-type: none"> <li>CHAR, DB2SECURITYLABEL</li> <li>VARCHAR, DB2SECURITYLABEL</li> <li>GRAPHIC, DB2SECURITYLABEL</li> <li>VARGRAPHIC, DB2SECURITYLABEL</li> </ul>   | <ul style="list-style-type: none"> <li>a string in security label string format</li> </ul>                         | This scalar function accepts a security label and returns a string that contains all elements in the security label.   |
| "SECOND " on page 402           | SYSIBM | <ul style="list-style-type: none"> <li>VARCHAR</li> <li>TIME</li> <li>TIMESTAMP</li> <li>DECIMAL</li> </ul>  | <ul style="list-style-type: none"> <li>INTEGER</li> <li>INTEGER</li> <li>INTEGER</li> <li>INTEGER</li> </ul>       | This scalar function returns the second (time unit) part of a value.   |
| "SIGN " on page 403             | SYSFUN | <ul style="list-style-type: none"> <li>SMALLINT</li> <li>INTEGER</li> <li>BIGINT</li> <li>DOUBLE</li> </ul>  | <ul style="list-style-type: none"> <li>SMALLINT</li> <li>INTEGER</li> <li>BIGINT</li> <li>DOUBLE</li> </ul>        | This scalar function returns an indicator of the sign of the argument. If the argument is less than zero, -1 is returned. If the argument equals zero, 0 is returned. If the argument is greater than zero, 1 is returned. |
| "SIN " on page 404              | SYSIBM | <ul style="list-style-type: none"> <li>DOUBLE</li> </ul>   | <ul style="list-style-type: none"> <li>DOUBLE</li> </ul>   | This scalar function returns the sine of the argument, where the argument is an angle expressed in radians.  |
| "SINH " on page 405             | SYSIBM | <ul style="list-style-type: none"> <li>DOUBLE</li> </ul>   | <ul style="list-style-type: none"> <li>DOUBLE</li> </ul>   | This scalar function returns the hyperbolic sine of the argument, where the argument is an angle expressed in radians.   |
| "SMALLINT " on page 406         | SYSIBM | <ul style="list-style-type: none"> <li>numeric-type</li> <li>VARCHAR</li> </ul>  | <ul style="list-style-type: none"> <li>SMALLINT</li> <li>SMALLINT</li> </ul>                                       | This scalar function returns the small integer representation of a number.   |



Table 16. Supported functions (continued)

| Function name               | Schema | Input  | Returns  | Description  |
|-----------------------------|--------|--|--|--|
| "SOUNDEX " on page 407      | SYSFUN | • VARCHAR(4000)  | • CHAR(4)  | This scalar function returns a 4-character code representing the sound of the words in the argument. This result can be compared with the sound of other strings.  |
| "SPACE " on page 408        | SYSFUN | • INTEGER  | • VARCHAR(4000)  | This scalar function returns a character string consisting of <i>argument1</i> blanks.   |
| "SQRT " on page 409         | SYSFUN | • DOUBLE   | • DOUBLE   | This scalar function returns the square root of the argument.  |
| "STDDEV " on page 276       | SYSIBM | • DOUBLE   | • DOUBLE   | This aggregate function returns the standard deviation of a set of numbers.  |
| "STRIP " on page 410        | SYSIBM | • CHAR<br>• VARCHAR<br>• GRAPHIC<br>• VARGRAPHIC<br>• CHAR, CHAR<br>• VARCHAR, CHAR<br>• GRAPHIC, CHAR<br>• VARGRAPHIC, CHAR | • CHAR<br>• VARCHAR<br>• GRAPHIC<br>• VARGRAPHIC<br>• CHAR<br>• VARCHAR<br>• GRAPHIC<br>• VARGRAPHIC | This scalar function removes leading or trailing blanks or other specified leading or trailing characters from a string expression.  |
| "SUBSTR " on page 411       | SYSIBM | • <i>string-type</i> , INTEGER<br>• <i>string-type</i> , INTEGER, INTEGER  | • <i>string-type</i><br>• <i>string-type</i>   | This scalar function returns a substring of string <i>argument1</i> , starting at <i>argument2</i> . The substring is <i>argument3</i> bytes long. If <i>argument3</i> is not specified, the remainder of the string is assumed.                 |
| "SUBSTRING " on page 414    | SYSIBM | • <i>string-type</i> , INTEGER, <i>string-unit</i><br>• <i>string-type</i> , INTEGER, INTEGER, <i>string-unit</i>            | • <i>string-type</i><br>• <i>string-type</i>   | This scalar function returns a substring of string <i>argument1</i> , starting at <i>argument2</i> . The substring is <i>argument3</i> characters long. If the second INTEGER argument is not specified, the remainder of the string is assumed. |
| "SUM " on page 277          | SYSIBM | • <i>numeric-type</i> <sup>4</sup>   | • <i>max-numeric-type</i> <sup>1</sup>   | This aggregate function returns the sum of a set of numbers.   |
| "TABLE_NAME " on page 417   | SYSIBM | • VARCHAR<br>• VARCHAR, VARCHAR  | • VARCHAR(128)<br>• VARCHAR(128)   | This scalar function returns an unqualified name of a table or view based on the object name specified in <i>argument1</i> , and the optional schema name specified in <i>argument2</i> . The returned value is used to resolve aliases.         |
| "TABLE_SCHEMA " on page 418 | SYSIBM | • VARCHAR<br>• VARCHAR, VARCHAR  | • VARCHAR(128)<br>• VARCHAR(128)   | This scalar function returns the schema name portion of a two-part table or view name (given by the object name in <i>argument1</i> and the optional schema name in <i>argument2</i> ). The returned value is used to resolve aliases.           |
| "TAN " on page 420          | SYSIBM | • DOUBLE   | • DOUBLE   | This scalar function returns the tangent of the argument, where the argument is an angle expressed in radians.   |

## Supported functions

Table 16. Supported functions (continued)

| Function name                   | Schema                | Input  | Returns  | Description  |   |                       |   |         |   |         |   |       |    |      |    |       |    |        |     |          |     |       |
|---------------------------------|-----------------------|--|--|--|---|-----------------------|---|---------|---|---------|---|-------|----|------|----|-------|----|--------|-----|----------|-----|-------|
| "TANH " on page 421             | SYSIBM                | <ul style="list-style-type: none"> <li>DOUBLE</li> </ul>   | <ul style="list-style-type: none"> <li>DOUBLE</li> </ul>   | This scalar function returns the hyperbolic tangent of the argument, where the argument is an angle expressed in radians.  |   |                       |   |         |   |         |   |       |    |      |    |       |    |        |     |          |     |       |
| "TIME " on page 422             | SYSIBM                | <ul style="list-style-type: none"> <li>TIME</li> <li>TIMESTAMP</li> <li>VARCHAR</li> </ul>   | <ul style="list-style-type: none"> <li>TIME</li> <li>TIME</li> <li>TIME</li> </ul>   | This scalar function returns a time from a value.  |   |                       |   |         |   |         |   |       |    |      |    |       |    |        |     |          |     |       |
| "TIMESTAMP " on page 423        | SYSIBM                | <ul style="list-style-type: none"> <li>TIMESTAMP</li> <li>VARCHAR</li> <li>VARCHAR, VARCHAR</li> <li>VARCHAR, TIME</li> <li>DATE, VARCHAR</li> <li>DATE, TIME</li> </ul> | <ul style="list-style-type: none"> <li>TIMESTAMP</li> <li>TIMESTAMP</li> <li>TIMESTAMP</li> <li>TIMESTAMP</li> <li>TIMESTAMP</li> <li>TIMESTAMP</li> </ul> | This scalar function returns a timestamp from a value or a pair of values.   |   |                       |   |         |   |         |   |       |    |      |    |       |    |        |     |          |     |       |
| "TIMESTAMP_FORMAT " on page 424 | SYSIBM                | <ul style="list-style-type: none"> <li>VARCHAR, VARCHAR</li> </ul>   | <ul style="list-style-type: none"> <li>TIMESTAMP</li> </ul>  | This scalar function returns a timestamp from a character string ( <i>argument1</i> ) that has been interpreted using a format template ( <i>argument2</i> ).  |   |                       |   |         |   |         |   |       |    |      |    |       |    |        |     |          |     |       |
| "TIMESTAMP_ISO " on page 426    | SYSFUN                | <ul style="list-style-type: none"> <li>DATE</li> <li>TIME</li> <li>TIMESTAMP</li> <li>VARCHAR(26)</li> </ul>   | <ul style="list-style-type: none"> <li>TIMESTAMP</li> <li>TIMESTAMP</li> <li>TIMESTAMP</li> <li>TIMESTAMP</li> </ul>                                       | This scalar function returns a timestamp value based on a date, time, or timestamp argument. If the argument is a date, it inserts zero for all the time elements. If the argument is a time, it inserts the value of CURRENT DATE for the date elements, and zero for the fractional time element.  |   |                       |   |         |   |         |   |       |    |      |    |       |    |        |     |          |     |       |
| "TIMESTAMPDIFF " on page 427    | SYSFUN                | <ul style="list-style-type: none"> <li>INTEGER, CHAR(22)</li> </ul>  | <ul style="list-style-type: none"> <li>INTEGER</li> </ul>  | <p>This scalar function returns an estimated number of intervals of type <i>argument1</i>, based on the difference between two timestamps. The second argument is the result of subtracting two timestamp types and converting the result to CHAR. Valid interval types are:</p> <table> <tr> <td>1</td> <td>Fractions of a second</td> </tr> <tr> <td>2</td> <td>Seconds</td> </tr> <tr> <td>4</td> <td>Minutes</td> </tr> <tr> <td>8</td> <td>Hours</td> </tr> <tr> <td>16</td> <td>Days</td> </tr> <tr> <td>32</td> <td>Weeks</td> </tr> <tr> <td>64</td> <td>Months</td> </tr> <tr> <td>128</td> <td>Quarters</td> </tr> <tr> <td>256</td> <td>Years</td> </tr> </table> | 1 | Fractions of a second | 2 | Seconds | 4 | Minutes | 8 | Hours | 16 | Days | 32 | Weeks | 64 | Months | 128 | Quarters | 256 | Years |
| 1                               | Fractions of a second |  |  |  |   |                       |   |         |   |         |   |       |    |      |    |       |    |        |     |          |     |       |
| 2                               | Seconds               |  |  |  |   |                       |   |         |   |         |   |       |    |      |    |       |    |        |     |          |     |       |
| 4                               | Minutes               |  |  |  |   |                       |   |         |   |         |   |       |    |      |    |       |    |        |     |          |     |       |
| 8                               | Hours                 |  |  |  |   |                       |   |         |   |         |   |       |    |      |    |       |    |        |     |          |     |       |
| 16                              | Days                  |  |  |  |   |                       |   |         |   |         |   |       |    |      |    |       |    |        |     |          |     |       |
| 32                              | Weeks                 |  |  |  |   |                       |   |         |   |         |   |       |    |      |    |       |    |        |     |          |     |       |
| 64                              | Months                |  |  |  |   |                       |   |         |   |         |   |       |    |      |    |       |    |        |     |          |     |       |
| 128                             | Quarters              |  |  |  |   |                       |   |         |   |         |   |       |    |      |    |       |    |        |     |          |     |       |
| 256                             | Years                 |  |  |  |   |                       |   |         |   |         |   |       |    |      |    |       |    |        |     |          |     |       |
| "TO_CHAR " on page 429          | SYSIBM                | <ul style="list-style-type: none"> <li>same as VARCHAR_FORMAT</li> </ul>   | <ul style="list-style-type: none"> <li>same as VARCHAR_FORMAT</li> </ul>   | This scalar function returns a character representation of a timestamp.  |   |                       |   |         |   |         |   |       |    |      |    |       |    |        |     |          |     |       |
| "TO_DATE " on page 430          | SYSIBM                | <ul style="list-style-type: none"> <li>same as TIMESTAMP_FORMAT</li> </ul>   | <ul style="list-style-type: none"> <li>same as TIMESTAMP_FORMAT</li> </ul>   | This scalar function returns a timestamp from a character string.  |   |                       |   |         |   |         |   |       |    |      |    |       |    |        |     |          |     |       |

Table 16. Supported functions (continued)

| Function name                           | Schema | Input   | Returns   | Description  |
|---|--------|---|---|--|
| "TRANSLATE " on page 431                | SYSIBM | <ul style="list-style-type: none"> <li>• CHAR</li> <li>• VARCHAR</li> <li>• CHAR, VARCHAR, VARCHAR</li> <li>• VARCHAR, VARCHAR, VARCHAR</li> <li>• CHAR, VARCHAR, VARCHAR, VARCHAR</li> <li>• VARCHAR, VARCHAR, VARCHAR, VARCHAR</li> <li>• GRAPHIC, VARGRAPHIC, VARGRAPHIC</li> <li>• VARGRAPHIC, VARGRAPHIC, VARGRAPHIC</li> <li>• GRAPHIC, VARGRAPHIC, VARGRAPHIC, VARGRAPHIC</li> <li>• VARGRAPHIC, VARGRAPHIC, VARGRAPHIC, VARGRAPHIC</li> </ul> | <ul style="list-style-type: none"> <li>• CHAR</li> <li>• VARCHAR</li> <li>• CHAR</li> <li>• VARCHAR</li> <li>• CHAR</li> <li>• VARCHAR</li> <li>• GRAPHIC</li> <li>• VARGRAPHIC</li> <li>• GRAPHIC</li> <li>• VARGRAPHIC</li> </ul> | This scalar function returns a string in which one or more characters may have been converted into other characters.   |
| "TRIM " on page 433                     | SYSIBM | <ul style="list-style-type: none"> <li>• CHAR</li> <li>• VARCHAR</li> <li>• GRAPHIC</li> <li>• VARGRAPHIC</li> <li>• CHAR, CHAR</li> <li>• CHAR, VARCHAR</li> <li>• CHAR, GRAPHIC</li> <li>• CHAR, VARGRAPHIC</li> </ul>  | <ul style="list-style-type: none"> <li>• CHAR</li> <li>• VARCHAR</li> <li>• GRAPHIC</li> <li>• VARGRAPHIC</li> <li>• CHAR</li> <li>• VARCHAR</li> <li>• GRAPHIC</li> <li>• VARGRAPHIC</li> </ul>                                    | This scalar function removes leading or trailing blanks or other specified leading or trailing characters from a string expression.  |
| "TRUNCATE or TRUNC " on page 435        | SYSIBM | <ul style="list-style-type: none"> <li>• INTEGER, INTEGER</li> <li>• BIGINT, INTEGER</li> <li>• DOUBLE, INTEGER</li> </ul>  | <ul style="list-style-type: none"> <li>• INTEGER</li> <li>• BIGINT</li> <li>• DOUBLE</li> </ul>   | This scalar function returns <i>argument1</i> truncated to <i>argument2</i> places right of the decimal point. If <i>argument2</i> is negative, <i>argument1</i> is truncated to the absolute value of <i>argument2</i> places to the left of the decimal point. |
| "TYPE_ID " on page 436 <sup>3</sup>     | SYSIBM | <ul style="list-style-type: none"> <li>• <i>any-structured-type</i></li> </ul>  | <ul style="list-style-type: none"> <li>• INTEGER</li> </ul>   | This scalar function returns the internal data type identifier of the dynamic data type of the argument. Note that the result of this function is not portable across databases.   |
| "TYPE_NAME " on page 437 <sup>3</sup>   | SYSIBM | <ul style="list-style-type: none"> <li>• <i>any-structured-type</i></li> </ul>  | <ul style="list-style-type: none"> <li>• VARCHAR(18)</li> </ul>   | This scalar function returns the unqualified name of the dynamic data type of the argument.  |
| "TYPE_SCHEMA " on page 438 <sup>3</sup> | SYSIBM | <ul style="list-style-type: none"> <li>• <i>any-structured-type</i></li> </ul>  | <ul style="list-style-type: none"> <li>• VARCHAR(128)</li> </ul>  | This scalar function returns the schema name of the dynamic type of the argument.  |

## Supported functions

Table 16. Supported functions (continued)

| Function name                     | Schema | Input  | Returns  | Description  |
|-----------------------------------|--------|--|--|--|
| "UCASE or UPPER " on page 439     | SYSFUN | • VARCHAR  | • VARCHAR  | This scalar function returns a string in which all the characters have been converted to uppercase characters.   |
| "UCASE or UPPER " on page 439     | SYSIBM | • CHAR<br>• VARCHAR  | • CHAR<br>• VARCHAR                              | This scalar function returns a string in which all the characters have been converted to uppercase characters.   |
| "VALUE " on page 440 <sup>3</sup> | SYSIBM |  |  | This scalar function is the same as COALESCE.  |
| "VARCHAR " on page 441            | SYSIBM | • <i>character-type</i><br>• <i>character-type</i> , INTEGER<br>• <i>datetime-type</i> | • VARCHAR<br>• VARCHAR<br>• VARCHAR              | This scalar function returns a VARCHAR representation of the first argument. If a second argument is present, it specifies the length of the result.   |
| "VARCHAR_FORMAT " on page 443     | SYSIBM | • TIMESTAMP, VARCHAR<br>• VARCHAR, VARCHAR   | • VARCHAR<br>• VARCHAR                           | This scalar function returns a character representation of a timestamp ( <i>argument1</i> ), formatted according to a template ( <i>argument2</i> ).   |
| "VARGRAPHIC " on page 445         | SYSIBM | • <i>graphic-type</i><br>• <i>graphic-type</i> , INTEGER<br>• VARCHAR                  | • VARGRAPHIC<br>• VARGRAPHIC<br>• VARGRAPHIC     | This scalar function returns a VARGRAPHIC representation of the first argument. If a second argument is present, it specifies the length of the result.  |
| "VARIANCE " on page 278           | SYSIBM | • DOUBLE   | • DOUBLE   | This aggregate function returns the variance of a set of numbers.  |
| "WEEK " on page 447               | SYSFUN | • VARCHAR(26)<br>• DATE<br>• TIMESTAMP   | • INTEGER<br>• INTEGER<br>• INTEGER              | This scalar function returns the week of the year in the argument as an integer value in the range of 1-54.  |
| "WEEK_ISO " on page 448           | SYSFUN | • VARCHAR(26)<br>• DATE<br>• TIMESTAMP   | • INTEGER<br>• INTEGER<br>• INTEGER              | This scalar function returns the week of the year in the argument as an integer value in the range of 1-53. The first day of a week is Monday. Week 1 is the first week of the year to contain a Thursday. |
| "YEAR " on page 486               | SYSIBM | • VARCHAR<br>• DATE<br>• TIMESTAMP<br>• DECIMAL  | • INTEGER<br>• INTEGER<br>• INTEGER<br>• INTEGER | This scalar function returns the year part of a value.   |
| "XMLAGG " on page 271             | SYSIBM | • XML  | • XML  | This aggregate function returns an XML sequence containing an item for each non-null value in a set of XML values.   |
| "XMLATTRIBUTES " on page 449      | SYSIBM | • Any SQL expression, but not a structured type; cannot include a scalar fullselect.   | • XML  | This scalar function constructs XML attributes from the arguments.   |
| "XMLCOMMENT " on page 451         | SYSIBM | • <i>character-type</i>  | • XML  | This scalar function returns an XML value with a single XQuery comment node with the input argument as the content.  |
| "XMLCONCAT " on page 452          | SYSIBM | • XML  | • XML  | This scalar function returns a sequence containing the concatenation of a variable number of XML input arguments.  |

Table 16. Supported functions (continued)

| Function name                 | Schema | Input  | Returns                   | Description   |
|-------------------------------|--------|--|---------------------------|---|
| "XMLDOCUMENT " on page 454    | SYSIBM | • XML  | • XML                     | This scalar function returns an XML value with a single XQuery document node with zero or more children nodes.  |
| "XMLELEMENT " on page 456     | SYSIBM | • XML  | • XML                     | This scalar function returns an XML value that is an XML element node.  |
| "XMLFOREST " on page 462      | SYSIBM | • Any SQL expression, but not a structured type; cannot include a scalar fullselect. | • XML                     | This scalar function returns an XML value that is a sequence of XML element nodes.  |
| "XMLNAMESPACES " on page 466  | SYSIBM | • <i>character-type</i>  | • XML                     | This scalar function constructs namespace declarations from the arguments.  |
| "XMLPARSE " on page 469       | SYSIBM | • <i>character-type</i><br>• BLOB  | • XML<br>• XML            | This scalar function parses the argument as an XML document and returns an XML value.   |
| "XMLPI " on page 471          | SYSIBM | • <i>character-type</i>  | • XML                     | This scalar function returns an XML value with a single XQuery processing instruction node.   |
| "XMLQUERY " on page 473       | SYSIBM | • <i>character-type</i>  | • XML                     | This scalar function returns an XML value from the evaluation of an XQuery expression possibly using specified input arguments as XQuery variables.   |
| "XMLSERIALIZE " on page 476   | SYSIBM | • <i>character-type</i><br>• BLOB  | • XML<br>• XML            | This scalar function returns a serialized XML value of the specified data type generated from the argument.   |
| "XMLTABLE " on page 488       | SYSIBM |  | >                         | This table function returns a table from the evaluation of XQuery expressions, possibly using specified input arguments as XQuery variables. Each sequence item in the result sequence of the row XQuery expression represents a row of the result table. |
| "XMLTEXT " on page 479        | SYSIBM | • <i>character-type</i>  | • XML                     | This scalar function returns an XML value with a single XQuery text node having the input argument as the content.  |
| "XMLVALIDATE " on page 481    | SYSIBM | • XML  | • XML                     | This scalar function returns a copy of the input XML value augmented with information obtained from XML schema validation, including default values and type annotations.   |
| "XMLXSROBJECTID " on page 485 | SYSIBM | • XML  | • BIGINT                  | This scalar function returns the XSR object identifier of the XML schema used to validate the XML document that is specified in the argument.   |
| "+"                           | SYSIBM | • <i>numeric-type</i> ,<br>• <i>numeric-type</i>                                     | • <i>max-numeric-type</i> | Adds two numeric operands.  |
| "+"                           | SYSIBM | • <i>numeric-type</i>  | • <i>numeric-type</i>     | Unary plus operator.  |

## Supported functions

Table 16. Supported functions (continued)

| Function name  | Schema | Input  | Returns  | Description                      |
|--|--------|--|--|----------------------------------|
| "+"  | SYSIBM | <ul style="list-style-type: none"> <li>• DATE, DECIMAL(8,0)</li> <li>• TIME, DECIMAL(6,0)</li> <li>• TIMESTAMP, DECIMAL(20,6)</li> <li>• DECIMAL(8,0), DATE</li> <li>• DECIMAL(6,0), TIME</li> <li>• DECIMAL(20,6), TIMESTAMP</li> <li>• <i>datetime-type</i>, DOUBLE, <i>labeled-duration-code</i></li> </ul>   | <ul style="list-style-type: none"> <li>• DATE</li> <li>• TIME</li> <li>• TIMESTAMP</li> <li>• DATE</li> <li>• TIME</li> <li>• TIMESTAMP</li> <li>• <i>datetime-type</i></li> </ul>   | Datetime plus operator.          |
| "_"  | SYSIBM | <ul style="list-style-type: none"> <li>• <i>numeric-type</i>, <i>numeric-type</i></li> </ul>   | <ul style="list-style-type: none"> <li>• <i>max-numeric-type</i></li> </ul>  | Subtracts two numeric operands.  |
| "-"  | SYSIBM | <ul style="list-style-type: none"> <li>• <i>numeric-type</i></li> </ul>  | <ul style="list-style-type: none"> <li>• <i>numeric-type</i><sup>1</sup></li> </ul>  | Unary minus operator.            |
| "_"  | SYSIBM | <ul style="list-style-type: none"> <li>• DATE, DATE</li> <li>• TIME, TIME</li> <li>• TIMESTAMP, TIMESTAMP</li> <li>• DATE, VARCHAR</li> <li>• TIME, VARCHAR</li> <li>• TIMESTAMP, VARCHAR</li> <li>• VARCHAR, DATE</li> <li>• VARCHAR, TIME</li> <li>• VARCHAR, TIMESTAMP</li> <li>• DATE, DECIMAL(8,0)</li> <li>• TIME, DECIMAL(6,0)</li> <li>• TIMESTAMP, DECIMAL(20,6)</li> <li>• <i>datetime-type</i>, DOUBLE, <i>labeled-duration-code</i></li> </ul> | <ul style="list-style-type: none"> <li>• DECIMAL(8,0)</li> <li>• DECIMAL(6,0)</li> <li>• DECIMAL(20,6)</li> <li>• DECIMAL(8,0)</li> <li>• DECIMAL(6,0)</li> <li>• DECIMAL(20,6)</li> <li>• DECIMAL(8,0)</li> <li>• DECIMAL(6,0)</li> <li>• DECIMAL(20,6)</li> <li>• DATE</li> <li>• TIME</li> <li>• TIMESTAMP</li> <li>• <i>datetime-type</i></li> </ul> | Datetime minus operator.         |
| "*"  | SYSIBM | <ul style="list-style-type: none"> <li>• <i>numeric-type</i>, <i>numeric-type</i></li> </ul>   | <ul style="list-style-type: none"> <li>• <i>max-numeric-type</i></li> </ul>  | Multiplies two numeric operands. |
| "/"  | SYSIBM | <ul style="list-style-type: none"> <li>• <i>numeric-type</i>, <i>numeric-type</i></li> </ul>   | <ul style="list-style-type: none"> <li>• <i>max-numeric-type</i></li> </ul>  | Divides two numeric operands.    |
| "  "   | SYSIBM |  |  | Same as CONCAT.                  |
| <b>Notes</b>   |        |  |  |                                  |
| <ul style="list-style-type: none"> <li>• References to string data types that are not qualified by a length should be assumed to support the maximum length for the data type.</li> <li>• References to a DECIMAL data type without precision and scale should be assumed to allow any supported precision and scale.</li> </ul> |        |  |  |                                  |

Table 16. Supported functions (continued)

| Function name                    | Schema | Input  | Returns | Description |
|----------------------------------|--------|--|---------|-------------|
| <b>Key to Table</b>              |        |  |         |             |
| <i>any-builtin-type</i>          |        | Any data type that is not a distinct type.   |         |             |
| <i>any-type</i>                  |        | Any type defined to the database.  |         |             |
| <i>any-structured-type</i>       |        | Any user-defined structured type defined to the database.  |         |             |
| <i>any-comparable-type</i>       |        | Any type that is comparable with other argument types as defined in “Assignments and comparisons” on page 105.   |         |             |
| <i>any-union-compatible-type</i> |        | Any type that is compatible with other argument types as defined in “Rules for result data types” on page 116.   |         |             |
| <i>character-type</i>            |        | Any of the character string types: CHAR, VARCHAR, LONG VARCHAR, CLOB.  |         |             |
| <i>compatible-string-type</i>    |        | A string type that comes from the same grouping as the other argument (for example, if one argument is a <i>character-type</i> the other must also be a <i>character-type</i> ).   |         |             |
| <i>datetime-type</i>             |        | Any of the datetime types: DATE, TIME, TIMESTAMP.  |         |             |
| <i>exact-numeric-type</i>        |        | Any of the exact numeric types: SMALLINT, INTEGER, BIGINT, DECIMAL.  |         |             |
| <i>graphic-type</i>              |        | Any of the double byte character string types: GRAPHIC, VARGRAPHIC, LONG VARGRAPHIC, DBCLOB.   |         |             |
| <i>labeled-duration-code</i>     |        | As a type this is a SMALLINT. If the function is invoked using the infix form of the plus or minus operator, labeled-durations as defined in “Expressions” can be used. For a source function that does not use the plus or minus operator character as the name, the following values must be used for the labeled-duration-code argument when invoking the function. |         |             |
|                                  | 1      | YEAR or YEARS  |         |             |
|                                  | 2      | MONTH or MONTHS  |         |             |
|                                  | 3      | DAY or DAYS  |         |             |
|                                  | 4      | HOUR or HOURS  |         |             |
|                                  | 5      | MINUTE or MINUTES  |         |             |
|                                  | 6      | SECOND or SECONDS  |         |             |
|                                  | 7      | MICROSECOND or MICROSECONDS  |         |             |
| <i>LOB-type</i>                  |        | Any of the large object types: BLOB, CLOB, DBCLOB.   |         |             |
| <i>max-numeric-type</i>          |        | The maximum numeric type of the arguments where maximum is defined as the rightmost <i>numeric-type</i> .  |         |             |
| <i>max-string-type</i>           |        | The maximum string type of the arguments where maximum is defined as the rightmost <i>character-type</i> or <i>graphic-type</i> . If arguments are BLOB, the <i>max-string-type</i> is BLOB.   |         |             |
| <i>numeric-type</i>              |        | Any of the numeric types: SMALLINT, INTEGER, BIGINT, DECIMAL, REAL, DOUBLE.  |         |             |
| <i>string-unit</i>               |        | Specifies the unit to use when determining the length of a string; can be OCTETS, CODEUNITS16, or CODEUNITS32.   |         |             |
| <i>string-type</i>               |        | Any type from <i>character-type</i> , <i>graphic-type</i> or BLOB.   |         |             |

## Supported functions

Table 16. Supported functions (continued)

| Function name          | Schema | Input | Returns | Description   |
|------------------------|--------|-------|---------|---|
| <b>Table Footnotes</b> |        |       |         |   |
| 1                      |        |       |         | When the input parameter is SMALLINT, the result type is INTEGER. When the input parameter is REAL, the result type is DOUBLE.  |
| 2                      |        |       |         | Keywords allowed are ISO, USA, EUR, JIS, and LOCAL. This function signature is not supported as a sourced function.   |
| 3                      |        |       |         | This function cannot be used as a source function.  |
| 4                      |        |       |         | The keyword ALL or DISTINCT may be used before the first parameter. If DISTINCT is specified, the use of user-defined structured types, long string types or a DATALINK type is not supported.  |
| 5                      |        |       |         | The use of user-defined structured types, long string types or a DATALINK type is not supported.  |
| 6                      |        |       |         | The type returned by RAISE_ERROR depends upon the context of its use. RAISE_ERROR, if not cast to a particular type, will return a type appropriate to its invocation within a CASE expression. |
| 7                      |        |       |         | The use of <i>graphic-type</i> , <i>LOB-type</i> , long string types, and DATALINK types is not supported.  |

Table 17. Aggregate functions

| Function                           | Description   |
|------------------------------------|---|
| "AVG " on page 259                 | Returns the average of a set of numbers.  |
| "CORRELATION " on page 261         | Returns the coefficient of correlation of a set of number pairs.  |
| "COUNT " on page 262               | Returns the number of rows or values in a set of rows or values.  |
| "COUNT_BIG " on page 263           | Returns the number of rows or values in a set of rows or values. The result can be greater than the maximum value of INTEGER.   |
| "COVARIANCE " on page 265          | Returns the covariance of a set of number pairs.  |
| "GROUPING " on page 266            | Used with grouping-sets and super-groups to indicate sub-total rows generated by a grouping set. The value returned is 0 or 1. A value of 1 means that the value of the argument in the returned row is a null value, and the row was generated for a grouping set. This generated row provides a sub-total for a grouping set. |
| "MAX " on page 268                 | Returns the maximum value in a set of values.   |
| "MIN " on page 270                 | Returns the minimum value in a set of values.   |
| "Regression functions" on page 273 | The REGR_AVGX aggregate function returns quantities used to compute diagnostic statistics.  |
| "Regression functions" on page 273 | The REGR_AVGY aggregate function returns quantities used to compute diagnostic statistics.  |
| "Regression functions" on page 273 | The REGR_COUNT aggregate function returns the number of non-null number pairs used to fit the regression line.  |
| "Regression functions" on page 273 | The REGR_INTERCEPT or REGR_ICPT aggregate function returns the y-intercept of the regression line.  |
| "Regression functions" on page 273 | The REGR_R2 aggregate function returns the coefficient of determination for the regression.   |
| "Regression functions" on page 273 | The REGR_SLOPE aggregate function returns the slope of the line.  |
| "Regression functions" on page 273 | The REGR_SXX aggregate function returns quantities used to compute diagnostic statistics.   |



Table 17. Aggregate functions (continued)

| Function                           | Description   |
|------------------------------------|---|
| "Regression functions" on page 273 | The REGR_SXY aggregate function returns quantities used to compute diagnostic statistics. |
| "Regression functions" on page 273 | The REGR_SYY aggregate function returns quantities used to compute diagnostic statistics. |
| "STDDEV " on page 276              | Returns the standard deviation of a set of numbers.                                       |
| "SUM " on page 277                 | Returns the sum of a set of numbers.  |
| "VARIANCE " on page 278            | Returns the variance of a set of numbers.   |

Table 18. Cast scalar functions

| Function                       | Description   |
|--------------------------------|---|
| "BIGINT " on page 287          | Returns a 64-bit integer representation of a number or a character string in the form of an integer constant. |
| "BLOB " on page 289            | Returns a BLOB representation of a string of any type.  |
| "CHAR " on page 291            | Returns a CHARACTER representation of a value.  |
| "CLOB " on page 298            | Returns a CLOB representation of a value.   |
| "DATE " on page 305            | Returns a DATE from a value.  |
| "DBCLOB " on page 312          | Returns a DBCLOB representation of a string.  |
| "DECIMAL " on page 315         | Returns a DECIMAL representation of a number.   |
| "DOUBLE " on page 325          | Returns a DOUBLE PRECISION representation of a number.  |
| "FLOAT " on page 331           | Returns a FLOAT representation of a number.   |
| "GRAPHIC " on page 336         | Returns a GRAPHIC representation of a string.   |
| "INTEGER " on page 348         | Returns an INTEGER representation of a number.  |
| "LONG_VARCHAR " on page 362    | Returns a LONG VARCHAR representation of a value.   |
| "LONG_VARGRAPHIC " on page 363 | Returns a LONG VARGRAPHIC representation of a value.  |
| "REAL " on page 386            | Returns a REAL representation of a number.  |
| "SMALLINT " on page 406        | Returns a SMALLINT representation of a number.  |
| "TIME " on page 422            | Returns a TIME from a value.  |
| "TIMESTAMP " on page 423       | Returns a TIMESTAMP from a value or a pair of values.   |
| "VARCHAR " on page 441         | Returns a VARCHAR representation of a value.  |
| "VARGRAPHIC " on page 445      | Returns a VARGRAPHIC representation of a value.   |

Table 19. Partitioning scalar functions

| Function                        | Description   |
|---------------------------------|---|
| "DATAPARTITIONNUM " on page 304 | Returns the sequence number (SYSDATAPARTITIONS.SEQNO) of the data partition in which the row resides. The argument is any column name within the table. |
| "DBPARTITIONNUM " on page 313   | Returns the database partition number of the row. The argument is any column name within the table.   |

## Supported functions

Table 19. Partitioning scalar functions (continued)

| Function                   | Description  |
|----------------------------|--|
| "HASHEDVALUE " on page 338 | Returns the distribution map index (0 to 4095) of the row. The argument is a column name within a table. |

Table 20. Datetime scalar functions

| Function                        | Description  |
|---------------------------------|--|
| "DAY " on page 306              | Returns the day part of a value.   |
| "DAYNAME " on page 307          | Returns a mixed case character string containing the name of the day (for example, Friday) for the day portion of the argument, based on what the locale was when db2start was issued.   |
| "DAYOFWEEK " on page 308        | Returns the day of the week from a value, where 1 is Sunday and 7 is Saturday.   |
| "DAYOFWEEK_ISO " on page 309    | Returns the day of the week from a value, where 1 is Monday and 7 is Sunday.   |
| "DAYOFYEAR " on page 310        | Returns the day of the year from a value.  |
| "DAYS " on page 311             | Returns an integer representation of a date.   |
| "HOUR " on page 342             | Returns the hour part of a value.  |
| "JULIAN_DAY " on page 350       | Returns an integer value representing the number of days from January 1, 4712 B.C. to the date specified in the argument.  |
| "MICROSECOND " on page 366      | Returns the microsecond part of a value.   |
| "MIDNIGHT_SECONDS " on page 367 | Returns an integer value representing the number of seconds between midnight and a specified time value.   |
| "MINUTE " on page 368           | Returns the minute part of a value.  |
| "MONTH " on page 370            | Returns the month part of a value.   |
| "MONTHNAME " on page 371        | Returns a mixed case character string containing the name of the month (for example, January) for the month portion of the argument that is a date or a timestamp, based on what the locale was when the database was started.   |
| "QUARTER " on page 382          | Returns an integer that represents the quarter of the year in which a date resides.  |
| "SECOND " on page 402           | Returns the seconds part of a value.   |
| "TIMESTAMP_FORMAT " on page 424 | Returns a timestamp from a character string ( <i>argument1</i> ) that has been interpreted using a format template ( <i>argument2</i> ).   |
| "TIMESTAMP_ISO " on page 426    | Returns a timestamp value based on a date, time, or timestamp argument. If the argument is a date, it inserts zero for all the time elements. If the argument is a time, it inserts the value of CURRENT DATE for the date elements, and zero for the fractional time element. |
| "TIMESTAMPDIFF " on page 427    | Returns an estimated number of intervals of type <i>argument1</i> , based on the difference between two timestamps. The second argument is the result of subtracting two timestamp types and converting the result to CHAR.  |
| "TO_CHAR " on page 429          | Returns a CHARACTER representation of a timestamp.   |

Table 20. Datetime scalar functions (continued)

| Function                      | Description   |
|-------------------------------|---|
| "TO_DATE " on page 430        | Returns a timestamp from a character string.  |
| "VARCHAR_FORMAT " on page 443 | Returns a CHARACTER representation of a timestamp ( <i>argument1</i> ), formatted according to a template ( <i>argument2</i> ). |
| "WEEK " on page 447           | Returns the week of the year from a value, where the week starts with Sunday.   |
| "WEEK_ISO " on page 448       | Returns the week of the year from a value, where the week starts with Monday.   |
| "YEAR " on page 486           | Returns the year part of a value.   |

Table 21. Numeric scalar functions

| Function                       | Description  |
|--------------------------------|--|
| "ABS or ABSVAL " on page 280   | Returns the absolute value of a number.  |
| "ACOS " on page 281            | Returns the arc cosine of a number, in radians.  |
| "ASIN " on page 283            | Returns the arc sine of a number, in radians.  |
| "ATAN " on page 284            | Returns the arc tangent of a number, in radians.   |
| "ATANH " on page 286           | Returns the hyperbolic arc tangent of a number, in radians.  |
| "ATAN2 " on page 285           | Returns the arc tangent of x and y coordinates as an angle expressed in radians.   |
| "CEILING or CEIL " on page 290 | Returns the smallest integer value that is greater than or equal to a number.  |
| "COS " on page 301             | Returns the cosine of a number.  |
| "COSH " on page 302            | Returns the hyperbolic cosine of a number.   |
| "COT " on page 303             | Returns the cotangent of the argument, where the argument is an angle expressed in radians.  |
| "DEGREES " on page 321         | Returns the number of degrees of an angle.   |
| "DIGITS " on page 324          | Returns a character-string representation of the absolute value of a number.   |
| "EXP " on page 330             | Returns a value that is the base of the natural logarithm (e) raised to a power specified by the argument.                                   |
| "FLOOR " on page 332           | Returns the largest integer value that is less than or equal to a number.  |
| "LN " on page 356              | Returns the natural logarithm of a number.   |
| "LOG " on page 360             | Returns the natural logarithm of a number (same as LN).  |
| "LOG10 " on page 361           | Returns the common logarithm (base 10) of a number.  |
| "MOD " on page 369             | Returns the remainder of the first argument divided by the second argument.  |
| "MULTIPLY_ALT " on page 372    | Returns the product of two arguments as a decimal value. This function is useful when the sum of the argument precisions is greater than 31. |
| "POWER " on page 381           | Returns the result of raising the first argument to the power of the second argument.  |
| "RADIANS " on page 383         | Returns the number of radians for an argument that is expressed in degrees.  |
| "RAND " on page 385            | Returns a random number.   |

## Supported functions

Table 21. Numeric scalar functions (continued)

| Function                         | Description  |
|----------------------------------|--|
| "ROUND " on page 394             | Returns a numeric value that has been rounded to the specified number of decimal places. |
| "SIGN " on page 403              | Returns the sign of a number.  |
| "SIN " on page 404               | Returns the sine of a number.  |
| "SINH " on page 405              | Returns the hyperbolic sine of a number.   |
| "SQRT " on page 409              | Returns the square root of a number.   |
| "TAN " on page 420               | Returns the tangent of a number.   |
| "TANH " on page 421              | Returns the hyperbolic tangent of a number.  |
| "TRUNCATE or TRUNC " on page 435 | Returns a number value that has been truncated at a specified number of decimal places.  |

Table 22. Security scalar functions

| Function                        | Description   |
|---------------------------------|---|
| "SECLABEL " on page 398         | Returns an unnamed security label.  |
| "SECLABEL_BY_NAME " on page 399 | Returns a specific security label.  |
| "SECLABEL_TO_CHAR " on page 400 | Accepts a security label and returns a string that contains all elements in the security label. |

Table 23. XML functions

| Function                     | Description  |
|------------------------------|--|
| "XMLAGG " on page 271        | Returns an XML sequence containing an item for each non-null value in a set of XML values.                                     |
| "XMLATTRIBUTES " on page 449 | Constructs XML attributes from the arguments.  |
| "XMLCOMMENT " on page 451    | Returns an XML value with a single XQuery comment node with the input argument as the content.                                 |
| "XMLCONCAT " on page 452     | Returns a sequence containing the concatenation of a variable number of XML input arguments.                                   |
| "XMLDOCUMENT " on page 454   | Returns an XML value with a single XQuery document node with zero or more children nodes.                                      |
| "XMLELEMENT " on page 456    | Returns an XML value that is an XML element node.  |
| "XMLFOREST " on page 462     | Returns an XML value that is a sequence of XML element nodes.  |
| "XMLNAMESPACES " on page 466 | Constructs namespace declarations from the arguments.  |
| "XMLPARSE " on page 469      | Parses the argument as an XML document and returns an XML value.   |
| "XMLPI " on page 471         | Returns an XML value with a single XQuery processing instruction node.   |
| "XMLQUERY " on page 473      | Returns an XML value from the evaluation of an XQuery expression possibly using specified input arguments as XQuery variables. |

Table 23. XML functions (continued)

| Function                      | Description   |
|-------------------------------|---|
| "XMLSERIALIZE " on page 476   | Returns a serialized XML value of the specified data type generated from the argument.  |
| "XMLTABLE " on page 488       | Returns a table from the evaluation of XQuery expressions, possibly using specified input arguments as XQuery variables. Each sequence item in the result sequence of the row XQuery expression represents a row of the result table. |
| "XMLTEXT " on page 479        | Returns an XML value with a single XQuery text node having the input argument as the content.   |
| "XMLVALIDATE " on page 481    | Returns a copy of the input XML value augmented with information obtained from XML schema validation, including default values and type annotations.  |
| "XMLXSROBJECTID " on page 485 | Returns the XSR object identifier of the XML schema used to validate the XML document that is specified in the argument   |

Table 24. String scalar functions

| Function                                    | Description   |
|---|---|
| "ASCII " on page 282                        | Returns the ASCII code value of the leftmost character of the argument as an integer.   |
| "CHARACTER_LENGTH " on page 295             | Returns the length of an expression in the specified <i>string-unit</i> .   |
| "CHR " on page 297                          | Returns the character that has the ASCII code value specified by the argument.  |
| "CONCAT " on page 300                       | Returns a string that is the concatenation of two strings.  |
| "DECRYPT_BIN and DECRYPT_CHAR " on page 319 | Returns a value that is the result of decrypting encrypted data using a password string.  |
| "DECRYPT_BIN and DECRYPT_CHAR " on page 319 | Returns a value that is the result of decrypting encrypted data using a password string.  |
| "DIFFERENCE " on page 323                   | Returns the difference between the sounds of the words in two argument strings, as determined by the SOUNDEX function. A value of 4 means the strings sound the same.   |
| "ENCRYPT " on page 327                      | Returns a value that is the result of encrypting a data string expression.  |
| "GENERATE_UNIQUE " on page 334              | Returns a bit data character string that is unique compared to any other execution of the same function.  |
| "GETHINT " on page 333                      | Returns the password hint if one is found.  |
| "INSERT " on page 347                       | Returns a string, where <i>argument3</i> bytes have been deleted from <i>argument1</i> (beginning at <i>argument2</i> ), and <i>argument4</i> has been inserted into <i>argument1</i> (beginning at <i>argument2</i> ). |
| "LCASE or LOWER " on page 351               | Returns a string in which all the characters have been converted to lowercase characters.   |
| "LEFT " on page 353                         | Returns the leftmost characters from a string.  |
| "LOCATE " on page 357                       | Returns the starting position of one string within another string.  |
| "LTRIM " on page 364                        | Removes blanks from the beginning of a string expression.   |

## Supported functions

Table 24. String scalar functions (continued)

| Function                      | Description  |
|-------------------------------|--|
| "OCTET_LENGTH " on page 375   | Returns the length of an expression in octets (bytes).   |
| "POSITION " on page 376       | Returns the starting position of <i>argument2</i> within <i>argument1</i> .  |
| "POSSTR " on page 379         | Returns the starting position of one string within another string.   |
| "REPEAT " on page 391         | Returns a character string composed of <i>argument1</i> repeated <i>argument2</i> times.   |
| "REPLACE " on page 392        | Replaces all occurrences of <i>argument2</i> in <i>argument1</i> with <i>argument3</i> .   |
| "RIGHT " on page 393          | Returns the rightmost characters from a string.  |
| "RTRIM " on page 396          | Removes blanks from the end of a string expression.  |
| "SOUNDEX " on page 407        | Returns a 4-character code representing the sound of the words in the argument. This result can be compared with the sound of other strings. |
| "SPACE " on page 408          | Returns a character string that consists of a specified number of blanks.  |
| "STRIP " on page 410          | Removes leading or trailing blanks or other specified leading or trailing characters from a string expression.                               |
| "SUBSTR " on page 411         | Returns a substring of a string.   |
| "SUBSTRING " on page 414      | Returns a substring of a string.   |
| "TRANSLATE " on page 431      | Returns a string in which one or more characters in a string are converted to other characters.  |
| "TRIM " on page 433           | Removes leading or trailing blanks or other specified leading or trailing characters from a string expression.                               |
| "UCASE or UPPER " on page 439 | Returns a string in which all the characters have been converted to uppercase characters.  |

Table 25. Miscellaneous scalar functions

| Function                          | Description  |
|-----------------------------------|--|
| "COALESCE " on page 299           | Returns the first argument that is not null.   |
| "DEREF " on page 322              | Returns an instance of the target type of the reference type argument.   |
| "EVENT_MON_STATE " on page 329    | Returns the operational state of particular event monitor.   |
| "HEX " on page 340                | Returns a hexadecimal representation of a value.   |
| "IDENTITY_VAL_LOCAL " on page 343 | Returns the most recently assigned value for an identity column.   |
| "LENGTH " on page 354             | Returns the length of a value.   |
| "NULLIF " on page 374             | Returns a null value if the arguments are equal; otherwise, it returns the value of the first argument.  |
| "RAISE_ERROR " on page 384        | Raises an error in the SQLCA. The sqlstate that is to be returned is indicated by <i>argument1</i> . The second argument contains any text that is to be returned. |
| "REC2XML " on page 387            | Returns a string formatted with XML tags, containing column names and column data.   |

Table 25. Miscellaneous scalar functions (continued)

| Function                    | Description   |
|-----------------------------|---|
| "TABLE_NAME " on page 417   | Returns an unqualified name of a table or view based on the object name specified in <i>argument1</i> , and the optional schema name specified in <i>argument2</i> . The returned value is used to resolve aliases. |
| "TABLE_SCHEMA " on page 418 | Returns the schema name portion of a two-part table or view name (given by the object name in <i>argument1</i> and the optional schema name in <i>argument2</i> ). The returned value is used to resolve aliases.   |
| "TYPE_ID " on page 436      | Returns the internal data type identifier of the dynamic data type of the argument. The result of this function is not portable across databases.   |
| "TYPE_NAME " on page 437    | Returns the unqualified name of the dynamic data type of the argument.  |
| "TYPE_SCHEMA " on page 438  | Returns the schema name of the dynamic data type of the argument.   |
| "VALUE " on page 440        | Returns the first argument that is not null.  |

### Aggregate functions

The argument of a column function is a set of values derived from an expression. The expression can include columns, but cannot include a *scalar-fullselect*, another column function, or an XMLQUERY or XMLEXISTS expression (SQLSTATE 42607). The scope of the set is a group or an intermediate result table.

If a GROUP BY clause is specified in a query, and the intermediate result of the FROM, WHERE, GROUP BY, and HAVING clauses is the empty set, the column functions are not applied; the result of the query is the empty set; the SQLCODE is set to +100; and the SQLSTATE is set to '02000'.

If a GROUP BY clause is *not* specified in a query, and the intermediate result of the FROM, WHERE, and HAVING clauses is the empty set, the column functions are applied to the empty set.

For example, the result of the following SELECT statement is the number of distinct values of JOBCODE for employees in department D01:

```
SELECT COUNT(DISTINCT JOBCODE)
FROM CORPDATA.EMPLOYEE
WHERE WORKDEPT = 'D01'
```

The keyword DISTINCT is not considered to be an argument of the function, but rather a specification of an operation that is performed before the function is applied. If DISTINCT is specified, duplicate values are eliminated. If ALL is implicitly or explicitly specified, duplicate values are not eliminated.

Expressions can be used in column functions. For example:

```
SELECT MAX(BONUS + 1000)
INTO :TOP_SALESREP_BONUS
FROM EMPLOYEE
WHERE COMM > 5000
```

Column functions can be qualified with a schema name (for example, SYSIBM.COUNT(\*)).

#### Related reference:

- "SQL queries" on page 505

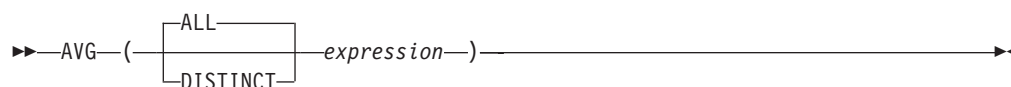

---

**AVG**

The schema is SYSIBM.

The AVG function returns the average of a set of numbers.

The argument values must be numbers (built-in types only) and their sum must be within the range of the data type of the result, except for a decimal result data type. For decimal results, their sum must be within the range supported by a decimal data type having a precision of 31 and a scale identical to the scale of the argument values. The result can be null.

The data type of the result is the same as the data type of the argument values, except that:

- The result is a large integer if the argument values are small integers.
- The result is double-precision floating point if the argument values are single-precision floating point.

If the data type of the argument values is decimal with precision  $p$  and scale  $s$ , the precision of the result is 31 and the scale is  $31-p+s$ .

The function is applied to the set of values derived from the argument values by the elimination of null values. If DISTINCT is specified, redundant duplicate values are eliminated.

If the function is applied to an empty set, the result is a null value. Otherwise, the result is the average value of the set.

The order in which the values are added is undefined, but every intermediate result must be within the range of the result data type.

If the type of the result is integer, the fractional part of the average is lost.

Examples:

- Using the PROJECT table, set the host variable AVERAGE (decimal(5,2)) to the average staffing level (PRSTAFF) of projects in department (DEPTNO) 'D11'.

```
SELECT AVG(PRSTAFF)
  INTO :AVERAGE
  FROM PROJECT
  WHERE DEPTNO = 'D11'
```

Results in AVERAGE being set to 4.25 (that is 17/4) when using the sample table.

- Using the PROJECT table, set the host variable ANY\_CALC (decimal(5,2)) to the average of each unique staffing level value (PRSTAFF) of projects in department (DEPTNO) 'D11'.

```
SELECT AVG(DISTINCT PRSTAFF)
  INTO :ANY_CALC
  FROM PROJECT
  WHERE DEPTNO = 'D11'
```

## AVG

Results in ANY\_CALC being set to 4.66 (that is 14/3) when using the sample table.

---

## CORRELATION

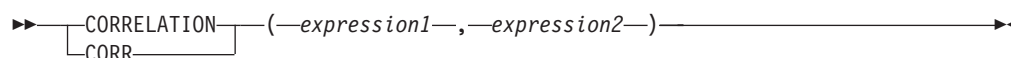

The schema is SYSIBM.

The CORRELATION function returns the coefficient of correlation of a set of number pairs.

The argument values must be numbers.

The data type of the result is double-precision floating point. The result can be null. When not null, the result is between -1 and 1.

The function is applied to the set of (*expression1*, *expression2*) pairs derived from the argument values by the elimination of all pairs for which either *expression1* or *expression2* is null.

If the function is applied to an empty set, or if either  $\text{STDDEV}(\textit{expression1})$  or  $\text{STDDEV}(\textit{expression2})$  is equal to zero, the result is a null value. Otherwise, the result is the correlation coefficient for the value pairs in the set. The result is equivalent to the following expression:

$$\frac{\text{COVARIANCE}(\textit{expression1}, \textit{expression2})}{(\text{STDDEV}(\textit{expression1}) * \text{STDDEV}(\textit{expression2}))}$$

The order in which the values are aggregated is undefined, but every intermediate result must be within the range of the result data type.

Example:

- Using the EMPLOYEE table, set the host variable CORRLN (double-precision floating point) to the correlation between salary and bonus for those employees in department (WORKDEPT) 'A00'.

```
SELECT CORRELATION(SALARY, BONUS)
  INTO :CORRLN
  FROM EMPLOYEE
  WHERE WORKDEPT = 'A00'
```

CORRLN is set to approximately 9.99853953399538E-001 when using the sample table.

---

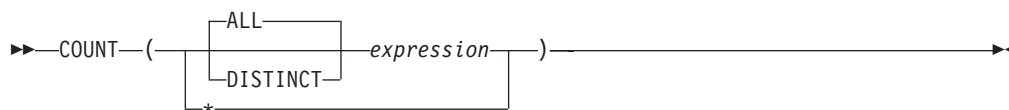
**COUNT**

The schema is SYSIBM.

The COUNT function returns the number of rows or values in a set of rows or values.

If DISTINCT is specified, the resulting data type of *expression* cannot be a LONG VARCHAR, LONG VARGRAPHIC, BLOB, CLOB, DBCLOB, DATALINK, XML, distinct type on any of these types, or structured type (SQLSTATE 42907). Otherwise the result data type of *expression* can be any data type.

The result of the function is a large integer. The result cannot be null.

The argument of COUNT(\*) is a set of rows. The result is the number of rows in the set. A row that includes only NULL values is included in the count.

The argument of COUNT(DISTINCT *expression*) is a set of values. The function is applied to the set of values derived from the argument values by the elimination of null and duplicate values. The result is the number of different non-null values in the set.

The argument of COUNT(*expression*) or COUNT(ALL *expression*) is a set of values. The function is applied to the set of values derived from the argument values by the elimination of null values. The result is the number of non-null values in the set, including duplicates.

Examples:

- Using the EMPLOYEE table, set the host variable FEMALE (int) to the number of rows where the value of the SEX column is 'F'.

```
SELECT COUNT(*)
  INTO :FEMALE
  FROM EMPLOYEE
  WHERE SEX = 'F'
```

Results in FEMALE being set to 13 when using the sample table.

- Using the EMPLOYEE table, set the host variable FEMALE\_IN\_DEPT (int) to the number of departments (WORKDEPT) that have at least one female as a member.

```
SELECT COUNT(DISTINCT WORKDEPT)
  INTO :FEMALE_IN_DEPT
  FROM EMPLOYEE
  WHERE SEX = 'F'
```

Results in FEMALE\_IN\_DEPT being set to 5 when using the sample table. (There is at least one female in departments A00, C01, D11, D21, and E11.)

---

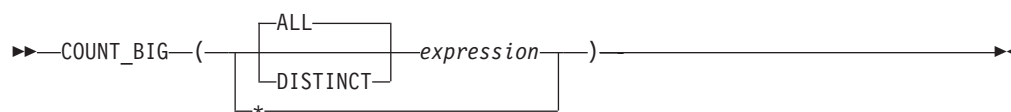
**COUNT\_BIG**

The schema is SYSIBM.

The COUNT\_BIG function returns the number of rows or values in a set of rows or values. It is similar to COUNT except that the result can be greater than the maximum value of integer.

If DISTINCT is specified, the resulting data type of *expression* cannot be a LONG VARCHAR, LONG VARGRAPHIC, BLOB, CLOB, DBCLOB, DATALINK, XML, distinct type on any of these types, or structured type (SQLSTATE 42907). Otherwise the result data type of *expression* can be any data type.

The result of the function is a decimal with precision 31 and scale 0. The result cannot be null.

The argument of COUNT\_BIG(\*) is a set of rows. The result is the number of rows in the set. A row that includes only NULL values is included in the count.

The argument of COUNT\_BIG(DISTINCT *expression*) is a set of values. The function is applied to the set of values derived from the argument values by the elimination of null and duplicate values. The result is the number of different non-null values in the set.

The argument of COUNT\_BIG(*expression*) or COUNT\_BIG(ALL *expression*) is a set of values. The function is applied to the set of values derived from the argument values by the elimination of null values. The result is the number of non-null values in the set, including duplicates.

Examples:

- Refer to COUNT examples and substitute COUNT\_BIG for occurrences of COUNT. The results are the same except for the data type of the result.
- Some applications may require the use of COUNT but need to support values larger than the largest integer. This can be achieved by use of sourced user-defined functions and setting the SQL path. The following series of statements shows how to create a sourced function to support COUNT(\*) based on COUNT\_BIG and returning a decimal value with a precision of 15. The SQL path is set such that the sourced function based on COUNT\_BIG is used in subsequent statements such as the query shown.

```
CREATE FUNCTION RICK.COUNT() RETURNS DECIMAL(15,0)
SOURCE SYSIBM.COUNT_BIG();
SET CURRENT FUNCTION PATH RICK, SYSTEM PATH;
SELECT COUNT(*) FROM EMPLOYEE;
```

Note how the sourced function is defined with no parameters to support COUNT(\*). This only works if you name the function COUNT and do not qualify the function with the schema name when it is used. To get the same effect as COUNT(\*) with a name other than COUNT, invoke the function with no parameters. Thus, if RICK.COUNT had been defined as RICK.MYCOUNT instead, the query would have to be written as follows:

## COUNT\_BIG

```
SELECT MYCOUNT() FROM EMPLOYEE;
```

If the count is taken on a specific column, the sourced function must specify the type of the column. The following statements created a sourced function that will take any CHAR column as a argument and use COUNT\_BIG to perform the counting.

```
CREATE FUNCTION RICK.COUNT(CHAR()) RETURNS DOUBLE  
SOURCE SYSIBM.COUNT_BIG(CHAR());  
SELECT COUNT(DISTINCT WORKDEPT) FROM EMPLOYEE;
```

---

**COVARIANCE**

The schema is SYSIBM.

The COVARIANCE function returns the (population) covariance of a set of number pairs.

The argument values must be numbers.

The data type of the result is double-precision floating point. The result can be null.

The function is applied to the set of (*expression1*,*expression2*) pairs derived from the argument values by the elimination of all pairs for which either *expression1* or *expression2* is null.

If the function is applied to an empty set, the result is a null value. Otherwise, the result is the covariance of the value pairs in the set. The result is equivalent to the following:

1. Let avgexp1 be the result of  $AVG(expression1)$  and let avgexp2 be the result of  $AVG(expression2)$ .
2. The result of  $COVARIANCE(expression1, expression2)$  is  $AVG( (expression1 - avgexp1) * (expression2 - avgexp2) )$

The order in which the values are aggregated is undefined, but every intermediate result must be within the range of the result data type.

Example:

- Using the EMPLOYEE table, set the host variable COVARNCE (double-precision floating point) to the covariance between salary and bonus for those employees in department (WORKDEPT) 'A00'.

```

SELECT COVARIANCE(SALARY, BONUS)
      INTO :COVARNCE
FROM EMPLOYEE
WHERE WORKDEPT = 'A00'

```

COVARNCE is set to approximately 1.6888888888889E+006 when using the sample table.

---

**GROUPING**

►► GROUPING (—*expression*—) ◀◀

The schema is SYSIBM.

Used in conjunction with grouping-sets and super-groups, the GROUPING function returns a value that indicates whether or not a row returned in a GROUP BY answer set is a row generated by a grouping set that excludes the column represented by *expression*.

The argument can be of any type, but must be an item of a GROUP BY clause.

The result of the function is a small integer. It is set to one of the following values:

- 1 The value of *expression* in the returned row is a null value, and the row was generated by the super-group. This generated row can be used to provide sub-total values for the GROUP BY expression.
- 0 The value is other than the above.

Example:

The following query:

```
SELECT SALES_DATE, SALES_PERSON,
       SUM(SALES) AS UNITS_SOLD,
       GROUPING(SALES_DATE) AS DATE_GROUP,
       GROUPING(SALES_PERSON) AS SALES_GROUP
FROM SALES
GROUP BY CUBE (SALES_DATE, SALES_PERSON)
ORDER BY SALES_DATE, SALES_PERSON
```

results in:

| SALES_DATE | SALES_PERSON | UNITS_SOLD | DATE_GROUP | SALES_GROUP |
|------------|--------------|------------|------------|-------------|
| 12/31/1995 | GOUNOT       | 1          | 0          | 0           |
| 12/31/1995 | LEE          | 6          | 0          | 0           |
| 12/31/1995 | LUCCHESSI    | 1          | 0          | 0           |
| 12/31/1995 | -            | 8          | 0          | 1           |
| 03/29/1996 | GOUNOT       | 11         | 0          | 0           |
| 03/29/1996 | LEE          | 12         | 0          | 0           |
| 03/29/1996 | LUCCHESSI    | 4          | 0          | 0           |
| 03/29/1996 | -            | 27         | 0          | 1           |
| 03/30/1996 | GOUNOT       | 21         | 0          | 0           |
| 03/30/1996 | LEE          | 21         | 0          | 0           |
| 03/30/1996 | LUCCHESSI    | 4          | 0          | 0           |
| 03/30/1996 | -            | 46         | 0          | 1           |
| 03/31/1996 | GOUNOT       | 3          | 0          | 0           |
| 03/31/1996 | LEE          | 27         | 0          | 0           |
| 03/31/1996 | LUCCHESSI    | 1          | 0          | 0           |
| 03/31/1996 | -            | 31         | 0          | 1           |
| 04/01/1996 | GOUNOT       | 14         | 0          | 0           |
| 04/01/1996 | LEE          | 25         | 0          | 0           |
| 04/01/1996 | LUCCHESSI    | 4          | 0          | 0           |
| 04/01/1996 | -            | 43         | 0          | 1           |
| -          | GOUNOT       | 50         | 1          | 0           |
| -          | LEE          | 91         | 1          | 0           |
| -          | LUCCHESSI    | 14         | 1          | 0           |
| -          | -            | 155        | 1          | 1           |



An application can recognize a SALES\_DATE sub-total row by the fact that the value of DATE\_GROUP is 0 and the value of SALES\_GROUP is 1. A SALES\_PERSON sub-total row can be recognized by the fact that the value of DATE\_GROUP is 1 and the value of SALES\_GROUP is 0. A grand total row can be recognized by the value 1 for both DATE\_GROUP and SALES\_GROUP.

**Related reference:**

- “Subselect” on page 506

## MAX

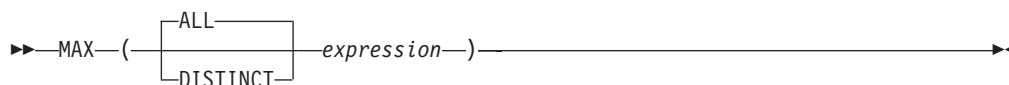

The schema is SYSIBM.

The MAX function returns the maximum value in a set of values.

The argument values can be of any built-in type other than a long string or DATALINK.

The resulting data type of *expression* cannot be a LONG VARCHAR, LONG VARGRAPHIC, BLOB, CLOB, DBCLOB, DATALINK, distinct type on any of these types, or structured type (SQLSTATE 42907).

The data type, length and code page of the result are the same as the data type, length and code page of the argument values. The result is considered to be a derived value and can be null.

The function is applied to the set of values derived from the argument values by the elimination of null values.

If the function is applied to an empty set, the result is a null value. Otherwise, the result is the maximum value in the set.

The specification of DISTINCT has no effect on the result and therefore is not recommended. It is included for compatibility with other relational systems.

Examples:

- Using the EMPLOYEE table, set the host variable MAX\_SALARY (decimal(7,2)) to the maximum monthly salary (SALARY/12) value.

```
SELECT MAX(SALARY) / 12
  INTO :MAX_SALARY
  FROM EMPLOYEE
```

Results in MAX\_SALARY being set to 4395.83 when using the sample table.

- Using the PROJECT table, set the host variable LAST\_PROJ(char(24)) to the project name (PROJNAME) that comes last in the collating sequence.

```
SELECT MAX(PROJNAME)
  INTO :LAST_PROJ
  FROM PROJECT
```

Results in LAST\_PROJ being set to 'WELD LINE PLANNING' when using the sample table.

- Similar to the previous example, set the host variable LAST\_PROJ (char(40)) to the project name that comes last in the collating sequence when a project name is concatenated with the host variable PROJSUPP. PROJSUPP is '\_Support'; it has a char(8) data type.

```
SELECT MAX(PROJNAME CONCAT PROJSUPP)
  INTO :LAST_PROJ
  FROM PROJECT
```

Results in LAST\_PROJ being set to 'WELD LINE PLANNING\_SUPPORT' when using the sample table.

---

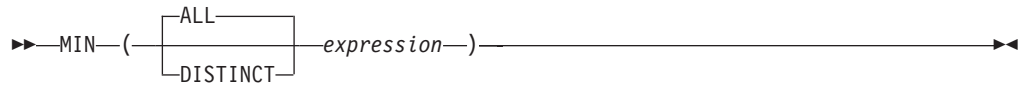
**MIN**

The MIN function returns the minimum value in a set of values.

The argument values can be of any built-in type other than a long string or DATALINK.

The resulting data type of *expression* cannot be a LONG VARCHAR, LONG VARGRAPHIC, BLOB, CLOB, DBCLOB, DATALINK, distinct type on any of these types, or structured type (SQLSTATE 42907).

The data type, length, and code page of the result are the same as the data type, length, and code page of the argument values. The result is considered to be a derived value and can be null.

The function is applied to the set of values derived from the argument values by the elimination of null values.

If this function is applied to an empty set, the result of the function is a null value. Otherwise, the result is the minimum value in the set.

The specification of DISTINCT has no effect on the result and therefore is not recommended. It is included for compatibility with other relational systems.

Examples:

- Using the EMPLOYEE table, set the host variable COMM\_SPREAD (decimal(7,2)) to the difference between the maximum and minimum commission (COMM) for the members of department (WORKDEPT) 'D11'.

```
SELECT MAX(COMM) - MIN(COMM)
  INTO :COMM_SPREAD
  FROM EMPLOYEE
  WHERE WORKDEPT = 'D11'
```

Results in COMM\_SPREAD being set to 1118 (that is, 2580 - 1462) when using the sample table.

- Using the PROJECT table, set the host variable (FIRST\_FINISHED (char(10))) to the estimated ending date (PRENDATE) of the first project scheduled to be completed.

```
SELECT MIN(PRENDATE)
  INTO :FIRST_FINISHED
  FROM PROJECT
```

Results in FIRST\_FINISHED being set to '1982-09-15' when using the sample table.

## XMLAGG

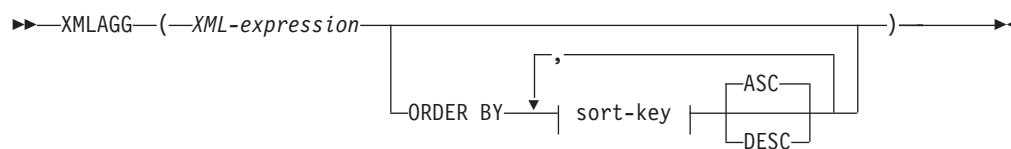

The schema is SYSIBM. The function name cannot be specified as a qualified name.

The XMLAGG function returns an XML sequence containing an item for each non-null value in a set of XML values.

### *XML-expression*

Specifies an expression of data type XML.

### **ORDER BY**

Specifies the order of the rows from the same grouping set that are processed in the aggregation. If the ORDER BY clause is omitted, or if the ORDER BY clause cannot distinguish the order of the column data, the rows in the same grouping set are arbitrarily ordered.

### *sort-key*

The sort key can be a column name or a *sort-key-expression*. Note that if the sort key is a constant, it does not refer to the position of the output column (as in the ordinary ORDER BY clause), but it is simply a constant, which implies no sort key.

The data type of the result is XML.

The function is applied to the set of values derived from the argument values by the elimination of null values.

If the *XML-expression* argument can be null, the result can be null. If the set of values is empty, the result is the null value. Otherwise, the result is an XML sequence containing an item for each value in the set.

### **Notes:**

- Support in non-Unicode databases and multiple database partition databases:** The result, at the outer level of XML value function nesting, must be an argument of the XMLSERIALIZE function.
- Support in OLAP expressions:** XMLAGG cannot be used as a column function of an OLAP aggregation function (SQLSTATE 42601).

Example:

**Note:** XMLAGG does not insert blank spaces or new line characters in the output. All example output has been formatted to enhance readability.

- Construct a department element for each department, containing a list of employees sorted by last name.

```
SELECT XMLSERIALIZE(
  CONTENT XMLELEMENT(
    NAME "Department", XMLATTRIBUTES(
      E.WORKDEPT AS "name"
    ),
    XMLAGG(
      XMLELEMENT(
```

```

        NAME "emp", E.LASTNAME
      )
      ORDER BY E.LASTNAME
    )
  )
  AS CLOB(110)
)
AS "dept_list"
FROM EMPLOYEE E
WHERE E.WORKDEPT IN ('C01','E21')
GROUP BY WORKDEPT

```

This query produces the following result:

```

dept_list
-----...
<Department name="C01">
  <emp>KWAN</emp>
  <emp>NICHOLLS</emp>
  <emp>QUINTANA</emp>
</Department>
<Department name="E21">
  <emp>GOUNOT</emp>
  <emp>LEE</emp>
  <emp>MEHTA</emp>
  <emp>SPENSER</emp>
</Department>

```

#### Related concepts:

- “Publishing XML values with SQL/XML” in *XML Guide*

#### Related reference:

- “XMLATTRIBUTES ” on page 449
- “XMLCOMMENT ” on page 451
- “XMLCONCAT ” on page 452
- “XMLDOCUMENT ” on page 454
- “XMLELEMENT ” on page 456
- “XMLFOREST ” on page 462
- “XMLNAMESPACES ” on page 466
- “XMLPARSE ” on page 469
- “XMLPI ” on page 471
- “XMLQUERY ” on page 473
- “XMLSERIALIZE ” on page 476
- “XMLTEXT ” on page 479
- “XMLVALIDATE ” on page 481

## Regression functions

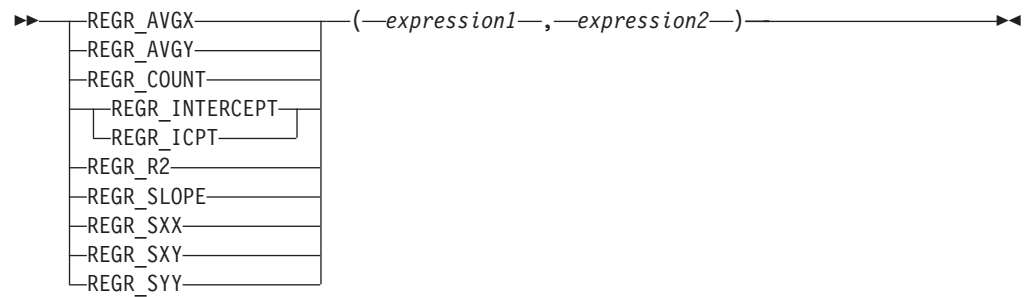

The schema is SYSIBM.

The regression functions support the fitting of an ordinary-least-squares regression line of the form  $y = a * x + b$  to a set of number pairs. The first element of each pair (*expression1*) is interpreted as a value of the dependent variable (that is, a "y value"). The second element of each pair (*expression2*) is interpreted as a value of the independent variable (that is, an "x value").

The REGR\_COUNT function returns the number of non-null number pairs used to fit the regression line (see below).

The REGR\_INTERCEPT (or REGR\_ICPT) function returns the y-intercept of the regression line ("b" in the above equation).

The REGR\_R2 function returns the coefficient of determination ("R-squared" or "goodness-of-fit") for the regression.

The REGR\_SLOPE function returns the slope of the line ("a" in the above equation).

The REGR\_AVGX, REGR\_AVGY, REGR\_SXX, REGR\_SXY, and REGR\_SYY functions return quantities that can be used to compute various diagnostic statistics needed for the evaluation of the quality and statistical validity of the regression model (see below).

The argument values must be numbers.

The data type of the result of REGR\_COUNT is integer. For the remaining functions, the data type of the result is double precision floating point. The result can be null. When not null, the result of REGR\_R2 is between 0 and 1, and the result of both REGR\_SXX and REGR\_SYY is non-negative.

Each function is applied to the set of (*expression1*, *expression2*) pairs derived from the argument values by the elimination of all pairs for which either *expression1* or *expression2* is null.

If the set is not empty and  $\text{VARIANCE}(\text{expression2})$  is positive, REGR\_COUNT returns the number of non-null pairs in the set, and the remaining functions return results that are defined as follows:

**REGR\_SLOPE**(*expression1*,*expression2*) =  
**COVARIANCE**(*expression1*,*expression2*)/**VARIANCE**(*expression2*)

## Regression functions

```
REGR_INTERCEPT(expression1, expression2) =
AVG(expression1) - REGR_SLOPE(expression1, expression2) * AVG(expression2)
REGR_R2(expression1, expression2) =
POWER(CORRELATION(expression1, expression2), 2) if VARIANCE(expression1)>0
REGR_R2(expression1, expression2) = 1 if VARIANCE(expression1)=0
REGR_AVGX(expression1, expression2) = AVG(expression2)
REGR_AVGY(expression1, expression2) = AVG(expression1)
REGR_SXX(expression1, expression2) =
REGR_COUNT(expression1, expression2) * VARIANCE(expression2)
REGR_SYY(expression1, expression2) =
REGR_COUNT(expression1, expression2) * VARIANCE(expression1)
REGR_SXY(expression1, expression2) =
REGR_COUNT(expression1, expression2) * COVARIANCE(expression1, expression2)
```

If the set is not empty and `VARIANCE(expression2)` is equal to zero, then the regression line either has infinite slope or is undefined. In this case, the functions `REGR_SLOPE`, `REGR_INTERCEPT`, and `REGR_R2` each return a null value, and the remaining functions return values as defined above. If the set is empty, `REGR_COUNT` returns zero and the remaining functions return a null value.

The order in which the values are aggregated is undefined, but every intermediate result must be within the range of the result data type.

The regression functions are all computed simultaneously during a single pass through the data. In general, it is more efficient to use the regression functions to compute the statistics needed for a regression analysis than to perform the equivalent computations using ordinary column functions such as `AVERAGE`, `VARIANCE`, `COVARIANCE`, and so forth.

The usual diagnostic statistics that accompany a linear-regression analysis can be computed in terms of the above functions. For example:

### Adjusted R2

$$1 - (1 - \text{REGR\_R2}) * ((\text{REGR\_COUNT} - 1) / (\text{REGR\_COUNT} - 2))$$

### Standard error

$$\text{SQRT}((\text{REGR\_SYY} - (\text{POWER}(\text{REGR\_SXY}, 2) / \text{REGR\_SXX})) / (\text{REGR\_COUNT} - 2))$$

### Total sum of squares

$$\text{REGR\_SYY}$$

### Regression sum of squares

$$\text{POWER}(\text{REGR\_SXY}, 2) / \text{REGR\_SXX}$$

### Residual sum of squares

$$(\text{Total sum of squares}) - (\text{Regression sum of squares})$$

### t statistic for slope

$$\text{REGR\_SLOPE} * \text{SQRT}(\text{REGR\_SXX}) / (\text{Standard error})$$

### t statistic for y-intercept

$$\text{REGR\_INTERCEPT} / ((\text{Standard error}) * \text{SQRT}((1 / \text{REGR\_COUNT}) + (\text{POWER}(\text{REGR\_AVGX}, 2) / \text{REGR\_SXX})))$$

Example:

- Using the `EMPLOYEE` table, compute an ordinary-least-squares regression line that expresses the bonus of an employee in department (`WORKDEPT`) 'A00' as a linear function of the employee's salary. Set the host variables `SLOPE`, `ICPT`,



RSQR (double-precision floating point) to the slope, intercept, and coefficient of determination of the regression line, respectively. Also set the host variables AVGSAL and AVGBONUS to the average salary and average bonus, respectively, of the employees in department 'A00', and set the host variable CNT (integer) to the number of employees in department 'A00' for whom both salary and bonus data are available. Store the remaining regression statistics in host variables SXX, SYY, and SXY.

```
SELECT REGR_SLOPE(BONUS,SALARY), REGR_INTERCEPT(BONUS,SALARY),
REGR_R2(BONUS,SALARY), REGR_COUNT(BONUS,SALARY),
REGR_AVGX(BONUS,SALARY), REGR_AVGY(BONUS,SALARY),
REGR_SXX(BONUS,SALARY), REGR_SYY(BONUS,SALARY),
REGR_SXY(BONUS,SALARY)
INTO :SLOPE, :ICPT,
:RSQR, :CNT,
:AVGSAL, :AVGBONUS,
:SXX, :SYY,
:SXY
FROM EMPLOYEE
WHERE WORKDEPT = 'A00'
```

When using the sample table, the host variables are set to the following approximate values:

```
SLOPE: +1.71002671916749E-002
ICPT: +1.00871888623260E+002
RSQR: +9.99707928128685E-001
CNT: 3
AVGSAL: +4.28333333333333E+004
AVGBONUS: +8.33333333333333E+002
SXX: +2.96291666666667E+008
SYY: +8.66666666666667E+004
SXY: +5.06666666666667E+006
```

---

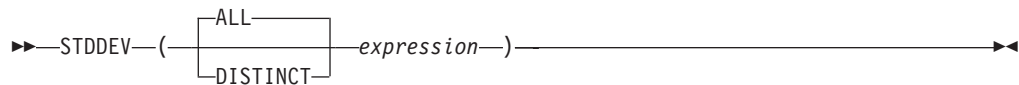
**STDDEV**

The schema is SYSIBM.

The STDDEV function returns the standard deviation ( $/n$ ) of a set of numbers. The formula used to calculate STDDEV is:

$$\text{STDDEV} = \text{SQRT}(\text{VARIANCE})$$

where SQRT(VARIANCE) is the square root of the variance.

The argument values must be numbers.

The data type of the result is double-precision floating point. The result can be null.

The function is applied to the set of values derived from the argument values by the elimination of null values. If DISTINCT is specified, redundant duplicate values are eliminated.

If the function is applied to an empty set, the result is a null value. Otherwise, the result is the standard deviation of the values in the set.

The order in which the values are aggregated is undefined, but every intermediate result must be within the range of the result data type.

Example:

- Using the EMPLOYEE table, set the host variable DEV (double-precision floating point) to the standard deviation of the salaries of employees in department (WORKDEPT) 'A00'.

```
SELECT STDDEV(SALARY)
  INTO :DEV
  FROM EMPLOYEE
  WHERE WORKDEPT = 'A00'
```

DEV is set to a number with an approximate value of 9938.00.

---

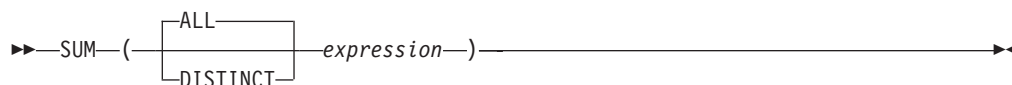
**SUM**

The schema is SYSIBM.

The SUM function returns the sum of a set of numbers.

The argument values must be numbers (built-in types only) and their sum must be within the range of the data type of the result.

The data type of the result is the same as the data type of the argument values except that:

- The result is a large integer if the argument values are small integers.
- The result is double-precision floating point if the argument values are single-precision floating point.

If the data type of the argument values is decimal, the precision of the result is 31 and the scale is the same as the scale of the argument values. The result can be null.

The function is applied to the set of values derived from the argument values by the elimination of null values. If DISTINCT is specified, redundant duplicate values are also eliminated.

If the function is applied to an empty set, the result is a null value. Otherwise, the result is the sum of the values in the set.

Example:

- Using the EMPLOYEE table, set the host variable JOB\_BONUS (decimal(9,2)) to the total bonus (BONUS) paid to clerks (JOB='CLERK').

```
SELECT SUM(BONUS)
  INTO :JOB_BONUS
  FROM EMPLOYEE
  WHERE JOB = 'CLERK'
```

Results in JOB\_BONUS being set to 2800 when using the sample table.

## VARIANCE

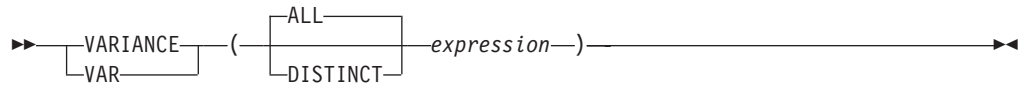

The schema is SYSIBM.

The VARIANCE function returns the variance of a set of numbers.

The argument values must be numbers.

The data type of the result is double-precision floating point. The result can be null.

The function is applied to the set of values derived from the argument values by the elimination of null values. If DISTINCT is specified, redundant duplicate values are eliminated.

If the function is applied to an empty set, the result is a null value. Otherwise, the result is the variance of the values in the set.

The order in which the values are added is undefined, but every intermediate result must be within the range of the result data type.

Example:

- Using the EMPLOYEE table, set the host variable VARNCE (double-precision floating point) to the variance of the salaries for those employees in department (WORKDEPT) 'A00'.

```
SELECT VARIANCE(SALARY)
  INTO :VARNCE
  FROM EMPLOYEE
  WHERE WORKDEPT = 'A00'
```

Results in VARNCE being set to approximately 98763888.88 when using the sample table.

---

## Scalar functions

A scalar function can be used wherever an expression can be used. However, the restrictions that apply to the use of expressions and column functions also apply when an expression or column function is used within a scalar function. For example, the argument of a scalar function can be a column function only if a column function is allowed in the context in which the scalar function is used.

The restrictions on the use of column functions do not apply to scalar functions, because a scalar function is applied to a single value rather than to a set of values.

The result of the following `SELECT` statement has as many rows as there are employees in department D01:

```
SELECT EMPNO, LASTNAME, YEAR(CURRENT DATE - BRTHDATE)
FROM EMPLOYEE
WHERE WORKDEPT = 'D01'
```

Scalar functions can be qualified with a schema name (for example, `SYSIBM.CHAR(123)`).

In a Unicode database, all scalar functions that accept a character or graphic string will accept any string types for which conversion is supported.

---

## ABS or ABSVAL

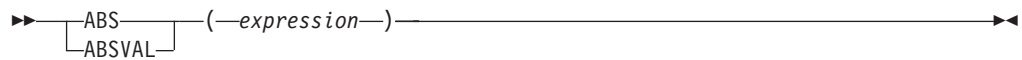

The schema is SYSIBM.

This function was first available in FixPak 2 of Version 7.1. The SYSFUN version of the ABS (or ABSVAL) function continues to be available.

Returns the absolute value of the argument. The argument can be any built-in numeric data type.

The result has the same data type and length attribute as the argument. The result can be null; if the argument is null, the result is the null value. If the argument is the maximum negative value for SMALLINT, INTEGER or BIGINT, the result is an overflow error.

Example:

**ABS(-51234)**

returns an INTEGER with a value of 51234.

---

## ACOS

►►—ACOS—(—*expression*—)—————►►

The schema is SYSIBM. (The SYSFUN version of the ACOS function continues to be available.)

Returns the arccosine of the argument as an angle expressed in radians.

The argument can be of any built-in numeric data type. It is converted to a double-precision floating-point number for processing by the function.

The result of the function is a double-precision floating-point number. The result can be null if the argument can be null or the database is configured with DFT\_SQLMATHWARN set to YES; the result is the null value if the argument is null.

Example:

Assume that the host variable ACOSINE is a DECIMAL(10,9) host variable with a value of 0.070737202.

```
SELECT ACOS(:ACOSINE)
FROM SYSIBM.SYSDUMMY1
```

This statement returns the approximate value 1.49.

### ASCII

►►—ASCII—(*—expression—*)—◄◄

The schema is SYSFUN.

Returns the ASCII code value of the leftmost character of the argument as an integer.

The argument can be of any built-in character string type. In a Unicode database, if a supplied argument is a graphic string, it is first converted to a character string before the function is executed. For a VARCHAR, the maximum length is 4 000 bytes, and for a CLOB, the maximum length is 1 048 576 bytes. LONG VARCHAR is converted to CLOB for processing by the function.

The result of the function is always INTEGER.

The result can be null; if the argument is null, the result is the null value.



---

## ASIN

►► ASIN(*expression*) ◄◄

The schema is SYSIBM. (The SYSFUN version of the ASIN function continues to be available.)

Returns the arcsine on the argument as an angle expressed in radians.

The argument can be of any built-in numeric type. It is converted to a double-precision floating-point number for processing by the function.

The result of the function is a double-precision floating-point number. The result can be null if the argument can be null or the database is configured with DFT\_SQLMATHWARN set to YES; the result is the null value if the argument is null.

---

**ATAN**

►► **ATAN** (*—expression—*) ◀◀

The schema is SYSIBM. (The SYSFUN version of the ATAN function continues to be available.)

Returns the arctangent of the argument as an angle expressed in radians.

The argument can be of any built-in numeric data type. It is converted to a double-precision floating-point number for processing by the function.

The result of the function is a double-precision floating-point number. The result can be null if the argument can be null or the database is configured with DFT\_SQLMATHWARN set to YES; the result is the null value if the argument is null.

---

## ATAN2

►►—ATAN2—(—*expression*—,—*expression*—)—————►

The schema is SYSIBM. (The SYSFUN version of the ATAN2 function continues to be available.)

Returns the arctangent of x and y coordinates as an angle expressed in radians. The x and y coordinates are specified by the first and second arguments, respectively.

The first and the second arguments can be of any built-in numeric data type. Both are converted to a double-precision floating-point number for processing by the function.

The result of the function is a double-precision floating-point number. The result can be null if the argument can be null or the database is configured with DFT\_SQLMATHWARN set to YES; the result is the null value if the argument is null.

---

**ATANH**

►►—ATANH—(*expression*)—◄◄

The schema is SYSIBM.

Returns the hyperbolic arctangent of the argument, where the argument is an angle expressed in radians.

The argument can be of any built-in numeric data type. It is converted to a double-precision floating-point number for processing by the function.

The result of the function is a double-precision floating-point number. The result can be null if the argument can be null or the database is configured with DFT\_SQLMATHWARN set to YES; the result is the null value if the argument is null.

## BIGINT

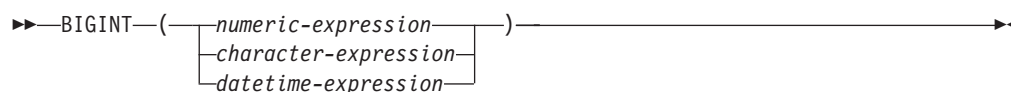

The schema is SYSIBM.

The BIGINT function returns a 64-bit integer representation of a number, character string, date, time, or timestamp in the form of an integer constant. In a Unicode database, if a supplied argument is a graphic string, it is first converted to a character string before the function is executed.

*numeric-expression*

An expression that returns a value of any built-in numeric data type.

If the argument is a *numeric-expression*, the result is the same number that would occur if the argument were assigned to a big integer column or variable. If the whole part of the argument is not within the range of integers, an error occurs. The decimal part of the argument is truncated if present.

*character-expression*

An expression that returns a character string value of length not greater than the maximum length of a character constant. Leading and trailing blanks are eliminated and the resulting string must conform to the rules for forming an SQL integer constant (SQLSTATE 22018). The character string cannot be a long string.

If the argument is a *character-expression*, the result is the same number that would occur if the corresponding integer constant were assigned to a big integer column or variable.

*datetime-expression*

An expression that is of one of the following data types:

- DATE. The result is a BIGINT value representing the date as *yyyymmdd*.
- TIME. The result is a BIGINT value representing the time as *hhmmss*.
- TIMESTAMP. The result is a BIGINT value representing the timestamp as *yyyymmddhhmmss*. The microseconds portion of the timestamp value is not included in the result.

The result of the function is a big integer. If the argument can be null, the result can be null; if the argument is null, the result is the null value.

Examples:

- From ORDERS\_HISTORY table, count the number of orders and return the result as a big integer value.
 

```
SELECT BIGINT (COUNT_BIG(*))
FROM ORDERS_HISTORY
```
- Using the EMPLOYEE table, select the EMPNO column in big integer form for further processing in the application.
 

```
SELECT BIGINT (EMPNO) FROM EMPLOYEE
```
- Assume that the column RECEIVED (timestamp) has an internal value equivalent to '1988-12-22-14.07.21.136421'.
 

```
BIGINT(RECEIVED)
```

## BIGINT

results in the value 19 881 222 140 721.

- Assume that the column STARTTIME (time) has an internal value equivalent to '12:03:04'.

**BIGINT**(STARTTIME)

results in the value 120 304.

---

**BLOB**

►► BLOB ( *string-expression* [ , *integer* ] ) ◀◀

The schema is SYSIBM.

The BLOB function returns a BLOB representation of a string of any type.

*string-expression*

A *string-expression* whose value can be a character string, graphic string, or a binary string.

*integer*

An integer value specifying the length attribute of the resulting BLOB data type. If *integer* is not specified, the length attribute of the result is the same as the length of the input, except where the input is graphic. In this case, the length attribute of the result is twice the length of the input.

The result of the function is a BLOB. If the argument can be null, the result can be null; if the argument is null, the result is the null value.

Examples

- Given a table with a BLOB column named TOPOGRAPHIC\_MAP and a VARCHAR column named MAP\_NAME, locate any maps that contain the string 'Pellow Island' and return a single binary string with the map name concatenated in front of the actual map.

```
SELECT BLOB(MAP_NAME CONCAT ': ') CONCAT TOPOGRAPHIC_MAP
FROM ONTARIO_SERIES_4
WHERE TOPOGRAPHIC_MAP LIKE BLOB('%Pellow Island%')
```

---

## CEILING or CEIL

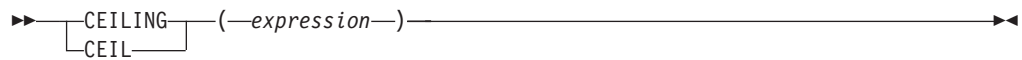

The schema is SYSIBM. (The SYSFUN version of the CEILING or CEIL function continues to be available.)

Returns the smallest integer value greater than or equal to the argument.

The argument can be of any built-in numeric type. The result of the function has the same data type and length attribute as the argument except that the scale is 0 if the argument is DECIMAL. For example, an argument with a data type of DECIMAL(5,5) returns DECIMAL(5,0).

The result can be null if the argument can be null or the database is configured with DFT\_SQLMATHWARN set to YES; the result is the null value if the argument is null.



---

**CHAR**
**Character to Character:**

►► CHAR(*—character-expression*, *—integer*)

**Datetime to Character:**

►► CHAR(*—datetime-expression*, *ISO*, *USA*, *EUR*, *JIS*, *LOCAL*)

**Integer to Character:**

►► CHAR(*—integer-expression*)

**Decimal to Character:**

►► CHAR(*—decimal-expression*, *—decimal-character*)

**Floating-point to Character:**

►► CHAR(*—floating-point-expression*, *—decimal-character*)

The schema is SYSIBM. The function name cannot be specified as a qualified name when keywords are used in the function signature. The SYSFUN.CHAR(*floating-point-expression*) signature continues to be available. In this case, the decimal character is locale sensitive, and therefore returns either a period or a comma, depending on the locale of the database server.

The CHAR function returns a fixed-length character string representation of:

- A character string, if the first argument is any type of character string
- A datetime value, if the first argument is a date, time, or timestamp
- An integer number, if the first argument is a SMALLINT, INTEGER, or BIGINT
- A decimal number, if the first argument is a decimal number
- A double-precision floating-point number, if the first argument is a DOUBLE or REAL

The first argument must be of a built-in data type. In a Unicode database, if a supplied argument is a graphic string, it is first converted to a character string before the function is executed.

**Note:** The CAST expression can also be used to return a string expression.

The result of the function is a fixed-length character string. If the first argument can be null, the result can be null. If the first argument is null, the result is the null value.

### Character to Character

#### *character-expression*

An expression that returns a value that is of the CHAR, VARCHAR, LONG VARCHAR, or CLOB data type.

#### *integer*

The length attribute of the resulting fixed-length character string. The value must be between 0 and 254.

If the length of the character expression is less than the length attribute of the result, the result is padded with blanks up to the length of the result. If the length of the character expression is greater than the length attribute of the result, the result is truncated. A warning is returned (SQLSTATE 01004), unless the truncated characters were all blanks, and the character expression was not a long string (LONG VARCHAR or CLOB).

### Datetime to Character

#### *datetime-expression*

An expression that is of one of the following three data types:

**date** The result is the character string representation of the date in the format specified by the second argument. The length of the result is 10. An error is returned if the second argument is specified and is not a valid value (SQLSTATE 42703).

**time** The result is the character string representation of the time in the format specified by the second argument. The length of the result is 8. An error is returned if the second argument is specified and is not a valid value (SQLSTATE 42703).

#### **timestamp**

The result is the character string representation of the timestamp. The length of the result is 26. The second argument is not applicable and must not be specified (SQLSTATE 42815).

The code page of the string is the code page of the database at the application server.

### Integer to Character

#### *integer-expression*

An expression that returns a value that is of an integer data type (either SMALLINT, INTEGER, or BIGINT).

The result is the character string representation of the argument in the form of an SQL integer constant. The result consists of *n* characters, which represent the significant digits in the argument, and is preceded by a minus sign if the argument is negative. The result is left justified.

- If the first argument is a small integer, the length of the result is 6.
- If the first argument is a large integer, the length of the result is 11.
- If the first argument is a big integer, the length of the result is 20.

If the number of bytes in the result is less than the defined length of the result, the result is padded on the right with blanks.

The code page of the string is the code page of the database at the application server.

### Decimal to Character

#### *decimal-expression*

An expression that returns a value that is a decimal data type. If a different precision and scale are required, the DECIMAL scalar function can be used first to make the change.

#### *decimal-character*

Specifies the single-byte character constant that is used to delimit the decimal digits in the result character string. The character constant cannot be a digit, the plus sign (+), the minus sign (-), or a blank (SQLSTATE 42815). The default is the period (.) character.

The result is the fixed-length character string representation of the argument. The result includes a decimal character and  $p$  digits, where  $p$  is the precision of the *decimal-expression*, with a preceding minus sign if the argument is negative. The length of the result is  $2 + p$ , where  $p$  is the precision of the *decimal-expression*. This means that a positive value will always include one trailing blank.

The code page of the string is the code page of the database at the application server.

### Floating-point to Character

#### *floating-point-expression*

An expression that returns a value that is a floating-point data type (DOUBLE or REAL).

#### *decimal-character*

Specifies the single-byte character constant that is used to delimit the decimal digits in the result character string. The character constant cannot be a digit, the plus sign (+), the minus sign (-), or a blank (SQLSTATE 42815). The default is the period (.) character.

The result is the fixed-length character string representation of the argument in the form of a floating-point constant. The length of the result is 24. If the argument is negative, the first character of the result is a minus sign; otherwise, the first character is a digit. If the argument value is zero, the result is 0E0; otherwise, the result includes the smallest number of characters that can represent the value of the argument, such that the mantissa consists of a single digit other than zero followed by the *decimal-character* and a sequence of digits. If the number of bytes in the result is less than 24, the result is padded on the right with blanks.

The code page of the string is the code page of the database at the application server.

Examples:

- Assume that the PRSTDAT column has an internal value equivalent to 1988-12-25. The following function returns the value '12/25/1988'.

```
CHAR(PRSTDAT, USA)
```

## CHAR

- Assume that the STARTING column has an internal value equivalent to 17:12:30, and that the host variable HOUR\_DUR (decimal(6,0)) is a time duration with a value of 050000 (that is, 5 hours). The following function returns the value '5:12 PM'.

```
CHAR(STARTING, USA)
```

The following function returns the value '10:12 PM'.

```
CHAR(STARTING + :HOUR_DUR, USA)
```

- Assume that the RECEIVED column (TIMESTAMP) has an internal value equivalent to the combination of the PRSTDATE and STARTING columns. The following function returns the value '1988-12-25-17.12.30.000000'.

```
CHAR(RECEIVED)
```

- The LASTNAME column is defined as VARCHAR(15). The following function returns the values in this column as fixed-length character strings that are 10 bytes long. LASTNAME values that are more than 10 bytes long (excluding trailing blanks) are truncated and a warning is returned.

```
SELECT CHAR(LASTNAME,10) FROM EMPLOYEE
```

- The EDLEVEL column is defined as SMALLINT. The following function returns the values in this column as fixed-length character strings. An EDLEVEL value of 18 is returned as the CHAR(6) value '18 ' ('18' followed by four blanks).

```
SELECT CHAR(EDLEVEL) FROM EMPLOYEE
```

- The SALARY column is defined as DECIMAL with a precision of 9 and a scale of 2. The current value (18357.50) is to be displayed with a comma as the decimal character (18357,50). The following function returns the value '00018357,50'.

```
CHAR(SALARY, ',')
```

- Values in the SALARY column are to be subtracted from 20000.25 and displayed with the default decimal character. The following function returns the value '-0001642.75'.

```
CHAR(20000.25 - SALARY)
```

- Assume that the host variable SEASONS\_TICKETS is defined as INTEGER and has a value of 10000. The following function returns the value '10000.00 '.

```
CHAR(DECIMAL(:SEASONS_TICKETS,7,2))
```

- Assume that the host variable DOUBLE\_NUM is defined as DOUBLE and has a value of -987.654321E-35. The following function returns the value '-9.87654321E-33 '. Because the result data type is CHAR(24), there are nine trailing blanks in the result.

```
CHAR(:DOUBLE_NUM)
```

### Related reference:

- "Expressions" on page 173
- "VARCHAR " on page 441

## CHARACTER\_LENGTH

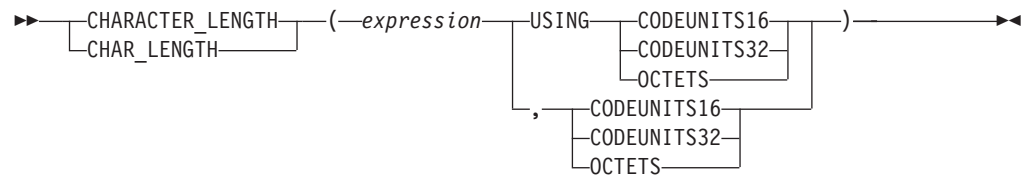

The schema is SYSIBM.

The CHARACTER\_LENGTH function returns the length of *expression* in the specified string unit.

*expression*

An expression that returns a value of a built-in character or graphic string.

### CODEUNITS16, CODEUNITS32, or OCTETS

Specifies the string unit of the result. CODEUNITS16 specifies that the result is to be expressed in 16-bit UTF-16 code units. CODEUNITS32 specifies that the result is to be expressed in 32-bit UTF-32 code units. OCTETS specifies that the result is to be expressed in bytes.

If a string unit is specified as CODEUNITS16 or CODEUNITS32, and *expression* is a binary string or bit data, an error is returned (SQLSTATE 428GC). If a string unit is specified as OCTETS and *expression* is a binary string, an error is returned (SQLSTATE 42815). For more information about CODEUNITS16, CODEUNITS32, and OCTETS, see “String units in built-in functions” in “Character strings”.

The result of the function is a large integer. If the argument can be null, the result can be null; if the argument is null, the result is the null value.

The length of character and graphic strings includes trailing blanks. The length of binary strings includes binary zeroes. The length of varying-length strings is the actual length and not the maximum length.

Examples:

- Assume that NAME is a VARCHAR(128) column, encoded in Unicode UTF-8, that contains the value 'Jürgen'. The following two queries return the value 6:

```
SELECT CHARACTER_LENGTH(NAME, CODEUNITS32)
FROM T1 WHERE NAME = 'Jürgen'
```

```
SELECT CHARACTER_LENGTH(NAME, CODEUNITS16)
FROM T1 WHERE NAME = 'Jürgen'
```

The following two queries return the value 7:

```
SELECT CHARACTER_LENGTH(NAME, OCTETS)
FROM T1 WHERE NAME = 'Jürgen'
```

```
SELECT LENGTH(NAME)
FROM T1 WHERE NAME = 'Jürgen'
```

- The following examples work with the Unicode string '&N~AB', where '&' is the musical symbol G clef character, and '~' is the combining tilde character. This string is shown below in different Unicode encoding forms:

## CHARACTER\_LENGTH

|          | '&'         | 'N'         | '~'         | 'A'         | 'B'         |
|----------|-------------|-------------|-------------|-------------|-------------|
| UTF-8    | X'F09D849E' | X'4E'       | X'CC83'     | X'41'       | X'42'       |
| UTF-16BE | X'D834DD1E' | X'004E'     | X'0303'     | X'0041'     | X'0042'     |
| UTF-32BE | X'0001D11E' | X'0000004E' | X'00000303' | X'00000041' | X'00000042' |

Assume that the variable UTF8\_VAR contains the UTF-8 representation of the string.

```
SELECT CHARACTER_LENGTH(UTF8_VAR, CODEUNITS16),
       CHARACTER_LENGTH(UTF8_VAR, CODEUNITS32),
       CHARACTER_LENGTH(UTF8_VAR, OCTETS)
FROM SYSIBM.SYSDUMMY1
```

returns the values 6, 5, and 9, respectively.

Assume that the variable UTF16\_VAR contains the UTF-16BE representation of the string.

```
SELECT CHARACTER_LENGTH(UTF16_VAR, CODEUNITS16),
       CHARACTER_LENGTH(UTF16_VAR, CODEUNITS32),
       CHARACTER_LENGTH(UTF16_VAR, OCTETS)
FROM SYSIBM.SYSDUMMY1
```

returns the values 6, 5, and 12, respectively.

### Related reference:

- "Character strings" on page 81
- "LENGTH " on page 354
- "OCTET\_LENGTH " on page 375
- "POSITION " on page 376
- "SUBSTRING " on page 414

---

**CHR**

►►—CHR—(—*expression*—)—————►►

The schema is SYSFUN.

Returns the character that has the ASCII code value specified by the argument. If *expression* is 0, the result is the blank character (X'20').

The argument can be either INTEGER or SMALLINT. The value of the argument should be between 0 and 255; otherwise, the return value is null.

The result of the function is CHAR(1). The result can be null; if the argument is null, the result is the null value.

---

**CLOB**

►► CLOB ( (*character-string-expression* , *integer* ) )

The schema is SYSIBM.

The CLOB function returns a CLOB representation of a character string type. In a Unicode database, if a supplied argument is a graphic string, it is first converted to a character string before the function is executed.

*character-string-expression*

An expression that returns a value that is a character string. The expression cannot be a character string defined as FOR BIT DATA (SQLSTATE 42846).

*integer*

An integer value specifying the length attribute of the resulting CLOB data type. The value must be between 0 and 2 147 483 647. If a value for *integer* is not specified, the length of the result is the same as the length of the first argument.

The result of the function is a CLOB. If the argument can be null, the result can be null; if the argument is null, the result is the null value.



## COALESCE

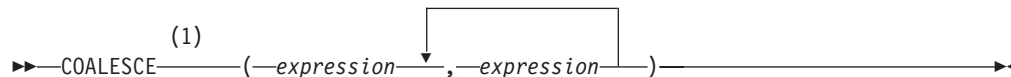

### Notes:

- 1 VALUE is a synonym for COALESCE.

The schema is SYSIBM.

COALESCE returns the first argument that is not null.

The arguments are evaluated in the order in which they are specified, and the result of the function is the first argument that is not null. The result can be null only if all the arguments can be null, and the result is null only if all the arguments are null. The selected argument is converted, if necessary, to the attributes of the result.

The arguments must be compatible. They can be of either a built-in or user-defined data type. (This function cannot be used as a source function when creating a user-defined function. Because this function accepts any compatible data types as arguments, it is not necessary to create additional signatures to support user-defined distinct types.)

### Examples:

- When selecting all the values from all the rows in the DEPARTMENT table, if the department manager (MGRNO) is missing (that is, null), then return a value of 'ABSENT'.

```
SELECT DEPTNO, DEPTNAME, COALESCE(MGRNO, 'ABSENT'), ADMRDEPT
FROM DEPARTMENT
```

- When selecting the employee number (EMPNO) and salary (SALARY) from all the rows in the EMPLOYEE table, if the salary is missing (that is, null), then return a value of zero.

```
SELECT EMPNO, COALESCE(SALARY, 0)
FROM EMPLOYEE
```

### Related reference:

- “Rules for result data types” on page 116

---

## CONCAT

(1)  
▶▶ CONCAT (—*expression1*—, —*expression2*—) ▶▶

**Notes:**

1 || can be used as a synonym for CONCAT.

The schema is SYSIBM.

Returns the concatenation of two string arguments. The two arguments must be compatible types.

The result of the function is a string whose length is the sum of the lengths of the two arguments. If either argument can be null, the result can be null; if either argument is null, the result is the null value.

**Related reference:**

- “Expressions” on page 173

---

## COS

►►—COS—(—*expression*—)—————►◄

The schema is SYSIBM. (The SYSFUN version of the COS function continues to be available.)

Returns the cosine of the argument, where the argument is an angle expressed in radians.

The argument can be of any built-in numeric type. It is converted to a double-precision floating-point number for processing by the function.

The result of the function is a double-precision floating-point number. The result can be null if the argument can be null or the database is configured with DFT\_SQLMATHWARN set to YES; the result is the null value if the argument is null.

---

**COSH**

►►—COSH—(—*expression*—)—————►◄

The schema is SYSIBM.

Returns the hyperbolic cosine of the argument, where the argument is an angle expressed in radians.

The argument can be of any built-in numeric data type. It is converted to a double-precision floating-point number for processing by the function.

The result of the function is a double-precision floating-point number. The result can be null if the argument can be null or the database is configured with DFT\_SQLMATHWARN set to YES; the result is the null value if the argument is null.

---

## COT

►► COT(*expression*) ◀◀

The schema is SYSIBM. (The SYSFUN version of the COT function continues to be available.)

Returns the cotangent of the argument, where the argument is an angle expressed in radians.

The argument can be of any built-in numeric type. It is converted to a double-precision floating-point number for processing by the function.

The result of the function is a double-precision floating-point number. The result can be null if the argument can be null or the database is configured with DFT\_SQLMATHWARN set to YES; the result is the null value if the argument is null.

---

**DATAPARTITIONNUM**

►►—DATAPARTITIONNUM—(—*column-name*—)—————►►

The schema is SYSIBM.

The DATAPARTITIONNUM function returns the sequence number (SYSDATAPARTITIONS.SEQNO) of the data partition in which the row resides. Data partitions are sorted by range, and sequence numbers start at 0. For example, the DATAPARTITIONNUM function returns 0 for a row that resides in the data partition with the lowest range.

The argument must be the qualified or unqualified name of any column in the table. Because row-level information is returned, the result is the same regardless of which column is specified. The column can have any data type.

If *column-name* references a column in a view, the expression for the column in the view must reference a column of the underlying base table, and the view must be deletable. A nested or common table expression follows the same rules as a view.

The data type of the result is INTEGER and is never null. If there is no db2nodes.cfg file, the result is 0.

This function cannot be used as a source function when creating a user-defined function. Because the function accepts any data type as an argument, it is not necessary to create additional signatures to support user-defined distinct types.

The DATAPARTITIONNUM function cannot be used within check constraints or in the definition of generated columns (SQLSTATE 42881). The DATAPARTITIONNUM function cannot be used in a materialized query table (MQT) definition (SQLSTATE 428EC).

Example:

- **SELECT DATAPARTITIONNUM (EMPNO, EMPNAME)  
FROM EMPLOYEE**

To convert from a sequence number (for example, 0) to a data partition name that can be used in other SQL statements (such as, for example, ALTER TABLE...DETACH PARTITION), you can query the system catalog.

```
SELECT DATAPARTITIONNAME  
FROM SYSCAT.DATAPARTITIONS  
WHERE TABNAME = 'EMPLOYEE' AND SEQNO = 0
```

results in the value 'PART0'.

---

**DATE**

►► **DATE**—(*expression*)—◄◄

The schema is SYSIBM.

The DATE function returns a date from a value.

The argument must be a date, timestamp, a positive number less than or equal to 3 652 059, a valid string representation of a date or timestamp, or a string of length 7 that is not a CLOB, LONG VARCHAR, DBCLOB, or LONG VARGRAPHIC.

Only Unicode databases support an argument that is a graphic string representation of a date or a timestamp. In a Unicode database, if a supplied argument is a graphic string, it is first converted to a character string before the function is executed.

If the argument is a string of length 7, it must represent a valid date in the form *yyyymmnn*, where *yyyy* are digits denoting a year, and *mmnn* are digits between 001 and 366, denoting a day of that year.

The result of the function is a date. If the argument can be null, the result can be null; if the argument is null, the result is the null value.

The other rules depend on the data type of the argument:

- If the argument is a date, timestamp, or valid string representation of a date or timestamp:
  - The result is the date part of the value.
- If the argument is a number:
  - The result is the date that is *n*-1 days after January 1, 0001, where *n* is the integral part of the number.
- If the argument is a string with a length of 7:
  - The result is the date represented by the string.

Examples:

Assume that the column RECEIVED (timestamp) has an internal value equivalent to '1988-12-25-17.12.30.000000'.

- This example results in an internal representation of '1988-12-25'.  
**DATE**(RECEIVED)
- This example results in an internal representation of '1988-12-25'.  
**DATE**('1988-12-25')
- This example results in an internal representation of '1988-12-25'.  
**DATE**('25.12.1988')
- This example results in an internal representation of '0001-02-04'.  
**DATE**(35)

---

**DAY**

►►—DAY—(—expression—)—————►►

The schema is SYSIBM.

The DAY function returns the day part of a value.

The argument must be a date, timestamp, date duration, timestamp duration, or a valid character string representation of a date or timestamp that is neither a CLOB nor a LONG VARCHAR. In a Unicode database, if a supplied argument is a graphic string, it is first converted to a character string before the function is executed.

The result of the function is a large integer. If the argument can be null, the result can be null; if the argument is null, the result is the null value.

The other rules depend on the data type of the argument:

- If the argument is a date, timestamp, or valid string representation of a date or timestamp:
  - The result is the day part of the value, which is an integer between 1 and 31.
- If the argument is a date duration or timestamp duration:
  - The result is the day part of the value, which is an integer between –99 and 99. A nonzero result has the same sign as the argument.

Examples:

- Using the PROJECT table, set the host variable END\_DAY (smallint) to the day that the WELD LINE PLANNING project (PROJNAME) is scheduled to stop (PRENDATE).

```
SELECT DAY(PRENDATE)
INTO :END_DAY
FROM PROJECT
WHERE PROJNAME = 'WELD LINE PLANNING'
```

Results in END\_DAY being set to 15 when using the sample table.

- Assume that the column DATE1 (date) has an internal value equivalent to 2000-03-15 and the column DATE2 (date) has an internal value equivalent to 1999-12-31.

```
DAY (DATE1 - DATE2)
```

Results in the value 15.



---

**DAYNAME**

►►—DAYNAME—(—*expression*—)—————►◄

The schema is SYSFUN.

Returns a mixed case character string containing the name of the day (for example, Friday) for the day portion of the argument based on the locale when the database was started.

The argument must be a date, timestamp, or a valid character string representation of a date or timestamp that is neither a CLOB nor a LONG VARCHAR. In a Unicode database, if a supplied argument is a graphic string, it is first converted to a character string before the function is executed.

The result of the function is VARCHAR(100). The result can be null; if the argument is null, the result is the null value.

---

**DAYOFWEEK**

►►—DAYOFWEEK—(*expression*)—◄◄

Returns the day of the week in the argument as an integer value in the range 1-7, where 1 represents Sunday.

The argument must be a date, timestamp, or a valid character string representation of a date or timestamp that is neither a CLOB nor a LONG VARCHAR. In a Unicode database, if a supplied argument is a graphic string, it is first converted to a character string before the function is executed.

The result of the function is INTEGER. The result can be null; if the argument is null, the result is the null value.

---

## DAYOFWEEK\_ISO

►►—DAYOFWEEK\_ISO—(*expression*)—◄◄

The schema is SYSFUN.

Returns the day of the week in the argument as an integer value in the range 1-7, where 1 represents Monday.

The argument must be a date, timestamp, or a valid character string representation of a date or timestamp that is neither a CLOB nor a LONG VARCHAR. In a Unicode database, if a supplied argument is a graphic string, it is first converted to a character string before the function is executed.

The result of the function is INTEGER. The result can be null; if the argument is null, the result is the null value.

---

**DAYOFYEAR**

►►—DAYOFYEAR—(*expression*)—◀◀

The schema is SYSFUN.

Returns the day of the year in the argument as an integer value in the range 1-366.

The argument must be a date, timestamp, or a valid character string representation of a date or timestamp that is neither a CLOB nor a LONG VARCHAR. In a Unicode database, if a supplied argument is a graphic string, it is first converted to a character string before the function is executed.

The result of the function is INTEGER. The result can be null; if the argument is null, the result is the null value.

## DAYS

►►—DAYS—(—*expression*—)—————►►

The schema is SYSIBM.

The DAYS function returns an integer representation of a date.

The argument must be a date, timestamp, or a valid character string representation of a date or timestamp that is neither a CLOB nor a LONG VARCHAR. In a Unicode database, if a supplied argument is a graphic string, it is first converted to a character string before the function is executed.

The result of the function is a large integer. If the argument can be null, the result can be null; if the argument is null, the result is the null value.

The result is 1 more than the number of days from January 1, 0001 to *D*, where *D* is the date that would occur if the DATE function were applied to the argument.

Examples:

- Using the PROJECT table, set the host variable EDUCATION\_DAYS (int) to the number of elapsed days (PRENDATE - PRSTDATE) estimated for the project (PROJNO) 'IF2000'.

```
SELECT DAYS(PRENDATE) - DAYS(PRSTDATE)
INTO :EDUCATION_DAYS
FROM PROJECT
WHERE PROJNO = 'IF2000'
```

Results in EDUCATION\_DAYS being set to 396.

- Using the PROJECT table, set the host variable TOTAL\_DAYS (int) to the sum of elapsed days (PRENDATE - PRSTDATE) estimated for all projects in department (DEPTNO) 'E21'.

```
SELECT SUM(DAYS(PRENDATE) - DAYS(PRSTDATE))
INTO :TOTAL_DAYS
FROM PROJECT
WHERE DEPTNO = 'E21'
```

Results in TOTAL\_DAYS being set to 1584 when using the sample table.

---

## DBCLOB

►► DBCLOB ( *graphic-expression* [ , *integer* ] )

The schema is SYSIBM.

The DBCLOB function returns a DBCLOB representation of a graphic string type.

In a Unicode database, if a supplied argument is a character string, it is first converted to a graphic string before the function is executed. When the output string is truncated, such that the last character is a high surrogate, that surrogate is either:

- Left as is, if the supplied argument is a character string
- Converted to the blank character (X'0020'), if the supplied argument is a graphic string

Do not rely on these behaviors, because they might change in a future release.

The result of the function is a DBCLOB. If the argument can be null, the result can be null; if the argument is null, the result is the null value.

*graphic-expression*

An expression that returns a value that is a graphic string.

*integer*

An integer value specifying the length attribute of the resulting DBCLOB data type. The value must be between 0 and 1 073 741 823. If *integer* is not specified, the length of the result is the same as the length of the first argument.

---

## DBPARTITIONNUM

►►—DBPARTITIONNUM—(—*column-name*—)—————►►

The schema is SYSIBM.

The DBPARTITIONNUM function returns the database partition number for a row. For example, if used in a SELECT clause, it returns the database partition number for each row in the result set.

The argument must be the qualified or unqualified name of any column in the table. Because row-level information is returned, the result is the same regardless of which column is specified. The column can have any data type.

If *column-name* references a column in a view, the expression for the column in the view must reference a column of the underlying base table, and the view must be deletable. A nested or common table expression follows the same rules as a view.

The specific row (and table) for which the database partition number is returned by the DBPARTITIONNUM function is determined from the context of the SQL statement that uses the function.

The database partition number returned on transition variables and tables is derived from the current transition values of the distribution key columns. For example, in a before insert trigger, the function returns the projected database partition number, given the current values of the new transition variables. However, the values of the distribution key columns might be modified by a subsequent before insert trigger. Thus, the final database partition number of the row when it is inserted into the database might differ from the projected value.

The data type of the result is INTEGER and is never null. If there is no db2nodes.cfg file, the result is 0.

This function cannot be used as a source function when creating a user-defined function. Because the function accepts any data type as an argument, it is not necessary to create additional signatures to support user-defined distinct types.

The DBPARTITIONNUM function cannot be used on replicated tables, within check constraints, or in the definition of generated columns (SQLSTATE 42881).

For compatibility with previous versions of DB2, NODENUMBER can be specified in place of DBPARTITIONNUM.

Examples:

- Count the number of instances in which the row for a given employee in the EMPLOYEE table is on a different database partition than the description of the employee's department in the DEPARTMENT table.

```
SELECT COUNT(*) FROM DEPARTMENT D, EMPLOYEE E
WHERE D.DEPTNO=E.WORKDEPT
AND DBPARTITIONNUM(E.LASTNAME) <> DBPARTITIONNUM(D.DEPTNO)
```

- Join the EMPLOYEE and DEPARTMENT tables so that the rows of the two tables are on the same database partition.

```
SELECT * FROM DEPARTMENT D, EMPLOYEE E
WHERE DBPARTITIONNUM(E.LASTNAME) = DBPARTITIONNUM(D.DEPTNO)
```

## DBPARTITIONNUM

- Using a before trigger on the EMPLOYEE table, log the employee number and the projected database partition number of any new row in the EMPLOYEE table in a table named EMPINSERTLOG1.

```
CREATE TRIGGER EMPINSLOGTRIG1
BEFORE INSERT ON EMPLOYEE
REFERENCING NEW AS NEWTABLE
FOR EACH ROW
INSERT INTO EMPINSERTLOG1
VALUES (NEWTABLE.EMPNO, DBPARTITIONNUM
(NEWTABLE.EMPNO))
```

### Related reference:

- “CREATE VIEW statement” in *SQL Reference, Volume 2*

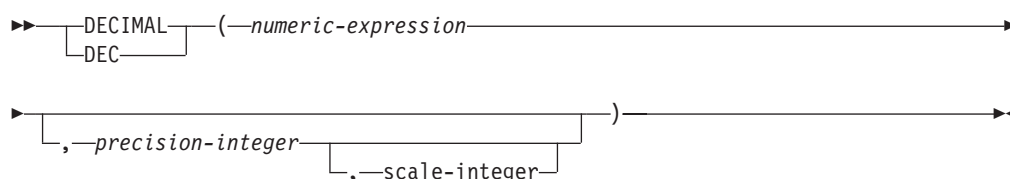
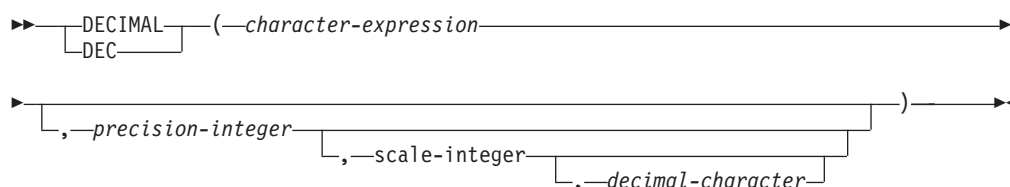
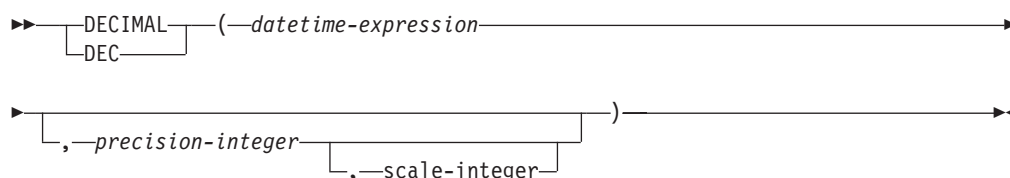

## DECIMAL

**Numeric to Decimal:****Character to Decimal:****Datetime to Decimal:**

The schema is SYSIBM.

The DECIMAL function returns a decimal representation of:

- A number
- A character string representation of a decimal number
- A character string representation of an integer number
- A character string representation of a floating-point number
- A datetime value if the argument is a date, time, or timestamp

In a Unicode database, if a supplied argument is a graphic string, it is first converted to a character string before the function is executed.

The result of the function is a decimal number with precision  $p$  and scale  $s$ , where  $p$  and  $s$  are the second and third arguments, respectively. If the first argument can be null, the result can be null; if the first argument is null, the result is the null value.

**Numeric to Decimal**

*numeric-expression*

An expression that returns a value of any numeric data type.

*precision-integer*

An integer constant with a value in the range of 1 to 31.

## DECIMAL

The default for *precision-integer* depends on the data type of *numeric-expression*:

- 15 for floating-point and decimal
- 19 for big integer
- 11 for large integer
- 5 for small integer.

*scale-integer*

An integer constant in the range of 0 to the *precision-integer* value. The default is zero.

The result is the same number that would occur if the first argument were assigned to a decimal column or variable with precision  $p$  and scale  $s$ , where  $p$  and  $s$  are the second and third arguments, respectively. An error occurs if the number of significant decimal digits required to represent the whole part of the number is greater than  $p-s$ .

### Character to Decimal

*character-expression*

An *expression* that returns a value that is a character string with a length not greater than the maximum length of a character constant (4 000 bytes). It cannot have a CLOB or LONG VARCHAR data type. Leading and trailing blanks are eliminated from the string. The resulting substring must conform to the rules for forming an SQL integer or decimal constant (SQLSTATE 22018).

The *character-expression* is converted to the database code page if required to match the code page of the constant *decimal-character*.

*precision-integer*

An integer constant with a value in the range 1 to 31 that specifies the precision of the result. If not specified, the default is 15.

*scale-integer*

An integer constant with a value in the range 0 to *precision-integer* that specifies the scale of the result. If not specified, the default is 0.

*decimal-character*

Specifies the single-byte character constant used to delimit the decimal digits in *character-expression* from the whole part of the number. The character cannot be a digit, plus (+), minus (-), or blank, and it can appear at most once in *character-expression* (SQLSTATE 42815).

The result is a decimal number with precision  $p$  and scale  $s$ , where  $p$  and  $s$  are the second and third arguments, respectively. Digits are truncated from the end of the decimal number if the number of digits to the right of the decimal character is greater than the scale. An error occurs if the number of significant digits to the left of the decimal character (the whole part of the number) in *character-expression* is greater than  $p-s$  (SQLSTATE 22003). The default decimal character is not valid in the substring if a different value for the *decimal-character* argument is specified (SQLSTATE 22018).

### Datetime to Decimal

*datetime-expression*

An expression that is of one of the following data types:

- DATE. The result is a DECIMAL(8,0) value representing the date as *yyyymmdd*.

- TIME. The result is a DECIMAL(6,0) value representing the time as *hhmmss*.
- TIMESTAMP. The result is a DECIMAL(20,6) value representing the timestamp as *yyyymmddhhmmss.nnnnnn*.

This function allows the user to specify a precision, or a precision and a scale. However, a scale cannot be specified without specifying a precision. The default value for (precision,scale) is (8,0) for DATE, (6,0) for TIME, and (20,6) for TIMESTAMP.

The result is a decimal number with precision *p* and scale *s*, where *p* and *s* are the second and third arguments, respectively. Digits are truncated from the end if the number of digits to the right of the decimal character is greater than the scale. An error occurs if the number of significant digits to the left of the decimal character (the whole part of the number) in *datetime-expression* is greater than *p-s* (SQLSTATE 22003).

Examples:

- Use the DECIMAL function in order to force a DECIMAL data type (with a precision of 5 and a scale of 2) to be returned in a select-list for the EDLEVEL column (data type = SMALLINT) in the EMPLOYEE table. The EMPNO column should also appear in the select list.

```
SELECT EMPNO, DECIMAL(EDLEVEL,5,2)
FROM EMPLOYEE
```

- Assume the host variable PERIOD is of type INTEGER. Then, in order to use its value as a date duration it must be "cast" as decimal(8,0).

```
SELECT PRSTDATE + DECIMAL(:PERIOD,8)
FROM PROJECT
```

- Assume that updates to the SALARY column are input through a window as a character string using comma as a decimal character (for example, the user inputs 21400,50). Once validated by the application, it is assigned to the host variable newsalary which is defined as CHAR(10).

```
UPDATE STAFF
SET SALARY = DECIMAL(:newsalary, 9, 2, ',')
WHERE ID = :empid;
```

The value of newsalary becomes 21400.50.

- Add the default decimal character (.) to a value.

```
DECIMAL('21400,50', 9, 2, '.')
```

This fails because a period (.) is specified as the decimal character, but a comma (,) appears in the first argument as a delimiter.

- Assume that the column STARTING (time) has an internal value equivalent to '12:10:00'.

```
DECIMAL(STARTING)
```

results in the value 121 000.

- Assume that the column RECEIVED (timestamp) has an internal value equivalent to '1988-12-22-14.07.21.136421'.

```
DECIMAL(RECEIVED)
```

results in the value 19 881 222 140 721.136421.

- The following table shows the decimal result and resulting precision and scale for various datetime input values.

## DECIMAL

| <b>DECIMAL(arguments)</b>                  | <b>Precision and Scale</b> | <b>Result</b>         |
|--|----------------------------|-----------------------|
| DECIMAL(2000-03-21)                        | (8,0)                      | 20000321              |
| DECIMAL(2000-03-21, 10)                    | (10,0)                     | 20000321              |
| DECIMAL(2000-03-21, 12, 2)                 | (12,2)                     | 20000321.00           |
| DECIMAL(12:02:21)                          | (6,0)                      | 120221                |
| DECIMAL(12:02:21, 10)                      | (10,0)                     | 120221                |
| DECIMAL(12:02:21, 10, 2)                   | (10,2)                     | 120221.00             |
| DECIMAL(2000-03-21-12.02.21.123456)        | (20, 6)                    | 20000321120221.123456 |
| DECIMAL(2000-03-21-12.02.21.123456, 23)    | (23, 6)                    | 20000321120221.123456 |
| DECIMAL(2000-03-21-12.02.21.123456, 23, 4) | (23, 4)                    | 20000321120221.1234   |

## DECRYPT\_BIN and DECRYPT\_CHAR

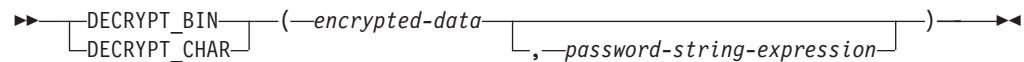

The schema is SYSIBM.

The DECRYPT\_BIN and DECRYPT\_CHAR functions both return a value that is the result of decrypting *encrypted-data*. The password used for decryption is either the *password-string-expression* value or the encryption password value that was assigned by the SET ENCRYPTION PASSWORD statement. The DECRYPT\_BIN and DECRYPT\_CHAR functions can only decrypt values that are encrypted using the ENCRYPT function (SQLSTATE 428FE).

### *encrypted-data*

An expression that returns a CHAR FOR BIT DATA or VARCHAR FOR BIT DATA value as a complete, encrypted data string. The data string must have been encrypted using the ENCRYPT function.

### *password-string-expression*

An expression that returns a CHAR or VARCHAR value with at least 6 bytes and no more than 127 bytes (SQLSTATE 428FC). This expression must be the same password used to encrypt the data (SQLSTATE 428FD). If the value of the password argument is null or not provided, the data will be decrypted using the encryption password value that was assigned for the session by the SET ENCRYPTION PASSWORD statement (SQLSTATE 51039).

The result of the DECRYPT\_BIN function is VARCHAR FOR BIT DATA. The result of the DECRYPT\_CHAR function is VARCHAR. If *encrypted-data* included a hint, the hint is not returned by the function. The length attribute of the result is the length of the data type of *encrypted-data* minus 8 bytes. The actual length of the value returned by the function will match the length of the original string that was encrypted. If *encrypted-data* includes bytes beyond the encrypted string, these bytes are not returned by the function.

If the first argument can be null, the result can be null. If the first argument is null, the result is the null value.

If the data is decrypted on a different system, which uses a code page that is different from the code page in which the data was encrypted, expansion might occur when converting the decrypted value to the database code page. In such situations, the *encrypted-data* value should be cast to a VARCHAR string with a larger number of bytes.

Examples:

- Use the SET ENCRYPTION PASSWORD statement to set an encryption password for the session.

```
CREATE TABLE EMP (SSN VARCHAR(24) FOR BIT DATA);
SET ENCRYPTION PASSWORD = 'Ben123';
INSERT INTO EMP(SSN) VALUES ENCRYPT('289-46-8832');
SELECT DECRYPT_CHAR(SSN)
FROM EMP;
```

This query returns the value '289-46-8832'.

- Pass the encryption password explicitly.

## DECRYPT\_BIN and DECRYPT\_CHAR

```
INSERT INTO EMP (SSN) VALUES ENCRYPT('289-46-8832','Ben123','');
SELECT DECRYPT_CHAR(SSN,'Ben123')
FROM EMP;
```

This query returns the value '289-46-8832'.

### Related reference:

- "ENCRYPT " on page 327
- "GETHINT " on page 333
- "SET ENCRYPTION PASSWORD statement" in *SQL Reference, Volume 2*

---

## DEGREES

►►—DEGREES—(*—expression—*)—◄◄

The schema is SYSFUN.

Returns the number of degrees converted from the argument expressed in radians.

The argument can be of any built-in numeric type. It is converted to a double-precision floating-point number for processing by the function.

The result of the function is a double-precision floating-point number. The result can be null; if the argument is null, the result is the null value.

---

**DEREF**

►►—DEREF—(*—expression—*)—◄◄

The Deref function returns an instance of the target type of the argument.

The argument can be any value with a reference data type that has a defined scope (SQLSTATE 428DT).

The static data type of the result is the target type of the argument. The dynamic data type of the result is a subtype of the target type of the argument. The result can be null. The result is the null value if *expression* is a null value or if *expression* is a reference that has no matching OID in the target table.

The result is an instance of the subtype of the target type of the reference. The result is determined by finding the row of the target table or target view of the reference that has an object identifier that matches the reference value. The type of this row determines the dynamic type of the result. Since the type of the result can be based on a row of a subtable or subview of the target table or target view, the authorization ID of the statement must have SELECT privilege on the target table and all of its subtables or the target view and all of its subviews (SQLSTATE 42501).

Examples:

Assume that EMPLOYEE is a table of type EMP, and that its object identifier column is named EMPID. Then the following query returns an object of type EMP (or one of its subtypes), for each row of the EMPLOYEE table (and its subtables). This query requires SELECT privilege on EMPLOYEE and all its subtables.

```
SELECT Deref(EMPID) FROM EMPLOYEE
```

**Related reference:**

- "TYPE\_NAME " on page 437



---

## DIFFERENCE

►►—DIFFERENCE—(—*expression*—,—*expression*—)—————►►

The schema is SYSFUN.

Returns a value from 0 to 4 representing the difference between the sounds of two strings based on applying the SOUNDEX function to the strings. A value of 4 is the best possible sound match.

The arguments can be character strings that are either CHAR or VARCHAR up to 4 000 bytes. In a Unicode database, if a supplied argument is a graphic string, it is first converted to a character string before the function is executed.

The result of the function is INTEGER. The result can be null; if the argument is null, the result is the null value.

Example:

```
VALUES (DIFFERENCE('CONSTRAINT', 'CONSTANT'), SOUNDEX('CONSTRAINT'),
        SOUNDEX('CONSTANT')),
        (DIFFERENCE('CONSTRAINT', 'CONTRITE'), SOUNDEX('CONSTRAINT'),
        SOUNDEX('CONTRITE'))
```

This example returns the following.

```
1          2      3
-----
4 C523 C523
2 C523 C536
```

In the first row, the words have the same result from SOUNDEX while in the second row the words have only some similarity.

**Related reference:**

- “SOUNDEX ” on page 407

---

**DIGITS**

►►—DIGITS—(*expression*)—◄◄

The schema is SYSIBM.

The DIGITS function returns a character-string representation of a number.

The argument must be an expression that returns a value of type SMALLINT, INTEGER, BIGINT or DECIMAL.

If the argument can be null, the result can be null; if the argument is null, the result is the null value.

The result of the function is a fixed-length character string representing the absolute value of the argument without regard to its scale. The result does not include a sign or a decimal character. Instead, it consists exclusively of digits, including, if necessary, leading zeros to fill out the string. The length of the string is:

- 5 if the argument is a small integer
- 10 if the argument is a large integer
- 19 if the argument is a big integer
- $p$  if the argument is a decimal number with a precision of  $p$ .

Examples:

- Assume that a table called TABLEX contains an INTEGER column called INTCOL containing 10-digit numbers. List all distinct four digit combinations of the first four digits contained in column INTCOL.

```
SELECT DISTINCT SUBSTR(DIGITS(INTCOL),1,4)  
FROM TABLEX
```

- Assume that COLUMNX has the DECIMAL(6,2) data type, and that one of its values is -6.28. Then, for this value:

```
DIGITS(COLUMNX)
```

returns the value '000628'.

The result is a string of length six (the precision of the column) with leading zeros padding the string out to this length. Neither sign nor decimal point appear in the result.

---

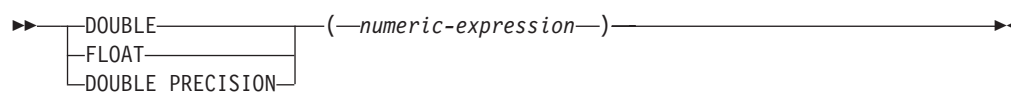
**DOUBLE**
**Numeric to Double:****Character String to Double:**

The schema is SYSIBM. However, the schema for `DOUBLE(string-expression)` is SYSFUN.

The `DOUBLE` function returns a floating-point number corresponding to a:

- number if the argument is a numeric expression
- character string representation of a number if the argument is a string expression.

In a Unicode database, if a supplied argument is a graphic string, it is first converted to a character string before the function is executed.

**Numeric to Double***numeric-expression*

The argument is an expression that returns a value of any built-in numeric data type.

The result of the function is a double-precision floating-point number. If the argument can be null, the result can be null; if the argument is null, the result is the null value.

The result is the same number that would occur if the argument were assigned to a double-precision floating-point column or variable.

**Character String to Double***string-expression*

The argument can be of type `CHAR` or `VARCHAR` in the form of a numeric constant. Leading and trailing blanks in argument are ignored.

The result of the function is a double-precision floating-point number. The result can be null; if the argument is null, the result is the null value.

The result is the same number that would occur if the string was considered a constant and assigned to a double-precision floating-point column or variable.

**Example:**

Using the `EMPLOYEE` table, find the ratio of salary to commission for employees whose commission is not zero. The columns involved (`SALARY` and `COMM`) have `DECIMAL` data types. To eliminate the possibility of out-of-range results, `DOUBLE` is applied to `SALARY` so that the division is carried out in floating point:

## DOUBLE

```
SELECT EMPNO, DOUBLE(SALARY)/COMM  
FROM EMPLOYEE  
WHERE COMM > 0
```

## ENCRYPT

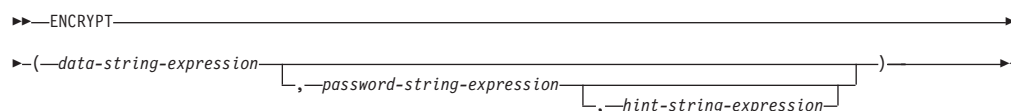

The schema is SYSIBM.

The ENCRYPT function returns a value that is the result of encrypting *data-string-expression*. The password used for encryption is either the *password-string-expression* value or the encryption password value that was assigned by the SET ENCRYPTION PASSWORD statement. In a Unicode database, if a supplied argument is a graphic string, it is first converted to a character string before the function is executed.

#### *data-string-expression*

An expression that returns a CHAR or a VARCHAR value that is to be encrypted. The length attribute for the data type of *data-string-expression* is limited to 32663 without a *hint-string-expression* argument, and 32631 when the *hint-string-expression* argument is specified (SQLSTATE 42815).

#### *password-string-expression*

An expression that returns a CHAR or a VARCHAR value with at least 6 bytes and no more than 127 bytes (SQLSTATE 428FC). The value represents the password used to encrypt *data-string-expression*. If the value of the password argument is null or not provided, the data will be encrypted using the encryption password value that was assigned for the session by the SET ENCRYPTION PASSWORD statement (SQLSTATE 51039).

#### *hint-string-expression*

An expression that returns a CHAR or a VARCHAR value with at most 32 bytes that will help data owners remember passwords (for example, 'Ocean' as a hint to remember 'Pacific'). If a hint value is given, the hint is embedded into the result and can be retrieved using the GETHINT function. If this argument is null or not provided, no hint will be embedded in the result.

The result data type of the function is VARCHAR FOR BIT DATA.

- When the optional hint parameter is specified, the length attribute of the result is equal to the length attribute of the unencrypted data + 8 bytes + the number of bytes until the next 8-byte boundary + 32 bytes for the length of the hint.
- When the optional hint parameter is not specified, the length attribute of the result is equal to the length attribute of the unencrypted data + 8 bytes + the number of bytes until the next 8-byte boundary.

If the first argument can be null, the result can be null. If the first argument is null, the result is the null value.

Note that the encrypted result is longer than the *data-string-expression* value. Therefore, when assigning encrypted values, ensure that the target is declared with sufficient size to contain the entire encrypted value.

#### Notes:

- **Encryption Algorithm:** The internal encryption algorithm is RC2 block cipher with padding; the 128-bit secret key is derived from the password using an MD5 message digest.

## ENCRYPT

- **Encryption Passwords and Data:** Password management is the user's responsibility. Once the data is encrypted, only the password that was used when encrypting it can be used to decrypt it (SQLSTATE 428FD).  
The encrypted result might contain null terminator and other unprintable characters. Any assignment or cast to a length that is shorter than the suggested data length might result in failed decryption in the future, and lost data. Blanks are valid encrypted data values that might be truncated when stored in a column that is too short.
- **Administration of encrypted data:** Encrypted data can only be decrypted on servers that support the decryption functions corresponding to the ENCRYPT function. Therefore, replication of columns with encrypted data should only be done to servers that support the DECRYPT\_BIN or the DECRYPT\_CHAR function.

Examples:

- Use the SET ENCRYPTION PASSWORD statement to set an encryption password for the session.

```
CREATE TABLE EMP (SSN VARCHAR(24) FOR BIT DATA);
SET ENCRYPTION PASSWORD = 'Ben123';
INSERT INTO EMP(SSN) VALUES ENCRYPT('289-46-8832');
```

- Pass the encryption password explicitly.

```
INSERT INTO EMP(SSN) VALUES ENCRYPT('289-46-8832', 'Ben123');
```

- Define a password hint.

```
INSERT INTO EMP(SSN) VALUES ENCRYPT('289-46-8832', 'Pacific', 'Ocean');
```

### Related reference:

- "DECRYPT\_BIN and DECRYPT\_CHAR " on page 319
- "GETHINT " on page 333
- "SET ENCRYPTION PASSWORD statement" in *SQL Reference, Volume 2*

---

## EVENT\_MON\_STATE

►►—EVENT\_MON\_STATE—(—*string-expression*—)—————►◄

The schema is SYSIBM.

The EVENT\_MON\_STATE function returns the current state of an event monitor.

The argument is a string expression with a resulting type of CHAR or VARCHAR and a value that is the name of an event monitor. If the named event monitor does not exist in the SYSCAT.EVENTMONITORS catalog table, SQLSTATE 42704 will be returned. In a Unicode database, if a supplied argument is a graphic string, it is first converted to a character string before the function is executed.

The result is an integer with one of the following values:

- 0        The event monitor is inactive.
- 1        The event monitor is active.

If the argument can be null, the result can be null; if the argument is null, the result is the null value.

Example:

The following example selects all of the defined event monitors, and indicates whether each is active or inactive:

```
SELECT EVMONNAME,
       CASE
         WHEN EVENT_MON_STATE(EVMONNAME) = 0 THEN 'Inactive'
         WHEN EVENT_MON_STATE(EVMONNAME) = 1 THEN 'Active'
       END
FROM SYSCAT.EVENTMONITORS
```

---

**EXP**

►►—EXP—(—*expression*—)—————►◄

The schema is SYSFUN.

Returns the exponential function of the argument.

The argument can be of any built-in numeric data type. It is converted to a double-precision floating-point number for processing by the function.

The result of the function is a double-precision floating-point number. The result can be null; if the argument is null, the result is the null value.



---

## FLOAT

►►—FLOAT—(*—numeric-expression—*)—◄◄

The schema is SYSIBM.

The FLOAT function returns a floating-point representation of a number. FLOAT is a synonym for DOUBLE.

**Related reference:**

- “DOUBLE ” on page 325

---

## FLOOR

►►—FLOOR—(*expression*)—◄◄

The schema is SYSIBM. (The SYSFUN version of the FLOOR function continues to be available.)

Returns the largest integer value less than or equal to the argument.

The result of the function has the same data type and length attribute as the argument except that the scale is 0 if the argument is DECIMAL. For example, an argument with a data type of DECIMAL(5,5) returns DECIMAL(5,0).

The result can be null if the argument can be null or the database is configured with DFT\_SQLMATHWARN set to YES; the result is the null value if the argument is null.

---

## GETHINT

►►—GETHINT—(—*encrypted-data*—)—————►►

The schema is SYSIBM.

The GETHINT function will return the password hint if one is found in the *encrypted-data*. A password hint is a phrase that will help data owners remember passwords; for example, 'Ocean' as a hint to remember 'Pacific'. In a Unicode database, if a supplied argument is a graphic string, it is first converted to a character string before the function is executed.

*encrypted-data*

An expression that returns a CHAR FOR BIT DATA or VARCHAR FOR BIT DATA value that is a complete, encrypted data string. The data string must have been encrypted using the ENCRYPT function (SQLSTATE 428FE).

The result of the function is VARCHAR(32). The result can be null; if the hint parameter was not added to the *encrypted-data* by the ENCRYPT function or the first argument is null, the result is the null value.

Example:

In this example the hint 'Ocean' is stored to help the user remember the encryption password 'Pacific'.

```
INSERT INTO EMP (SSN) VALUES ENCRYPT('289-46-8832', 'Pacific','Ocean');
SELECT GETHINT(SSN)
FROM EMP;
```

The value returned is 'Ocean'.

### Related reference:

- "DECRYPT\_BIN and DECRYPT\_CHAR " on page 319
- "ENCRYPT " on page 327

---

## GENERATE\_UNIQUE

►►—GENERATE\_UNIQUE—(—)—————►►

The schema is SYSIBM.

The GENERATE\_UNIQUE function returns a bit data character string 13 bytes long (CHAR(13) FOR BIT DATA) that is unique compared to any other execution of the same function. (The system clock is used to generate the internal Universal Time, Coordinated (UTC) timestamp along with the database partition number on which the function executes. Adjustments that move the actual system clock backward could result in duplicate values.) The function is defined as not-deterministic.

There are no arguments to this function (the empty parentheses must be specified).

The result of the function is a unique value that includes the internal form of the Universal Time, Coordinated (UTC) and the database partition number where the function was processed. The result cannot be null.

The result of this function can be used to provide unique values in a table. Each successive value will be greater than the previous value, providing a sequence that can be used within a table. The value includes the database partition number where the function executed so that a table partitioned across multiple database partitions also has unique values in some sequence. The sequence is based on the time the function was executed.

This function differs from using the special register CURRENT\_TIMESTAMP in that a unique value is generated for each row of a multiple row insert statement or an insert statement with a fullselect.

The timestamp value that is part of the result of this function can be determined using the TIMESTAMP scalar function with the result of GENERATE\_UNIQUE as an argument.

Examples:

- Create a table that includes a column that is unique for each row. Populate this column using the GENERATE\_UNIQUE function. Notice that the UNIQUE\_ID column has "FOR BIT DATA" specified to identify the column as a bit data character string.

```
CREATE TABLE EMP_UPDATE
  (UNIQUE_ID CHAR(13) FOR BIT DATA,
  EMPNO CHAR(6),
  TEXT VARCHAR(1000))
INSERT INTO EMP_UPDATE
  VALUES (GENERATE_UNIQUE(), '000020', 'Update entry...'),
  (GENERATE_UNIQUE(), '000050', 'Update entry...')
```

This table will have a unique identifier for each row provided that the UNIQUE\_ID column is always set using GENERATE\_UNIQUE. This can be done by introducing a trigger on the table.

```
CREATE TRIGGER EMP_UPDATE_UNIQUE
NO CASCADE BEFORE INSERT ON EMP_UPDATE
REFERENCING NEW AS NEW_UPD
FOR EACH ROW
SNEW_UPD.UNIQUE_ID = GENERATE_UNIQUE()
```

With this trigger defined, the previous INSERT statement could be issued without the first column as follows.

```
INSERT INTO EMP_UPDATE (EMPNO, TEXT)
VALUES ('000020', 'Update entry 1...'),
('000050', 'Update entry 2...')
```

The timestamp (in UTC) for when a row was added to EMP\_UPDATE can be returned using:

```
SELECT TIMESTAMP (UNIQUE_ID), EMPNO, TEXT
FROM EMP_UPDATE
```

Therefore, there is no need to have a timestamp column in the table to record when a row is inserted.

## GRAPHIC

### Graphic to Graphic:

►► GRAPHIC(*—graphic-expression*, *—integer*)

### Character to Graphic:

►► GRAPHIC(*—character-expression*)

### Datetime to Graphic:

►► GRAPHIC(*—datetime-expression*, *ISO*, *USA*, *EUR*, *JIS*, *LOCAL*)

The schema is SYSIBM. The function name cannot be specified as a qualified name when keywords are used in the function signature.

The GRAPHIC function returns a fixed-length graphic string representation of:

- A graphic string, if the first argument is any type of graphic string
- A datetime value (Unicode database only), if the first argument is a date, time, or timestamp

In a Unicode database, if a supplied argument is a character string, it is first converted to a graphic string before the function is executed. When the output string is truncated, such that the last character is a high surrogate, that surrogate is converted to the blank character (X'0020'). Do not rely on this behavior, because it might change in a future release.

The result of the function is a fixed-length graphic string (GRAPHIC data type). If the first argument can be null, the result can be null; if the first argument is null, the result is the null value.

### Graphic to Graphic

*graphic-expression*

An expression that returns a value that is a graphic string.

*integer*

An integer value specifying the length attribute of the resulting GRAPHIC data type. The value must be between 1 and 127. If a value is not specified, the length attribute of the result is the same as the length attribute of the first argument.

### Character to Graphic

*character-expression*

An expression whose value must be of a character string data type other than LONG VARCHAR or CLOB, and whose maximum length is 16 336 bytes.

The length attribute of the result is equal to the length attribute of the argument.

### Datetime to Graphic

#### *datetime-expression*

An expression that is of one of the following three data types:

**date** The result is the graphic string representation of the date in the format specified by the second argument. The length of the result is 10. An error is returned if the second argument is specified and is not a valid value (SQLSTATE 42703).

**time** The result is the graphic string representation of the time in the format specified by the second argument. The length of the result is 8. An error is returned if the second argument is specified and is not a valid value (SQLSTATE 42703).

#### **timestamp**

The result is the graphic string representation of the timestamp. The length of the result is 26. The second argument is not applicable and must not be specified (SQLSTATE 42815).

The code page of the string is the code page of the database at the application server.

#### **Related reference:**

- “VARGRAPHIC ” on page 445

---

## HASHEDVALUE

►►—HASHEDVALUE—(*column-name*)—◄◄

The schema is SYSIBM.

The HASHEDVALUE function returns the distribution map index of the row obtained by applying the partitioning function on the distribution key value of the row. For example, if used in a SELECT clause, it returns the distribution map index for each row of the table that was used to form the result of the SELECT statement.

The distribution map index returned on transition variables and tables is derived from the current transition values of the distribution key columns. For example, in a before insert trigger, the function will return the projected distribution map index given the current values of the new transition variables. However, the values of the distribution key columns may be modified by a subsequent before insert trigger. Thus, the final distribution map index of the row when it is inserted into the database may differ from the projected value.

The argument must be the qualified or unqualified name of a column in a table. The column can have any data type. (This function cannot be used as a source function when creating a user-defined function. Because it accepts any data type as an argument, it is not necessary to create additional signatures to support user-defined distinct types.) If *column-name* references a column of a view the expression in the view for the column must reference a column of the underlying base table and the view must be deletable. A nested or common table expression follows the same rules as a view.

The specific row (and table) for which the distribution map index is returned by the HASHEDVALUE function is determined from the context of the SQL statement that uses the function.

The data type of the result is INTEGER in the range 0 to 4095. For a table with no distribution key, the result is always 0. A null value is never returned. Since row-level information is returned, the results are the same, regardless of which column is specified for the table.

The HASHEDVALUE function cannot be used on replicated tables, within check constraints, or in the definition of generated columns (SQLSTATE 42881).

For compatibility with versions earlier than Version 8, the function name PARTITION can be substituted for HASHEDVALUE.

Example:

- List the employee numbers (EMPNO) from the EMPLOYEE table for all rows with a distribution map index of 100.

```
SELECT EMPNO FROM EMPLOYEE
WHERE HASHEDVALUE(PHONENO) = 100
```

- Log the employee number and the projected distribution map index of the new row into a table called EMPINSERTLOG2 for any insertion of employees by creating a before trigger on the table EMPLOYEE.



```
CREATE TRIGGER EMPINSLOGTRIG2
  BEFORE INSERT ON EMPLOYEE
  REFERENCING NEW AS NEWTABLE
  FOR EACH ROW
  INSERT INTO EMPINSERTLOG2
    VALUES(NEWTABLE.EMPNO, HASHEDVALUE(NEWTABLE.EMPNO))
```

**Related reference:**

- “CREATE VIEW statement” in *SQL Reference, Volume 2*

---

**HEX**

►►—HEX—(—*expression*—)—————►►

The schema is SYSIBM.

The HEX function returns a hexadecimal representation of a value as a character string.

The argument can be an expression that is a value of any built-in data type with a maximum length of 16 336 bytes.

The result of the function is a character string. If the argument can be null, the result can be null; if the argument is null, the result is the null value.

The code page is the database code page.

The result is a string of hexadecimal digits. The first two represent the first byte of the argument, the next two represent the second byte of the argument, and so forth. If the argument is a datetime value or a numeric value the result is the hexadecimal representation of the internal form of the argument. The hexadecimal representation that is returned may be different depending on the application server where the function is executed. Cases where differences would be evident include:

- Character string arguments when the HEX function is performed on an ASCII client with an EBCDIC server or on an EBCDIC client with an ASCII server.
- Numeric arguments (in some cases) when the HEX function is performed where client and server systems have different byte orderings for numeric values.

The type and length of the result vary based on the type and length of character string arguments.

- Character string
  - Fixed length not greater than 127
    - Result is a character string of fixed length twice the defined length of the argument.
  - Fixed length greater than 127
    - Result is a character string of varying length twice the defined length of the argument.
  - Varying length
    - Result is a character string of varying length with maximum length twice the defined maximum length of the argument.
- Graphic string
  - Fixed length not greater than 63
    - Result is a character string of fixed length four times the defined length of the argument.
  - Fixed length greater than 63
    - Result is a character string of varying length four times the defined length of the argument.
- Varying length

- Result is a character string of varying length with maximum length four times the defined maximum length of the argument.

Examples:

Assume the use of a DB2 for AIX<sup>®</sup> application server for the following examples.

- Using the DEPARTMENT table set the host variable HEX\_MGRNO (char(12)) to the hexadecimal representation of the manager number (MGRNO) for the 'PLANNING' department (DEPTNAME).

```
SELECT HEX(MGRNO)
  INTO :HEX_MGRNO
  FROM DEPARTMENT
  WHERE DEPTNAME = 'PLANNING'
```

HEX\_MGRNO will be set to '303030303230' when using the sample table (character value is '000020').

- Suppose COL\_1 is a column with a data type of char(1) and a value of 'B'. The hexadecimal representation of the letter 'B' is X'42'. HEX(COL\_1) returns a two byte long string '42'.
- Suppose COL\_3 is a column with a data type of decimal(6,2) and a value of 40.1. An eight byte long string '0004010C' is the result of applying the HEX function to the internal representation of the decimal value, 40.1.

---

## HOUR

►►—*HOUR*—(*—expression—*)——————▶▶

The schema is SYSIBM.

The HOUR function returns the hour part of a value.

The argument must be a time, timestamp, time duration, timestamp duration, or a valid character string representation of a time or timestamp that is neither a CLOB nor a LONG VARCHAR. In a Unicode database, if a supplied argument is a graphic string, it is first converted to a character string before the function is executed.

The result of the function is a large integer. If the argument can be null, the result can be null; if the argument is null, the result is the null value.

The other rules depend on the data type of the argument:

- If the argument is a time, timestamp or valid string representation of a time or timestamp:
  - The result is the hour part of the value, which is an integer between 0 and 24.
- If the argument is a time duration or timestamp duration:
  - The result is the hour part of the value, which is an integer between –99 and 99. A nonzero result has the same sign as the argument.

Example:

Using the CL\_SCHED sample table, select all the classes that start in the afternoon.

```
SELECT * FROM CL_SCHED
WHERE HOUR(STARTING) BETWEEN 12 AND 17
```

---

## IDENTITY\_VAL\_LOCAL

►►—IDENTITY\_VAL\_LOCAL—(—)—————►►

The schema is SYSIBM.

The IDENTITY\_VAL\_LOCAL function is a non-deterministic function that returns the most recently assigned value for an identity column, where the assignment occurred as a result of a single row INSERT statement using a VALUES clause. The function has no input parameters.

The result is a DECIMAL(31,0), regardless of the actual data type of the corresponding identity column.

The value returned by the function is the value assigned to the identity column of the table identified in the most recent single row INSERT statement. The INSERT statement must contain a VALUES clause on a table containing an identity column. The INSERT statement must also be issued at the same level; that is, the value must be available locally at the level it was assigned, until it is replaced by the next assigned value. (A new level is initiated each time a trigger or routine is invoked.)

The assigned value is either a value supplied by the user (if the identity column is defined as GENERATED BY DEFAULT), or an identity value generated by the database manager.

The function returns a null value if a single row INSERT statement with a VALUES clause has not been issued at the current processing level against a table containing an identity column.

The result of the function is not affected by the following:

- A single row INSERT statement with a VALUES clause for a table without an identity column
- A multiple row INSERT statement with a VALUES clause
- An INSERT statement with a fullselect
- A ROLLBACK TO SAVEPOINT statement

Notes:

- Expressions in the VALUES clause of an INSERT statement are evaluated prior to the assignments for the target columns of the INSERT statement. Thus, an invocation of an IDENTITY\_VAL\_LOCAL function inside the VALUES clause of an INSERT statement will use the most recently assigned value for an identity column from a previous INSERT statement. The function returns the null value if no previous single row INSERT statement with a VALUES clause for a table containing an identity column has been executed within the same level as the IDENTITY\_VAL\_LOCAL function.
- The identity column value of the table for which the trigger is defined can be determined within a trigger by referencing the trigger transition variable for the identity column.
- The result of invoking the IDENTITY\_VAL\_LOCAL function from within the trigger condition of an insert trigger is a null value.

## IDENTITY\_VAL\_LOCAL

- It is possible that multiple before or after insert triggers exist for a table. In this case, each trigger is processed separately, and identity values assigned by one triggered action are not available to other triggered actions using the `IDENTITY_VAL_LOCAL` function. This is true even though the multiple triggered actions are conceptually defined at the same level.
- It is not generally recommended to use the `IDENTITY_VAL_LOCAL` function in the body of a before insert trigger. The result of invoking the `IDENTITY_VAL_LOCAL` function from within the triggered action of a before insert trigger is the null value. The value for the identity column of the table for which the trigger is defined cannot be obtained by invoking the `IDENTITY_VAL_LOCAL` function within the triggered action of a before insert trigger. However, the value for the identity column can be obtained in the triggered action by referencing the trigger transition variable for the identity column.
- The result of invoking the `IDENTITY_VAL_LOCAL` function from within the triggered action of an after insert trigger is the value assigned to an identity column of the table identified in the most recent single row `INSERT` statement invoked in the same triggered action that had a `VALUES` clause for a table containing an identity column. (This applies to both `FOR EACH ROW` and `FOR EACH STATEMENT` after insert triggers.) If a single row `INSERT` statement with a `VALUES` clause for a table containing an identity column was not executed within the same triggered action, prior to the invocation of the `IDENTITY_VAL_LOCAL` function, the function returns a null value.
- Because `IDENTITY_VAL_LOCAL` is a non-deterministic function, the result of invoking this function within the `SELECT` statement of a cursor can vary for each `FETCH` statement.
- The assigned value is the value actually assigned to the identity column (that is, the value that would be returned on a subsequent `SELECT` statement). This value is not necessarily the value provided in the `VALUES` clause of the `INSERT` statement, or a value generated by the database manager. The assigned value could be a value specified in a `SET` transition variable statement, within the body of a before insert trigger, for a trigger transition variable associated with the identity column.
- The value returned by the function following a failed single row `INSERT` statement with a `VALUES` clause into a table with an identity column is unpredictable. It could be the value that would have been returned from the function had it been invoked prior to the failed insert operation, or it could be the value that would have been assigned had the insert operation succeeded. The actual value returned depends on the point of failure, and is therefore unpredictable.

Examples:

Example 1: Create two tables, T1 and T2, each with an identity column named C1. Start the identity sequence for table T2 at 10. Insert some values for C2 into T1.

```
CREATE TABLE T1
(C1 INTEGER GENERATED ALWAYS AS IDENTITY,
 C2 INTEGER)

CREATE TABLE T2
(C1 DECIMAL(15,0) GENERATED BY DEFAULT AS IDENTITY (START WITH 10),
 C2 INTEGER)

INSERT INTO T1 (C2) VALUES (5)
```

```
INSERT INTO T1 (C2) VALUES (6)
```

```
SELECT * FROM T1
```

This query returns:

```

C1          C2
-----
          1          5
          2          6

```

Insert a single row into table T2, where column C2 gets its value from the IDENTITY\_VAL\_LOCAL function.

```
INSERT INTO T2 (C2) VALUES (IDENTITY_VAL_LOCAL())
```

```
SELECT * FROM T2
```

This query returns:

```

C1          C2
-----
          10.          2

```

Example 2: In a nested environment involving a trigger, use the IDENTITY\_VAL\_LOCAL function to retrieve the identity value assigned at a particular level, even though there might have been identity values assigned at lower levels. Assume that there are three tables, EMPLOYEE, EMP\_ACT, and ACCT\_LOG. There is an after insert trigger defined on EMPLOYEE that results in additional inserts into the EMP\_ACT and ACCT\_LOG tables.

```

CREATE TABLE EMPLOYEE
  (EMPNO SMALLINT GENERATED ALWAYS AS IDENTITY (START WITH 1000),
   NAME CHAR(30),
   SALARY DECIMAL(5,2),
   DEPTNO SMALLINT)

CREATE TABLE EMP_ACT
  (ACNT_NUM SMALLINT GENERATED ALWAYS AS IDENTITY (START WITH 1),
   EMPNO SMALLINT)

CREATE TABLE ACCT_LOG
  (ID SMALLINT GENERATED ALWAYS AS IDENTITY (START WITH 100),
   ACNT_NUM SMALLINT,
   EMPNO SMALLINT)

CREATE TRIGGER NEW_HIRE
  AFTER INSERT ON EMPLOYEE
  REFERENCING NEW AS NEW_EMP
  FOR EACH ROW
  BEGIN ATOMIC
    INSERT INTO EMP_ACT (EMPNO) VALUES (NEW_EMP.EMPNO);
    INSERT INTO ACCT_LOG (ACNT_NUM, EMPNO)
      VALUES (IDENTITY_VAL_LOCAL(), NEW_EMP.EMPNO);
  END

```

The first triggered INSERT statement inserts a row into the EMP\_ACT table. This statement uses a trigger transition variable for the EMPNO column of the EMPLOYEE table to indicate that the identity value for the EMPNO column of the EMPLOYEE table is to be copied to the EMPNO column of the EMP\_ACT table. The IDENTITY\_VAL\_LOCAL function could not be used to obtain the value assigned to the EMPNO column of the EMPLOYEE table, because an INSERT statement has not been issued at this level of the nesting. If the IDENTITY\_VAL\_LOCAL function were invoked in the VALUES clause of the

## IDENTITY\_VAL\_LOCAL

INSERT statement for the EMP\_ACT table, it would return a null value. The INSERT statement for the EMP\_ACT table also results in the generation of a new identity value for the ACNT\_NUM column.

The second triggered INSERT statement inserts a row into the ACCT\_LOG table. This statement invokes the IDENTITY\_VAL\_LOCAL function to indicate that the identity value assigned to the ACNT\_NUM column of the EMP\_ACT table in the previous INSERT statement in the triggered action is to be copied to the ACNT\_NUM column of the ACCT\_LOG table. The EMPNO column is assigned the same value as the EMPNO column of the EMPLOYEE table.

After the following INSERT statement and all of the triggered actions have been processed:

```
INSERT INTO EMPLOYEE (NAME, SALARY, DEPTNO)
VALUES ('Rupert', 989.99, 50)
```

the contents of the three tables are as follows:

```
SELECT EMPNO, SUBSTR(NAME,1,10) AS NAME, SALARY, DEPTNO
FROM EMPLOYEE
```

| EMPNO | NAME   | SALARY | DEPTNO |
|-------|--------|--------|--------|
| 1000  | Rupert | 989.99 | 50     |

```
SELECT ACNT_NUM, EMPNO
FROM EMP_ACT
```

| ACNT_NUM | EMPNO |
|----------|-------|
| 1        | 1000  |

```
SELECT * FROM ACCT_LOG
```

| ID  | ACNT_NUM | EMPNO |
|-----|----------|-------|
| 100 | 1        | 1000  |

The result of the IDENTITY\_VAL\_LOCAL function is the most recently assigned value for an identity column at the same nesting level. After processing the original INSERT statement and all of the triggered actions, the IDENTITY\_VAL\_LOCAL function returns a value of 1000, because this is the value that was assigned to the EMPNO column of the EMPLOYEE table.

### Related samples:

- "fnuse.out -- HOW TO USE BUILT-IN SQL FUNCTIONS (C)"
- "fnuse.sqc -- How to use built-in SQL functions (C)"
- "fnuse.out -- HOW TO USE FUNCTIONS (C++)"
- "fnuse.sqC -- How to use built-in SQL functions (C++)"



---

**INSERT**

►►—INSERT—(—*expression1*—,—*expression2*—,—*expression3*—,—*expression4*—)—►►

The schema is SYSFUN.

Returns a string where *expression3* bytes have been deleted from *expression1*, beginning at *expression2*, and where *expression4* has been inserted into *expression1*, beginning at *expression2*. If the length of the result string exceeds the maximum for the return type, an error is returned (SQLSTATE 38552).

The first argument is a character string or a binary string type. In a Unicode database, if a supplied argument is a graphic string, it is first converted to a character string before the function is executed. The second and third arguments must be a numeric value with a data type of SMALLINT or INTEGER. If the first argument is a character string, then the fourth argument must also be a character string. If the first argument is a binary string, then the fourth argument must be a binary string. For a VARCHAR the maximum length is 4 000 bytes and for a CLOB or a binary string the maximum length is 1 048 576 bytes. For the first and fourth arguments, CHAR is converted to VARCHAR and LONG VARCHAR to CLOB(1M), for second and third arguments SMALLINT is converted to INTEGER for processing by the function.

The result is based on the argument types as follows:

- VARCHAR(4000) if both the first and fourth arguments are VARCHAR (not exceeding 4 000 bytes) or CHAR
- CLOB(1M) if either the first or fourth argument is CLOB or LONG VARCHAR
- BLOB(1M) if both first and fourth arguments are BLOB.

The result can be null; if any argument is null, the result is the null value.

Example:

- Delete one character from the word 'DINING' and insert 'VID', both beginning at the third character.

```
VALUES CHAR(INSERT('DINING', 3, 1, 'VID'), 10)
```

This example returns the following:

```
1
-----
DIVIDING
```

As mentioned, the output of the INSERT function is VARCHAR(4000). In this example, the function CHAR has been used to limit the output of INSERT to 10 bytes. The starting location of a particular string can be found using the LOCATE function.

**Related reference:**

- "LOCATE " on page 357

## INTEGER

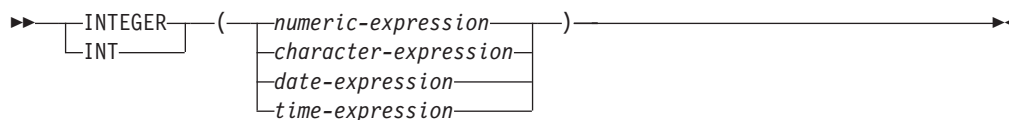

The schema is SYSIBM.

The INTEGER function returns an integer representation of a number, character string, date, or time in the form of an integer constant. In a Unicode database, if a supplied argument is a graphic string, it is first converted to a character string before the function is executed.

### *numeric-expression*

An expression that returns a value of any built-in numeric data type.

If the argument is a *numeric-expression*, the result is the same number that would occur if the argument were assigned to a large integer column or variable. If the whole part of the argument is not within the range of integers, an error occurs. The decimal part of the argument is truncated if present.

### *character-expression*

An expression that returns a character string value of length not greater than the maximum length of a character constant. Leading and trailing blanks are eliminated and the resulting string must conform to the rules for forming an SQL integer constant (SQLSTATE 22018). The character string cannot be a long string.

If the argument is a *character-expression*, the result is the same number that would occur if the corresponding integer constant were assigned to a large integer column or variable.

### *date-expression*

An expression that returns a value of the DATE data type. The result is an INTEGER value representing the date as *yyyymmdd*.

### *time-expression*

An expression that returns a value of the TIME data type. The result is an INTEGER value representing the time as *hhmmss*.

The result of the function is a large integer. If the argument can be null, the result can be null; if the argument is null, the result is the null value.

### Examples:

- Using the EMPLOYEE table, select a list containing salary (SALARY) divided by education level (EDLEVEL). Truncate any decimal in the calculation. The list should also contain the values used in the calculation and employee number (EMPNO). The list should be in descending order of the calculated value.

```
SELECT INTEGER (SALARY / EDLEVEL), SALARY, EDLEVEL, EMPNO
FROM EMPLOYEE
ORDER BY 1 DESC
```

- Using the EMPLOYEE table, select the EMPNO column in integer form for further processing in the application.
 

```
SELECT INTEGER(EMPNO) FROM EMPLOYEE
```
- Assume that the column BIRTHDATE (date) has an internal value equivalent to '1964-07-20'.

**INTEGER**(BIRTHDATE)

results in the value 19 640 720.

- Assume that the column STARTTIME (time) has an internal value equivalent to '12:03:04'.

**INTEGER**(STARTTIME)

results in the value 120 304.

---

## JULIAN\_DAY

►►—JULIAN\_DAY—(*—expression—*)——————►◄

The schema is SYSFUN.

Returns an integer value representing the number of days from January 1, 4713 B.C. (the start of the Julian date calendar) to the date value specified in the argument.

The argument must be a date, timestamp, or a valid character string representation of a date or timestamp that is neither a CLOB nor a LONG VARCHAR. In a Unicode database, if a supplied argument is a graphic string, it is first converted to a character string before the function is executed.

The result of the function is INTEGER. The result can be null; if the argument is null, the result is the null value.

---

## LCASE or LOWER



The schema is SYSIBM. (The SYSFUN version of this function continues to be available with support for LONG VARCHAR and CLOB arguments.)

The LCASE or LOWER function returns a string in which all the SBCS characters have been converted to lowercase characters. That is, the characters A-Z will be converted to the characters a-z, and other characters will be converted to their lowercase equivalents, if they exist. For example, in code page 850, É maps to é. If the code point length of the result character is not the same as the code point length of the source character, the source character is not converted. Because not all characters are converted, LCASE(UCASE(*string-expression*)) does not necessarily return the same result as LCASE(*string-expression*).

The argument must be an expression whose value is a CHAR or VARCHAR data type.

The result of the function has the same data type and length attribute as the argument. If the argument can be null, the result can be null; if the argument is null, the result is the null value.

In a Unicode database, if a supplied argument is a graphic string, it is first converted to a character string before the function is executed.

Example:

Ensure that the characters in the value of column JOB in the EMPLOYEE table are returned in lowercase characters.

```
SELECT LCASE(JOB)
FROM EMPLOYEE
WHERE EMPNO = '000020';
```

The result is the value 'manager'.

### Related reference:

- “LCASE (SYSFUN schema) ” on page 352

---

### LCASE (SYSFUN schema)

►►—LCASE—(—*expression*—)—————►►

The schema is SYSFUN.

Returns a string in which all the characters A-Z have been converted to the characters a-z (characters with diacritical marks are not converted). Note that LCASE(UCASE(string)) will therefore not necessarily return the same result as LCASE(string).

The argument can be of any built-in character string type. For a VARCHAR, the maximum length is 4 000 bytes, and for a CLOB, the maximum length is 1 048 576 bytes.

The result of the function is:

- VARCHAR(4000) if the argument is VARCHAR (not exceeding 4 000 bytes) or CHAR
- CLOB(1M) if the argument is CLOB or LONG VARCHAR

The result can be null; if the argument is null, the result is the null value.

In a Unicode database, if a supplied argument is a graphic string, it is first converted to a character string before the function is executed.

---

**LEFT**

▶▶—LEFT—(—*expression1*—,—*expression2*—)—▶▶

The schema is SYSFUN.

Returns a string consisting of the leftmost *expression2* bytes in *expression1*. The *expression1* value is effectively padded on the right with the necessary number of blank characters so that the specified substring of *expression1* always exists.

The first argument is a character string or a binary string type. In a Unicode database, if a supplied argument is a graphic string, it is first converted to a character string before the function is executed. For a VARCHAR, the maximum length is 4 000 bytes and for a CLOB or a binary string, the maximum length is 1 048 576 bytes. The second argument must be of data type INTEGER or SMALLINT.

The result of the function is:

- VARCHAR(4000) if the argument is VARCHAR (not exceeding 4 000 bytes) or CHAR
- CLOB(1M) if the argument is CLOB or LONG VARCHAR
- BLOB(1M) if the argument is BLOB.

The result can be null; if any argument is null, the result is the null value.

## LENGTH

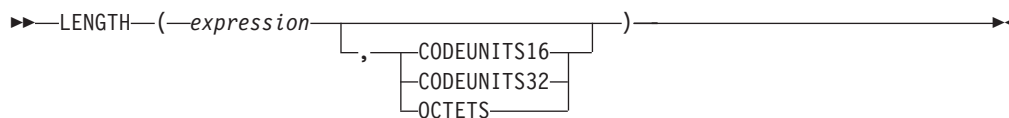

The schema is SYSIBM.

The LENGTH function returns the length of *expression* in the implicit or explicit string unit.

*expression*

An expression that returns a value that is a built-in data type. If *expression* can be null, the result can be null; if *expression* is null, the result is the null value.

#### CODEUNITS16, CODEUNITS32, or OCTETS

Specifies the string unit of the result. CODEUNITS16 specifies that the result is to be expressed in 16-bit UTF-16 code units. CODEUNITS32 specifies that the result is to be expressed in 32-bit UTF-32 code units. OCTETS specifies that the result is to be expressed in bytes.

If a string unit is explicitly specified, and if *expression* is not string data, an error is returned (SQLSTATE 428GC). If a string unit is specified as CODEUNITS16 or CODEUNITS32, and *expression* is a binary string or bit data, an error is returned (SQLSTATE 428GC). If a string unit is specified as OCTETS and *expression* is a binary string, an error is returned (SQLSTATE 42815). For more information about CODEUNITS16, CODEUNITS32, and OCTETS, see “String units in built-in functions” in “Character strings”.

If a string unit is not explicitly specified, the data type of the result determines the unit that is used. If the result is graphic data, the value returned specifies the length in 2-byte units. Otherwise, the value returned specifies the length in bytes.

The result of the function is a large integer. If the argument can be null, the result can be null; if the argument is null, the result is the null value.

The length of character and graphic strings includes trailing blanks. The length of binary strings includes binary zeroes. The length of varying-length strings is the actual length and not the maximum length. The length of all other values is the number of bytes used to represent the value:

- 2 for small integer
- 4 for large integer
- $(p/2)+1$  for decimal numbers with precision  $p$
- The length of the string for binary strings
- The length of the string for character strings
- 4 for single-precision floating-point
- 8 for double-precision floating-point
- 4 for date
- 3 for time
- 10 for timestamp

Examples:



- Assume that the host variable ADDRESS is a varying-length character string with a value of '895 Don Mills Road'.

```
LENGTH(:ADDRESS)
```

returns the value 18.

- Assume that START\_DATE is a column of type DATE.

```
LENGTH(START_DATE)
```

returns the value 4.

- **LENGTH(CHAR(START\_DATE, EUR))**

returns the value 10.

- The following examples work with the Unicode string '&N~AB', where '&' is the musical symbol G clef character, and '~' is the combining tilde character. This string is shown below in different Unicode encoding forms:

|          | '&'         | 'N'         | '~'         | 'A'         | 'B'         |
|----------|-------------|-------------|-------------|-------------|-------------|
| UTF-8    | X'F09D849E' | X'4E'       | X'CC83'     | X'41'       | X'42'       |
| UTF-16BE | X'D834DD1E' | X'004E'     | X'0303'     | X'0041'     | X'0042'     |
| UTF-32BE | X'0001D11E' | X'0000004E' | X'00000303' | X'00000041' | X'00000042' |

Assume that the variable UTF8\_VAR contains the UTF-8 representation of the string.

```
SELECT LENGTH(UTF8_VAR, CODEUNITS16),
       LENGTH(UTF8_VAR, CODEUNITS32),
       LENGTH(UTF8_VAR, OCTETS)
FROM SYSIBM.SYSDUMMY1
```

returns the values 6, 5, and 9, respectively.

Assume that the variable UTF16\_VAR contains the UTF-16BE representation of the string.

```
SELECT LENGTH(UTF16_VAR, CODEUNITS16),
       LENGTH(UTF16_VAR, CODEUNITS32),
       LENGTH(UTF16_VAR, OCTETS)
FROM SYSIBM.SYSDUMMY1
```

returns the values 6, 5, and 12, respectively.

#### Related reference:

- "Character strings" on page 81
- "CHARACTER\_LENGTH" on page 295
- "OCTET\_LENGTH" on page 375

►►—LN—(*expression*)—◄◄

The schema is SYSFUN.

Returns the natural logarithm of the argument (same as LOG).

The argument can be of any built-in numeric data type. It is converted to a double-precision floating-point number for processing by the function.

The result of the function is a double-precision floating-point number. The result can be null; if the argument is null, the result is the null value.

## LOCATE

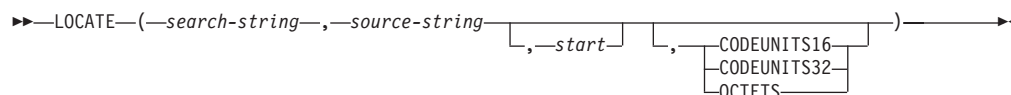

The schema is SYSIBM. The SYSFUN version of the LOCATE function continues to be available.

The LOCATE function returns the starting position of the first occurrence of one string (called the *search-string*) within another string (called the *source-string*). If the *search-string* is not found and neither argument is null, the result is zero. If the *search-string* is found, the result is a number from 1 to the actual length of the *source-string*. If the optional *start* is specified, it indicates the character position in the *source-string* at which the search is to begin. An optional string unit can be specified to indicate in what units the *start* and result of the function are expressed.

If the *search-string* has a length of zero, the result returned by the function is 1. Otherwise, if the *source-string* has a length of zero, the result returned by the function is 0. Otherwise:

- If the value of *search-string* is equal to an identical length of substring of contiguous positions within the value of *source-string*, the result returned by the function is the starting position of the first such substring within the *source-string* value.
- Otherwise, the result returned by the function is 0.

### *search-string*

An expression that specifies the string that is the object of the search. The expression must return a value that is a built-in character string data type, graphic string data type, or binary string data type with an actual length that is no greater than 4000 bytes. No element of the expression can be of type LONG VARCHAR, CLOB, LONG VARGRAPHIC, or DBCLOB. In addition, it cannot be a BLOB file reference variable. The expression can be specified by any of the following:

- A constant
- A special register
- A host variable
- A scalar function whose operands are any of the above
- An expression that concatenates (using CONCAT or ||) any of the above
- An SQL procedure parameter

These rules are similar to those that are described for *pattern-expression* for the LIKE predicate.

### *source-string*

An expression that specifies the string in which the search is to take place. The expression must return a value that is a built-in character string data type, graphic string data type, or binary string data type. The expression can be specified by any of the following:

- A constant
- A special register
- A host variable (including a locator variable or a file reference variable)
- A scalar function

## LOCATE

- A large object locator
- A column name
- An expression that concatenates (using CONCAT or ||) any of the above

### *start*

An expression that specifies the position within *source-string* at which the search is to start. The expression must be an integer that is greater than or equal to zero. If *start* is specified, the LOCATE function is similar to:

```
POSITION(search-string,  
SUBSTRING(source-string, start, string-unit),  
string-unit) + start - 1
```

where *string-unit* is either CODEUNITS16, CODEUNITS32, or OCTETS.

If *start* is not specified, the search begins at the first position of the source string, and the LOCATE function is similar to:

```
POSITION(search-string, source-string, string-unit)
```

### CODEUNITS16, CODEUNITS32, or OCTETS

Specifies the string unit of *start* and the result. CODEUNITS16 specifies that *start* and the result are to be expressed in 16-bit UTF-16 code units. CODEUNITS32 specifies that *start* and the result are to be expressed in 32-bit UTF-32 code units. OCTETS specifies that *start* and the result are to be expressed in bytes.

If a string unit is specified as CODEUNITS16 or CODEUNITS32, and *search-string* or *source-string* is a binary string or bit data, an error is returned (SQLSTATE 428GC). If a string unit is specified as OCTETS, *search-string* is converted to the code page of the *source-string* if it has a different code page. In this case, the operation is done in the code page of the *source-string*. If a string unit is specified as OCTETS and *search-string* and *source-string* are binary strings, an error is returned (SQLSTATE 42815).

If a string unit is not explicitly specified, the data type of the result determines the unit that is used. If the result is graphic data, *start* and the returned position are expressed in two-byte units; otherwise, they are expressed in bytes.

For more information about CODEUNITS16, CODEUNITS32, and OCTETS, see “String units in built-in functions” in “Character strings”.

The first and second arguments must have compatible string types. For more information on compatibility, see “Rules for string conversions”.

The result of the function is a large integer. If any argument can be null, the result can be null; if any argument is null, the result is the null value.

Examples:

- Find the location of the first occurrence of the character 'N' in the string 'DINING'.

```
SELECT LOCATE('N', 'DINING')  
FROM SYSIBM.SYSDUMMY1
```

The result is the value 3.

- For all the rows in the table named IN\_TRAY, select the RECEIVED column, the SUBJECT column, and the starting position of the string 'GOOD' within the NOTE\_TEXT column.

```
SELECT RECEIVED, SUBJECT, LOCATE('GOOD', NOTE_TEXT)
FROM IN_TRAY
WHERE LOCATE('GOOD', NOTE_TEXT) <> 0
```

- Locate the character 'ß' in the string 'Jürgen lives on Hegelstraße', and set the host variable LOCATION with the position, as measured in CODEUNITS32 units, within the string.

```
SET :LOCATION = LOCATE('ß', 'Jürgen lives on Hegelstraße', 1, CODEUNITS32)
```

The value of host variable LOCATION is set to 27.

- Locate the character 'ß' in the string 'Jürgen lives on Hegelstraße', and set the host variable LOCATION with the position, as measured in CODEUNITS16 units, within the string.

```
SET :LOCATION = LOCATE('ß', 'Jürgen lives on Hegelstraße', 1, CODEUNITS16)
```

The value of host variable LOCATION is set to 27.

- Locate the character 'ß' in the string 'Jürgen lives on Hegelstraße', and set the host variable LOCATION with the position, as measured in OCTETS, within the string.

```
SET :LOCATION = LOCATE('ß', 'Jürgen lives on Hegelstraße', 1, OCTETS)
```

The value of host variable LOCATION is set to 28.

- The following examples work with the Unicode string '&N~AB', where '&' is the musical symbol G clef character, and '~' is the combining tilde character. This string is shown below in different Unicode encoding forms:

|          | '&'         | 'N'     | '~'     | 'A'     | 'B'     |
|----------|-------------|---------|---------|---------|---------|
| UTF-8    | X'F09D849E' | X'4E'   | X'CC83' | X'41'   | X'42'   |
| UTF-16BE | X'D834DD1E' | X'004E' | X'0303' | X'0041' | X'0042' |

Assume that the variable UTF8\_VAR contains the UTF-8 representation of the string.

```
SELECT LOCATE('~', UTF8_VAR, CODEUNITS16),
       LOCATE('~', UTF8_VAR, CODEUNITS32),
       LOCATE('~', UTF8_VAR, OCTETS)
FROM SYSIBM.SYSDUMMY1
```

returns the values 4, 3, and 6, respectively.

Assume that the variable UTF16\_VAR contains the UTF-16BE representation of the string.

```
SELECT LOCATE('~', UTF16_VAR, CODEUNITS16),
       LOCATE('~', UTF16_VAR, CODEUNITS32),
       LOCATE('~', UTF16_VAR, OCTETS)
FROM SYSIBM.SYSDUMMY1
```

returns the values 4, 3, and 7, respectively.

#### Related reference:

- “Character strings” on page 81
- “POSITION ” on page 376
- “Rules for string conversions” on page 120

---

**LOG**

►►—LOG—(*expression*)—◄◄

The schema is SYSFUN.

Returns the natural logarithm of the argument (same as LN).

The argument can be of any built-in numeric data type. It is converted to a double-precision floating-point number for processing by the function.

The result of the function is a double-precision floating-point number. The result can be null; if the argument is null, the result is the null value.

---

**LOG10**

►►—LOG10—(*expression*)—◄◄

The schema is SYSFUN.

Returns the base 10 logarithm of the argument.

The argument can be of any built-in numeric type. It is converted to a double-precision floating-point number for processing by the function.

The result of the function is a double-precision floating-point number. The result can be null; if the argument is null, the result is the null value.

---

## LONG\_VARCHAR

►►—LONG\_VARCHAR—(*—character-string-expression—*)——————►◄

The schema is SYSIBM.

The LONG\_VARCHAR function returns a LONG VARCHAR representation of a character string data type. In a Unicode database, if a supplied argument is a graphic string, it is first converted to a character string before the function is executed.

*character-string-expression*

An *expression* that returns a value that is a character string with a maximum length of 32 700 bytes.

The result of the function is a LONG VARCHAR. If the argument can be null, the result can be null; if the argument is null, the result is the null value.



---

## LONG\_VARGRAPHIC

►►—LONG\_VARGRAPHIC—(*—graphic-expression—*)—►►

The schema is SYSIBM.

The LONG\_VARGRAPHIC function returns a LONG VARGRAPHIC representation of a double-byte character string.

*graphic-expression*

An *expression* that returns a value that is a graphic string with a maximum length of 16 350 double byte characters.

The result of the function is a LONG VARGRAPHIC. If the argument can be null, the result can be null; if the argument is null, the result is the null value.

---

**LTRIM**

►►—LTRIM—(—*string-expression*—)—————►►

The schema is SYSIBM. (The SYSFUN version of this function continues to be available with support for LONG VARCHAR and CLOB arguments.)

The LTRIM function removes blanks from the beginning of *string-expression*.

The argument can be a CHAR, VARCHAR, GRAPHIC, or VARGRAPHIC data type.

- If the argument is a graphic string in a DBCS or EUC database, then the leading double byte blanks are removed.
- If the argument is a graphic string in a Unicode database, then the leading UCS-2 blanks are removed.
- Otherwise, the leading single byte blanks are removed.

The result data type of the function is:

- VARCHAR if the data type of *string-expression* is VARCHAR or CHAR
- VARGRAPHIC if the data type of *string-expression* is VARGRAPHIC or GRAPHIC

The length parameter of the returned type is the same as the length parameter of the argument data type.

The actual length of the result for character strings is the length of *string-expression* minus the number of bytes removed for blank characters. The actual length of the result for graphic strings is the length (in number of double byte characters) of *string-expression* minus the number of double byte blank characters removed. If all of the characters are removed, the result is an empty, varying-length string (length is zero).

If the argument can be null, the result can be null; if the argument is null, the result is the null value.

Example:

Assume that host variable HELLO is defined as CHAR(9) and has a value of 'Hello'.

```
VALUES LTRIM(:HELLO)
```

The result is 'Hello'.

**Related reference:**

- "LTRIM (SYSFUN schema) " on page 365

---

**LTRIM (SYSFUN schema)**

▶▶—LTRIM—(*expression*)—▶▶

The schema is SYSFUN.

Returns the characters of the argument with leading blanks removed.

The argument can be of any built-in character string type. For a VARCHAR the maximum length is 4 000 bytes and for a CLOB the maximum length is 1 048 576 bytes.

The result of the function is:

- VARCHAR(4000) if the argument is VARCHAR (not exceeding 4 000 bytes) or CHAR
- CLOB(1M) if the argument is CLOB or LONG VARCHAR.

The result can be null; if the argument is null, the result is the null value.

---

**MICROSECOND**

►►—MICROSECOND—(—*expression*—)—————►►

The schema is SYSIBM.

The MICROSECOND function returns the microsecond part of a value.

The argument must be a timestamp, timestamp duration, or a valid character string representation of a timestamp that is neither a CLOB nor a LONG VARCHAR. In a Unicode database, if a supplied argument is a graphic string, it is first converted to a character string before the function is executed.

The result of the function is a large integer. If the argument can be null, the result can be null; if the argument is null, the result is the null value.

The other rules depend on the data type of the argument:

- If the argument is a timestamp or a valid string representation of a timestamp:
  - The integer ranges from 0 through 999 999.
- If the argument is a duration:
  - The result reflects the microsecond part of the value which is an integer between –999 999 through 999 999. A nonzero result has the same sign as the argument.

Example:

- Assume a table TABLEA contains two columns, TS1 and TS2, of type TIMESTAMP. Select all rows in which the microseconds portion of TS1 is not zero and the seconds portion of TS1 and TS2 are identical.

```
SELECT * FROM TABLEA
WHERE MICROSECOND(TS1) <> 0
AND
SECOND(TS1) = SECOND(TS2)
```

---

## MIDNIGHT\_SECONDS

►►—MIDNIGHT\_SECONDS—(—*expression*—)—————►►

The schema is SYSFUN.

Returns an integer value in the range 0 to 86 400, representing the number of seconds between midnight and the time value specified in the argument.

The argument must be a time, timestamp, or a valid character string representation of a time or timestamp that is neither a CLOB nor a LONG VARCHAR. In a Unicode database, if a supplied argument is a graphic string, it is first converted to a character string before the function is executed.

The result of the function is INTEGER. The result can be null; if the argument is null, the result is the null value.

Examples:

- Find the number of seconds between midnight and 00:10:10, and midnight and 13:10:10.

```
VALUES (MIDNIGHT_SECONDS('00:10:10'), MIDNIGHT_SECONDS('13:10:10'))
```

This example returns the following:

```
1          2
-----
          610      47410
```

Since a minute is 60 seconds, there are 610 seconds between midnight and the specified time. The same follows for the second example. There are 3600 seconds in an hour, and 60 seconds in a minute, resulting in 47410 seconds between the specified time and midnight.

- Find the number of seconds between midnight and 24:00:00, and midnight and 00:00:00.

```
VALUES (MIDNIGHT_SECONDS('24:00:00'), MIDNIGHT_SECONDS('00:00:00'))
```

This example returns the following:

```
1          2
-----
      86400      0
```

Note that these two values represent the same point in time, but return different MIDNIGHT\_SECONDS values.

---

**MINUTE**

►►—MINUTE—(—*expression*—)—————►►

The schema is SYSIBM.

The MINUTE function returns the minute part of a value.

The argument must be a time, timestamp, time duration, timestamp duration, or a valid character string representation of a time or timestamp that is neither a CLOB nor a LONG VARCHAR. In a Unicode database, if a supplied argument is a graphic string, it is first converted to a character string before the function is executed.

The result of the function is a large integer. If the argument can be null, the result can be null; if the argument is null, the result is the null value.

The other rules depend on the data type of the argument:

- If the argument is a time, timestamp or valid string representation of a time or timestamp:
  - The result is the minute part of the value, which is an integer between 0 and 59.
- If the argument is a time duration or timestamp duration:
  - The result is the minute part of the value, which is an integer between –99 and 99. A nonzero result has the same sign as the argument.

Example:

- Using the CL\_SCHED sample table, select all classes with a duration less than 50 minutes.

```
SELECT * FROM CL_SCHED
WHERE HOUR(ENDING - STARTING) = 0
AND
MINUTE(ENDING - STARTING) < 50
```

---

**MOD**

►►—MOD—(—*expression*—,—*expression*—)—————►►

The schema is SYSFUN.

Returns the remainder of the first argument divided by the second argument. The result is negative only if first argument is negative.

The result of the function is:

- SMALLINT if both arguments are SMALLINT
- INTEGER if one argument is INTEGER and the other is INTEGER or SMALLINT
- BIGINT if one argument is BIGINT and the other argument is BIGINT, INTEGER or SMALLINT.

The result can be null; if any argument is null, the result is the null value.

---

**MONTH**

►► MONTH(*—expression—*) ◀◀

The schema is SYSIBM.

The MONTH function returns the month part of a value.

The argument must be a date, timestamp, date duration, timestamp duration, or a valid character string representation of a date or timestamp that is neither a CLOB nor a LONG VARCHAR. In a Unicode database, if a supplied argument is a graphic string, it is first converted to a character string before the function is executed.

The result of the function is a large integer. If the argument can be null, the result can be null; if the argument is null, the result is the null value.

The other rules depend on the data type of the argument:

- If the argument is a date, timestamp, or a valid string representation of a date or timestamp:
  - The result is the month part of the value, which is an integer between 1 and 12.
- If the argument is a date duration or timestamp duration:
  - The result is the month part of the value, which is an integer between –99 and 99. A nonzero result has the same sign as the argument.

Example:

- Select all rows from the EMPLOYEE table for people who were born (BIRTHDATE) in DECEMBER.

```
SELECT * FROM EMPLOYEE
WHERE MONTH(BIRTHDATE) = 12
```



---

## MONTHNAME

►►—MONTHNAME—(*—expression—*)——————▶◀

The schema is SYSFUN.

Returns a mixed case character string containing the name of the month (for example, January) for the month portion of the argument, based on the locale when the database was started.

The argument must be a date, timestamp, or a valid character string representation of a date or timestamp that is neither a CLOB nor a LONG VARCHAR. In a Unicode database, if a supplied argument is a graphic string, it is first converted to a character string before the function is executed.

The result of the function is VARCHAR(100). The result can be null; if the argument is null, the result is the null value.

---

**MULTIPLY\_ALT**

►►MULTIPLY\_ALT(—*exact\_numeric\_expression*—,—*exact\_numeric\_expression*—)◄◄

The schema is SYSIBM.

The MULTIPLY\_ALT scalar function returns the product of the two arguments as a decimal value. It is provided as an alternative to the multiplication operator, especially when the sum of the precisions of the arguments exceeds 31.

The arguments can be any built-in exact numeric data type (DECIMAL, BIGINT, INTEGER, or SMALLINT).

The result of the function is a DECIMAL. The precision and scale of the result are determined as follows, using the symbols  $p$  and  $s$  to denote the precision and scale of the first argument, and the symbols  $p'$  and  $s'$  to denote the precision and scale of the second argument.

The precision is  $\text{MIN}(31, p + p')$

The scale is:

- 0 if the scale of both arguments is 0
- $\text{MIN}(31, s + s')$  if  $p + p'$  is less than or equal to 31
- $\text{MAX}(\text{MIN}(3, s + s'), 31 - (p - s + p' - s'))$  if  $p + p'$  is greater than 31.

The result can be null if at least one argument can be null, or if the database is configured with DFT\_SQLMATHWARN set to YES; the result is the null value if one of the arguments is null.

The MULTIPLY\_ALT function is a preferable choice to the multiplication operator when performing decimal arithmetic where a scale of at least 3 is required and the sum of the precisions exceeds 31. In these cases, the internal computation is performed so that overflows are avoided. The final result is then assigned to the result data type, using truncation where necessary to match the scale. Note that overflow of the final result is still possible when the scale is 3.

The following is a sample comparing the result types using MULTIPLY\_ALT and the multiplication operator.

| Type of argument 1 | Type of argument 2 | Result using MULTIPLY_ALT | Result using multiplication operator |
|--------------------|--------------------|---------------------------|--------------------------------------|
| DECIMAL(31,3)      | DECIMAL(15,8)      | DECIMAL(31,3)             | DECIMAL(31,11)                       |
| DECIMAL(26,23)     | DECIMAL(10,1)      | DECIMAL(31,19)            | DECIMAL(31,24)                       |
| DECIMAL(18,17)     | DECIMAL(20,19)     | DECIMAL(31,29)            | DECIMAL(31,31)                       |
| DECIMAL(16,3)      | DECIMAL(17,8)      | DECIMAL(31,9)             | DECIMAL(31,11)                       |
| DECIMAL(26,5)      | DECIMAL(11,0)      | DECIMAL(31,3)             | DECIMAL(31,5)                        |
| DECIMAL(21,1)      | DECIMAL(15,1)      | DECIMAL(31,2)             | DECIMAL(31,2)                        |

Example:

Multiply two values where the data type of the first argument is DECIMAL(26,3) and the data type of the second argument is DECIMAL(9,8). The data type of the result is DECIMAL(31,7).

```
values multiply_alt(98765432109876543210987.654,5.43210987)
```

```
1
```

```
-----  
536504678578875294857887.5277415
```

Note that the complete product of these two numbers is 536504678578875294857887.52774154498, but the last 4 digits are truncated to match the scale of the result data type. Using the multiplication operator with the same values will cause an arithmetic overflow, since the result data type is DECIMAL(31,11) and the result value has 24 digits left of the decimal, but the result data type only supports 20 digits.

---

**NULLIF**

►►—NULLIF—(—*expression*—,—*expression*—)—————►

The schema is SYSIBM.

The NULLIF function returns a null value if the arguments are equal, otherwise it returns the value of the first argument.

The arguments must be comparable. They can be of either a built-in (other than a long string or DATALINK) or distinct data type (other than based on a long string or DATALINK). (This function cannot be used as a source function when creating a user-defined function. Because this function accepts any compatible data types as arguments, it is not necessary to create additional signatures to support user-defined distinct types.) The attributes of the result are the attributes of the first argument.

The result of using NULLIF(e1,e2) is the same as using the expression

```
CASE WHEN e1=e2 THEN NULL ELSE e1 END
```

Note that when e1=e2 evaluates to unknown (because one or both arguments is NULL), CASE expressions consider this not true. Therefore, in this situation, NULLIF returns the value of the first argument.

Example:

- Assume host variables PROFIT, CASH, and LOSSES have DECIMAL data types with the values 4500.00, 500.00, and 5000.00 respectively:

```
NULLIF (:PROFIT + :CASH , :LOSSES )
```

Returns a null value.

**Related reference:**

- “Assignments and comparisons” on page 105

---

## OCTET\_LENGTH

►►—OCTET\_LENGTH—(—*expression*—)—————►►

The schema is SYSIBM.

The OCTET\_LENGTH function returns the length of *expression* in octets (bytes).

*expression*

An expression that returns a value that is a built-in string data type.

The result of the function is INTEGER. If the argument can be null, the result can be null; if the argument is null, the result is the null value.

The length of character or graphic strings includes trailing blanks. The length of binary strings includes binary zeroes. The length of varying-length strings is the actual length and not the maximum length.

For greater portability, code your application to be able to accept a result of data type DECIMAL(31).

Examples:

- Assume that table T1 has a GRAPHIC(10) column named C1.

```
SELECT OCTET_LENGTH(C1) FROM T1
```

returns the value 20.

- The following example works with the Unicode string '&N~AB', where '&' is the musical symbol G clef character, and '~' is the combining tilde character. This string is shown below in different Unicode encoding forms:

|          | '&'         | 'N'     | '~'     | 'A'     | 'B'     |
|----------|-------------|---------|---------|---------|---------|
| UTF-8    | X'F09D849E' | X'4E'   | X'CC83' | X'41'   | X'42'   |
| UTF-16BE | X'D834DD1E' | X'004E' | X'0303' | X'0041' | X'0042' |

Assume that the variables UTF8\_VAR and UTF16\_VAR contain the UTF-8 and the UTF-16BE representations of the string, respectively.

```
SELECT OCTET_LENGTH(UTF8_VAR),
       OCTET_LENGTH(UTF16_VAR)
FROM SYSIBM.SYSDUMMY1
```

returns the values 9 and 12, respectively.

**Related reference:**

- “CHARACTER\_LENGTH ” on page 295
- “LENGTH ” on page 354

POSITION

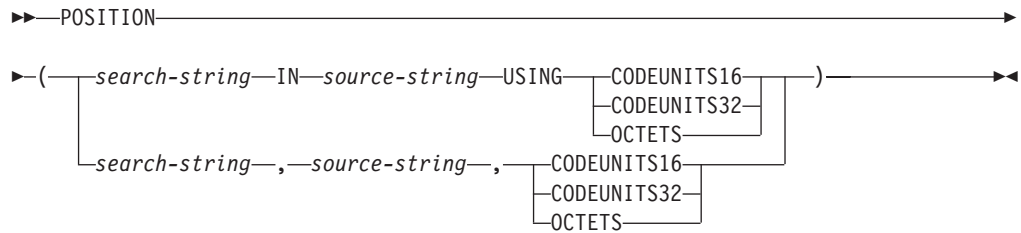

The schema is SYSIBM.

The POSITION function returns the starting position of the first occurrence of one string (called the *search-string*) within another string (called the *source-string*). If *search-string* is not found and neither argument is null, the result is zero. If the *search-string* is found, the result is a number from 1 to the actual length of *source-string*, expressed in the string unit that is explicitly specified.

If *source-string* has an actual length of 0, the result of the function is 0. If *search-string* has an actual length of 0 and *source-string* is not null, the result of the function is 1.

*search-string*

An expression that specifies the string that is the object of the search. The expression must return a value that is a built-in character string data type, graphic string data type, or binary string data type with an actual length that is no greater than 4000 bytes. No element of the expression can be of type LONG VARCHAR, CLOB, LONG VARGRAPHIC, or DBCLOB. In addition, it cannot be a BLOB file reference variable. The expression can be specified by any of the following:

- A constant
- A special register
- A host variable
- A scalar function whose operands are any of the above
- An expression that concatenates (using CONCAT or ||) any of the above
- An SQL procedure parameter

These rules are similar to those that are described for *pattern-expression* for the LIKE predicate.

*source-string*

An expression that specifies the string in which the search is to take place. The expression must return a value that is a built-in character string data type, graphic string data type, or binary string data type. The expression can be specified by any of the following:

- A constant
- A special register
- A host variable (including a locator variable or a file reference variable)
- A scalar function
- A large object locator
- A column name
- An expression that concatenates (using CONCAT or ||) any of the above

**CODEUNITS16, CODEUNITS32, or OCTETS**

Specifies the string unit of the result. CODEUNITS16 specifies that the result is to be expressed in 16-bit UTF-16 code units. CODEUNITS32 specifies that the result is to be expressed in 32-bit UTF-32 code units. OCTETS specifies that the result is to be expressed in bytes.

If a string unit is specified as CODEUNITS16 or CODEUNITS32, and *search-string* or *source-string* is a binary string or bit data, an error is returned (SQLSTATE 428GC). If a string unit is specified as OCTETS, *search-string* is converted to the code page of the *source-string* if it has a different code page. In this case, the operation is done in the code page of the *source-string*. If a string unit is specified as OCTETS and *search-string* and *source-string* are binary strings, an error is returned (SQLSTATE 42815).

For more information about CODEUNITS16, CODEUNITS32, and OCTETS, see “String units in built-in functions” in “Character strings”.

The first and second arguments must have compatible string types. For more information on compatibility, see “Rules for string conversions”.

The result of the function is a large integer. If any argument can be null, the result can be null; if any argument is null, the result is the null value.

Examples:

- Select the RECEIVED column, the SUBJECT column, and the starting position of the string ‘GOOD BEER’ within the NOTE\_TEXT column for all rows in the IN\_TRAY table that contain that string.

```
SELECT RECEIVED, SUBJECT, POSITION('GOOD BEER', NOTE_TEXT, OCTETS)
FROM IN_TRAY
WHERE POSITION('GOOD BEER', NOTE_TEXT, OCTETS) <> 0
```

- Find the position of the character ‘B’ in the string ‘Jürgen lives on Hegelstraße’, and set the host variable LOCATION with the position, as measured in CODEUNITS32 units, within the string.

```
SET :LOCATION = POSITION(
    'B', 'Jürgen lives on Hegelstraße', CODEUNITS32
)
```

The value of host variable LOCATION is set to 27.

- Find the position of the character ‘B’ in the string ‘Jürgen lives on Hegelstraße’, and set the host variable LOCATION with the position, as measured in OCTETS, within the string.

```
SET :LOCATION = POSITION(
    'B', 'Jürgen lives on Hegelstraße', OCTETS
)
```

The value of host variable LOCATION is set to 28.

- The following examples work with the Unicode string ‘&N~AB’, where ‘&’ is the musical symbol G clef character, and ‘~’ is the combining tilde character. This string is shown below in different Unicode encoding forms:

|          | '&'         | 'N'     | '~'     | 'A'     | 'B'     |
|----------|-------------|---------|---------|---------|---------|
| UTF-8    | X'F09D849E' | X'4E'   | X'CC83' | X'41'   | X'42'   |
| UTF-16BE | X'D834DD1E' | X'004E' | X'0303' | X'0041' | X'0042' |

Assume that the variable UTF8\_VAR contains the UTF-8 representation of the string.

## POSITION

```
SELECT POSITION('N', UTF8_VAR, CODEUNITS16),  
       POSITION('N', UTF8_VAR, CODEUNITS32),  
       POSITION('N', UTF8_VAR, OCTETS)  
FROM SYSIBM.SYSDUMMY1
```

returns the values 3, 2, and 5, respectively.

Assume that the variable UTF16\_VAR contains the UTF-16BE representation of the string.

```
SELECT POSITION('B', UTF16_VAR, CODEUNITS16),  
       POSITION('B', UTF16_VAR, CODEUNITS32),  
       POSITION('B', UTF16_VAR, OCTETS)  
FROM SYSIBM.SYSDUMMY1
```

returns the values 6, 5, and 11, respectively.

### Related reference:

- “Character strings” on page 81
- “LOCATE ” on page 357
- “Rules for string conversions” on page 120



---

## POSSTR

►►—POSSTR—(—*source-string*—,—*search-string*—)—————►◄

The schema is SYSIBM.

The POSSTR function returns the starting position of the first occurrence of one string (called the *search-string*) within another string (called the *source-string*). Numbers for the *search-string* position start at 1 (not 0).

The result of the function is a large integer. If either of the arguments can be null, the result can be null; if either of the arguments is null, the result is the null value.

### *source-string*

An expression that specifies the source string in which the search is to take place.

The expression can be specified by any one of:

- A constant
- A special register
- A host variable (including a locator variable or a file reference variable)
- A scalar function
- A large object locator
- A column name
- An expression concatenating any of the above

### *search-string*

An expression that specifies the string that is to be searched for.

The expression can be specified by any one of:

- A constant
- A special register
- A host variable
- A scalar function whose operands are any of the above
- An expression concatenating any of the above
- An SQL procedure parameter

with the restrictions that:

- No element in the expression can be of type LONG VARCHAR, CLOB, LONG VARGRAPHIC or DBCLOB. In addition, it cannot be a BLOB file reference variable.
- The actual length of *search-string* cannot be more than 4 000 bytes.

The following are examples of invalid string expressions or strings:

- SQL user-defined function parameters
- Trigger transition variables
- Local variables in dynamic compound statements

Both *search-string* and *source-string* have zero or more contiguous positions. If the strings are character or binary strings, a position is a byte. If the strings are graphic strings, a position is a graphic (DBCS) character.

## POSSTR

The POSSTR function accepts mixed data strings. However, POSSTR operates on a strict byte-count basis, oblivious to changes between single and multi-byte characters.

The following rules apply:

- The data types of *source-string* and *search-string* must be compatible, otherwise an error is raised (SQLSTATE 42884).
  - If *source-string* is a character string, then *search-string* must be a character string, but not a CLOB or LONG VARCHAR, with an actual length of 32 672 bytes or less.
  - If *source-string* is a graphic string, then *search-string* must be a graphic string, but not a DBCLOB or LONG VARGRAPHIC, with an actual length of 16 336 double-byte characters or less.
  - If *source-string* is a binary string, then *search-string* must be a binary string with an actual length of 32 672 bytes or less.
- If *search-string* has a length of zero, the result returned by the function is 1.
- Otherwise:
  - If *source-string* has a length of zero, the result returned by the function is zero.
  - Otherwise:
    - If the value of *search-string* is equal to an identical length substring of contiguous positions from the value of *source-string*, then the result returned by the function is the starting position of the first such substring within the *source-string* value.
    - Otherwise, the result returned by the function is 0.

Example

- Select RECEIVED and SUBJECT columns as well as the starting position of the words 'GOOD BEER' within the NOTE\_TEXT column for all entries in the IN\_TRAY table that contain these words.

```
SELECT RECEIVED, SUBJECT, POSSTR(NOTE_TEXT, 'GOOD BEER')
FROM IN_TRAY
WHERE POSSTR(NOTE_TEXT, 'GOOD BEER') <> 0
```

---

**POWER**

►►—POWER—(—*expression1*—,—*expression2*—)—————►◄

The schema is SYSFUN.

Returns the value of *expression1* to the power of *expression2*.

The arguments can be of any built-in numeric data type. DECIMAL and REAL arguments are converted to a double-precision floating-point number.

The result of the function is:

- INTEGER if both arguments are INTEGER or SMALLINT
- BIGINT if one argument is BIGINT and the other argument is BIGINT, INTEGER or SMALLINT
- DOUBLE otherwise.

The result can be null; if any argument is null, the result is the null value.

---

## QUARTER

►►—QUARTER—(—*expression*—)—————►►

The schema is SYSFUN.

Returns an integer value in the range 1 to 4, representing the quarter of the year for the date specified in the argument.

The argument must be a date, timestamp, or a valid character string representation of a date or timestamp that is neither a CLOB nor a LONG VARCHAR. In a Unicode database, if a supplied argument is a graphic string, it is first converted to a character string before the function is executed.

The result of the function is INTEGER. The result can be null; if the argument is null, the result is the null value.

---

## RADIANS

►►—RADIANS—(*—expression—*)—◄◄

The schema is SYSFUN.

Returns the number of radians converted from argument which is expressed in degrees.

The argument can be of any built-in numeric data type. It is converted to a double-precision floating-point number for processing by the function.

The result of the function is a double-precision floating-point number. The result can be null; if the argument is null, the result is the null value.

---

**RAISE\_ERROR**

►►—RAISE\_ERROR—(—*sqlstate*—,—*diagnostic-string*—)—————►►

The schema is SYSIBM.

The RAISE\_ERROR function causes the statement that includes the function to return an error with the specified SQLSTATE, SQLCODE -438, and *diagnostic-string*. The RAISE\_ERROR function always returns NULL with an undefined data type. In a Unicode database, if a supplied argument is a graphic string, it is first converted to a character string before the function is executed.

*sqlstate*

A character string containing exactly 5 bytes. It must be of type CHAR defined with a length of 5 or type VARCHAR defined with a length of 5 or greater. The *sqlstate* value must follow the rules for application-defined SQLSTATES as follows:

- Each character must be from the set of digits ('0' through '9') or non-accented upper case letters ('A' through 'Z')
- The SQLSTATE class (first two characters) cannot be '00', '01' or '02' since these are not error classes.
- If the SQLSTATE class (first two characters) starts with the character '0' through '6' or 'A' through 'H', then the subclass (last three characters) must start with a letter in the range 'I' through 'Z'
- If the SQLSTATE class (first two characters) starts with the character '7', '8', '9' or 'I' through 'Z', then the subclass (last three characters) can be any of '0' through '9' or 'A' through 'Z'.

If the SQLSTATE does not conform to these rules an error occurs (SQLSTATE 428B3).

*diagnostic-string*

An expression of type CHAR or VARCHAR that returns a character string of up to 70 bytes that describes the error condition. If the string is longer than 70 bytes, it will be truncated.

To use this function in a context where the rules for result data types do not apply (such as alone in a select list), a cast specification must be used to give the null returned value a data type. A CASE expression is where the RAISE\_ERROR function will be most useful.

Example:

List employee numbers and education levels as Post Graduate, Graduate and Diploma. If an education level is greater than 20, raise an error.

```
SELECT EMPNO,
       CASE WHEN EDUCLVL < 16 THEN 'Diploma'
            WHEN EDUCLVL < 18 THEN 'Graduate'
            WHEN EDUCLVL < 21 THEN 'Post Graduate'
            ELSE RAISE_ERROR('70001',
                          'EDUCLVL has a value greater than 20')
       END
FROM EMPLOYEE
```

---

**RAND**

```
»»—RAND—(—expression—)——————»»
```

The schema is SYSFUN.

The RAND function returns a floating point value between 0 and 1.

If an expression is specified, it is used as the seed value. The expression must be a built-in SMALLINT or INTEGER data type with a value between 0 and 2 147 483 647.

The data type of the result is double-precision floating point. If the argument is null, the result is the null value.

A specific seed value will produce the same sequence of random numbers for a specific instance of a RAND function in a query each time the query is executed. If a seed value is not specified, a different sequence of random numbers is produced each time the query is executed within the same session. To produce a set of random numbers that varies from session to session, specify a random seed; for example, one that is based on the current time.

RAND is a non-deterministic function.

---

**REAL**

►►—REAL—(*—numeric-expression—*)—◄◄

The schema is SYSIBM.

The REAL function returns a single-precision floating-point representation of a number.

The argument is an expression that returns a value of any built-in numeric data type.

The result of the function is a single-precision floating-point number. If the argument can be null, the result can be null; if the argument is null, the result is the null value.

The result is the same number that would occur if the argument were assigned to a single-precision floating-point column or variable.

Example:

Using the EMPLOYEE table, find the ratio of salary to commission for employees whose commission is not zero. The columns involved (SALARY and COMM) have DECIMAL data types. The result is desired in single-precision floating point. Therefore, REAL is applied to SALARY so that the division is carried out in floating point (actually double-precision) and then REAL is applied to the complete expression to return the result in single-precision floating point.

```
SELECT EMPNO, REAL(REAL(SALARY)/COMM)
FROM EMPLOYEE
WHERE COMM > 0
```



## REC2XML

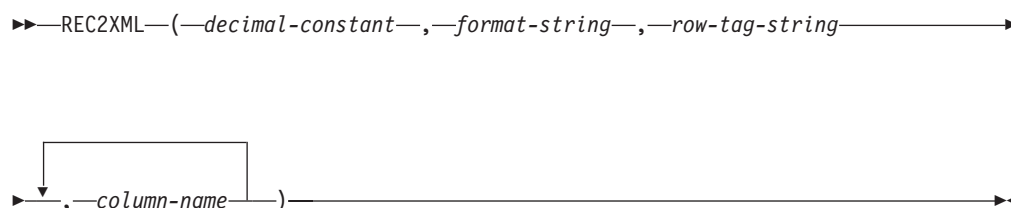

The schema is SYSIBM.

The REC2XML function returns a string formatted with XML tags, containing column names and column data. In a Unicode database, if a supplied argument is a graphic string, it is first converted to a character string before the function is executed.

### *decimal-constant*

The expansion factor for replacing column data characters. The decimal value must be greater than 0.0 and less than or equal to 6.0. (SQLSTATE 42820).

The *decimal-constant* value is used to calculate the result length of the function. For every column with a character data type, the length attribute of the column is multiplied by this expansion factor before it is added in to the result length.

To specify no expansion, use a value of 1.0. Specifying a value less than 1.0 reduces the calculated result length. If the actual length of the result string is greater than the calculated result length of the function, then an error is raised (SQLSTATE 22001).

### *format-string*

The string constant that specifies which format the function is to use during execution.

The *format-string* is case-sensitive, so the following values must be specified in uppercase to be recognized.

### COLATTVAL or COLATTVAL\_XML

These formats return a string with columns as attribute values.

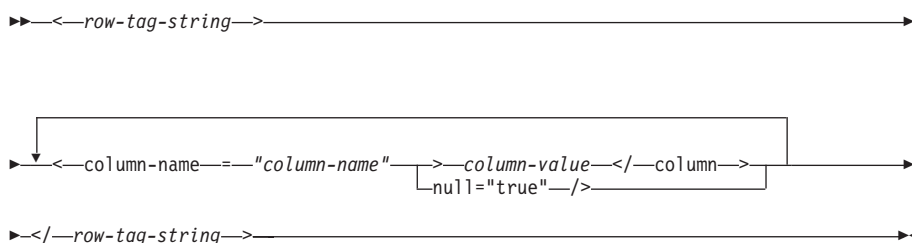

Column names may or may not be valid XML attribute values. For column names which are not valid XML attribute values, character replacement is performed on the column name before it is included in the result string.

Column values may or may not be valid XML element names. If the *format-string* COLATTVAL is specified, then for the column names which are

not valid XML element values, character replacement is performed on the column value before it is included in the result string. If the *format-string* COLATTVAL\_XML is specified, then character replacement is not performed on column values (although character replacement is still performed on column names).

*row-tag-string*

A string constant that specifies the tag used for each row. If an empty string is specified, then a value of 'row' is assumed.

If a string of one or more blank characters is specified, then no beginning *row-tag-string* or ending *row-tag-string* (including the angle bracket delimiters) will appear in the result string.

*column-name*

A qualified or unqualified name of a table column. The column must have one of the following data types (SQLSTATE 42815):

- numeric (SMALLINT, INTEGER, BIGINT, DECIMAL, REAL, DOUBLE)
- character string (CHAR, VARCHAR; a character string with a subtype of BIT DATA is not allowed)
- datetime (DATE, TIME, TIMESTAMP)
- a user-defined type based on one of the above types

The same column name cannot be specified more than once (SQLSTATE 42734).

The result of the function is VARCHAR. The maximum length is 32 672 bytes (SQLSTATE 54006).

Consider the following invocation:

```
REC2XML (dc, fs, rt, c1, c2, ..., cn)
```

If the value of "fs" is either "COLATTVAL" or "COLATTVAL\_XML", then the result is the same as this expression:

```
'<' CONCAT rt CONCAT '>' CONCAT y1 CONCAT y2  
CONCAT ... CONCAT yn CONCAT '</' CONCAT rt CONCAT '>'
```

where y<sub>n</sub> is equivalent to:

```
'<column name="' CONCAT xvcn CONCAT vn
```

and vn is equivalent to:

```
'">' CONCAT rn CONCAT '</column>'
```

if the column is not null, and

```
'" null="true"/>'
```

if the column value is null.

xvc<sub>n</sub> is equivalent to a string representation of the column name of c<sub>n</sub>, where any characters appearing in Table 27 on page 389 are replaced with the corresponding representation. This ensures that the resulting string is a valid XML attribute or element value token.

The  $r_n$  is equivalent to a string representation as indicated in Table 26

Table 26. Column Values String Result

| Data type of $c_n$  | $r_n$   |
|---|---|
| CHAR, VARCHAR   | The value is a string. If the <i>format-string</i> does not end in the characters "_XML", then each character in $c_n$ is replaced with the corresponding replacement representation from Table 27, as indicated. The length attribute is: $dc * \text{the length attribute of } c_n$ . |
| SMALLINT, INTEGER, BIGINT, DECIMAL, NUMERIC, REAL, DOUBLE | The value is <code>LTRIM(RTRIM(CHAR(<math>c_n</math>)))</code> . The length attribute is the result length of <code>CHAR(<math>c_n</math>)</code> . The decimal character is always the period ('.') character.   |
| DATE  | The value is <code>CHAR(<math>c_n</math>,ISO)</code> . The length attribute is the result length of <code>CHAR(<math>c_n</math>,ISO)</code> .   |
| TIME  | The value is <code>CHAR(<math>c_n</math>,JIS)</code> . The length attribute is the result length of <code>CHAR(<math>c_n</math>,JIS)</code> .   |
| TIMESTAMP   | The value is <code>CHAR(<math>c_n</math>)</code> . The length attribute is the result length of <code>CHAR(<math>c_n</math>)</code> .   |

Character replacement:

Depending on the value specified for the *format-string*, certain characters in column names and column values will be replaced to ensure that the column names form valid XML attribute values and the column values form valid XML element values.

Table 27. Character Replacements for XML Attribute Values and Element Values

| Character | Replacement |
|-----------|-------------|
| <         | &lt;        |
| >         | &gt;        |
| "         | &quot;      |
| &         | &amp;       |
| '         | &apos;      |

Examples:

**Note:** REC2XML does not insert blank spaces or new line characters in the output. All example output has been formatted to enhance readability.

- Using the DEPARTMENT table in the sample database, format the department table row, except the DEPTNAME and LOCATION columns, for department 'D01' into an XML string. Since the data does not contain any of the characters which require replacement, the expansion factor will be 1.0 (no expansion). Also note that the MGRNO value is null for this row.

```
SELECT REC2XML (1.0, 'COLATTVAL', '', DEPTNO, MGRNO, ADMRDEPT)
FROM DEPARTMENT
WHERE DEPTNO = 'D01'
```

This example returns the following VARCHAR(117) string:

```

<row>
<column name="DEPTNO">D01</column>
<column name="MGRNO" null="true"/>
<column name="ADMRDEPT">A00</column>
</row>

```

- A 5-day university schedule introduces a class named '&43<FIE' to a table called CL\_SCHED, with a new format for the CLASS\_CODE column. Using the REC2XML function, this example formats an XML string with this new class data, except for the class end time.

The length attribute for the REC2XML call (see below) with an expansion factor of 1.0 would be 128 (11 for the '<row>' and '</row>' overhead, 21 for the column names, 75 for the '<column name=', '>', '</column>' and double quotes, 7 for the CLASS\_CODE data, 6 for the DAY data, and 8 for the STARTING data). Since the '&' and '<' characters will be replaced, an expansion factor of 1.0 will not be sufficient. The length attribute of the function will need to support an increase from 7 to 14 bytes for the new format CLASS\_CODE data.

However, since it is known that the DAY value will never be more than 1 digit long, an unused extra 5 units of length are added to the total. Therefore, the expansion only needs to handle an increase of 2. Since CLASS\_CODE is the only character string column in the argument list, this is the only column data to which the expansion factor applies. To get an increase of 2 for the length, an expansion factor of 9/7 (approximately 1.2857) would be needed. An expansion factor of 1.3 will be used.

```

SELECT REC2XML (1.3, 'COLATTVAL', 'record', CLASS_CODE, DAY, STARTING)
FROM CL_SCHED
WHERE CLASS_CODE = '&43<FIE'

```

This example returns the following VARCHAR(167) string:

```

<record>
<column name="CLASS_CODE">&43<FIE</column>
<column name="DAY">5</column>
<column name="STARTING">06:45:00</column>
</record>

```

- Assume that new rows have been added to the EMP\_RESUME table in the sample database. The new rows store the resumes as strings of valid XML. The COLATTVAL\_XML *format-string* is used so character replacement will not be carried out. None of the resumes are more than 3500 bytes in length. The following query is used to select the XML version of the resumes from the EMP\_RESUME table and format it into an XML document fragment.

```

SELECT REC2XML (1.0, 'COLATTVAL_XML', 'row', EMPNO, RESUME_XML)
FROM (SELECT EMPNO, CAST(RESUME AS VARCHAR(3500)) AS RESUME_XML
FROM EMP_RESUME
WHERE RESUME_FORMAT = 'XML')
AS EMP_RESUME_XML

```

This example returns a row for each employee who has a resume in XML format. Each returned row will be a string with the following format:

```

<row>
<column name="EMPNO">{employee number}</column>
<column name="RESUME_XML">{resume in XML}</column>
</row>

```

Where "{employee number}" is the actual EMPNO value for the column and "{resume in XML}" is the actual XML fragment string value that is the resume.

---

## REPEAT

►►—REPEAT—(—*expression*—,—*expression*—)—————►►

The schema is SYSFUN.

Returns a character string composed of the first argument repeated the number of times specified by the second argument. In a Unicode database, if a supplied argument is a graphic string, it is first converted to a character string before the function is executed.

The first argument is a character string or binary string type. For a VARCHAR the maximum length is 4 000 bytes and for a CLOB or a binary string the maximum length is 1 048 576 bytes. The second argument can be SMALLINT or INTEGER.

The result of the function is:

- VARCHAR(4000) if the first argument is VARCHAR (not exceeding 4 000 bytes) or CHAR
- CLOB(1M) if the first argument is CLOB or LONG VARCHAR
- BLOB(1M) if the first argument is BLOB.

The result can be null; if any argument is null, the result is the null value.

Example:

- List the phrase 'REPEAT THIS' five times.  
**VALUES CHAR(REPEAT('REPEAT THIS', 5), 60)**

This example return the following:

```
1
-----
REPEAT THISREPEAT THISREPEAT THISREPEAT THISREPEAT THIS
```

As mentioned, the output of the REPEAT function is VARCHAR(4000). For this example, the CHAR function has been used to limit the output of REPEAT to 60 bytes.

---

**REPLACE**

►►—REPLACE—(—*expression1*—,—*expression2*—,—*expression3*—)—►►

The schema is SYSFUN.

Replaces all occurrences of *expression2* in *expression1* with *expression3*.

The first argument can be of any built-in character string or binary string type. In a Unicode database, if a supplied argument is a graphic string, it is first converted to a character string before the function is executed. For a VARCHAR, the maximum length is 4 000 bytes, and for a CLOB or a binary string, the maximum length is 1 048 576 bytes. CHAR is converted to VARCHAR and LONG VARCHAR is converted to CLOB(1M). The type of the second and third arguments is identical to that of the first argument.

The result of the function is:

- VARCHAR(4000) if the first, second, and third arguments are VARCHAR or CHAR
- CLOB(1M) if the first, second, and third arguments are CLOB or LONG VARCHAR
- BLOB(1M) if the first, second, and third arguments are BLOB.

The result can be null; if any argument is null, the result is the null value.

Example:

Replace all occurrence of the letter 'N' in the word 'DINING' with 'VID'.

```
VALUES CHAR (REPLACE ('DINING', 'N', 'VID'), 10)
```

This example returns the following:

```
1
-----
DIVIDIVIDG
```

As mentioned, the output of the REPLACE function is VARCHAR(4000). For this example, the CHAR function has been used to limit the output of REPLACE to 10 bytes.

---

## RIGHT

►►—RIGHT—(—*expression1*—,—*expression2*—)—————►►

Returns a string consisting of the rightmost *expression2* bytes in *expression1*. The *expression1* value is effectively padded on the right with the necessary number of blank characters so that the specified substring of *expression1* always exists.

The first argument is a character string or a binary string type. In a Unicode database, if a supplied argument is a graphic string, it is first converted to a character string before the function is executed. For a VARCHAR, the maximum length is 4 000 bytes, and for a CLOB or a binary string, the maximum length is 1 048 576 bytes. The second argument can be INTEGER or SMALLINT.

The result of the function is:

- VARCHAR(4000) if the first argument is VARCHAR (not exceeding 4 000 bytes) or CHAR
- CLOB(1M) if the first argument is CLOB or LONG VARCHAR
- BLOB(1M) if the first argument is BLOB.

The result can be null; if any argument is null, the result is the null value.

---

**ROUND**

►►—ROUND—(—*expression1*—,—*expression2*—)—————►►

The schema is SYSIBM. (The SYSFUN version of the ROUND function continues to be available.)

The ROUND function returns *expression1* rounded to *expression2* places to the right of the decimal point if *expression2* is positive, or to the left of the decimal point if *expression2* is zero or negative.

If *expression1* is positive, a digit value of 5 or greater is an indication to round to the next higher positive number. For example, ROUND(3.5,0) = 4. If *expression1* is negative, a digit value of 5 or greater is an indication to round to the next lower negative number. For example, ROUND(-3.5,0) = -4.

*expression1*

An expression that returns a value of any built-in numeric data type.

*expression2*

An expression that returns a small or large integer. When the value of *expression2* is not negative, it specifies rounding to that number of places to the right of the decimal separator. When the value of *expression2* is negative, it specifies rounding to the absolute value of *expression2* places to the left of the decimal separator.

If *expression2* is not negative, *expression1* is rounded to the absolute value of *expression2* number of places to the right of the decimal point. If the value of *expression2* is greater than the scale of *expression1* then the value is unchanged except that the result value has a precision that is larger by 1. For example, ROUND(748.58,5) = 748.58 where the precision is now 6 and the scale remains 2.

If *expression2* is negative, *expression1* is rounded to the absolute value of *expression2*+1 number of places to the left of the decimal point.

If the absolute value of a negative *expression2* is larger than the number of digits to the left of the decimal point, the result is 0. For example, ROUND(748.58,-4) = 0.

The data type and length attribute of the result are the same as the data type and length attribute of the first argument, except that the precision is increased by one if the *expression1* is DECIMAL and the precision is less than 31.

For example, an argument with a data type of DECIMAL(5,2) results in DECIMAL(6,2). An argument with a data type of DECIMAL(31,2) results in DECIMAL(31,2). The scale is the same as the scale of the first argument.

If either argument can be null or the database is configured with DFT\_SQLMATHWARN set to YES, the result can be null. If either argument is null, the result is the null value.

Examples:

Calculate the value of 873.726, rounded to 2, 1, 0, -1, -2, -3, and -4 decimal places, respectively.



```
VALUES (
  ROUND(873.726, 2),
  ROUND(873.726, 1),
  ROUND(873.726, 0),
  ROUND(873.726,-1),
  ROUND(873.726,-2),
  ROUND(873.726,-3),
  ROUND(873.726,-4) )
```

This example returns:

| 1       | 2       | 3       | 4       | 5       | 6        | 7     |
|---------|---------|---------|---------|---------|----------|-------|
| 873.730 | 873.700 | 874.000 | 870.000 | 900.000 | 1000.000 | 0.000 |

Calculate using both positive and negative numbers.

```
VALUES (
  ROUND(3.5, 0),
  ROUND(3.1, 0),
  ROUNDROUND(-3.1, 0),
  ROUND(-3.5,0) )
```

This example returns:

| 1   | 2   | 3    | 4    |
|-----|-----|------|------|
| 4.0 | 3.0 | -3.0 | -4.0 |

---

**RTRIM**

►►—RTRIM—(—*string-expression*—)—————►►

The schema is SYSIBM. (The SYSFUN version of this function continues to be available with support for LONG VARCHAR and CLOB arguments.)

The RTRIM function removes blanks from the end of *string-expression*.

The argument can be a CHAR, VARCHAR, GRAPHIC, or VARGRAPHIC data type.

- If the argument is a graphic string in a DBCS or EUC database, then the trailing double byte blanks are removed.
- If the argument is a graphic string in a Unicode database, then the trailing UCS-2 blanks are removed.
- Otherwise, the trailing single byte blanks are removed.

The result data type of the function is:

- VARCHAR if the data type of *string-expression* is VARCHAR or CHAR
- VARGRAPHIC if the data type of *string-expression* is VARGRAPHIC or GRAPHIC

The length parameter of the returned type is the same as the length parameter of the argument data type.

The actual length of the result for character strings is the length of *string-expression* minus the number of bytes removed for blank characters. The actual length of the result for graphic strings is the length (in number of double byte characters) of *string-expression* minus the number of double byte blank characters removed. If all of the characters are removed, the result is an empty, varying-length string (length is zero).

If the argument can be null, the result can be null; if the argument is null, the result is the null value.

Example: Assume that host variable HELLO is defined as CHAR(9) and has a value of 'Hello'.

```
VALUES RTRIM(:HELLO)
```

The result is 'Hello'.

**Related reference:**

- “RTRIM (SYSFUN schema) ” on page 397

---

## RTRIM (SYSFUN schema)

►►—RTRIM—(*expression*)—◄◄

The schema is SYSFUN.

Returns the characters of the argument with trailing blanks removed.

The argument can be of any built-in character string data types. For a VARCHAR the maximum length is 4 000 bytes and for a CLOB the maximum length is 1 048 576 bytes.

The result of the function is:

- VARCHAR(4000) if the argument is VARCHAR (not exceeding 4 000 bytes) or CHAR
- CLOB(1M) if the argument is CLOB or LONG VARCHAR.

The result can be null; if the argument is null, the result is the null.

---

**SECLABEL**

►►—SECLABEL—(—*security-policy-name*—,—*string-constant*—)—————►

The schema is SYSIBM.

The SECLABEL function returns an unnamed security label with a data type of DB2SECURITYLABEL. Use the SECLABEL function to insert a security label with given component values without having to create a named security label.

*security-policy-name*

An expression that returns a CHAR, VARCHAR, GRAPHIC, or VARGRAPHIC value. This expression must be the name of a security policy that exists at the current server (SQLSTATE 42704).

*string-constant*

A character constant that contains a valid representation of a security label for the security policy named by *security-policy-name* (SQLSTATE 4274I).

Examples:

- The following statement inserts a row in table REGIONS which is protected by the security policy named CONTRIBUTIONS. The security label for the row to be inserted is given by the SECLABEL function. The security policy CONTRIBUTIONS has two components. The security label given has the element LIFE MEMBER for first component, the elements BLUE and YELLOW for the second component.

```
INSERT INTO REGIONS
VALUES (SECLABEL('CONTRIBUTIONS', 'LIFE MEMBER:(BLUE,YELLOW)'),
1, 'Northeast')
```

- The following statement inserts a row in table CASE\_IDS which is protected by the security policy named TS\_SECPOLICY, which has three components. The security label is provided by the SECLABEL function. The security label inserted has the element HIGH PROFILE for the first component, the empty value for the second component and the element G19 for the third component.

```
INSERT INTO CASE_IDS
VALUES (SECLABEL('TS_SECPOLICY', 'HIGH PROFILE:():G19') , 3, 'KLB')
```

**Related concepts:**

- “Built-in functions for dealing with LBAC security labels” in *Administration Guide: Implementation*
- “LBAC security labels” in *Administration Guide: Implementation*
- “LBAC security policies” in *Administration Guide: Implementation*

**Related reference:**

- “Format for security label values” in *Administration Guide: Implementation*
- “SECLABEL\_BY\_NAME ” on page 399
- “SECLABEL\_TO\_CHAR ” on page 400

---

## SECLABEL\_BY\_NAME

►►—SECLABEL\_BY\_NAME—(—*security-policy-name*—,—*security-label-name*—)————►►

The schema is SYSIBM.

The SECLABEL\_BY\_NAME function returns the specified security label. The security label returned has a data type of DB2SECURITYLABEL. Use this function to insert a named security label.

### *security-policy-name*

A string expression with a resulting type of CHAR, VARCHAR, GRAPHIC, or VARGRAPHIC and a value that is the name of a security policy that exists at the current server (SQLSTATE 42704).

### *security-label-name*

A string expression with a resulting type of CHAR, VARCHAR, GRAPHIC, or VARGRAPHIC and a value that is the name of a security label for the security policy named by *security-policy-name* (SQLSTATE 4274I).

Examples:

- User Tina is trying to insert a row in table REGIONS which is protected by the security policy named CONTRIBUTIONS. Tina wants the row to be protected by the security label named EMPLOYEESECLABEL. This statement fails because CONTRIBUTIONS.EMPLOYEESECLABEL is an unknown identifier:

```
INSERT INTO REGIONS
VALUES (CONTRIBUTIONS.EMPLOYEESECLABEL, 1, 'Southwest') -- incorrect
```

This statement fails because the first value is a string, it does not have a data type of DB2SECURITYLABEL:

```
INSERT INTO REGIONS
VALUES ('CONTRIBUTIONS.EMPLOYEESECLABEL', 1, 'Southwest') -- incorrect
```

This statement succeeds because the SECLABEL\_BY\_NAME function returns a security label that has a data type of DB2SECURITYLABEL:

```
INSERT INTO REGIONS
VALUES (SECLABEL_BY_NAME('CONTRIBUTIONS', 'EMPLOYEESECLABEL'),
1, 'Southwest') -- correct
```

### Related concepts:

- “Built-in functions for dealing with LBAC security labels” in *Administration Guide: Implementation*
- “LBAC security labels” in *Administration Guide: Implementation*
- “LBAC security policies” in *Administration Guide: Implementation*

### Related reference:

- “SECLABEL ” on page 398
- “SECLABEL\_TO\_CHAR ” on page 400
- “Format for security label values” in *Administration Guide: Implementation*

---

## SECLABEL\_TO\_CHAR

►►—SECLABEL\_TO\_CHAR—(—*security-policy-name*—,—*security-label*—)————►►

The schema is SYSIBM.

The SECLABEL\_TO\_CHAR function accepts a security label and returns a string that contains all elements in the security label. The string is in the security label string format.

### *security-policy-name*

An expression that returns a CHAR, VARCHAR, GRAPHIC, or VARGRAPHIC value. This expression must be the name of a security policy that exists at the current server (SQLSTATE 42704).

### *security-label*

An expression that returns a security label value that is valid for the security policy named by *security-policy-name* (SQLSTATE 4274I).

### Notes:

- If the authorization ID of the statement executes this function on a security label being read from a column with a data type of DB2SECURITYLABEL then that authorization ID's LBAC credentials might affect the output of the function. In such a case an element is not included in the output if the authorization ID does not have read access to that element. An authorization ID has read access to an element if its LBAC credentials would allow it to read data that was protected by a security label containing only that element, and no others.

For the rule set DB2LBACRULES only components of type TREE can contain elements that you do not have read access to. For other types of component, if any one of the elements block read access then you will not be able to read the row at all. So only components of type tree will have elements excluded in this way.

### Example:

- The EMP table has two columns, RECORDNUM and LABEL; RECORDNUM has data type INTEGER, and LABEL has type DB2SECURITYLABEL. Table EMP is protected by security policy DATA\_ACCESSPOLICY, which uses the DB2LBACRULES rule set and has only one component (GROUPS, of type TREE). GROUPS has five elements: PROJECT, TEST, DEVELOPMENT, CURRENT, AND FIELD. The following diagram shows the relationship of these elements to one another:

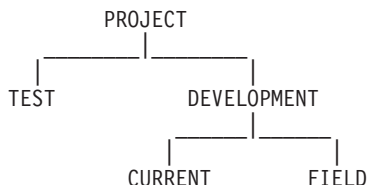

The EMP table contains the following data:

| RECORDNUM | LABEL            |
|-----------|------------------|
| 1         | PROJECT          |
| 2         | (TEST, FIELD)    |
| 3         | (CURRENT, FIELD) |

Djavan holds a security label for reading that contains only the DEVELOPMENT element. This means that Djavan has read access to the DEVELOPMENT, CURRENT, and FIELD elements:

```
SELECT RECORDNUM, SECLABEL_TO_CHAR('DATA_ACCESSPOLICY', LABEL) FROM EMP
```

returns:

```
RECORDNUM LABEL
-----
          2 FIELD
          3 (CURRENT, FIELD)
```

The row with a RECORDNUM value of 1 is not included in the output, because Djavan's LBAC credentials do not allow him to read that row. In the row with a RECORDNUM value of 2, element TEST is not included in the output, because Djavan does not have read access to that element; Djavan would not have been able to access the row at all if TEST were the only element in the security label. Because Djavan has read access to elements CURRENT and FIELD, both elements appear in the output.

Now Djavan is granted an exemption to the DB2LBACREADTREE rule. This means that no element of a TREE type component will block read access. The same query returns:

```
RECORDNUM LABEL
-----
          1 PROJECT
          2 (TEST, FIELD)
          3 (CURRENT, FIELD)
```

This time the output includes all rows and all elements, because the exemption gives Djavan read access to all of the elements.

#### Related concepts:

- "Built-in functions for dealing with LBAC security labels" in *Administration Guide: Implementation*
- "LBAC security labels" in *Administration Guide: Implementation*
- "LBAC security policies" in *Administration Guide: Implementation*

#### Related reference:

- "SECLABEL " on page 398
- "SECLABEL\_BY\_NAME " on page 399
- "Format for security label values" in *Administration Guide: Implementation*

---

**SECOND**

►►—SECOND—(*—expression—*)——————►►

The schema is SYSIBM.

The SECOND function returns the seconds part of a value.

The argument must be a time, timestamp, time duration, timestamp duration, or a valid character string representation of a time or timestamp that is neither a CLOB nor a LONG VARCHAR. In a Unicode database, if a supplied argument is a graphic string, it is first converted to a character string before the function is executed.

The result of the function is a large integer. If the argument can be null, the result can be null; if the argument is null, the result is the null value.

The other rules depend on the data type of the argument:

- If the argument is a time, timestamp or valid string representation of a time or timestamp:
  - The result is the seconds part of the value, which is an integer between 0 and 59.
- If the argument is a time duration or timestamp duration:
  - The result is the seconds part of the value, which is an integer between –99 and 99. A nonzero result has the same sign as the argument.

Examples:

- Assume that the host variable TIME\_DUR (decimal(6,0)) has the value 153045.

**SECOND**(:TIME\_DUR)

Returns the value 45.

- Assume that the column RECEIVED (timestamp) has an internal value equivalent to 1988-12-25-17.12.30.000000.

**SECOND**(RECEIVED)

Returns the value 30.



---

## SIGN

►►—SIGN—(*expression*)—◄◄

Returns an indicator of the sign of the argument. If the argument is less than zero, -1 is returned. If argument equals zero, 0 is returned. If argument is greater than zero, 1 is returned.

The argument can be of any built-in numeric data type. DECIMAL and REAL values are converted to double-precision floating-point numbers for processing by the function.

The result of the function is:

- SMALLINT if the argument is SMALLINT
- INTEGER if the argument is INTEGER
- BIGINT if the argument is BIGINT
- DOUBLE otherwise.

The result can be null; if the argument is null, the result is the null value.

---

**SIN**

►►—SIN—(*expression*)—◄◄

The schema is SYSIBM. (The SYSFUN version of the SIN function continues to be available.)

Returns the sine of the argument, where the argument is an angle expressed in radians.

The argument can be of any built-in numeric data type. It is converted to double-precision floating-point number for processing by the function.

The result of the function is a double-precision floating-point number. The result can be null if the argument can be null or the database is configured with DFT\_SQLMATHWARN set to YES; the result is the null value if the argument is null.

---

## SINH

►►—SINH—(*expression*)—◄◄

The schema is SYSIBM.

Returns the hyperbolic sine of the argument, where the argument is an angle expressed in radians.

The argument can be of any built-in numeric data type. It is converted to a double-precision floating-point number for processing by the function.

The result of the function is a double-precision floating-point number. The result can be null if the argument can be null or the database is configured with DFT\_SQLMATHWARN set to YES; the result is the null value if the argument is null.

---

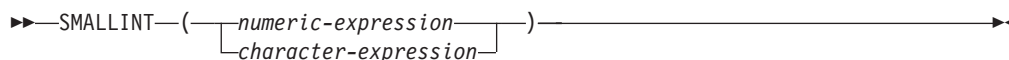
**SMALLINT**

The schema is SYSIBM.

The SMALLINT function returns a small integer representation of a number or character string in the form of a small integer constant. In a Unicode database, if a supplied argument is a graphic string, it is first converted to a character string before the function is executed.

*numeric-expression*

An expression that returns a value of any built-in numeric data type.

If the argument is a *numeric-expression*, the result is the same number that would occur if the argument were assigned to a small integer column or variable. If the whole part of the argument is not within the range of small integers, an error occurs. The decimal part of the argument is truncated if present.

*character-expression*

An expression that returns a character string value of length not greater than the maximum length of a character constant. Leading and trailing blanks are eliminated and the resulting string must conform to the rules for forming an SQL integer constant (SQLSTATE 22018). However, the value of the constant must be in the range of small integers (SQLSTATE 22003). The character string cannot be a long string.

If the argument is a *character-expression*, the result is the same number that would occur if the corresponding integer constant were assigned to a small integer column or variable.

The result of the function is a small integer. If the argument can be null, the result can be null; if the argument is null, the result is the null value.

---

**SOUNDEX**

►►—SOUNDEX—(—*expression*—)—————►►

The schema is SYSFUN.

Returns a 4-character code representing the sound of the words in the argument. The result can be used to compare with the sound of other strings.

The argument can be a character string that is either a CHAR or VARCHAR not exceeding 4 000 bytes. In a Unicode database, if a supplied argument is a graphic string, it is first converted to a character string before the function is executed.

The result of the function is CHAR(4). The result can be null; if the argument is null, the result is the null value.

The SOUNDEX function is useful for finding strings for which the sound is known but the precise spelling is not. It makes assumptions about the way that letters and combinations of letters sound that can help to search out words with similar sounds. The comparison can be done directly or by passing the strings as arguments to the DIFFERENCE function.

Example:

Using the EMPLOYEE table, find the EMPNO and LASTNAME of the employee with a surname that sounds like 'Loucesy'.

```
SELECT EMPNO, LASTNAME FROM EMPLOYEE
WHERE SOUNDEX(LASTNAME) = SOUNDEX('Loucesy')
```

This example returns the following:

```
EMPNO  LASTNAME
-----
000110  LUCCHESI
```

**Related reference:**

- “DIFFERENCE ” on page 323

---

**SPACE**

►►—SPACE—(*—expression—*)——————►◄

The schema is SYSFUN.

Returns a character string consisting of blanks with length specified by the second argument.

The argument can be SMALLINT or INTEGER.

The result of the function is VARCHAR(4000). The result can be null; if the argument is null, the result is the null value.

---

## SQRT

►►—SQRT—(*expression*)—◄◄

The schema is SYSFUN.

Returns the square root of the argument.

The argument can be any built-in numeric data type. It is converted to a double-precision floating-point number for processing by the function.

The result of the function is a double-precision floating-point number. The result can be null; if the argument is null, the result is the null value.

## STRIP

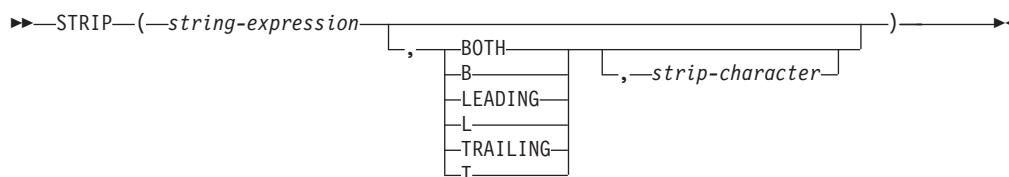

The schema is SYSIBM. The function name cannot be specified as a qualified name when keywords are used in the function signature.

The STRIP function removes blanks or occurrences of another specified character from the end or the beginning of a string expression.

The STRIP function is identical to the TRIM scalar function.

#### *string-expression*

An expression that returns a value that is a CHAR, VARCHAR, GRAPHIC, or VARGRAPHIC data type.

#### **BOTH, LEADING, or TRAILING**

Specifies whether characters are removed from the beginning, the end, or from both ends of the string expression. If this argument is not specified, the characters are removed from both the end and the beginning of the string.

#### *strip-character*

A single-character constant that specifies the character that is to be removed. If *strip-character* is not specified and:

- If the *string-expression* is a DBCS graphic string, the default *strip-character* is a DBCS blank, whose code point is dependent on the database code page
- If the *string-expression* is a UCS-2 graphic string, the default *strip-character* is a UCS-2 blank (X'0020')
- Otherwise, the default *strip-character* is an SBCS blank (X'20')

The result is a varying-length string with the same maximum length as the length attribute of the *string-expression*. The actual length of the result is the length of the *string-expression* minus the number of bytes that are removed. If all of the characters are removed, the result is an empty varying-length string. The code page of the result is the same as the code page of the *string-expression*.

Example:

- Assume that the host variable BALANCE of type CHAR(9) has a value of '000345.50'.

```
SELECT STRIP(:BALANCE, LEADING, '0'),
FROM SYSIBM.SYSDUMMY1
```

returns the value '345.50'.

#### **Related reference:**

- "TRIM " on page 433



## SUBSTR

►► SUBSTR(*string*, *start*, *length*)

The SUBSTR function returns a substring of a string.

If *string* is a character string, the result of the function is a character string represented in the code page of its first argument. If it is a binary string, the result of the function is a binary string. If it is a graphic string, the result of the function is a graphic string represented in the code page of its first argument. If the first argument is a host variable, the code page of the result is the database code page. If any argument of the SUBSTR function can be null, the result can be null; if any argument is null, the result is the null value.

*string*

An expression that specifies the string from which the result is derived.

If *string* is either a character string or a binary string, a substring of *string* is zero or more contiguous bytes of *string*. If *string* is a graphic string, a substring of *string* is zero or more contiguous double-byte characters of *string*.

*start*

An expression that specifies the position of the first byte of the result for a character string or a binary string or the position of the first character of the result for a graphic string. *start* must be an integer between 1 and the length or maximum length of *string*, depending on whether *string* is fixed-length or varying-length (SQLSTATE 22011, if out of range). It must be specified as number of bytes in the context of the database code page and not the application code page.

*length*

An expression that specifies the length of the result. If specified, *length* must be a binary integer in the range 0 to *n*, where *n* equals (the length attribute of *string*) - *start* + 1 (SQLSTATE 22011, if out of range).

If *length* is explicitly specified, *string* is effectively padded on the right with the necessary number of blank characters (single-byte for character strings; double-byte for graphic strings) or hexadecimal zero characters (for BLOB strings) so that the specified substring of *string* always exists. The default for *length* is the number of bytes from the byte specified by the *start* to the last byte of *string* in the case of character string or binary string or the number of double-byte characters from the character specified by the *start* to the last character of *string* in the case of a graphic string. However, if *string* is a varying-length string with a length less than *start*, the default is zero and the result is the empty string. It must be specified as number of bytes in the context of the database code page and not the application code page. (For example, the column NAME with a data type of VARCHAR(18) and a value of 'MCKNIGHT' will yield an empty string with SUBSTR(NAME,10)).

Table 28 on page 412 shows that the result type and length of the SUBSTR function depend on the type and attributes of its inputs.

## SUBSTR

Table 28. Data Type and Length of SUBSTR Result

| String Argument Data Type | Length Argument                                       | Result Data Type           |
|---------------------------|---|----------------------------|
| CHAR(A)                   | constant ( $l < 255$ )                                | CHAR( $l$ )                |
| CHAR(A)                   | not specified but <i>start</i> argument is a constant | CHAR( $A - start + 1$ )    |
| CHAR(A)                   | not a constant  | VARCHAR(A)                 |
|                           |   |                            |
| VARCHAR(A)                | constant ( $l < 255$ )                                | CHAR( $l$ )                |
| VARCHAR(A)                | constant ( $254 < l < 32673$ )                        | VARCHAR( $l$ )             |
| VARCHAR(A)                | not a constant or not specified                       | VARCHAR(A)                 |
|                           |   |                            |
| LONG VARCHAR              | constant ( $l < 255$ )                                | CHAR( $l$ )                |
|                           |   |                            |
| LONG VARCHAR              | constant ( $254 < l < 4001$ )                         | VARCHAR( $l$ )             |
| LONG VARCHAR              | constant ( $l > 4000$ )                               | LONG VARCHAR               |
| LONG VARCHAR              | not a constant or not specified                       | LONG VARCHAR               |
|                           |   |                            |
| CLOB(A)                   | constant ( $l$ )                                      | CLOB( $l$ )                |
| CLOB(A)                   | not a constant or not specified                       | CLOB(A)                    |
|                           |   |                            |
| GRAPHIC(A)                | constant ( $l < 128$ )                                | GRAPHIC( $l$ )             |
| GRAPHIC(A)                | not specified but <i>start</i> argument is a constant | GRAPHIC( $A - start + 1$ ) |
| GRAPHIC(A)                | not a constant  | VARGRAPHIC(A)              |
|                           |   |                            |
| VARGRAPHIC(A)             | constant ( $l < 128$ )                                | GRAPHIC( $l$ )             |
| VARGRAPHIC(A)             | constant ( $127 < l < 16337$ )                        | VARGRAPHIC( $l$ )          |
| VARGRAPHIC(A)             | not a constant  | VARGRAPHIC(A)              |
|                           |   |                            |
| LONG VARGRAPHIC           | constant ( $l < 128$ )                                | GRAPHIC( $l$ )             |
| LONG VARGRAPHIC           | constant ( $127 < l < 2001$ )                         | VARGRAPHIC( $l$ )          |
| LONG VARGRAPHIC           | constant ( $l > 2000$ )                               | LONG VARGRAPHIC            |
| LONG VARGRAPHIC           | not a constant or not specified                       | LONG VARGRAPHIC            |
|                           |   |                            |
| DBCLOB(A)                 | constant ( $l$ )                                      | DBCLOB( $l$ )              |
| DBCLOB(A)                 | not a constant or not specified                       | DBCLOB(A)                  |
|                           |   |                            |
| BLOB(A)                   | constant ( $l$ )                                      | BLOB( $l$ )                |
| BLOB(A)                   | not a constant or not specified                       | BLOB(A)                    |
|                           |   |                            |

If *string* is a fixed-length string, omission of *length* is an implicit specification of  $\text{LENGTH}(\text{string}) - \text{start} + 1$ . If *string* is a varying-length string, omission of *length* is an implicit specification of zero or  $\text{LENGTH}(\text{string}) - \text{start} + 1$ , whichever is greater.

Examples:

- Assume the host variable NAME (VARCHAR(50)) has a value of 'BLUE JAY' and the host variable SURNAME\_POS (int) has a value of 6.

```
SUBSTR(:NAME, :SURNAME_POS)
```

Returns the value 'JAY'

```
SUBSTR(:NAME, :SURNAME_POS,1)
```

Returns the value 'J'.

- Select all rows from the PROJECT table for which the project name (PROJNAME) starts with the word 'OPERATION'.

```
SELECT * FROM PROJECT
WHERE SUBSTR(PROJNAME,1,10) = 'OPERATION '
```

The space at the end of the constant is necessary to preclude initial words such as 'OPERATIONS'.

**Notes:**

1. In dynamic SQL, *string*, *start*, and *length* may be represented by a parameter marker (?). If a parameter marker is used for *string*, the data type of the operand will be VARCHAR, and the operand will be nullable.
2. Though not explicitly stated in the result definitions above, it follows from these semantics that if *string* is a mixed single- and multi-byte character string, the result may contain fragments of multi-byte characters, depending upon the values of *start* and *length*. That is, the result could possibly begin with the second byte of a double-byte character, and/or end with the first byte of a double-byte character. The SUBSTR function does not detect such fragments, nor provides any special processing should they occur.

**Related reference:**

- "Character strings" on page 81

## SUBSTRING

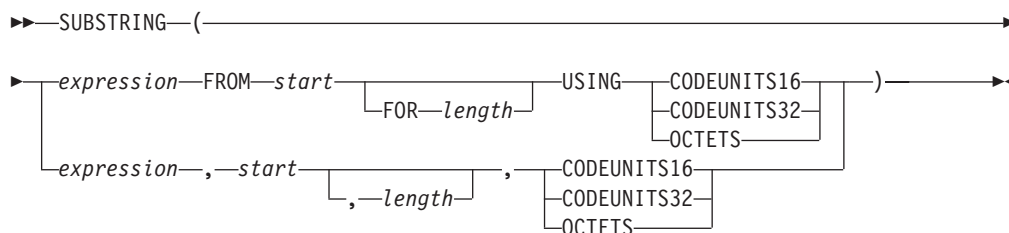

The schema is SYSIBM.

The SUBSTRING function returns a substring of a string.

*expression*

An expression that returns a value of any built-in string data type. If *expression* is a character string, the result is a character string. If *expression* is a graphic string, the result is a graphic string. If *expression* is a binary string, the result is a binary string.

A substring of *expression* is zero or more contiguous string units of *expression*.

*start*

An expression that specifies the position within *expression* that is to be the first string unit of the result; *start*, which is expressed in the specified string unit, must return an integer. The value of *start* can be positive, negative, or zero; a value of 1 indicates that the first string unit of the result is the first string unit of *expression*. If OCTETS is specified and *expression* is graphic data, *start* must be odd; otherwise, an error is returned (SQLSTATE 428GC).

*length*

An expression that specifies the length of the desired substring.

If *expression* is a fixed-length string, omission of *length* is an implicit specification of  $\text{CHARACTER\_LENGTH}(\text{expression USING string-unit}) - \text{start} + 1$ , which is the number of *string units* (CODEUNITS16, CODEUNITS32, or OCTETS) from *start* to the last position of *expression*. If *expression* is a varying-length string, omission of *length* is an implicit specification of zero or  $\text{CHARACTER\_LENGTH}(\text{expression USING string-unit}) - \text{start} + 1$ , whichever is greater. If the desired length is zero, the result is the empty string.

If specified, *length* must be an expression that returns a value that is a built-in integer data type. The value must be greater than or equal to zero and less than or equal to  $n$ , where  $n$  is the  $(\text{length attribute of expression}) - \text{start} + 1$ ; *length* is expressed in the units that are explicitly specified. If OCTETS is specified, and *expression* is graphic data, *length* must be an even number (SQLSTATE 428GC).

**CODEUNITS16, CODEUNITS32, or OCTETS**

Specifies the string unit of *start* and *length*. CODEUNITS16 specifies that *start* and *length* are to be expressed in 16-bit UTF-16 code units. CODEUNITS32 specifies that *start* and *length* are to be expressed in 32-bit UTF-32 code units. OCTETS specifies that *start* and *length* are to be expressed in bytes.

If a string unit is specified as CODEUNITS16 or CODEUNITS32, and *expression* is a binary string or bit data, an error is returned (SQLSTATE 428GC). If a string unit is specified as OCTETS and *expression* is a binary string, an error is returned (SQLSTATE 42815).

For more information about CODEUNITS16, CODEUNITS32, and OCTETS, see “String units in built-in functions” in “Character strings”.

When the SUBSTRING function is invoked using OCTETS, and the *source-string* is encoded in a code page that requires more than one byte per code point (mixed or MBCS), the SUBSTRING operation might split a multi-byte code point and the resulting substring might begin or end with a partial code point. If this occurs, the function replaces the bytes of leading or trailing partial code points with blanks in a way that does not change the byte length of the result. (See a related example below.)

The length attribute of the result is equal to the length attribute of *expression*. If any argument of the function can be null, the result can be null; if any argument is null, the result is the null value. The result is not padded with any character. If *expression* has actual length 0, the result also has actual length 0.

Notes:

- The length attribute of the result is equal to the length attribute of the input string expression. This behavior is different from the behavior of the SUBSTR function, where the length attribute is derived from the *start* and the *length* arguments of the function.

Examples:

- Select all rows from the PROJECT table for which the project name (PROJNAME) starts with the word 'OPERATION '. The space at the end of the constant is necessary to preclude initial words such as 'OPERATIONS'.

```
SELECT * FROM PROJECT
WHERE SUBSTRING(PROJNAME, 1, 10) = 'OPERATION '
```

- FIRSTNAME is a VARCHAR(12) column in table T1. One of its values is the 6-character string 'Jürgen'. When FIRSTNAME has this value:

| Function ...                         | Returns ...                          |
|--------------------------------------|--------------------------------------|
| SUBSTRING(FIRSTNAME,1,2,CODEUNITS32) | 'Jü' -- x'4AC3BC'                    |
| SUBSTRING(FIRSTNAME,1,2,CODEUNITS16) | 'Jü' -- x'4AC3BC'                    |
| SUBSTRING(FIRSTNAME,1,2,OCTETS)      | 'J ' -- x'4A20' (a truncated string) |
| SUBSTRING(FIRSTNAME,8,CODEUNITS16)   | a zero-length string                 |
| SUBSTRING(FIRSTNAME,8,4,OCTETS)      | a zero-length string                 |

- C1 is a VARCHAR(12) column in table T1. One of its values is the string 'ABCDEFGH'. When C1 has this value:

| Function ...              | Returns ...          |
|---------------------------|----------------------|
| SUBSTRING(C1,-2,2,OCTETS) | a zero-length string |
| SUBSTRING(C1,-2,4,OCTETS) | 'A'                  |
| SUBSTRING(C1,-2,OCTETS)   | 'ABCDEFGH'           |
| SUBSTRING(C1,0,1,OCTETS)  | a zero-length string |

- The following example illustrates how SUBSTRING replaces the bytes of leading or trailing partial multi-byte code points with blanks when the string length unit is OCTETS. Assume that UTF8\_VAR contains the UTF-8 representation of the Unicode string '&N~AB', where '&' is the musical symbol G clef and '~' is the combining tilde character.

```
SUBSTRING(UTF8_VAR, 2, 5, OCTETS)
```

Three blank bytes precede the 'N', and one blank byte follows the 'N'.

**Related reference:**

- “CHARACTER\_LENGTH ” on page 295

## SUBSTRING

- "OCTET\_LENGTH " on page 375
- "POSITION " on page 376
- "SUBSTR " on page 411

---

**TABLE\_NAME**

►►—TABLE\_NAME—(—*objectname*—  
└,—*objectschema*—┘)—►►

The schema is SYSIBM.

The TABLE\_NAME function returns an unqualified name of the object found after any alias chains have been resolved. The specified *objectname* (and *objectschema*) are used as the starting point of the resolution. If the starting point does not refer to an alias, the unqualified name of the starting point is returned. The resulting name may be of a table, view, or undefined object. In a Unicode database, if a supplied argument is a graphic string, it is first converted to a character string before the function is executed.

*objectname*

A character expression representing the unqualified name (usually of an existing alias) to be resolved. *objectname* must have a data type of CHAR or VARCHAR and a length greater than 0 and less than 129 bytes.

*objectschema*

A character expression representing the schema used to qualify the supplied *objectname* value before resolution. *objectschema* must have a data type of CHAR or VARCHAR and a length greater than 0 and less than 129 bytes.

If *objectschema* is not supplied, the default schema is used for the qualifier.

The data type of the result of the function is VARCHAR(128). If *objectname* can be null, the result can be null; if *objectname* is null, the result is the null value. If *objectschema* is the null value, the default schema name is used. The result is the character string representing an unqualified name. The result name could represent one of the following:

**table** The value for *objectname* was either a table name (the input value is returned) or an alias name that resolved to the table whose name is returned.

**view** The value for *objectname* was either a view name (the input value is returned) or an alias name that resolved to the view whose name is returned.

**undefined object**

The value for *objectname* was either an undefined object (the input value is returned) or an alias name that resolved to the undefined object whose name is returned.

Therefore, if a non-null value is given to this function, a value is always returned, even if no object with the result name exists.

---

**TABLE\_SCHEMA**

►►—TABLE\_SCHEMA—(—*objectname*—  
└,—*objectschema*—┘)—►►

The schema is SYSIBM.

The TABLE\_SCHEMA function returns the schema name of the object found after any alias chains have been resolved. The specified *objectname* (and *objectschema*) are used as the starting point of the resolution. If the starting point does not refer to an alias, the schema name of the starting point is returned. The resulting schema name may be of a table, view, or undefined object. In a Unicode database, if a supplied argument is a graphic string, it is first converted to a character string before the function is executed.

*objectname*

A character expression representing the unqualified name (usually of an existing alias) to be resolved. *objectname* must have a data type of CHAR or VARCHAR and a length greater than 0 and less than 129 bytes.

*objectschema*

A character expression representing the schema used to qualify the supplied *objectname* value before resolution. *objectschema* must have a data type of CHAR or VARCHAR and a length greater than 0 and less than 129 bytes.

If *objectschema* is not supplied, the default schema is used for the qualifier.

The data type of the result of the function is VARCHAR(128). If *objectname* can be null, the result can be null; if *objectname* is null, the result is the null value. If *objectschema* is the null value, the default schema name is used. The result is the character string representing a schema name. The result schema could represent the schema name for one of the following:

**table** The value for *objectname* was either a table name (the input or default value of *objectschema* is returned) or an alias name that resolved to a table for which the schema name is returned.

**view** The value for *objectname* was either a view name (the input or default value of *objectschema* is returned) or an alias name that resolved to a view for which the schema name is returned.

**undefined object**

The value for *objectname* was either an undefined object (the input or default value of *objectschema* is returned) or an alias name that resolved to an undefined object for which the schema name is returned.

Therefore, if a non-null *objectname* value is given to this function, a value is always returned, even if the object name with the result schema name does not exist. For example, TABLE\_SCHEMA('DEPT', 'PEOPLE') returns 'PEOPLE' if the catalog entry is not found.

Examples:

- PBIRD tries to select the statistics for a given table from SYSCAT.TABLES using an alias PBIRD.A1 defined on the table HEDGES.T1.

```
SELECT NPAGES, CARD FROM SYSCAT.TABLES
WHERE TABNAME = TABLE_NAME ('A1')
AND TABSCHEMA = TABLE_SCHEMA ('A1')
```



The requested statistics for HEDGES.T1 are retrieved from the catalog.

- Select the statistics for an object called HEDGES.X1 from SYSCAT.TABLES using HEDGES.X1. Use TABLE\_NAME and TABLE\_SCHEMA since it is not known whether HEDGES.X1 is an alias or a table.

```
SELECT NPAGES, CARD FROM SYSCAT.TABLES
WHERE TABNAME = TABLE_NAME ('X1','HEDGES')
AND TABSCHEMA = TABLE_SCHEMA ('X1','HEDGES')
```

Assuming that HEDGES.X1 is a table, the requested statistics for HEDGES.X1 are retrieved from the catalog.

- Select the statistics for a given table from SYSCAT.TABLES using an alias PBIRD.A2 defined on HEDGES.T2 where HEDGES.T2 does not exist.

```
SELECT NPAGES, CARD FROM SYSCAT.TABLES
WHERE TABNAME = TABLE_NAME ('A2','PBIRD')
AND TABSCHEMA = TABLE_SCHEMA ('A2','PBIRD')
```

The statement returns 0 records as no matching entry is found in SYSCAT.TABLES where TABNAME = 'T2' and TABSCHEMA = 'HEDGES'.

- Select the qualified name of each entry in SYSCAT.TABLES along with the final referenced name for any alias entry.

```
SELECT TABSCHEMA AS SCHEMA, TABNAME AS NAME,
TABLE_SCHEMA (BASE_TABNAME, BASE_TABSCHEMA) AS REAL_SCHEMA,
TABLE_NAME (BASE_TABNAME, BASE_TABSCHEMA) AS REAL_NAME
FROM SYSCAT.TABLES
```

The statement returns the qualified name for each object in the catalog and the final referenced name (after alias has been resolved) for any alias entries. For all non-alias entries, BASE\_TABNAME and BASE\_TABSCHEMA are null so the REAL\_SCHEMA and REAL\_NAME columns will contain nulls.

---

**TAN**

►►—TAN—(*expression*)—◄◄

The schema is SYSIBM. (The SYSFUN version of the TAN function continues to be available.)

Returns the tangent of the argument, where the argument is an angle expressed in radians.

The argument can be any built-in numeric data type. It is converted to a double-precision floating-point number for processing by the function.

The result of the function is a double-precision floating-point number. The result can be null if the argument can be null or the database is configured with DFT\_SQLMATHWARN set to YES; the result is the null value if the argument is null.

---

## TANH

►►TANH(*expression*)◄◄

The schema is SYSIBM.

Returns the hyperbolic tangent of the argument, where the argument is an angle expressed in radians.

The argument can be of any built-in numeric data type. It is converted to a double-precision floating-point number for processing by the function.

The result of the function is a double-precision floating-point number. The result can be null if the argument can be null or the database is configured with DFT\_SQLMATHWARN set to YES; the result is the null value if the argument is null.

---

**TIME**

►►—TIME—(—*expression*—)—————►►

The schema is SYSIBM.

The TIME function returns a time from a value.

The argument must be a time, timestamp, or a valid string representation of a time or timestamp that is not a CLOB, LONG VARCHAR, DBCLOB, or LONG VARGRAPHIC.

Only Unicode databases support an argument that is a graphic string representation of a time or a timestamp. In a Unicode database, if a supplied argument is a graphic string, it is first converted to a character string before the function is executed.

The result of the function is a time. If the argument can be null, the result can be null; if the argument is null, the result is the null value.

The other rules depend on the data type of the argument:

- If the argument is a time:
  - The result is that time.
- If the argument is a timestamp:
  - The result is the time part of the timestamp.
- If the argument is a string:
  - The result is the time represented by the string.

Example:

- Select all notes from the IN\_TRAY sample table that were received at least one hour later in the day (any day) than the current time.

```
SELECT * FROM IN_TRAY
WHERE TIME(RECEIVED) >= CURRENT TIME + 1 HOUR
```

---

**TIMESTAMP**

►►—TIMESTAMP—(—*expression*—  
,*expression*—)◀◀

The schema is SYSIBM.

The **TIMESTAMP** function returns a timestamp from a value or a pair of values.

Only Unicode databases support an argument that is a graphic string representation of a date, a time, or a timestamp. In a Unicode database, if a supplied argument is a graphic string, it is first converted to a character string before the function is executed.

The rules for the arguments depend on whether the second argument is specified.

- If only one argument is specified:
  - It must be a timestamp, a valid string representation of a timestamp, or a string of length 14 that is not a CLOB, LONG VARCHAR, DBCLOB, or LONG VARGRAPHIC.
 

A string of length 14 must be a string of digits that represents a valid date and time in the form *yyyyxxddhhmmss*, where *yyyy* is the year, *xx* is the month, *dd* is the day, *hh* is the hour, *mm* is the minute, and *ss* is the seconds.
- If both arguments are specified:
  - The first argument must be a date or a valid string representation of a date and the second argument must be a time or a valid string representation of a time.

The result of the function is a timestamp. If either argument can be null, the result can be null; if either argument is null, the result is the null value.

The other rules depend on whether the second argument is specified:

- If both arguments are specified:
  - The result is a timestamp with the date specified by the first argument and the time specified by the second argument. The microsecond part of the timestamp is zero.
- If only one argument is specified and it is a timestamp:
  - The result is that timestamp.
- If only one argument is specified and it is a string:
  - The result is the timestamp represented by that string. If the argument is a string of length 14, the timestamp has a microsecond part of zero.

Example:

- Assume the column **START\_DATE** (date) has a value equivalent to 1988-12-25, and the column **START\_TIME** (time) has a value equivalent to 17.12.30.

**TIMESTAMP**(START\_DATE, START\_TIME)

Returns the value '1988-12-25-17.12.30.000000'.

---

**TIMESTAMP\_FORMAT**

►►—TIMESTAMP\_FORMAT—(—*string-expression*—, *format-string*—)—————►►

The schema is SYSIBM.

The TIMESTAMP\_FORMAT function returns a timestamp from a character string that has been interpreted using a character template. In a Unicode database, if a supplied argument is a graphic string, it is first converted to a character string before the function is executed.

*string-expression*

A character expression representing a timestamp value in the format specified by *format-string*. (If *string-expression* is an untyped parameter marker, the type is assumed to be VARCHAR with a maximum length of 254.) The string expression returns a CHAR or a VARCHAR value whose maximum length is not greater than 254 (SQLSTATE 42815). Leading and trailing blanks are removed from *string-expression*, and the resulting substring is interpreted as a timestamp using the format specified by *format-string*. Leading zeros can be omitted from any timestamp components except the year. Blanks can be used in place of leading zeros for these components. For example, with a format string of 'YYYY-MM-DD HH24:MI:SS', each of the following strings is an acceptable specification for 9 a.m. on January 1, 2000:

|                       |  |
|-----------------------|--|
| '2000-1-01 09:00:00'  | (single digit for month)   |
| '2000- 1-01 09:00:00' | (single digit - preceded by a blank -<br>for month)                            |
| '2000-1-1 09:00:00'   | (single digits for month and day)  |
| '2000-01-01 9:00:00'  | (single digit for hour)  |
| '2000-01-01 09:0:0'   | (single digits for minutes and seconds)  |
| '2000- 1- 1 09: 0: 0' | (single digit - preceded by a blank -<br>for month, day, minutes, and seconds) |
| '2000-01-01 09:00:00' | (maximum number of digits for each element)                                    |

*format-string*

A character constant that contains a template for how the string expression is to be interpreted as a timestamp value. The length of the format string must not be greater than 254 (SQLSTATE 42815). Leading and trailing blanks are removed from *format-string*, and the resulting substring must be a valid template for a timestamp value (SQLSTATE 42815). The content of *format-string* can be specified in mixed case.

Valid format strings are:

'YYYY-MM-DD HH24:MI:SS'

where *YYYY* represents a 4-digit year value; *MM* represents a 2-digit month value (01-12; January=01); *DD* represents a 2-digit day of the month value (01-31); *HH24* represents a 2-digit hour of the day value (00-24; If the hour is 24, the minutes and seconds values are zero.); *MI* represents a 2-digit minute value (00-59); and *SS* represents a 2-digit seconds value (00-59).

The result of the function is a timestamp. If the first argument can be null, the result can be null; if the first argument is null, the result is the null value.

Example:

- Insert a row into the in\_tray table with a receiving timestamp that is equal to one second before the beginning of the year 2000 (December 31, 1999 at 23:59:59).

```
INSERT INTO in_tray (received)
VALUES (TIMESTAMP_FORMAT('1999-12-31 23:59:59',
'YYYY-MM-DD HH24:MI:SS'))
```

---

### TIMESTAMP\_ISO

►►—TIMESTAMP\_ISO—(*—expression—*)—◄◄

The schema is SYSFUN.

Returns a timestamp value based on a date, time, or timestamp argument. If the argument is a date, it inserts zero for all the time elements. If the argument is a time, it inserts the value of the CURRENT DATE special register for the date elements, and zero for the fractional time element.

The argument must be a date, time, or timestamp, or a valid character string representation of a date, time or timestamp that is neither a CLOB nor a LONG VARCHAR. In a Unicode database, if a supplied argument is a graphic string, it is first converted to a character string before the function is executed.

The result of the function is TIMESTAMP. The result can be null; if the argument is null, the result is the null value.



---

## TIMESTAMPDIFF

►►—TIMESTAMPDIFF—(—*expression*—,—*expression*—)—————►►

The schema is SYSFUN.

Returns an estimated number of intervals of the type defined by the first argument, based on the difference between two timestamps.

The first argument can be either INTEGER or SMALLINT. Valid values of interval (the first argument) are:

|     |                       |
|-----|-----------------------|
| 1   | Fractions of a second |
| 2   | Seconds               |
| 4   | Minutes               |
| 8   | Hours                 |
| 16  | Days                  |
| 32  | Weeks                 |
| 64  | Months                |
| 128 | Quarters              |
| 256 | Years                 |

The second argument is the result of subtracting two timestamps and converting the result to CHAR(22). In a Unicode database, if a supplied argument is a graphic string, it is first converted to a character string before the function is executed.

The result of the function is INTEGER. The result can be null; if the argument is null, the result is the null value.

The following assumptions may be used in estimating a difference:

- There are 365 days in a year.
- There are 30 days in a month.
- There are 24 hours in a day.
- There are 60 minutes in an hour.
- There are 60 seconds in a minute.

These assumptions are used when converting the information in the second argument, which is a timestamp duration, to the interval type specified in the first argument. The returned estimate may vary by a number of days. For example, if the number of days (interval 16) is requested for the difference between '1997-03-01-00.00.00' and '1997-02-01-00.00.00', the result is 30. This is because the difference between the timestamps is 1 month, and the assumption of 30 days in a month applies.

Example:

The following example returns 4277, the number of minutes between two timestamps:

## TIMESTAMPDIFF

```
TIMESTAMPDIFF(4,CHAR(TIMESTAMP('2001-09-29-11.25.42.483219') -  
TIMESTAMP('2001-09-26-12.07.58.065497')))
```

---

## TO\_CHAR

►►—TO\_CHAR—(*timestamp-expression*—, *format-string*—)—————►◄

The schema is SYSIBM.

The TO\_CHAR function returns a character representation of a timestamp that has been formatted using a character template.

TO\_CHAR is a synonym for VARCHAR\_FORMAT.

**Related reference:**

- “VARCHAR\_FORMAT ” on page 443

---

## TO\_DATE

►►—TO\_DATE—(—*string-expression*—,—*format-string*—)—————►◄

The schema is SYSIBM.

The TO\_DATE function returns a timestamp from a character string that has been interpreted using a character template.

TO\_DATE is a synonym for TIMESTAMP\_FORMAT.

**Related reference:**

- “TIMESTAMP\_FORMAT ” on page 424

## TRANSLATE

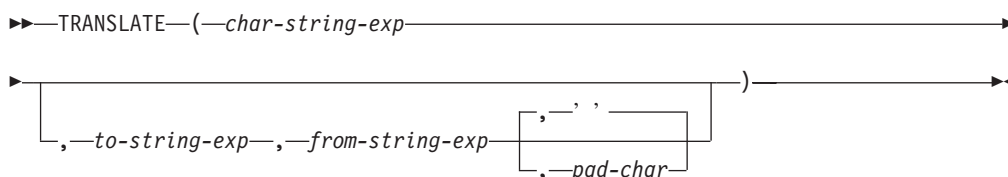
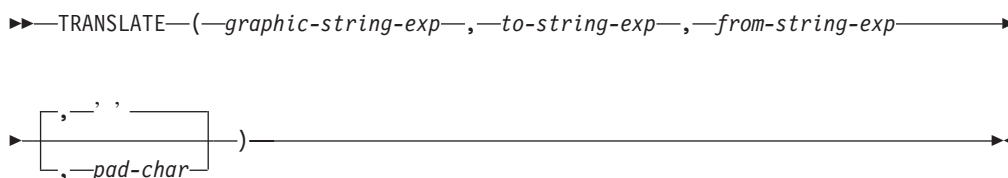
**character string expression:****graphic string expression:**

The schema is SYSIBM.

The TRANSLATE function returns a value in which one or more characters in a string expression might have been converted to other characters.

The function converts all the characters in *char-string-exp* or *graphic-string-exp* that also occur in *from-string-exp* to the corresponding characters in *to-string-exp* or, if no corresponding characters exist, to the pad character specified by *pad-char-exp*.

The result of the function has the same data type and code page as the first argument. If the first argument is a host variable, the code page of the result is the database code page. The length attribute of the result is the same as that of the first argument. If any specified expression can be NULL, the result can be NULL. If any specified expression is NULL, the result will be NULL.

*char-string-exp* or *graphic-string-exp*

Specifies a string that is to be converted.

*to-string-exp*

Specifies a string of characters to which certain characters in *char-string-exp* will be converted.

If a value for *to-string-exp* is not specified, and the data type is not graphic, all characters in *char-string-exp* will be in monospace; that is, the characters a-z will be converted to the characters A-Z, and other characters will be converted to their uppercase equivalents, if they exist. For example, in code page 850, é maps to É, but ÿ is not mapped, because code page 850 does not include Ÿ. If the code point length of the result character is not the same as the code point length of the source character, the source character is not converted.

*from-string-exp*

Specifies a string of characters which, if found in *char-string-exp*, will be converted to the corresponding character in *to-string-exp*. If *from-string-exp* contains duplicate characters, the first one found will be used, and the

## TRANSLATE

duplicates will be ignored. If *to-string-exp* is longer than *from-string-exp*, the surplus characters will be ignored. If *to-string-exp* is specified, *from-string-exp* must also be specified.

### *pad-char-exp*

Specifies a single character that will be used to pad *to-string-exp* if *to-string-exp* is shorter than *from-string-exp*. The *pad-char-exp* argument must have a length attribute of one. If a value is not specified, a single-byte blank character is assumed.

The arguments can be either character strings of data type CHAR or VARCHAR, or graphic strings of data type GRAPHIC or VARGRAPHIC. They cannot be of data type LONG VARCHAR, LONG VARGRAPHIC, BLOB, CLOB, or DBCLOB.

With *graphic-string-exp*, only *pad-char-exp* is optional (if a value is not specified, the double-byte blank character is assumed), and each argument, including the pad character, must be of a graphic data type.

The code page of the result is the same as the code page of the first operand. As of Version 8, if the first operand is a host variable, the code page of the result is the database code page. Each of the other operands is converted to the result code page unless it or the first operand is defined as FOR BIT DATA (in which case there is no conversion).

If the arguments are of data type CHAR or VARCHAR, the corresponding characters in *to-string-exp* and *from-string-exp* must have the same number of bytes. For example, it is not valid to convert a single-byte character to a multi-byte character, or to convert a multi-byte character to a single-byte character. The *pad-char-exp* argument cannot be the first byte of a valid multi-byte character (SQLSTATE 42815).

If only *char-string-exp* is specified, single-byte characters will be moncased, and multi-byte characters will remain unchanged.

Examples:

- Assume that the host variable SITE (VARCHAR(30)) has a value of 'Hanauma Bay'.

```
TRANSLATE(:SITE)
```

Returns the value 'HANAUMA BAY'.

```
TRANSLATE(:SITE 'j', 'B')
```

Returns the value 'Hanauma jay'.

```
TRANSLATE(:SITE, 'ei', 'aa')
```

Returns the value 'Heneume Bey'.

```
TRANSLATE(:SITE, 'bA', 'Bay', '%')
```

Returns the value 'HAnAumA bA%'.

```
TRANSLATE(:SITE, 'r', 'Bu')
```

Returns the value 'Hana ma ray'.

## TRIM

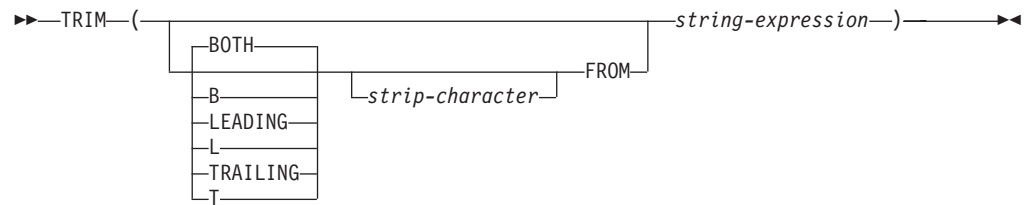

The schema is SYSIBM. The function name cannot be specified as a qualified name when keywords are used in the function signature.

The TRIM function removes blanks or occurrences of another specified character from the end or the beginning of a string expression.

#### **BOTH, LEADING, or TRAILING**

Specifies whether characters are removed from the beginning, the end, or from both ends of the string expression. If this argument is not specified, the characters are removed from both the end and the beginning of the string.

#### *strip-character*

A single-character constant that specifies the character that is to be removed. If *strip-character* is not specified and:

- If the *string-expression* is a DBCS graphic string, the default *strip-character* is a DBCS blank, whose code point is dependent on the database code page
- If the *string-expression* is a UCS-2 graphic string, the default *strip-character* is a UCS-2 blank (X'0020')
- Otherwise, the default *strip-character* is an SBCS blank (X'20')

#### **FROM** *string-expression*

An expression that returns a value that is a CHAR, VARCHAR, GRAPHIC, or VARGRAPHIC data type.

The result is a varying-length string with the same maximum length as the length attribute of the *string-expression*. The actual length of the result is the length of the *string-expression* minus the number of bytes that are removed. If all of the characters are removed, the result is an empty varying-length string. The code page of the result is the same as the code page of the *string-expression*.

#### Examples:

- Assume that the host variable HELLO of type CHAR(9) has a value of ' Hello'.

```

SELECT TRIM(:HELLO),
       TRIM(TRAILING FROM :HELLO)
FROM SYSIBM.SYSDUMMY1

```

returns the values 'Hello' and ' Hello', respectively.

- Assume that the host variable BALANCE of type CHAR(9) has a value of '000345.50'.

```

SELECT TRIM(L '0' FROM :BALANCE),
       FROM SYSIBM.SYSDUMMY1

```

returns the value '345.50'.

#### Related reference:

## TRIM

- “STRIP ” on page 410



---

## TRUNCATE or TRUNC

The schema is SYSIBM. (The SYSFUN version of the TRUNCATE or TRUNC function continues to be available.)

Returns *expression1* truncated to *expression2* places to the right of the decimal point if *expression2* is positive, or to the left of the decimal point if *expression2* is zero or negative.

*expression1*

An expression that returns a value of any built-in numeric data type.

*expression2*

An expression that returns a small or a large integer. The absolute value of the integer specifies the number of places to the right of the decimal point for the result if *expression2* is not negative, or to left of the decimal point if *expression2* is negative.

If the absolute value of *expression2* is larger than the number of digits to the left of the decimal point, the result is 0. For example:

```
TRUNCATE(748.58,-4) = 0
```

The data type and length attribute of the result are the same as the data type and length attribute of the first argument.

The result can be null if the argument can be null or the database is configured with DFT\_SQLMATHWARN set to YES; the result is the null value if the argument is null.

Examples:

- Using the EMPLOYEE table, calculate the average monthly salary for the highest paid employee. Truncate the result two places to the right of the decimal point.

```
SELECT TRUNCATE(MAX(SALARY)/12,2)
FROM EMPLOYEE;
```

Because the highest paid employee earns \$52750.00 per year, the example returns 4395.83.

- Display the number 873.726 truncated 2, 1, 0, -1, and -2 decimal places, respectively.

```
VALUES (
  TRUNC(873.726,2),
  TRUNC(873.726,1),
  TRUNC(873.726,0),
  TRUNC(873.726,-1),
  TRUNC(873.726,-2),
  TRUNC(873.726,-3) );
```

This example returns 873.720, 873.700, 873.000, 870.000, 800.000, and 0.000.

---

**TYPE\_ID**

►►—TYPE\_ID—(—*expression*—)—————►►

The schema is SYSIBM.

The TYPE\_ID function returns the internal type identifier of the dynamic data type of the *expression*.

The argument must be a user-defined structured type. (This function cannot be used as a source function when creating a user-defined function. Because it accepts any structured data type as an argument, it is not necessary to create additional signatures to support different user-defined types.)

The data type of the result of the function is INTEGER. If *expression* can be null, the result can be null; if *expression* is null, the result is the null value.

The value returned by the TYPE\_ID function is not portable across databases. The value may be different, even though the type schema and type name of the dynamic data type are the same. When coding for portability, use the TYPE\_SCHEMA and TYPE\_NAME functions to determine the type schema and type name.

Examples:

- A table hierarchy exists having root table EMPLOYEE of type EMP and subtable MANAGER of type MGR. Another table ACTIVITIES includes a column called WHO\_RESPONSIBLE that is defined as REF(EMP) SCOPE EMPLOYEE. For each reference in ACTIVITIES, display the internal type identifier of the row that corresponds to the reference.

```
SELECT TASK, WHO_RESPONSIBLE->NAME,  
       TYPE_ID(DEREF(WHO_RESPONSIBLE))  
FROM ACTIVITIES
```

The DEREF function is used to return the object corresponding to the row.

---

## TYPE\_NAME

►►—TYPE\_NAME—(—*expression*—)—————►◄

The schema is SYSIBM.

The TYPE\_NAME function returns the unqualified name of the dynamic data type of the *expression*.

The argument must be a user-defined structured type. (This function cannot be used as a source function when creating a user-defined function. Because it accepts any structured data type as an argument, it is not necessary to create additional signatures to support different user-defined types.)

The data type of the result of the function is VARCHAR(18). If *expression* can be null, the result can be null; if *expression* is null, the result is the null value. Use the TYPE\_SCHEMA function to determine the schema name of the type name returned by TYPE\_NAME.

Examples:

- A table hierarchy exists having root table EMPLOYEE of type EMP and subtable MANAGER of type MGR. Another table ACTIVITIES includes a column called WHO\_RESPONSIBLE that is defined as REF(EMP) SCOPE EMPLOYEE. For each reference in ACTIVITIES, display the type of the row that corresponds to the reference.

```
SELECT TASK, WHO_RESPONSIBLE->NAME,
       TYPE_NAME(DEREF(WHO_RESPONSIBLE)),
       TYPE_SCHEMA(DEREF(WHO_RESPONSIBLE))
FROM ACTIVITIES
```

The DEREf function is used to return the object corresponding to the row.

---

## TYPE\_SCHEMA

►►—TYPE\_SCHEMA—(—*expression*—)—————►◄

The schema is SYSIBM.

The TYPE\_SCHEMA function returns the schema name of the dynamic data type of the *expression*.

The argument must be a user-defined structured type. This function cannot be used as a source function when creating a user-defined function. Because it accepts any structured data type as an argument, it is not necessary to create additional signatures to support different user-defined types.

The data type of the result of the function is VARCHAR(128). If *expression* can be null, the result can be null; if *expression* is null, the result is the null value. Use the TYPE\_NAME function to determine the type name associated with the schema name returned by TYPE\_SCHEMA.

**Related reference:**

- “TYPE\_NAME ” on page 437

---

## UCASE or UPPER

►► UCASE (—*expression*—) ►►  
    └───┬───┘  
    UPPER

The schema is SYSIBM. (The SYSFUN version of this function continues to be available for upward compatibility. See Version 5 documentation for a description.)

The UCASE or UPPER function is identical to the TRANSLATE function except that only the first argument (*char-string-exp*) is specified.

In a Unicode database, if a supplied argument is a graphic string, it is first converted to a character string before the function is executed.

**Related reference:**

- “TRANSLATE ” on page 431

## VALUE

---

## VALUE

►►—VALUE—(—*expression*—, *expression*—)—►►

The schema is SYSIBM.

The VALUE function returns the first argument that is not null.

VALUE is a synonym for COALESCE.

**Related reference:**

- “COALESCE ” on page 299

## VARCHAR

### Character to Varchar:

►► VARCHAR ( (*character-expression* [*, integer*] ) )

### Graphic to Varchar:

►► VARCHAR ( (*graphic-expression* [*, integer*] ) )

### Datetime to Varchar:

►► VARCHAR ( (*datetime-expression*) )

The schema is SYSIBM.

The VARCHAR function returns a varying-length character string representation of:

- A character string, if the first argument is any type of character string
- A graphic string (Unicode databases only), if the first argument is any type of graphic string
- A datetime value, if the argument is a date, time, or timestamp

In a Unicode database, when the output string is truncated part-way through a multiple-byte character:

- If the input was a character string, the partial character is replaced with one or more blanks
- If the input was a graphic string, the partial character is replaced by the empty string

Do not rely on either of these behaviors, because they might change in a future release.

The result of the function is a varying-length character string. If the first argument can be null, the result can be null. If the first argument is null, the result is the null value.

### Character to Varchar

#### *character-expression*

An expression whose value must be of a character string data type with a maximum length of 32 672 bytes.

#### *integer*

The length attribute of the resulting varying-length character string. The value must be between 0 and 32 672. If this argument is not specified, the length attribute of the result is the same as the length attribute of the argument.

### Graphic to Varchar

## VARCHAR

### *graphic-expression*

An expression whose value must be of a graphic string data type other than LONG VARGRAPHIC or DBCLOB, and whose maximum length is 16 336 double-byte characters.

### *integer*

The length attribute of the resulting varying-length character string. The value must be between 0 and 32 672. If this argument is not specified, the length attribute of the result is the same as the length attribute of the argument.

### **Datetime to Varchar**

#### *datetime-expression*

An expression whose value must be of the DATE, TIME, or TIMESTAMP data type.

Example:

- Set the host variable JOB\_DESC, defined as VARCHAR(8), to the VARCHAR equivalent of the job description (which is the value of the JOB column), defined as CHAR(8), for employee Dolores Quintana.

```
SELECT VARCHAR(JOB)
  INTO :JOB_DESC
  FROM EMPLOYEE
  WHERE LASTNAME = 'QUINTANA'
```

### **Related reference:**

- “CHAR ” on page 291



---

## VARCHAR\_FORMAT

►►—VARCHAR\_FORMAT—(—*timestamp-expression*—,—*format-string*—)—————►►

The schema is SYSIBM.

The VARCHAR\_FORMAT function returns a character representation of a timestamp that has been formatted using a character template. In a Unicode database, if a supplied argument is a graphic string, it is first converted to a character string before the function is executed.

### *timestamp-expression*

An expression that results in a timestamp. The argument must be a timestamp or a string representation of a timestamp that is neither a CLOB nor a LONG VARCHAR. (If *string-expression* is an untyped parameter marker, the type is assumed to be TIMESTAMP.) The string expression returns a CHAR or a VARCHAR value whose maximum length is not greater than 254 (SQLSTATE 42815). Leading and trailing blanks are removed from *string-expression*, and the resulting substring is interpreted as a timestamp using the format specified by *format-string*. Leading zeros can be omitted from any timestamp components except the year. Blanks can be used in place of leading zeros for these components. For example, with a format string of 'YYYY-MM-DD HH24:MI:SS', each of the following strings is an acceptable specification for 9 a.m. on January 1, 2000:

|                       |   |
|-----------------------|---|
| '2000-1-01 09:00:00'  | (single digit for month)  |
| '2000- 1-01 09:00:00' | (single digit - preceded by a blank - for month)                            |
| '2000-1-1 09:00:00'   | (single digits for month and day)   |
| '2000-01-01 9:00:00'  | (single digit for hour)   |
| '2000-01-01 09:0:0'   | (single digits for minutes and seconds)                                     |
| '2000- 1- 1 09: 0: 0' | (single digit - preceded by a blank - for month, day, minutes, and seconds) |
| '2000-01-01 09:00:00' | (maximum number of digits for each element)                                 |

### *format-string*

A character constant that contains a template for how the result is to be formatted. The length of the format string must not be greater than 254 (SQLSTATE 42815). Leading and trailing blanks are removed from *format-string*, and the resulting substring must be a valid template for a timestamp value (SQLSTATE 42815). The content of *format-string* can be specified in mixed case.

Valid format strings are:

'YYYY-MM-DD HH24:MI:SS'

where *YYYY* represents a 4-digit year value; *MM* represents a 2-digit month value (01-12; January=01); *DD* represents a 2-digit day of the month value (01-31); *HH24* represents a 2-digit hour of the day value (00-24; If the hour is 24, the minutes and seconds values are zero.); *MI* represents a 2-digit minute value (00-59); and *SS* represents a 2-digit seconds value (00-59).

The result of the function is a varying-length character string containing a formatted timestamp expression. The format string also determines the length attribute and the actual length of the result. If *format-string* is 'YYYY-MM-DD HH24:MI:SS', the length attribute is 19. The result is 19 characters of the form:

YYYY-MM-DD HH:MI:SS

## VARCHAR\_FORMAT

For example, with format 'YYYY-MM-DD HH24:MI:SS' and a time and date of 10 a.m. on January 1, 2000, the following is returned:

```
'2000-01-01 10:00:00'
```

Even though the values for month and day only require a single digit, in this example, each significant digit is preceded with a leading zero. And, even though the minutes and seconds values are both zero, the maximum number of digits are used for each, and '00' is returned for each of these parts in the result.

If the first argument can be null, the result can be null; if the first argument is null, the result is the null value. The code page of the result is the SBCS code page of the system.

Example:

- Display the table names and creation timestamps for all of the system tables whose name starts with 'SYSU'.

```
SELECT VARCHAR(name, 20) AS TABLE_NAME,  
       VARCHAR_FORMAT(ctime, 'YYYY-MM-DD HH24:MI:SS') AS CREATION_TIME  
FROM SYSCAT.TABLES  
WHERE name LIKE 'SYSU%'
```

This example returns the following:

| TABLE_NAME     | CREATION_TIME       |
|----------------|---------------------|
| -----          | -----               |
| SYSUSERAUTH    | 2000-05-19 08:18:56 |
| SYSUSEROPTIONS | 2000-05-19 08:18:56 |

---

**VARGRAPHIC**
**Graphic to Vargraphic:**

►►—VARGRAPHIC—(*—graphic-expression—* [*—integer—*])—►►

**Character to Vargraphic:**

►►—VARGRAPHIC—(*—character-expression—*)—►►

**Datetime to Vargraphic:**

►►—VARGRAPHIC—(*—datetime-expression—*)—►►

The schema is SYSIBM.

The VARGRAPHIC function returns a varying-length graphic string representation of:

- A graphic string, if the first argument is any type of graphic string
- A character string, converting single-byte characters to double-byte characters, if the first argument is any type of character string
- A datetime value (Unicode databases only), if the argument is a date, time, or timestamp

In a Unicode database, if a supplied argument is a character string, it is first converted to a graphic string before the function is executed. When the output string is truncated, such that the last character is a high surrogate, that surrogate is converted to the blank character (X'0020'). Do not rely on this behavior, because it might change in a future release.

The result of the function is a varying-length graphic string (VARGRAPHIC data type). If the first argument can be null, the result can be null; if the first argument is null, the result is the null value.

**Graphic to Vargraphic**

*graphic-expression*

An expression that returns a value that is a graphic string.

*integer*

An integer value specifying the length attribute of the resulting VARGRAPHIC data type. The value must be between 0 and 16 336. If a value is not specified, the length attribute of the result is the same as the length attribute of the first argument.

If the length of the graphic expression is greater than the length attribute of the result, the result is truncated. A warning is returned (SQLSTATE 01004), unless the truncated characters were all blanks, and the graphic expression was not a long string (LONG VARGRAPHIC or DBCLOB).

**Character to Vargraphic**

## VARGRAPHIC

### *character-expression*

An expression whose value must be of a character string data type other than LONG VARCHAR or CLOB, and whose maximum length is 16 336 bytes.

The length attribute of the result is equal to the length attribute of the argument.

Each single-byte character in *character-expression* is converted to its equivalent double-byte representation or to the double-byte substitution character in the result. Each double-byte character in *character-expression* is mapped without additional conversion. If the first byte of a double-byte character appears as the last byte of *character-expression*, it is converted to the double-byte substitution character. The sequential order of the characters in *character-expression* is preserved.

For a Unicode database, this function converts the character string from the code page of the operand to UCS-2. Every character of the operand, including double-byte characters, is converted. If a value for the second argument is provided, it specifies the required length of the resulting string (in UCS-2 characters).

The conversion to double-byte code points by the VARGRAPHIC function is based on the code page of the operand.

Double-byte characters of the operand are not converted. All other characters are converted to their corresponding double-byte equivalents. If there is no corresponding double-byte equivalent, the double-byte substitution character for the code page is used.

No warning or error code is generated if one or more double-byte substitution characters are returned in the result.

### **Datetime to Vargraphic**

#### *datetime-expression*

An expression whose value must be of the DATE, TIME, or TIMESTAMP data type.

#### **Related reference:**

- “GRAPHIC ” on page 336
- Appendix N, “Japanese and traditional-Chinese extended UNIX code (EUC) considerations,” on page 841

---

**WEEK**

►► `WEEK` (*—expression—*) ◀◀

Returns the week of the year of the argument as an integer value in range 1-54. The week starts with Sunday.

The argument must be a date, timestamp, or a valid character string representation of a date or timestamp that is neither a CLOB nor a LONG VARCHAR. In a Unicode database, if a supplied argument is a graphic string, it is first converted to a character string before the function is executed.

The result of the function is INTEGER. The result can be null; if the argument is null, the result is the null value.

---

**WEEK\_ISO**

►► WEEK\_ISO (—*expression*—) ◀◀

The schema is SYSFUN.

Returns the week of the year of the argument as an integer value in the range 1-53. The week starts with Monday and always includes 7 days. Week 1 is the first week of the year to contain a Thursday, which is equivalent to the first week containing January 4. It is therefore possible to have up to 3 days at the beginning of a year appear in the last week of the previous year. Conversely, up to 3 days at the end of a year may appear in the first week of the next year.

The argument must be a date, timestamp, or a valid character string representation of a date or timestamp that is neither a CLOB nor a LONG VARCHAR. In a Unicode database, if a supplied argument is a graphic string, it is first converted to a character string before the function is executed.

The result of the function is INTEGER. The result can be null; if the argument is null, the result is the null value.

Example:

The following list shows examples of the result of WEEK\_ISO and DAYOFWEEK\_ISO.

| DATE       | WEEK_ISO | DAYOFWEEK_ISO |
|------------|----------|---------------|
| 1997-12-28 | 52       | 7             |
| 1997-12-31 | 1        | 3             |
| 1998-01-01 | 1        | 4             |
| 1999-01-01 | 53       | 5             |
| 1999-01-04 | 1        | 1             |
| 1999-12-31 | 52       | 5             |
| 2000-01-01 | 52       | 6             |
| 2000-01-03 | 1        | 1             |

---

## XMLATTRIBUTES

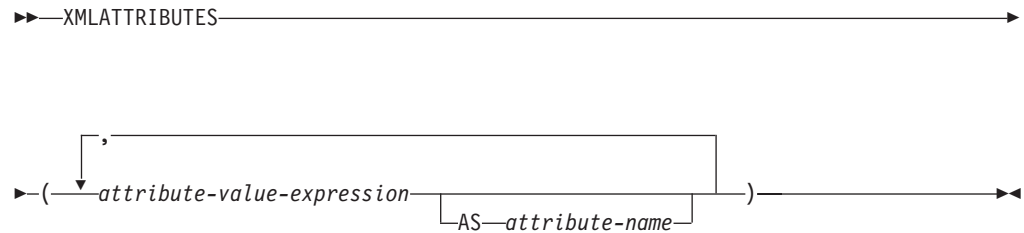

The schema is SYSIBM. The function name cannot be specified as a qualified name.

The XMLATTRIBUTES function constructs XML attributes from the arguments. This function can only be used as an argument of the XMLELEMENT function. The result is an XML sequence containing an XQuery attribute node for each non-null input value.

### *attribute-value-expression*

An expression whose result is the attribute value. The data type of *attribute-value-expression* cannot be a structured type (SQLSTATE 42884). The expression can be any SQL expression. If the expression is not a simple column reference, an attribute name must be specified.

### *attribute-name*

Specifies an attribute name. The name is an SQL identifier that must be in the form of an XML qualified name, or QName (SQLSTATE 42634). See the W3C XML namespace specifications for more details on valid names. The attribute name cannot be `xmlns` or prefixed with `xmlns:`. A namespace is declared using the function XMLNAMESPACES. Duplicate attribute names, whether implicit or explicit, are not allowed (SQLSTATE 42713).

If *attribute-name* is not specified, *attribute-value-expression* must be a column name (SQLSTATE 42703). The attribute name is created from the column name using the fully escaped mapping from a column name to an XML attribute name.

The data type of the result is XML. If the result of *attribute-value-expression* can be null, the result can be null; if the result of every *attribute-value-expression* is null, the result is the null value.

### Notes:

- Support in non-Unicode databases and multiple database partition databases:** The BLOB data type and character string data defined as FOR BIT DATA are not supported (SQLSTATE 42884).

Examples:

**Note:** XMLATTRIBUTES does not insert blank spaces or new line characters in the output. All example output has been formatted to enhance readability.

- Produce an element with attributes.

```

SELECT E.EMPNO, XMLELEMENT(
  NAME "Emp",
  XMLATTRIBUTES(
    E.EMPNO, E.FIRSTNME || ' ' || E.LASTNAME AS "name"
  )
)

```

## XMLATTRIBUTES

```
)  
)  
AS "Result"  
FROM EMPLOYEE E WHERE E.EDLEVEL = 12
```

This query produces the following result:

```
EMPNO Result  
000290 <Emp EMPNO="000290" name="JOHN PARKER"></Emp>  
000310 <Emp EMPNO="000310" name="MAUDE SETRIGHT"></Emp>  
200310 <Emp EMPNO="200310" name="MICHELLE SPRINGER"></Emp>
```

- Produce an element with a namespace declaration that is not used in any QName. The prefix is used in an attribute value.

```
VALUES XMLELEMENT(  
  NAME "size",  
  XMLNAMESPACES(  
    'http://www.w3.org/2001/XMLSchema-instance' AS "xsi",  
    'http://www.w3.org/2001/XMLSchema' AS "xsd"  
  ),  
  XMLATTRIBUTES(  
    'xsd:string' AS "xsi:type"  
  ), '1'  
)  
FROM EMPLOYEE
```

This query produces the following result:

```
<size xmlns:xsi="http://www.w3.org/2001/XMLSchema-instance"  
  xmlns:xsd="http://www.w3.org/2001/XMLSchema"  
  xsi:type="xsd:string">1</size>
```

### Related concepts:

- “Publishing XML values with SQL/XML” in *XML Guide*

### Related reference:

- “XMLCOMMENT ” on page 451
- “XMLCONCAT ” on page 452
- “XMLDOCUMENT ” on page 454
- “XMLELEMENT ” on page 456
- “XMLFOREST ” on page 462
- “XMLNAMESPACES ” on page 466
- “XMLPARSE ” on page 469
- “XMLPI ” on page 471
- “XMLQUERY ” on page 473
- “XMLSERIALIZE ” on page 476
- “XMLTEXT ” on page 479
- “XMLVALIDATE ” on page 481
- “XMLAGG ” on page 271



---

## XMLCOMMENT

►► XMLCOMMENT (—*string-expression*—) ◀◀

The schema is SYSIBM. The function name cannot be specified as a qualified name.

The XMLCOMMENT function returns an XML value with a single XQuery comment node with the input argument as the content.

### *string-expression*

An expression whose value has a character string type: CHAR, VARCHAR or CLOB. The result of the *string-expression* is parsed to check for conformance to the requirements for an XML comment, as specified in the XML 1.0 rule. The result of the *string-expression* must conform to the following regular expression:

```
((Char - '-' ) | ('-' (Char - '-')))*
```

where Char is defined as any Unicode character excluding surrogate blocks X'FFFE' and X'FFFF'. Basically, the XML comment cannot contain two adjacent hyphens, and cannot end with a hyphen (SQLSTATE 2200S).

The data type of the result is XML. If the result of *string-expression* can be null, the result can be null; if the input value is null, the result is the null value.

### Notes:

1. **Support in non-Unicode databases and multiple database partition databases:** XMLCOMMENT is not supported (SQLSTATE 42997).

### Related concepts:

- “Publishing XML values with SQL/XML” in *XML Guide*

### Related reference:

- “XMLATTRIBUTES ” on page 449
- “XMLCONCAT ” on page 452
- “XMLDOCUMENT ” on page 454
- “XMLELEMENT ” on page 456
- “XMLFOREST ” on page 462
- “XMLNAMESPACES ” on page 466
- “XMLPARSE ” on page 469
- “XMLPI ” on page 471
- “XMLQUERY ” on page 473
- “XMLSERIALIZE ” on page 476
- “XMLTEXT ” on page 479
- “XMLVALIDATE ” on page 481
- “XMLAGG ” on page 271

---

**XMLCONCAT**

```

▶▶ XMLCONCAT ( —XML-expression— , —XML-expression— )

```

The schema is SYSIBM. The function name cannot be specified as a qualified name.

The XMLCONCAT function returns a sequence containing the concatenation of a variable number of XML input arguments.

*XML-expression*

Specifies an expression of data type XML.

The data type of the result is XML. The result is an XML sequence containing the concatenation of the non-null input XML values. Null values in the input are ignored. If the result of any *XML-expression* can be null, the result can be null; if the result of every input value is null, the result is the null value.

**Notes:**

**1. Support in non-Unicode databases and multiple database partition databases:**

The result, at the outer level of XML function nesting, must be an argument of the XMLSERIALIZE function (SQLSTATE 42997).

Example:

**Note:** XMLCONCAT does not insert blank spaces or new line characters in the output. All example output has been formatted to enhance readability.

- Construct a department element for departments A00 and B01, containing a list of employees sorted by first name. Include an introductory comment immediately preceding the department element.

```

SELECT XMLCONCAT (
  XMLCOMMENT (
    'Confirm these employees are on track for their product schedule'
  ),
  XMLELEMENT (
    NAME "Department",
    XMLATTRIBUTES (
      E.WORKDEPT AS "name"
    ),
    XMLAGG (
      XMLELEMENT (
        NAME "emp", E.FIRSTNME
      )
      ORDER BY E.FIRSTNME
    )
  )
)
FROM EMPLOYEE E
WHERE E.WORKDEPT IN ('A00', 'B01')
GROUP BY E.WORKDEPT

```

This query produces the following result:

```

<!--Confirm these employees are on track for their product schedule-->
<Department name="A00">
<emp>CHRISTINE</emp>
<emp>DIAN</emp>
<emp>GREG</emp>
<emp>SEAN</emp>

```

```
<emp>VINCENZO</emp>
</Department>
<!--Confirm these employees are on track for their product schedule-->
<Department name="B01">
<emp>MICHAEL</emp>
</Department>
```

**Related concepts:**

- “Publishing XML values with SQL/XML” in *XML Guide*

**Related reference:**

- “XMLATTRIBUTES ” on page 449
- “XMLCOMMENT ” on page 451
- “XMLDOCUMENT ” on page 454
- “XMLELEMENT ” on page 456
- “XMLFOREST ” on page 462
- “XMLNAMESPACES ” on page 466
- “XMLPARSE ” on page 469
- “XMLPI ” on page 471
- “XMLQUERY ” on page 473
- “XMLSERIALIZE ” on page 476
- “XMLTEXT ” on page 479
- “XMLVALIDATE ” on page 481
- “XMLAGG ” on page 271

---

**XMLDOCUMENT**

►►XMLDOCUMENT(—(*XML-expression*)—)◄◄

The schema is SYSIBM. The function name cannot be specified as a qualified name.

The XMLDOCUMENT function returns an XML value with a single XQuery document node with zero or more children nodes.

*XML-expression*

An expression that returns an XML value. A sequence item in the XML value must not be an attribute node (SQLSTATE 10507).

The data type of the result is XML. If the result of *XML-expression* can be null, the result can be null; if the input value is null, the result is the null value.

The children of the resulting document node are constructed as described in the following steps. The input expression is a sequence of nodes or atomic values, which is referred to in these steps as the content sequence.

1. If the content sequence contains a document node, the document node is replaced in the content sequence by the children of the document node.
2. Each adjacent sequence of one or more atomic values in the content sequence are replaced with a text node containing the result of casting each atomic value to a string with a single blank character inserted between adjacent values.
3. For each node in the content sequence, a new deep copy of the node is constructed. A deep copy of a node is a copy of the whole subtree rooted at that node, including the node itself and its descendants. Each copied node has a new node identity. Copied element and attribute nodes preserve their type annotation.
4. The nodes in the content sequence become the children of the new document node.

The XMLDOCUMENT function effectively executes the XQuery computed document constructor. The result of

```
XMLQUERY('document {$E}' PASSING BY REF XML-expression AS "E")
```

is equivalent to

```
XMLDOCUMENT( XML-expression )
```

with the exception of the case where *XML-expression* is null and XMLQUERY returns the empty sequence compared to XMLDOCUMENT which returns the null value.

**Notes:**

1. **Support in non-Unicode databases and multiple database partition databases:** XMLDOCUMENT is not supported (SQLSTATE 42997).

Example:

- Insert a constructed document into an XML column.

```
INSERT INTO T1 VALUES(
  123, (
    SELECT XMLDOCUMENT(
      XMLELEMENT(
        NAME "Emp", E.FIRSTNME || ' ' || E.LASTNAME, XMLCOMMENT(
```

```
        'This is just a simple example'  
    )  
    )  
    )  
FROM EMPLOYEE E  
WHERE E.EMPNO = '000120'  
    )  
    )
```

**Related concepts:**

- “Publishing XML values with SQL/XML” in *XML Guide*

**Related reference:**

- “XMLATTRIBUTES ” on page 449
- “XMLCOMMENT ” on page 451
- “XMLCONCAT ” on page 452
- “XMLELEMENT ” on page 456
- “XMLFOREST ” on page 462
- “XMLNAMESPACES ” on page 466
- “XMLPARSE ” on page 469
- “XMLPI ” on page 471
- “XMLQUERY ” on page 473
- “XMLSERIALIZE ” on page 476
- “XMLTEXT ” on page 479
- “XMLVALIDATE ” on page 481
- “XMLAGG ” on page 271

XMLELEMENT

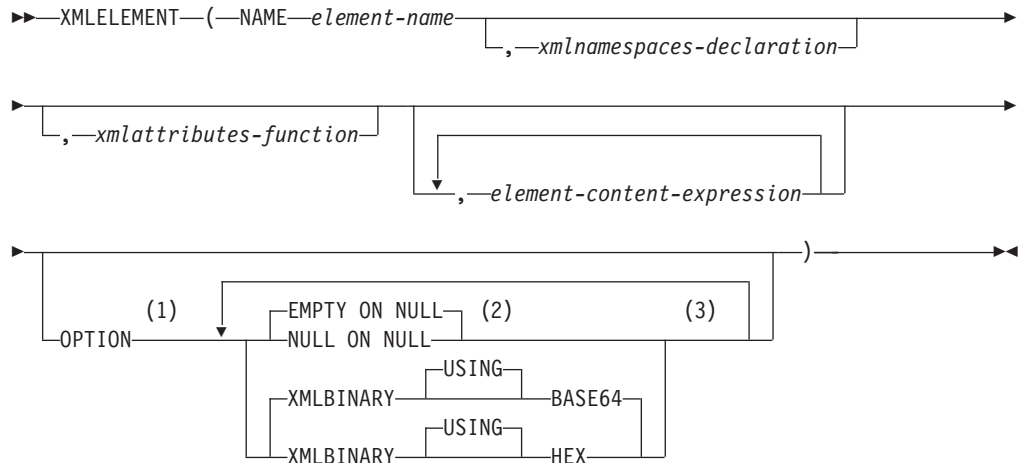

Notes:

- 1 The OPTION clause can only be specified if at least one *xmlattributes-function* or *element-content-expression* is specified.
- 2 NULL ON NULL or EMPTY ON NULL can only be specified if at least one *element-content-expression* is specified.
- 3 The same clause must not be specified more than once.

The schema is SYSIBM. The function name cannot be specified as a qualified name.

The XMLELEMENT function returns an XML value that is an XQuery element node.

NAME *element-name*

Specifies the name of an XML element. The name is an SQL identifier that must be in the form of an XML qualified name, or QName (SQLSTATE 42634). See the W3C XML namespace specifications for more details on valid names. If the name is qualified, the namespace prefix must be declared within the scope (SQLSTATE 42635).

*xmlns:spaces-declaration*

Specifies the XML namespace declarations that are the result of the XMLNAMESPACES declaration. The namespaces that are declared are in the scope of the XMLELEMENT function. The namespaces apply to any nested XML functions within the XMLELEMENT function, regardless of whether or not they appear inside another subselect.

If *xmlns:spaces-declaration* is not specified, namespace declarations are not associated with the constructed element.

*xmlattributes-function*

Specifies the XML attributes for the element. The attributes are the result of the XMLATTRIBUTES function.

*element-content-expression*

The content of the generated XML element node is specified by an expression or a list of expressions. The data type of *element-content-expression* cannot be a structured type (SQLSTATE 42884). The expression can be any SQL expression.

If *element-content-expression* is not specified, an empty string is used as the content for the element and `OPTION NULL ON NULL` or `EMPTY ON NULL` must not be specified.

**OPTION**

Specifies additional options for constructing the XML element. If no `OPTION` clause is specified, the default is `EMPTY ON NULL XMLBINARY USING BASE64`. This clause has no impact on nested `XMLELEMENT` invocations specified in *element-content-expression*.

**EMPTY ON NULL or NULL ON NULL**

Specifies whether a null value or an empty element is to be returned if the values of each *element-content-expression* is a null value. This option only affects null handling of element contents, not attribute values. The default is `EMPTY ON NULL`.

**EMPTY ON NULL**

If the value of each *element-content-expression* is null, an empty element is returned.

**NULL ON NULL**

If the value of each *element-content-expression* is null, a null value is returned.

**XMLBINARY USING BASE64 or XMLBINARY USING HEX**

Specifies the assumed encoding of binary input data, character string data with the `FOR BIT DATA` attribute, or a distinct type that is based on one of these types. The encoding applies to element content or attribute values. The default is `XMLBINARY USING BASE64`.

**XMLBINARY USING BASE64**

Specifies that the assumed encoding is base64 characters, as defined for XML schema type `xs:base64Binary` encoding. The base64 encoding uses a 65-character subset of US-ASCII (10 digits, 26 lowercase characters, 26 uppercase characters, '+', and '/') to represent every six bits of the binary or bit data with one printable character in the subset. These characters are selected so that they are universally representable. Using this method, the size of the encoded data is 33 percent larger than the original binary or bit data.

**XMLBINARY USING HEX**

Specifies that the assumed encoding is hexadecimal characters, as defined for XML schema type `xs:hexBinary` encoding. The hexadecimal encoding represents each byte (8 bits) with two hexadecimal characters. Using this method, the encoded data is twice the size of the original binary or bit data.

This function takes an element name, an optional collection of namespace declarations, an optional collection of attributes, and zero or more arguments that make up the content of the XML element. The result is an XML sequence containing an XML element node or the null value.

The data type of the result is XML. If any of the *element-content-expression* arguments can be null, the result can be null; if all the *element-content-expression* argument values are null and the `NULL ON NULL` option is in effect, the result is the null value.

**Notes:**

1. **Support in non-Unicode databases and multiple database partition databases:**  
The function is only supported as it was in Version 8. The result, at the outer

level of XML value function nesting, must be an argument of the XMLSERIALIZE function. The null handling options and binary encoding options cannot be specified (SQLSTATE 42997). BLOB and character string data defined as FOR BIT DATA cannot be specified (SQLSTATE 42884).

When constructing elements that will be copied as content of another element that defines default namespaces, default namespaces should be explicitly undeclared in the copied element to avoid possible errors that could result from inheriting the default namespace from the new parent element. Predefined namespace prefixes ('xs', 'xsi', 'xml', and 'sqlxml') must also be declared explicitly when they are used.

2. **Constructing an element node:** The resulting element node is constructed as follows:
  - a. The *xmlnamespaces-declaration* adds a set of in-scope namespaces for the constructed element. Each in-scope namespace associates a namespace prefix (or the default namespace) with a namespace URI. The in-scope namespaces define the set of namespace prefixes that are available for interpreting QNames within the scope of the element.
  - b. If the *xmlattributes-function* is specified, it is evaluated and the result is a sequence of attribute nodes.
  - c. Each *element-content-expression* is evaluated and the result is converted into a sequence of nodes as follows:
    - If the result type is not XML, it is converted to an XML text node whose content is the result of *element-content-expression* mapped to XML according to the rules of mapping SQL data values to XML data values (see the table that describes supported casts from non-XML values to XML values in “Casting between data types”).
    - If the result type is XML, then in general the result is a sequence of items. Some of the items in that sequence might be document nodes. Each document node in the sequence is replaced by the sequence of its top-level children. Then for each node in the resulting sequence, a new deep copy of the node is constructed, including its children and attributes. Each copied node has a new node identity. Copied element and attribute nodes preserve their type annotation. For each adjacent sequence of one or more atomic values returned in the sequence, a new text node is constructed, containing the result of casting each atomic value to a string, with a single blank character inserted between adjacent values. Adjacent text nodes in the content sequence are merged into a single text node by concatenating their contents, with no intervening blanks. After concatenation, any text node whose content is a zero-length string is deleted from the content sequence.
  - d. The result sequence of XML attributes and the resulting sequences of all *element-content-expression* specifications are concatenated into one sequence which is called the content sequence. Any sequence of adjacent text nodes in the content sequence is merged into a single text node. If all the *element-content-expression* arguments are empty strings, or an *element-content-expression* argument is not specified, an empty element is returned.
  - e. The content sequence must not contain an attribute node following a node that is not an attribute node (SQLSTATE 10507). Attribute nodes occurring in the content sequence become attributes of the new element node. Two or more of these attribute nodes must not have the same name (SQLSTATE 10503). A namespace declaration is created corresponding to any namespace used in the names of the attribute nodes if the namespace URI is not in the in-scope namespaces of the constructed element.



- f. Element, text, comment, and processing instruction nodes in the content sequence become the children of the constructed element node.
  - g. The constructed element node is given a type annotation of `xs:anyType`, and each of its attributes is given a type annotation of `xdt:untypedAtomic`. The node name of the constructed element node is element-name specified after the NAME keyword.
3. **Rules for using namespaces within XMLELEMENT:** Consider the following rules about scoping of namespaces:
- The namespaces declared in the XMLNAMESPACES declaration are the in-scope namespaces of the element node constructed by the XMLELEMENT function. If the element node is serialized, then each of its in-scope namespaces will be serialized as a namespace attribute unless it is an in-scope namespace of the parent of the element node and the parent element is serialized too.
  - If an XMLQUERY or XMLEXISTS is in an *element-content-expression*, then the namespaces becomes the statically known namespaces of the XQuery expression of the XMLQUERY or XMLEXISTS. Statically known namespaces are used to resolve the QName in the XQuery expression. If the XQuery prolog declares a namespace with the same prefix, within the scope of the XQuery expression, the namespace declared in the prolog will override the namespaces declared in the XMLNAMESPACES declaration.
  - If an attribute of the constructed element comes from an *element-content-expression*, its namespace might not already be declared as an in-scope namespace of the constructed element, in this case, a new namespace is created for it. If this would result in a conflict, which means that the prefix of the attribute name is already bound to a different URI by a in-scope namespace, DB2 generates a prefix that does not cause such a conflict and the prefix used in the attribute name is changed to the new prefix, and a namespace is created for this new prefix. The generated new prefix follows the following pattern: "db2ns-xx", where "x" is a character chosen from the set [A-Z,a-z,0-9]. For example:

```
VALUES XMLELEMENT(
  NAME "c", XMLQUERY(
    'declare namespace ipo="www.ipo.com"; $m/ipo:a/@ipo:b' PASSING XMLPARSE(
      DOCUMENT '<tst:a xmlns:tst="www.ipo.com" tst:b="2"/>'
    ) AS "m"
  )
)
```

returns:

```
<c xmlns:tst="www.ipo.com" tst:b="2"/>
```

A second example:

```
VALUES XMLELEMENT(
  NAME "tst:c", XMLNAMESPACES(
    'www.tst.com' AS "tst"
  ),
  XMLQUERY(
    'declare namespace ipo="www.ipo.com"; $m/ipo:a/@ipo:b' PASSING XMLPARSE(
      DOCUMENT '<tst:a xmlns:tst="www.ipo.com" tst:b="2"/>'
    ) AS "m"
  )
)
```

returns:

```
<tst:c xmlns:tst="www.tst.com" xmlns:db2ns-a1="www.ipo.com" db2ns-a1:b="2"/>
```

## XMLELEMENT

Examples:

**Note:** XMLELEMENT does not insert blank spaces or new line characters in the output. All example output has been formatted to enhance readability.

- Construct an element with the NULL ON NULL option.

```
SELECT E.FIRSTNME, E.LASTNAME, XMLELEMENT(
  NAME "Emp", XMLELEMENT(
    NAME "firstname", E.FIRSTNME
  ),
  XMLELEMENT(
    NAME "lastname", E.LASTNAME
  )
  OPTION NULL ON NULL
)
AS "Result"
FROM EMPLOYEE E
WHERE E.EDLEVEL = 12
```

This query produces the following result:

| FIRSTNME | LASTNAME | Emp   |
|----------|----------|---|
| JOHN     | PARKER   | <Emp><firstname>JOHN</firstname><br><lastname>PARKER</lastname></Emp>       |
| MAUDE    | SETRIGHT | <Emp><firstname>MAUDE</firstname><br><lastname>SETRIGHT</lastname></Emp>    |
| MICHELLE | SPRINGER | <Emp><firstname>MICHELLE</firstname><br><lastname>SPRINGER</lastname></Emp> |

- Produce an element with a list of elements nested as child elements.

```
SELECT XMLELEMENT(
  NAME "Department", XMLATTRIBUTES(
    E.WORKDEPT AS "name"
  ),
  XMLAGG(
    XMLELEMENT(
      NAME "emp", E.FIRSTNME
    )
    ORDER BY E.FIRSTNME
  )
)
AS "dept_list"
FROM EMPLOYEE E
WHERE E.WORKDEPT IN ('A00', 'B01')
GROUP BY WORKDEPT
```

This query produces the following result:

```
dept_list
<Department name="A00">
<emp>CHRISTINE</emp>
<emp>SEAN</emp>
<emp>VINCENZO</emp>
</Department>
<Department name="B01">
<emp>MICHAEL</emp>
</Department>
```

### Related concepts:

- “Publishing XML values with SQL/XML” in *XML Guide*

### Related reference:

- “XMLPI ” on page 471
- “XMLQUERY ” on page 473

- “XMLAGG ” on page 271
- “XMLATTRIBUTES ” on page 449
- “XMLCOMMENT ” on page 451
- “XMLCONCAT ” on page 452
- “XMLDOCUMENT ” on page 454
- “XMLFOREST ” on page 462
- “XMLNAMESPACES ” on page 466
- “XMLPARSE ” on page 469
- “XMLSERIALIZE ” on page 476
- “XMLTEXT ” on page 479
- “XMLVALIDATE ” on page 481

## XMLFOREST

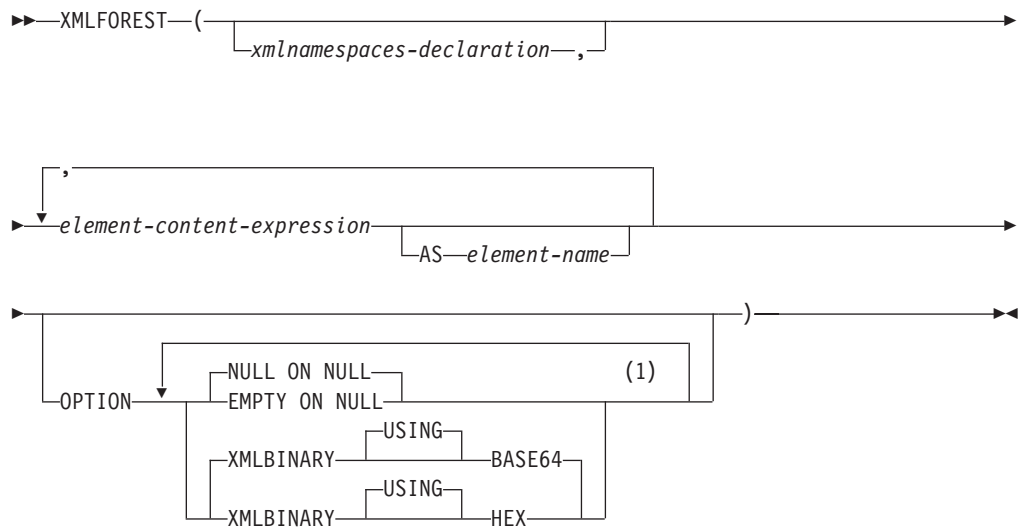
**Notes:**

- 1 The same clause must not be specified more than once.

The schema is SYSIBM. The function name cannot be specified as a qualified name.

The XMLFOREST function returns an XML value that is a sequence of XQuery element nodes.

*xmlnamespaces-declaration*

Specifies the XML namespace declarations that are the result of the XMLNAMESPACES declaration. The namespaces that are declared are in the scope of the XMLFOREST function. The namespaces apply to any nested XML functions within the XMLFOREST function, regardless of whether or not they appear inside another subselect.

If *xmlnamespaces-declaration* is not specified, namespace declarations are not associated with the constructed elements.

*element-content-expression*

The content of the generated XML element node is specified by an expression. The data type of *element-content-expression* cannot be a structured type (SQLSTATE 42884). The expression can be any SQL expression. If the expression is not a simple column reference, an element name must be specified.

**AS** *element-name*

Specifies the XML element name as an SQL identifier. The element name must be of the form of an XML qualified name, or QName (SQLSTATE 42634). See the W3C XML namespace specifications for more details on valid names. If the name is qualified, the namespace prefix must be declared within the scope (SQLSTATE 42635). If *element-name* is not specified, *element-content-expression* must be a column name (SQLSTATE 42703, SQLCODE -206). The element name is created from the column name using the fully escaped mapping from a column name to an QName.

**OPTION**

Specifies additional options for constructing the XML element. If no OPTION clause is specified, the default is NULL ON NULL XMLBINARY USING BASE64. This clause has no impact on nested XMLELEMENT invocations specified in *element-content-expression*.

**EMPTY ON NULL or NULL ON NULL**

Specifies whether a null value or an empty element is to be returned if the values of each *element-content-expression* is a null value. This option only affects null handling of element contents, not attribute values. The default is NULL ON NULL.

**EMPTY ON NULL**

If the value of each *element-content-expression* is null, an empty element is returned.

**NULL ON NULL**

If the value of each *element-content-expression* is null, a null value is returned.

**XMLBINARY USING BASE64 or XMLBINARY USING HEX**

Specifies the assumed encoding of binary input data, character string data with the FOR BIT DATA attribute, or a distinct type that is based on one of these types. The encoding applies to element content or attribute values. The default is XMLBINARY USING BASE64.

**XMLBINARY USING BASE64**

Specifies that the assumed encoding is base64 characters, as defined for XML schema type xs:base64Binary encoding. The base64 encoding uses a 65-character subset of US-ASCII (10 digits, 26 lowercase characters, 26 uppercase characters, '+', and '/') to represent every six bits of the binary or bit data with one printable character in the subset. These characters are selected so that they are universally representable. Using this method, the size of the encoded data is 33 percent larger than the original binary or bit data.

**XMLBINARY USING HEX**

Specifies that the assumed encoding is hexadecimal characters, as defined for XML schema type xs:hexBinary encoding. The hexadecimal encoding represents each byte (8 bits) with two hexadecimal characters. Using this method, the encoded data is twice the size of the original binary or bit data.

This function takes an optional set of namespace declarations and one or more arguments that make up the name and element content for one or more element nodes. The result is an XML sequence containing a sequence of XQuery element nodes or the null value.

The data type of the result is XML. If any of the *element-content-expression* arguments can be null, the result can be null; if all the *element-content-expression* argument values are null and the NULL ON NULL option is in effect, the result is the null value.

The XMLFOREST function can be expressed by using XMLCONCAT and XMLELEMENT. For example, the following two expressions are semantically equivalent.

```
XMLFOREST(xmlnamespaces-declaration, arg1 AS name1, arg2 AS name2 ...)
```

```
XMLCONCAT (
  XMLELEMENT (
    NAME name1, xmlnamespaces-declaration, arg1
  ),
  XMLELEMENT (
    NAME name2, xmlnamespaces-declaration, arg2
  )
  ...
)
```

**Notes:****1. Support in non-Unicode databases and multiple database partition databases:**

The function is only supported as it was in Version 8. The result, at the outer level of XML value function nesting, must be an argument of the XMLSERIALIZE function. The null handling options and binary encoding options cannot be specified (SQLSTATE 42997). BLOB and character string data defined as FOR BIT DATA cannot be specified (SQLSTATE 42884).

When constructing elements that will be copied as content of another element that defines default namespaces, default namespaces should be explicitly undeclared in the copied element to avoid possible errors that could result from inheriting the default namespace from the new parent element. Predefined namespace prefixes ('xs', 'xsi', 'xml', and 'sqlxml') must also be declared explicitly when they are used.

Example:

**Note:** XMLFOREST does not insert blank spaces or new line characters in the output. All example output has been formatted to enhance readability.

- Construct a forest of elements with a default namespace.

```
SELECT EMPNO,
       XMLFOREST(
         XMLNAMESPACES(
           DEFAULT 'http://hr.org', 'http://fed.gov' AS "d"
         ),
         LASTNAME, JOB AS "d:job"
       )
AS "Result"
FROM EMPLOYEE
WHERE EDLEVEL = 12
```

This query produces the following result:

```
EMPNO Result
000290 <LASTNAME xmlns="http://hr.org" xmlns:d="http://fed.gov">PARKER</LASTNAME>
<d:job xmlns="http://hr.org" xmlns:d="http://fed.gov">OPERATOR</d:job>

000310 <LASTNAME xmlns="http://hr.org" xmlns:d="http://fed.gov">SETRIGHT</LASTNAME>
<d:job xmlns="http://hr.org" xmlns:d="http://fed.gov">OPERATOR</d:job>

200310 <LASTNAME xmlns="http://hr.org" xmlns:d="http://fed.gov">SPRINGER</LASTNAME>
<d:job xmlns="http://hr.org" xmlns:d="http://fed.gov">OPERATOR</d:job>
```

**Related concepts:**

- “Publishing XML values with SQL/XML” in *XML Guide*

**Related reference:**

- “XMLATTRIBUTES ” on page 449
- “XMLCOMMENT ” on page 451
- “XMLCONCAT ” on page 452

- “XMLDOCUMENT ” on page 454
- “XMLELEMENT ” on page 456
- “XMLNAMESPACES ” on page 466
- “XMLPARSE ” on page 469
- “XMLPI ” on page 471
- “XMLQUERY ” on page 473
- “XMLSERIALIZE ” on page 476
- “XMLTEXT ” on page 479
- “XMLVALIDATE ” on page 481
- “XMLAGG ” on page 271

## XMLNAMESPACES

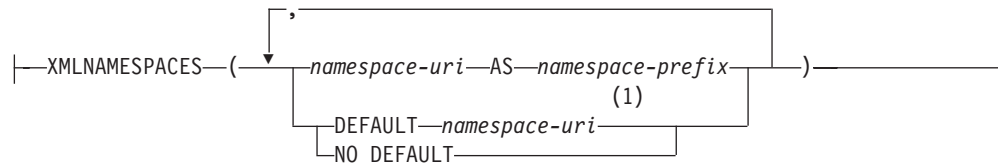
**xmlnamespaces-declaration:****Notes:**

- 1 DEFAULT or NO DEFAULT can only be specified once in arguments of XMLNAMESPACES.

The schema is SYSIBM. The declaration name cannot be specified as a qualified name.

The XMLNAMESPACES declaration constructs namespace declarations from the arguments. This declaration can only be used as an argument for specific functions such as XMLELEMENT, XMLFOREST and XMLTABLE. The result is one or more XML namespace declarations containing in-scope namespaces for each non-null input value.

*namespace-uri*

Specifies the namespace universal resource identifier (URI) as an SQL character string constant. This character string constant must not be empty if it is used with a *namespace-prefix* (SQLSTATE 42815).

*namespace-prefix*

Specifies a namespace prefix. The prefix is an SQL identifier that must be in the form of an XML NCName (SQLSTATE 42634). See the W3C XML namespace specifications for more details on valid names. The prefix cannot be `xml` or `xmlns` and the prefix must be unique within the list of namespace declarations (SQLSTATE 42635).

**DEFAULT** *namespace-uri*

Specifies the default namespace to use within the scope of this namespace declaration. The *namespace-uri* applies for unqualified names in the scope unless overridden in a nested scope by another DEFAULT declaration or a NO DEFAULT declaration.

**NO DEFAULT**

Specifies that no default namespace is to be used within the scope of this namespace declaration. There is no default namespace in the scope unless overridden in a nested scope by a DEFAULT declaration.

The data type of the result is XML. The result is an XML namespace declaration for each specified namespace. The result cannot be null.

Examples:

**Note:** XMLNAMESPACES does not insert blank spaces or new line characters in the output. All example output has been formatted to enhance readability.

- Produce an XML element named `adm:employee` and an XML attribute `adm:department`, both associated with a namespace whose prefix is `adm`.



```

SELECT EMPNO, XMLELEMENT(
  NAME "adm:employee", XMLNAMESPACES(
    'http://www.adm.com' AS "adm"
  ),
  XMLATTRIBUTES(
    WORKDEPT AS "adm:department"
  ),
  LASTNAME
)
FROM EMPLOYEE
WHERE JOB = 'ANALYST'

```

This query produces the following result:

```

000130 <adm:employee xmlns:adm="http://www.adm.com" adm:department="C01">
  QUINTANA</adm:employee>
000140 <adm:employee xmlns:adm="http://www.adm.com" adm:department="C01">
  NICHOLLS</adm:employee>
200140 <adm:employee xmlns:adm="http://www.adm.com" adm:department="C01">
  NATZ</adm:employee>

```

- Produce an XML element named 'employee', which is associated with a default namespace, and a sub-element named 'job', which does not use a default namespace, but whose sub-element named 'department' does use a default namespace.

```

SELECT EMP.EMPNO, XMLELEMENT(
  NAME "employee", XMLNAMESPACES(
    DEFAULT 'http://hr.org'
  ),
  EMP.LASTNAME, XMLELEMENT(
    NAME "job", XMLNAMESPACES(
      NO DEFAULT
    ),
    EMP.JOB, XMLELEMENT(
      NAME "department", XMLNAMESPACES(
        DEFAULT 'http://adm.org'
      ),
      EMP.WORKDEPT
    )
  )
)
FROM EMPLOYEE EMP
WHERE EMP.EDLEVEL = 12

```

This query produces the following result:

```

000290 <employee xmlns="http://hr.org">PARKER<job xmlns="">OPERATOR
  <department xmlns="http://adm.org">E11</department></job></employee>
000310 <employee xmlns="http://hr.org">SETRIGHT<job xmlns="">OPERATOR
  <department xmlns="http://adm.org">E11</department></job></employee>
200310 <employee xmlns="http://hr.org">SPRINGER<job xmlns="">OPERATOR
  <department xmlns="http://adm.org">E11</department></job></employee>

```

#### Related concepts:

- "Publishing XML values with SQL/XML" in *XML Guide*

#### Related reference:

- "XMLATTRIBUTES " on page 449
- "XMLCOMMENT " on page 451
- "XMLCONCAT " on page 452
- "XMLDOCUMENT " on page 454
- "XMLELEMENT " on page 456
- "XMLFOREST " on page 462

## XMLNAMESPACES

- “XMLPARSE ” on page 469
- “XMLPI ” on page 471
- “XMLQUERY ” on page 473
- “XMLSERIALIZE ” on page 476
- “XMLTEXT ” on page 479
- “XMLVALIDATE ” on page 481
- “XMLAGG ” on page 271

## XMLPARSE

```

▶▶ XMLPARSE ( ( DOCUMENT string-expression [ STRIP WHITESPACE | PRESERVE WHITESPACE ] ) )

```

The schema is SYSIBM. The function name cannot be specified as a qualified name.

The XMLPARSE function parses the argument as an XML document and returns an XML value.

**DOCUMENT**

Specifies that the character string expression to be parsed must evaluate to a well-formed XML document that conforms to XML 1.0, as modified by the XML Namespaces recommendation (SQLSTATE 2200M).

*string-expression*

Specifies an expression that returns a character string or BLOB value. If a parameter marker is used, it must explicitly be cast to one of the supported data types.

**STRIP WHITESPACE or PRESERVE WHITESPACE**

Specifies whether or not whitespace in the input argument is to be preserved. If neither is specified, STRIP WHITESPACE is the default.

**STRIP WHITESPACE**

Specifies that text nodes containing only whitespace characters up to 1000 bytes in length will be stripped, unless the nearest containing element has the attribute `xml:space='preserve'`. If any text node begins with more than 1000 bytes of whitespace, an error is returned (SQLSTATE 54059).

The whitespace characters in the CDATA section are also affected by this option. DTDs may have DOCTYPE declarations for elements, but the content models of elements are not used to determine if whitespace is stripped or not.

**PRESERVE WHITESPACE**

Specifies that all whitespace is to be preserved, even when the nearest containing element has the attribute `xml:space='default'`.

The data type of the result is XML. If the result of *string-expression* can be null, the result can be null; if the result of *string-expression* is null, the result is the null value.

**Notes:**

- Support in non-Unicode databases and multiple database partition databases:** XMLPARSE is not supported (SQLSTATE 42997).
- Encoding of the input string:** The input string may contain an XML declaration that identifies the encoding of the characters in the XML document. If the string is passed to the XMLPARSE function as a character string, it will be converted to the code page at the database server. This code page may be different from the originating code page and the encoding identified in the XML declaration.

Therefore, applications should avoid direct use of XMLPARSE with character string input and should send strings containing XML documents directly using host variables to maintain the match between the external code page and the

encoding in the XML declaration. If XMLPARSE must be used in this situation, a BLOB type should be specified as the argument to avoid code page conversion.

3. **Handling of DTDs:** External document type definitions (DTDs) and entities must be registered in a database. Both internal and external DTDs are checked for valid syntax. During the parsing process, the following actions are also performed:
  - Default values that are defined by the internal and external DTDs are applied.
  - Entity references and parameter entities are replaced by their expanded forms.
  - If an internal DTD and an external DTD define the same element, an error is returned (SQLSTATE 2200M).
  - If an internal DTD and an external DTD define the same entity or attribute, the internal definition is chosen.

After parsing, internal DTDs and entities, as well as references to external DTDs and entities, are not preserved in the stored representation of the value.

**Related concepts:**

- “XML parsing” in *XML Guide*

**Related reference:**

- “XMLAGG ” on page 271
- “XMLATTRIBUTES ” on page 449
- “XMLCOMMENT ” on page 451
- “XMLCONCAT ” on page 452
- “XMLDOCUMENT ” on page 454
- “XMLELEMENT ” on page 456
- “XMLFOREST ” on page 462
- “XMLNAMESPACES ” on page 466
- “XMLPI ” on page 471
- “XMLQUERY ” on page 473
- “XMLSERIALIZE ” on page 476
- “XMLTEXT ” on page 479
- “XMLVALIDATE ” on page 481

## XMLPI

```

▶▶ XMLPI ( ( —NAME— pi-name , —string-expression— ) )

```

The schema is SYSIBM. The function name cannot be specified as a qualified name.

The XMLPI function returns an XML value with a single XQuery processing instruction node.

**NAME** *pi-name*

Specifies the name of a processing instruction. The name is an SQL identifier that must be in the form of an XML NCName (SQLSTATE 42634). See the W3C XML namespace specifications for more details on valid names. The name cannot be the word 'xml' in any case combination (SQLSTATE 42634).

*string-expression*

An expression that returns a value that is a character string. The resulting string is converted to UTF-8 and must conform to the content of an XML processing instruction as specified in XML 1.0 rules (SQLSTATE 2200T):

- The string must not contain the substring '?>' since this substring terminates a processing instruction
- Each character of the string can be any Unicode character excluding the surrogate blocks, X'FFFE' and X'FFFF'.

The resulting string becomes the content of the constructed processing instruction node.

The data type of the result is XML. If the result of *string-expression* can be null, the result can be null; if the result of *string-expression* is null, the result is the null value. If *string-expression* is an empty string or is not specified, an empty processing instruction node is returned.

**Notes:**

1. **Support in non-Unicode databases and multiple database partition databases:** XMLPI is not supported (SQLSTATE 42997).

## Examples:

- Generate an XML processing instruction node.

```

SELECT XMLPI (
  NAME "Instruction", 'Push the red button'
)
FROM SYSIBM.SYSDUMMY1

```

This query produces the following result:

```
<?Instruction Push the red button?>
```

- Generate an empty XML processing instruction node.

```

SELECT XMLPI (
  NAME "Warning"
)
FROM SYSIBM.SYSDUMMY1

```

This query produces the following result:

```
<?Warning ?>
```

## XMLPI

### Related concepts:

- “Publishing XML values with SQL/XML” in *XML Guide*

### Related reference:

- “XMLATTRIBUTES ” on page 449
- “XMLCOMMENT ” on page 451
- “XMLCONCAT ” on page 452
- “XMLDOCUMENT ” on page 454
- “XMLELEMENT ” on page 456
- “XMLFOREST ” on page 462
- “XMLNAMESPACES ” on page 466
- “XMLPARSE ” on page 469
- “XMLTEXT ” on page 479
- “XMLVALIDATE ” on page 481
- “XMLAGG ” on page 271
- “XMLQUERY ” on page 473
- “XMLSERIALIZE ” on page 476

## XMLQUERY

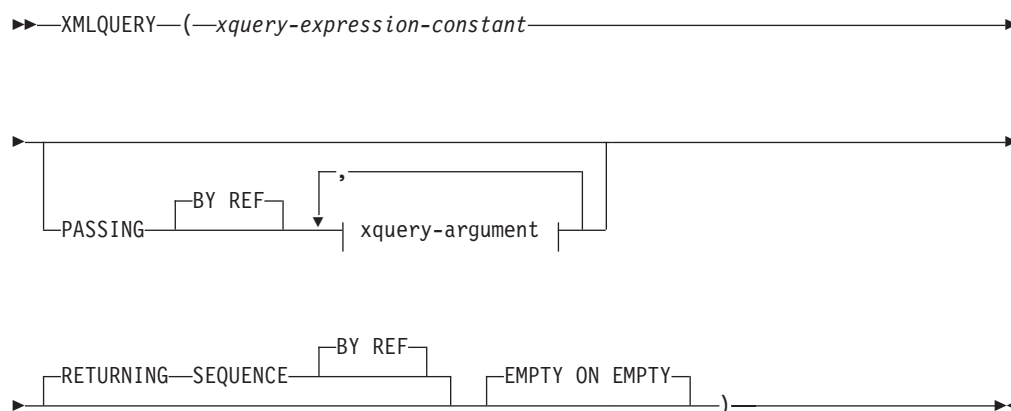
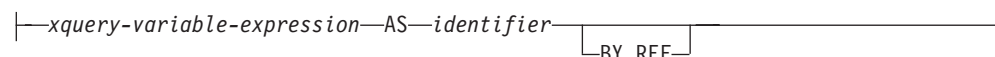
**xquery-argument:**

The schema is SYSIBM. The function name cannot be specified as a qualified name.

The XMLQUERY function returns an XML value from the evaluation of an XQuery expression possibly using specified input arguments as XQuery variables.

*xquery-expression-constant*

Specifies an SQL character string constant that is interpreted as an XQuery expression using supported XQuery language syntax. The constant string is converted directly to UTF-8 without conversion to the database or section code page. The XQuery expression executes using an optional set of input XML values, and returns an output sequence that is also returned as the value of the XMLQUERY expression. The value for *xquery-expression-constant* must not be an empty string or a string of blank characters (SQLSTATE 10505).

**PASSING**

Specifies input values and the manner in which these values are passed to the XQuery expression specified by *xquery-expression-constant*.

**BY REF**

Specifies that the default passing mechanism is by reference for any *xquery-variable-expression* of data type XML and for the returned value. When XML values are passed by reference, the XQuery evaluation uses the input node trees, if any, directly from the specified input expressions, preserving all properties, including the original node identities and document order. If two arguments pass the same XML value, node identity comparisons and document ordering comparisons involving some nodes contained between the two input arguments might refer to nodes within the same XML node tree.

This clause has no impact on how non-XML values are passed. The non-XML values create a new copy of the value during the cast to XML.

**xquery-argument**

Specifies an argument that is to be passed to the XQuery expression

specified by *xquery-expression-constant*. An argument specifies a value and the manner in which that value is to be passed. The argument includes an SQL expression that is evaluated.

- If the resulting value is of type XML, it becomes an *input-xml-value*. A null XML value is converted to an XML empty sequence.
- If the resulting value is not of type XML, it must be castable to the XML data type. A null value is converted to an XML empty sequence. The converted value becomes an *input-xml-value*.

When the *xquery-expression-constant* is evaluated, an XQuery variable is presented with a value equal to *input-xml-value* and a name specified by the AS clause.

#### *xquery-variable-expression*

Specifies an SQL expression whose value is available to the XQuery expression specified by *xquery-expression-constant* during execution. The expression cannot contain a sequence reference (SQLSTATE 428F9) or an OLAP function (SQLSTATE 42903).

#### **AS** *identifier*

Specifies that the value generated by *xquery-variable-expression* will be passed to *xquery-expression-constant* as an XQuery variable. The variable name will be *identifier*. The leading dollar sign (\$) that precedes variable names in the XQuery language is not included in *identifier*. The identifier must be a valid XQuery variable name and is restricted to an XML NCName (SQLSTATE 42634). The identifier must not be greater than 128 bytes in length. Two arguments within the same PASSING clause cannot use the same identifier (SQLSTATE 42711).

#### **BY REF**

Indicates that an XML input value is to be passed by reference. When XML values are passed by reference, the XQuery evaluation uses the input node trees, if any, directly from the specified input expressions, preserving all properties, including the original node identities and document order. If two arguments pass the same XML value, node identity comparisons and document ordering comparisons involving some nodes contained between the two input arguments might refer to nodes within the same XML node tree. If BY REF is not specified following an *xquery-variable-expression*, XML arguments are passed by way of the default passing mechanism that is provided through the syntax that follows the PASSING keyword. This option cannot be specified for non-XML values. When a non-XML value is passed, the value is converted to XML; this process creates a copy.

#### **RETURNING SEQUENCE**

Indicates that the XMLQUERY expression returns a sequence.

#### **BY REF**

Indicates that the result of the XQuery expression is returned by reference. If this value contains nodes, any expression using the return value of the XQuery expression will receive node references directly, preserving all node properties, including the original node identities and document order. Referenced nodes will remain connected within their node trees. If the BY REF clause is not specified and the PASSING is specified, the default passing mechanism is used. If BY REF is not specified and PASSING is not specified, the default returning mechanism is BY REF.



**EMPTY ON EMPTY**

Specifies that an empty sequence result from processing the XQuery expression is returned as an empty sequence.

The data type of the result is XML; it cannot be null.

If the evaluation of the XQuery expression results in an error, then the XMLQUERY function returns the XQuery error (SQLSTATE class '10').

**Notes:**

1. **XMLQUERY usage restrictions:** The XMLQUERY function cannot be:
  - Part of the ON clause that is associated with a JOIN operator or a MERGE statement (SQLSTATE 42972)
  - Part of the GENERATE KEY USING or RANGE THROUGH clause in the CREATE INDEX EXTENSION statement (SQLSTATE 428E3)
  - Part of the FILTER USING clause in the CREATE FUNCTION (External Scalar) statement, or the FILTER USING clause in the CREATE INDEX EXTENSION statement (SQLSTATE 428E4)
  - Part of a check constraint or a column generation expression (SQLSTATE 42621)
  - Part of a group-by-clause (SQLSTATE 42822)
  - Part of an argument for a column-function (SQLSTATE 42607)
2. **XMLQUERY as a subquery:** An XMLQUERY expression that acts as a subquery can be restricted by statements that restrict subqueries.
3. **Support in non-Unicode databases and multiple database partition databases:** XMLQUERY is not supported (SQLSTATE 42997).

**Related concepts:**

- “XMLQUERY overview” in *XML Guide*

**Related reference:**

- “XMLNAMESPACES ” on page 466
- “XMLATTRIBUTES ” on page 449
- “XMLCOMMENT ” on page 451
- “XMLCONCAT ” on page 452
- “XMLDOCUMENT ” on page 454
- “XMLELEMENT ” on page 456
- “XMLFOREST ” on page 462
- “XMLPARSE ” on page 469
- “XMLPI ” on page 471
- “XMLSERIALIZE ” on page 476
- “XMLTEXT ” on page 479
- “XMLVALIDATE ” on page 481
- “XMLAGG ” on page 271

## XMLSERIALIZE

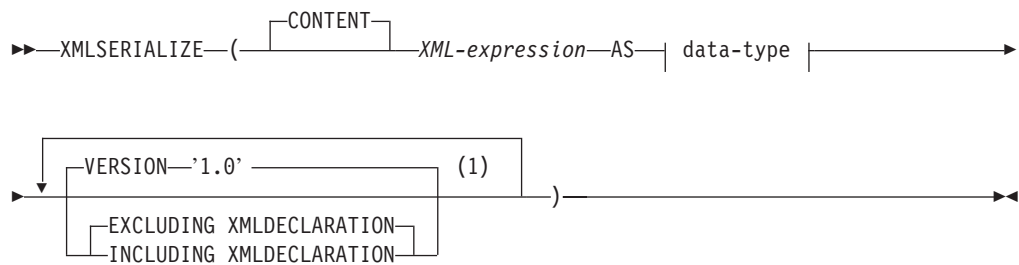
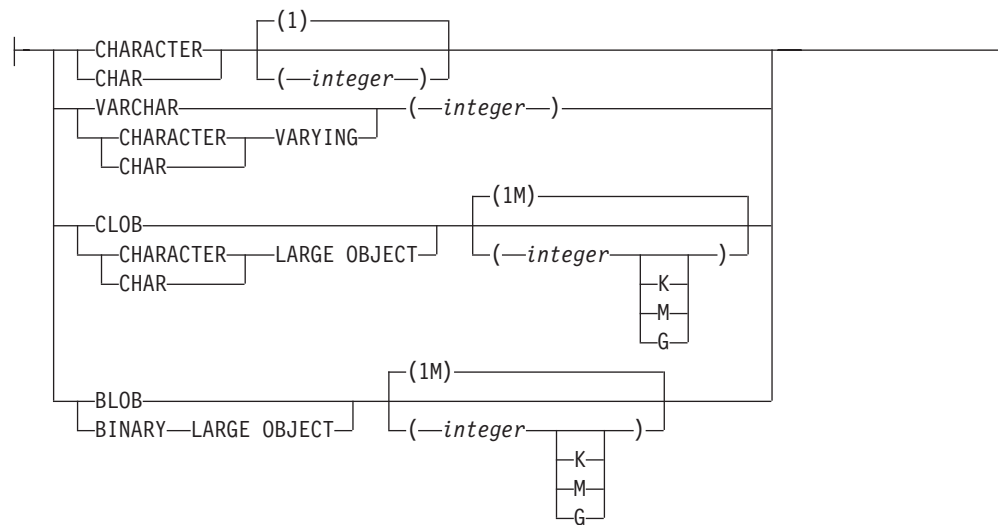
**data-type:****Notes:**

- 1 The same clause must not be specified more than once.

The schema is SYSIBM. The function name cannot be specified as a qualified name.

The XMLSERIALIZE function returns a serialized XML value of the specified data type generated from the *XML-expression* argument.

**CONTENT**

Specifies that any XML value can be specified and the result of the serialization is based on this input value.

*XML-expression*

Specifies an expression that returns a value of data type XML. The XML sequence value must not contain an item that is an attribute node (SQLSTATE 2200W). This is the input to the serialization process.

**AS data-type**

Specifies the result type. The implicit or explicit length attribute of the specified result data type must be sufficient to contain the serialized output (SQLSTATE 22001).

**VERSION '1.0'**

Specifies the XML version of the serialized value. The only version supported is '1.0' which must be specified as a string constant (SQLSTATE 42815).

**EXCLUDING XMLDECLARATION or INCLUDING XMLDECLARATION**

Specifies whether an XML declaration is included in the result. The default is EXCLUDING XMLDECLARATION.

**EXCLUDING XMLDECLARATION**

Specifies that an XML declaration is not included in the result.

**INCLUDING XMLDECLARATION**

Specifies that an XML declaration is included in the result. The XML declaration is the string '<?xml version="1.0" encoding="UTF-8"?>'.

The result has the data type specified by the user. An XML sequence is effectively converted to have a single document node by applying XMLDOCUMENT to *XML-expression* prior to serializing the resulting XML nodes. If the result of *XML-expression* can be null, the result can be null; if the result of *XML-expression* is null, the result is the null value.

**Notes:**

1. **Support in non-Unicode databases and multiple database partition databases:** The function is only supported as it was in Version 8. The CONTENT keyword must be specified, a BLOB data type cannot be specified, and an XMLDECLARATION option cannot be specified (SQLSTATE 42997).
2. **Encoding in the serialized result:** The serialized result is encoded with UTF-8. If XMLSERIALIZE is used with a character data type, and the INCLUDING XMLDECLARATION clause is specified, the resulting character string containing serialized XML might have an XML encoding declaration that does not match the code page of the character string. Following serialization, which uses UTF-8 encoding, the character string that is returned from the server to the client is converted to the code page of the client, and that code page might be different from UTF-8.  
Therefore, applications should avoid direct use of XMLSERIALIZE INCLUDING XMLDECLARATION that return character string types and should retrieve XML values directly into host variables to maintain the match between the external code page and the encoding in the XML declaration. If XMLSERIALIZE must be used in this situation, a BLOB type should be specified to avoid code page conversion.
3. **Syntax alternative:** XMLCLOB(*XML-expression*) can be specified in place of XMLSERIALIZE(*XML-expression* AS CLOB(2G)). It is supported only for compatibility with previous DB2 releases.

**Related concepts:**

- "XML serialization" in *XML Guide*

**Related reference:**

- "XMLATTRIBUTES " on page 449
- "XMLCOMMENT " on page 451
- "XMLCONCAT " on page 452
- "XMLDOCUMENT " on page 454
- "XMLELEMENT " on page 456
- "XMLFOREST " on page 462
- "XMLNAMESPACES " on page 466

## **XMLSERIALIZE**

- “XMLPARSE ” on page 469
- “XMLPI ” on page 471
- “XMLQUERY ” on page 473
- “XMLTEXT ” on page 479
- “XMLVALIDATE ” on page 481
- “XMLAGG ” on page 271

---

**XMLTEXT**

►►—XMLTEXT—(—*string-expression*—)—————►►

The schema is SYSIBM. The function name cannot be specified as a qualified name.

The XMLTEXT function returns an XML value with a single XQuery text node having the input argument as the content.

*string-expression*

An expression whose value has a character string type: CHAR, VARCHAR or CLOB.

The data type of the result is XML. If the result of *string-expression* can be null, the result can be null; if the input value is null, the result is the null value. If the result of *string-expression* is an empty string, the result value is an empty text node.

**Notes:**

1. **Support in non-Unicode databases and multiple database partition databases:**  
XMLTEXT is not supported (SQLSTATE 42997).

Examples:

- Create a simple XMLTEXT query.

```
VALUES(
  XMLTEXT(
    'The stock symbol for Johnson&Johnson is JNJ.'
  )
)
```

This query produces the following serialized result:

```
1
-----
The stock symbol for Johnson&Johnson is JNJ.
```

Note that the '&' sign is mapped to '&amp;,' when a text node is serialized.

- Use XMLTEXT with XMLAGG to construct mixed content. Suppose that the content of table T is as follows:

| seqno | plaintext   | emphertext    |
|-------|---|---------------|
| 1     | This query shows how to construct   | mixed content |
| 2     | using XMLAGG and XMLTEXT. Without   | XMLTEXT       |
| 3     | XMLAGG will not have text nodes to group with other nodes, therefore, cannot generate | mixed content |

```
SELECT XMLELEMENT(
  NAME "para", XMLAGG(
    XMLCONCAT(
      XMLTEXT(
        PLAINTEXT
      ),
      XMLELEMENT(
        NAME "emphasis", EMPHTEXT
      )
    )
  )
  ORDER BY SEQNO
), '.'
) AS "result"
FROM T
```

This query produces the following result:

result

---

```
<para>This query shows how to construct <emphasis>mixed content</emphasis>
using XMLAGG and XMLTEXT. Without <emphasis>XMLTEXT</emphasis> , XMLAGG
will not have text nodes to group with other nodes, therefore, cannot generate
<emphasis>mixed content</emphasis>.</para>
```

### Related concepts:

- “Publishing XML values with SQL/XML” in *XML Guide*

### Related reference:

- “XMLATTRIBUTES ” on page 449
- “XMLCOMMENT ” on page 451
- “XMLCONCAT ” on page 452
- “XMLDOCUMENT ” on page 454
- “XMLELEMENT ” on page 456
- “XMLFOREST ” on page 462
- “XMLNAMESPACES ” on page 466
- “XMLPARSE ” on page 469
- “XMLPI ” on page 471
- “XMLQUERY ” on page 473
- “XMLSERIALIZE ” on page 476
- “XMLVALIDATE ” on page 481
- “XMLAGG ” on page 271

## XMLVALIDATE

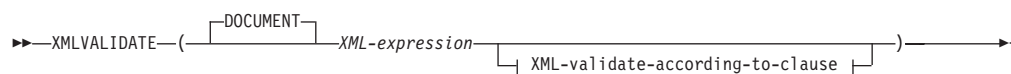
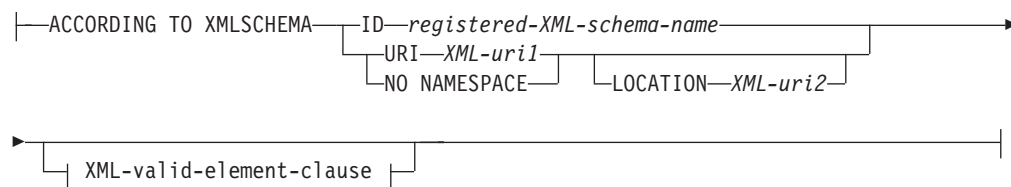
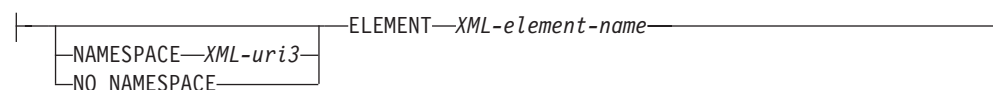
**XML-validate-according-to-clause:****XML-valid-element-clause:**

The schema is SYSIBM. The function name cannot be specified as a qualified name.

The XMLVALIDATE function returns a copy of the input XML value augmented with information obtained from XML schema validation, including default values and type annotations.

**DOCUMENT**

Specifies that the XML value resulting from *XML-expression* must be a well-formed XML document that conforms to XML Version 1.0 (SQLSTATE 2200M).

*XML-expression*

An expression that returns a value of data type XML. If *XML-expression* is an XML host variable or an implicitly or explicitly typed parameter marker, the function performs a validating parse that strips ignorable whitespace and the CURRENT IMPLICIT XMLPARSE OPTION setting is not considered.

**XML-validate-according-to-clause**

Specifies the information that is to be used when validating the input XML value.

**ACCORDING TO XMLSCHEMA**

Indicates that the XML schema information for validation is explicitly specified. If this clause is not included, the XML schema information must be provided in the content of the *XML-expression* value.

**ID** *registered-XML-schema-name*

Specifies an SQL identifier for the XML schema that is to be used for validation. The name, including the implicit or explicit SQL schema qualifier, must uniquely identify an existing XML schema in the XML schema repository at the current server. If no XML schema by this name exists in the implicitly or explicitly specified SQL schema, an error is returned (SQLSTATE 42704).

**URI** *XML-uri1*

Specifies the target namespace URI of the XML schema that is to be

used for validation. The value of *XML-uri1* specifies a URI as a character string constant that is not empty. The URI must be the target namespace of a registered XML schema (SQLSTATE 4274A) and, if no **LOCATION** clause is specified, it must uniquely identify the registered XML schema (SQLSTATE 4274B).

**NO NAMESPACE**

Specifies that the XML schema for validation has no target namespace. The target namespace URI is equivalent to an empty character string that cannot be specified as an explicit target namespace URI.

**LOCATION** *XML-uri2*

Specifies the XML schema location URI of the XML schema that is to be used for validation. The value of *XML-uri2* specifies a URI as a character string constant that is not empty. The XML schema location URI, combined with the target namespace URI, must identify a registered XML schema (SQLSTATE 4274A), and there must be only one such XML schema registered (SQLSTATE 4274B).

**XML-valid-element-clause**

Specifies that the XML value in *XML-expression* must have the specified element name as the root element of the XML document.

**NAMESPACE** *XML-uri3* or **NO NAMESPACE**

Specifies the target namespace for the element that is to be validated. If neither clause is specified, the specified element is assumed to be in the same namespace as the target namespace of the registered XML schema that is to be used for validation.

**NAMESPACE** *XML-uri3*

Specifies the namespace URI for the element that is to be validated. The value of *XML-uri3* specifies a URI as a character string constant that is not empty. This can be used when the registered XML schema that is to be used for validation has more than one namespace.

**NO NAMESPACE**

Specifies that the element for validation has no target namespace. The target namespace URI is equivalent to an empty character string which cannot be specified as an explicit target namespace URI.

**ELEMENT** *xml-element-name*

Specifies the name of a global element in the XML schema that is to be used for validation. The specified element, with implicit or explicit namespace, must match the root element of the value of *XML-expression* (SQLSTATE 22535 or 22536).

The data type of the result is XML. If the value of *XML-expression* can be null, the result can be null; if the value of *XML-expression* is null, the result is the null value.

The XML validation process is performed on a serialized XML value. Because XMLVALIDATE is invoked with an argument of type XML, this value is automatically serialized prior to validation processing with the follow two exceptions.

- If the argument to XMLVALIDATE is an XML host variable or an implicitly or explicitly typed parameter marker, then a validating parse operation is performed on the input value (no implicit non-validating parse is performed and CURRENT IMPLICIT XMLPARSE OPTION setting is not considered).



- If the argument to XMLVALIDATE is an XMLPARSE invocation using the option PRESERVE WHITESPACE, then the XML parsing and XML validation of the document may be combined into a single validating parse operation.

If an XML value has previously been validated, the annotated type information from the previous validation is removed by the serialization process. However, any default values and entity expansions from the previous validation remain unchanged. If validation is successful, all ignorable whitespace characters are stripped from the result.

To validate a document whose root element does not have a namespace, an xsi:noNamespaceSchemaLocation attribute must be present on the root element.

#### Notes:

1. **Support in non-Unicode databases and multiple database partition databases:** XMLVALIDATE is not supported (SQLSTATE 42997).
2. **Determining the XML schema:** The XML schema can be specified explicitly as part of XMLVALIDATE invocation, or determined from the XML schema information in the input XML value. If the XML schema information is not specified during invocation, the target namespace and the schema location in the input XML value are used to identify the registered schema for validation. If an explicit XML schema is not specified, the input XML value must contain an XML schema information hint (SQLSTATE 2200M). Explicit or implicit XML schema information must identify a registered XML schema (SQLSTATE 42704, 4274A, or 22532), and there must be only one such registered XML schema (SQLSTATE 4274B or 22533).
3. **XML schema authorization:** The XML schema used for validation must be registered in the XML schema repository prior to use. The privileges held by the authorization ID of the statement must include at least one of the following:
  - USAGE privilege on the XML schema that is to be used during validation
  - SYSADM or DBADM authority

#### Examples:

- Validate using the XML schema identified by the XML schema hint in the XML instance document.

```
INSERT INTO T1(XMLCOL)
VALUES (XMLVALIDATE(?))
```

Assume that the input parameter marker is bound to an XML value that contains the XML schema information.

```
<po:order
  xmlns:po='http://my.world.com'
  xmlns:xsi="http://www.w3.org/2001/XMLSchema-instance"
  xsi:schemaLocation="http://my.world.com/world.xsd" >
...
</po:order>
```

Further, assume that the XML schema that is associated with the target namespace "http://my.world.com" and by schemaLocation hint "http://my.world.com/world.xsd" is found in the XML schema repository.

Based on these assumptions, the input XML value will be validated and the type annotated according to that XML schema.

- Validate using the XML schema identified by the SQL name PODOCS.WORLDPO.

```

INSERT INTO T1(XMLCOL)
VALUES (
  XMLVALIDATE(
    ? ACCORDING TO XMLSCHEMA ID PODOCS.WORLDPO
  )
)

```

Assuming that the XML schema that is associated with SQL name FOO.WORLDPO is found in the XML repository, the input XML value will be validated and the type annotated according to that XML schema.

- Validate a specified element of the XML value.

```

INSERT INTO T1(XMLCOL)
VALUES (
  XMLVALIDATE(
    ? ACCORDING TO XMLSCHEMA ID FOO.WORLDPO
    NAMESPACE 'http://my.world.com/Mary'
    ELEMENT "po"
  )
)

```

Assuming that the XML schema that is associated with SQL name FOO.WORLDPO is found in the XML repository, the XML schema will be validated against the element "po", whose namespace is 'http://my.world.com/Mary'.

- XML schema is identified by target namespace and schema location.

```

INSERT INTO T1(XMLCOL)
VALUES (
  XMLVALIDATE(
    ? ACCORDING TO XMLSCHEMA URI 'http://my.world.com'
    LOCATION 'http://my.world.com/world.xsd'
  )
)

```

Assuming that an XML schema associated with the target namespace "http://my.world.com" and by schemaLocation hint "http://my.world.com/world.xsd" is found in the XML schema repository, the input XML value will be validated and the type annotated according to that schema.

#### Related concepts:

- "XML validation" in *XML Guide*

#### Related reference:

- "XMLATTRIBUTES " on page 449
- "XMLCOMMENT " on page 451
- "XMLCONCAT " on page 452
- "XMLDOCUMENT " on page 454
- "XMLELEMENT " on page 456
- "XMLFOREST " on page 462
- "XMLNAMESPACES " on page 466
- "XMLPARSE " on page 469
- "XMLPI " on page 471
- "XMLQUERY " on page 473
- "XMLSERIALIZE " on page 476
- "XMLTEXT " on page 479
- "XMLAGG " on page 271

---

## XMLXSROBJECTID

►►—XMLXSROBJECTID—(—*xml-value-expression*—)—————►►

The schema is SYSIBM.

The XMLXSROBJECTID function returns the XSR object identifier of the XML schema used to validate the XML document specified in the argument. The XSR object identifier is returned as a BIGINT value and provides the key to a single row in SYSCAT.XSROBJECTS.

### *xml-value-expression*

Specifies an expression that results in a value with a data type of XML. The resulting XML value must be an XML sequence with a single item that is an XML document or the null value (SQLSTATE 42815). If the argument is null, the function returns null. If *xml-value-expression* does not specify a validated XML document, the function returns 0.

### Notes:

1. **Support in non-Unicode databases and multiple database partition databases:** XMLXSROBJECTID is not supported (SQLSTATE 42997).
2. The XML schema corresponding to an XSR object ID returned by the function might no longer exist, because an XML schema can be dropped without affecting XML values that were validated using the XML schema. Therefore, queries that use the XSR object ID to fetch further XML schema information from the catalog views might return an empty result set.
3. Applications can use the XSR object identifier to retrieve additional information about the XML schema. For example, the XSR object identifier can be used to return the individual XML schema documents that make up a registered XML schema from SYSCAT.SYSXSROBJECTCOMPONENTS, and the hierarchy of XML schema documents in the XML schema from SYSCAT.XSROBJECTHIERARCHIES.

### Examples:

- Retrieve the XML schema identifier for the XML document XMLDOC stored in the table MYTABLE.

```
SELECT XMLXSROBJECTID(XMLDOC) FROM MYTABLE
```

- Retrieve the XML schema documents associated with the XML document that has a specific ID (in this case where DOCKEY = 1) in the table MYTABLE, including the hierarchy of the XML schema documents that make up the XML schema.

```
SELECT H.HTYPE, C.TARGETNAMESPACE, C.COMPONENT
FROM SYSCAT.XSROBJECTCOMPONENTS C, SYSCAT.XSROBJECTHIERARCHIES H
WHERE C.OBJECTID =
  (SELECT XMLXSROBJECTID(XMLDOC) FROM MYTABLE
   WHERE DOCKEY = 1)
AND C.OBJECTID = H.XSROBJECTID
```

---

**YEAR**

►►—YEAR—(—*expression*—)—————►►

The schema is SYSIBM.

The YEAR function returns the year part of a value.

The argument must be a date, timestamp, date duration, timestamp duration, or a valid character string representation of a date or timestamp that is neither a CLOB nor a LONG VARCHAR. In a Unicode database, if a supplied argument is a graphic string, it is first converted to a character string before the function is executed.

The result of the function is a large integer. If the argument can be null, the result can be null; if the argument is null, the result is the null value.

The other rules depend on the data type of the argument specified:

- If the argument is a date, timestamp, or valid string representation of a date or timestamp:
  - The result is the year part of the value, which is an integer between 1 and 9 999.
- If the argument is a date duration or timestamp duration:
  - The result is the year part of the value, which is an integer between –9 999 and 9 999. A nonzero result has the same sign as the argument.

Examples:

- Select all the projects in the PROJECT table that are scheduled to start (PRSTDATE) and end (PRENDATE) in the same calendar year.

```
SELECT * FROM PROJECT
WHERE YEAR(PRSTDATE) = YEAR(PRENDATE)
```
- Select all the projects in the PROJECT table that are scheduled to take less than one year to complete.

```
SELECT * FROM PROJECT
WHERE YEAR(PRENDATE - PRSTDATE) < 1
```

---

## Table functions

A table function can be used only in the FROM clause of a statement. Table functions return columns of a table, resembling a table created through a simple CREATE TABLE statement. Table functions can be qualified with a schema name.

## XMLTABLE

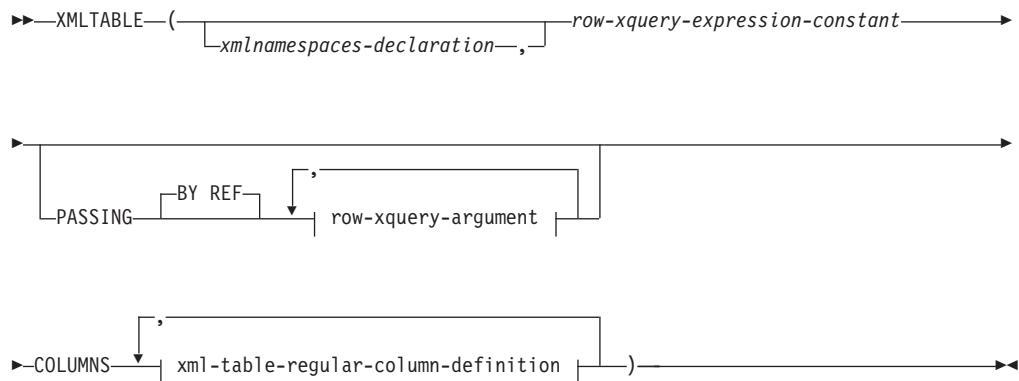
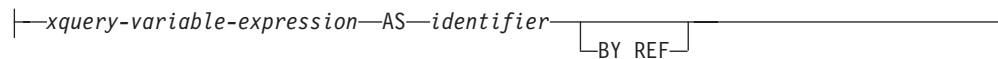
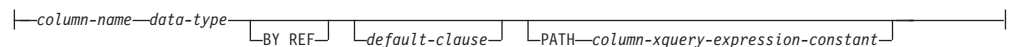
**row-xquery-argument:****xml-table-regular-column-definition:**

The schema is SYSIBM. The function name cannot be specified as a qualified name.

The XMLTABLE function returns a result table from the evaluation of XQuery expressions, possibly using specified input arguments as XQuery variables. Each sequence item in the result sequence of the row XQuery expression represents a row of the result table.

*xmlnamespaces-declaration*

Specifies one or more XML namespace declarations that become part of the static context of the *row-xquery-expression-constant* and the *column-xquery-expression-constant*. The set of statically known namespaces for XQuery expressions which are arguments of XMLTABLE is the combination of the pre-established set of statically known namespaces and the namespace declarations specified in this clause. The XQuery prolog within an XQuery expression may override these namespaces.

If *xmlnamespaces-declaration* is not specified, only the pre-established set of statically known namespaces apply to the the XQuery expressions.

*row-xquery-expression-constant*

Specifies an SQL character string constant that is interpreted as an XQuery expression using supported XQuery language syntax. The constant string is converted directly to UTF-8 without conversion to the database or section code page. The XQuery expression executes using an optional set of input XML values, and returns an output XQuery sequence where a row is generated for each item in the sequence. The value for *row-xquery-expression-constant* must not be an empty string or a string of all blanks (SQLSTATE 10505).

**PASSING**

Specifies input values and the manner in which these values are passed to the XQuery expression specified by *row-xquery-expression-constant*.

**BY REF**

Specifies that any XML input arguments are, by default, passed by reference. When XML values are passed by reference, the XQuery evaluation uses the input node trees, if any, directly from the specified input expressions, preserving all properties, including the original node identities and document order. If two arguments pass the same XML value, node identity comparisons and document ordering comparisons involving some nodes contained between the two input arguments might refer to nodes within the same XML node tree.

This clause has no impact on how non-XML values are passed. The non-XML values create a new copy of the value during the cast to XML.

**row-xquery-argument**

Specifies an argument that is to be passed to the XQuery expression specified by *row-xquery-expression-constant*. An argument specifies a value and the manner in which that value is to be passed. The argument includes an SQL expression that is evaluated before passing the result to the XQuery expression.

- If the resulting value is of type XML, it becomes an *input-xml-value*. A null XML value is converted to an XML empty sequence.
- If the resulting value is not of type XML, it must be castable to the XML data type. A null value is converted to an XML empty sequence. The converted value becomes an *input-xml-value*.

When the *row-xquery-expression-constant* is evaluated, an XQuery variable is presented with a value equal to *input-xml-value* and a name specified by the AS clause.

*xquery-variable-expression*

Specifies an SQL expression whose value is available to the XQuery expression specified by *row-xquery-expression-constant* during execution. The expression cannot contain a NEXT VALUE expression, PREVIOUS VALUE expression (SQLSTATE 428F9), or an OLAP function (SQLSTATE 42903).

**AS identifier**

Specifies that the value generated by *xquery-variable-expression* will be passed to *row-xquery-expression-constant* as an XQuery variable. The variable name will be *identifier*. The leading dollar sign (\$) that precedes variable names in the XQuery language is not included in *identifier*. The identifier must be a valid XQuery variable name and is restricted to an XML NCName. The identifier must not be greater than 128 bytes in length. Two arguments within the same PASSING clause cannot use the same identifier (SQLSTATE 42711).

**BY REF**

Indicates that an XML input value is to be passed by reference. When XML values are passed by reference, the XQuery evaluation uses the input node trees, if any, directly from the specified input expressions, preserving all properties, including the original node identities and document order. If two arguments pass the same XML value, node identity comparisons and document ordering comparisons involving some nodes contained between the two input arguments might refer to nodes within the same XML node tree. If BY REF is not specified following an *xquery-expression-variable*, XML arguments are passed by way of the default passing mechanism that is provided through the syntax that follows the PASSING keyword. This option cannot be

specified for non-XML values (SQLSTATE 42636). When a non-XML value is passed, the value is converted to XML; this process creates a copy.

**COLUMNS** *xml-table-regular-column-definition*

Specifies the output columns of the result table including the column name, data type, XML passing mechanism and an XQuery expression to extract the value from the sequence item for the row.

*column-name*

Specifies the name of the column in the result table. The name cannot be qualified and the same name cannot be used for more than one column of the table (SQLSTATE 42711).

*data-type*

Specifies the data type of the column. See CREATE TABLE for the syntax and a description of types available. A *data-type* may be used in XMLTable if there is a supported XMLCAST from the XML data type to the specified *data-type*.

**BY REF**

Specifies that XML values are returned by reference for columns of data type XML. By default, XML values are returned BY REF. When XML values are returned by reference, the XML value includes the input node trees, if any, directly from the result values, and preserves all properties, including the original node identities and document order. This option cannot be specified for non-XML columns (SQLSTATE 42636). When a non-XML column is processed, the value is converted from XML; this process creates a copy.

*default-clause*

Specifies a default value for the column. See CREATE TABLE for the syntax and a description of the *default-clause*. For XMLTABLE result columns, the default is applied when the processing the XQuery expression contained in *column-xquery-expression-constant* returns an empty sequence.

**PATH** *column-xquery-expression-constant*

Specifies an SQL character string constant that is interpreted as an XQuery expression using supported XQuery language syntax. The constant string is converted directly to UTF-8 without conversion to the database or section code page. The *column-xquery-expression-constant* specifies an XQuery expression that determines the column value with respect to an item that is the result of evaluating the XQuery expression in *row-xquery-expression-constant*. Given an item from the result of processing the *row-xquery-expression-constant* as the externally provided context item, the *column-xquery-expression-constant* is evaluated, returning an output sequence. The column value is determined based on this output sequence as follows.

- If the output sequence contains zero items, the *default-clause* provides the value of the column.
- If an empty sequence is returned and no *default-clause* was specified, a null value is assigned to the column.
- If a non-empty sequence is returned, the value is XMLCAST to the *data-type* specified for the column. An error could be returned from processing this XMLCAST.

The value for *column-xquery-expression-constant* must not be an empty string or a string of all blanks (SQLSTATE 10505). If this clause is not specified, the default XQuery expression is simply the *column-name*.



If the evaluation of any of the XQuery expressions results in an error, then the XMLTABLE function returns the XQuery error (SQLSTATE class '10').

**Notes:**

1. **Support in non-Unicode databases and multiple database partition databases:**  
XMLTABLE is not supported (SQLSTATE 42997).

**Examples:**

- List as a table result the purchase order items for orders with a status of 'NEW'.

```

SELECT U."PO ID", U."Part #", U."Product Name",
       U."Quantity", U."Price", U."Order Date"
FROM PURCHASEORDER P,
     XMLTABLE(XMLNAMESPACES('http://podemo.org' AS "pod"),
              '$po/PurchaseOrder/itemlist/item' PASSING P.PORDER AS "po"
              COLUMNS "PO ID"          INTEGER          PATH '../@POid',
                       "Part #"        CHAR(6)          PATH 'product/@pid',
                       "Product Name"  CHAR(50)         PATH 'product/pod:name',
                       "Quantity"      INTEGER          PATH 'quantity',
                       "Price"         DECIMAL(9,2)      PATH 'product/pod:price',
                       "Order Date"    TIMESTAMP        PATH '../dateTime'
              ) AS U
WHERE P.STATUS = 'NEW'

```

**Related concepts:**

- "XMLTABLE overview" in *XML Guide*

## User-defined functions

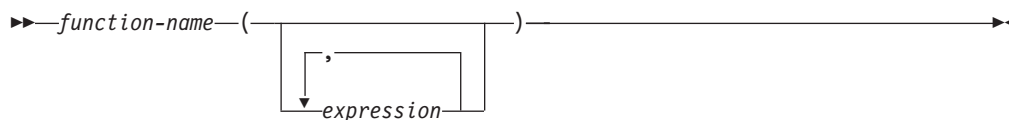

*User-defined functions (UDFs)* are extensions or additions to the existing built-in functions of the SQL language. A user-defined function can be a scalar function, which returns a single value each time it is called; a column function, which is passed a set of like values and returns a single value for the set; a row function, which returns one row; or a table function, which returns a table.

A number of user-defined functions are provided in the SYSFUN and SYSPROC schemas.

A UDF can be a column function only if it is sourced on an existing column function. A UDF is referenced by means of a qualified or unqualified function name, followed by parentheses enclosing the function arguments (if any). A user-defined column or scalar function registered with the database can be referenced in the same contexts in which any built-in function can appear. A user-defined row function can be referenced only implicitly when registered as a transform function for a user-defined type. A user-defined table function registered with the database can be referenced only in the FROM clause of a SELECT statement.

Function arguments must correspond in number and position to the parameters specified for the user-defined function when it was registered with the database. In addition, the arguments must be of data types that are promotable to the data types of the corresponding defined parameters.

The result of the function is specified in the RETURNS clause. The RETURNS clause, defined when the UDF was registered, determines whether or not a function is a table function. If the RETURNS NULL ON NULL INPUT clause is specified (or defaulted to) when the function is registered, the result is null if any argument is null. In the case of table functions, this is interpreted to mean a return table with no rows (that is, an empty table).

Following are some examples of user-defined functions:

- A scalar UDF called ADDRESS extracts the home address from resumes stored in script format. The ADDRESS function expects a CLOB argument and returns a VARCHAR(4000) value:

```
SELECT EMPNO, ADDRESS(RESUME) FROM EMP_RESUME
WHERE RESUME_FORMAT = 'SCRIPT'
```

- Table T2 has a numeric column A. Invoking the scalar UDF called ADDRESS from the previous example:

```
SELECT ADDRESS(A) FROM T2
```

raises an error (SQLSTATE 42884), because no function with a matching name and with a parameter that is promotable from the argument exists.

- A table UDF called WHO returns information about the sessions on the server machine that were active at the time that the statement is executed. The WHO function is invoked from within a FROM clause that includes the keyword

TABLE and a mandatory correlation variable. The column names of the WHO() table were defined in the CREATE FUNCTION statement.

```
SELECT ID, START_DATE, ORIG_MACHINE
FROM TABLE( WHO() ) AS QQ
WHERE START_DATE LIKE 'MAY%'
```

**Related reference:**

- “Subselect” on page 506
- “CREATE FUNCTION statement” in *SQL Reference, Volume 2*

## User-defined functions

---

## Chapter 4. Procedures

---

### Procedures overview

A procedure is an application program that can be started through the SQL CALL statement. The procedure is specified by a procedure name, which may be followed by arguments that are enclosed within parentheses.

The argument or arguments of a procedure are individual scalar values, which can be of different types and can have different meanings. The arguments can be used to pass values into the procedure, receive return values from the procedure, or both.

User-defined procedures are procedures that are registered to a database in SYSCAT.ROUTINES, using the CREATE PROCEDURE statement. One such set of functions is provided with the database manager, in a schema called SYSFUN, and another in a schema called SYSPROC.

Procedures can be qualified with the schema name.

---

## XSR\_ADDSCHEMADOC procedure

```

▶▶ XSR_ADDSCHEMADOC ( ( rschema , name , schemalocation , content ,
▶ docproperty )

```

The schema is SYSPROC.

Each XML schema in the XML schema repository (XSR) can consist of one or more XML schema documents. Where an XML schema consists of multiple documents, the XSR\_ADDSCHEMADOC stored procedure is used to add every XML schema other than the primary XML schema document.

### Authorization:

The user ID of the caller of the procedure must be the owner of the XSR object as recorded in the catalog view SYSCAT.XSROBJECTS.

#### *rschema*

An input argument of type VARCHAR (128) that specifies the SQL schema for the XML schema. The SQL schema is one part of the SQL identifier used to identify this XML schema in the XSR, which is to be moved to the complete state. (The other part of the SQL identifier is supplied by the name argument.) This argument can have a NULL value, which indicates that the default SQL schema, as defined in the CURRENT SCHEMA special register, is used. Rules for valid characters and delimiters that apply to any SQL identifier also apply to this argument. XSR objects will not experience name collisions with database objects that exist outside of the XSR, because XSR objects occur in a different namespace than objects outside of the XML schema repository.

#### *name*

An input argument of type VARCHAR (128) that specifies the name of the XML schema. The complete SQL identifier for the XML schema is *rschema.name*. The XML schema name must already exist as a result of calling the XSR\_REGISTER stored procedure, and XML schema registration cannot yet be completed. This argument cannot have a NULL value. Rules for valid characters and delimiters that apply to any SQL identifier also apply to this argument.

#### *schemalocation*

An input argument of type VARCHAR (1000), which can have a NULL value, that indicates the schema location of the primary XML schema document to which the XML schema document is being added. This argument is the external name of the XML schema, that is, the primary document can be identified in the XML instance documents with the xsi:schemaLocation attribute.

#### *content*

An input parameter of type BLOB (30M) that contains the content of the XML schema document being added. This argument cannot have a NULL value; an XML schema document must be supplied.

#### *docproperty*

An input parameter of type BLOB (5M) that indicates the properties for the XML schema document being added. This parameter can have a NULL value; otherwise, the value is an XML document.

Example:

```
CALL SYSPROC.XSR_ADDSCHEMADOC(  
  'user1',  
  'POschema',  
  'http://myPOschema/address.xsd',  
  :content_host_var,  
  0)
```

---

## XSR\_COMPLETE procedure

```

▶▶XSR_COMPLETE(—(—rschema—,—name—,—schemaproperties—,——————▶
▶—isusedfordecomposition—)—————▶▶

```

The schema is SYSPROC.

The XSR\_COMPLETE procedure is the final stored procedure to be called as part of the XML schema registration process, which registers XML schemas with the XML schema repository (XSR). An XML schema is not available for validation until the schema registration completes through a call to this stored procedure.

### Authorization::

The user ID of the caller of the procedure must be the owner of the XSR object as recorded in the catalog view SYSCAT.XSROBJECTS.

#### *rschema*

An input argument of type VARCHAR (128) that specifies the SQL schema for the XML schema. The SQL schema is one part of the SQL identifier used to identify this XML schema in the XSR, which is to be moved to the complete state. (The other part of the SQL identifier is supplied by the name argument.) This argument can have a NULL value, which indicates that the default SQL schema, as defined in the CURRENT SCHEMA special register, is used. Rules for valid characters and delimiters that apply to any SQL identifier also apply to this argument. XSR objects will not experience name collisions with database objects that exist outside of the XSR, because XSR objects occur in a different namespace than objects outside of the XML schema repository.

#### *name*

An input argument of type VARCHAR (128) that specifies the name of the XML schema. The complete SQL identifier for the XML schema, for which a completion check is to be performed, is *rschema.name*. The XML schema name must already exist as a result of calling the XSR\_REGISTER stored procedure, and XML schema registration cannot yet be completed. This argument cannot have a NULL value. Rules for valid characters and delimiters that apply to any SQL identifier also apply to this argument.

#### *schemaproperties*

An input argument of type BLOB (5M) that specifies properties, if any, associated with the XML schema. The value for this argument is either NULL, if there are no associated properties, or an XML document representing the properties for the XML schema.

#### *isusedfordecomposition*

An input parameter of type integer that indicates if an XML schema is to be used for decomposition. If an XML schema is to be used for decomposition, this value should be set to 1; otherwise, it should be set to zero.

### Example:

```

CALL SYSPROC.XSR_COMPLETE(
  'user1',
  'P0schema',
  :schemaproperty_host_var,
  0)

```



## XSR\_DTD procedure

►► XSR\_DTD (—*rschema*—, —*name*—, —*systemid*—, —*publicid*—, —*content*—) ►►

The schema is SYSPROC.

The XSR\_DTD procedure registers a document type declaration (DTD) with the XML schema repository (XSR).

### Authorization:

The user ID of the caller of the procedure must have at least one of the following:

- SYSADM or DBADM authority.
- IMPLICIT\_SCHEMA database authority if the SQL schema does not exist.
- CREATEIN privilege if the SQL schema exists.

### *rschema*

An input argument of type VARCHAR (128) that specifies the SQL schema for the DTD. The SQL schema is one part of the SQL identifier used to identify this DTD in the XSR. (The other part of the SQL identifier is supplied by the *name* argument.) This argument can have a NULL value, which indicates that the default SQL schema, as defined in the CURRENT SCHEMA special register, is used. Rules for valid characters and delimiters that apply to any SQL identifier also apply to this argument. Relational schemas that begin with the string 'SYS' must not be used for this value. XSR objects will not experience name collisions with database objects that exist outside of the XSR, because XSR objects occur in a different namespace than objects outside of the XML schema repository.

### *name*

An input and output argument of type VARCHAR (128) that specifies the name of the DTD. The complete SQL identifier for the DTD is *rschema.name* and should be unique among all objects in the XSR. This argument accepts a NULL value. When a NULL value is provided for this argument, a unique value is generated and stored within the XSR. Rules for valid characters and delimiters that apply to any SQL identifier also apply to this argument.

### *systemid*

An input parameter of type VARCHAR (1000) that specifies the system identifier of the DTD. The system ID of the DTD should match the uniform resource identifier of the DTD in the DOCTYPE declaration of the XML instance document or in an ENTITY declaration (as prefixed by the SYSTEM keyword, if used). This argument cannot have a NULL value. The system ID can be specified together with a public ID.

### *publicid*

An input parameter of type VARCHAR (1000) that specifies the public identifier of the DTD. The public ID of a DTD should match the uniform resource identifier of the DTD in the DOCTYPE declaration of the XML instance document or in an ENTITY declaration (as prefixed by the PUBLIC keyword, if used). This argument accepts a NULL value and should be used only if also specified in the DOCTYPE declaration of the XML instance document or in an ENTITY declaration.

## XSR\_DTD

### *content*

An input parameter of type BLOB (30M) that contains the content of the DTD document. This argument cannot have a NULL value.

Example: Register the DTD identified by the system ID *http://www.test.com/person.dtd* and public ID *http://www.test.com/person*:

```
CALL SYSPROC.XSR_DTD ( 'MYDEPT' ,  
    'PERSONDTD' ,  
    'http://www.test.com/person.dtd' ,  
    'http://www.test.com/person' ,  
    :content_host_variable  
)
```

### **Related concepts:**

- “Registering XSR objects through stored procedures” in *XML Guide*
- “XML schema, DTD, and external entity management using the XML schema repository (XSR)” in *XML Guide*

## XSR\_EXTENTITY procedure

```

▶▶XSR_EXTENTITY—(—rschema—,—name—,—systemid—,—publicid—,——————▶
▶—content—)—————▶▶

```

The schema is SYSPROC.

The XSR\_EXTENTITY procedure registers an external entity with the XML schema repository (XSR).

### Authorization:

The user ID of the caller of the procedure must have at least one of the following:

- SYSADM or DBADM authority.
- IMPLICIT\_SCHEMA database authority if the SQL schema does not exist.
- CREATEIN privilege if the SQL schema exists.

### *rschema*

An input argument of type VARCHAR (128) that specifies the SQL schema for the external entity. The SQL schema is one part of the SQL identifier used to identify this external entity in the XSR. (The other part of the SQL identifier is supplied by the *name* argument.) This argument can have a NULL value, which indicates that the default SQL schema, as defined in the CURRENT SCHEMA special register, is used. Rules for valid characters and delimiters that apply to any SQL identifier also apply to this argument. Relational schemas that begin with the string 'SYS' must not be used for this value. XSR objects will not experience name collisions with database objects that exist outside of the XSR, because XSR objects occur in a different namespace than objects outside of the XML schema repository.

### *name*

An input and output argument of type VARCHAR (128) that specifies the name of the external entity. The complete SQL identifier for the external entity is *rschema.name* and should be unique among all objects in the XSR. This argument accepts a NULL value. When a NULL value is provided for this argument, a unique value is generated and stored within the XSR. Rules for valid characters and delimiters that apply to any SQL identifier also apply to this argument.

### *systemid*

An input parameter of type VARCHAR (1000) that specifies the system identifier of the external entity. The system ID of the external entity should match the uniform resource identifier of the external entity in the ENTITY declaration (as prefixed by the SYSTEM keyword, if used). This argument cannot have a NULL value. The system ID can be specified together with a public ID.

### *publicid*

An input parameter of type VARCHAR (1000) that specifies the public identifier of the external entity. The public ID of a external entity should match the uniform resource identifier of the external entity in the ENTITY declaration (as prefixed by the PUBLIC keyword, if used). This argument accepts a NULL value and should be used only if also specified in the DOCTYPE declaration of the XML instance document or in an ENTITY declaration.

## XSR\_EXTENTITY

### *content*

An input parameter of type BLOB (30M) that contains the content of the external entity document. This argument cannot have a NULL value.

Example: Register the external entities identified by the system identifiers *http://www.test.com/food/chocolate.txt* and *http://www.test.com/food/cookie.txt*:

```
CALL SYSPROC.XSR_EXTENTITY ( 'FOOD' ,
    'CHOCOLATE' ,
    'http://www.test.com/food/chocolate.txt' ,
    NULL ,
    :content_of_chocolate.txt_as_a_host_variable
)
```

```
CALL SYSPROC.XSR_EXTENTITY ( 'FOOD' ,
    'COOKIE' ,
    'http://www.test.com/food/cookie.txt' ,
    NULL ,
    :content_of_cookie.txt_as_a_host_variable
)
```

### **Related concepts:**

- “Registering XSR objects through stored procedures” in *XML Guide*
- “XML schema, DTD, and external entity management using the XML schema repository (XSR)” in *XML Guide*

## XSR\_REGISTER procedure

```

▶▶ XSR_REGISTER(—rschema—,—name—,—schemalocation—,—content—,—
▶ docproperty—)

```

The schema is SYSPROC.

The XSR\_REGISTER procedure is the first stored procedure to be called as part of the XML schema registration process, which registers XML schemas with the XML schema repository (XSR).

### Authorization:

The user ID of the caller of the procedure must have at least one of the following:

- SYSADM or DBADM authority.
- IMPLICIT\_SCHEMA database authority if the SQL schema does not exist.
- CREATEIN privilege if the SQL schema exists.

### *rschema*

An input argument of type VARCHAR (128) that specifies the SQL schema for the XML schema. The SQL schema is one part of the SQL identifier used to identify this XML schema in the XSR. (The other part of the SQL identifier is supplied by the name argument.) This argument can have a NULL value, which indicates that the default SQL schema, as defined in the CURRENT SCHEMA special register, is used. Rules for valid characters and delimiters that apply to any SQL identifier also apply to this argument. Relational schemas that begin with the string 'SYS' must not be used for this value. XSR objects will not experience name collisions with database objects that exist outside of the XSR, because XSR objects occur in a different namespace than objects outside of the XML schema repository.

### *name*

An input and output argument of type VARCHAR (128) that specifies the name of the XML schema. The complete SQL identifier for the XML schema is *rschema.name* and should be unique among all objects in the XSR. This argument accepts a NULL value. When a NULL value is provided for this argument, a unique value is generated and stored within the XSR. Rules for valid characters and delimiters that apply to any SQL identifier also apply to this argument.

### *schemalocation*

An input argument of type VARCHAR (1000), which can have a NULL value, that indicates the schema location of the primary XML schema document. This argument is the external name of the XML schema, that is, the primary document can be identified in the XML instance documents with the xsi:schemaLocation attribute.

### *content*

An input parameter of type BLOB (30M) that contains the content of the primary XML schema document. This argument cannot have a NULL value; an XML schema document must be supplied.

### *docproperty*

An input parameter of type BLOB (5M) that indicates the properties for the

## XSR\_REGISTER

primary XML schema document. This parameter can have a NULL value; otherwise, the value is an XML document.

Example:

```
CALL SYSPROC.XSR_REGISTER(  
  'user1',  
  'POschema',  
  'http://myPOschema/PO.xsd',  
  :content_host_var,  
  :docproperty_host_var)
```

---

## Chapter 5. Queries

---

### SQL queries

A *query* specifies a result table. A query is a component of certain SQL statements. The three forms of a query are:

- subselect
- fullselect
- select-statement.

#### Authorization

For each table, view, or nickname referenced in the query, the authorization ID of the statement must have at least one of the following:

- SYSADM or DBADM authority
- CONTROL privilege
- SELECT privilege.

Group privileges, with the exception of PUBLIC, are not checked for queries that are contained in static SQL statements.

For nicknames, authorization requirements of the data source for the object referenced by the nickname are applied when the query is processed. The authorization ID of the statement may be mapped to a different authorization ID at the data source.

#### Related reference:

- “SELECT INTO statement” in *SQL Reference, Volume 2*

---

## Subselect

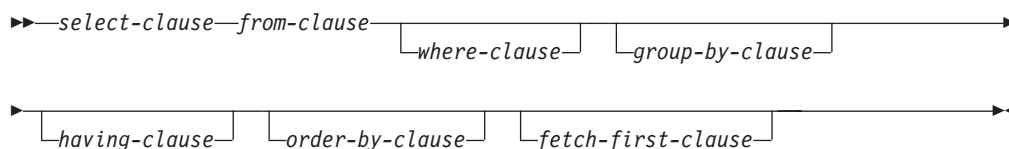

The *subselect* is a component of the *fullselect*.

A subselect specifies a result table derived from the tables, views or nicknames identified in the FROM clause. The derivation can be described as a sequence of operations in which the result of each operation is input for the next. (This is only a way of describing the subselect. The method used to perform the derivation can be quite different from this description. If portions of the subselect do not actually need to be executed for the correct result to be obtained, they might or might not be executed.)

The clauses of the subselect are processed in the following sequence:

1. FROM clause
2. WHERE clause
3. GROUP BY clause
4. HAVING clause
5. SELECT clause
6. ORDER BY clause
7. FETCH FIRST clause

A subselect that contains an ORDER BY or FETCH FIRST clause cannot be specified:

- In the outermost fullselect of a view.
- In a materialized query table.
- Unless the subselect is enclosed in parenthesis.

For example, the following is not valid (SQLSTATE 428FJ):

```
SELECT * FROM T1
  ORDER BY C1
UNION
SELECT * FROM T2
  ORDER BY C1
```

The following example *is* valid:

```
(SELECT * FROM T1
  ORDER BY C1)
UNION
(SELECT * FROM T2
  ORDER BY C1)
```

**Note:** An ORDER BY clause in a subselect does not affect the order of the rows returned by a query. An ORDER BY clause only affects the order of the rows returned if it is specified in the outermost fullselect.



## select-clause

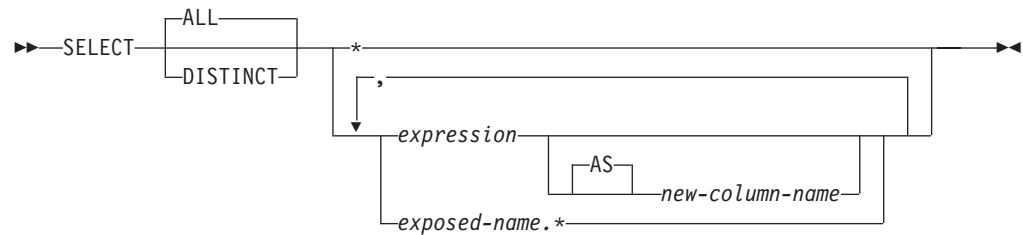

The SELECT clause specifies the columns of the final result table. The column values are produced by the application of the *select list* to R. The select list is the names or expressions specified in the SELECT clause, and R is the result of the previous operation of the subselect. For example, if the only clauses specified are SELECT, FROM, and WHERE, R is the result of that WHERE clause.

**ALL**

Retains all rows of the final result table, and does not eliminate redundant duplicates. This is the default.

**DISTINCT**

Eliminates all but one of each set of duplicate rows of the final result table. If DISTINCT is used, no string column of the result table can be a LONG VARCHAR, LONG VARGRAPHIC, DATALINK, LOB type, distinct type on any of these types, or structured type. DISTINCT may be used more than once in a subselect. This includes SELECT DISTINCT, the use of DISTINCT in a column function of the select list or HAVING clause, and subqueries of the subselect.

Two rows are duplicates of one another only if each value in the first is equal to the corresponding value of the second. For determining duplicates, two null values are considered equal.

**Select list notation:**

- \* Represents a list of names that identify the columns of table R. The first name in the list identifies the first column of R, the second name identifies the second column of R, and so on.

The list of names is established when the program containing the SELECT clause is bound. Hence \* (the asterisk) does not identify any columns that have been added to a table after the statement containing the table reference has been bound.

*expression*

Specifies the values of a result column. Can be any expression that is a valid SQL language element, but commonly includes column names. Each column name used in the select list must unambiguously identify a column of R.

*new-column-name* or **AS** *new-column-name*

Names or renames the result column. The name must not be qualified and does not have to be unique. Subsequent usage of column-name is limited as follows:

- A new-column-name specified in the AS clause can be used in the order-by-clause, provided the name is unique.

## Select list notation:

- A new-column-name specified in the AS clause of the select list cannot be used in any other clause within the subselect (where-clause, group-by-clause or having-clause).
- A new-column-name specified in the AS clause cannot be used in the update-clause.
- A new-column-name specified in the AS clause is known outside the fullselect of nested table expressions, common table expressions and CREATE VIEW.

*name.\**

Represents the list of names that identify the columns of the result table identified by *exposed-name*. The *exposed-name* may be a table name, view name, nickname, or correlation name, and must designate a table, view or nickname named in the FROM clause. The first name in the list identifies the first column of the table, view or nickname, the second name in the list identifies the second column of the table, view or nickname, and so on.

The list of names is established when the statement containing the SELECT clause is bound. Therefore, \* does not identify any columns that have been added to a table after the statement has been bound.

The number of columns in the result of SELECT is the same as the number of expressions in the operational form of the select list (that is, the list established when the statement is prepared), and cannot exceed 500 for a 4K page size or 1012 for an 8K, 16K, or 32K page size.

### Limitations on string columns

For limitations on the select list, see “Restrictions Using Varying-Length Character Strings”.

### Applying the select list

Some of the results of applying the select list to R depend on whether or not GROUP BY or HAVING is used. The results are described in two separate lists:

#### If GROUP BY or HAVING is used:

- An expression *X* (not a column function) used in the select list must have a GROUP BY clause with:
  - a *grouping-expression* in which each column-name unambiguously identifies a column of R (see “group-by-clause” on page 521) or
  - each column of R referenced in *X* as a separate *grouping-expression*.
- The select list is applied to each group of R, and the result contains as many rows as there are groups in R. When the select list is applied to a group of R, that group is the source of the arguments of the column functions in the select list.

#### If neither GROUP BY nor HAVING is used:

- Either the select list must not include any column functions, or each *column-name* in the select list must be specified within a column function or must be a correlated column reference.
- If the select does not include column functions, then the select list is applied to each row of R and the result contains as many rows as there are rows in R.
- If the select list is a list of column functions, then R is the source of the arguments of the functions and the result of applying the select list is one row.

In either case the *n*th column of the result contains the values specified by applying the *n*th expression in the operational form of the select list.

**Null attributes of result columns:** Result columns do not allow null values if they are derived from:

- A column that does not allow null values
- A constant
- The COUNT or COUNT\_BIG function
- A host variable that does not have an indicator variable
- A scalar function or expression that does not include an operand that allows nulls

Result columns allow null values if they are derived from:

- Any column function except COUNT or COUNT\_BIG
- A column that allows null values
- A scalar function or expression that includes an operand that allows nulls
- A NULLIF function with arguments containing equal values
- A host variable that has an indicator variable
- A result of a set operation if at least one of the corresponding items in the select list is nullable
- An arithmetic expression or view column that is derived from an arithmetic expression and the database is configured with DFT\_SQLMATHWARN set to Yes
- A scalar subselect
- A dereference operation

**Names of result columns:**

- If the AS clause is specified, the name of the result column is the name specified on the AS clause.
- If the AS clause is not specified and the result column is derived from a column, then the result column name is the unqualified name of that column.
- If the AS clause is not specified and the result column is derived using a dereference operation, then the result column name is the unqualified name of the target column of the dereference operation.
- All other result column names are unnamed. The system assigns temporary numbers (as character strings) to these columns.

**Data types of result columns:** Each column of the result of SELECT acquires a data type from the expression from which it is derived.

| When the expression is ...                  | The data type of the result column is ...   |
|---|---|
| the name of any numeric column              | the same as the data type of the column, with the same precision and scale for DECIMAL columns.     |
| an integer constant                         | INTEGER.  |
| a decimal constant                          | DECIMAL, with the precision and scale of the constant.  |
| a floating-point constant                   | DOUBLE.   |
| the name of any numeric variable            | the same as the data type of the variable, with the same precision and scale for DECIMAL variables. |
| a hexadecimal constant representing n bytes | VARCHAR(n); the code page is the database code page.  |

## Data types of result columns

| When the expression is ...                     | The data type of the result column is ...   |
|--|---|
| the name of any string column                  | the same as the data type of the column, with the same length attribute.  |
| the name of any string variable                | the same as the data type of the variable, with the same length attribute; if the data type of the variable is not identical to an SQL data type (for example, a NUL-terminated string in C), the result column is a varying-length string. |
| a character string constant of length <i>n</i> | VARCHAR( <i>n</i> ).  |
| a graphic string constant of length <i>n</i>   | VARGRAPHIC( <i>n</i> ).   |
| the name of a datetime column                  | the same as the data type of the column.  |
| the name of a user-defined type column         | the same as the data type of the column.  |
| the name of a reference type column            | the same as the data type of the column.  |

## from-clause



The FROM clause specifies an intermediate result table.

If one table-reference is specified, the intermediate result table is simply the result of that table-reference. If more than one table-reference is specified, the intermediate result table consists of all possible combinations of the rows of the specified table-references (the Cartesian product). Each row of the result is a row from the first table-reference concatenated with a row from the second table-reference, concatenated in turn with a row from the third, and so on. The number of rows in the result is the product of the number of rows in all the individual table-references. For a description of *table-reference*, see “table-reference.”

## table-reference

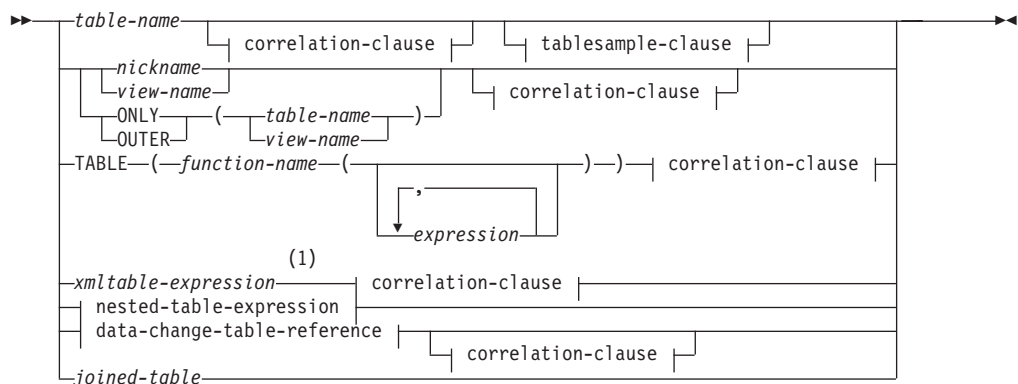

**correlation-clause:**

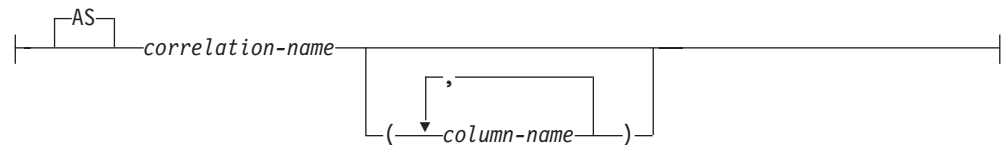
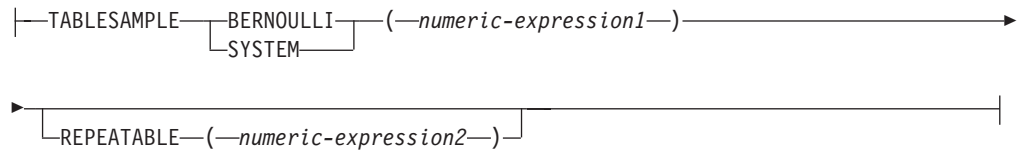
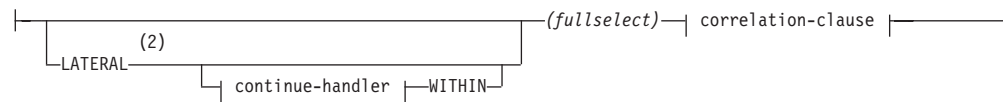
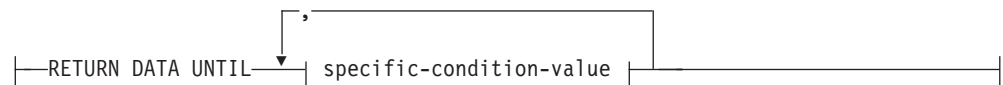
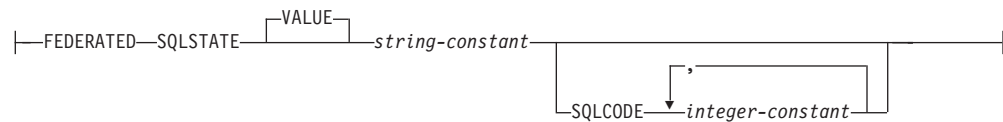
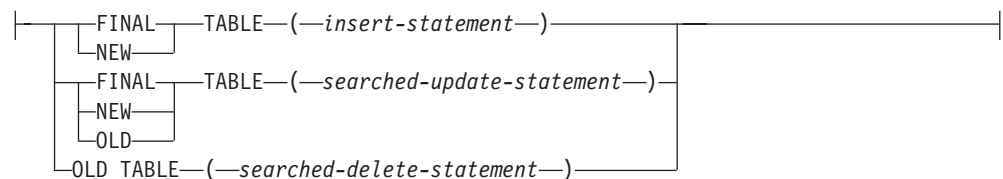
**tablesample-clause:****nested-table-expression:****continue-handler:****specific-condition-value:****data-change-table-reference:****Notes:**

- 1 An XMLTABLE expression can be part of a table-reference. In this case, subexpressions within the XMLTABLE expression are in-scope of prior range variables in the FROM clause. For more information, see the description of "XMLTABLE".
- 2 TABLE can be specified in place of LATERAL.

Each *table-name*, *view-name* or *nickname* specified as a table-reference must identify an existing table, view or nickname at the application server or the *table-name* of a common table expression defined preceding the fullselect containing the

table-reference. If the *table-name* references a typed table, the name denotes the UNION ALL of the table with all its subtables, with only the columns of the *table-name*. Similarly, if the *view-name* references a typed view, the name denotes the UNION ALL of the view with all its subviews, with only the columns of the *view-name*.

The use of ONLY(*table-name*) or ONLY(*view-name*) means that the rows of the proper subtables or subviews are not included. If the *table-name* used with ONLY does not have subtables, then ONLY(*table-name*) is equivalent to specifying *table-name*. If the *view-name* used with ONLY does not have subviews, then ONLY(*view-name*) is equivalent to specifying *view-name*.

The use of OUTER(*table-name*) or OUTER(*view-name*) represents a virtual table. If the *table-name* or *view-name* used with OUTER does not have subtables or subviews, then specifying OUTER is equivalent to not specifying OUTER. OUTER(*table-name*) is derived from *table-name* as follows:

- The columns include the columns of *table-name* followed by the additional columns introduced by each of its subtables (if any). The additional columns are added on the right, traversing the subtable hierarchy in depth-first order. Subtables that have a common parent are traversed in creation order of their types.
- The rows include all the rows of *table-name* and all the rows of its subtables. Null values are returned for columns that are not in the subtable for the row.

The previous points also apply to OUTER(*view-name*), substituting *view-name* for *table-name* and subview for subtable.

The use of ONLY or OUTER requires the SELECT privilege on every subtable of *table-name* or subview of *view-name*.

Each *function-name* together with the types of its arguments, specified as a table reference must resolve to an existing table function at the application server.

A fullselect in parentheses followed by a correlation name is called a *nested table expression*.

A *joined-table* specifies an intermediate result set that is the result of one or more join operations. For more information, see “joined-table” on page 518.

The exposed names of all table references should be unique. An exposed name is:

- A *correlation-name*,
- A *table-name* that is not followed by a *correlation-name*,
- A *view-name* that is not followed by a *correlation-name*,
- A *nickname* that is not followed by a *correlation-name*,
- An *alias-name* that is not followed by a *correlation-name*.

Each *correlation-name* is defined as a designator of the immediately preceding *table-name*, *view-name*, *nickname*, *function-name* reference or nested table expression. Any qualified reference to a column for a table, view, table function or nested table expression must use the exposed name. If the same table name, view or nickname name is specified twice, at least one specification should be followed by a *correlation-name*. The *correlation-name* is used to qualify references to the columns of the table, view or nickname. When a *correlation-name* is specified, *column-names* can

also be specified to give names to the columns of the *table-name*, *view-name*, *nickname*, *function-name* reference or nested table expression.

In general, table functions and nested table expressions can be specified on any from-clause. Columns from the table functions and nested table expressions can be referenced in the select list and in the rest of the subselect using the correlation name which must be specified. The scope of this correlation name is the same as correlation names for other table, view or nickname in the FROM clause. A nested table expression can be used:

- In place of a view to avoid creating the view (when general use of the view is not required)
- When the desired result table is based on host variables

An expression in the select list of a nested table expression that is referenced within, or is the target of, a data change statement within a fullselect is only valid when it does not include:

- A function that reads or modifies SQL data
- A function that is non-deterministic
- A function that has external action
- An OLAP function

If a view is referenced directly in, or as the target of a nested table expression in a data change statement within a FROM clause, the view must either be symmetric (have WITH CHECK OPTION specified) or satisfy the restriction for a WITH CHECK OPTION view.

If the target of a data change statement within a FROM clause is a nested table expression, the modified rows are not requalified, WHERE clause predicates are not re-evaluated, and ORDER BY or FETCH FIRST operations are not redone.

The optional *tablesample-clause* can be used to obtain a random subset (a sample) of the rows from the specified *table-name*, rather than the entire contents of that *table-name*, for this query. This sampling is in addition to any predicates that are specified in the *where-clause*. Unless the optional REPEATABLE clause is specified, each execution of the query will usually yield a different sample, except in degenerate cases where the table is so small relative to the sample size that any sample must return the same rows. The size of the sample is controlled by the *numeric-expression1* in parentheses, representing an approximate percentage (P) of the table to be returned. The method by which the sample is obtained is specified after the TABLESAMPLE keyword, and can be either BERNOULLI or SYSTEM. For both methods, the exact number of rows in the sample may be different for each execution of the query, but on average should be approximately P percent of the table, before any predicates further reduce the number of rows.

The *table-name* must be a stored table. It can be a materialized query table (MQT) name, but not a subselect or table expression for which an MQT has been defined, because there is no guarantee that the database manager will route to the MQT for that subselect.

Semantically, sampling of a table occurs before any other query processing, such as applying predicates or performing joins. Repeated accesses of a sampled table within a single execution of a query (such as in a nested-loop join or a correlated subquery) will return the same sample. More than one table may be sampled in a query.

BERNOULLI sampling considers each row individually. It includes each row in the sample with probability  $P/100$  (where  $P$  is the value of *numeric-expression1*), and excludes each row with probability  $1 - P/100$ , independently of the other rows. So if the *numeric-expression1* evaluated to the value 10, representing a ten percent sample, each row would be included with probability 0.1, and excluded with probability 0.9.

SYSTEM sampling permits the database manager to determine the most efficient manner in which to perform the sampling. In most cases, SYSTEM sampling applied to a *table-name* means that each page of *table-name* is included in the sample with probability  $P/100$ , and excluded with probability  $1 - P/100$ . All rows on each page that is included qualify for the sample. SYSTEM sampling of a *table-name* generally executes much faster than BERNOULLI sampling, because fewer data pages need to be retrieved; however, it can often yield less accurate estimates for aggregate functions (SUM(SALES), for example), especially if the rows of *table-name* are clustered on any columns referenced in that query. The optimizer may in certain circumstances decide that it is more efficient to perform SYSTEM sampling as if it were BERNOULLI sampling, for example when a predicate on *table-name* can be applied by an index and is much more selective than the sampling rate  $P$ .

The *numeric-expression1* specifies the size of the sample to be obtained from *table-name*, expressed as a percentage. It must be a constant numeric expression that cannot contain columns, parameter markers, or host variables. The expression must evaluate to a positive number that is less than or equal to 100, but can be between 1 and 0. For example, a value of 0.01 represents one one-hundredth of a percent, meaning that 1 row in 10 000 would be sampled, on average. A *numeric-expression1* that evaluates to 100 is handled as if the *tablesample-clause* were not specified. If *numeric-expression1* evaluates to the null value, or to a value that is greater than 100 or less than 0, an error is returned (SQLSTATE 2202H).

It is sometimes desirable for sampling to be repeatable from one execution of the query to the next; for example, during regression testing or query "debugging". This can be accomplished by specifying the REPEATABLE clause. The REPEATABLE clause requires the specification of a *numeric-expression2* in parentheses, which serves the same role as the seed in a random number generator. Adding the REPEATABLE clause to the *tablesample-clause* of any *table-name* ensures that repeated executions of that query (using the same value for *numeric-expression2*) return the same sample, assuming, of course, that the data itself has not been updated, reorganized, or repartitioned. To guarantee that the same sample of *table-name* is used across multiple queries, use of a global temporary table is recommended. Alternatively, the multiple queries could be combined into one query, with multiple references to a sample that is defined using the WITH clause.

Following are some examples:

*Example 1:* Request a 10% Bernoulli sample of the Sales table for auditing purposes.

```
SELECT * FROM Sales
TABLESAMPLE BERNOULLI(10)
```

*Example 2:* Compute the total sales revenue in the Northeast region for each product category, using a random 1% SYSTEM sample of the Sales table. The semantics of SUM are for the sample itself, so to extrapolate the sales to the entire Sales table, the query must divide that SUM by the sampling rate (0.01).



```

SELECT SUM(Sales.Revenue) / (0.01)
FROM Sales TABLESAMPLE SYSTEM(1)
WHERE Sales.RegionName = 'Northeast'
GROUP BY Sales.ProductCategory

```

*Example 3:* Using the REPEATABLE clause, modify the previous query to ensure that the same (yet random) result is obtained each time the query is executed. (The value of the constant enclosed by parentheses is arbitrary.)

```

SELECT SUM(Sales.Revenue) / (0.01)
FROM Sales TABLESAMPLE SYSTEM(1) REPEATABLE(3578231)
WHERE Sales.RegionName = 'Northeast'
GROUP BY Sales.ProductCategory

```

## Table function references

In general, a table function, together with its argument values, can be referenced in the FROM clause of a SELECT in exactly the same way as a table or view. There are, however, some special considerations which apply.

- Table Function Column Names

Unless alternate column names are provided following the *correlation-name*, the column names for the table function are those specified in the RETURNS clause of the CREATE FUNCTION statement. This is analogous to the names of the columns of a table, which are defined in the CREATE TABLE statement.

- Table Function Resolution

The arguments specified in a table function reference, together with the function name, are used by an algorithm called *function resolution* to determine the exact function to be used. This is no different from what happens with other functions (such as scalar functions) that are used in a statement.

- Table Function Arguments

As with scalar function arguments, table function arguments can in general be any valid SQL expression. The following examples are valid syntax:

Example 1: 

```

SELECT c1
FROM TABLE( tf1('Zachary') ) AS z
WHERE c2 = 'FLORIDA';

```

Example 2: 

```

SELECT c1
FROM TABLE( tf2 (:hostvar1, CURRENT DATE) ) AS z;

```

Example 3: 

```

SELECT c1
FROM t
WHERE c2 IN
      (SELECT c3 FROM
       TABLE( tf5(t.c4) ) AS z -- correlated reference
      ) -- to previous FROM clause

```

- Table Functions That Modify SQL Data

Table functions that are specified with the MODIFIES SQL DATA option can only be used as the last table reference in a *select-statement*, *common-table-expression*, or RETURN statement that is a subselect, a SELECT INTO, or a *row-fullselect* in a SET statement. Only one table function is allowed in one FROM clause, and the table function arguments must be correlated to all other table references in the subselect (SQLSTATE 429BL). The following examples have valid syntax for a table function with the MODIFIES SQL DATA property:

Example 1: 

```

SELECT c1
FROM TABLE( tfmod('Jones') ) AS z

```

Example 2: 

```

SELECT c1
FROM t1, t2, TABLE( tfmod(t1.c1, t2.c1) ) AS z

```

Example 3: 

```

SET var =

```

## Table function references

```
(SELECT c1  
FROM TABLE( tfmod('Jones') ) AS z
```

Example 4: **RETURN SELECT** c1  
**FROM TABLE( tfmod('Jones') ) AS z**

Example 5: **WITH** v1(c1) **AS**  
(**SELECT** c1  
**FROM TABLE( tfmod(:hostvar1) ) AS z**)  
**SELECT** c1  
**FROM** v1, t1 **WHERE** v1.c1 = t1.c1

### Error tolerant nested-table-expression

Certain errors that occur within a *nested-table-expression* can be tolerated, and instead of returning an error, the query can continue and return a result.

Specifying the RETURN DATA UNTIL clause will cause any rows that are returned from the fullselect before the indicated condition is encountered to make up the result set from the fullselect. This means that a partial result set (which could also be an empty result set) from the fullselect is acceptable as the result for the *nested-table-expression*.

The FEDERATED keyword restricts the condition to handle only errors that occur at a remote data source.

The condition can be specified as an SQLSTATE value, with a *string-constant* length of 5. You can optionally specify an SQLCODE value for each specified SQLSTATE value. For portable applications, specify SQLSTATE values as much as possible, because SQLCODE values are generally not portable across platforms and are not part of the SQL standard.

Only certain conditions can be tolerated. Errors that do not allow the rest of the query to be executed cannot be tolerated, and an error is returned for the whole query. The *specific-condition-value* might specify conditions that cannot actually be tolerated by the database manager, even if a specific SQLSTATE or SQLCODE value is specified, and for these cases, an error is returned.

The following SQLSTATE values and SQLCODE values have the potential, when specified, to be tolerated by the database manager:

- SQLSTATE 08001; SQLCODEs -1336, -30080, -30081, -30082
- SQLSTATE 08004
- SQLSTATE 42501
- SQLSTATE 42704; SQLCODE -204
- SQLSTATE 42720
- SQLSTATE 28000

A query or view containing an error tolerant *nested-table-expression* is read-only.

The fullselect of an error tolerant *nested-table-expression* is not optimized using materialized query tables.

### Correlated references in table-references

Correlated references can be used in nested table expressions or as arguments to table functions. The basic rule that applies for both these cases is that the correlated reference must be from a *table-reference* at a higher level in the hierarchy of subqueries. This hierarchy includes the table-references that have already been

## Correlated references in table-references

resolved in the left-to-right processing of the FROM clause. For nested table expressions, the TABLE keyword must appear before the fullselect. So the following examples are valid syntax:

```
Example 1: SELECT t.c1, z.c5
           FROM t, TABLE( tf3(t.c2) ) AS z      -- t precedes tf3
           WHERE t.c3 = z.c4;                  -- in FROM, so t.c2
                                           -- is known

Example 2: SELECT t.c1, z.c5
           FROM t, TABLE( tf4(2 * t.c2) ) AS z -- t precedes tf4
           WHERE t.c3 = z.c4;                  -- in FROM, so t.c2
                                           -- is known

Example 3: SELECT d.deptno, d.deptname,
           empinfo.avgsal, empinfo.empcount
           FROM department d,
           LATERAL (SELECT AVG(e.salary) AS avgsal,
                   COUNT(*) AS empcount
                   FROM employee e           -- department precedes
                   WHERE e.workdept=d.deptno -- and TABLE is
                   ) AS empinfo;             -- specified, so
                                           -- d.deptno is known
```

But the following examples are not valid:

```
Example 4: SELECT t.c1, z.c5
           FROM TABLE( tf6(t.c2) ) AS z, t    -- cannot resolve t in t.c2!
           WHERE t.c3 = z.c4;                  -- compare to Example 1 above.

Example 5: SELECT a.c1, b.c5
           FROM TABLE( tf7a(b.c2) ) AS a, TABLE( tf7b(a.c6) ) AS b
           WHERE a.c3 = b.c4;                  -- cannot resolve b in b.c2!

Example 6: SELECT d.deptno, d.deptname,
           empinfo.avgsal, empinfo.empcount
           FROM department d,
           (SELECT AVG(e.salary) AS avgsal,
            COUNT(*) AS empcount
            FROM employee e           -- department precedes
            WHERE e.workdept=d.deptno -- but TABLE is not
            ) AS empinfo;             -- specified, so
                                           -- d.deptno is unknown
```

## Data change table references

A *data-change-table-reference* clause specifies an intermediate result table. This table is based on the rows that are directly changed by the searched UPDATE, searched DELETE, or INSERT statement that is included in the clause. A *data-change-table-reference* can be specified as the only *table-reference* in the FROM clause of the outer fullselect that is used in a *select-statement*, a SELECT INTO statement, or a common table expression. A *data-change-table-reference* can be specified as the only table reference in the only fullselect in a SET Variable statement (SQLSTATE 428FL). The target table or view of the data change statement is considered to be a table or view that is referenced in the query; therefore, the authorization ID of the query must have SELECT privilege on that target table or view. A *data-change-table-reference* clause cannot be specified in a view definition, materialized query table definition, or FOR statement (SQLSTATE 428FL).

The target of the UPDATE, DELETE, or INSERT statement cannot be a temporary view defined in a common table expression (SQLSTATE 42807).

### FINAL TABLE

Specifies that the rows of the intermediate result table represent the set of rows

## Data change table references

that are changed by the SQL data change statement as they appear at the completion of the data change statement. If there are AFTER triggers or referential constraints that result in further operations on the table that is the target of the SQL data change statement, an error is returned (SQLSTATE 57058, SQLSTATE 560C6). If the target of the SQL data change statement is a view that is defined with an INSTEAD OF trigger for the type of data change, an error is returned (SQLSTATE 428G3).

### NEW TABLE

Specifies that the rows of the intermediate result table represent the set of rows that are changed by the SQL data change statement prior to the application of referential constraints and AFTER triggers. Data in the target table at the completion of the statement might not match the data in the intermediate result table because of additional processing for referential constraints and AFTER triggers.

### OLD TABLE

Specifies that the rows of the intermediate result table represent the set of rows that are changed by the SQL data change statement as they existed prior to the application of the data change statement.

*(searched-update-statement)*

Specifies a searched UPDATE statement. A WHERE clause or a SET clause in the UPDATE statement cannot contain correlated references to columns outside of the UPDATE statement.

*(searched-delete-statement)*

Specifies a searched DELETE statement. A WHERE clause in the DELETE statement cannot contain correlated references to columns outside of the DELETE statement.

*(insert-statement)*

Specifies an INSERT statement. A fullselect in the INSERT statement cannot contain correlated references to columns outside of the fullselect of the INSERT statement.

The content of the intermediate result table for a *data-change-table-reference* is determined when the cursor opens. The intermediate result table contains all manipulated rows, including all the columns in the specified target table or view. All the columns of the target table or view for an SQL data change statement are accessible using the column names from the target table or view. If an INCLUDE clause was specified within a data change statement, the intermediate result table will contain these additional columns.

## joined-table

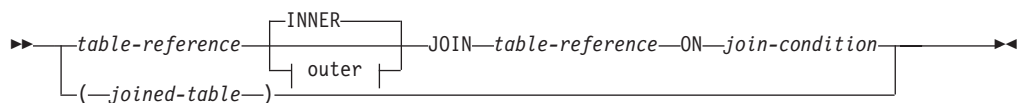

**outer:**



A *joined table* specifies an intermediate result table that is the result of either an inner join or an outer join. The table is derived by applying one of the join operators: INNER, LEFT OUTER, RIGHT OUTER, or FULL OUTER to its operands.

Inner joins can be thought of as the cross product of the tables (combine each row of the left table with every row of the right table), keeping only the rows where the join condition is true. The result table may be missing rows from either or both of the joined tables. Outer joins include the inner join and preserve these missing rows. There are three types of outer joins:

- *left outer join* includes rows from the left table that were missing from the inner join.
- *right outer join* includes rows from the right table that were missing from the inner join.
- *full outer join* includes rows from both the left and right tables that were missing from the inner join.

If a join-operator is not specified, INNER is implicit. The order in which multiple joins are performed can affect the result. Joins can be nested within other joins. The order of processing for joins is generally from left to right, but based on the position of the required join-condition. Parentheses are recommended to make the order of nested joins more readable. For example:

```
TB1 LEFT JOIN TB2 ON TB1.C1=TB2.C1
  RIGHT JOIN TB3 LEFT JOIN TB4 ON TB3.C1=TB4.C1
    ON TB1.C1=TB3.C1
```

is the same as:

```
(TB1 LEFT JOIN TB2 ON TB1.C1=TB2.C1)
  RIGHT JOIN (TB3 LEFT JOIN TB4 ON TB3.C1=TB4.C1)
    ON TB1.C1=TB3.C1
```

A joined table can be used in any context in which any form of the SELECT statement is used. A view or a cursor is read-only if its SELECT statement includes a joined table.

A *join-condition* is a *search-condition*, except that:

- It cannot contain any subqueries, scalar or otherwise
- It cannot include any dereference operations or the Deref function, where the reference value is other than the object identifier column
- It cannot include an SQL function
- Any column referenced in an expression of the *join-condition* must be a column of one of the operand tables of the associated join (in the scope of the same joined-table clause)
- Any function referenced in an expression of the *join-condition* of a full outer join must be deterministic and have no external action
- It cannot include an XMLQUERY or XMLEXISTS expression

An error occurs if the join condition does not comply with these rules (SQLSTATE 42972).

Column references are resolved using the rules for resolution of column name qualifiers. The same rules that apply to predicates apply to join conditions.

### Join operations

A *join-condition* specifies pairings of T1 and T2, where T1 and T2 are the left and right operand tables of the JOIN operator of the *join-condition*. For all possible combinations of rows of T1 and T2, a row of T1 is paired with a row of T2 if the *join-condition* is true. When a row of T1 is joined with a row of T2, a row in the result consists of the values of that row of T1 concatenated with the values of that row of T2. The execution might involve the generation of a null row. The null row of a table consists of a null value for each column of the table, regardless of whether the columns allow null values.

The following summarizes the result of the join operations:

- The result of T1 INNER JOIN T2 consists of their paired rows where the join-condition is true.
- The result of T1 LEFT OUTER JOIN T2 consists of their paired rows where the join-condition is true and, for each unpaired row of T1, the concatenation of that row with the null row of T2. All columns derived from T2 allow null values.
- The result of T1 RIGHT OUTER JOIN T2 consists of their paired rows where the join-condition is true and, for each unpaired row of T2, the concatenation of that row with the null row of T1. All columns derived from T1 allow null values.
- The result of T1 FULL OUTER JOIN T2 consists of their paired rows and, for each unpaired row of T2, the concatenation of that row with the null row of T1 and, for each unpaired row of T1, the concatenation of that row with the null row of T2. All columns derived from T1 and T2 allow null values.

### where-clause

►►—WHERE—*search-condition*—◄◄

The WHERE clause specifies an intermediate result table that consists of those rows of R for which the *search-condition* is true. R is the result of the FROM clause of the subselect.

The *search-condition* must conform to the following rules:

- Each *column-name* must unambiguously identify a column of R or be a correlated reference. A *column-name* is a correlated reference if it identifies a column of a *table-reference* in an outer subselect.
- A column function must not be specified unless the WHERE clause is specified in a subquery of a HAVING clause and the argument of the function is a correlated reference to a group.

Any subquery in the *search-condition* is effectively executed for each row of R, and the results are used in the application of the *search-condition* to the given row of R. A subquery is actually executed for each row of R only if it includes a correlated reference. In fact, a subquery with no correlated references may be executed just once, whereas a subquery with a correlated reference may have to be executed once for each row.

## group-by-clause

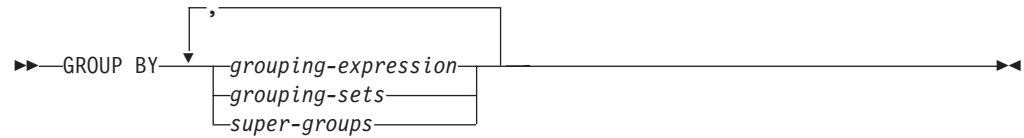

The GROUP BY clause specifies an intermediate result table that consists of a grouping of the rows of R. R is the result of the previous clause of the subselect.

In its simplest form, a GROUP BY clause contains a *grouping expression*. A grouping expression is an *expression* used in defining the grouping of R. Each *column name* included in grouping-expression must unambiguously identify a column of R (SQLSTATE 42702 or 42703). A grouping expression cannot include a scalar fullselect or an XMLQUERY or XMLEXISTS expression (SQLSTATE 42822), or any function that is variant or has an external action (SQLSTATE 42845).

More complex forms of the GROUP BY clause include *grouping-sets* and *super-groups*. For a description of these forms, see “grouping-sets” and “super-groups” on page 522, respectively.

The result of GROUP BY is a set of groups of rows. Each row in this result represents the set of rows for which the *grouping-expression* is equal. For grouping, all null values from a *grouping-expression* are considered equal.

A *grouping-expression* can be used in a search condition in a HAVING clause, in an expression in a SELECT clause or in a *sort-key-expression* of an ORDER BY clause (see “order-by-clause” on page 527 for details). In each case, the reference specifies only one value for each group. For example, if the *grouping-expression* is *col1+col2*, then an allowed expression in the select list would be *col1+col2+3*. Associativity rules for expressions would disallow the similar expression, *3+col1+col2*, unless parentheses are used to ensure that the corresponding expression is evaluated in the same order. Thus, *3+(col1+col2)* would also be allowed in the select list. If the concatenation operator is used, the *grouping-expression* must be used exactly as the expression was specified in the select list.

If the *grouping-expression* contains varying-length strings with trailing blanks, the values in the group can differ in the number of trailing blanks and may not all have the same length. In that case, a reference to the *grouping-expression* still specifies only one value for each group, but the value for a group is chosen arbitrarily from the available set of values. Thus, the actual length of the result value is unpredictable.

As noted, there are some cases where the GROUP BY clause cannot refer directly to a column that is specified in the SELECT clause as an expression (scalar-fullselect, variant or external action functions). To group using such an expression, use a nested table expression or a common table expression to first provide a result table with the expression as a column of the result. For an example using nested table expressions, see “Example A9” on page 532.

### grouping-sets

## grouping-sets

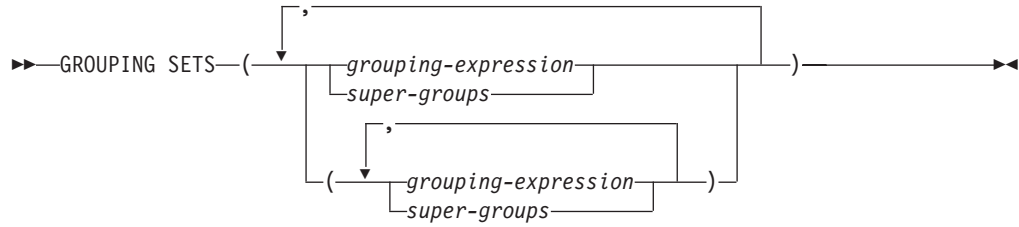

A *grouping-sets* specification allows multiple grouping clauses to be specified in a single statement. This can be thought of as the union of two or more groups of rows into a single result set. It is logically equivalent to the union of multiple subselects with the group by clause in each subselect corresponding to one grouping set. A grouping set can be a single element or can be a list of elements delimited by parentheses, where an element is either a grouping-expression or a super-group. Using *grouping-sets* allows the groups to be computed with a single pass over the base table.

The *grouping-sets* specification allows either a simple *grouping-expression* to be used, or the more complex forms of *super-groups*. For a description of *super-groups*, see “super-groups.”

Note that grouping sets are the fundamental building blocks for GROUP BY operations. A simple GROUP BY with a single column can be considered a grouping set with one element. For example:

**GROUP BY a**

is the same as

**GROUP BY GROUPING SETS((a))**

and

**GROUP BY a,b,c**

is the same as

**GROUP BY GROUPING SETS((a,b,c))**

Non-aggregation columns from the select list of the subselect that are excluded from a grouping set will return a null for such columns for each row generated for that grouping set. This reflects the fact that aggregation was done without considering the values for those columns.

“Example C2” on page 535 through “Example C7” on page 539 illustrate the use of grouping sets.

## super-groups

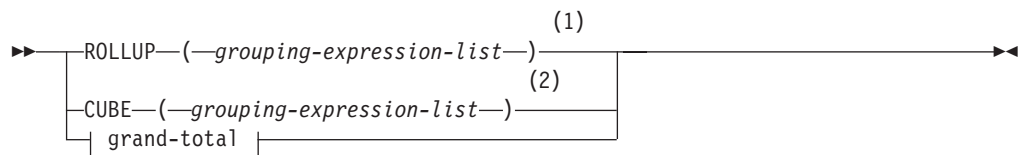

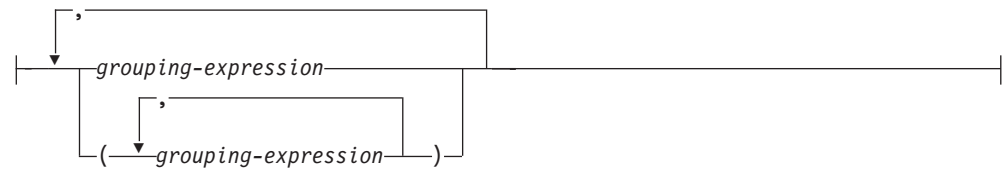

**grouping-expression-list:****grand-total:****Notes:**

- 1 Alternate specification when used alone in group-by-clause is:  
grouping-expression-list WITH ROLLUP.
- 2 Alternate specification when used alone in group-by-clause is:  
grouping-expression-list WITH CUBE.

**ROLLUP ( grouping-expression-list )**

A *ROLLUP grouping* is an extension to the GROUP BY clause that produces a result set containing *sub-total* rows in addition to the “regular” grouped rows. *Sub-total* rows are “super-aggregate” rows that contain further aggregates whose values are derived by applying the same column functions that were used to obtain the grouped rows. These rows are called sub-total rows, because that is their most common use; however, any column function can be used for the aggregation. For instance, MAX and AVG are used in “Example C8” on page 541.

A ROLLUP grouping is a series of *grouping-sets*. The general specification of a ROLLUP with  $n$  elements

**GROUP BY ROLLUP**( $C_1, C_2, \dots, C_{n-1}, C_n$ )

is equivalent to

**GROUP BY GROUPING SETS**(( $C_1, C_2, \dots, C_{n-1}, C_n$ )  
( $C_1, C_2, \dots, C_{n-1}$ )  
 $\dots$   
( $C_1, C_2$ )  
( $C_1$ )  
( ) )

Note that the  $n$  elements of the ROLLUP translate to  $n+1$  grouping sets. Note also that the order in which the *grouping-expressions* is specified is significant for ROLLUP. For example:

**GROUP BY ROLLUP**( $a, b$ )

is equivalent to

**GROUP BY GROUPING SETS**(( $a, b$ )  
( $a$ )  
( ) )

while

**GROUP BY ROLLUP**( $b, a$ )

is the same as

```
GROUP BY GROUPING SETS((b,a)
                        (b)
                        () )
```

The ORDER BY clause is the only way to guarantee the order of the rows in the result set. "Example C3" on page 536 illustrates the use of ROLLUP.

**CUBE** (*grouping-expression-list*)

A *CUBE grouping* is an extension to the GROUP BY clause that produces a result set that contains all the rows of a ROLLUP aggregation and, in addition, contains "cross-tabulation" rows. *Cross-tabulation* rows are additional "super-aggregate" rows that are not part of an aggregation with sub-totals.

Like a ROLLUP, a CUBE grouping can also be thought of as a series of *grouping-sets*. In the case of a CUBE, all permutations of the cubed *grouping-expression-list* are computed along with the grand total. Therefore, the *n* elements of a CUBE translate to  $2^{*n}$  (2 to the power *n*) *grouping-sets*. For instance, a specification of

```
GROUP BY CUBE(a,b,c)
```

is equivalent to

```
GROUP BY GROUPING SETS((a,b,c)
                        (a,b)
                        (a,c)
                        (b,c)
                        (a)
                        (b)
                        (c)
                        () )
```

Notice that the 3 elements of the CUBE translate to 8 grouping sets.

The order of specification of elements does not matter for CUBE. 'CUBE (DayOfYear, Sales\_Person)' and 'CUBE (Sales\_Person, DayOfYear)' yield the same result sets. The use of the word 'same' applies to content of the result set, not to its order. The ORDER BY clause is the only way to guarantee the order of the rows in the result set. "Example C4" on page 536 illustrates the use of CUBE.

*grouping-expression-list*

A *grouping-expression-list* is used within a CUBE or ROLLUP clause to define the number of elements in the CUBE or ROLLUP operation. This is controlled by using parentheses to delimit elements with multiple *grouping-expressions*.

The rules for a *grouping-expression* are described in "group-by-clause" on page 521. For example, suppose that a query is to return the total expenses for the ROLLUP of City within a Province but not within a County. However the clause:

```
GROUP BY ROLLUP(Province, County, City)
```

results in unwanted sub-total rows for the County. In the clause

```
GROUP BY ROLLUP(Province, (County, City))
```

the composite (County, City) forms one element in the ROLLUP and, therefore, a query that uses this clause will yield the desired result. In other words, the two element ROLLUP

```
GROUP BY ROLLUP(Province, (County, City))
```

generates

```
GROUP BY GROUPING SETS((Province, County, City)
                        (Province)
                        ( ) )
```

while the 3 element ROLLUP would generate

```
GROUP BY GROUPING SETS((Province, County, City)
                        (Province, County)
                        (Province)
                        ( ) )
```

“Example C2” on page 535 also utilizes composite column values.

### grand-total

Both CUBE and ROLLUP return a row which is the overall (grand total) aggregation. This may be separately specified with empty parentheses within the GROUPING SET clause. It may also be specified directly in the GROUP BY clause, although there is no effect on the result of the query. “Example C4” on page 536 uses the grand-total syntax.

### Combining grouping sets

This can be used to combine any of the types of GROUP BY clauses. When simple *grouping-expression* fields are combined with other groups, they are “appended” to the beginning of the resulting *grouping sets*. When ROLLUP or CUBE expressions are combined, they operate like “multipliers” on the remaining expression, forming additional grouping set entries according to the definition of either ROLLUP or CUBE.

For instance, combining *grouping-expression* elements acts as follows:

```
GROUP BY a, ROLLUP(b,c)
```

is equivalent to

```
GROUP BY GROUPING SETS((a,b,c)
                        (a,b)
                        (a) )
```

Or similarly,

```
GROUP BY a, b, ROLLUP(c,d)
```

is equivalent to

```
GROUP BY GROUPING SETS((a,b,c,d)
                        (a,b,c)
                        (a,b) )
```

Combining of *ROLLUP* elements acts as follows:

```
GROUP BY ROLLUP(a), ROLLUP(b,c)
```

is equivalent to

```
GROUP BY GROUPING SETS((a,b,c)
                        (a,b)
                        (a)
                        (b,c)
                        (b)
                        ( ) )
```

Similarly,

```
GROUP BY ROLLUP(a), CUBE(b,c)
```

is equivalent to

## Combining grouping sets

```
GROUP BY GROUPING SETS((a,b,c)
                        (a,b)
                        (a,c)
                        (a)
                        (b,c)
                        (b)
                        (c)
                        ( ) )
```

Combining of *CUBE* and *ROLLUP* elements acts as follows:

```
GROUP BY CUBE(a,b), ROLLUP(c,d)
```

is equivalent to

```
GROUP BY GROUPING SETS((a,b,c,d)
                        (a,b,c)
                        (a,b)
                        (a,c,d)
                        (a,c)
                        (a)
                        (b,c,d)
                        (b,c)
                        (b)
                        (c,d)
                        (c)
                        ( ) )
```

Like a simple *grouping-expression*, combining grouping sets also eliminates duplicates within each grouping set. For instance,

```
GROUP BY a, ROLLUP(a,b)
```

is equivalent to

```
GROUP BY GROUPING SETS((a,b)
                        (a) )
```

A more complete example of combining grouping sets is to construct a result set that eliminates certain rows that would be returned for a full *CUBE* aggregation.

For example, consider the following *GROUP BY* clause:

```
GROUP BY Region,
        ROLLUP(Sales_Person, WEEK(Sales_Date)),
        CUBE(YEAR(Sales_Date), MONTH (Sales_Date))
```

The column listed immediately to the right of *GROUP BY* is simply grouped, those within the parenthesis following *ROLLUP* are rolled up, and those within the parenthesis following *CUBE* are cubed. Thus, the above clause results in a cube of *MONTH* within *YEAR* which is then rolled up within *WEEK* within *Sales\_Person* within the *Region* aggregation. It does not result in any grand total row or any cross-tabulation rows on *Region*, *Sales\_Person* or *WEEK(Sales\_Date)* so produces fewer rows than the clause:

```
GROUP BY ROLLUP (Region, Sales_Person, WEEK(Sales_Date),
                YEAR(Sales_Date), MONTH(Sales_Date) )
```

## having-clause

►►—HAVING—*search-condition*—◄◄

The HAVING clause specifies an intermediate result table that consists of those groups of R for which the *search-condition* is true. R is the result of the previous clause of the subselect. If this clause is not GROUP BY, R is considered to be a single group with no grouping columns.

Each *column-name* in the search condition must do one of the following:

- Unambiguously identify a grouping column of R.
- Be specified within a column function.
- Be a correlated reference. A *column-name* is a correlated reference if it identifies a column of a *table-reference* in an outer subselect.

A group of R to which the search condition is applied supplies the argument for each column function in the search condition, except for any function whose argument is a correlated reference.

If the search condition contains a subquery, the subquery can be thought of as being executed each time the search condition is applied to a group of R, and the results used in applying the search condition. In actuality, the subquery is executed for each group only if it contains a correlated reference. For an illustration of the difference, see “Example A6” on page 531 and “Example A7” on page 531.

A correlated reference to a group of R must either identify a grouping column or be contained within a column function.

When HAVING is used without GROUP BY, the select list can only be a column name within a column function, a correlated column reference, a literal, or a special register.

## order-by-clause

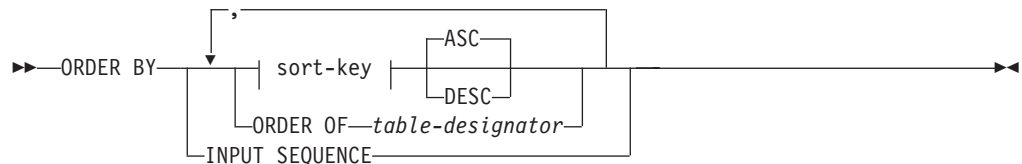

### sort-key:



The ORDER BY clause specifies an ordering of the rows of the result table. If a single sort specification (one *sort-key* with associated direction) is identified, the rows are ordered by the values of that sort specification. If more than one sort specification is identified, the rows are ordered by the values of the first identified sort specification, then by the values of the second identified sort specification, and so on. Each *sort-key* cannot have a data type of LONG VARCHAR, CLOB, LONG VARGRAPHIC, DBCLOB, BLOB, DATALINK, distinct type on any of these types, or structured type (SQLSTATE 42907).

A named column in the select list may be identified by a *sort-key* that is a *simple-integer* or a *simple-column-name*. An unnamed column in the select list must

## order-by-clause

be identified by an *simple-integer* or, in some cases, by a *sort-key-expression* that matches the expression in the select list (see details of *sort-key-expression*). A column is unnamed if the AS clause is not specified and it is derived from a constant, an expression with operators, or a function.

Ordering is performed in accordance with comparison rules. The null value is higher than all other values. If the ORDER BY clause does not completely order the rows, rows with duplicate values of all identified columns are displayed in an arbitrary order.

### *simple-column-name*

Usually identifies a column of the result table. In this case, *simple-column-name* must be the column name of a named column in the select list.

The *simple-column-name* may also identify a column name of a table, view, or nested table identified in the FROM clause if the query is a subselect. An error occurs if the subselect:

- Specifies DISTINCT in the select-clause (SQLSTATE 42822)
- Produces a grouped result and the *simple-column-name* is not a *grouping-expression* (SQLSTATE 42803).

Determining which column is used for ordering the result is described under “Column names in sort keys” below.

### *simple-integer*

Must be greater than 0 and not greater than the number of columns in the result table (SQLSTATE 42805). The integer *n* identifies the *n*th column of the result table.

### *sort-key-expression*

An expression that is not simply a column name or an unsigned integer constant. The query to which ordering is applied must be a *subselect* to use this form of sort-key. The *sort-key-expression* cannot include a correlated scalar fullselect (SQLSTATE 42703), an XMLQUERY or XMLEXISTS expression (SQLSTATE 42822), or a function with an external action (SQLSTATE 42845).

Any column-name within a *sort-key-expression* must conform to the rules described under “Column names in sort keys” below.

There are a number of special cases that further restrict the expressions that can be specified.

- DISTINCT is specified in the SELECT clause of the subselect (SQLSTATE 42822).

The sort-key-expression must match exactly with an expression in the select list of the subselect (scalar-fullselects are never matched).

- The subselect is grouped (SQLSTATE 42803).

The sort-key-expression can:

- be an expression in the select list of the subselect,
- include a *grouping-expression* from the GROUP BY clause of the subselect
- include a column function, constant or host variable.

### ASC

Uses the values of the column in ascending order. This is the default.

### DESC

Uses the values of the column in descending order.

**ORDER OF *table-designator***

Specifies that the same ordering used in *table-designator* should be applied to the result table of the subselect. There must be a table reference matching *table-designator* in the FROM clause of the subselect that specifies this clause (SQLSTATE 42703). The subselect (or fullselect) corresponding to the specified *table-designator* must include an ORDER BY clause that is dependant on the data (SQLSTATE 428FI). The ordering that is applied is the same as if the columns of the ORDER BY clause in the nested subselect (or fullselect) were included in the outer subselect (or fullselect), and these columns were specified in place of the ORDER OF clause.

Note that this form is not allowed in a fullselect (other than the degenerative form of a fullselect). For example, the following is not valid:

```
(SELECT C1 FROM T1
   ORDER BY C1)
UNION
SELECT C1 FROM T2
   ORDER BY ORDER OF T1
```

The following example *is* valid:

```
SELECT C1 FROM
  (SELECT C1 FROM T1
   UNION
   SELECT C1 FROM T2
   ORDER BY C1 ) AS UTABLE
ORDER BY ORDER OF UTABLE
```

**INPUT SEQUENCE**

Specifies that, for an INSERT statement, the result table will reflect the input order of ordered data rows. INPUT SEQUENCE ordering can only be specified if an INSERT statement is used in a FROM clause (SQLSTATE 428G4). See “table-reference” on page 510. If INPUT SEQUENCE is specified and the input data is not ordered, the INPUT SEQUENCE clause is ignored.

**Notes:**

- **Column names in sort keys:**

- The column name is qualified.

The query must be a *subselect* (SQLSTATE 42877). The column name must unambiguously identify a column of some table, view or nested table in the FROM clause of the subselect (SQLSTATE 42702). The value of the column is used to compute the value of the sort specification.

- The column name is unqualified.

- The query is a subselect.

If the column name is identical to the name of more than one column of the result table, the column name must unambiguously identify a column of some table, view or nested table in the FROM clause of the ordering subselect (SQLSTATE 42702). If the column name is identical to one column, that column is used to compute the value of the sort specification. If the column name is not identical to a column of the result table, then it must unambiguously identify a column of some table, view or nested table in the FROM clause of the fullselect in the select-statement (SQLSTATE 42702).

- The query is not a subselect (it includes set operations such as union, except or intersect).

The column name must not be identical to the name of more than one column of the result table (SQLSTATE 42702). The column name must be

## order-by-clause

identical to exactly one column of the result table (SQLSTATE 42707), and this column is used to compute the value of the sort specification.

- **Limits:** The use of a *sort-key-expression* or a *simple-column-name* where the column is not in the select list may result in the addition of the column or expression to the temporary table used for sorting. This may result in reaching the limit of the number of columns in a table or the limit on the size of a row in a table. Exceeding these limits will result in an error if a temporary table is required to perform the sorting operation.

## fetch-first-clause

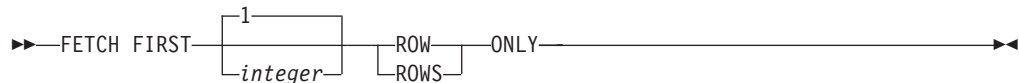

The *fetch-first-clause* sets a maximum number of rows that can be retrieved. It lets the database manager know that the application does not want to retrieve more than *integer* rows, regardless of how many rows there might be in the result table when this clause is not specified. An attempt to fetch beyond *integer* rows is handled the same way as normal end of data (SQLSTATE 02000). The value of *integer* must be a positive integer (not zero).

Limiting the result table to the first *integer* rows can improve performance. The database manager will cease processing the query once it has determined the first *integer* rows. If both the *fetch-first-clause* and the *optimize-for-clause* are specified, the lower of the *integer* values from these clauses is used to influence the communications buffer size. The values are considered independently for optimization purposes.

If the fullselect contains an SQL data change statement in the FROM clause, all the rows are modified regardless of the limit on the number of rows to fetch.

## Examples of subselects

*Example A1:* Select all columns and rows from the EMPLOYEE table.

```
SELECT * FROM EMPLOYEE
```

*Example A2:* Join the EMP\_ACT and EMPLOYEE tables, select all the columns from the EMP\_ACT table and add the employee's surname (LASTNAME) from the EMPLOYEE table to each row of the result.

```
SELECT EMP_ACT.*, LASTNAME
FROM EMP_ACT, EMPLOYEE
WHERE EMP_ACT.EMPNO = EMPLOYEE.EMPNO
```

*Example A3:* Join the EMPLOYEE and DEPARTMENT tables, select the employee number (EMPNO), employee surname (LASTNAME), department number (WORKDEPT in the EMPLOYEE table and DEPTNO in the DEPARTMENT table) and department name (DEPTNAME) of all employees who were born (BIRTHDATE) earlier than 1930.

```
SELECT EMPNO, LASTNAME, WORKDEPT, DEPTNAME
FROM EMPLOYEE, DEPARTMENT
WHERE WORKDEPT = DEPTNO
AND YEAR(BIRTHDATE) < 1930
```



*Example A4:* Select the job (JOB) and the minimum and maximum salaries (SALARY) for each group of rows with the same job code in the EMPLOYEE table, but only for groups with more than one row and with a maximum salary greater than or equal to 27000.

```
SELECT JOB, MIN(SALARY), MAX(SALARY)
FROM EMPLOYEE
GROUP BY JOB
HAVING COUNT(*) > 1
AND MAX(SALARY) >= 27000
```

*Example A5:* Select all the rows of EMP\_ACT table for employees (EMPNO) in department (WORKDEPT) 'E11'. (Employee department numbers are shown in the EMPLOYEE table.)

```
SELECT *
FROM EMP_ACT
WHERE EMPNO IN
    (SELECT EMPNO
     FROM EMPLOYEE
     WHERE WORKDEPT = 'E11')
```

*Example A6:* From the EMPLOYEE table, select the department number (WORKDEPT) and maximum departmental salary (SALARY) for all departments whose maximum salary is less than the average salary for all employees.

```
SELECT WORKDEPT, MAX(SALARY)
FROM EMPLOYEE
GROUP BY WORKDEPT
HAVING MAX(SALARY) < (SELECT AVG(SALARY)
                     FROM EMPLOYEE)
```

The subquery in the HAVING clause would only be executed once in this example.

*Example A7:* Using the EMPLOYEE table, select the department number (WORKDEPT) and maximum departmental salary (SALARY) for all departments whose maximum salary is less than the average salary in all other departments.

```
SELECT WORKDEPT, MAX(SALARY)
FROM EMPLOYEE EMP_COR
GROUP BY WORKDEPT
HAVING MAX(SALARY) < (SELECT AVG(SALARY)
                     FROM EMPLOYEE
                     WHERE NOT WORKDEPT = EMP_COR.WORKDEPT)
```

In contrast to "Example A6," the subquery in the HAVING clause would need to be executed for each group.

*Example A8:* Determine the employee number and salary of sales representatives along with the average salary and head count of their departments.

This query must first create a nested table expression (DINFO) in order to get the AVGSALARY and EMPCOUNT columns, as well as the DEPTNO column that is used in the WHERE clause.

```
SELECT THIS_EMP.EMPNO, THIS_EMP.SALARY, DINFO.AVGSALARY, DINFO.EMPCOUNT
FROM EMPLOYEE THIS_EMP,
    (SELECT OTHERS.WORKDEPT AS DEPTNO,
      AVG(OTHERS.SALARY) AS AVGSALARY,
      COUNT(*) AS EMPCOUNT
     FROM EMPLOYEE OTHERS
     GROUP BY OTHERS.WORKDEPT
    ) AS DINFO
WHERE THIS_EMP.JOB = 'SALESREP'
AND THIS_EMP.WORKDEPT = DINFO.DEPTNO
```

## Examples of subselects

Using a nested table expression for this case saves the overhead of creating the DINFO view as a regular view. During statement preparation, accessing the catalog for the view is avoided and, because of the context of the rest of the query, only the rows for the department of the sales representatives need to be considered by the view.

*Example A9:* Display the average education level and salary for 5 random groups of employees.

This query requires the use of a nested table expression to set a random value for each employee so that it can subsequently be used in the GROUP BY clause.

```
SELECT RANDID , AVG(EDLEVEL), AVG(SALARY)
FROM ( SELECT EDLEVEL, SALARY, INTEGER(RAND()*5) AS RANDID
      FROM EMPLOYEE
      ) AS EMPRAND
GROUP BY RANDID
```

*Example A10:* Query the EMP\_ACT table and return those project numbers that have an employee whose salary is in the top 10 of all employees.

```
SELECT EMP_ACT.EMPNO, PROJNO
FROM EMP_ACT
WHERE EMP_ACT.EMPNO IN
      (SELECT EMPLOYEE.EMPNO
      FROM EMPLOYEE
      ORDER BY SALARY DESC
      FETCH FIRST 10 ROWS ONLY)
```

## Examples of joins

*Example B1:* This example illustrates the results of the various joins using tables J1 and J2. These tables contain rows as shown.

```
SELECT * FROM J1
```

```
W  X
---
A   11
B   12
C   13
```

```
SELECT * FROM J2
```

```
Y  Z
---
A   21
C   22
D   23
```

The following query does an inner join of J1 and J2 matching the first column of both tables.

```
SELECT * FROM J1 INNER JOIN J2 ON W=Y
```

```
W  X      Y  Z
---
A   11 A     21
C   13 C     22
```

In this inner join example the row with column W='C' from J1 and the row with column Y='D' from J2 are not included in the result because they do not have a match in the other table. Note that the following alternative form of an inner join query produces the same result.

```
SELECT * FROM J1, J2 WHERE W=Y
```

The following left outer join will get back the missing row from J1 with nulls for the columns of J2. Every row from J1 is included.

```
SELECT * FROM J1 LEFT OUTER JOIN J2 ON W=Y
```

| W | X  | Y | Z  |
|---|----|---|----|
| A | 11 | A | 21 |
| B | 12 | - | -  |
| C | 13 | C | 22 |

The following right outer join will get back the missing row from J2 with nulls for the columns of J1. Every row from J2 is included.

```
SELECT * FROM J1 RIGHT OUTER JOIN J2 ON W=Y
```

| W | X  | Y | Z  |
|---|----|---|----|
| A | 11 | A | 21 |
| C | 13 | C | 22 |
| - | -  | D | 23 |

The following full outer join will get back the missing rows from both J1 and J2 with nulls where appropriate. Every row from both J1 and J2 is included.

```
SELECT * FROM J1 FULL OUTER JOIN J2 ON W=Y
```

| W | X  | Y | Z  |
|---|----|---|----|
| A | 11 | A | 21 |
| C | 13 | C | 22 |
| - | -  | D | 23 |
| B | 12 | - | -  |

*Example B2:* Using the tables J1 and J2 from the previous example, examine what happens when an additional predicate is added to the search condition.

```
SELECT * FROM J1 INNER JOIN J2 ON W=Y AND X=13
```

| W | X  | Y | Z  |
|---|----|---|----|
| C | 13 | C | 22 |

The additional condition caused the inner join to select only 1 row compared to the inner join in "Example B1" on page 532.

Notice what the impact of this is on the full outer join.

```
SELECT * FROM J1 FULL OUTER JOIN J2 ON W=Y AND X=13
```

| W | X  | Y | Z  |
|---|----|---|----|
| - | -  | A | 21 |
| C | 13 | C | 22 |
| - | -  | D | 23 |
| A | 11 | - | -  |
| B | 12 | - | -  |

The result now has 5 rows (compared to 4 without the additional predicate) since there was only 1 row in the inner join and all rows of both tables must be returned.

## Examples of joins

The following query illustrates that placing the same additional predicate in WHERE clause has completely different results.

```
SELECT * FROM J1 FULL OUTER JOIN J2 ON W=Y
WHERE X=13
```

| W | X  | Y | Z  |
|---|----|---|----|
| C | 13 | C | 22 |

The WHERE clause is applied after the intermediate result of the full outer join. This intermediate result would be the same as the result of the full outer join query in "Example B1" on page 532. The WHERE clause is applied to this intermediate result and eliminates all but the row that has X=13. Choosing the location of a predicate when performing outer joins can have significant impact on the results. Consider what happens if the predicate was X=12 instead of X=13. The following inner join returns no rows.

```
SELECT * FROM J1 INNER JOIN J2 ON W=Y AND X=12
```

Hence, the full outer join would return 6 rows, 3 from J1 with nulls for the columns of J2 and 3 from J2 with nulls for the columns of J1.

```
SELECT * FROM J1 FULL OUTER JOIN J2 ON W=Y AND X=12
```

| W | X  | Y | Z  |
|---|----|---|----|
| - | -  | A | 21 |
| - | -  | C | 22 |
| - | -  | D | 23 |
| A | 11 | - | -  |
| B | 12 | - | -  |
| C | 13 | - | -  |

If the additional predicate is in the WHERE clause instead, 1 row is returned.

```
SELECT * FROM J1 FULL OUTER JOIN J2 ON W=Y
WHERE X=12
```

| W | X  | Y | Z |
|---|----|---|---|
| B | 12 | - | - |

*Example B3:* List every department with the employee number and last name of the manager, including departments without a manager.

```
SELECT DEPTNO, DEPTNAME, EMPNO, LASTNAME
FROM DEPARTMENT LEFT OUTER JOIN EMPLOYEE
ON MGRNO = EMPNO
```

*Example B4:* List every employee number and last name with the employee number and last name of their manager, including employees without a manager.

```
SELECT E.EMPNO, E.LASTNAME, M.EMPNO, M.LASTNAME
FROM EMPLOYEE E LEFT OUTER JOIN
DEPARTMENT INNER JOIN EMPLOYEE M
ON MGRNO = M.EMPNO
ON E.WORKDEPT = DEPTNO
```

The inner join determines the last name for any manager identified in the DEPARTMENT table and the left outer join guarantees that each employee is listed even if a corresponding department is not found in DEPARTMENT.

## Examples of grouping sets, cube, and rollup

The queries in “Example C1” through “Example C4” on page 536 use a subset of the rows in the SALES tables based on the predicate ‘WEEK(SALES\_DATE) = 13’.

```
SELECT WEEK(SALES_DATE) AS WEEK,
       DAYOFWEEK(SALES_DATE) AS DAY_WEEK,
       SALES_PERSON, SALES AS UNITS_SOLD
FROM SALES
WHERE WEEK(SALES_DATE) = 13
```

which results in:

| WEEK | DAY_WEEK | SALES_PERSON | UNITS_SOLD |
|------|----------|--------------|------------|
| 13   | 6        | LUCCHESSI    | 3          |
| 13   | 6        | LUCCHESSI    | 1          |
| 13   | 6        | LEE          | 2          |
| 13   | 6        | LEE          | 2          |
| 13   | 6        | LEE          | 3          |
| 13   | 6        | LEE          | 5          |
| 13   | 6        | GOUNOT       | 3          |
| 13   | 6        | GOUNOT       | 1          |
| 13   | 6        | GOUNOT       | 7          |
| 13   | 7        | LUCCHESSI    | 1          |
| 13   | 7        | LUCCHESSI    | 2          |
| 13   | 7        | LUCCHESSI    | 1          |
| 13   | 7        | LEE          | 7          |
| 13   | 7        | LEE          | 3          |
| 13   | 7        | LEE          | 7          |
| 13   | 7        | LEE          | 4          |
| 13   | 7        | GOUNOT       | 2          |
| 13   | 7        | GOUNOT       | 18         |
| 13   | 7        | GOUNOT       | 1          |

*Example C1:* Here is a query with a basic GROUP BY clause over 3 columns:

```
SELECT WEEK(SALES_DATE) AS WEEK,
       DAYOFWEEK(SALES_DATE) AS DAY_WEEK,
       SALES_PERSON, SUM(SALES) AS UNITS_SOLD
FROM SALES
WHERE WEEK(SALES_DATE) = 13
GROUP BY WEEK(SALES_DATE), DAYOFWEEK(SALES_DATE), SALES_PERSON
ORDER BY WEEK, DAY_WEEK, SALES_PERSON
```

This results in:

| WEEK | DAY_WEEK | SALES_PERSON | UNITS_SOLD |
|------|----------|--------------|------------|
| 13   | 6        | GOUNOT       | 11         |
| 13   | 6        | LEE          | 12         |
| 13   | 6        | LUCCHESSI    | 4          |
| 13   | 7        | GOUNOT       | 21         |
| 13   | 7        | LEE          | 21         |
| 13   | 7        | LUCCHESSI    | 4          |

*Example C2:* Produce the result based on two different grouping sets of rows from the SALES table.

```
SELECT WEEK(SALES_DATE) AS WEEK,
       DAYOFWEEK(SALES_DATE) AS DAY_WEEK,
       SALES_PERSON, SUM(SALES) AS UNITS_SOLD
FROM SALES
WHERE WEEK(SALES_DATE) = 13
GROUP BY GROUPING SETS ( (WEEK(SALES_DATE), SALES_PERSON),
                          (DAYOFWEEK(SALES_DATE), SALES_PERSON) )
ORDER BY WEEK, DAY_WEEK, SALES_PERSON
```

## Examples of grouping sets, cube, and rollup

This results in:

| WEEK | DAY_WEEK | SALES_PERSON | UNITS_SOLD |
|------|----------|--------------|------------|
| 13   |          | - GOUNOT     | 32         |
| 13   |          | - LEE        | 33         |
| 13   |          | - LUCCHESI   | 8          |
| -    | 6        | GOUNOT       | 11         |
| -    | 6        | LEE          | 12         |
| -    | 6        | LUCCHESI     | 4          |
| -    | 7        | GOUNOT       | 21         |
| -    | 7        | LEE          | 21         |
| -    | 7        | LUCCHESI     | 4          |

The rows with WEEK 13 are from the first grouping set and the other rows are from the second grouping set.

*Example C3:* If you use the 3 distinct columns involved in the grouping sets of "Example C2" on page 535 and perform a ROLLUP, you can see grouping sets for (WEEK, DAY\_WEEK, SALES\_PERSON), (WEEK, DAY\_WEEK), (WEEK) and grand total.

```
SELECT WEEK(SALES_DATE) AS WEEK,
       DAYOFWEEK(SALES_DATE) AS DAY_WEEK,
       SALES_PERSON, SUM(SALES) AS UNITS_SOLD
FROM SALES
WHERE WEEK(SALES_DATE) = 13
GROUP BY ROLLUP ( WEEK(SALES_DATE), DAYOFWEEK(SALES_DATE), SALES_PERSON )
ORDER BY WEEK, DAY_WEEK, SALES_PERSON
```

This results in:

| WEEK | DAY_WEEK | SALES_PERSON | UNITS_SOLD |
|------|----------|--------------|------------|
| 13   | 6        | GOUNOT       | 11         |
| 13   | 6        | LEE          | 12         |
| 13   | 6        | LUCCHESI     | 4          |
| 13   | 6        | -            | 27         |
| 13   | 7        | GOUNOT       | 21         |
| 13   | 7        | LEE          | 21         |
| 13   | 7        | LUCCHESI     | 4          |
| 13   | 7        | -            | 46         |
| 13   | -        | -            | 73         |
| -    | -        | -            | 73         |

*Example C4:* If you run the same query as "Example C3" only replace ROLLUP with CUBE, you can see additional grouping sets for (WEEK, SALES\_PERSON), (DAY\_WEEK, SALES\_PERSON), (DAY\_WEEK), (SALES\_PERSON) in the result.

```
SELECT WEEK(SALES_DATE) AS WEEK,
       DAYOFWEEK(SALES_DATE) AS DAY_WEEK,
       SALES_PERSON, SUM(SALES) AS UNITS_SOLD
FROM SALES
WHERE WEEK(SALES_DATE) = 13
GROUP BY CUBE ( WEEK(SALES_DATE), DAYOFWEEK(SALES_DATE), SALES_PERSON )
ORDER BY WEEK, DAY_WEEK, SALES_PERSON
```

This results in:

| WEEK | DAY_WEEK | SALES_PERSON | UNITS_SOLD |
|------|----------|--------------|------------|
| 13   | 6        | GOUNOT       | 11         |
| 13   | 6        | LEE          | 12         |
| 13   | 6        | LUCCHESI     | 4          |
| 13   | 6        | -            | 27         |
| 13   | 7        | GOUNOT       | 21         |
| 13   | 7        | LEE          | 21         |

## Examples of grouping sets, cube, and rollup

|    |            |    |
|----|------------|----|
| 13 | 7 LUCCHESI | 4  |
| 13 | 7 -        | 46 |
| 13 | - GOUNOT   | 32 |
| 13 | - LEE      | 33 |
| 13 | - LUCCHESI | 8  |
| 13 | - -        | 73 |
| -  | 6 GOUNOT   | 11 |
| -  | 6 LEE      | 12 |
| -  | 6 LUCCHESI | 4  |
| -  | 6 -        | 27 |
| -  | 7 GOUNOT   | 21 |
| -  | 7 LEE      | 21 |
| -  | 7 LUCCHESI | 4  |
| -  | 7 -        | 46 |
| -  | - GOUNOT   | 32 |
| -  | - LEE      | 33 |
| -  | - LUCCHESI | 8  |
| -  | - -        | 73 |

*Example C5:* Obtain a result set which includes a grand-total of selected rows from the SALES table together with a group of rows aggregated by SALES\_PERSON and MONTH.

```

SELECT SALES_PERSON,
       MONTH(SALES_DATE) AS MONTH,
       SUM(SALES) AS UNITS_SOLD
FROM SALES
GROUP BY GROUPING SETS ( (SALES_PERSON, MONTH(SALES_DATE)),
                        ()
                      )
ORDER BY SALES_PERSON, MONTH

```

This results in:

| SALES_PERSON | MONTH | UNITS_SOLD |
|--------------|-------|------------|
| GOUNOT       | 3     | 35         |
| GOUNOT       | 4     | 14         |
| GOUNOT       | 12    | 1          |
| LEE          | 3     | 60         |
| LEE          | 4     | 25         |
| LEE          | 12    | 6          |
| LUCCHESI     | 3     | 9          |
| LUCCHESI     | 4     | 4          |
| LUCCHESI     | 12    | 1          |
| -            | -     | 155        |

*Example C6:* This example shows two simple ROLLUP queries followed by a query which treats the two ROLLUPs as grouping sets in a single result set and specifies row ordering for each column involved in the grouping sets.

*Example C6-1:*

```

SELECT WEEK(SALES_DATE) AS WEEK,
       DAYOFWEEK(SALES_DATE) AS DAY_WEEK,
       SUM(SALES) AS UNITS_SOLD
FROM SALES
GROUP BY ROLLUP ( WEEK(SALES_DATE), DAYOFWEEK(SALES_DATE) )
ORDER BY WEEK, DAY_WEEK

```

results in:

| WEEK | DAY_WEEK | UNITS_SOLD |
|------|----------|------------|
| 13   | 6        | 27         |
| 13   | 7        | 46         |
| 13   | -        | 73         |

## Examples of grouping sets, cube, and rollup

|    |   |     |
|----|---|-----|
| 14 | 1 | 31  |
| 14 | 2 | 43  |
| 14 | - | 74  |
| 53 | 1 | 8   |
| 53 | - | 8   |
| -  | - | 155 |

Example C6-2:

```

SELECT MONTH(SALES_DATE) AS MONTH,
       REGION,
       SUM(SALES) AS UNITS_SOLD
FROM SALES
GROUP BY ROLLUP ( MONTH(SALES_DATE), REGION );
ORDER BY MONTH, REGION

```

results in:

| MONTH | REGION        | UNITS_SOLD |
|-------|---------------|------------|
| ----- | -----         | -----      |
| 3     | Manitoba      | 22         |
| 3     | Ontario-North | 8          |
| 3     | Ontario-South | 34         |
| 3     | Quebec        | 40         |
| 3     | -             | 104        |
| 4     | Manitoba      | 17         |
| 4     | Ontario-North | 1          |
| 4     | Ontario-South | 14         |
| 4     | Quebec        | 11         |
| 4     | -             | 43         |
| 12    | Manitoba      | 2          |
| 12    | Ontario-South | 4          |
| 12    | Quebec        | 2          |
| 12    | -             | 8          |
| -     | -             | 155        |

Example C6-3:

```

SELECT WEEK(SALES_DATE) AS WEEK,
       DAYOFWEEK(SALES_DATE) AS DAY_WEEK,
       MONTH(SALES_DATE) AS MONTH,
       REGION,
       SUM(SALES) AS UNITS_SOLD
FROM SALES
GROUP BY GROUPING SETS ( ROLLUP( WEEK(SALES_DATE), DAYOFWEEK(SALES_DATE) ),
                        ROLLUP( MONTH(SALES_DATE), REGION ) )
ORDER BY WEEK, DAY_WEEK, MONTH, REGION

```

results in:

| WEEK  | DAY_WEEK | MONTH | REGION          | UNITS_SOLD |
|-------|----------|-------|-----------------|------------|
| ----- | -----    | ----- | -----           | -----      |
| 13    | 6        | - -   |                 | 27         |
| 13    | 7        | - -   |                 | 46         |
| 13    | -        | - -   |                 | 73         |
| 14    | 1        | - -   |                 | 31         |
| 14    | 2        | - -   |                 | 43         |
| 14    | -        | - -   |                 | 74         |
| 53    | 1        | - -   |                 | 8          |
| 53    | -        | - -   |                 | 8          |
| -     | -        |       | 3 Manitoba      | 22         |
| -     | -        |       | 3 Ontario-North | 8          |
| -     | -        |       | 3 Ontario-South | 34         |
| -     | -        |       | 3 Quebec        | 40         |
| -     | -        |       | 3 -             | 104        |
| -     | -        |       | 4 Manitoba      | 17         |
| -     | -        |       | 4 Ontario-North | 1          |
| -     | -        |       | 4 Ontario-South | 14         |



## Examples of grouping sets, cube, and rollup

|   |   |                  |     |
|---|---|------------------|-----|
| - | - | 4 Quebec         | 11  |
| - | - | 4 -              | 43  |
| - | - | 12 Manitoba      | 2   |
| - | - | 12 Ontario-South | 4   |
| - | - | 12 Quebec        | 2   |
| - | - | 12 -             | 8   |
| - | - | - -              | 155 |
| - | - | - -              | 155 |

Using the two ROLLUPs as grouping sets causes the result to include duplicate rows. There are even two grand total rows.

Observe how the use of ORDER BY has affected the results:

- In the first grouped set, week 53 has been repositioned to the end.
- In the second grouped set, month 12 has now been positioned to the end and the regions now appear in alphabetic order.
- Null values are sorted high.

*Example C7:* In queries that perform multiple ROLLUPs in a single pass (such as “Example C6-3” on page 538) you may want to be able to indicate which grouping set produced each row. The following steps demonstrate how to provide a column (called GROUP) which indicates the origin of each row in the result set. By origin, we mean which one of the two grouping sets produced the row in the result set.

*Step 1:* Introduce a way of “generating” new data values, using a query which selects from a VALUES clause (which is an alternate form of a fullselect). This query shows how a table can be derived called “X” having 2 columns “R1” and “R2” and 1 row of data.

```
SELECT R1,R2
FROM (VALUES('GROUP 1','GROUP 2')) AS X(R1,R2);
```

results in:

```
R1      R2
-----
GROUP 1 GROUP 2
```

*Step 2:* Form the cross product of this table “X” with the SALES table. This add columns “R1” and “R2” to every row.

```
SELECT R1, R2, WEEK(SALES_DATE) AS WEEK,
       DAYOFWEEK(SALES_DATE) AS DAY_WEEK,
       MONTH(SALES_DATE) AS MONTH,
       REGION,
       SALES AS UNITS_SOLD
FROM SALES, (VALUES('GROUP 1','GROUP 2')) AS X(R1,R2)
```

This add columns “R1” and “R2” to every row.

*Step 3:* Now we can combine these columns with the grouping sets to include these columns in the rollup analysis.

```
SELECT R1, R2,
       WEEK(SALES_DATE) AS WEEK,
       DAYOFWEEK(SALES_DATE) AS DAY_WEEK,
       MONTH(SALES_DATE) AS MONTH,
       REGION, SUM(SALES) AS UNITS_SOLD
FROM SALES, (VALUES('GROUP 1','GROUP 2')) AS X(R1,R2)
GROUP BY GROUPING SETS ((R1, ROLLUP(WEEK(SALES_DATE),
                                     DAYOFWEEK(SALES_DATE))),
                        (R2, ROLLUP(MONTH(SALES_DATE), REGION) ) )
ORDER BY WEEK, DAY_WEEK, MONTH, REGION
```

## Examples of grouping sets, cube, and rollup

results in:

| R1      | R2      | WEEK | DAY_WEEK | MONTH | REGION           | UNITS_SOLD |
|---------|---------|------|----------|-------|------------------|------------|
| GROUP 1 | -       | 13   | 6        | -     | -                | 27         |
| GROUP 1 | -       | 13   | 7        | -     | -                | 46         |
| GROUP 1 | -       | 13   | -        | -     | -                | 73         |
| GROUP 1 | -       | 14   | 1        | -     | -                | 31         |
| GROUP 1 | -       | 14   | 2        | -     | -                | 43         |
| GROUP 1 | -       | 14   | -        | -     | -                | 74         |
| GROUP 1 | -       | 53   | 1        | -     | -                | 8          |
| GROUP 1 | -       | 53   | -        | -     | -                | 8          |
| -       | GROUP 2 | -    | -        | -     | 3 Manitoba       | 22         |
| -       | GROUP 2 | -    | -        | -     | 3 Ontario-North  | 8          |
| -       | GROUP 2 | -    | -        | -     | 3 Ontario-South  | 34         |
| -       | GROUP 2 | -    | -        | -     | 3 Quebec         | 40         |
| -       | GROUP 2 | -    | -        | -     | 3 -              | 104        |
| -       | GROUP 2 | -    | -        | -     | 4 Manitoba       | 17         |
| -       | GROUP 2 | -    | -        | -     | 4 Ontario-North  | 1          |
| -       | GROUP 2 | -    | -        | -     | 4 Ontario-South  | 14         |
| -       | GROUP 2 | -    | -        | -     | 4 Quebec         | 11         |
| -       | GROUP 2 | -    | -        | -     | 4 -              | 43         |
| -       | GROUP 2 | -    | -        | -     | 12 Manitoba      | 2          |
| -       | GROUP 2 | -    | -        | -     | 12 Ontario-South | 4          |
| -       | GROUP 2 | -    | -        | -     | 12 Quebec        | 2          |
| -       | GROUP 2 | -    | -        | -     | 12 -             | 8          |
| -       | GROUP 2 | -    | -        | -     | -                | 155        |
| GROUP 1 | -       | -    | -        | -     | -                | 155        |

*Step 4:* Notice that because R1 and R2 are used in different grouping sets, whenever R1 is non-null in the result, R2 is null and whenever R2 is non-null in the result, R1 is null. That means you can consolidate these columns into a single column using the COALESCE function. You can also use this column in the ORDER BY clause to keep the results of the two grouping sets together.

```

SELECT COALESCE(R1,R2) AS GROUP,
       WEEK(SALES_DATE) AS WEEK,
       DAYOFWEEK(SALES_DATE) AS DAY_WEEK,
       MONTH(SALES_DATE) AS MONTH,
       REGION, SUM(SALES) AS UNITS_SOLD
FROM SALES, (VALUES('GROUP 1','GROUP 2')) AS X(R1,R2)
GROUP BY GROUPING SETS ((R1, ROLLUP(WEEK(SALES_DATE),
                                     DAYOFWEEK(SALES_DATE))),
                        (R2, ROLLUP( MONTH(SALES_DATE), REGION ) ) )
ORDER BY GROUP, WEEK, DAY_WEEK, MONTH, REGION;

```

results in:

| GROUP   | WEEK | DAY_WEEK | MONTH | REGION          | UNITS_SOLD |
|---------|------|----------|-------|-----------------|------------|
| GROUP 1 | 13   | 6        | -     | -               | 27         |
| GROUP 1 | 13   | 7        | -     | -               | 46         |
| GROUP 1 | 13   | -        | -     | -               | 73         |
| GROUP 1 | 14   | 1        | -     | -               | 31         |
| GROUP 1 | 14   | 2        | -     | -               | 43         |
| GROUP 1 | 14   | -        | -     | -               | 74         |
| GROUP 1 | 53   | 1        | -     | -               | 8          |
| GROUP 1 | 53   | -        | -     | -               | 8          |
| GROUP 1 | -    | -        | -     | -               | 155        |
| GROUP 2 | -    | -        | -     | 3 Manitoba      | 22         |
| GROUP 2 | -    | -        | -     | 3 Ontario-North | 8          |
| GROUP 2 | -    | -        | -     | 3 Ontario-South | 34         |
| GROUP 2 | -    | -        | -     | 3 Quebec        | 40         |
| GROUP 2 | -    | -        | -     | 3 -             | 104        |
| GROUP 2 | -    | -        | -     | 4 Manitoba      | 17         |
| GROUP 2 | -    | -        | -     | 4 Ontario-North | 1          |
| GROUP 2 | -    | -        | -     | 4 Ontario-South | 14         |

## Examples of grouping sets, cube, and rollup

|         |   |   |                  |     |
|---------|---|---|------------------|-----|
| GROUP 2 | - | - | 4 Quebec         | 11  |
| GROUP 2 | - | - | 4 -              | 43  |
| GROUP 2 | - | - | 12 Manitoba      | 2   |
| GROUP 2 | - | - | 12 Ontario-South | 4   |
| GROUP 2 | - | - | 12 Quebec        | 2   |
| GROUP 2 | - | - | 12 -             | 8   |
| GROUP 2 | - | - | - -              | 155 |

*Example C8:* The following example illustrates the use of various column functions when performing a CUBE. The example also makes use of cast functions and rounding to produce a decimal result with reasonable precision and scale.

```

SELECT MONTH(SALES_DATE) AS MONTH,
       REGION,
       SUM(SALES) AS UNITS_SOLD,
       MAX(SALES) AS BEST_SALE,
       CAST(ROUND(AVG(DECIMAL(SALES)),2) AS DECIMAL(5,2)) AS AVG_UNITS_SOLD
FROM SALES
GROUP BY CUBE(MONTH(SALES_DATE),REGION)
ORDER BY MONTH, REGION

```

This results in:

| MONTH | REGION        | UNITS_SOLD | BEST_SALE | AVG_UNITS_SOLD |
|-------|---------------|------------|-----------|----------------|
| 3     | Manitoba      | 22         | 7         | 3.14           |
| 3     | Ontario-North | 8          | 3         | 2.67           |
| 3     | Ontario-South | 34         | 14        | 4.25           |
| 3     | Quebec        | 40         | 18        | 5.00           |
| 3     | -             | 104        | 18        | 4.00           |
| 4     | Manitoba      | 17         | 9         | 5.67           |
| 4     | Ontario-North | 1          | 1         | 1.00           |
| 4     | Ontario-South | 14         | 8         | 4.67           |
| 4     | Quebec        | 11         | 8         | 5.50           |
| 4     | -             | 43         | 9         | 4.78           |
| 12    | Manitoba      | 2          | 2         | 2.00           |
| 12    | Ontario-South | 4          | 3         | 2.00           |
| 12    | Quebec        | 2          | 1         | 1.00           |
| 12    | -             | 8          | 3         | 1.60           |
| -     | Manitoba      | 41         | 9         | 3.73           |
| -     | Ontario-North | 9          | 3         | 2.25           |
| -     | Ontario-South | 52         | 14        | 4.00           |
| -     | Quebec        | 53         | 18        | 4.42           |
| -     | -             | 155        | 18        | 3.87           |

### Related reference:

- “Assignments and comparisons” on page 105
- “Character strings” on page 81
- “Fullselect” on page 543
- “Functions” on page 157
- “GROUPING ” on page 266
- “Identifiers” on page 57
- “Predicates” on page 207
- “Select-statement” on page 548
- “XMLTABLE ” on page 488
- “CREATE FUNCTION (External Table) statement” in *SQL Reference, Volume 2*
- “CREATE FUNCTION (SQL Scalar, Table, or Row) statement” in *SQL Reference, Volume 2*
- “DELETE statement” in *SQL Reference, Volume 2*
- “INSERT statement” in *SQL Reference, Volume 2*

## Examples of grouping sets, cube, and rollup

- “UPDATE statement” in *SQL Reference, Volume 2*

## Fullselect

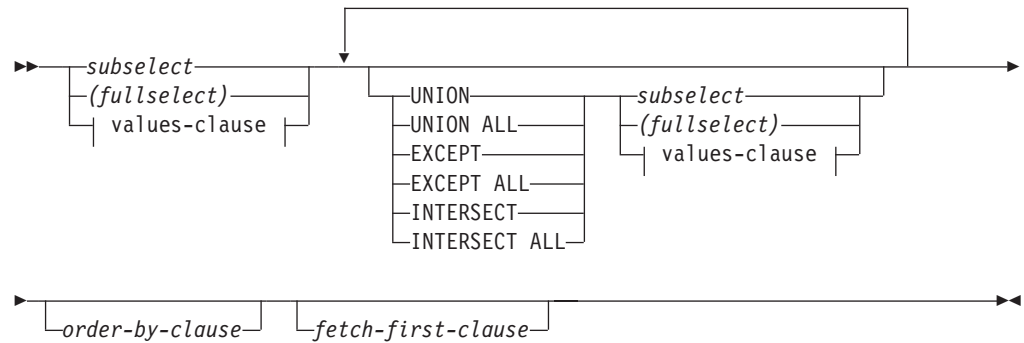

### values-clause:



### values-row:



The *fullselect* is a component of the select-statement, the INSERT statement, and the CREATE VIEW statement. It is also a component of certain predicates which, in turn, are components of a statement. A fullselect that is a component of a predicate is called a *subquery*, and a fullselect that is enclosed in parentheses is sometimes called a subquery.

The set operators UNION, EXCEPT, and INTERSECT correspond to the relational operators union, difference, and intersection.

A fullselect specifies a result table. If a set operator is not used, the result of the fullselect is the result of the specified subselect or values-clause.

### values-clause

Derives a result table by specifying the actual values, using expressions, for each column of a row in the result table. Multiple rows may be specified.

NULL can only be used with multiple specifications of *values-row*, and at least one row in the same column must not be NULL (SQLSTATE 42826).

A *values-row* is specified by:

- A single expression for a single column result table or,
- $n$  expressions (or NULL) separated by commas and enclosed in parentheses, where  $n$  is the number of columns in the result table.

## Fullselect

A multiple row VALUES clause must have the same number of expressions in each *values-row* (SQLSTATE 42826).

The following are examples of values-clauses and their meaning.

|                             |                       |
|-----------------------------|-----------------------|
| VALUES (1),(2),(3)          | - 3 rows of 1 column  |
| VALUES 1, 2, 3              | - 3 rows of 1 column  |
| VALUES (1, 2, 3)            | - 1 row of 3 columns  |
| VALUES (1,21),(2,22),(3,23) | - 3 rows of 2 columns |

A values-clause that is composed of  $n$  specifications of *values-row*,  $RE_1$  to  $RE_n$ , where  $n$  is greater than 1, is equivalent to:

$RE_1$  UNION ALL  $RE_2$  ... UNION ALL  $RE_n$

This means that the corresponding expressions of each *values-row* must be comparable (SQLSTATE 42825).

### UNION or UNION ALL

Derives a result table by combining two other result tables (R1 and R2). If UNION ALL is specified, the result consists of all rows in R1 and R2. If UNION is specified without the ALL option, the result is the set of all rows in either R1 or R2, with the duplicate rows eliminated. In either case, however, each row of the UNION table is either a row from R1 or a row from R2.

### EXCEPT or EXCEPT ALL

Derives a result table by combining two other result tables (R1 and R2). If EXCEPT ALL is specified, the result consists of all rows that do not have a corresponding row in R2, where duplicate rows are significant. If EXCEPT is specified without the ALL option, the result consists of all rows that are only in R1, with duplicate rows in the result of this operation eliminated.

### INTERSECT or INTERSECT ALL

Derives a result table by combining two other result tables (R1 and R2). If INTERSECT ALL is specified, the result consists of all rows that are in both R1 and R2. If INTERSECT is specified without the ALL option, the result consists of all rows that are in both R1 and R2, with the duplicate rows eliminated.

### *order-by-clause*

A fullselect that contains an ORDER BY or FETCH FIRST clause cannot be specified in:

- A materialized query table
- The outermost fullselect of a view (SQLSTATE 428FJ).

**Note:** An ORDER BY clause in a fullselect does not affect the order of the rows returned by a query. An ORDER BY clause only affects the order of the rows returned if it is specified in the outermost fullselect.

The number of columns in the result tables R1 and R2 must be the same (SQLSTATE 42826). If the ALL keyword is not specified, R1 and R2 must not include any columns having a data type of LONG VARCHAR, CLOB, LONG VARGRAPHIC, DBCLOB, BLOB, DATALINK, distinct type on any of these types, or structured type (SQLSTATE 42907).

The columns of the result are named as follows:

- If the  $n$ th column of R1 and the  $n$ th column of R2 have the same result column name, then the  $n$ th column of R has the result column name.

- If the  $n$ th column of R1 and the  $n$ th column of R2 have different result column names, a name is generated. This name cannot be used as the column name in an ORDER BY or UPDATE clause.

The generated name can be determined by performing a DESCRIBE of the SQL statement and consulting the SQLNAME field.

Two rows are duplicates of one another if each value in the first is equal to the corresponding value of the second. (For determining duplicates, two null values are considered equal.)

When multiple operations are combined in an expression, operations within parentheses are performed first. If there are no parentheses, the operations are performed from left to right with the exception that all INTERSECT operations are performed before UNION or EXCEPT operations.

In the following example, the values of tables R1 and R2 are shown on the left. The other headings listed show the values as a result of various set operations on R1 and R2.

| R1 | R2 | UNION<br>ALL | UNION | EXCEPT<br>ALL | EXCEPT | INTER-<br>SECT<br>ALL | INTER-<br>SECT |
|----|----|--------------|-------|---------------|--------|-----------------------|----------------|
| 1  | 1  | 1            | 1     | 1             | 2      | 1                     | 1              |
| 1  | 1  | 1            | 2     | 2             | 5      | 1                     | 3              |
| 1  | 3  | 1            | 3     | 2             |        | 3                     | 4              |
| 2  | 3  | 1            | 4     | 2             |        | 4                     |                |
| 2  | 3  | 1            | 5     | 4             |        |                       |                |
| 2  | 3  | 2            |       | 5             |        |                       |                |
| 3  | 4  | 2            |       |               |        |                       |                |
| 4  |    | 2            |       |               |        |                       |                |
| 4  |    | 3            |       |               |        |                       |                |
| 5  |    | 3            |       |               |        |                       |                |
|    |    | 3            |       |               |        |                       |                |
|    |    | 3            |       |               |        |                       |                |
|    |    | 3            |       |               |        |                       |                |
|    |    | 4            |       |               |        |                       |                |
|    |    | 4            |       |               |        |                       |                |
|    |    | 4            |       |               |        |                       |                |
|    |    | 5            |       |               |        |                       |                |

## Examples of a fullselect

*Example 1:* Select all columns and rows from the EMPLOYEE table.

```
SELECT * FROM EMPLOYEE
```

*Example 2:* List the employee numbers (EMPNO) of all employees in the EMPLOYEE table whose department number (WORKDEPT) either begins with 'E' or who are assigned to projects in the EMP\_ACT table whose project number (PROJNO) equals 'MA2100', 'MA2110', or 'MA2112'.

## Examples of a fullselect

```
SELECT EMPNO
  FROM EMPLOYEE
 WHERE WORKDEPT LIKE 'E%'
UNION
SELECT EMPNO
  FROM EMP_ACT
 WHERE PROJNO IN('MA2100', 'MA2110', 'MA2112')
```

*Example 3:* Make the same query as in example 2, and, in addition, “tag” the rows from the EMPLOYEE table with 'emp' and the rows from the EMP\_ACT table with 'emp\_act'. Unlike the result from example 2, this query may return the same EMPNO more than once, identifying which table it came from by the associated “tag”.

```
SELECT EMPNO, 'emp'
  FROM EMPLOYEE
 WHERE WORKDEPT LIKE 'E%'
UNION
SELECT EMPNO, 'emp_act' FROM EMP_ACT
 WHERE PROJNO IN('MA2100', 'MA2110', 'MA2112')
```

*Example 4:* Make the same query as in example 2, only use UNION ALL so that no duplicate rows are eliminated.

```
SELECT EMPNO
  FROM EMPLOYEE
 WHERE WORKDEPT LIKE 'E%'
UNION ALL
SELECT EMPNO
  FROM EMP_ACT
 WHERE PROJNO IN('MA2100', 'MA2110', 'MA2112')
```

*Example 5:* Make the same query as in Example 3, only include an additional two employees currently not in any table and tag these rows as "new".

```
SELECT EMPNO, 'emp'
  FROM EMPLOYEE
 WHERE WORKDEPT LIKE 'E%'
UNION
SELECT EMPNO, 'emp_act'
  FROM EMP_ACT
 WHERE PROJNO IN('MA2100', 'MA2110', 'MA2112')
UNION
VALUES ('NEWAAA', 'new'), ('NEWBBB', 'new')
```

*Example 6:* This example of EXCEPT produces all rows that are in T1 but not in T2.

```
(SELECT * FROM T1)
EXCEPT ALL
(SELECT * FROM T2)
```

If no NULL values are involved, this example returns the same results as

```
SELECT ALL *
  FROM T1
 WHERE NOT EXISTS (SELECT * FROM T2
                   WHERE T1.C1 = T2.C1 AND T1.C2 = T2.C2 AND...)
```

*Example 7:* This example of INTERSECT produces all rows that are in both tables T1 and T2, removing duplicates.

```
(SELECT * FROM T1)
INTERSECT
(SELECT * FROM T2)
```



If no NULL values are involved, this example returns the same result as

```
SELECT DISTINCT * FROM T1
WHERE EXISTS (SELECT * FROM T2
              WHERE T1.C1 = T2.C1 AND T1.C2 = T2.C2 AND...)
```

where C1, C2, and so on represent the columns of T1 and T2.

**Related reference:**

- “Rules for result data types” on page 116
- “Rules for string conversions” on page 120

## Select-statement

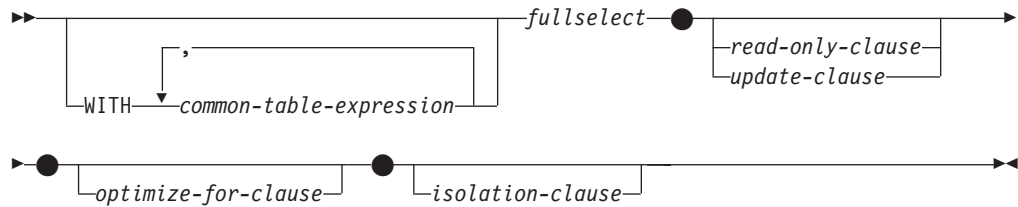

The *select-statement* is the form of a query that can be directly specified in a DECLARE CURSOR statement, or prepared and then referenced in a DECLARE CURSOR statement. It can also be issued through the use of dynamic SQL statements using the command line processor (or similar tools), causing a result table to be displayed on the user's screen. In either case, the table specified by a *select-statement* is the result of the fullselect.

### common-table-expression

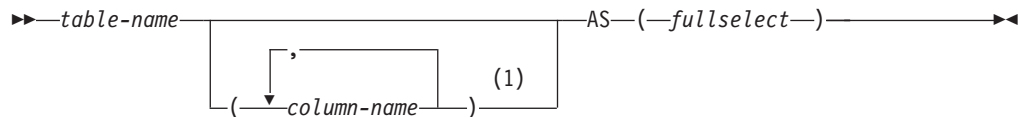

**Notes:**

- 1 If a common table expression is recursive, or if the fullselect results in duplicate column names, column names must be specified.

A *common table expression* permits defining a result table with a *table-name* that can be specified as a table name in any FROM clause of the fullselect that follows. Multiple common table expressions can be specified following the single WITH keyword. Each common table expression specified can also be referenced by name in the FROM clause of subsequent common table expressions.

If a list of columns is specified, it must consist of as many names as there are columns in the result table of the fullselect. Each *column-name* must be unique and unqualified. If these column names are not specified, the names are derived from the select list of the fullselect used to define the common table expression.

The *table-name* of a common table expression must be different from any other common table expression *table-name* in the same statement (SQLSTATE 42726). If the common table expression is specified in an INSERT statement the *table-name* cannot be the same as the table or view name that is the object of the insert (SQLSTATE 42726). A common table expression *table-name* can be specified as a table name in any FROM clause throughout the fullselect. A *table-name* of a common table expression overrides any existing table, view or alias (in the catalog) with the same qualified name.

If more than one common table expression is defined in the same statement, cyclic references between the common table expressions are not permitted (SQLSTATE 42835). A *cyclic reference* occurs when two common table expressions *dt1* and *dt2* are created such that *dt1* refers to *dt2* and *dt2* refers to *dt1*.

If the fullselect of a common table expression contains a *data-change-table-reference* in the FROM clause, the common table expression is said to modify data. A common table expression that modifies data is always evaluated when the statement is processed, regardless of whether the common table expression is used anywhere else in the statement. If there is at least one common table expression that reads or modifies data, all common table expressions are processed in the order in which they occur, and each common table expression that reads or modifies data is completely executed, including all constraints and triggers, before any subsequent common table expressions are executed.

The common table expression is also optional prior to the fullselect in the CREATE VIEW and INSERT statements.

A common table expression can be used:

- In place of a view to avoid creating the view (when general use of the view is not required and positioned updates or deletes are not used)
- To enable grouping by a column that is derived from a scalar subselect or function that is not deterministic or has external action
- When the desired result table is based on host variables
- When the same result table needs to be shared in a fullselect
- When the result needs to be derived using recursion
- When multiple SQL data change statements need to be processed within the query

If the fullselect of a common table expression contains a reference to itself in a FROM clause, the common table expression is a *recursive common table expression*. Queries using recursion are useful in supporting applications such as bill of materials (BOM), reservation systems, and network planning.

The following must be true of a recursive common table expression:

- Each fullselect that is part of the recursion cycle must start with SELECT or SELECT ALL. Use of SELECT DISTINCT is not allowed (SQLSTATE 42925). Furthermore, the unions must use UNION ALL (SQLSTATE 42925).
- The column names must be specified following the *table-name* of the common table expression (SQLSTATE 42908).
- The first fullselect of the first union (the initialization fullselect) must not include a reference to any column of the common table expression in any FROM clause (SQLSTATE 42836).
- If a column name of the common table expression is referred to in the iterative fullselect, the data type, length, and code page for the column are determined based on the initialization fullselect. The corresponding column in the iterative fullselect must have the same data type and length as the data type and length determined based on the initialization fullselect and the code page must match (SQLSTATE 42825). However, for character string types, the length of the two data types may differ. In this case, the column in the iterative fullselect must have a length that would always be assignable to the length determined from the initialization fullselect.
- Each fullselect that is part of the recursion cycle must not include any column functions, group-by-clauses, or having-clauses (SQLSTATE 42836).  
The FROM clauses of these fullselects can include at most one reference to a common table expression that is part of a recursion cycle (SQLSTATE 42836).
- The iterative fullselect and the overall recursive fullselect must not include an order-by-clause (SQLSTATE 42836).

## common-table-expression

- Subqueries (scalar or quantified) must not be part of any recursion cycles (SQLSTATE 42836).

When developing recursive common table expressions, remember that an infinite recursion cycle (loop) can be created. Check that recursion cycles will terminate. This is especially important if the data involved is cyclic. A recursive common table expression is expected to include a predicate that will prevent an infinite loop. The recursive common table expression is expected to include:

- In the iterative fullselect, an integer column incremented by a constant.
- A predicate in the where clause of the iterative fullselect in the form "counter\_col < constant" or "counter\_col < :hostvar".

A warning is issued if this syntax is not found in the recursive common table expression (SQLSTATE 01605).

### Recursion example: bill of materials:

Bill of materials (BOM) applications are a common requirement in many business environments. To illustrate the capability of a recursive common table expression for BOM applications, consider a table of parts with associated subparts and the quantity of subparts required by the part. For this example, create the table as follows:

```
CREATE TABLE PARTLIST
(PART VARCHAR(8),
SUBPART VARCHAR(8),
QUANTITY INTEGER);
```

To give query results for this example, assume that the PARTLIST table is populated with the following values:

| PART | SUBPART | QUANTITY |
|------|---------|----------|
| 00   | 01      | 5        |
| 00   | 05      | 3        |
| 01   | 02      | 2        |
| 01   | 03      | 3        |
| 01   | 04      | 4        |
| 01   | 06      | 3        |
| 02   | 05      | 7        |
| 02   | 06      | 6        |
| 03   | 07      | 6        |
| 04   | 08      | 10       |
| 04   | 09      | 11       |
| 05   | 10      | 10       |
| 05   | 11      | 10       |
| 06   | 12      | 10       |
| 06   | 13      | 10       |
| 07   | 14      | 8        |
| 07   | 12      | 8        |

### Example 1: Single level explosion

The first example is called single level explosion. It answers the question, "What parts are needed to build the part identified by '01'?". The list will include the direct subparts, subparts of the subparts and so on. However, if a part is used multiple times, its subparts are only listed once.

```
WITH RPL (PART, SUBPART, QUANTITY) AS
( SELECT ROOT.PART, ROOT.SUBPART, ROOT.QUANTITY
  FROM PARTLIST ROOT
  WHERE ROOT.PART = '01'
```

```

UNION ALL
  SELECT CHILD.PART, CHILD.SUBPART, CHILD.QUANTITY
  FROM RPL PARENT, PARTLIST CHILD
  WHERE PARENT.SUBPART = CHILD.PART
)
SELECT DISTINCT PART, SUBPART, QUANTITY
FROM RPL
ORDER BY PART, SUBPART, QUANTITY;

```

The above query includes a common table expression, identified by the name *RPL*, that expresses the recursive part of this query. It illustrates the basic elements of a recursive common table expression.

The first operand (fullselect) of the UNION, referred to as the *initialization fullselect*, gets the direct children of part '01'. The FROM clause of this fullselect refers to the source table and will never refer to itself (*RPL* in this case). The result of this first fullselect goes into the common table expression *RPL* (Recursive PARTLIST). As in this example, the UNION must always be a UNION ALL.

The second operand (fullselect) of the UNION uses *RPL* to compute subparts of subparts by having the FROM clause refer to the common table expression *RPL* and the source table with a join of a part from the source table (child) to a subpart of the current result contained in *RPL* (parent). The result goes back to *RPL* again. The second operand of UNION is then used repeatedly until no more children exist.

The SELECT DISTINCT in the main fullselect of this query ensures the same part/subpart is not listed more than once.

The result of the query is as follows:

| PART | SUBPART | QUANTITY |
|------|---------|----------|
| 01   | 02      | 2        |
| 01   | 03      | 3        |
| 01   | 04      | 4        |
| 01   | 06      | 3        |
| 02   | 05      | 7        |
| 02   | 06      | 6        |
| 03   | 07      | 6        |
| 04   | 08      | 10       |
| 04   | 09      | 11       |
| 05   | 10      | 10       |
| 05   | 11      | 10       |
| 06   | 12      | 10       |
| 06   | 13      | 10       |
| 07   | 12      | 8        |
| 07   | 14      | 8        |

Observe in the result that from part '01' we go to '02' which goes to '06' and so on. Further, notice that part '06' is reached twice, once through '01' directly and another time through '02'. In the output, however, its subcomponents are listed only once (this is the result of using a SELECT DISTINCT) as required.

It is important to remember that with recursive common table expressions it is possible to introduce an *infinite loop*. In this example, an infinite loop would be created if the search condition of the second operand that joins the parent and child tables was coded as:

```
PARENT.SUBPART = CHILD.SUBPART
```

## common-table-expression

This example of causing an infinite loop is obviously a case of not coding what is intended. However, care should also be exercised in determining what to code so that there is a definite end of the recursion cycle.

The result produced by this example query could be produced in an application program without using a recursive common table expression. However, this approach would require starting of a new query for every level of recursion. Furthermore, the application needs to put all the results back in the database to order the result. This approach complicates the application logic and does not perform well. The application logic becomes even harder and more inefficient for other bill of material queries, such as summarized and indented explosion queries.

### *Example 2: Summarized explosion*

The second example is a summarized explosion. The question posed here is, what is the total quantity of each part required to build part '01'. The main difference from the single level explosion is the need to aggregate the quantities. The first example indicates the quantity of subparts required for the part whenever it is required. It does not indicate how many of the subparts are needed to build part '01'.

```
WITH RPL (PART, SUBPART, QUANTITY) AS
(
  SELECT ROOT.PART, ROOT.SUBPART, ROOT.QUANTITY
  FROM PARTLIST ROOT
  WHERE ROOT.PART = '01'
  UNION ALL
  SELECT PARENT.PART, CHILD.SUBPART, PARENT.QUANTITY*CHILD.QUANTITY
  FROM RPL PARENT, PARTLIST CHILD
  WHERE PARENT.SUBPART = CHILD.PART
)
SELECT PART, SUBPART, SUM(QUANTITY) AS "Total QTY Used"
FROM RPL
GROUP BY PART, SUBPART
ORDER BY PART, SUBPART;
```

In the above query, the select list of the second operand of the UNION in the recursive common table expression, identified by the name *RPL*, shows the aggregation of the quantity. To find out how much of a subpart is used, the quantity of the parent is multiplied by the quantity per parent of a child. If a part is used multiple times in different places, it requires another final aggregation. This is done by the grouping over the common table expression *RPL* and using the SUM column function in the select list of the main fullselect.

The result of the query is as follows:

| PART | SUBPART | Total Qty Used |
|------|---------|----------------|
| 01   | 02      | 2              |
| 01   | 03      | 3              |
| 01   | 04      | 4              |
| 01   | 05      | 14             |
| 01   | 06      | 15             |
| 01   | 07      | 18             |
| 01   | 08      | 40             |
| 01   | 09      | 44             |
| 01   | 10      | 140            |
| 01   | 11      | 140            |
| 01   | 12      | 294            |
| 01   | 13      | 150            |
| 01   | 14      | 144            |

Looking at the output, consider the line for subpart '06'. The total quantity used value of 15 is derived from a quantity of 3 directly for part '01' and a quantity of 6 for part '02' which is needed 2 times by part '01'.

### Example 3: Controlling depth

The question may come to mind, what happens when there are more levels of parts in the table than you are interested in for your query? That is, how is a query written to answer the question, "What are the first two levels of parts needed to build the part identified by '01'?" For the sake of clarity in the example, the level is included in the result.

```
WITH RPL (LEVEL, PART, SUBPART, QUANTITY) AS
(
  SELECT 1,          ROOT.PART, ROOT.SUBPART, ROOT.QUANTITY
  FROM PARTLIST ROOT
  WHERE ROOT.PART = '01'
  UNION ALL
  SELECT PARENT.LEVEL+1, CHILD.PART, CHILD.SUBPART, CHILD.QUANTITY
  FROM RPL PARENT, PARTLIST CHILD
  WHERE PARENT.SUBPART = CHILD.PART
        AND PARENT.LEVEL < 2
)
SELECT PART, LEVEL, SUBPART, QUANTITY
FROM RPL;
```

This query is similar to example 1. The column *LEVEL* was introduced to count the levels from the original part. In the initialization fullselect, the value for the *LEVEL* column is initialized to 1. In the subsequent fullselect, the level from the parent is incremented by 1. Then to control the number of levels in the result, the second fullselect includes the condition that the parent level must be less than 2. This ensures that the second fullselect only processes children to the second level.

The result of the query is:

| PART | LEVEL | SUBPART | QUANTITY |
|------|-------|---------|----------|
| 01   | 1     | 02      | 2        |
| 01   | 1     | 03      | 3        |
| 01   | 1     | 04      | 4        |
| 01   | 1     | 06      | 3        |
| 02   | 2     | 05      | 7        |
| 02   | 2     | 06      | 6        |
| 03   | 2     | 07      | 6        |
| 04   | 2     | 08      | 10       |
| 04   | 2     | 09      | 11       |
| 06   | 2     | 12      | 10       |
| 06   | 2     | 13      | 10       |

## update-clause

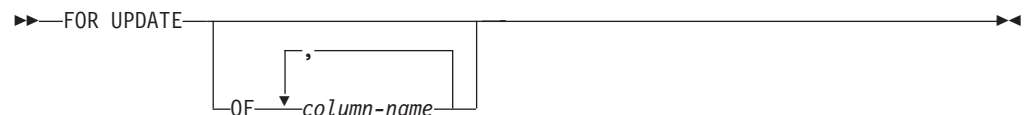

The FOR UPDATE clause identifies the columns that can be updated in a subsequent Positioned UPDATE statement. Each *column-name* must be unqualified and must identify a column of the table or view identified in the first FROM clause

## update-clause

of the fullselect. If the FOR UPDATE clause is specified without column names, all updatable columns of the table or view identified in the first FROM clause of the fullselect are included.

The FOR UPDATE clause cannot be used if one of the following is true:

- The cursor associated with the select-statement is not deletable .
- One of the selected columns is a non-updatable column of a catalog table and the FOR UPDATE clause has not been used to exclude that column.

## read-only-clause

►► FOR READ ONLY  
FETCH

The FOR READ ONLY clause indicates that the result table is read-only and therefore the cursor cannot be referred to in Positioned UPDATE and DELETE statements. FOR FETCH ONLY has the same meaning.

Some result tables are read-only by nature. (For example, a table based on a read-only view.) FOR READ ONLY can still be specified for such tables, but the specification has no effect.

For result tables in which updates and deletes are allowed, specifying FOR READ ONLY (or FOR FETCH ONLY) can possibly improve the performance of FETCH operations by allowing the database manager to do blocking. For example, in programs that contain dynamic SQL statements without the FOR READ ONLY or ORDER BY clause, the database manager might open cursors as if the FOR UPDATE clause were specified. It is recommended, therefore, that the FOR READ ONLY clause be used to improve performance, except in cases where queries will be used in positioned UPDATE or DELETE statements.

A read-only result table must not be referred to in a Positioned UPDATE or DELETE statement, whether it is read-only by nature or specified as FOR READ ONLY (FOR FETCH ONLY).

## optimize-for-clause

►► OPTIMIZE FOR *integer* ROWS  
ROW

The OPTIMIZE FOR clause requests special processing of the *select statement*. If the clause is omitted, it is assumed that all rows of the result table will be retrieved; if it is specified, it is assumed that the number of rows retrieved will probably not exceed *n*, where *n* is the value of *integer*. The value of *n* must be a positive integer. Use of the OPTIMIZE FOR clause influences query optimization, based on the assumption that *n* rows will be retrieved. In addition, for cursors that are blocked, this clause will influence the number of rows that will be returned in each block (that is, no more than *n* rows will be returned in each block). If both the *fetch-first-clause* and the *optimize-for-clause* are specified, the lower of the integer values from these clauses will be used to influence the communications buffer size. The values are considered independently for optimization purposes.



This clause does not limit the number of rows that can be fetched, or affect the result in any other way than performance. Using OPTIMIZE FOR *n* ROWS can improve performance if no more than *n* rows are retrieved, but may degrade performance if more than *n* rows are retrieved.

If the value of *n* multiplied by the size of the row exceeds the size of the communication buffer, the OPTIMIZE FOR clause will have no impact on the data buffers. The size of the communication buffer is defined by the RQRIOLBK or the ASLHEAPSZ configuration parameter.

## isolation-clause

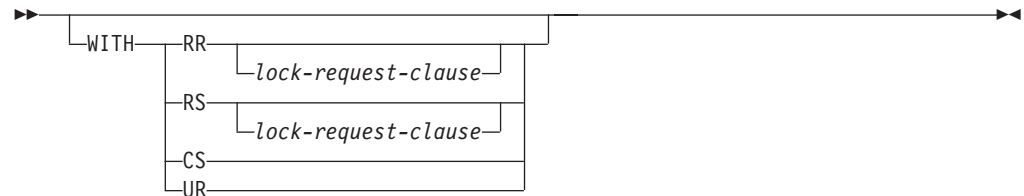

The optional *isolation-clause* specifies the isolation level at which the statement is executed, and whether a specific type of lock is to be acquired.

- RR - Repeatable Read
- RS - Read Stability
- CS - Cursor Stability
- UR - Uncommitted Read

The default isolation level of the statement is the isolation level of the package in which the statement is bound. When a nickname is used in a *select-statement* to access data in DB2 family and Microsoft SQL Server data sources, the *isolation-clause* can be included in the statement to specify the statement isolation level. If the *isolation-clause* is included in statements that access other data sources, the specified isolation level is ignored. The current isolation level on the federated server is mapped to a corresponding isolation level at the data source on each connection to the data source. After a connection is made to a data source, the isolation level cannot be changed for the duration of the connection.

## lock-request-clause



The optional *lock-request-clause* specifies the type of lock that the database manager is to acquire and hold:

- SHARE** Concurrent processes can acquire SHARE or UPDATE locks on the data.
- UPDATE** Concurrent processes can acquire SHARE locks on the data, but no concurrent process can acquire an UPDATE or EXCLUSIVE lock.
- EXCLUSIVE** Concurrent processes cannot acquire a lock on the data.

## lock-request-clause

The *lock-request-clause* applies to all base table and index scans required by the query, including those within subqueries, SQL functions and SQL methods. It has no effect on locks placed by procedures, external functions, or external methods. Any SQL function or SQL method invoked (directly or indirectly) by the statement must be created with INHERIT ISOLATION LEVEL WITH LOCK REQUEST (SQLSTATE 42601). The *lock-request-clause* cannot be used with a modifying query that might invoke triggers or that requires referential integrity checks (SQLSTATE 42601).

## Examples of a select-statement

*Example 1:* Select all columns and rows from the EMPLOYEE table.

```
SELECT * FROM EMPLOYEE
```

*Example 2:* Select the project name (PROJNAME), start date (PRSTDATE), and end date (PRENDATE) from the PROJECT table. Order the result table by the end date with the most recent dates appearing first.

```
SELECT PROJNAME, PRSTDATE, PRENDATE
FROM PROJECT
ORDER BY PRENDATE DESC
```

*Example 3:* Select the department number (WORKDEPT) and average departmental salary (SALARY) for all departments in the EMPLOYEE table. Arrange the result table in ascending order by average departmental salary.

```
SELECT WORKDEPT, AVG(SALARY)
FROM EMPLOYEE
GROUP BY WORKDEPT
ORDER BY 2
```

*Example 4:* Declare a cursor named UP\_CUR to be used in a C program to update the start date (PRSTDATE) and the end date (PRENDATE) columns in the PROJECT table. The program must receive both of these values together with the project number (PROJNO) value for each row.

```
EXEC SQL DECLARE UP_CUR CURSOR FOR
SELECT PROJNO, PRSTDATE, PRENDATE
FROM PROJECT
FOR UPDATE OF PRSTDATE, PRENDATE;
```

*Example 5:* This example names the expression SAL+BONUS+COMM as TOTAL\_PAY

```
SELECT SALARY+BONUS+COMM AS TOTAL_PAY
FROM EMPLOYEE
ORDER BY TOTAL_PAY
```

*Example 6:* Determine the employee number and salary of sales representatives along with the average salary and head count of their departments. Also, list the average salary of the department with the highest average salary.

Using a common table expression for this case saves the overhead of creating the DINFO view as a regular view. During statement preparation, accessing the catalog for the view is avoided and, because of the context of the rest of the fullselect, only the rows for the department of the sales representatives need to be considered by the view.

```
WITH
DINFO (DEPTNO, AVGSALARY, EMPCOUNT) AS
(SELECT OTHERS.WORKDEPT, AVG(OTHERS.SALARY), COUNT(*)
FROM EMPLOYEE OTHERS
GROUP BY OTHERS.WORKDEPT
```

```

),
DINFOMAX AS
  (SELECT MAX(AVGSALARY) AS AVGMAX FROM DINFO)
SELECT THIS_EMP.EMPNO, THIS_EMP.SALARY,
       DINFO.AVGSALARY, DINFO.EMPCOUNT, DINFOMAX.AVGMAX
FROM EMPLOYEE THIS_EMP, DINFO, DINFOMAX
WHERE THIS_EMP.JOB = 'SALESREP'
AND THIS_EMP.WORKDEPT = DINFO.DEPTNO

```

*Example 7:* Given two tables, EMPLOYEE and PROJECT, replace employee SALLY with a new employee GEORGE, assign all projects lead by SALLY to GEORGE, and return the names of the updated projects.

```

WITH
  NEWEMP AS (SELECT EMPNO FROM NEW TABLE
             (INSERT INTO EMPLOYEE(EMPNO, FIRSTNAME)
              VALUES(NEXT VALUE FOR EMPNO_SEQ, 'GEORGE'))),
  OLDEMP AS (SELECT EMPNO FROM EMPLOYEE WHERE FIRSTNAME = 'SALLY'),
  UPPROJ AS (SELECT PROJNAME FROM NEW TABLE
            (UPDATE PROJECT
             SET RESPEMP = (SELECT EMPNO FROM NEWEMP)
             WHERE RESPEMP = (SELECT EMPNO FROM OLDEMP))),
  DELEMP AS (SELECT EMPNO FROM OLD TABLE
            (DELETE FROM EMPLOYEE
             WHERE EMPNO = (SELECT EMPNO FROM OLDEMP)))
SELECT PROJNAME FROM UPPROJ;

```

*Example 8:* Retrieve data from the DEPT table. That data will later be updated with a searched update, and should be locked when the query executes.

```

SELECT DEPTNO, DEPTNAME, MGRNO
FROM DEPT
WHERE ADMRDEPT = 'A00'
FOR READ ONLY WITH RS USE AND KEEP EXCLUSIVE LOCKS

```

### Related reference:

- “DECLARE CURSOR statement” in *SQL Reference, Volume 2*
- “Subselect” on page 506



---

## Appendix A. SQL and XQuery limits

The following tables describe certain SQL and XQuery limits. Adhering to the most restrictive case can help you to design application programs that are easily portable.

Table 29. Identifier Length Limits

| Description  | Maximum in Bytes |
|--|------------------|
| Authorization name (can only be single-byte characters)  | 30               |
| Constraint name  | 18               |
| Correlation name   | 128              |
| Cursor name  | 18               |
| Data partition name  | 128              |
| Data source name   | 128              |
| External program name  | 8                |
| Function mapping name  | 128              |
| Host identifier <sup>1</sup>   | 255              |
| Identifier for a data source user ( <i>remote-authorization-name</i> )   | 30               |
| Identifier in an SQL procedure (condition name, for loop identifier, label, result set locator, statement name, variable name) | 128              |
| Label name   | 128              |
| Namespace uniform resource identifier (URI)  | 1000             |
| Package version ID   | 64               |
| Parameter name   | 128              |
| Password to access a data source   | 32               |
| Savepoint name   | 128              |
| XML schema location uniform resource identifier (URI)  | 1000             |
| SQL schema name <sup>2</sup>   | 30               |
| Security label component name  | 128              |
| Security label name  | 128              |
| Security policy name   | 128              |
| Server (database alias) name   | 8                |
| SQL condition name   | 128              |
| SQL variable name  | 128              |
| Statement name   | 18               |
| Transform group name   | 18               |
| Type mapping name  | 18               |
| Unqualified column name  | 30               |
| Unqualified data source column name  | 255              |
| Unqualified data source index name   | 128              |
| Unqualified data source table name ( <i>remote-table-name</i> )  | 128              |

Table 29. Identifier Length Limits (continued)

| Description  | Maximum in Bytes |
|--|------------------|
| Unqualified package name   | 8                |
| Unqualified alias name, function name, index name, method name, nickname, procedure name, sequence name, specific name, table name, or view name | 128              |
| Unqualified buffer pool name, database partition group name, table space name, trigger name, or type name  | 18               |
| Wrapper name   | 128              |
| XML element name, attribute name, or prefix name   | 1000             |
| <b>Notes:</b>  |                  |
| 1. Individual host language compilers might have a more restrictive limit on variable names.   |                  |
| 2. The SQL schema name for a user-defined type is limited to 8 bytes.  |                  |

Table 30. Numeric Limits

| Description                    | Limit                      |
|--------------------------------|----------------------------|
| Smallest SMALLINT value        | -32 768                    |
| Largest SMALLINT value         | +32 767                    |
| Smallest INTEGER value         | -2 147 483 648             |
| Largest INTEGER value          | +2 147 483 647             |
| Smallest BIGINT value          | -9 223 372 036 854 775 808 |
| Largest BIGINT value           | +9 223 372 036 854 775 807 |
| Largest decimal precision      | 31                         |
| Smallest DOUBLE value          | -1.79769E+308              |
| Largest DOUBLE value           | +1.79769E+308              |
| Smallest positive DOUBLE value | +2.225E-307                |
| Largest negative DOUBLE value  | -2.225E-307                |
| Smallest REAL value            | -3.402E+38                 |
| Largest REAL value             | +3.402E+38                 |
| Smallest positive REAL value   | +1.175E-37                 |
| Largest negative REAL value    | -1.175E-37                 |

Table 31. String Limits

| Description  | Limit         |
|--|---------------|
| Maximum length of CHAR (in bytes)                        | 254           |
| Maximum length of VARCHAR (in bytes)                     | 32 672        |
| Maximum length of LONG VARCHAR (in bytes)                | 32 700        |
| Maximum length of CLOB (in bytes)                        | 2 147 483 647 |
| Maximum length of serialized XML (in bytes)              | 2 147 483 647 |
| Maximum length of GRAPHIC (in double-byte characters)    | 127           |
| Maximum length of VARGRAPHIC (in double-byte characters) | 16 336        |

Table 31. String Limits (continued)

| Description  | Limit         |
|--|---------------|
| Maximum length of LONG VARCHAR (in double-byte characters)                     | 16 350        |
| Maximum length of DBCLOB (in double-byte characters)                           | 1 073 741 823 |
| Maximum length of BLOB (in bytes)  | 2 147 483 647 |
| Maximum length of character constant   | 32 672        |
| Maximum length of graphic constant   | 16 336        |
| Maximum length of concatenated character string                                | 2 147 483 647 |
| Maximum length of concatenated graphic string                                  | 1 073 741 823 |
| Maximum length of concatenated binary string                                   | 2 147 483 647 |
| Maximum number of hexadecimal constant digits                                  | 32 672        |
| Largest instance of a structured type column object at run time (in gigabytes) | 1             |
| Maximum size of a catalog comment (in bytes)                                   | 254           |

Table 32. XML Limits

| Description                                       | Limit      |
|---|------------|
| Maximum depth of an XML document (in levels)      | 125        |
| Maximum size of an XML schema document (in bytes) | 31 457 280 |

Table 33. Datetime Limits

| Description              | Limit                      |
|--------------------------|----------------------------|
| Smallest DATE value      | 0001-01-01                 |
| Largest DATE value       | 9999-12-31                 |
| Smallest TIME value      | 00:00:00                   |
| Largest TIME value       | 24:00:00                   |
| Smallest TIMESTAMP value | 0001-01-01-00.00.00.000000 |
| Largest TIMESTAMP value  | 9999-12-31-24.00.00.000000 |

Table 34. Database Manager Limits

| Description   | Limit                  |
|---|------------------------|
| <b>Tables and Views</b>   |                        |
| Maximum number of columns in a table <sup>7</sup>   | 1012                   |
| Maximum number of columns in a view <sup>1</sup>  | 5000                   |
| Maximum number of columns in a data source table or view that is referenced by a nickname | 5000                   |
| Maximum number of columns in a distribution key <sup>5</sup>                              | 500                    |
| Maximum length of a row including all overhead <sup>2 7</sup>                             | 32 677                 |
| Maximum number of rows in a non-partitioned table, per database partition                 | 128 × 10 <sup>10</sup> |
| Maximum number of rows in a data partition, per database partition                        | 128 × 10 <sup>10</sup> |

Table 34. Database Manager Limits (continued)

| <b>Description</b>  | <b>Limit</b>            |
|---|-------------------------|
| Maximum size of a table per database partition in a regular table space (in gigabytes) <sup>3 7</sup>               | 512                     |
| Maximum size of a table per database partition in a large DMS table space (in gigabytes) <sup>7</sup>               | 16 384                  |
| Maximum number of data partitions for a single table  | 32 767                  |
| Maximum number of table partitioning columns  | 16                      |
| <b>Constraints</b>  |                         |
| Maximum number of constraints on a table  | storage                 |
| Maximum number of columns in a UNIQUE constraint (supported through a UNIQUE index)                                 | 64                      |
| Maximum combined length of columns in a UNIQUE constraint (supported through a UNIQUE index, in bytes) <sup>9</sup> | 8192                    |
| Maximum number of referencing columns in a foreign key  | 64                      |
| Maximum combined length of referencing columns in a foreign key (in bytes) <sup>9</sup>                             | 8192                    |
| Maximum length of a check constraint specification (in bytes)   | 65 535                  |
| <b>Triggers</b>   |                         |
| Maximum run-time depth of cascading triggers  | 16                      |
| <b>User-defined Types</b>   |                         |
| Maximum number of attributes in a structured type   | 4082                    |
| <b>Indexes</b>  |                         |
| Maximum number of indexes on a table  | 32 767 or storage       |
| Maximum number of columns in an index key   | 64                      |
| Maximum length of an index key including all overhead <sup>7 9</sup>  | <i>indexpagesize/4</i>  |
| Maximum length of a variable index key part (in bytes) <sup>8</sup>   | 1022 or storage         |
| Maximum size of an index per database partition in an SMS table space (in gigabytes) <sup>7</sup>                   | 16 384                  |
| Maximum size of an index per database partition in a regular DMS table space (in gigabytes) <sup>7</sup>            | 512                     |
| Maximum size of an index per database partition in a large DMS table space (in gigabytes) <sup>7</sup>              | 16 384                  |
| Maximum size of an index over XML data per database partition (in terabytes)  | 2                       |
| Maximum length of a variable index key part for an index over XML data (in bytes) <sup>7</sup>                      | <i>pagesize/4 - 207</i> |
| <b>SQL</b>  |                         |
| Maximum total length of an SQL statement (in bytes)   | 2 097 152               |
| Maximum number of tables referenced in an SQL statement or a view   | storage                 |
| Maximum number of host variable references in an SQL statement  | 32 767                  |
| Maximum number of constants in a statement  | storage                 |
| Maximum number of elements in a select list <sup>7</sup>  | 1012                    |



Table 34. Database Manager Limits (continued)

| <b>Description</b>   | <b>Limit</b>  |
|--|---------------|
| Maximum number of predicates in a WHERE or HAVING clause                           | storage       |
| Maximum number of columns in a GROUP BY clause <sup>7</sup>                        | 1012          |
| Maximum total length of columns in a GROUP BY clause (in bytes) <sup>7</sup>       | 32 677        |
| Maximum number of columns in an ORDER BY clause <sup>7</sup>                       | 1012          |
| Maximum total length of columns in an ORDER BY clause (in bytes) <sup>7</sup>      | 32 677        |
| Maximum level of subquery nesting  | storage       |
| Maximum number of subqueries in a single statement                                 | storage       |
| Maximum number of values in an insert operation <sup>7</sup>                       | 1012          |
| Maximum number of SET clauses in a single update operation <sup>7</sup>            | 1012          |
| <b>Routines</b>  |               |
| Maximum number of parameters in a procedure  | 32 767        |
| Maximum number of parameters in a user-defined function                            | 90            |
| Maximum number of nested levels for routines                                       | 64            |
| <b>Applications</b>  |               |
| Maximum number of host variable declarations in a precompiled program <sup>3</sup> | storage       |
| Maximum length of a host variable value (in bytes)                                 | 2 147 483 647 |
| Maximum number of declared cursors in a program                                    | storage       |
| Maximum number of rows changed in a unit of work                                   | storage       |
| Maximum number of cursors opened at one time                                       | storage       |
| Maximum number of connections per process within a DB2 client                      | 512           |
| Maximum number of simultaneously opened LOB locators in a transaction              | 32 100        |
| Maximum size of an SQLDA (in bytes)  | storage       |
| Maximum number of prepared statements  | storage       |
| <b>Concurrency</b>   |               |
| Maximum number of concurrent users of a server <sup>4</sup>                        | 64 000        |
| Maximum number of concurrent users per instance                                    | 64 000        |
| Maximum number of concurrent applications per database                             | 60 000        |
| Maximum number of databases per instance concurrently in use                       | 256           |
| <b>Monitoring</b>  |               |
| Maximum number of simultaneously active event monitors                             | 32            |
| <b>Security</b>  |               |
| Maximum number of elements in a security label component of type set or tree       | 64            |
| Maximum number of elements in a security label component of type array             | 65 535        |

Table 34. Database Manager Limits (continued)

| Description  | Limit         |
|--|---------------|
| Maximum number of security label components in a security policy   | 16            |
| <b>Databases</b>   |               |
| Maximum database partition number  | 999           |
| <b>Table Spaces</b>  |               |
| Maximum number of table spaces in a database   | 32 768        |
| Maximum number of tables in an SMS table space   | 65 534        |
| Maximum size of a regular DMS table space (in gigabytes)<br><sup>3 7</sup>   | 512           |
| Maximum size of a large DMS table space (in terabytes) <sup>3 7</sup>  | 16            |
| Maximum size of a temporary DMS table space (in terabytes) <sup>3</sup>  | 16            |
| Maximum number of table objects in a DMS table space <sup>6</sup>  | 51 000        |
| Maximum number of storage paths in an automatic storage database   | 128           |
| Maximum length of a storage path that is associated with an automatic storage database (in bytes)  | 175           |
| <b>Buffer Pools</b>  |               |
| Maximum NPAGES in a buffer pool for 32-bit releases  | 1 048 576     |
| Maximum NPAGES in a buffer pool for 64-bit releases  | 2 147 483 647 |
| Maximum total size of all buffer pool slots (4K)   | 2 147 483 646 |
| <b>Notes:</b>  |               |
| <ol style="list-style-type: none"> <li>1. This maximum can be achieved using a join in the CREATE VIEW statement. Selecting from such a view is subject to the limit of most elements in a select list.</li> <li>2. The actual data for BLOB, CLOB, LONG VARCHAR, DBCLOB, and LONG VARGRAPHIC columns is not included in this count. However, information about the location of that data does take up some space in the row.</li> <li>3. The numbers shown are architectural limits and approximations. The practical limits may be less.</li> <li>4. The actual value will be the value of the MAXAGENTS configuration parameter.</li> <li>5. This is an architectural limit. The limit on the most columns in an index key should be used as the practical limit.</li> <li>6. Table objects include data, indexes, LONG VARCHAR or VARGRAPHIC columns, and LOB columns. Table objects that are in the same table space as the table data do not count extra toward the limit. However, each table object that is in a different table space than the table data does contribute one toward the limit for each table object type per table in the table space in which the table object resides.</li> <li>7. For page size-specific values, see Table 35 on page 565.</li> <li>8. This is limited only by the longest index key, including all overhead (in bytes). As the number of index key parts increases, the maximum length of each key part decreases.</li> <li>9. The maximum can be less, depending on index options.</li> </ol> |               |

Table 35. Database Manager Page Size-specific Limits

| Description   | 4K page size limit | 8K page size limit | 16K page size limit | 32K page size limit |
|---|--------------------|--------------------|---------------------|---------------------|
| Maximum number of columns in a table  | 500                | 1012               | 1012                | 1012                |
| Maximum length of a row including all overhead  | 4005               | 8101               | 16 293              | 32 677              |
| Maximum size of a table per database partition in a regular table space (in gigabytes)      | 64                 | 128                | 256                 | 512                 |
| Maximum size of a table per database partition in a large DMS table space (in gigabytes)    | 2048               | 4096               | 8192                | 16 384              |
| Maximum length of an index key including all overhead (in bytes)                            | 1024               | 2048               | 4096                | 8192                |
| Maximum size of an index per database partition in an SMS table space (in gigabytes)        | 2048               | 4096               | 8192                | 16 384              |
| Maximum size of an index per database partition in a regular DMS table space (in gigabytes) | 64                 | 128                | 256                 | 512                 |
| Maximum size of an index per database partition in a large DMS table space (in gigabytes)   | 2048               | 4096               | 8192                | 16 384              |
| Maximum size of an index over XML data per database partition (in terabytes)                | 2                  | 2                  | 2                   | 2                   |
| Maximum size of a regular DMS table space (in gigabytes)                                    | 64                 | 128                | 256                 | 512                 |
| Maximum size of a large DMS table space (in gigabytes)                                      | 2048               | 4096               | 8192                | 16 384              |
| Maximum number of elements in a select list   | 500                | 1012               | 1012                | 1012                |
| Maximum number of columns in a GROUP BY clause  | 500                | 1012               | 1012                | 1012                |
| Maximum total length of columns in a GROUP BY clause (in bytes)                             | 4005               | 8101               | 16 293              | 32 677              |
| Maximum number of columns in an ORDER BY clause   | 500                | 1012               | 1012                | 1012                |
| Maximum total length of columns in an ORDER BY clause (in bytes)                            | 4005               | 8101               | 16 293              | 32 677              |

## SQL limits

Table 35. Database Manager Page Size-specific Limits (continued)

| Description  | 4K page size limit | 8K page size limit | 16K page size limit | 32K page size limit |
|--|--------------------|--------------------|---------------------|---------------------|
| Maximum number of values in an insert operation            | 500                | 1012               | 1012                | 1012                |
| Maximum number of SET clauses in a single update operation | 500                | 1012               | 1012                | 1012                |

**Related reference:**

- “maxagents - Maximum number of agents configuration parameter” in *Performance Guide*

---

## Appendix B. SQLCA (SQL communications area)

An SQLCA is a collection of variables that is updated at the end of the execution of every SQL statement. A program that contains executable SQL statements and is precompiled with option LANGLEVEL SAA1 (the default) or MIA must provide exactly one SQLCA, though more than one SQLCA is possible by having one SQLCA per thread in a multi-threaded application.

When a program is precompiled with option LANGLEVEL SQL92E, an SQLCODE or SQLSTATE variable may be declared in the SQL declare section or an SQLCODE variable can be declared somewhere in the program.

An SQLCA should not be provided when using LANGLEVEL SQL92E. The SQL INCLUDE statement can be used to provide the declaration of the SQLCA in all languages but REXX. The SQLCA is automatically provided in REXX.

To display the SQLCA after each command executed through the command line processor, issue the command db2 -a. The SQLCA is then provided as part of the output for subsequent commands. The SQLCA is also dumped in the db2diag.log file.

---

### SQLCA field descriptions

*Table 36. Fields of the SQLCA.* The field names shown are those present in an SQLCA that is obtained via an INCLUDE statement.

| Name     | Data Type | Field Values  |
|----------|-----------|---|
| sqlcaid  | CHAR(8)   | An "eye catcher" for storage dumps containing 'SQLCA'. The sixth byte is 'L' if line number information is returned from parsing an SQL procedure body.   |
| sqlcab   | INTEGER   | Contains the length of the SQLCA, 136.  |
| sqlcode  | INTEGER   | Contains the SQL return code.<br><br><b>Code</b> <b>Means</b><br><br><b>0</b> Successful execution (although one or more SQLWARN indicators may be set).<br><br><b>positive</b><br>Successful execution, but with a warning condition.<br><br><b>negative</b><br>Error condition. |
| sqlerrml | SMALLINT  | Length indicator for <i>sqlerrmc</i> , in the range 0 through 70. 0 means that the value of <i>sqlerrmc</i> is not relevant.  |

## SQLCA field descriptions

Table 36. Fields of the SQLCA (continued). The field names shown are those present in an SQLCA that is obtained via an INCLUDE statement.

| Name       | Data Type       | Field Values   |
|------------|-----------------|--|
| sqlerrmc   | VARCHAR<br>(70) | <p>Contains one or more tokens, separated by X'FF', which are substituted for variables in the descriptions of error conditions.</p> <p>This field is also used when a successful connection is completed.</p> <p>When a NOT ATOMIC compound SQL statement is issued, it may contain information on up to seven errors.</p> <p>The last token might be followed by X'FF'. The <i>sqlerrml</i> value will include any trailing X'FF'.</p>   |
| sqlerrp    | CHAR(8)         | <p>Begins with a three-letter identifier indicating the product, followed by five digits indicating the version, release, and modification level of the product. For example, SQL09010 means DB2 V9.1 (version 9, release 1, modification level 0).</p> <p>If SQLCODE indicates an error condition, this field identifies the module that returned the error.</p> <p>This field is also used when a successful connection is completed.</p>  |
| sqlerrd    | ARRAY           | <p>Six INTEGER variables that provide diagnostic information. These values are generally empty if there are no errors, except for sqlerrd(6) from a partitioned database.</p>  |
| sqlerrd(1) | INTEGER         | <p>If connection is invoked and successful, contains the maximum expected difference in length of mixed character data (CHAR data types) when converted to the database code page from the application code page. A value of 0 or 1 indicates no expansion; a value greater than 1 indicates a possible expansion in length; a negative value indicates a possible contraction.</p> <p>On successful return from an SQL procedure, contains the return status value from the SQL procedure.</p>  |
| sqlerrd(2) | INTEGER         | <p>If connection is invoked and successful, contains the maximum expected difference in length of mixed character data (CHAR data types) when converted to the application code page from the database code page. A value of 0 or 1 indicates no expansion; a value greater than 1 indicates a possible expansion in length; a negative value indicates a possible contraction. If the SQLCA results from a NOT ATOMIC compound SQL statement that encountered one or more errors, the value is set to the number of statements that failed.</p> |

Table 36. Fields of the SQLCA (continued). The field names shown are those present in an SQLCA that is obtained via an INCLUDE statement.

| Name       | Data Type | Field Values  |
|------------|-----------|---|
| sqlerrd(3) | INTEGER   | <p>If PREPARE is invoked and successful, contains an estimate of the number of rows that will be returned. After INSERT, UPDATE, DELETE, or MERGE, contains the actual number of rows that qualified for the operation. If compound SQL is invoked, contains an accumulation of all sub-statement rows. If CONNECT is invoked, contains 1 if the database can be updated, or 2 if the database is read only.</p> <p>If the OPEN statement is invoked, and the cursor contains SQL data change statements, this field contains the sum of the number of rows that qualified for the embedded insert, update, delete, or merge operations.</p> <p>If CREATE PROCEDURE for an SQL procedure is invoked, and an error is encountered when parsing the SQL procedure body, contains the line number where the error was encountered. The sixth byte of sqlcaid must be 'L' for this to be a valid line number.</p>                               |
| sqlerrd(4) | INTEGER   | <p>If PREPARE is invoked and successful, contains a relative cost estimate of the resources required to process the statement. If compound SQL is invoked, contains a count of the number of successful sub-statements. If CONNECT is invoked, contains 0 for a one-phase commit from a down-level client; 1 for a one-phase commit; 2 for a one-phase, read-only commit; and 3 for a two-phase commit.</p>   |
| sqlerrd(5) | INTEGER   | <p>Contains the total number of rows deleted, inserted, or updated as a result of both:</p> <ul style="list-style-type: none"> <li>The enforcement of constraints after a successful delete operation</li> <li>The processing of triggered SQL statements from activated triggers</li> </ul> <p>If compound SQL is invoked, contains an accumulation of the number of such rows for all sub-statements. In some cases, when an error is encountered, this field contains a negative value that is an internal error pointer. If CONNECT is invoked, contains an authentication type value of 0 for server authentication; 1 for client authentication; 2 for authentication using DB2 Connect™; 4 for SERVER_ENCRYPT authentication; 5 for authentication using DB2 Connect with encryption; 7 for KERBEROS authentication; 9 for GSSPLUGIN authentication; 11 for DATA_ENCRYPT authentication; and 255 for unspecified authentication.</p> |
| sqlerrd(6) | INTEGER   | <p>For a partitioned database, contains the partition number of the database partition that encountered the error or warning. If no errors or warnings were encountered, this field contains the partition number of the coordinator partition. The number in this field is the same as that specified for the database partition in the db2nodes.cfg file.</p>   |
| sqlwarn    | Array     | <p>A set of warning indicators, each containing a blank or W. If compound SQL is invoked, contains an accumulation of the warning indicators set for all sub-statements.</p>  |

## SQLCA field descriptions

Table 36. Fields of the SQLCA (continued). The field names shown are those present in an SQLCA that is obtained via an INCLUDE statement.

| Name      | Data Type | Field Values   |
|-----------|-----------|--|
| sqlwarn0  | CHAR(1)   | Blank if all other indicators are blank; contains 'W' if at least one other indicator is not blank.  |
| sqlwarn1  | CHAR(1)   | Contains 'W' if the value of a string column was truncated when assigned to a host variable. Contains 'N' if the null terminator was truncated. Contains 'A' if the CONNECT or ATTACH is successful, and the authorization name for the connection is longer than 8 bytes. Contains 'P' if the PREPARE statement relative cost estimate stored in sqlerrd(4) exceeded the value that could be stored in an INTEGER or was less than 1, and either the CURRENT EXPLAIN MODE or the CURRENT EXPLAIN SNAPSHOT special register is set to a value other than NO. |
| sqlwarn2  | CHAR(1)   | Contains 'W' if null values were eliminated from the argument of a column function. <sup>a</sup><br><br>If CONNECT is invoked and successful, contains 'D' if the database is in quiesce state, or 'I' if the instance is in quiesce state.  |
| sqlwarn3  | CHAR(1)   | Contains 'W' if the number of columns is not equal to the number of host variables. Contains 'Z' if the number of result set locators specified on the ASSOCIATE LOCATORS statement is less than the number of result sets returned by a procedure.  |
| sqlwarn4  | CHAR(1)   | Contains 'W' if a prepared UPDATE or DELETE statement does not include a WHERE clause.   |
| sqlwarn5  | CHAR(1)   | Contains 'E' if an error was tolerated during SQL statement execution.   |
| sqlwarn6  | CHAR(1)   | Contains 'W' if the result of a date calculation was adjusted to avoid an impossible date.   |
| sqlwarn7  | CHAR(1)   | Reserved for future use.<br><br>If CONNECT is invoked and successful, contains 'E' if the DYN_QUERY_MGMT database configuration parameter is enabled.  |
| sqlwarn8  | CHAR(1)   | Contains 'W' if a character that could not be converted was replaced with a substitution character.  |
| sqlwarn9  | CHAR(1)   | Contains 'W' if arithmetic expressions with errors were ignored during column function processing.   |
| sqlwarn10 | CHAR(1)   | Contains 'W' if there was a conversion error when converting a character data value in one of the fields in the SQLCA.   |
| sqlstate  | CHAR(5)   | A return code that indicates the outcome of the most recently executed SQL statement.  |

<sup>a</sup> Some functions may not set SQLWARN2 to W, even though null values were eliminated, because the result was not dependent on the elimination of null values.

---

## Error reporting

The order of error reporting is as follows:



1. Severe error conditions are always reported. When a severe error is reported, there are no additions to the SQLCA.
2. If no severe error occurs, a deadlock error takes precedence over other errors.
3. For all other errors, the SQLCA for the first negative SQL code is returned.
4. If no negative SQL codes are detected, the SQLCA for the first warning (that is, positive SQL code) is returned.

In a partitioned database system, the exception to this rule occurs if a data manipulation operation is invoked against a table that is empty on one database partition, but has data on other database partitions. SQLCODE +100 is only returned to the application if agents from all database partitions return SQL0100W, either because the table is empty on all database partitions, or there are no more rows that satisfy the WHERE clause in an UPDATE statement.

---

### SQLCA usage in partitioned database systems

In partitioned database systems, one SQL statement may be executed by a number of agents on different database partitions, and each agent may return a different SQLCA for different errors or warnings. The coordinator agent also has its own SQLCA.

To provide a consistent view for applications, all SQLCA values are merged into one structure, and SQLCA fields indicate global counts, such that:

- For all errors and warnings, the *sqlwarn* field contains the warning flags received from all agents.
- Values in the *sqlerrd* fields indicating row counts are accumulations from all agents.

Note that SQLSTATE 09000 may not be returned every time an error occurs during the processing of a triggered SQL statement.



---

## Appendix C. SQLDA (SQL descriptor area)

An SQLDA is a collection of variables that is required for execution of the SQL DESCRIBE statement. The SQLDA variables are options that can be used by the PREPARE, OPEN, FETCH, and EXECUTE statements. An SQLDA communicates with dynamic SQL; it can be used in a DESCRIBE statement, modified with the addresses of host variables, and then reused in a FETCH or EXECUTE statement.

SQLDAs are supported for all languages, but predefined declarations are provided only for C, REXX, FORTRAN, and COBOL.

The meaning of the information in an SQLDA depends on its use. In PREPARE and DESCRIBE, an SQLDA provides information to an application program about a prepared statement. In OPEN, EXECUTE, and FETCH, an SQLDA describes host variables.

In DESCRIBE and PREPARE, if any one of the columns being described is either a LOB type (LOB locators and file reference variables do not require doubled SQLDAs), reference type, or a user-defined type, the number of SQLVAR entries for the entire SQLDA will be doubled. For example:

- When describing a table with 3 VARCHAR columns and 1 INTEGER column, there will be 4 SQLVAR entries
- When describing a table with 2 VARCHAR columns, 1 CLOB column, and 1 integer column, there will be 8 SQLVAR entries

In EXECUTE, FETCH, and OPEN, if any one of the variables being described is a LOB type (LOB locators and file reference variables do not require doubled SQLDAs) or a structured type, the number of SQLVAR entries for the entire SQLDA must be doubled. (Distinct types and reference types are not relevant in these cases, because the additional information in the double entries is not required by the database.)

---

### SQLDA field descriptions

An SQLDA consists of four variables followed by an arbitrary number of occurrences of a sequence of variables collectively named SQLVAR. In OPEN, FETCH, and EXECUTE, each occurrence of SQLVAR describes a host variable. In DESCRIBE and PREPARE, each occurrence of SQLVAR describes a column of a result table or a parameter marker. There are two types of SQLVAR entries:

- **Base SQLVARs:** These entries are always present. They contain the base information about the column, parameter marker, or host variable such as data type code, length attribute, column name, host variable address, and indicator variable address.
- **Secondary SQLVARs:** These entries are only present if the number of SQLVAR entries is doubled as per the rules outlined above. For user-defined types (distinct or structured), they contain the user-defined type name. For reference types, they contain the target type of the reference. For LOBs, they contain the length attribute of the host variable and a pointer to the buffer that contains the actual length. (The distinct type and LOB information does not overlap, so distinct types can be based on LOBs without forcing the number of SQLVAR entries on a DESCRIBE to be tripled.) If locators or file reference variables are used to represent LOBs, these entries are not necessary.

## SQLDA field descriptions

In SQLDAs that contain both types of entries, the base SQLVARs are in a block before the block of secondary SQLVARs. In each, the number of entries is equal to the value in SQLD (even though many of the secondary SQLVAR entries may be unused).

The circumstances under which the SQLVAR entries are set by DESCRIBE is detailed in “Effect of DESCRIBE on the SQLDA” on page 578.

### Fields in the SQLDA header

Table 37. Fields in the SQLDA Header

| C Name  | SQL Data Type | Usage in DESCRIBE and PREPARE (set by the database manager except for SQLN)   | Usage in FETCH, OPEN, and EXECUTE (set by the application prior to executing the statement)  |
|---------|---------------|---|--|
| sqldaid | CHAR(8)       | The seventh byte of this field is a flag byte named SQLDOUBLED. The database manager sets SQLDOUBLED to the character '2' if two SQLVAR entries have been created for each column; otherwise it is set to a blank (X'20' in ASCII, X'40' in EBCDIC). See “Effect of DESCRIBE on the SQLDA” on page 578 for details on when SQLDOUBLED is set. | The seventh byte of this field is used when the number of SQLVARs is doubled. It is named SQLDOUBLED. If any of the host variables being described is a structured type, BLOB, CLOB, or DBCLOB, the seventh byte must be set to the character '2'; otherwise it can be set to any character but the use of a blank is recommended. |
| sqldabc | INTEGER       | For 32 bit, the length of the SQLDA, equal to SQLN*44+16. For 64 bit, the length of the SQLDA, equal to SQLN*56+16  | For 32 bit, the length of the SQLDA, >= to SQLN*44+16. For 64 bit, the length of the SQLDA, >= to SQLN*56+16.  |
| sqln    | SMALLINT      | Unchanged by the database manager. Must be set to a value greater than or equal to zero before the DESCRIBE statement is executed. Indicates the total number of occurrences of SQLVAR.   | Total number of occurrences of SQLVAR provided in the SQLDA. SQLN must be set to a value greater than or equal to zero.  |
| sqld    | SMALLINT      | Set by the database manager to the number of columns in the result table or to the number of parameter markers.   | The number of host variables described by occurrences of SQLVAR.   |

## Fields in an occurrence of a base SQLVAR

Table 38. Fields in a Base SQLVAR

| Name    | Data Type | Usage in DESCRIBE and PREPARE  | Usage in FETCH, OPEN, and EXECUTE   |
|---------|-----------|--|---|
| sqltype | SMALLINT  | <p>Indicates the data type of the column or parameter marker, and whether it can contain nulls. (Parameter markers are always considered nullable.) Table 40 on page 579 lists the allowable values and their meanings.</p> <p>Note that for a distinct or reference type, the data type of the base type is placed into this field. For a structured type, the data type of the result of the FROM SQL transform function of the transform group (based on the CURRENT DEFAULT TRANSFORM GROUP special register) for the type is placed into this field. There is no indication in the base SQLVAR that it is part of the description of a user-defined type or reference type.</p> | <p>Same for host variable. Host variables for datetime values must be character string variables. For FETCH, a datetime type code means a fixed-length character string. If sqltype is an even number value, the sqlind field is ignored.</p>   |
| sqllen  | SMALLINT  | <p>The length attribute of the column or parameter marker. For datetime columns and parameter markers, the length of the string representation of the values. See Table 40 on page 579.</p> <p>Note that the value is set to 0 for large object strings (even for those whose length attribute is small enough to fit into a two byte integer).</p>  | <p>The length attribute of the host variable. See Table 40 on page 579.</p> <p>Note that the value is ignored by the database manager for CLOB, DBCLOB, and BLOB columns. The len.sqllonglen field in the Secondary SQLVAR is used instead.</p> |
| sqldata | pointer   | <p>For string SQLVARs, sqldata contains the code page. For character-string SQLVARs where the column is defined with the FOR BIT DATA attribute, sqldata contains 0. For other character-string SQLVARs, sqldata contains either the SBCS code page for SBCS data, or the SBCS code page associated with the composite MBCS code page for MBCS data. For Japanese EUC, Traditional Chinese EUC, and Unicode UTF-8 character-string SQLVARs, sqldata contains 954, 964, and 1208 respectively.</p> <p>For all other column types, sqldata is undefined.</p>   | <p>Contains the address of the host variable (where the fetched data will be stored).</p>   |
| sqlind  | pointer   | <p>For character-string SQLVARs, sqlind contains 0, except for MBCS data, when sqlind contains the DBCS code page associated with the composite MBCS code page.</p> <p>For all other types, sqlind is undefined.</p>   | <p>Contains the address of an associated indicator variable, if there is one; otherwise, not used. If sqltype is an even number value, the sqlind field is ignored.</p>   |

## Fields in an occurrence of a base SQLVAR

Table 38. Fields in a Base SQLVAR (continued)

| Name    | Data Type       | Usage in DESCRIBE and PREPARE  | Usage in FETCH, OPEN, and EXECUTE  |
|---------|-----------------|--|--|
| sqlname | VARCHAR<br>(30) | <p>Contains the unqualified name of the column or parameter marker.</p> <p>For columns and parameter markers that have a system-generated name, the thirtieth byte is set to X'FF'. For column names specified by the AS clause, this byte is X'00'.</p> | <p>When connecting to a host database, sqlname can be set to indicate a FOR BIT DATA string as follows:</p> <ul style="list-style-type: none"> <li>• The sixth byte of the SQLDAID in the SQLDA header is set to '+'</li> <li>• The length of sqlname is 8</li> <li>• The first two bytes of sqlname are X'0000'</li> <li>• The third and fourth bytes of sqlname are X'0000'</li> <li>• The remaining four bytes of sqlname are reserved and should be set to X'00000000'</li> </ul> <p>When working with XML data, sqlname can be set to indicate an XML subtype as follows:</p> <ul style="list-style-type: none"> <li>• The length of sqlname is 8</li> <li>• The first two bytes of sqlname are X'0000'</li> <li>• The third and fourth bytes of sqlname are X'0000'</li> <li>• The fifth byte of sqlname is X'01'</li> <li>• The remaining three bytes of sqlname are reserved and should be set to X'000000'</li> </ul> |

## Fields in an occurrence of a secondary SQLVAR

Table 39. Fields in a Secondary SQLVAR

| Name           | Data Type                                    | Usage in DESCRIBE and PREPARE   | Usage in FETCH, OPEN, and EXECUTE  |
|----------------|--|---|--|
| len.sqllonglen | INTEGER                                      | The length attribute of a BLOB, CLOB, or DBCLOB column or parameter marker. | The length attribute of a BLOB, CLOB, or DBCLOB host variable. The database manager ignores the SQLLEN field in the Base SQLVAR for the data types. The length attribute stores the number of bytes for a BLOB or CLOB, and the number of double-byte characters for a DBCLOB. |
| reserve2       | CHAR(3) for 32 bit, and CHAR(11) for 64 bit. | Not used.   | Not used.  |

## Fields in an occurrence of a secondary SQLVAR

Table 39. Fields in a Secondary SQLVAR (continued)

| Name             | Data Type   | Usage in DESCRIBE and PREPARE   | Usage in FETCH, OPEN, and EXECUTE  |
|------------------|-------------|---|--|
| sqlflag4         | CHAR(1)     | The value is X'01' if the SQLVAR represents a reference type with a target type named in sqldatatype_name. The value is X'12' if the SQLVAR represents a structured type, with the user-defined type name in sqldatatype_name. Otherwise, the value is X'00'. | Set to X'01' if the SQLVAR represents a reference type with a target type named in sqldatatype_name. Set to X'12' if the SQLVAR represents a structured type, with the user-defined type name in sqldatatype_name. Otherwise, the value is X'00'.  |
| sqldatalen       | pointer     | Not used.   | Used for BLOB, CLOB, and DBCLOB host variables only.<br><br>If this field is NULL, then the actual length (in double-byte characters) should be stored in the 4 bytes immediately before the start of the data and SQLDATA should point to the first byte of the field length.<br><br>If this field is not NULL, it contains a pointer to a 4 byte long buffer that contains the actual length <i>in bytes</i> (even for DBCLOB) of the data in the buffer pointed to from the SQLDATA field in the matching base SQLVAR.<br><br>Note that, whether or not this field is used, the len.sqllonglen field must be set. |
| sqldatatype_name | VARCHAR(27) | For a user-defined type, the database manager sets this to the fully qualified user-defined type name. <sup>1</sup> For a reference type, the database manager sets this to the fully qualified type name of the target type of the reference.                | For structured types, set to the fully qualified user-defined type name in the format indicated in the table note. <sup>1</sup>  |
| reserved         | CHAR(3)     | Not used.   | Not used.  |

<sup>1</sup> The first 8 bytes contain the schema name of the type (extended to the right with spaces, if necessary). Byte 9 contains a dot (.). Bytes 10 to 27 contain the low order portion of the type name, which is *not* extended to the right with spaces.

Note that, although the prime purpose of this field is for the name of user-defined types, the field is also set for IBM predefined data types. In this case, the schema name is SYSIBM, and the low order portion of the name is the name stored in the TYPENAME column of the DATATYPES catalog view. For example:

| type name       | length | sqldatatype_name |
|-----------------|--------|------------------|
| -----           | -----  | -----            |
| A.B             | 10     | A .B             |
| INTEGER         | 16     | SYSIBM .INTEGER  |
| "Frank's".SMINT | 13     | Frank's .SMINT   |
| MY."type "      | 15     | MY .type         |

---

### Effect of DESCRIBE on the SQLDA

For a DESCRIBE OUTPUT or PREPARE OUTPUT INTO statement, the database manager always sets SQLD to the number of columns in the result set, or the number of output parameter markers. For a DESCRIBE INPUT or PREPARE INPUT INTO statement, the database manager always sets SQLD to the number of input parameter markers in the statement. Note that a parameter marker that corresponds to an INOUT parameter in a CALL statement is described in both the input and output descriptors.

The SQLVARs in the SQLDA are set in the following cases:

- $SQLN \geq SQLD$  and no entry is either a LOB, user-defined type or reference type  
The first SQLD SQLVAR entries are set and SQLDOUBLED is set to blank.
- $SQLN \geq 2 * SQLD$  and at least one entry is a LOB, user-defined type or reference type  
Two times SQLD SQLVAR entries are set, and SQLDOUBLED is set to '2'.
- $SQLD \leq SQLN < 2 * SQLD$  and at least one entry is a distinct type or reference type, but there are no LOB entries or structured type entries  
The first SQLD SQLVAR entries are set and SQLDOUBLED is set to blank. If the SQLWARN bind option is YES, a warning SQLCODE +237 (SQLSTATE 01594) is issued.

The SQLVARs in the SQLDA are NOT set (requiring allocation of additional space and another DESCRIBE) in the following cases:

- $SQLN < SQLD$  and no entry is either a LOB, user-defined type or reference type  
No SQLVAR entries are set and SQLDOUBLED is set to blank. If the SQLWARN bind option is YES, a warning SQLCODE +236 (SQLSTATE 01005) is issued.  
Allocate SQLD SQLVARs for a successful DESCRIBE.
- $SQLN < SQLD$  and at least one entry is a distinct type or reference type, but there are no LOB entries or structured type entries  
No SQLVAR entries are set and SQLDOUBLED is set to blank. If the SQLWARN bind option is YES, a warning SQLCODE +239 (SQLSTATE 01005) is issued.  
Allocate  $2 * SQLD$  SQLVARs for a successful DESCRIBE including the names of the distinct types and target types of reference types.
- $SQLN < 2 * SQLD$  and at least one entry is a LOB or a structured type  
No SQLVAR entries are set and SQLDOUBLED is set to blank. A warning SQLCODE +238 (SQLSTATE 01005) is issued (regardless of the setting of the SQLWARN bind option).  
Allocate  $2 * SQLD$  SQLVARs for a successful DESCRIBE.

References in the above lists to LOB entries include distinct type entries whose source type is a LOB type.

The SQLWARN option of the BIND or PREP command is used to control whether the DESCRIBE (or PREPARE INTO) will return the warning SQLCODEs +236, +237, +239. It is recommended that your application code always consider that these SQLCODEs could be returned. The warning SQLCODE +238 is always returned when there are LOB or structured type entries in the select list and there are insufficient SQLVARs in the SQLDA. This is the only way the application can know that the number of SQLVARs must be doubled because of a LOB or structured type entry in the result set.



If a structured type entry is being described, but no FROM SQL transform is defined (either because no TRANSFORM GROUP was specified using the CURRENT DEFAULT TRANSFORM GROUP special register (SQLSTATE 42741), or because the name group does not have a FROM SQL transform function defined (SQLSTATE 42744), the DESCRIBE will return an error. This error is the same error returned for a DESCRIBE of a table with a structured type entry.

## SQLTYPE and SQLLEN

Table 40 shows the values that may appear in the SQLTYPE and SQLLEN fields of the SQLDA. In DESCRIBE and PREPARE INTO, an even value of SQLTYPE means that the column does not allow nulls, and an odd value means the column does allow nulls. In FETCH, OPEN, and EXECUTE, an even value of SQLTYPE means that no indicator variable is provided, and an odd value means that SQLIND contains the address of an indicator variable.

Table 40. SQLTYPE and SQLLEN values for DESCRIBE, FETCH, OPEN, and EXECUTE

| SQLTYPE | For DESCRIBE and PREPARE INTO        |                                | For FETCH, OPEN, and EXECUTE                                |                                       |
|---------|--------------------------------------|--------------------------------|---|---------------------------------------|
|         | Column Data Type                     | SQLLEN                         | Host Variable Data Type                                     | SQLLEN                                |
| 384/385 | date                                 | 10                             | fixed-length character string representation of a date      | length attribute of the host variable |
| 388/389 | time                                 | 8                              | fixed-length character string representation of a time      | length attribute of the host variable |
| 392/393 | timestamp                            | 26                             | fixed-length character string representation of a timestamp | length attribute of the host variable |
| 396/397 | DATALINK                             | length attribute of the column | DATALINK  | length attribute of the host variable |
| 400/401 | N/A                                  | N/A                            | NUL-terminated graphic string                               | length attribute of the host variable |
| 404/405 | BLOB                                 | 0 *                            | BLOB  | Not used. *                           |
| 408/409 | CLOB                                 | 0 *                            | CLOB  | Not used. *                           |
| 412/413 | DBCLOB                               | 0 *                            | DBCLOB  | Not used. *                           |
| 448/449 | varying-length character string      | length attribute of the column | varying-length character string                             | length attribute of the host variable |
| 452/453 | fixed-length character string        | length attribute of the column | fixed-length character string                               | length attribute of the host variable |
| 456/457 | long varying-length character string | length attribute of the column | long varying-length character string                        | length attribute of the host variable |
| 460/461 | N/A                                  | N/A                            | NUL-terminated character string                             | length attribute of the host variable |
| 464/465 | varying-length graphic string        | length attribute of the column | varying-length graphic string                               | length attribute of the host variable |
| 468/469 | fixed-length graphic string          | length attribute of the column | fixed-length graphic string                                 | length attribute of the host variable |
| 472/473 | long varying-length graphic string   | length attribute of the column | long graphic string   | length attribute of the host variable |

## SQLTYPE and SQLLEN

Table 40. SQLTYPE and SQLLEN values for DESCRIBE, FETCH, OPEN, and EXECUTE (continued)

| For DESCRIBE and PREPARE INTO |                  |  | For FETCH, OPEN, and EXECUTE  |  |
|-------------------------------|------------------|--|---|--|
| SQLTYPE                       | Column Data Type | SQLLEN   | Host Variable Data Type   | SQLLEN   |
| 480/481                       | floating point   | 8 for double precision, 4 for single precision | floating point  | 8 for double precision, 4 for single precision |
| 484/485                       | packed decimal   | precision in byte 1; scale in byte 2           | packed decimal  | precision in byte 1; scale in byte 2           |
| 492/493                       | big integer      | 8  | big integer   | 8  |
| 496/497                       | large integer    | 4  | large integer   | 4  |
| 500/501                       | small integer    | 2  | small integer   | 2  |
| 916/917                       | Not applicable   | Not applicable                                 | BLOB file reference variable.   | 267  |
| 920/921                       | Not applicable   | Not applicable                                 | CLOB file reference variable.   | 267  |
| 924/925                       | Not applicable   | Not applicable                                 | DBCLOB file reference variable.   | 267  |
| 960/961                       | Not applicable   | Not applicable                                 | BLOB locator  | 4  |
| 964/965                       | Not applicable   | Not applicable                                 | CLOB locator  | 4  |
| 968/969                       | Not applicable   | Not applicable                                 | DBCLOB locator  | 4  |
| 988/989                       | XML              | 0  | None applicable. Use an XML AS <string or binary LOB type> host variable instead. | Not used.                                      |

**Note:**

- The len.sqllonglen field in the secondary SQLVAR contains the length attribute of the column.
- The SQLTYPE has changed from the previous version for portability in DB2. The values from the previous version (see previous version SQL Reference) will continue to be supported.

## Unrecognized and unsupported SQLTYPES

The values that appear in the SQLTYPE field of the SQLDA are dependent on the level of data type support available at the sender as well as at the receiver of the data. This is particularly important as new data types are added to the product.

New data types may or may not be supported by the sender or receiver of the data and may or may not even be recognized by the sender or receiver of the data. Depending on the situation, the new data type may be returned, or a compatible data type agreed upon by both the sender and receiver of the data may be returned or an error may result.

When the sender and receiver agree to use a compatible data type, the following indicates the mapping that will take place. This mapping will take place when at least one of the sender or the receiver does not support the data type provided. The unsupported data type can be provided by either the application or the database manager.

| Data Type | Compatible Data Type |
|-----------|----------------------|
| BIGINT    | DECIMAL(19, 0)       |

| Data Type          | Compatible Data Type     |
|--------------------|--------------------------|
| ROWID <sup>1</sup> | VARCHAR(40) FOR BIT DATA |

<sup>1</sup> ROWID is supported by DB2 Universal Database for z/OS Version 8.

Note that no indication is given in the SQLDA that the data type is substituted.

### Packed decimal numbers

Packed decimal numbers are stored in a variation of Binary Coded Decimal (BCD) notation. In BCD, each nybble (four bits) represents one decimal digit. For example, 0001 0111 1001 represents 179. Therefore, read a packed decimal value nybble by nybble. Store the value in bytes and then read those bytes in hexadecimal representation to return to decimal. For example, 0001 0111 1001 becomes 00000001 01111001 in binary representation. By reading this number as hexadecimal, it becomes 0179.

The decimal point is determined by the scale. In the case of a DEC(12,5) column, for example, the rightmost 5 digits are to the right of the decimal point.

Sign is indicated by a nybble to the right of the nybbles representing the digits. A positive or negative sign is indicated as follows:

*Table 41. Values for Sign Indicator of a Packed Decimal Number*

| Sign         | Representation |         |             |
|--------------|----------------|---------|-------------|
|              | Binary         | Decimal | Hexadecimal |
| Positive (+) | 1100           | 12      | C           |
| Negative (-) | 1101           | 13      | D           |

In summary:

- To store any value, allocate  $p/2+1$  bytes, where  $p$  is precision.
- Assign the nybbles from left to right to represent the value. If a number has an even precision, a leading zero nybble is added. This assignment includes leading (insignificant) and trailing (significant) zero digits.
- The sign nybble will be the second nybble of the last byte.

For example:

| Column   | Value   | Nybbles in Hexadecimal Grouped by Bytes |
|----------|---------|---|
| DEC(8,3) | 6574.23 | 00 65 74 23 0C                          |
| DEC(6,2) | -334.02 | 00 33 40 2D                             |
| DEC(7,5) | 5.2323  | 05 23 23 0C                             |
| DEC(5,2) | -23.5   | 02 35 0D                                |

### SQLLEN field for decimal

The SQLLEN field contains the precision (first byte) and scale (second byte) of the decimal column. If writing a portable application, the precision and scale bytes should be set individually, versus setting them together as a short integer. This will avoid integer byte reversal problems.

For example, in C:

## SQLLEN field for decimal

```
((char *)&(sqlda->sqlvar[i].sqllen))[0] = precision;  
((char *)&(sqlda->sqlvar[i].sqllen))[1] = scale;
```

### Related reference:

- “CHAR ” on page 291

---

## Appendix D. Catalog views

This appendix contains a description of each system catalog view, including column names and data types.

---

### System catalog views

The database manager creates and maintains two sets of system catalog views that are defined on top of the base system catalog tables.

- SYSCAT views are read-only catalog views that are found in the SYSCAT schema. SELECT privilege on these views is granted to PUBLIC by default.
- SYSSTAT views are updatable catalog views that are found in the SYSSTAT schema. The updatable views contain statistical information that is used by the optimizer. The values in some columns in these views can be changed to test performance. (Before changing any statistics, it is recommended that the RUNSTATS command be invoked so that all the statistics reflect the current state.)

Applications should be written to the SYSCAT and SYSSTAT views rather than the base catalog tables.

All the system catalog views are created at database creation time. The catalog views cannot be explicitly created or dropped. The views are updated during normal operation in response to SQL data definition statements, environment routines, and certain utilities. Data in the system catalog views is available through normal SQL query facilities. The system catalog views (with the exception of some updatable catalog views) cannot be modified using normal SQL data manipulation statements.

An object (table, column, function, or index) will appear in a user's updatable catalog view only if that user created the object, holds CONTROL privilege on the object, or holds explicit DBADM authority.

The order of columns in the views may change from release to release. To prevent this from affecting programming logic, specify the columns in a select list explicitly, and avoid using SELECT \*. Columns have consistent names based on the types of objects that they describe.

| <b>Described Object</b> | <b>Column Names</b>                  |
|-------------------------|--------------------------------------|
| <b>Table</b>            | TABSCHEMA, TABNAME                   |
| <b>Index</b>            | INDSCHEMA, INDNAME                   |
| <b>View</b>             | VIEWSHEMA, VIEWNAME                  |
| <b>Constraint</b>       | CONSTSCHEMA, CONSTNAME               |
| <b>Trigger</b>          | TRIGSCHEMA, TRIGNAME                 |
| <b>Package</b>          | PKGSCHEMA, PKGNAME                   |
| <b>Type</b>             | TYPESHEMA, TYPENAME, TYPEID          |
| <b>Function</b>         | ROUTINESHEMA, ROUTINENAME, ROUTINEID |

## System catalog views

|                                 |  |
|---------------------------------|--|
| <b>Method</b>                   | ROUTINESCHEMA, ROUTINENAME,<br>ROUTINEID |
| <b>Procedure</b>                | ROUTINESCHEMA, ROUTINENAME,<br>ROUTINEID |
| <b>Column</b>                   | COLNAME                                  |
| <b>Schema</b>                   | SCHEMANAME                               |
| <b>Table Space</b>              | TBSPACE                                  |
| <b>Database partition group</b> | NGNAME                                   |
| <b>Buffer pool</b>              | BPNAME                                   |
| <b>Event Monitor</b>            | EVMONNAME                                |
| <b>Creation Timestamp</b>       | CREATE_TIME                              |

## Road map to the catalog views

Table 42. Road map to the read-only catalog views

| Description   | Catalog View                                  |
|---|---|
| attributes of structured data types                   | "SYSCAT.ATTRIBUTES " on page 590              |
| authorities on database                               | "SYSCAT.DBAUTH " on page 617                  |
| buffer pool configuration on database partition group | "SYSCAT.BUFFERPOOLS " on page 593             |
| buffer pool size on database partition                | "SYSCAT.BUFFERPOOLDBPARTITIONS " on page 592  |
| cast functions  | "SYSCAT.CASTFUNCTIONS " on page 594           |
| check constraints                                     | "SYSCAT.CHECKS " on page 595                  |
| column privileges                                     | "SYSCAT.COLAUTH " on page 596                 |
| columns   | "SYSCAT.COLUMNS " on page 605                 |
| columns referenced by check constraints               | "SYSCAT.COLCHECKS " on page 597               |
| columns used in dimensions                            | "SYSCAT.COLUSE " on page 610                  |
| columns used in keys                                  | "SYSCAT.KEYCOLUSE " on page 644               |
| constraint dependencies                               | "SYSCAT.CONSTDEP " on page 611                |
| database partition group database partitions          | "SYSCAT.DBPARTITIONGROUPDEF " on page 618     |
| database partition group definitions                  | "SYSCAT.DBPARTITIONGROUPS " on page 619       |
| data partitions                                       | "SYSCAT.DATAPARTITIONEXPRESSION " on page 612 |
|   | "SYSCAT.DATAPARTITIONS " on page 613          |
| data types  | "SYSCAT.DATATYPES " on page 615               |
| detailed column group statistics                      | "SYSCAT.COLGROUPCOLS " on page 599            |
|   | "SYSCAT.COLGROUPDIST " on page 600            |
|   | "SYSCAT.COLGROUPDISTCOUNTS " on page 601      |
|   | "SYSCAT.COLGROUPS " on page 602               |
| detailed column options                               | "SYSCAT.COLOPTIONS " on page 604              |
| detailed column statistics                            | "SYSCAT.COLDIST " on page 598                 |
| distribution maps                                     | "SYSCAT.PARTITIONMAPS " on page 656           |
| event monitor definitions                             | "SYSCAT.EVENTMONITORS " on page 620           |
| events currently monitored                            | "SYSCAT.EVENTS " on page 622                  |
|   | "SYSCAT.EVENTTABLES " on page 623             |
| function dependencies <sup>1</sup>                    | "SYSCAT.ROUTINEDEP " on page 661              |
| function mapping                                      | "SYSCAT.FUNCMAPPINGS " on page 627            |
| function mapping options                              | "SYSCAT.FUNCMAPOPTIONS " on page 625          |
| function parameter mapping options                    | "SYSCAT.FUNCMAPPARMOPTIONS " on page 626      |
| function parameters <sup>1</sup>                      | "SYSCAT.ROUTINEPARMS " on page 664            |
| functions <sup>1</sup>                                | "SYSCAT.ROUTINES " on page 666                |
| hierarchies (types, tables, views)                    | "SYSCAT.HIERARCHIES " on page 628             |
|   | "SYSCAT.FULLHIERARCHIES " on page 624         |
| identity columns                                      | "SYSCAT.COLIDENTATTRIBUTES " on page 603      |
| index columns   | "SYSCAT.INDEXCOLUSE " on page 630             |
| index dependencies                                    | "SYSCAT.INDEXDEP " on page 631                |

## Road map to the catalog views

Table 42. Road map to the read-only catalog views (continued)

| Description   | Catalog View  |
|---|---|
| index exploitation  | "SYSCAT.INDEXEXPLOITRULES " on page 637             |
| index extension dependencies                                      | "SYSCAT.INDEXEXTENSIONDEP " on page 638             |
| index extension parameters  | "SYSCAT.INDEXEXTENSIONPARMS " on page 640           |
| index extension search methods                                    | "SYSCAT.INDEXEXTENSIONMETHODS " on page 639         |
| index extensions  | "SYSCAT.INDEXEXTENSIONS " on page 641               |
| index options   | "SYSCAT.INDEXOPTIONS " on page 642                  |
| index privileges  | "SYSCAT.INDEXAUTH " on page 629                     |
| indexes   | "SYSCAT.INDEXES " on page 632                       |
| method dependencies <sup>1</sup>                                  | "SYSCAT.ROUTINEDEP " on page 661                    |
| method parameters <sup>1</sup>                                    | "SYSCAT.ROUTINES " on page 666                      |
| methods <sup>1</sup>  | "SYSCAT.ROUTINES " on page 666                      |
| nicknames   | "SYSCAT.NICKNAMES " on page 646                     |
| object mapping  | "SYSCAT.NAMEMAPPINGS " on page 645                  |
| package dependencies  | "SYSCAT.PACKAGEDEP " on page 650                    |
| package privileges  | "SYSCAT.PACKAGEAUTH " on page 649                   |
| packages  | "SYSCAT.PACKAGES " on page 651                      |
| partitioned tables  | "SYSCAT.TABDETACHEDDEP " on page 697                |
| pass-through privileges   | "SYSCAT.PASSTHROUGH " on page 657                   |
| predicate specifications  | "SYSCAT.PREDICATESPECS " on page 658                |
| procedure options   | "SYSCAT.ROUTINEOPTIONS " on page 662                |
| procedure parameter options                                       | "SYSCAT.ROUTINEPARMOPTIONS " on page 663            |
| procedure parameters <sup>1</sup>                                 | "SYSCAT.ROUTINEPARMS " on page 664                  |
| procedures <sup>1</sup>   | "SYSCAT.ROUTINES " on page 666                      |
| protected tables  | "SYSCAT.SECURITYLABELACCESS " on page 678           |
|   | "SYSCAT.SECURITYLABELCOMPONENTELEMETS " on page 679 |
|   | "SYSCAT.SECURITYLABELCOMPONENTS " on page 680       |
|   | "SYSCAT.SECURITYLABELS " on page 681                |
|   | "SYSCAT.SECURITYPOLICIES " on page 682              |
|   | "SYSCAT.SECURITYPOLICYCOMPONENTRULES " on page 683  |
|   | "SYSCAT.SECURITYPOLICYEXEMPTIONS " on page 684      |
|   | "SYSCAT.SURROGATEAUTHIDS " on page 685              |
| provides DB2 Universal Database for z/OS and OS/390 compatibility | "SYSIBM.SYSDUMMY1 " on page 589                     |
| referential constraints   | "SYSCAT.REFERENCES " on page 659                    |
| remote table options  | "SYSCAT.TABOPTIONS " on page 706                    |
| routine dependencies  | "SYSCAT.ROUTINEDEP " on page 661                    |
| routine parameters <sup>1</sup>                                   | "SYSCAT.ROUTINEPARMS " on page 664                  |
| routine privileges  | "SYSCAT.ROUTINEAUTH " on page 660                   |



Table 42. Road map to the read-only catalog views (continued)

| Description                | Catalog View                               |
|----------------------------|--|
| routines <sup>1</sup>      | "SYSCAT.ROUTINES " on page 666             |
|                            | "SYSCAT.ROUTINESFEDERATED " on page 674    |
| schema privileges          | "SYSCAT.SCHEMAAUTH " on page 676           |
| schemas                    | "SYSCAT.SCHEMATA " on page 677             |
| sequence privileges        | "SYSCAT.SEQUENCEAUTH " on page 686         |
| sequences                  | "SYSCAT.SEQUENCES " on page 687            |
| server options             | "SYSCAT.SERVEROPTIONS " on page 689        |
| server options values      | "SYSCAT.USEROPTIONS " on page 715          |
| statements in packages     | "SYSCAT.STATEMENTS " on page 691           |
| stored procedures          | "SYSCAT.ROUTINES " on page 666             |
| system servers             | "SYSCAT.SERVERS " on page 690              |
| table constraints          | "SYSCAT.TABCONST " on page 694             |
| table dependencies         | "SYSCAT.TABDEP " on page 695               |
| table privileges           | "SYSCAT.TABAUTH " on page 692              |
| table space use privileges | "SYSCAT.TBSPACEAUTH " on page 707          |
| table spaces               | "SYSCAT.TABLESPACES " on page 704          |
| tables                     | "SYSCAT.TABLES " on page 698               |
| transforms                 | "SYSCAT.TRANSFORMS " on page 708           |
| trigger dependencies       | "SYSCAT.TRIGDEP " on page 709              |
| triggers                   | "SYSCAT.TRIGGERS " on page 710             |
| type mapping               | "SYSCAT.TYPEMAPPINGS " on page 712         |
| user-defined functions     | "SYSCAT.ROUTINES " on page 666             |
| view dependencies          | "SYSCAT.TABDEP " on page 695               |
| views                      | "SYSCAT.TABLES " on page 698               |
|                            | "SYSCAT.VIEWS " on page 716                |
| wrapper options            | "SYSCAT.WRAPOPTIONS " on page 717          |
| wrappers                   | "SYSCAT.WRAPPERS " on page 718             |
| XML values index           | "SYSCAT.INDEXXMLPATTERNS " on page 643     |
| XSR objects                | "SYSCAT.XDBMAPGRAPHS " on page 719         |
|                            | "SYSCAT.XDBMAPSHREDTREES " on page 720     |
|                            | "SYSCAT.XSROBJECTAUTH " on page 721        |
|                            | "SYSCAT.XSROBJECTCOMPONENTS " on page 722  |
|                            | "SYSCAT.XSROBJECTDEP " on page 723         |
|                            | "SYSCAT.XSROBJECTHIERARCHIES " on page 724 |
|                            | "SYSCAT.XSROBJECTS " on page 725           |

<sup>1</sup> The catalog views for functions, methods, and procedures from DB2 Version 7.1 and earlier still exist. These views, however, do not reflect any changes since DB2 Version 7.1. The views are:

Functions: SYSCAT.FUNCTIONS, SYSCAT.FUNCDEP, SYSCAT.FUNCPARMS  
 Methods: SYSCAT.FUNCTIONS, SYSCAT.FUNCDEP, SYSCAT.FUNCPARMS  
 Procedures: SYSCAT.PROCEDURES, SYSCAT.PROCPARMS

## Road map to the catalog views

Table 43. Road map to the updatable catalog views

| Description                      | Catalog View                              |
|----------------------------------|---|
| columns                          | "SYSSTAT.COLUMNS " on page 730            |
| detailed column group statistics | "SYSSTAT.COLGROUPDIST " on page 727       |
|                                  | "SYSSTAT.COLGROUPDISTCOUNTS " on page 728 |
|                                  | "SYSSTAT.COLGROUPS " on page 729          |
| detailed column statistics       | "SYSSTAT.COLDIST " on page 726            |
| indexes                          | "SYSSTAT.INDEXES " on page 731            |
| routines <sup>1</sup>            | "SYSSTAT.ROUTINES " on page 734           |
| tables                           | "SYSSTAT.TABLES " on page 735             |

<sup>1</sup> The SYSSTAT.FUNCTIONS catalog view still exists for updating the statistics for functions and methods. This view, however, does not reflect any changes since DB2 Version 7.1.

---

**SYSIBM.SYSDUMMY1**

Contains one row. This view is available for applications that require compatibility with DB2 Universal Database for z/OS.

*Table 44. SYSIBM.SYSDUMMY1 Catalog View*

| Column Name | Data Type | Nullable | Description |
|-------------|-----------|----------|-------------|
| IBMREQD     | CHAR(1)   |          | 'Y'         |

---

**SYSCAT.ATTRIBUTES**

Each row represents an attribute that is defined for a user-defined structured data type. Includes inherited attributes of subtypes.

Table 45. SYSCAT.ATTRIBUTES Catalog View

| Column Name      | Data Type    | Nullable | Description  |
|------------------|--------------|----------|--|
| TYPESHEMA        | VARCHAR(128) |          | Schema name of the structured data type that includes the attribute.   |
| TYPENAME         | VARCHAR(128) |          | Unqualified name of the structured data type that includes the attribute.  |
| ATTR_NAME        | VARCHAR(128) |          | Attribute name.  |
| ATTR_TYPESHEMA   | VARCHAR(128) |          | Schema name of the data type of an attribute.  |
| ATTR_TYPENAME    | VARCHAR(128) |          | Unqualified name of the data type of an attribute.   |
| TARGET_TYPESHEMA | VARCHAR(128) | Y        | Schema name of the target row type. Applies to reference types only; null value otherwise.   |
| TARGET_TYPENAME  | VARCHAR(128) | Y        | Unqualified name of the target row type. Applies to reference types only; null value otherwise.  |
| SOURCE_TYPESHEMA | VARCHAR(128) |          | For inherited attributes, the schema name of the data type with which the attribute was first defined. For non-inherited attributes, this column is the same as TYPESHEMA.     |
| SOURCE_TYPENAME  | VARCHAR(128) |          | For inherited attributes, the unqualified name of the data type with which the attribute was first defined. For non-inherited attributes, this column is the same as TYPENAME. |
| ORDINAL          | SMALLINT     |          | Position of the attribute in the definition of the structured data type, starting with 0.  |
| LENGTH           | INTEGER      |          | For string types, contains the maximum length. For decimal type, contains the precision (number of digits); 0 otherwise.   |
| SCALE            | SMALLINT     |          | For the decimal type, contains the scale (number of digits to the right of the decimal point); 0 otherwise.  |
| CODEPAGE         | SMALLINT     |          | For string types, denotes the code page; 0 indicates FOR BIT DATA; 0 for non-string types.   |
| LOGGED           | CHAR(1)      |          | Applies to LOB types only; blank otherwise.<br>N = Changes are not logged<br>Y = Changes are logged  |
| COMPACT          | CHAR(1)      |          | Applies to LOB types only; blank otherwise.<br>N = Stored in non-compact format<br>Y = Stored in compact format  |
| DL_FEATURES      | CHAR(10)     |          | Applies to DATALINK type only; blanks otherwise. Encodes various datalink features such as link type, control mode, recovery, and unlink properties.                           |

Table 45. SYSCAT.ATTRIBUTES Catalog View (continued)

| Column Name    | Data Type    | Nullable | Description              |
|----------------|--------------|----------|--------------------------|
| JAVA_FIELDNAME | VARCHAR(256) | Y        | Reserved for future use. |

---

**SYSCAT.BUFFERPOOLDBPARTITIONS**

Each row represents a combination of a buffer pool and a database partition, in which the size of the buffer pool on that partition is different from its default size for other partitions in the same database partition group (as represented in SYSCAT.BUFFERPOOLS).

*Table 46. SYSCAT.BUFFERPOOLDBPARTITIONS Catalog View*

| <b>Column Name</b> | <b>Data Type</b> | <b>Nullable</b> | <b>Description</b>  |
|--------------------|------------------|-----------------|---|
| BUFFERPOOLID       | INTEGER          |                 | Internal buffer pool identifier.                                |
| DBPARTITIONNUM     | SMALLINT         |                 | Database partition number.                                      |
| NPAGES             | INTEGER          |                 | Number of pages in this buffer pool on this database partition. |

---

**SYSCAT.BUFFERPOOLS**

Each row represents the configuration of a buffer pool on one database partition group of a database, or on all database partitions of a database.

Table 47. SYSCAT.BUFFERPOOLS Catalog View

| Column Name         | Data Type    | Nullable | Description   |
|---------------------|--------------|----------|---|
| BPNAME              | VARCHAR(128) |          | Name of the buffer pool.  |
| BUFFERPOOLID        | INTEGER      |          | Identifier for the buffer pool.   |
| DBPGNAME            | VARCHAR(128) | Y        | Name of the database partition group (null if the buffer pool exists on all database partitions in the database).   |
| NPAGES              | INTEGER      |          | Default number of pages in this buffer pool on database partitions in this database partition group.  |
| PAGESIZE            | INTEGER      |          | Page size for this buffer pool on database partitions in this database partition group.   |
| ESTORE              | CHAR(1)      |          | Always 'N'. Extended storage no longer applies.   |
| NUMBLOCKPAGES       | INTEGER      | Y        | Number of pages of the buffer pool that are to be in a block-based area. A block-based area of the buffer pool is only used by prefetchers doing a sequential prefetch. By default, a buffer pool will not have a block-based area; that is, NUMBLOCKPAGES is null. |
| BLOCKSIZE           | INTEGER      | Y        | Number of pages in a block.   |
| NGNAME <sup>1</sup> | VARCHAR(128) | Y        | Name of the database partition group (null if the buffer pool exists on all database partitions in the database).   |

**Notes:**

1. The NGNAME column is included for backwards compatibility. See DBPGNAME.

---

**SYSCAT.CASTFUNCTIONS**

Each row represents a cast function, not including built-in cast functions.

*Table 48. SYSCAT.CASTFUNCTIONS Catalog View*

| Column Name     | Data Type    | Nullable | Description  |
|-----------------|--------------|----------|--|
| FROM_TYPESHEMA  | VARCHAR(128) |          | Schema name of the data type of the parameter.                     |
| FROM_TYPENAME   | VARCHAR(128) |          | Name of the data type of the parameter.                            |
| TO_TYPESHEMA    | VARCHAR(128) |          | Schema name of the data type of the result after casting.          |
| TO_TYPENAME     | VARCHAR(128) |          | Name of the data type of the result after casting.                 |
| FUNCSHEMA       | VARCHAR(128) |          | Schema name of the function.                                       |
| FUNCNAME        | VARCHAR(128) |          | Unqualified name of the function.                                  |
| SPECIFICNAME    | VARCHAR(128) |          | Name of the routine instance (might be system-generated).          |
| ASSIGN_FUNCTION | CHAR(1)      |          | N = Not an assignment function<br>Y = Implicit assignment function |



## SYSCAT.CHECKS

Each row represents a check constraint or a derived column in a materialized query table. For table hierarchies, each check constraint is recorded only at the level of the hierarchy where the constraint was created.

Table 49. SYSCAT.CHECKS Catalog View

| Column Name          | Data Type    | Nullable | Description   |
|----------------------|--------------|----------|---|
| CONSTNAME            | VARCHAR(18)  |          | Name of the check constraint.   |
| OWNER                | VARCHAR(128) |          | Authorization ID under which the check constraint was created.  |
| TABSCHEMA            | VARCHAR(128) |          | Schema name of the table to which this constraint applies.  |
| TABNAME              | VARCHAR(128) |          | Name of the table to which this constraint applies.   |
| CREATE_TIME          | TIMESTAMP    |          | Time at which the constraint was defined. Used in resolving functions that are part of this constraint. Functions that were created after the constraint was defined are not chosen.          |
| QUALIFIER            | VARCHAR(128) |          | Value of the default schema at the time of object definition. Used to complete any unqualified references.  |
| TYPE                 | CHAR(1)      |          | Type of check constraint:<br>C = Check constraint<br>F = Functional dependency<br>O = Constraint is an object property<br>S = System-generated check constraint for a GENERATED ALWAYS column |
| FUNC_PATH            | VARCHAR(254) |          | SQL path in effect when the constraint was defined; used to resolve functions and types that are part of the constraint.  |
| TEXT                 | CLOB(2M)     |          | Text of the check condition or definition of the derived column. <sup>1</sup>   |
| PERCENTVALID         | SMALLINT     |          | Number of rows for which the informational constraint is valid, expressed as a percentage of the total.   |
| DEFINER <sup>2</sup> | VARCHAR(128) |          | Authorization ID under which the check constraint was created.  |

### Notes:

1. In the catalog view, the text of the check condition is always shown in the database code page and can contain substitution characters. The check constraint will always be applied in the code page of the target table, and will not contain any substitution characters when applied. (The check constraint will be applied based on the original text in the code page of the target table, which might not include the substitution characters.)
2. The DEFINER column is included for backwards compatibility. See OWNER.

---

**SYSCAT.COLAUTH**

Each row represents a user or a group that has been granted one or more privileges on a column.

Table 50. SYSCAT.COLAUTH Catalog View

| Column Name | Data Type    | Nullable | Description   |
|-------------|--------------|----------|---|
| GRANTOR     | VARCHAR(128) |          | Grantor of a privilege.   |
| GRANTEE     | VARCHAR(128) |          | Holder of a privilege.  |
| GRANTEETYPE | CHAR(1)      |          | G = Grantee is a group<br>U = Grantee is an individual user           |
| TABSCHEMA   | VARCHAR(128) |          | Schema name of the table or view on which the privilege is held.      |
| TABNAME     | VARCHAR(128) |          | Unqualified name of the table or view on which the privilege is held. |
| COLNAME     | VARCHAR(128) |          | Name of the column to which this privilege applies.                   |
| COLNO       | SMALLINT     |          | Column number of this column within the table (starting with 0).      |
| PRIVTYPE    | CHAR(1)      |          | R = Reference privilege<br>U = Update privilege                       |
| GRANTABLE   | CHAR(1)      |          | G = Privilege is grantable<br>N = Privilege is not grantable          |

**Notes:**

1. Privileges can be granted by column, but can be revoked only on a table-wide basis.

## SYSCAT.COLCHECKS

Each row represents a column that is referenced by a check constraint or by the definition of a materialized query table. For table hierarchies, each check constraint is recorded only at the level of the hierarchy where the constraint was created.

Table 51. SYSCAT.COLCHECKS Catalog View

| Column Name | Data Type    | Nullable | Description   |
|-------------|--------------|----------|---|
| CONSTNAME   | VARCHAR(128) |          | Name of the check constraint.   |
| TABSCHEMA   | VARCHAR(128) |          | Schema name of the table containing the referenced column.  |
| TABNAME     | VARCHAR(128) |          | Unqualified name of the table containing the referenced column.   |
| COLNAME     | VARCHAR(128) |          | Name of the column.   |
| USAGE       | CHAR(1)      |          | D = Column is the child in a functional dependency<br>P = Column is the parent in a functional dependency<br>R = Column is referenced in the check constraint<br>S = Column is a source in the system-generated column check constraint that supports a materialized query table<br>T = Column is a target in the system-generated column check constraint that supports a materialized query table |

---

**SYSCAT.COLDIST**

Each row represents the *n*th most frequent value of some column, or the *n*th quantile (cumulative distribution) value of the column. Applies to columns of real tables only (not views). No statistics are recorded for inherited columns of typed tables.

Table 52. SYSCAT.COLDIST Catalog View

| Column Name            | Data Type    | Nullable | Description  |
|------------------------|--------------|----------|--|
| TABSCHEMA              | VARCHAR(128) |          | Schema name of the table to which the statistics apply.  |
| TABNAME                | VARCHAR(128) |          | Unqualified name of the table to which the statistics apply.   |
| COLNAME                | VARCHAR(128) |          | Name of the column to which the statistics apply.  |
| TYPE                   | CHAR(1)      |          | F = Frequency value<br>Q = Quantile value  |
| SEQNO                  | SMALLINT     |          | If TYPE = 'F', <i>n</i> in this column identifies the <i>n</i> th most frequent value. If TYPE = 'Q', <i>n</i> in this column identifies the <i>n</i> th quantile value.     |
| COLVALUE <sup>1</sup>  | VARCHAR(254) | Y        | Data value as a character literal or a null value.   |
| VALCOUNT               | BIGINT       |          | If TYPE = 'F', VALCOUNT is the number of occurrences of COLVALUE in the column. If TYPE = 'Q', VALCOUNT is the number of rows whose value is less than or equal to COLVALUE. |
| DISTCOUNT <sup>2</sup> | BIGINT       | Y        | If TYPE = 'Q', this column records the number of distinct values that are less than or equal to COLVALUE (null if unavailable).  |

**Notes:**

1. In the catalog view, the value of COLVALUE is always shown in the database code page and can contain substitution characters. However, the statistics are gathered internally in the code page of the column's table, and will therefore use actual column values when applied during query optimization.
2. DISTCOUNT is collected only for columns that are the first key column in an index.

---

**SYSCAT.COLGROUPOCOLS**

Each row represents a column that makes up a column group.

*Table 53. SYSCAT.COLGROUPOCOLS Catalog View*

| <b>Column Name</b> | <b>Data Type</b> | <b>Nullable</b> | <b>Description</b>  |
|--------------------|------------------|-----------------|---|
| COLGROUPOID        | INTEGER          |                 | Identifier for the column group.                                  |
| COLNAME            | VARCHAR(128)     |                 | Name of the column in the column group.                           |
| TABSCHEMA          | VARCHAR(128)     |                 | Schema name of the table for the column in the column group.      |
| TABNAME            | VARCHAR(128)     |                 | Unqualified name of the table for the column in the column group. |
| ORDINAL            | SMALLINT         |                 | Ordinal number of the column in the column group.                 |

---

**SYSCAT.COLGROUPDIST**

Each row represents the value of the column in a column group that makes up the *n*th most frequent value of the column group or the *n*th quantile value of the column group.

Table 54. SYSCAT.COLGROUPDIST Catalog View

| Column Name           | Data Type    | Nullable | Description  |
|-----------------------|--------------|----------|--|
| COLGROUPID            | INTEGER      |          | Identifier for the column group.   |
| TYPE                  | CHAR(1)      |          | F = Frequency value<br>Q = Quantile value  |
| ORDINAL               | SMALLINT     |          | Ordinal number of the column in the column group.  |
| SEQNO                 | SMALLINT     |          | If TYPE = 'F', <i>n</i> in this column identifies the <i>n</i> th most frequent value. If TYPE = 'Q', <i>n</i> in this column identifies the <i>n</i> th quantile value. |
| COLVALUE <sup>1</sup> | VARCHAR(254) | Y        | Data value as a character literal or a null value.   |

**Notes:**

1. In the catalog view, the value of COLVALUE is always shown in the database code page and can contain substitution characters. However, the statistics are gathered internally in the code page of the column's table, and will therefore use actual column values when applied during query optimization.

---

**SYSCAT.COLGROUPDISTCOUNTS**

Each row represents the distribution statistics that apply to the *n*th most frequent value of a column group or the *n*th quantile of a column group.

Table 55. SYSCAT.COLGROUPDISTCOUNTS Catalog View

| Column Name | Data Type | Nullable | Description  |
|-------------|-----------|----------|--|
| COLGROUPID  | INTEGER   |          | Identifier for the column group.   |
| TYPE        | CHAR(1)   |          | F = Frequency value<br>Q = Quantile value  |
| SEQNO       | SMALLINT  |          | Sequence number <i>n</i> representing the <i>n</i> th TYPE value.  |
| VALCOUNT    | BIGINT    |          | If TYPE = 'F', VALCOUNT is the number of occurrences of COLVALUE for the column group with this SEQNO. If TYPE = 'Q', VALCOUNT is the number of rows whose value is less than or equal to COLVALUE for the column group with this SEQNO. |
| DISTCOUNT   | BIGINT    | Y        | If TYPE = 'Q', this column records the number of distinct values that are less than or equal to COLVALUE for the column group with this SEQNO (null if unavailable).   |

## SYSCAT.COLGROUPS

---

## SYSCAT.COLGROUPS

Each row represents a column group and statistics that apply to the entire column group.

*Table 56. SYSCAT.COLGROUPS Catalog View*

| <b>Column Name</b> | <b>Data Type</b> | <b>Nullable</b> | <b>Description</b>  |
|--------------------|------------------|-----------------|---|
| COLGROUPSCHEMA     | VARCHAR(128)     |                 | Schema name of the column group.                          |
| COLGROUPNAME       | VARCHAR(128)     |                 | Unqualified name of the column group.                     |
| COLGROUPLD         | INTEGER          |                 | Identifier for the column group.                          |
| COLGROUPLCARD      | BIGINT           |                 | Cardinality of the column group.                          |
| NUMFREQ_VALUES     | SMALLINT         |                 | Number of frequent values collected for the column group. |
| NUMQUANTILES       | SMALLINT         |                 | Number of quantiles collected for the column group.       |



---

**SYSCAT.COLIDENTATTRIBUTES**

Each row represents an identity column that is defined for a table.

Table 57. SYSCAT.COLIDENTATTRIBUTES Catalog View

| Column Name         | Data Type     | Nullable | Description   |
|---------------------|---------------|----------|---|
| TABSCHEMA           | VARCHAR(128)  |          | Schema name of the table or view that contains the column.  |
| TABNAME             | VARCHAR(128)  |          | Unqualified name of the table or view that contains the column.   |
| COLNAME             | VARCHAR(128)  |          | Name of the column.   |
| START               | DECIMAL(31,0) |          | Start value of the sequence.  |
| INCREMENT           | DECIMAL(31,0) |          | Increment value.  |
| MINVALUE            | DECIMAL(31,0) |          | Minimum value of the sequence.  |
| MAXVALUE            | DECIMAL(31,0) |          | Maximum value of the sequence.  |
| CYCLE               | CHAR(1)       |          | Indicates whether or not the sequence can continue to generate values after reaching its maximum or minimum value.<br>N = Sequence cannot cycle<br>Y = Sequence can cycle   |
| CACHE               | INTEGER       |          | Number of sequence values to pre-allocate in memory for faster access. 0 indicates that values of the sequence are not to be preallocated. In a partitioned database, this value applies to each database partition.            |
| ORDER               | CHAR(1)       |          | Indicates whether or not the sequence numbers must be generated in order of request.<br>N = Sequence numbers are not required to be generated in order of request<br>Y = Sequence numbers must be generated in order of request |
| NEXTCACHEFIRSTVALUE | DECIMAL(31,0) | Y        | The first value available to be assigned in the next cache block. If no caching, the next value available to be assigned.   |
| SEQID               | INTEGER       |          | Identifier for the sequence.  |

## SYSCAT.COLOPTIONS

---

## SYSCAT.COLOPTIONS

Each row contains column specific option values.

*Table 58. SYSCAT.COLOPTIONS Catalog View*

| <b>Column Name</b> | <b>Data Type</b> | <b>Nullable</b> | <b>Description</b>                                 |
|--------------------|------------------|-----------------|--|
| TABSCHEMA          | VARCHAR(128)     |                 | Qualifier of a nickname.                           |
| TABNAME            | VARCHAR(128)     |                 | Nickname for the column for which options are set. |
| COLNAME            | VARCHAR(128)     |                 | Local column name.                                 |
| OPTION             | VARCHAR(128)     |                 | Name of the column option.                         |
| SETTING            | CLOB(32K)        |                 | Value.   |

---

**SYSCAT.COLUMNS**

Each row represents a column defined for a table, view, or nickname.

Table 59. SYSCAT.COLUMNS Catalog View

| Column Name          | Data Type    | Nullable | Description   |
|----------------------|--------------|----------|---|
| TABSCHEMA            | VARCHAR(128) |          | Schema name of the table, view, or nickname that contains the column.   |
| TABNAME              | VARCHAR(128) |          | Unqualified name of the table, view, or nickname that contains the column.  |
| COLNAME              | VARCHAR(128) |          | Name of the column.   |
| COLNO                | SMALLINT     |          | Number of this column in the table (starting with 0).   |
| TYPESHEMA            | VARCHAR(128) |          | Schema name of the data type for the column.  |
| TYPENAME             | VARCHAR(128) |          | Unqualified name of the data type for the column.   |
| LENGTH               | INTEGER      |          | Maximum length of the data. 0 for distinct types. The LENGTH column indicates precision for DECIMAL fields.   |
| SCALE                | SMALLINT     |          | Scale if the column type is DECIMAL; 0 otherwise.   |
| DEFAULT <sup>1</sup> | VARCHAR(254) | Y        | Default value for the column of a table expressed as a constant, special register, or cast-function appropriate for the data type of the column. Can also be the keyword NULL. Values might be converted from what was specified as a default value. For example, date and time constants are shown in ISO format, cast-function names are qualified with schema names, and identifiers are delimited. Null value if a DEFAULT clause was not specified or the column is a view column. |
| NULLS <sup>2</sup>   | CHAR(1)      |          | Nullability attribute for the column.<br>N = Column is not nullable<br>Y = Column is nullable<br><br>The value can be 'N' for a view column that is derived from an expression or function. Nevertheless, such a column allows null values when the statement using the view is processed with warnings for arithmetic errors.  |
| CODEPAGE             | SMALLINT     |          | Code page used for data in this column; 0 if the column is defined as FOR BIT DATA or is not a string type.   |
| LOGGED               | CHAR(1)      |          | Applies only to columns whose type is LOB or distinct based on LOB; blank otherwise.<br>N = Column is not logged<br>Y = Column is logged  |

## SYSCAT.COLUMNS

Table 59. SYSCAT.COLUMNS Catalog View (continued)

| Column Name           | Data Type    | Nullable | Description  |
|-----------------------|--------------|----------|--|
| COMPACT               | CHAR(1)      |          | Applies only to columns whose type is LOB or distinct based on LOB; blank otherwise.<br>N = Column is not compacted<br>Y = Column is compacted in storage                                    |
| COLCARD               | BIGINT       |          | Number of distinct values in the column; -1 if statistics are not collected; -2 for inherited columns and columns of hierarchy tables.   |
| HIGH2KEY <sup>3</sup> | VARCHAR(254) | Y        | Second-highest data value. Representation of numeric data changed to character literals. Empty if statistics are not collected. Empty for inherited columns and columns of hierarchy tables. |
| LOW2KEY <sup>3</sup>  | VARCHAR(254) | Y        | Second-lowest data value. Representation of numeric data changed to character literals. Empty if statistics are not collected. Empty for inherited columns and columns of hierarchy tables.  |
| AVGCOLLEN             | INTEGER      |          | Average space (in bytes) required for the column; -1 if a long field or LOB, or statistics have not been collected; -2 for inherited columns and columns of hierarchy tables.                |
| KEYSEQ                | SMALLINT     | Y        | The column's numerical position within the table's primary key. Null for columns of subtables and hierarchy tables.  |
| PARTKEYSEQ            | SMALLINT     | Y        | The column's numerical position within the table's distribution key; 0 or the null value if the column is not in the distribution key. Null for columns of subtables and hierarchy tables.   |
| NQUANTILES            | SMALLINT     |          | Number of quantile values recorded in SYSCAT.COLDIST for this column; -1 if statistics are not gathered; -2 for inherited columns and columns of hierarchy tables.                           |
| NMOSTFREQ             | SMALLINT     |          | Number of most-frequent values recorded in SYSCAT.COLDIST for this column; -1 if statistics are not gathered; -2 for inherited columns and columns of hierarchy tables.                      |
| NUMNULLS              | BIGINT       |          | Number of null values in the column; -1 if statistics are not collected.   |
| TARGET_TYPESHEMA      | VARCHAR(128) | Y        | Schema name of the target row type, if the type of this column is REFERENCE; null value otherwise.   |
| TARGET_TYPENAME       | VARCHAR(128) | Y        | Unqualified name of the target row type, if the type of this column is REFERENCE; null value otherwise.  |
| SCOPE_TABSCHEMA       | VARCHAR(128) | Y        | Schema name of the scope (target table), if the type of this column is REFERENCE; null value otherwise.  |
| SCOPE_TABNAME         | VARCHAR(128) | Y        | Unqualified name of the scope (target table), if the type of this column is REFERENCE; null value otherwise.   |

Table 59. SYSCAT.COLUMNS Catalog View (continued)

| Column Name      | Data Type    | Nullable | Description   |
|------------------|--------------|----------|---|
| SOURCE_TABSCHEMA | VARCHAR(128) | Y        | For columns of typed tables or views, the schema name of the table or view in which the column was first introduced. For non-inherited columns, this is the same as TABSCHEMA. Null for columns of non-typed tables and views.  |
| SOURCE_TABNAME   | VARCHAR(128) | Y        | For columns of typed tables or views, the unqualified name of the table or view in which the column was first introduced. For non-inherited columns, this is the same as TABNAME. Null for columns of non-typed tables and views.   |
| DL_FEATURES      | CHAR(10)     | Y        | Applies to DATALINK type columns only; blanks otherwise. Each byte position is defined as follows:<br>1 = Link type ('U' for URL)<br>2 = Link control ('F' for file; 'N' for none)<br>3 = Integrity ('A' for all; 'N' for none)<br>4 = Read permission ('F' for file system; 'D' for database)<br>5 = Write permission ('F' for file system; 'B' for blocked; 'A' for admin requiring token for update; 'N' for admin not requiring token for update)<br>6 = Recovery ('Y' for yes; 'N' for no)<br>7 = On unlink ('R' for restore; 'D' for delete; 'N' for not applicable)<br>Bytes 8 through 10 are reserved for future use. |
| SPECIAL_PROPS    | CHAR(8)      | Y        | Applies to REFERENCE type columns only; blanks otherwise. Each byte position is defined as follows:<br>1 = Object identifier (OID) column ('Y' for yes; 'N' for no)<br>2 = User-generated or system-generated ('U' for user; 'S' for system)<br>Bytes 3 through 8 are reserved for future use.  |
| HIDDEN           | CHAR(1)      |          | Type of hidden column.<br>S = System-managed hidden column<br>Blank = Column is not hidden  |
| INLINE_LENGTH    | INTEGER      |          | Maximum length of LONG VARCHAR or LOB data that can be stored as VARCHAR data in the base table. Initial value is 0.  |
| IDENTITY         | CHAR(1)      |          | N = Not an identity column<br>Y = Identity column   |

## SYSCAT.COLUMNS

Table 59. SYSCAT.COLUMNS Catalog View (continued)

| Column Name                | Data Type    | Nullable | Description   |
|----------------------------|--------------|----------|---|
| GENERATED                  | CHAR(1)      |          | Type of generated column.<br>A = Column value is always generated<br>D = Column value is generated by default<br>Blank = Column is not generated  |
| TEXT                       | CLOB(2M)     |          | For columns defined as generated as expression, this field contains the text of the generated column expression, starting with the keyword AS.  |
| COMPRESS                   | CHAR(1)      |          | O = Compress off<br>S = Compress system default values  |
| AVGDISTINCTPERPAGE         | DOUBLE       | Y        | For future use.   |
| PAGEVARIANCERATIO          | DOUBLE       | Y        | For future use.   |
| SUB_COUNT                  | SMALLINT     |          | Average number of sub-elements in the column. Applicable to character string columns only.  |
| SUB_DELIM_LENGTH           | SMALLINT     |          | Average length of the delimiters that separate each sub-element in the column. Applicable to character string columns only.   |
| IMPLICITVALUE <sup>4</sup> | VARCHAR(254) | Y        | For a column that was added to a table after the table was created, stores the default value at the time the column was added. For a column that was defined when the table was created, stores the null value. |
| SECLABELNAME               | VARCHAR(128) |          | Name of the security label that is associated with the column if it is a protected column; null value otherwise.  |
| REMARKS                    | VARCHAR(254) | Y        | User-provided comments, or null.  |

Table 59. SYSCAT.COLUMNS Catalog View (continued)

| Column Name | Data Type | Nullable | Description |
|-------------|-----------|----------|-------------|
|-------------|-----------|----------|-------------|

**Notes:**

1. For Version 2.1.0, cast-function names were not delimited and may still appear this way in the DEFAULT column. Also, some view columns included default values which will still appear in the DEFAULT column.
2. Starting with Version 2, value D (indicating not null with a default) is no longer used. Instead, use of WITH DEFAULT is indicated by a non-null value in the DEFAULT column.
3. In the catalog view, the values of HIGH2KEY and LOW2KEY are always shown in the database code page and can contain substitution characters. However, the statistics are gathered internally in the code page of the column's table, and will therefore use actual column values when applied during query optimization.
4. Attaching a data partition is allowed unless IMPLICITVALUE for a specific column is a non-null value for both the source column and the target column, and the values do not match. In this case, you must drop the source table and then recreate it. A column can have a non-null value in the IMPLICITVALUE field if one of the following conditions is met:
  - The column is created as the result of an ALTER TABLE...ADD COLUMN statement
  - The IMPLICITVALUE field is propagated from a source table during attach
  - The IMPLICITVALUE field is inherited from a source table during detach
  - The IMPLICITVALUE field is set during migration from Version 8 to Version 9, where it is determined to be an added column, or might be an added column. If the database is not certain whether the column is added or not, it is treated as added. An added column is a column that was created as the result of an ALTER TABLE...ADD COLUMN statement.

To avoid these inconsistencies during non-migration scenarios, it is recommended that you always create the tables that you are going to attach with all the columns already defined. That is, never use the ALTER TABLE statement to add columns to a table before attaching it.

**Related tasks:**

- "Attaching a data partition" in *Administration Guide: Implementation*

## SYSCAT.COLUSE

---

## SYSCAT.COLUSE

Each row represents a column that is referenced in the DIMENSIONS clause of a CREATE TABLE statement.

Table 60. SYSCAT.COLUSE Catalog View

| Column Name | Data Type    | Nullable | Description  |
|-------------|--------------|----------|--|
| TABSCHEMA   | VARCHAR(128) |          | Schema name of the table containing the column.  |
| TABNAME     | VARCHAR(128) |          | Unqualified name of the table containing the column.   |
| COLNAME     | VARCHAR(128) |          | Name of the column.  |
| DIMENSION   | SMALLINT     |          | Dimension number, based on the order of dimensions specified in the DIMENSIONS clause (initial position is 0). For a composite dimension, this value will be the same for each component of the dimension. |
| COLSEQ      | SMALLINT     |          | Numeric position of the column in the dimension to which it belongs (initial position is 0). The value is 0 for the single column in a noncomposite dimension.   |
| TYPE        | CHAR(1)      |          | Type of dimension.<br>C = Clustering or multidimensional clustering<br>P = Partitioning  |



---

## SYSCAT.CONSTDEP

Each row represents a dependency of a constraint on some other object. The constraint depends on the object of type BTYPE of name BNAME, so a change to the object affects the constraint.

Table 61. SYSCAT.CONSTDEP Catalog View

| Column Name | Data Type    | Nullable | Description  |
|-------------|--------------|----------|--|
| CONSTNAME   | VARCHAR(128) |          | Unqualified name of the constraint.  |
| TABSCHEMA   | VARCHAR(128) |          | Schema name of the table to which the constraint applies.  |
| TABNAME     | VARCHAR(128) |          | Unqualified name of the table to which the constraint applies.   |
| BTYPE       | CHAR(1)      |          | Type of object on which the constraint depends. Possible values are:<br>F = Routine instance<br>I = Index<br>R = Structured type |
| BSHEMA      | VARCHAR(128) |          | Schema name of the object on which the constraint depends.   |
| BNAME       | VARCHAR(128) |          | Unqualified name of the object on which the constraint depends.  |

---

**SYSCAT.DATAPARTITIONEXPRESSION**

Each row represents an expression for that part of the table partitioning key.

*Table 62. SYSCAT.DATAPARTITIONEXPRESSION Catalog View*

| Column Name             | Data Type    | Nullable | Description   |
|-------------------------|--------------|----------|---|
| TABSCHEMA               | VARCHAR(128) |          | Schema name of the partitioned table.   |
| TABNAME                 | VARCHAR(128) |          | Unqualified name of the partitioned table.  |
| DATAPARTITIONKEYSEQ     | INTEGER      |          | Expression key part sequence ID, starting from 1.   |
| DATAPARTITIONEXPRESSION | CLOB(32K)    |          | Expression for this entry in the sequence, in SQL syntax.   |
| NULLSFIRST              | CHAR(1)      |          | N = Null values in this expression compare high<br>Y = Null values in this expression compare low |

---

**SYSCAT.DATAPARTITIONS**

Each row represents a data partition.

Table 63. SYSCAT.DATAPARTITIONS Catalog View

| Column Name       | Data Type    | Nullable | Description  |
|-------------------|--------------|----------|--|
| DATAPARTITIONNAME | VARCHAR(128) |          | Name of the data partition.  |
| TABSCHEMA         | VARCHAR(128) |          | Schema name of the table to which this data partition belongs.   |
| TABNAME           | VARCHAR(128) |          | Unqualified name of the table to which this data partition belongs.  |
| DATAPARTITIONID   | INTEGER      |          | Identifier for the data partition.   |
| TBSPACEID         | INTEGER      | Y        | Identifier for the table space in which this data partition is stored. Null when STATUS is 'I'.  |
| PARTITIONOBJECTID | INTEGER      | Y        | Identifier for the data partition within the table space.  |
| LONG_TBSPACEID    | INTEGER      | Y        | Identifier for the table space in which long data is stored. Null when STATUS is 'I'.  |
| ACCESS_MODE       | CHAR(1)      |          | Access restriction state of the data partition. These states only apply to objects that are in set integrity pending state or to objects that were processed by a SET INTEGRITY statement. Possible values are:<br>D = No data movement<br>F = Full access<br>N = No access<br>R = Read-only access  |
| STATUS            | VARCHAR(32)  |          | A = Data partition is newly attached<br>D = Data partition is detached<br>I = Detached data partition whose entry in the catalog is maintained only during asynchronous index cleanup; rows with a STATUS value of 'I' are removed when all index records referring to the detached partition have been deleted<br>Empty string = Data partition is visible (normal status)<br><br>Bytes 2 through 32 are reserved for future use. |
| SEQNO             | INTEGER      |          | Data partition sequence number (starting from 0).  |
| LOWINCLUSIVE      | CHAR(1)      |          | N = Low key value is not inclusive<br>Y = Low key value is inclusive   |
| LOWVALUE          | VARCHAR(512) |          | Low key value (a string representation of an SQL value) for this data partition.   |
| HIGHINCLUSIVE     | CHAR(1)      |          | N = High key value is not inclusive<br>Y = High key value is inclusive   |

## SYSCAT.DATAPARTITIONS

Table 63. SYSCAT.DATAPARTITIONS Catalog View (continued)

| Column Name | Data Type    | Nullable | Description   |
|-------------|--------------|----------|---|
| HIGHVALUE   | VARCHAR(512) |          | High key value (a string representation of an SQL value) for this data partition. |

---

**SYSCAT.DATATYPES**

Each row represents a built-in or user-defined data type.

Table 64. SYSCAT.DATATYPES Catalog View

| Column Name      | Data Type    | Nullable | Description   |
|------------------|--------------|----------|---|
| TYPESHEMA        | VARCHAR(128) |          | Schema name of the data type. The schema name for built-in types is 'SYSIBM'.   |
| TYPENAME         | VARCHAR(128) |          | Unqualified name of the data type.  |
| OWNER            | VARCHAR(128) |          | Authorization ID under which the type was created.  |
| SOURCESHEMA      | VARCHAR(128) | Y        | Schema name of the source type for distinct types. For user-defined structured types, this is the type schema of the reference representation type. Null for other types.   |
| SOURCENAME       | VARCHAR(128) | Y        | Unqualified name of the source type for distinct types. For user-defined structured types, this is the type name of the reference representation type. Null for other types.  |
| METATYPE         | CHAR(1)      |          | R = User-defined structured type<br>S = System predefined type<br>T = User-defined distinct type  |
| TYPEID           | SMALLINT     |          | Identifier for the data type.   |
| SOURCETYPEID     | SMALLINT     | Y        | Identifier for the source type (null for built-in types). For user-defined structured types, this is the identifier of the reference representation type.   |
| LENGTH           | INTEGER      |          | Maximum length of the type. 0 for built-in parameterized types (for example, DECIMAL and VARCHAR). For user-defined structured types, this is the length of the reference representation type.  |
| SCALE            | SMALLINT     |          | Scale for distinct types or reference representation types based on the built-in DECIMAL type; 0 for all other types (including DECIMAL itself). For user-defined structured types, this indicates the length of the reference representation type. |
| CODEPAGE         | SMALLINT     |          | Database code page for string types, distinct types based on string types, or reference representation types; 0 otherwise.  |
| CREATE_TIME      | TIMESTAMP    |          | Creation time of the data type.   |
| ATTRCOUNT        | SMALLINT     |          | Number of attributes in the data type.  |
| INSTANTIABLE     | CHAR(1)      |          | N = Type cannot be instantiated<br>Y = Type can be instantiated   |
| WITH_FUNC_ACCESS | CHAR(1)      |          | N = Methods for this type cannot be invoked using function notation<br>Y = All the methods for this type can be invoked using function notation   |

## SYSCAT.DATATYPES

Table 64. SYSCAT.DATATYPES Catalog View (continued)

| Column Name           | Data Type    | Nullable | Description   |
|-----------------------|--------------|----------|---|
| FINAL                 | CHAR(1)      |          | N = The user-defined type can have subtypes<br>Y = The user-defined type cannot have subtypes   |
| INLINE_LENGTH         | INTEGER      |          | Maximum length of a structured type that can be kept with a base table row; 0 otherwise.  |
| NATURAL_INLINE_LENGTH | INTEGER      | Y        | System-generated natural inline length of a structured type instance. Null if this type is not a structured type.   |
| JARSCHEMA             | VARCHAR(128) | Y        | Schema name of the JAR_ID that identifies the Jar file containing the Java class that implements the SQL type. Null if the EXTERNAL NAME clause is not specified.                                       |
| JAR_ID                | VARCHAR(128) | Y        | Identifier for the Jar file that contains the Java class that implements the SQL type. Null if the EXTERNAL NAME clause is not specified.   |
| CLASS                 | VARCHAR(128) | Y        | Java class that implements the SQL type. Null if the EXTERNAL NAME clause is not specified.   |
| SQLJ_REPRESENTATION   | CHAR(1)      | Y        | SQLJ "representation_spec" of the Java class that implements the SQL type. Null if the EXTERNAL NAME ... LANGUAGE JAVA REPRESENTATION SPEC clause is not specified.<br>D = SQL data<br>S = Serializable |
| ALTER_TIME            | TIMESTAMP    |          | Time at which the data type was last altered.   |
| DEFINER <sup>1</sup>  | VARCHAR(128) |          | Authorization ID under which the type was created.  |
| REMARKS               | VARCHAR(254) | Y        | User-provided comments, or null.  |

### Notes:

1. The DEFINER column is included for backwards compatibility. See OWNER.

## SYSCAT.DBAUTH

Each row represents a user or a group that has been granted one or more database-level authorities.

Table 65. SYSCAT.DBAUTH Catalog View

| Column Name         | Data Type    | Nullable | Description   |
|---------------------|--------------|----------|---|
| GRANTOR             | VARCHAR(128) |          | Grantor of the authority.   |
| GRANTEE             | VARCHAR(128) |          | Holder of the authority.  |
| GRANTEETYPE         | CHAR(1)      |          | G = Grantee is a group<br>U = Grantee is an individual user   |
| BINDADDAUTH         | CHAR(1)      |          | Authority to create packages.<br>N = Not held<br>Y = Held   |
| CONNECTAUTH         | CHAR(1)      |          | Authority to connect to the database.<br>N = Not held<br>Y = Held   |
| CREATETABAUTH       | CHAR(1)      |          | Authority to create tables.<br>N = Not held<br>Y = Held   |
| DBADMAUTH           | CHAR(1)      |          | DBADM authority.<br>N = Not held<br>Y = Held  |
| EXTERNALROUTINEAUTH | CHAR(1)      |          | Authority to create external routines.<br>N = Not held<br>Y = Held  |
| IMPLSCHEMAAUTH      | CHAR(1)      |          | Authority to implicitly create schemas by creating objects in non-existent schemas.<br>N = Not held<br>Y = Held |
| LOADAUTH            | CHAR(1)      |          | Authority to use the DB2 load utility.<br>N = Not held<br>Y = Held  |
| NOFENCEAUTH         | CHAR(1)      |          | Authority to create non-fenced user-defined functions.<br>N = Not held<br>Y = Held                              |
| QUIESCECONNECTAUTH  | CHAR(1)      |          | Authority to access the database when it is quiesced.<br>N = Not held<br>Y = Held                               |
| LIBRARYADMAUTH      | CHAR(1)      |          | Reserved for future use.  |
| SECURITYADMAUTH     | CHAR(1)      |          | Security Administrator authority.<br>N = Not held<br>Y = Held   |

---

**SYSCAT.DBPARTITIONGROUPDEF**

Each row represents a database partition that is contained in a database partition group.

Table 66. SYSCAT.DBPARTITIONGROUPDEF Catalog View

| Column Name    | Data Type    | Nullable | Description   |
|----------------|--------------|----------|---|
| DBPGNAME       | VARCHAR(128) |          | Name of the database partition group that contains the database partition.  |
| DBPARTITIONNUM | SMALLINT     |          | Partition number of a database partition that is contained in the database partition group. A valid partition number is between 0 and 999, inclusive.   |
| IN_USE         | CHAR(1)      |          | Status of the database partition.<br>A = The newly added database partition is not in the distribution map, but the containers for the table spaces in the database partition group have been created; the database partition is added to the distribution map when a redistribute database partition group operation has completed successfully<br>D = The database partition will be dropped when a redistribute database partition group operation has completed successfully<br>T = The newly added database partition is not in the distribution map, and it was added using the WITHOUT TABLESPACES clause; containers must be added to the table spaces in the database partition group<br>Y = The database partition is in the distribution map |



---

## SYSCAT.DBPARTITIONGROUPS

Each row represents a database partition group.

Table 67. SYSCAT.DBPARTITIONGROUPS Catalog View

| Column Name          | Data Type    | Nullable | Description   |
|----------------------|--------------|----------|---|
| DBPGNAME             | VARCHAR(128) |          | Name of the database partition group.   |
| OWNER                | VARCHAR(128) |          | Authorization ID under which the database partition group was created.  |
| PMAP_ID              | SMALLINT     |          | Identifier for the distribution map in the SYSCAT.PARTITIONMAPS catalog view.   |
| REDISTRIBUTE_PMAP_ID | SMALLINT     |          | Identifier for the distribution map currently being used for redistribution; -1 if redistribution is currently not in progress. |
| CREATE_TIME          | TIMESTAMP    |          | Creation time of the database partition group.  |
| DEFINER <sup>1</sup> | VARCHAR(128) |          | Authorization ID under which the database partition group was created.  |
| REMARKS              | VARCHAR(254) | Y        | User-provided comments, or null.  |

**Notes:**

1. The DEFINER column is included for backwards compatibility. See OWNER.

---

**SYSCAT.EVENTMONITORS**

Each row represents an event monitor.

Table 68. SYSCAT.EVENTMONITORS Catalog View

| Column Name    | Data Type    | Nullable | Description   |
|----------------|--------------|----------|---|
| EVMONNAME      | VARCHAR(128) |          | Name of the event monitor.  |
| OWNER          | VARCHAR(128) |          | Authorization ID under which the event monitor was created.   |
| TARGET_TYPE    | CHAR(1)      |          | Type of target to which event data is written.<br>F = File<br>P = Pipe<br>T = Table   |
| TARGET         | VARCHAR(256) |          | Name of the target to which file or pipe event monitor data is written. For files, it can be either an absolute path name or a relative path name (relative to the database path for the database; this can be seen using the LIST ACTIVE DATABASES command). For pipes, it can be an absolute path name. |
| MAXFILES       | INTEGER      | Y        | Maximum number of event files that this event monitor permits in an event path. Null if there is no maximum, or if TARGET_TYPE is not 'F' (file).   |
| MAXFILESIZE    | INTEGER      | Y        | Maximum size (in 4K pages) that each event file can attain before the event monitor creates a new file. Null if there is no maximum, or if TARGET_TYPE is not 'F' (file).   |
| BUFFERSIZE     | INTEGER      | Y        | Size of the buffer (in 4K pages) that is used by event monitors with file targets; null value otherwise.  |
| IO_MODE        | CHAR(1)      | Y        | Mode of file input/output (I/O).<br>B = Blocked<br>N = Not blocked<br>Null = TARGET_TYPE is not 'F' (file) or 'T' (table)   |
| WRITE_MODE     | CHAR(1)      | Y        | Indicates how this event monitor handles existing event data when the monitor is activated.<br>A = Append<br>R = Replace<br>Null = TARGET_TYPE is not 'F' (file)  |
| AUTOSTART      | CHAR(1)      |          | Indicates whether this event monitor is to be activated automatically when the database starts.<br>N = No<br>Y = Yes  |
| DBPARTITIONNUM | SMALLINT     |          | Number of the database partition on which the event monitor runs and logs events.   |

Table 68. SYSCAT.EVENTMONITORS Catalog View (continued)

| Column Name          | Data Type    | Nullable | Description   |
|----------------------|--------------|----------|---|
| MONSCOPE             | CHAR(1)      |          | Monitoring scope.<br>G = Global<br>L = Local<br>T = Each database partition on which the table space exists<br>Blank = WRITE TO TABLE event monitor |
| EVMON_ACTIVATES      | INTEGER      |          | Number of times the event monitor has been activated.   |
| NODENUM <sup>1</sup> | SMALLINT     |          | Number of the database partition on which the event monitor runs and logs events.   |
| DEFINER <sup>2</sup> | VARCHAR(128) |          | Authorization ID under which the event monitor was created.   |
| REMARKS              | VARCHAR(254) | Y        | Reserved for future use.  |

**Notes:**

1. The NODENUM column is included for backwards compatibility. See DBPARTITIONNUM.
2. The DEFINER column is included for backwards compatibility. See OWNER.

## SYSCAT.EVENTS

---

## SYSCAT.EVENTS

Each row represents an event that is being monitored. An event monitor, in general, monitors multiple events.

Table 69. SYSCAT.EVENTS Catalog View

| Column Name | Data Type    | Nullable | Description   |
|-------------|--------------|----------|---|
| EVMONNAME   | VARCHAR(128) |          | Name of the event monitor that is monitoring this event.  |
| TYPE        | VARCHAR(18)  |          | Type of event being monitored. Possible values are:<br>CONNECTIONS<br>DATABASE<br>DEADLOCKS<br>DETAILDEADLOCKS<br>STATEMENTS<br>TABLES<br>TABLESPACES<br>TRANSACTIONS |
| FILTER      | CLOB(32K)    | Y        | Full text of the WHERE clause that applies to this event.   |

---

**SYSCAT.EVENTTABLES**

Each row represents the target table of an event monitor that writes to SQL tables.

Table 70. SYSCAT.EVENTTABLES Catalog View

| Column Name   | Data Type    | Nullable | Description  |
|---------------|--------------|----------|--|
| EVMONNAME     | VARCHAR(128) |          | Name of the event monitor.   |
| LOGICAL_GROUP | VARCHAR(18)  |          | Name of the logical data group. Possible values are:<br>BUFFERPOOL<br>CONN<br>CONNHEADER<br>CONTROL<br>DB<br>DEADLOCK<br>DLCONN<br>DLLOCK<br>STMT<br>SUBSECTION<br>TABLE<br>TABLESPACE<br>XACT |
| TABSCHEMA     | VARCHAR(128) |          | Schema name of the target table.   |
| TABNAME       | VARCHAR(128) |          | Unqualified name of the target table.  |
| PCTDEACTIVATE | SMALLINT     |          | A percent value that specifies how full a DMS table space must be before an event monitor automatically deactivates. Set to 100 for SMS table spaces.  |

---

**SYSCAT.FULLHIERARCHIES**

Each row represents the relationship between a subtable and a supertable, a subtype and a supertype, or a subview and a superview. All hierarchical relationships, including immediate ones, are included in this view.

Table 71. SYSCAT.FULLHIERARCHIES Catalog View

| Column Name  | Data Type    | Nullable | Description   |
|--------------|--------------|----------|---|
| METATYPE     | CHAR(1)      |          | Relationship type.<br>R = Between structured types<br>U = Between typed tables<br>W = Between typed views |
| SUB_SCHEMA   | VARCHAR(128) |          | Schema name of the subtype, subtable, or subview.   |
| SUB_NAME     | VARCHAR(128) |          | Unqualified name of the subtype, subtable, or subview.  |
| SUPER_SCHEMA | VARCHAR(128) |          | Schema name of the supertype, supertable, or superview.   |
| SUPER_NAME   | VARCHAR(128) |          | Unqualified name of the supertype, supertable, or superview.  |
| ROOT_SCHEMA  | VARCHAR(128) |          | Schema name of the table, view, or type that is at the root of the hierarchy.                             |
| ROOT_NAME    | VARCHAR(128) |          | Unqualified name of the table, view, or type that is at the root of the hierarchy.                        |

---

**SYSCAT.FUNCMAPOPTIONS**

Each row represents a function mapping option value.

*Table 72. SYSCAT.FUNCMAPOPTIONS Catalog View*

| Column Name      | Data Type     | Nullable | Description                           |
|------------------|---------------|----------|---------------------------------------|
| FUNCTION_MAPPING | VARCHAR(128)  |          | Name of the function mapping.         |
| OPTION           | VARCHAR(128)  |          | Name of the function mapping option.  |
| SETTING          | VARCHAR(2048) |          | Value of the function mapping option. |

---

**SYSCAT.FUNCMAPPARMOPTIONS**

Each row represents a function mapping parameter option value.

*Table 73. SYSCAT.FUNCMAPPARMOPTIONS Catalog View*

| Column Name      | Data Type     | Nullable | Description   |
|------------------|---------------|----------|---|
| FUNCTION_MAPPING | VARCHAR(128)  |          | Name of the function mapping.   |
| ORDINAL          | SMALLINT      |          | Position of the parameter.  |
| LOCATION         | CHAR(1)       |          | Location of the parameter.<br>L = Local parameter<br>R = Remote parameter |
| OPTION           | VARCHAR(128)  |          | Name of the function mapping parameter option.                            |
| SETTING          | VARCHAR(2048) |          | Value of the function mapping parameter option.                           |



## SYSCAT.FUNCMAPPINGS

Each row represents a function mapping.

Table 74. SYSCAT.FUNCMAPPINGS Catalog View

| Column Name          | Data Type     | Nullable | Description  |
|----------------------|---------------|----------|--|
| FUNCTION_MAPPING     | VARCHAR(128)  |          | Name of the function mapping (might be system-generated).  |
| FUNCSHEMA            | VARCHAR(128)  | Y        | Schema name of the function. If null, the function is assumed to be a built-in function.                   |
| FUNCNAME             | VARCHAR(1024) | Y        | Unqualified name of the user-defined or built-in function.   |
| FUNCID               | INTEGER       | Y        | Identifier for the function.   |
| SPECIFICNAME         | VARCHAR(128)  | Y        | Name of the routine instance (might be system-generated).  |
| OWNER                | VARCHAR(128)  |          | Authorization ID under which the mapping was created. 'SYSIBM' indicates that this is a built-in function. |
| WRAPNAME             | VARCHAR(128)  | Y        | Wrapper to which this mapping applies.   |
| SERVERNAME           | VARCHAR(128)  | Y        | Name of the data source.   |
| SERVERTYPE           | VARCHAR(30)   | Y        | Type of data source to which this mapping applies.   |
| SERVERVERSION        | VARCHAR(18)   | Y        | Version of the server type to which this mapping applies.  |
| CREATE_TIME          | TIMESTAMP     |          | Time at which the mapping was created.   |
| DEFINER <sup>1</sup> | VARCHAR(128)  |          | Authorization ID under which the mapping was created. 'SYSIBM' indicates that this is a built-in function. |
| REMARKS              | VARCHAR(254)  | Y        | User-provided comments, or null.   |

**Notes:**

1. The DEFINER column is included for backwards compatibility. See OWNER.

---

**SYSCAT.HIERARCHIES**

Each row represents the relationship between a subtable and its immediate supertable, a subtype and its immediate supertype, or a subview and its immediate superview. Only immediate hierarchical relationships are included in this view.

Table 75. SYSCAT.HIERARCHIES Catalog View

| Column Name  | Data Type    | Nullable | Description   |
|--------------|--------------|----------|---|
| METATYPE     | CHAR(1)      |          | Relationship type.<br>R = Between structured types<br>U = Between typed tables<br>W = Between typed views |
| SUB_SCHEMA   | VARCHAR(128) |          | Schema name of the subtype, subtable, or subview.   |
| SUB_NAME     | VARCHAR(128) |          | Unqualified name of the subtype, subtable, or subview.  |
| SUPER_SCHEMA | VARCHAR(128) |          | Schema name of the supertype, supertable, or superview.   |
| SUPER_NAME   | VARCHAR(128) |          | Unqualified name of the supertype, supertable, or superview.  |
| ROOT_SCHEMA  | VARCHAR(128) |          | Schema name of the table, view, or type that is at the root of the hierarchy.                             |
| ROOT_NAME    | VARCHAR(128) |          | Unqualified name of the table, view, or type that is at the root of the hierarchy.                        |

---

**SYSCAT.INDEXAUTH**

Each row represents a user or group that has been granted CONTROL privilege on an index.

*Table 76. SYSCAT.INDEXAUTH Catalog View*

| Column Name | Data Type    | Nullable | Description   |
|-------------|--------------|----------|---|
| GRANTOR     | VARCHAR(128) |          | Grantor of the privilege.                                   |
| GRANTEE     | VARCHAR(128) |          | Holder of the privilege.                                    |
| GRANTEETYPE | CHAR(1)      |          | G = Grantee is a group<br>U = Grantee is an individual user |
| INDSCHEMA   | VARCHAR(128) |          | Schema name of the index.                                   |
| INDNAME     | VARCHAR(128) |          | Unqualified name of the index.                              |
| CONTROLAUTH | CHAR(1)      |          | CONTROL privilege.<br>N = Not held<br>Y = Held              |

---

**SYSCAT.INDEXCOLUSE**

Each row represents a column that participates in an index.

*Table 77. SYSCAT.INDEXCOLUSE Catalog View*

| <b>Column Name</b> | <b>Data Type</b> | <b>Nullable</b> | <b>Description</b>  |
|--------------------|------------------|-----------------|---|
| INDSCHEMA          | VARCHAR(128)     |                 | Schema name of the index.   |
| INDNAME            | VARCHAR(128)     |                 | Unqualified name of the index.  |
| COLNAME            | VARCHAR(128)     |                 | Name of the column.   |
| COLSEQ             | SMALLINT         |                 | Numeric position of the column in the index (initial position is 1).  |
| COLORDER           | CHAR(1)          |                 | Order of the values in this index column.<br>Possible values are:<br>A = Ascending<br>D = Descending<br>I = INCLUDE column (ordering ignored) |

## SYSCAT.INDEXDEP

Each row represents a dependency of an index on some other object. The index depends on an object of type BTYPE and name BNAME, so a change to the object affects the index.

Table 78. SYSCAT.INDEXDEP Catalog View

| Column Name | Data Type    | Nullable | Description  |
|-------------|--------------|----------|--|
| INDSCHEMA   | VARCHAR(128) |          | Schema name of the index.  |
| INDNAME     | VARCHAR(128) |          | Unqualified name of the index.   |
| BTYPE       | CHAR(1)      |          | Type of object on which there is a dependency. Possible values are:<br>A = Alias<br>B = Trigger<br>F = Routine instance<br>H = Hierachy table<br>K = Package<br>L = Detached table<br>O = Privilege dependency on all subtables or subviews in a table or view hierarchy<br>Q = Sequence<br>R = Structured type<br>S = Materialized query table<br>T = Table (not typed)<br>U = Typed table<br>V = View (not typed)<br>W = Typed view<br>X = Index extension<br>Z = XSR object |
| BSCHEMA     | VARCHAR(128) |          | Schema name of the object on which there is a dependency.  |
| BNAME       | VARCHAR(128) |          | Unqualified name of the object on which there is a dependency. For routines (BTYPE = 'F'), this is the specific name.  |
| TABAUTH     | SMALLINT     | Y        | If BTYPE = 'O', 'S', 'T', 'U', 'V' or 'W', encodes the privileges on the table or view that are required by the dependent index; null value otherwise.   |

---

**SYSCAT.INDEXES**

Each row represents an index. Indexes on typed tables are represented by two rows: one for the “logical index” on the typed table, and one for the “H-index” on the hierarchy table.

Table 79. SYSCAT.INDEXES Catalog View

| Column Name            | Data Type    | Nullable | Description   |
|------------------------|--------------|----------|---|
| INDSCHEMA              | VARCHAR(128) |          | Schema name of the index.   |
| INDNAME                | VARCHAR(128) |          | Unqualified name of the index.  |
| OWNER                  | VARCHAR(128) |          | Authorization ID under which the index was created.   |
| TABSCHEMA              | VARCHAR(128) |          | Schema name of the table or nickname on which the index is defined.   |
| TABNAME                | VARCHAR(128) |          | Unqualified name of the table or nickname on which the index is defined.  |
| COLNAMES               | VARCHAR(640) |          | This column is no longer used and will be removed in the next release. Use SYSCAT.INDEXCOLUSE for this information.   |
| UNIQUERULE             | CHAR(1)      |          | Unique rule.<br>D = Permits duplicates<br>U = Unique<br>P = Implements primary key  |
| MADE_UNIQUE            | CHAR(1)      |          | N = Index remains as it was created<br>Y = This index was originally non-unique but was converted to a unique index to support a unique or primary key constraint. If the constraint is dropped, the index reverts to being non-unique.   |
| COLCOUNT               | SMALLINT     |          | Number of columns in the key, plus the number of include columns, if any.   |
| UNIQUE_COLCOUNT        | SMALLINT     |          | Number of columns required for a unique key. It is always $\leq$ COLCOUNT, and $<$ COLCOUNT only if there are include columns; -1 if the index has no unique key (that is, it permits duplicates).  |
| INDEXTYPE <sup>5</sup> | CHAR(4)      |          | Type of index.<br>BLOK = Block index<br>CLUS = Clustering index (controls the physical placement of newly inserted rows)<br>DIM = Dimension block index<br>REG = Regular index<br>XPTH = XML path index<br>XRGN = XML region index<br>XVIL = Index over XML column (logical)<br>XVIP = Index over XML column (physical) |

Table 79. SYSCAT.INDEXES Catalog View (continued)

| Column Name                | Data Type | Nullable | Description   |
|----------------------------|-----------|----------|---|
| ENTRYTYPE                  | CHAR(1)   |          | H = This row represents an index on a hierarchy table<br>L = This row represents a logical index on a typed table<br>Blank = This row represents an index on an untyped table     |
| PCTFREE                    | SMALLINT  |          | Percentage of each index page to be reserved during the initial building of the index. This space is available for data insertions after the index has been built.                |
| IID                        | SMALLINT  |          | Identifier for the index.   |
| NLEAF                      | BIGINT    |          | Number of leaf pages; -1 if statistics are not collected.   |
| NLEVELS                    | SMALLINT  |          | Number of index levels; -1 if statistics are not collected.   |
| FIRSTKEYCARD               | BIGINT    |          | Number of distinct first-key values; -1 if statistics are not collected.  |
| FIRST2KEYCARD              | BIGINT    |          | Number of distinct keys using the first two columns of the index; -1 if statistics are not collected, or if not applicable.   |
| FIRST3KEYCARD              | BIGINT    |          | Number of distinct keys using the first three columns of the index; -1 if statistics are not collected, or if not applicable.   |
| FIRST4KEYCARD              | BIGINT    |          | Number of distinct keys using the first four columns of the index; -1 if statistics are not collected, or if not applicable.  |
| FULLKEYCARD                | BIGINT    |          | Number of distinct full-key values; -1 if statistics are not collected.   |
| CLUSTERRATIO <sup>3</sup>  | SMALLINT  |          | Degree of data clustering with the index; -1 if statistics are not collected or if detailed index statistics are collected (in which case, CLUSTERFACTOR will be used instead).   |
| CLUSTERFACTOR <sup>3</sup> | DOUBLE    |          | Finer measurement of the degree of clustering; -1 if statistics are not collected or if the index is defined on a nickname.   |
| SEQUENTIAL_PAGES           | BIGINT    |          | Number of leaf pages located on disk in index key order with few or no large gaps between them; -1 if statistics are not collected.   |
| DENSITY                    | INTEGER   |          | Ratio of SEQUENTIAL_PAGES to number of pages in the range of pages occupied by the index, expressed as a percent (integer between 0 and 100); -1 if statistics are not collected. |
| USER_DEFINED               | SMALLINT  |          | 1 if this index was defined by a user and has not been dropped; 0 otherwise.  |

## SYSCAT.INDEXES

Table 79. SYSCAT.INDEXES Catalog View (continued)

| Column Name                   | Data Type    | Nullable | Description   |
|-------------------------------|--------------|----------|---|
| SYSTEM_REQUIRED               | SMALLINT     |          | <p>1 if one or the other of the following conditions is met:</p> <ul style="list-style-type: none"> <li>– This index is required for a primary or unique key constraint, or this index is a dimension block index or composite block index for a multidimensional clustering (MDC) table.</li> <li>– This is the index on the object identifier (OID) column of a typed table.</li> </ul> <p>2 if both of the following conditions are met:</p> <ul style="list-style-type: none"> <li>– This index is required for a primary or unique key constraint, or this index is a dimension block index or composite block index for an MDC table.</li> <li>– This is the index on the OID column of a typed table.</li> </ul> <p>0 otherwise.</p> |
| CREATE_TIME                   | TIMESTAMP    |          | Time when the index was created.  |
| STATS_TIME                    | TIMESTAMP    | Y        | Last time that any change was made to the recorded statistics for this index. Null if no statistics are available.  |
| PAGE_FETCH_PAIRS <sup>3</sup> | VARCHAR(520) |          | A list of pairs of integers, represented in character form. Each pair represents the number of pages in a hypothetical buffer, and the number of page fetches required to scan the table with this index using that hypothetical buffer. Zero-length string if no data is available.  |
| MINPCTUSED                    | SMALLINT     |          | A non-zero integer value indicates that the index is enabled for online defragmentation, and represents the minimum percentage of used space on a page before a page merge can be attempted. A zero value indicates that no page merge is attempted.  |
| REVERSE_SCANS                 | CHAR(1)      |          | <p>N = Index does not support reverse scans</p> <p>Y = Index supports reverse scans</p>   |
| INTERNAL_FORMAT               | SMALLINT     |          | <p>Possible values are:</p> <p>1 = Index does not have backward pointers</p> <p>2 or greater = Index has backward pointers</p> <p>6 = Index is a composite block index</p>  |
| IESHEMA                       | VARCHAR(128) | Y        | Schema name of the index extension. Null for ordinary indexes.  |
| IENAME                        | VARCHAR(18)  | Y        | Unqualified name of the index extension. Null for ordinary indexes.   |



Table 79. SYSCAT.INDEXES Catalog View (continued)

| Column Name                                 | Data Type | Nullable | Description   |
|---|-----------|----------|---|
| IEARGUMENTS                                 | CLOB(32K) | Y        | External information of the parameter specified when the index is created. Null for ordinary indexes.   |
| INDEX_OBJECTID                              | INTEGER   |          | Identifier for the index object.  |
| NUMRIDS                                     | BIGINT    |          | Total number of row identifiers (RIDs) or block identifiers (BIDs) in the index; -1 if not known.   |
| NUMRIDS_DELETED                             | BIGINT    |          | Total number of row identifiers (or block identifiers) in the index that are marked deleted, excluding those identifiers on leaf pages on which all the identifiers are marked deleted.   |
| NUM_EMPTY_LEAFS                             | BIGINT    |          | Total number of index leaf pages that have all of their row identifiers (or block identifiers) marked deleted.  |
| AVERAGE_RANDOM_FETCH_PAGES <sup>1,2</sup>   | DOUBLE    |          | Average number of random table pages between sequential page accesses when fetching using the index; -1 if not known.   |
| AVERAGE_RANDOM_PAGES <sup>2</sup>           | DOUBLE    |          | Average number of random table pages between sequential page accesses; -1 if not known.   |
| AVERAGE_SEQUENCE_GAP <sup>2</sup>           | DOUBLE    |          | Gap between index page sequences. Detected through a scan of index leaf pages, each gap represents the average number of index pages that must be randomly fetched between sequences of index pages; -1 if not known.                               |
| AVERAGE_SEQUENCE_FETCH_GAP <sup>1,2</sup>   | DOUBLE    |          | Gap between table page sequences when fetching using the index. Detected through a scan of index leaf pages, each gap represents the average number of table pages that must be randomly fetched between sequences of table pages; -1 if not known. |
| AVERAGE_SEQUENCE_PAGES <sup>2</sup>         | DOUBLE    |          | Average number of index pages that are accessible in sequence (that is, the number of index pages that the prefetchers would detect as being in sequence); -1 if not known.   |
| AVERAGE_SEQUENCE_FETCH_PAGES <sup>1,2</sup> | DOUBLE    |          | Average number of table pages that are accessible in sequence (that is, the number of table pages that the prefetchers would detect as being in sequence) when fetching using the index; -1 if not known.   |
| TBSPACEID                                   | INTEGER   |          | Identifier for the index table space.   |
| LEVEL2PCTFREE                               | SMALLINT  |          | Percentage of each index level 2 page to be reserved during initial building of the index. This space is available for future inserts after the index has been built.   |
| PAGESPLIT                                   | CHAR(1)   |          | Index page split behavior.<br>H = High<br>L = Low<br>S = Symmetric  |

## SYSCAT.INDEXES

Table 79. SYSCAT.INDEXES Catalog View (continued)

| Column Name                                    | Data Type    | Nullable | Description  |
|--|--------------|----------|--|
| AVGPARTITION_<br>CLUSTERRATIO <sup>3</sup>     | SMALLINT     |          | Degree of data clustering within a single data partition. -1 if the table is not partitioned, if statistics are not collected, or if detailed statistics are collected (in which case AVGPARTITION_ CLUSTERFACTOR will be used instead).                                     |
| AVGPARTITION_<br>CLUSTERFACTOR <sup>3</sup>    | DOUBLE       |          | Finer measurement of the degree of clustering within a single data partition. -1 if the table is not partitioned, if statistics are not collected, or if the index is defined on a nickname.   |
| AVGPARTITION_PAGE_FETCH_<br>PAIRS <sup>3</sup> | VARCHAR(520) |          | A list of paired integers in character form. Each pair represents a potential buffer pool size and the corresponding page fetches required to access a single data partition from the table. Zero-length string if no data is available, or if the table is not partitioned. |
| DATAPARTITION_<br>CLUSTERFACTOR                | DOUBLE       |          | A statistic measuring the "clustering" of the index keys with regard to data partitions. It is a number between 0 and 1, with 1 representing perfect clustering and 0 representing no clustering.  |
| INDCARD  | BIGINT       |          | Cardinality of the index. This might be different from the cardinality of the table for indexes that do not have a one-to-one relationship between the table rows and the index entries.   |
| DEFINER <sup>4</sup>                           | VARCHAR(128) |          | Authorization ID under which the index was created.  |
| REMARKS  | VARCHAR(254) | Y        | User-provided comments, or null.   |

### Notes:

1. When using DMS table spaces, this statistic cannot be computed.
2. Prefetch statistics are not gathered during a LOAD...STATISTICS YES, or a CREATE INDEX...COLLECT STATISTICS operation, or when the database configuration parameter *seqdetect* is turned off.
3. AVGPARTITION\_ CLUSTERRATIO, AVGPARTITION\_ CLUSTERFACTOR, and AVGPARTITION\_ PAGE\_FETCH\_ PAIRS measure the degree of clustering within a single data partition (local clustering). CLUSTERRATIO, CLUSTERFACTOR, and PAGE\_FETCH\_ PAIRS measure the degree of clustering in the entire table (global clustering). Global clustering and local clustering values can diverge significantly if the table partitioning key is not a prefix of the index key, or when the table partitioning key and the index key are logically independent of each other.
4. The DEFINER column is included for backwards compatibility. See OWNER.
5. The XPTH, XRGN, and XVIP indexes are not recognized by any application programming interface that returns index metadata.

### Related reference:

- "SYSCAT.INDEXCOLUSE " on page 630

---

**SYSCAT.INDEXEXPLOITRULES**

Each row represents an index exploitation rule.

*Table 80. SYSCAT.INDEXEXPLOITRULES Catalog View*

| Column Name    | Data Type     | Nullable | Description  |
|----------------|---------------|----------|--|
| FUNCID         | INTEGER       |          | Identifier for the function.   |
| SPECID         | SMALLINT      |          | Number of the predicate specification.   |
| IESHEMA        | VARCHAR(128)  |          | Schema name of the index extension.  |
| IENAME         | VARCHAR(128)  |          | Unqualified name of the index extension.   |
| RULEID         | SMALLINT      |          | Identifier for the exploitation rule.  |
| SEARCHMETHODID | SMALLINT      |          | Identifier for the search method in the specific index extension.  |
| SEARCHKEY      | VARCHAR(320)  |          | Key used to exploit the index.   |
| SEARCHARGUMENT | VARCHAR(1800) |          | Search arguments used to exploit the index.  |
| EXACT          | CHAR(1)       |          | N = Index lookup is not exact in terms of predicate evaluation<br>Y = Index lookup is exact in terms of predicate evaluation |

---

**SYSCAT.INDEXEXTENSIONDEP**

Each row represents a dependency of an index extension on some other object. The index extension depends on the object of type BTYPE of name BNAME, so a change to the object affects the index extension.

Table 81. SYSCAT.INDEXEXTENSIONDEP Catalog View

| Column Name | Data Type    | Nullable | Description  |
|-------------|--------------|----------|--|
| IESCHEMA    | VARCHAR(128) |          | Schema name of the index extension.  |
| IENAME      | VARCHAR(128) |          | Unqualified name of the index extension.   |
| BTYPE       | CHAR(1)      |          | Type of object on which there is a dependency. Possible values are:<br>A = Alias<br>B = Trigger<br>F = Routine instance<br>H = Hierachy table<br>K = Package<br>L = Detached table<br>O = Privilege dependency on all subtables or subviews in a table or view hierarchy<br>Q = Sequence<br>R = Structured type<br>S = Materialized query table<br>T = Table (not typed)<br>U = Typed table<br>V = View (not typed)<br>W = Typed view<br>X = Index extension<br>Z = XSR object |
| BSCHEMA     | VARCHAR(128) |          | Schema name of the object on which there is a dependency.  |
| BNAME       | VARCHAR(128) |          | Unqualified name of the object on which there is a dependency. For routines (BTYPE = 'F'), this is the specific name.  |
| TABAUTH     | SMALLINT     | Y        | If BTYPE = 'O', 'S', 'T', 'U', 'V' or 'W', encodes the privileges on the table or view that are required by the dependent index extension; null value otherwise.   |

---

**SYSCAT.INDEXEXTENSIONMETHODS**

Each row represents a search method. An index extension can contain more than one search method.

Table 82. SYSCAT.INDEXEXTENSIONMETHODS Catalog View

| Column Name        | Data Type    | Nullable | Description  |
|--------------------|--------------|----------|--|
| METHODNAME         | VARCHAR(128) |          | Name of the search method.   |
| METHODID           | SMALLINT     |          | Number of the method in the index extension.                             |
| IESHEMA            | VARCHAR(128) |          | Schema name of the index extension on which this method is defined.      |
| IENAME             | VARCHAR(128) |          | Unqualified name of the index extension on which this method is defined. |
| RANGEFUNCSHEMA     | VARCHAR(128) |          | Schema name of the range-through function.                               |
| RANGEFUNCNAME      | VARCHAR(18)  |          | Unqualified name of the range-through function.                          |
| RANGESPECIFICNAME  | VARCHAR(18)  |          | Function-specific name of the range-through function.                    |
| FILTERFUNCSHEMA    | VARCHAR(128) | Y        | Schema name of the filter function.                                      |
| FILTERFUNCNAME     | VARCHAR(128) | Y        | Unqualified name of the filter function.                                 |
| FILTERSPECIFICNAME | VARCHAR(128) | Y        | Function-specific name of the filter function.                           |
| REMARKS            | VARCHAR(254) | Y        | User-provided comments, or null.   |

---

**SYSCAT.INDEXEXTENSIONPARMS**

Each row represents an index extension instance parameter or source key column.

*Table 83. SYSCAT.INDEXEXTENSIONPARMS Catalog View*

| Column Name | Data Type    | Nullable | Description  |
|-------------|--------------|----------|--|
| IESHEMA     | VARCHAR(128) |          | Schema name of the index extension.  |
| IENAME      | VARCHAR(128) |          | Unqualified name of the index extension.                                     |
| ORDINAL     | SMALLINT     |          | Sequence number of the parameter or key column.                              |
| PARAMNAME   | VARCHAR(128) |          | Name of the parameter or key column.   |
| TYPESHEMA   | VARCHAR(128) |          | Schema name of the data type of the parameter or key column.                 |
| TYPENAME    | VARCHAR(128) |          | Unqualified name of the data type of the parameter or key column.            |
| LENGTH      | INTEGER      |          | Data type length of the parameter or key column.                             |
| SCALE       | SMALLINT     |          | Data type scale of the parameter or key column; 0 if not applicable.         |
| PARMTYPE    | CHAR(1)      |          | K = Source key column<br>P = Index extension instance parameter              |
| CODEPAGE    | SMALLINT     |          | Code page of the index extension instance parameter; 0 if not a string type. |

---

**SYSCAT.INDEXEXTENSIONS**

Each row represents an index extension.

*Table 84. SYSCAT.INDEXEXTENSIONS Catalog View*

| Column Name          | Data Type    | Nullable | Description   |
|----------------------|--------------|----------|---|
| IESHEMA              | VARCHAR(128) |          | Schema name of the index extension.                                       |
| IENAME               | VARCHAR(128) |          | Unqualified name of the index extension.                                  |
| OWNER                | VARCHAR(128) |          | Authorization ID under which the index extension was created.             |
| CREATE_TIME          | TIMESTAMP    |          | Time at which the index extension was defined.                            |
| KEYGENFUNCSHEMA      | VARCHAR(128) |          | Schema name of the key generation function.                               |
| KEYGENFUNCNAME       | VARCHAR(128) |          | Unqualified name of the key generation function.                          |
| KEYGENSPECIFICNAME   | VARCHAR(128) |          | Name of the key generation function instance (might be system-generated). |
| TEXT                 | CLOB(2M)     |          | Full text of the CREATE INDEX EXTENSION statement.                        |
| DEFINER <sup>1</sup> | VARCHAR(128) |          | Authorization ID under which the index extension was created.             |
| REMARKS              | VARCHAR(254) | Y        | User-provided comments, or null.  |

**Notes:**

1. The DEFINER column is included for backwards compatibility. See OWNER.

---

**SYSCAT.INDEXOPTIONS**

Each row represents an index-specific option value.

*Table 85. SYSCAT.INDEXOPTIONS Catalog View*

| <b>Column Name</b> | <b>Data Type</b> | <b>Nullable</b> | <b>Description</b>             |
|--------------------|------------------|-----------------|--------------------------------|
| INDSCHEMA          | VARCHAR(128)     |                 | Schema name of the index.      |
| INDNAME            | VARCHAR(128)     |                 | Unqualified name of the index. |
| OPTION             | VARCHAR(128)     |                 | Name of the index option.      |
| SETTING            | VARCHAR(2048)    |                 | Value of the index option.     |



---

**SYSCAT.INDEXXMLPATTERNS**

Each row represents a pattern clause in an index over an XML column.

Table 86. SYSCAT.INDEXXMLPATTERNS Catalog View

| Column Name | Data Type    | Nullable | Description   |
|-------------|--------------|----------|---|
| INDSCHEMA   | VARCHAR(128) |          | Schema name of the logical index.   |
| INDNAME     | VARCHAR(128) |          | Unqualified name of the logical index.  |
| PINDNAME    | VARCHAR(128) |          | Unqualified name of the physical index.                                       |
| PINDID      | SMALLINT     |          | Identifier for the physical index.  |
| TYPEMODEL   | CHAR(1)      |          | Q = SQL DATA TYPE   |
| DATATYPE    | VARCHAR(128) |          | Name of the data type.  |
| HASHED      | CHAR(1)      |          | Indicates whether or not the value is hashed.<br>N = Not hashed<br>Y = Hashed |
| LENGTH      | SMALLINT     |          | VARCHAR( <i>n</i> ) length; 0 otherwise.                                      |
| PATTERNID   | SMALLINT     |          | Identifier for the pattern.   |
| PATTERN     | CLOB(2M)     | Y        | Definition of the pattern .   |

**Notes:**

1. When you create indexes over XML columns, logical indexes that utilize XML pattern information are created, resulting in the creation of physical B-tree indexes with DB2-generated key columns to support the logical indexes. A physical index is created to support the data type that is specified in the `xmltype`-clause of the `CREATE INDEX` statement.

---

**SYSCAT.KEYCOLUSE**

Each row represents a column that participates in a key defined by a unique, primary key, or foreign key constraint.

*Table 87. SYSCAT.KEYCOLUSE Catalog View*

| <b>Column Name</b> | <b>Data Type</b> | <b>Nullable</b> | <b>Description</b>   |
|--------------------|------------------|-----------------|--|
| CONSTNAME          | VARCHAR(128)     |                 | Name of the constraint.  |
| TABSCHEMA          | VARCHAR(128)     |                 | Schema name of the table containing the column.                    |
| TABNAME            | VARCHAR(128)     |                 | Unqualified name of the table containing the column.               |
| COLNAME            | VARCHAR(128)     |                 | Name of the column.  |
| COLSEQ             | SMALLINT         |                 | Numeric position of the column in the key (initial position is 1). |

## SYSCAT.NAMEMAPPINGS

Each row represents the mapping between a “logical” object (typed table or view and its columns and indexes, including inherited columns) and the corresponding “implementation” object (hierarchy table or hierarchy view and its columns and indexes) that implements the logical object.

Table 88. SYSCAT.NAMEMAPPINGS Catalog View

| Column Name     | Data Type    | Nullable | Description   |
|-----------------|--------------|----------|---|
| TYPE            | CHAR(1)      |          | C = Column<br>I = Index<br>U = Typed table  |
| LOGICAL_SCHEMA  | VARCHAR(128) |          | Schema name of the logical object.  |
| LOGICAL_NAME    | VARCHAR(128) |          | Unqualified name of the logical object.   |
| LOGICAL_COLNAME | VARCHAR(128) | Y        | Name of the logical column if TYPE = 'C'; null value otherwise.                   |
| IMPL_SCHEMA     | VARCHAR(128) |          | Schema name of the implementation object that implements the logical object.      |
| IMPL_NAME       | VARCHAR(128) |          | Unqualified name of the implementation object that implements the logical object. |
| IMPL_COLNAME    | VARCHAR(128) | Y        | Name of the implementation column if TYPE = 'C'; null value otherwise.            |

---

**SYSCAT.NICKNAMES**

Each row represents a nickname.

Table 89. SYSCAT.NICKNAMES Catalog View

| Column Name | Data Type    | Nullable | Description   |
|-------------|--------------|----------|---|
| TABSCHEMA   | VARCHAR(128) |          | Schema name of the nickname.  |
| TABNAME     | VARCHAR(128) |          | Unqualified name of the nickname.   |
| DEFINER     | VARCHAR(128) |          | User who created the nickname.  |
| STATUS      | CHAR(1)      |          | Status of the object.<br>C = Set integrity pending<br>N = Normal<br>X = Inoperative   |
| CREATE_TIME | TIMESTAMP    |          | Time at which the object was created.   |
| STATS_TIME  | TIMESTAMP    | Y        | Time at which any change was last made to recorded statistics for this object. Null if statistics are not collected.  |
| COLCOUNT    | SMALLINT     |          | Number of columns, including inherited columns (if any).  |
| TABLEID     | SMALLINT     |          | Internal logical object identifier.   |
| TBSPACEID   | SMALLINT     |          | Internal logical identifier for the primary table space for this object.  |
| CARD        | BIGINT       |          | Total number of rows; -1 if statistics are not collected.   |
| NPAGES      | BIGINT       |          | Total number of pages on which the rows of the nickname exist; -1 if statistics are not gathered.   |
| FPAGES      | BIGINT       |          | Total number of pages; -1 if statistics are not gathered.   |
| OVERFLOW    | BIGINT       |          | Total number of overflow records; -1 if statistics are not gathered.  |
| PARENTS     | SMALLINT     | Y        | Number of parent tables for this object; that is, the number of referential constraints in which this object is a dependent.  |
| CHILDREN    | SMALLINT     | Y        | Number of dependent tables for this object; that is, the number of referential constraints in which this object is a parent.  |
| SELFREFS    | SMALLINT     | Y        | Number of self-referencing referential constraints for this object; that is, the number of referential constraints in which this object is both a parent and a dependent. |
| KEYCOLUMNS  | SMALLINT     | Y        | Number of columns in the primary key.   |
| KEYINDEXID  | SMALLINT     | Y        | Index identifier for the primary key index; 0 or the null value if there is no primary key.   |
| KEYUNIQUE   | SMALLINT     |          | Number of unique key constraints (other than the primary key constraint) defined on this object.  |
| CHECKCOUNT  | SMALLINT     |          | Number of check constraints defined on this object.   |

Table 89. SYSCAT.NICKNAMES Catalog View (continued)

| Column Name        | Data Type    | Nullable | Description  |
|--------------------|--------------|----------|--|
| DATA_CAPTURE       | CHAR(1)      |          | <p>L = Nickname participates in data replication, including replication of LONG VARCHAR and LONG VARGRAPHIC columns</p> <p>N = Nickname does not participate in data replication</p> <p>Y = Nickname participates in data replication</p>  |
| CONST_CHECKED      | CHAR(32)     |          | <p>Byte 1 represents foreign key constraint.</p> <p>Byte 2 represents check constraint.</p> <p>Byte 5 represents materialized query table.</p> <p>Byte 6 represents generated column.</p> <p>Byte 7 represents staging table.</p> <p>Byte 8 represents data partitioning constraint.</p> <p>Other bytes are reserved for future use.</p> <p>Possible values are:</p> <p>F = In byte 5, the materialized query table cannot be refreshed incrementally.</p> <p>In byte 7, the content of the staging table is incomplete and cannot be used for incremental refresh of the associated materialized query table.</p> <p>N = Not checked</p> <p>U = Checked by user</p> <p>W = Was in 'U' state when the table was placed in set integrity pending state</p> <p>Y = Checked by system</p> |
| PARTITION_MODE     | CHAR(1)      |          | Reserved for future use.   |
| STATISTICS_PROFILE | CLOB(10M)    | Y        | RUNSTATS command used to register a statistical profile for the object.  |
| ACCESS_MODE        | CHAR(1)      |          | <p>Access restriction state of the object. These states only apply to objects that are in set integrity pending state or to objects that were processed by a SET INTEGRITY statement. Possible values are:</p> <p>D = No data movement</p> <p>F = Full access</p> <p>N = No access</p> <p>R = Read-only access</p>   |
| CODEPAGE           | SMALLINT     |          | Code page of the object. This is the default code page used for all character columns, triggers, check constraints, and expression-generated columns.  |
| REMOTE_TABLE       | VARCHAR(128) |          | Unqualified name of the specific data source object (such as a table or a view) for which the nickname was created.  |

## SYSCAT.NICKNAMES

Table 89. SYSCAT.NICKNAMES Catalog View (continued)

| Column Name    | Data Type    | Nullable | Description  |
|----------------|--------------|----------|--|
| REMOTE_SCHEMA  | VARCHAR(128) |          | Schema name of the specific data source object (such as a table or a view) for which the nickname was created. |
| SERVER_NAME    | VARCHAR(128) |          | Name of the data source that contains the table or view for which the nickname was created.                    |
| CACHINGALLOWED | VARCHAR(32)  |          | N = Caching is not allowed<br>Y = Caching is allowed   |
| REMARKS        | VARCHAR(254) | Y        | User-provided comments, or null.   |

---

**SYSCAT.PACKAGEAUTH**

Each row represents a user or group that has been granted one or more privileges on a package.

Table 90. SYSCAT.PACKAGEAUTH Catalog View

| Column Name | Data Type    | Nullable | Description   |
|-------------|--------------|----------|---|
| GRANTOR     | VARCHAR(128) |          | Grantor of the privilege.   |
| GRANTEE     | VARCHAR(128) |          | Holder of the privilege.  |
| GRANTEETYPE | CHAR(1)      |          | G = Grantee is a group<br>U = Grantee is an individual user                             |
| PKGSHEMA    | VARCHAR(128) |          | Schema name of the package.   |
| PKGNAME     | VARCHAR(128) |          | Unqualified name of the package.  |
| CONTROLAUTH | CHAR(1)      |          | CONTROL privilege.<br>N = Not held<br>Y = Held  |
| BINDAUTH    | CHAR(1)      |          | Privilege to bind the package.<br>G = Held and grantable<br>N = Not held<br>Y = Held    |
| EXECUTEAUTH | CHAR(1)      |          | Privilege to execute the package.<br>G = Held and grantable<br>N = Not held<br>Y = Held |

---

**SYSCAT.PACKAGEDEP**

Each row represents a dependency of a package on some other object. The package depends on the object of type BTYPE of name BNAME, so a change to the object affects the package.

Table 91. SYSCAT.PACKAGEDEP Catalog View

| Column Name | Data Type            | Nullable | Description  |
|-------------|----------------------|----------|--|
| PKGSHEMA    | VARCHAR(128)         |          | Schema name of the package.  |
| PKGNAME     | VARCHAR(128)         |          | Unqualified name of the package.   |
| BINDER      | VARCHAR(128)         |          | Binder of the package.   |
| BTYPE       | CHAR(1)              |          | Type of object on which there is a dependency. Possible values are:<br>A = Alias<br>B = Trigger<br>D = Server definition<br>F = Routine instance<br>I = Index<br>M = Function mapping<br>N = Nickname<br>O = Privilege dependency on all subtables or subviews in a table or view hierarchy<br>P = Page size<br>Q = Sequence object<br>R = Structured type<br>S = Materialized query table<br>T = Table (untyped)<br>U = Typed table<br>V = View (untyped)<br>W = Typed view<br>Z = XSR object |
| BSCHEMA     | VARCHAR(128)         |          | Schema name of an object on which the package depends.   |
| BNAME       | VARCHAR(128)         |          | Unqualified name of an object on which the package depends.  |
| TABAUTH     | SMALLINT             | Y        | If BTYPE is 'O', 'S', 'T', 'U', 'V', or 'W', encodes the privileges that are required by this package (SELECT, INSERT, UPDATE, or DELETE).   |
| UNIQUE_ID   | CHAR(8) FOR BIT DATA |          | Identifier for a specific package when multiple packages having the same name exist.   |
| PKGVERSION  | VARCHAR(64)          |          | Version identifier for the package.  |

**Notes:**

1. If a function instance with dependencies is dropped, the package is put into an "inoperative" state, and it must be explicitly rebound. If any other object with dependencies is dropped, the package is put into an "invalid" state, and the system will attempt to rebind the package automatically when it is first referenced.



## SYSCAT.PACKAGES

Each row represents a package that has been created by binding an application program.

Table 92. SYSCAT.PACKAGES Catalog View

| Column Name        | Data Type            | Nullable | Description   |
|--------------------|----------------------|----------|---|
| PKGSHEMA           | VARCHAR(128)         |          | Schema name of the package.   |
| PKGNAME            | VARCHAR(128)         |          | Unqualified name of the package.  |
| BOUNDBY            | VARCHAR(128)         |          | Authorization ID of the binder of the package.  |
| OWNER              | VARCHAR(128)         |          | Authorization ID under which the package was bound.   |
| DEFAULT_SCHEMA     | VARCHAR(128)         |          | Default schema name used for unqualified names in static SQL statements.  |
| VALID <sup>1</sup> | CHAR(1)              |          | N = Needs rebinding<br>V = Validate at run time<br>X = Package is inoperative because some function instance on which it depends has been dropped; explicit rebind is needed<br>Y = Valid |
| UNIQUE_ID          | CHAR(8) FOR BIT DATA |          | Identifier for a specific package when multiple packages having the same name exist.  |
| TOTAL_SECT         | SMALLINT             |          | Number of sections in the package.  |
| FORMAT             | CHAR(1)              |          | Date and time format associated with the package.<br>0 = Format associated with the territory code of the client<br>1 = USA<br>2 = EUR<br>3 = ISO<br>4 = JIS<br>5 = LOCAL                 |
| ISOLATION          | CHAR(2)              | Y        | Isolation level.<br>CS = Cursor Stability<br>RR = Repeatable Read<br>RS = Read Stability<br>UR = Uncommitted Read   |
| BLOCKING           | CHAR(1)              | Y        | Cursor blocking option.<br>B = Block all cursors<br>N = No blocking<br>U = Block unambiguous cursors  |

## SYSCAT.PACKAGES

Table 92. SYSCAT.PACKAGES Catalog View (continued)

| Column Name      | Data Type    | Nullable | Description   |
|------------------|--------------|----------|---|
| INSERT_BUF       | CHAR(1)      |          | Setting of the INSERT bind option (applies to partitioned database systems).<br>N = Inserts are not buffered<br>Y = Inserts are buffered at the coordinator database partition to minimize traffic among database partitions  |
| LANG_LEVEL       | CHAR(1)      | Y        | Setting of the LANGLEVEL bind option.<br>0 = SAA1<br>1 = MIA<br>2 = SQL92E  |
| FUNC_PATH        | VARCHAR(254) |          | SQL path used by the last bind operation for this package. This is used as the default path for rebind operations. 'SYSIBM' for pre-Version 2 packages.   |
| QUERYOPT         | INTEGER      |          | Optimization class under which this package was bound. Used for rebind operations.  |
| EXPLAIN_LEVEL    | CHAR(1)      |          | Indicates whether Explain was requested using the EXPLAIN or EXPLSNAP bind option.<br>P = Package selection level<br>Blank = No Explain requested   |
| EXPLAIN_MODE     | CHAR(1)      |          | Value of the EXPLAIN bind option.<br>A = ALL<br>N = No<br>R = REOPT<br>Y = Yes  |
| EXPLAIN_SNAPSHOT | CHAR(1)      |          | Value of the EXPLSNAP bind option.<br>A = ALL<br>N = No<br>R = REOPT<br>Y = Yes   |
| SQLWARN          | CHAR(1)      |          | Indicates whether or not positive SQLCODEs resulting from dynamic SQL statements are returned to the application.<br>N = No, they are suppressed<br>Y = Yes   |
| SQLMATHWARN      | CHAR(1)      |          | Value of the <i>dft_sqlmathwarn</i> database configuration parameter at bind time. Indicates whether arithmetic and retrieval conversion errors return warnings and null values (indicator -2), allowing query processing to continue whenever possible.<br>N = No, errors are returned<br>Y = Yes, warnings are returned |

Table 92. SYSCAT.PACKAGES Catalog View (continued)

| Column Name        | Data Type | Nullable | Description   |
|--------------------|-----------|----------|---|
| EXPLICIT_BIND_TIME | TIMESTAMP |          | Time at which this package was last explicitly bound or rebound. When the package is implicitly rebound, no function instance that was created later than this time will be selected.   |
| LAST_BIND_TIME     | TIMESTAMP |          | Time at which the package was last explicitly or implicitly bound or rebound. Used to check the validity of Explain data.   |
| CODEPAGE           | SMALLINT  |          | Application code page at bind time; -1 if not known.  |
| DEGREE             | CHAR(5)   |          | Degree of intra-partition parallelism that was specified when the package was bound.<br>1 = No parallelism<br>2-32767 = User-specified limit<br>ANY = Degree determined by the system (no limit specified)  |
| MULTINODE_PLANS    | CHAR(1)   |          | N = Package was not bound in a partitioned database environment<br>Y = Package was bound in a partitioned database environment  |
| INTRA_PARALLEL     | CHAR(1)   |          | Use of intra-partition parallelism by static SQL statements within the package.<br>F = One or more static SQL statements in this package can use intra-partition parallelism; this parallelism has been disabled for use on a system that is not configured for intra-partition parallelism<br>N = No static SQL statement uses intra-partition parallelism<br>Y = One or more static SQL statements in the package use intra-partition parallelism |
| VALIDATE           | CHAR(1)   |          | Indicates whether validity checking can be deferred until run time.<br>B = All checking must be performed at bind time<br>R = Validation of tables, views, and privileges that do not exist at bind time is performed at run time   |

## SYSCAT.PACKAGES

Table 92. SYSCAT.PACKAGES Catalog View (continued)

| Column Name  | Data Type     | Nullable | Description   |
|--------------|---------------|----------|---|
| DYNAMICRULES | CHAR(1)       |          | <p>B = BIND; dynamic SQL statements are executed with DYNAMICRULES BIND behavior</p> <p>D = DEFINERBIND; when the package is run within a routine context, dynamic SQL statements in the package are executed with DEFINE behavior; when the package is not run within a routine context, dynamic SQL statements in the package are executed with BIND behavior</p> <p>E = DEFINERRUN; when the package is run within a routine context, dynamic SQL statements in the package are executed with DEFINE behavior; when the package is not run within a routine context, dynamic SQL statements in the package are executed with RUN behavior</p> <p>H = INVOKEBIND; when the package is run within a routine context, dynamic SQL statements in the package are executed with INVOKE behavior; when the package is not run within a routine context, dynamic SQL statements in the package are executed with BIND behavior</p> <p>I = INVOKERUN; when the package is run within a routine context, dynamic SQL statements in the package are executed with INVOKE behavior; when the package is not run within a routine context, dynamic SQL statements in the package are executed with RUN behavior</p> <p>R = RUN; dynamic SQL statements are executed with RUN behavior; this is the default</p> |
| SQLERROR     | CHAR(1)       |          | <p>SQLERROR option on the most recent subcommand that bound or rebound the package.</p> <p>C = CONTINUE; creates a package, even if errors occur while binding SQL statements</p> <p>N = NOPACKAGE; does not create a package or a bind file if an error occurs</p>   |
| REFRESHAGE   | DECIMAL(20,6) |          | Timestamp duration indicating the maximum length of time between execution of a REFRESH TABLE statement for a materialized query table (MQT) and when that MQT is used in place of a base table.  |
| FEDERATED    | CHAR(1)       |          | <p>N = FEDERATED bind or prep option is turned off</p> <p>Y = FEDERATED bind or prep option is turned on</p>  |

Table 92. SYSCAT.PACKAGES Catalog View (continued)

| Column Name          | Data Type     | Nullable | Description  |
|----------------------|---------------|----------|--|
| TRANSFORMGROUP       | VARCHAR(1024) | Y        | Value of the TRANSFORM GROUP bind option; null if a transform group is not specified.  |
| REOPTVAR             | CHAR(1)       |          | Indicates whether the access path is determined again at execution time using input variable values.<br>A = Access path is reoptimized for every OPEN or EXECUTE request<br>N = Access path is determined at bind time<br>O = Access path is reoptimized only at the first OPEN or EXECUTE request; it is subsequently cached  |
| OS_PTR_SIZE          | INTEGER       |          | Word size for the platform on which the package was created.<br>32 = Package is a 32-bit package<br>64 = Package is a 64-bit package   |
| PKGVERSION           | VARCHAR(64)   |          | Version identifier for the package.  |
| PKG_CREATE_TIME      | TIMESTAMP     |          | Time at which the package was first bound.   |
| STATICREADONLY       | CHAR(1)       |          | Indicates whether or not static cursors will be treated as READ ONLY. Possible values are:<br>N = Static cursors take on the attributes that would normally be generated for the given statement text and the setting of the LANGLEVEL precompile option<br>Y = Any static cursor that does not contain the FOR UPDATE or the FOR READ ONLY clause is considered READ ONLY |
| FEDERATED_ASYNCHRONY | INTEGER       |          | Indicates the limit on asynchrony (the number of ATQs in the plan) as a bind option when the package was bound.<br>0 = No asynchrony<br>1 = User-specified limit ( <i>maxagents/4</i> )<br>-1 = Degree of asynchrony determined by the system<br>-2 = Degree of asynchrony not specified<br>For a non-federated system, the value is 0.                                    |
| DEFINER <sup>2</sup> | VARCHAR(128)  |          | Authorization ID under which the package was bound.  |
| REMARKS              | VARCHAR(254)  | Y        | User-provided comments, or null.   |

**Notes:**

1. If a function instance with dependencies is dropped, the package is put into an "inoperative" state, and it must be explicitly rebound. If any other object with dependencies is dropped, the package is put into an "invalid" state, and the system will attempt to rebound the package automatically when it is first referenced.
2. The DEFINER column is included for backwards compatibility. See OWNER.

---

**SYSCAT.PARTITIONMAPS**

Each row represents a distribution map that is used to distribute the rows of a table among the database partitions in a database partition group, based on hashing the table's distribution key.

*Table 93. SYSCAT.PARTITIONMAPS Catalog View*

| Column Name  | Data Type                    | Nullable | Description  |
|--------------|------------------------------|----------|--|
| PMAP_ID      | SMALLINT                     |          | Identifier for the distribution map.   |
| PARTITIONMAP | LONG VARCHAR<br>FOR BIT DATA |          | Distribution map, a vector of 4096 two-byte integers for a multiple partition database partition group. For a single partition database partition group, there is one entry denoting the partition number of the single partition. |

---

**SYSCAT.PASSTHRUAUTH**

Each row represents a user or group that has been granted pass-through authorization to query a data source.

*Table 94. SYSCAT.PASSTHRUAUTH Catalog View*

| Column Name | Data Type    | Nullable | Description  |
|-------------|--------------|----------|--|
| GRANTOR     | VARCHAR(128) |          | Grantor of the privilege.  |
| GRANTEE     | VARCHAR(128) |          | Holder of the privilege.   |
| GRANTEETYPE | CHAR(1)      |          | G = Grantee is a group<br>U = Grantee is an individual user      |
| SERVERNAME  | VARCHAR(128) |          | Name of the data source to which authorization is being granted. |

---

**SYSCAT.PREDICATESPECS**

Each row represents a predicate specification.

*Table 95. SYSCAT.PREDICATESPECS Catalog View*

| Column Name  | Data Type    | Nullable | Description   |
|--------------|--------------|----------|---|
| FUNCSHEMA    | VARCHAR(128) |          | Schema name of the function.  |
| FUNCNAME     | VARCHAR(128) |          | Unqualified name of the function.   |
| SPECIFICNAME | VARCHAR(128) |          | Name of the function instance.  |
| FUNCID       | INTEGER      |          | Identifier for the function.  |
| SPECID       | SMALLINT     |          | Number of this predicate specification.   |
| CONTEXTOP    | CHAR(8)      |          | Comparison operator, one of the built-in relational operators (=, <, >, >=, and so on). |
| CONTEXTEXP   | CLOB(32K)    |          | Constant, or an SQL expression.   |
| FILTERTEXT   | CLOB(64K)    | Y        | Text of the data filter expression.   |



---

**SYSCAT.REFERENCES**

Each row represents a referential integrity (foreign key) constraint.

Table 96. SYSCAT.REFERENCES Catalog View

| Column Name          | Data Type    | Nullable | Description   |
|----------------------|--------------|----------|---|
| CONSTNAME            | VARCHAR(128) |          | Name of the constraint.   |
| TABSCHEMA            | VARCHAR(128) |          | Schema name of the dependent table.   |
| TABNAME              | VARCHAR(128) |          | Unqualified name of the dependent table.  |
| OWNER                | VARCHAR(128) |          | Authorization ID under which the constraint was created.  |
| REFKEYNAME           | VARCHAR(128) |          | Name of the parent key.   |
| REFTABSCHEMA         | VARCHAR(128) |          | Schema name of the parent table.  |
| REFTABNAME           | VARCHAR(128) |          | Unqualified name of the parent table.   |
| COLCOUNT             | SMALLINT     |          | Number of columns in the foreign key.   |
| DELETERULE           | CHAR(1)      |          | Delete rule.<br>A = NO ACTION<br>C = CASCADE<br>N = SET NULL<br>R = RESTRICT                                      |
| UPDATERULE           | CHAR(1)      |          | Update rule.<br>A = NO ACTION<br>R = RESTRICT   |
| CREATE_TIME          | TIMESTAMP    |          | Time at which the constraint was defined.   |
| FK_COLNAMES          | VARCHAR(640) |          | This column is no longer used and will be removed in a future release. Use SYSCAT.KEYCOLUSE for this information. |
| PK_COLNAMES          | VARCHAR(640) |          | This column is no longer used and will be removed in a future release. Use SYSCAT.KEYCOLUSE for this information. |
| DEFINER <sup>1</sup> | VARCHAR(128) |          | Authorization ID under which the constraint was created.  |

**Notes:**

1. The DEFINER column is included for backwards compatibility. See OWNER.

**Related reference:**

- "SYSCAT.KEYCOLUSE " on page 644

---

**SYSCAT.ROUTINEAUTH**

Each row represents a user or group that has been granted EXECUTE privilege on a particular routine (function, method, or procedure), or on all routines in a particular schema in the database.

Table 97. SYSCAT.ROUTINEAUTH Catalog View

| Column Name  | Data Type    | Nullable | Description  |
|--------------|--------------|----------|--|
| GRANTOR      | VARCHAR(128) |          | Grantor of the privilege. 'SYSIBM' if the privilege was granted by the system.   |
| GRANTEE      | VARCHAR(128) |          | Holder of the privilege.   |
| GRANTEETYPE  | CHAR(1)      |          | G = Grantee is a group<br>U = Grantee is an individual user  |
| SCHEMA       | VARCHAR(128) |          | Schema name of the routine.  |
| SPECIFICNAME | VARCHAR(128) | Y        | Specific name of the routine. If SPECIFICNAME is null and ROUTINETYPE is not 'M', the privilege applies to all routines of the type specified in ROUTINETYPE in the schema specified in SCHEMA. If SPECIFICNAME is null and ROUTINETYPE is 'M', the privilege applies to all methods for the subject type specified by TYPENAME in the schema specified by TYPESHEMA. If SPECIFICNAME is null, ROUTINETYPE is 'M', and both TYPENAME and TYPESHEMA are null, the privilege applies to all methods for all types in the schema. |
| TYPESHEMA    | VARCHAR(128) | Y        | Schema name of the type for the method. Null if ROUTINETYPE is not 'M'.  |
| TYPENAME     | VARCHAR(128) | Y        | Unqualified name of the type for the method. Null if ROUTINETYPE is not 'M'. If TYPENAME is null and ROUTINETYPE is 'M', the privilege applies to all methods for any subject type if they are in the schema specified by SCHEMA.  |
| ROUTINETYPE  | CHAR(1)      |          | Type of the routine.<br>F = Function<br>M = Method<br>P = Procedure  |
| EXECUTEAUTH  | CHAR(1)      |          | Privilege to execute the routine.<br>G = Held and grantable<br>N = Not held<br>Y = Held  |
| GRANT_TIME   | TIMESTAMP    |          | Time at which the privilege was granted.   |

## SYSCAT.ROUTINEDEP

Each row represents a dependency of a routine on some other object. The routine depends on the object of type BTYPE of name BNAME, so a change to the object affects the routine.

Table 98. SYSCAT.ROUTINEDEP Catalog View

| Column Name  | Data Type    | Nullable | Description  |
|--------------|--------------|----------|--|
| ROUTINESHEMA | VARCHAR(128) |          | Schema name of the routine that has dependencies on another object.  |
| ROUTINENAME  | VARCHAR(128) |          | Unqualified name of the routine that has dependencies on another object.   |
| SPECIFICNAME | VARCHAR(128) |          | Specific name of the routine that has dependencies on another object.  |
| BTYPE        | CHAR(1)      |          | Type of object on which there is a dependency. Possible values are:<br>A = Alias<br>B = Trigger<br>F = Routine instance<br>H = Hierachy table<br>K = Package<br>L = Detached table<br>O = Privilege dependency on all subtables or subviews in a table or view hierarchy<br>Q = Sequence<br>R = Structured type<br>S = Materialized query table<br>T = Table (not typed)<br>U = Typed table<br>V = View (not typed)<br>W = Typed view<br>X = Index extension<br>Z = XSR object |
| BSCHEMA      | VARCHAR(128) |          | Schema name of the object on which there is a dependency.  |
| BNAME        | VARCHAR(128) |          | Unqualified name of the object on which there is a dependency. For routines (BTYPE = 'F'), this is the specific name.  |
| TABAUTH      | SMALLINT     | Y        | If BTYPE = 'O', 'S', 'T', 'U', 'V' or 'W', encodes the privileges on the table or view that are required by the dependent routine; null value otherwise.   |

## SYSCAT.ROUTINEOPTIONS

---

## SYSCAT.ROUTINEOPTIONS

Each row represents a routine-specific option value.

*Table 99. SYSCAT.ROUTINEOPTIONS Catalog View*

| Column Name  | Data Type     | Nullable | Description   |
|--------------|---------------|----------|---|
| ROUTINESHEMA | VARCHAR(128)  |          | Schema name of the routine.                               |
| ROUTINENAME  | VARCHAR(128)  |          | Unqualified name of the routine.                          |
| SPECIFICNAME | VARCHAR(128)  |          | Name of the routine instance (might be system-generated). |
| OPTION       | VARCHAR(128)  |          | Name of the federated routine option.                     |
| SETTING      | VARCHAR(2048) |          | Value of the federated routine option.                    |

---

**SYSCAT.ROUTINEPARMOPTIONS**

Each row represents a routine parameter-specific option value.

*Table 100. SYSCAT.ROUTINEPARMOPTIONS Catalog View*

| Column Name  | Data Type     | Nullable | Description   |
|--------------|---------------|----------|---|
| ROUTINESHEMA | VARCHAR(128)  |          | Schema name of the routine.                               |
| ROUTINENAME  | VARCHAR(128)  |          | Unqualified name of the routine.                          |
| SPECIFICNAME | VARCHAR(128)  |          | Name of the routine instance (might be system-generated). |
| ORDINAL      | SMALLINT      |          | Position of the parameter within the routine signature.   |
| OPTION       | VARCHAR(128)  |          | Name of the federated routine option.                     |
| SETTING      | VARCHAR(2048) |          | Value of the federated routine option.                    |

---

**SYSCAT.ROUTINEPARMS**

Each row represents a parameter or the result of a routine defined in SYSCAT.ROUTINES.

Table 101. SYSCAT.ROUTINEPARMS Catalog View

| Column Name         | Data Type    | Nullable | Description   |
|---------------------|--------------|----------|---|
| ROUTINESHEMA        | VARCHAR(128) |          | Schema name of the routine.   |
| ROUTINENAME         | VARCHAR(128) |          | Unqualified name of the routine.  |
| SPECIFICNAME        | VARCHAR(128) |          | Name of the routine instance (might be system-generated).   |
| PARAMNAME           | VARCHAR(128) | Y        | Name of the parameter or result column, or null if no name exists.  |
| ROWTYPE             | CHAR(1)      |          | B = Both input and output parameter<br>C = Result after casting<br>O = Output parameter<br>P = Input parameter<br>R = Result before casting   |
| ORDINAL             | SMALLINT     |          | If ROWTYPE = 'B', 'O', or 'P', numerical position of the parameter within the routine signature, starting with 1; if ROWTYPE = 'R' and the routine returns a table, numerical position of a named column in the result table, starting with 1; 0 otherwise. |
| TYPESHEMA           | VARCHAR(128) |          | Schema name of the data type. The schema name for built-in types is 'SYSIBM'.   |
| TYPENAME            | VARCHAR(128) |          | Unqualified name of the data type.  |
| LOCATOR             | CHAR(1)      |          | N = Parameter or result is not passed in the form of a locator<br>Y = Parameter or result is passed in the form of a locator  |
| LENGTH <sup>1</sup> | INTEGER      |          | Length of the parameter or result; 0 if the parameter or result is a distinct type.   |
| SCALE <sup>1</sup>  | SMALLINT     |          | Scale of the parameter or result; 0 if the parameter or result is a distinct type.  |
| CODEPAGE            | SMALLINT     |          | Code page of this parameter or result; 0 denotes either not applicable, or a parameter or result for character data declared with the FOR BIT DATA attribute.   |
| CAST_FUNCSCHEMA     | VARCHAR(128) |          | Schema name of the function used to cast an argument or a result. Applies to sourced and external functions; null value otherwise.  |
| CAST_FUNCSPECIFIC   | VARCHAR(128) |          | Unqualified name of the function used to cast an argument or a result. Applies to sourced and external functions; null value otherwise.   |
| TARGET_TYPESHEMA    | VARCHAR(128) |          | Schema name of the target type, if the type of the parameter or result is REFERENCE. Null value if the type of the parameter or result is not REFERENCE.  |

Table 101. SYSCAT.ROUTINEPARMS Catalog View (continued)

| Column Name      | Data Type    | Nullable | Description   |
|------------------|--------------|----------|---|
| TARGET_TYPENAME  | VARCHAR(128) |          | Unqualified name of the target type, if the type of the parameter or result is REFERENCE. Null value if the type of the parameter or result is not REFERENCE. |
| SCOPE_TABSCHEMA  | VARCHAR(128) | Y        | Schema name of the scope (target table), if the parameter type is REFERENCE; null value otherwise.  |
| SCOPE_TABNAME    | VARCHAR(128) | Y        | Unqualified name of the scope (target table), if the parameter type is REFERENCE; null value otherwise.   |
| TRANSFORMGRPNAME | VARCHAR(128) | Y        | Name of the transform group for a structured type parameter or result.  |
| REMARKS          | VARCHAR(254) | Y        | User-provided comments, or null.  |

**Notes:**

1. LENGTH and SCALE are set to 0 for sourced functions (functions defined with a reference to another function), because they inherit the length and scale of parameters from their source.

## SYSCAT.ROUTINES

### SYSCAT.ROUTINES

Each row represents a user-defined routine (scalar function, table function, sourced function, method, or procedure). Does not include built-in functions.

Table 102. SYSCAT.ROUTINES Catalog View

| Column Name       | Data Type    | Nullable | Description   |
|-------------------|--------------|----------|---|
| ROUTINESCHEMA     | VARCHAR(128) |          | Schema name of the routine.   |
| ROUTINENAME       | VARCHAR(128) |          | Unqualified name of the routine.  |
| ROUTINETYPE       | CHAR(1)      |          | Type of routine.<br>F = Function<br>M = Method<br>P = Procedure   |
| OWNER             | VARCHAR(128) |          | Authorization ID under which the routine was created.   |
| SPECIFICNAME      | VARCHAR(128) |          | Name of the routine instance (might be system-generated).   |
| ROUTINEID         | INTEGER      |          | Identifier for the routine.   |
| RETURN_TYPESCHEMA | VARCHAR(128) |          | Schema name of the return type for a scalar function or method.   |
| RETURN_TYPENAME   | VARCHAR(128) |          | Unqualified name of the return type for a scalar function or method.  |
| ORIGIN            | CHAR(1)      |          | B = Built-in<br>E = User-defined, external<br>M = Template function<br>F = Federated procedure<br>Q = SQL-bodied <sup>1</sup><br>S = System-generated<br>T = System-generated transform function (not directly invocable)<br>U = User-defined, based on a source  |
| FUNCTIONTYPE      | CHAR(1)      |          | C = Column or aggregate<br>R = Row<br>S = Scalar<br>T = Table<br>Blank = Procedure  |
| PARAM_COUNT       | SMALLINT     |          | Number of routine parameters.   |
| LANGUAGE          | CHAR(8)      |          | Implementation language for the routine body (or for the source function body, if this function is sourced on another function). Possible values are 'C', 'COBOL', 'JAVA', 'OLE', 'OLEDB', or 'SQL'. Blanks if ORIGIN is not 'E' or 'Q'.                          |
| SOURCESCHEMA      | VARCHAR(128) | Y        | If ORIGIN = 'U' and the source function is a user-defined function, contains the schema name of the specific name of the source function. If ORIGIN = 'U' and the source function is a built-in function, contains the value 'SYSIBM'. Null if ORIGIN is not 'U'. |



Table 102. SYSCAT.ROUTINES Catalog View (continued)

| Column Name       | Data Type    | Nullable | Description  |
|-------------------|--------------|----------|--|
| SOURCESPECIFIC    | VARCHAR(128) | Y        | If ORIGIN = 'U' and the source function is a user-defined function, contains the unqualified specific name of the source function. If ORIGIN = 'U' and the source function is a built-in function, contains the value 'N/A for built-in'. Null if ORIGIN is not 'U'. |
| DETERMINISTIC     | CHAR(1)      |          | N = Results are not deterministic (same parameters might give different results in different routine calls)<br>Y = Results are deterministic<br>Blank = ORIGIN is not 'E', 'F', or 'Q'   |
| EXTERNAL_ACTION   | CHAR(1)      |          | E = Function has external side-effects (therefore, the number of invocations is important)<br>N = No side-effects<br>Blank = ORIGIN is not 'E', 'F', or 'Q'  |
| NULLCALL          | CHAR(1)      |          | N = RETURNS NULL ON NULL INPUT (function result is implicitly the null value if one or more operands are null)<br>Y = CALLED ON NULL INPUT<br>Blank = ORIGIN is not 'E' or 'Q'   |
| CAST_FUNCTION     | CHAR(1)      |          | N = Not a cast function<br>Y = Cast function<br>Blank = ROUTINETYPE is not 'F'   |
| ASSIGN_FUNCTION   | CHAR(1)      |          | N = Not an assignment function<br>Y = Implicit assignment function<br>Blank = ROUTINETYPE is not 'F'   |
| SCRATCHPAD        | CHAR(1)      |          | N = Routine has no scratchpad<br>Y = Routine has a scratchpad<br>Blank = ORIGIN is not 'E' or ROUTINETYPE is 'P'   |
| SCRATCHPAD_LENGTH | SMALLINT     |          | Size (in bytes) of the scratchpad for the routine.<br>-1 = LANGUAGE is 'OLEDB' and SCRATCHPAD is 'Y'<br>0 = SCRATCHPAD is not 'Y'  |
| FINALCALL         | CHAR(1)      |          | N = No final call is made<br>Y = Final call is made to this routine at the runtime end-of-statement<br>Blank = ORIGIN is not 'E' or ROUTINETYPE is 'P'   |
| PARALLEL          | CHAR(1)      |          | N = Routine cannot be executed in parallel<br>Y = Routine can be executed in parallel<br>Blank = ORIGIN is not 'E'   |

## SYSCAT.ROUTINES

Table 102. SYSCAT.ROUTINES Catalog View (continued)

| Column Name      | Data Type | Nullable | Description   |
|------------------|-----------|----------|---|
| PARAMETER_STYLE  | CHAR(8)   |          | Parameter style that was declared when the routine was created. Possible values are:<br>DB2DARI<br>DB2GENRL<br>DB2SQL<br>GENERAL<br>GNRLNULL<br>JAVA<br>SQL<br>Blanks if ORIGIN is not 'E'  |
| FENCED           | CHAR(1)   |          | N = Not fenced<br>Y = Fenced<br>Blank = ORIGIN is not 'E'   |
| SQL_DATA_ACCESS  | CHAR(1)   |          | Indicates what type of SQL statements, if any, the database manager should assume is contained in the routine.<br>C = Contains SQL (simple expressions with no subqueries only)<br>M = Contains SQL statements that modify data<br>N = Does not contain SQL statements<br>R = Contains read-only SQL statements<br>Blank = ORIGIN is not 'E', 'F', or 'Q' |
| DBINFO           | CHAR(1)   |          | Indicates whether a DBINFO parameter is passed to an external routine.<br>N = DBINFO is not passed<br>Y = DBINFO is passed<br>Blank = ORIGIN is not 'E'   |
| PROGRAMTYPE      | CHAR(1)   |          | Indicates how the external routine is invoked.<br>M = Main<br>S = Subroutine<br>Blank = ORIGIN is 'F'   |
| COMMIT_ON_RETURN | CHAR(1)   |          | Indicates whether the transaction is committed on successful return from this procedure.<br>N = The unit of work is not committed<br>Y = The unit of work is committed<br>Blank = ROUTINETYPE is not 'P'  |
| RESULT_SETS      | SMALLINT  |          | Estimated maximum number of result sets.  |

Table 102. SYSCAT.ROUTINES Catalog View (continued)

| Column Name       | Data Type | Nullable | Description  |
|-------------------|-----------|----------|--|
| SPEC_REG          | CHAR(1)   |          | Indicates whether special registers are inherited from the caller or reinitialized to their default values when the routine is called.<br>D = Default special registers<br>I = Inherited special registers<br>Blank = PARAMETER_STYLE is 'DB2DARI' or ORIGIN is not 'E' or 'Q' |
| FEDERATED         | CHAR(1)   |          | Indicates whether or not federated objects can be accessed from the routine.<br>N = Federated objects cannot be accessed<br>Y = Federated objects can be accessed<br>Blank = ORIGIN is not 'E', 'F', or 'Q'  |
| THREADSAFE        | CHAR(1)   |          | Indicates whether or not the routine can run in the same process as other routines.<br>N = Routine is not threadsafe<br>Y = Routine is threadsafe<br>Blank = ORIGIN is not 'E'   |
| VALID             | CHAR(1)   |          | Applies to LANGUAGE = 'SQL' only; blank otherwise.<br>N = Routine needs rebinding<br>Y = Routine is valid<br>X = Routine is inoperative and must be recreated  |
| METHODIMPLEMENTED | CHAR(1)   |          | N = Method body is not implemented<br>Y = Method body is implemented<br>Blank = ROUTINETYPE is not 'M'   |
| METHODEFFECT      | CHAR(2)   |          | CN = Constructor method<br>MU = Mutator method<br>OB = Observer method<br>Blanks = Not a system method   |
| TYPE_PRESERVING   | CHAR(1)   |          | N = Return type is the declared return type of the method<br>Y = Return type is governed by a "type-preserving" parameter; all system-generated mutator methods are type-preserving<br>Blank = ROUTINETYPE is not 'M'  |
| WITH_FUNC_ACCESS  | CHAR(1)   |          | N = This method cannot be invoked by using functional notation<br>Y = This method can be invoked by using functional notation; that is, the "WITH FUNCTION ACCESS" attribute is specified<br>Blank = ROUTINETYPE is not 'M'  |

## SYSCAT.ROUTINES

Table 102. SYSCAT.ROUTINES Catalog View (continued)

| Column Name         | Data Type     | Nullable | Description  |
|---------------------|---------------|----------|--|
| OVERRIDDEN_METHODID | INTEGER       | Y        | Identifier for the overridden method when the OVERRIDING option is specified for a user-defined method. Null if ROUTINETYPE is not 'M'.  |
| SUBJECT_TYPESHEMA   | VARCHAR(128)  | Y        | Schema name of the subject type for the user-defined method. Null if ROUTINETYPE is not 'M'.   |
| SUBJECT_TYPENAME    | VARCHAR(128)  | Y        | Unqualified name of the subject type for the user-defined method. Null if ROUTINETYPE is not 'M'.  |
| CLASS               | VARCHAR(128)  | Y        | For LANGUAGE JAVA, CLR, or OLE, this is the class that implements this routine; null value otherwise.  |
| JAR_ID              | VARCHAR(128)  | Y        | For LANGUAGE JAVA, this is the JAR_ID of the installed jar file that implements this routine if a jar file was specified at routine creation time; null value otherwise. For LANGUAGE CLR, this is the assembly file that implements this routine. |
| JARSCHEMA           | VARCHAR(128)  | Y        | For LANGUAGE JAVA when a JAR_ID is present, this is the schema name of the jar file that implements this routine; null value otherwise.  |
| JAR_SIGNATURE       | VARCHAR(1024) | Y        | For LANGUAGE JAVA, this is the method signature of this routine's specified Java method. For LANGUAGE CLR, this is a reference field for this CLR routine. Null value otherwise.   |
| CREATE_TIME         | TIMESTAMP     |          | Time at which the routine was created.   |
| ALTER_TIME          | TIMESTAMP     |          | Time at which the routine was last altered.  |
| FUNC_PATH           | VARCHAR(254)  | Y        | SQL path at the time the routine was defined. Null if LANGUAGE is not 'SQL'.   |
| QUALIFIER           | VARCHAR(128)  |          | Value of the default schema at the time of object definition. Used to complete any unqualified references.   |
| IOS_PER_INVOC       | DOUBLE        |          | Estimated number of inputs/outputs (I/Os) per invocation; 0 is the default; -1 if not known.   |
| INSTS_PER_INVOC     | DOUBLE        |          | Estimated number of instructions per invocation; 450 is the default; -1 if not known.  |
| IOS_PER_ARGBYTE     | DOUBLE        |          | Estimated number of I/Os per input argument byte; 0 is the default; -1 if not known.   |
| INSTS_PER_ARGBYTE   | DOUBLE        |          | Estimated number of instructions per input argument byte; 0 is the default; -1 if not known.   |
| PERCENT_ARGBYTES    | SMALLINT      |          | Estimated average percent of input argument bytes that the routine will actually read; 100 is the default; -1 if not known.  |

Table 102. SYSCAT.ROUTINES Catalog View (continued)

| Column Name              | Data Type    | Nullable | Description   |
|--------------------------|--------------|----------|---|
| INITIAL_IOS              | DOUBLE       |          | Estimated number of I/Os performed the first time that the routine is invoked; 0 is the default; -1 if not known.   |
| INITIAL_INSTS            | DOUBLE       |          | Estimated number of instructions executed the first time the routine is invoked; 0 is the default; -1 if not known.   |
| CARDINALITY              | BIGINT       |          | Predicted cardinality of a table function; -1 if not known, or if the routine is not a table function.  |
| SELECTIVITY <sup>2</sup> | DOUBLE       |          | For user-defined predicates; -1 if there are no user-defined predicates.  |
| RESULT_COLS              | SMALLINT     |          | For a table function (ROUTINETYPE = 'F' and FUNCTIONTYPE = 'T'), contains the number of columns in the result table; for a procedure (ROUTINETYPE = 'P'), contains 0; contains 1 otherwise.   |
| IMPLEMENTATION           | VARCHAR(254) | Y        | If ORIGIN = 'E', identifies the path/module/function that implements this function. If ORIGIN = 'U' and the source function is built-in, this column contains the name and signature of the source function. Null value otherwise.  |
| LIB_ID                   | INTEGER      | Y        | Reserved for future use.  |
| TEXT_BODY_OFFSET         | INTEGER      |          | If LANGUAGE = 'SQL', the offset to the start of the SQL procedure body in the full text of the CREATE statement; -1 if LANGUAGE is not 'SQL'.   |
| TEXT                     | CLOB(2M)     | Y        | If LANGUAGE = 'SQL', the full text of the CREATE FUNCTION, CREATE METHOD, or CREATE PROCEDURE statement; null value otherwise.  |
| NEWSAVEPOINTLEVEL        | CHAR(1)      |          | Indicates whether the routine initiates a new savepoint level when it is invoked.<br>N = A new savepoint level is not initiated when the routine is invoked; the routine uses the existing savepoint level<br>Y = A new savepoint level is initiated when the routine is invoked<br>Blank = Not applicable  |
| DEBUG_MODE <sup>3</sup>  | VARCHAR(8)   |          | Indicates whether or not the routine can be debugged using the DB2 debugger.<br>DISALLOW = Routine is not debuggable<br>ALLOW = Routine is debuggable, and can participate in a client debug session with the DB2 debugger<br>DISABLE = Routine is not debuggable, and this setting cannot be altered without dropping and recreating the routine<br>Empty string = Routine type is not currently supported by the DB2 debugger |
| TRACE_LEVEL              | CHAR(1)      |          | Reserved for future use.  |

## SYSCAT.ROUTINES

Table 102. SYSCAT.ROUTINES Catalog View (continued)

| Column Name          | Data Type     | Nullable | Description   |
|----------------------|---------------|----------|---|
| DIAGNOSTIC_LEVEL     | CHAR(1)       |          | Reserved for future use.  |
| CHECKOUT_USERID      | VARCHAR(128)  | Y        | ID of the user who performed a checkout of the object; null if the object is not checked out.   |
| PRECOMPILE_OPTIONS   | VARCHAR(1024) | Y        | Precompile options specified for the routine.   |
| COMPILE_OPTIONS      | VARCHAR(1024) | Y        | Compile options specified for the routine.  |
| EXECUTION_CONTROL    | CHAR(1)       |          | Execution control mode of a common language runtime (CLR) routine. Possible values are:<br>N = Network<br>R = Fileread<br>S = Safe<br>U = Unsafe<br>W = Filewrite<br>Blank = LANGUAGE is not 'CLR'  |
| CODEPAGE             | SMALLINT      |          | Routine code page, which specifies the default code page used for all character parameter types, result types, and local variables within the routine body.   |
| ENCODING_SCHEME      | CHAR(1)       |          | Encoding scheme of the routine, as specified in the PARAMETER CCSID clause. Possible values are:<br>A = ASCII<br>U = UNICODE<br>Blank = PARAMETER CCSID clause was not specified  |
| LAST_REGEN_TIME      | TIMESTAMP     |          | Time at which the SQL routine packed descriptor was last regenerated.   |
| INHERITLOCKREQUEST   | CHAR(1)       |          | N = This function or method cannot be invoked in the context of an SQL statement that includes a lock-request-clause as part of a specified isolation-clause<br>Y = This function or method inherits the isolation level of the invoking statement; it also inherits the specified lock-request-clause<br>Blank = LANGUAGE is not 'SQL' or ROUTINETYPE is 'P' |
| DEFINER <sup>4</sup> | VARCHAR(128)  |          | Authorization ID under which the routine was created.   |
| REMARKS              | VARCHAR(254)  | Y        | User-provided comments, or null.  |

Table 102. SYSCAT.ROUTINES Catalog View (continued)

| Column Name | Data Type | Nullable | Description |
|-------------|-----------|----------|-------------|
|-------------|-----------|----------|-------------|

---

**Notes:**

1. For SQL procedures created before Version 8.2 and migrated to Version 9, 'E' (instead of 'Q').
2. During migration, the SELECTIVITY column will be set to -1 in the packed descriptor and system catalogs for all user-defined routines. For a user-defined predicate, the selectivity in the system catalog will be -1. In this case, the selectivity value used by the optimizer is 0.01.
3. For Java routines, the DEBUG\_MODE setting does not indicate whether the Java routine was actually compiled in debug mode, or whether a debug Jar was installed at the server.
4. The DEFINER column is included for backwards compatibility. See OWNER.

## SYSCAT.ROUTINESFEDERATED

### SYSCAT.ROUTINESFEDERATED

Each row represents a user-defined routine (scalar function, table function, sourced function, method, or procedure). Does not include built-in functions.

Table 103. SYSCAT.ROUTINESFEDERATED Catalog View

| Column Name      | Data Type    | Nullable | Description   |
|------------------|--------------|----------|---|
| ROUTINESHEMA     | VARCHAR(128) |          | Schema name of the routine.   |
| ROUTINENAME      | VARCHAR(128) |          | Unqualified name of the routine.  |
| ROUTINETYPE      | CHAR(1)      |          | Type of routine.<br>P = Procedure   |
| OWNER            | VARCHAR(128) |          | Authorization ID under which the routine was created.   |
| SPECIFICNAME     | VARCHAR(128) |          | Name of the routine instance (might be system-generated).   |
| ROUTINEID        | INTEGER      |          | Identifier for the routine.   |
| PARAM_COUNT      | SMALLINT     |          | Number of routine parameters.   |
| DETERMINISTIC    | CHAR(1)      |          | N = Results are not deterministic (same parameters might give different results in different routine calls)<br>Y = Results are deterministic  |
| EXTERNAL_ACTION  | CHAR(1)      |          | E = Routine has external side-effects (therefore, the number of invocations is important)<br>N = No side-effects  |
| SQL_DATA_ACCESS  | CHAR(1)      |          | Indicates what type of SQL statements, if any, the database manager should assume is contained in the routine.<br>C = Contains SQL (simple expressions with no subqueries only)<br>M = Contains SQL statements that modify data<br>N = Does not contain SQL statements<br>R = Contains read-only SQL statements |
| COMMIT_ON_RETURN | CHAR(1)      |          | Indicates whether the transaction is committed on successful return from this procedure.<br>N = The unit of work is not committed<br>Y = The unit of work is committed<br>Blank = ROUTINETYPE is not 'P'  |
| RESULT_SETS      | SMALLINT     |          | Estimated maximum number of result sets.  |
| CREATE_TIME      | TIMESTAMP    |          | Time at which the routine was created.  |
| ALTER_TIME       | TIMESTAMP    |          | Time at which the routine was last altered.   |
| QUALIFIER        | VARCHAR(128) |          | Value of the default schema at the time of object definition. Used to complete any unqualified references.  |
| RESULT_COLS      | SMALLINT     |          | For a procedure (ROUTINETYPE = 'P'), contains 0; contains 1 otherwise.  |



Table 103. SYSCAT.ROUTINESFEDERATED Catalog View (continued)

| Column Name                  | Data Type    | Nullable | Description   |
|------------------------------|--------------|----------|---|
| CODEPAGE                     | SMALLINT     |          | Routine code page, which specifies the default code page used for all character parameter types, result types, and local variables within the routine body. |
| LAST_REGEN_TIME              | TIMESTAMP    |          | Time at which the SQL routine packed descriptor was last regenerated.   |
| REMOTE_PROCEDURE             | VARCHAR(128) |          | Unqualified name of the source procedure for which the federated routine was created.   |
| REMOTE_SCHEMA                | VARCHAR(128) |          | Schema name of the source procedure for which the federated routine was created.  |
| SERVERNAME                   | VARCHAR(128) |          | Name of the data source that contains the source procedure for which the federated routine was created.   |
| REMOTE_PACKAGE               | VARCHAR(128) |          | Name of the package to which the source procedure belongs (applies only to wrappers for Oracle data sources).   |
| REMOTE_PROCEDURE_ ALTER_TIME | VARCHAR(128) |          | Reserved for future use.  |
| REMARKS                      | VARCHAR(254) | Y        | User-provided comments, or null.  |

**SYSCAT.SCHEMAAUTH**

Each row represents a user or group that has been granted one or more privileges on a schema.

Table 104. SYSCAT.SCHEMAAUTH Catalog View

| Column Name  | Data Type    | Nullable | Description   |
|--------------|--------------|----------|---|
| GRANTOR      | VARCHAR(128) |          | Grantor of a privilege.   |
| GRANTEE      | VARCHAR(128) |          | Holder of a privilege.  |
| GRANTEETYPE  | CHAR(1)      |          | G = Grantee is a group<br>U = Grantee is an individual user   |
| SCHEMANAME   | VARCHAR(128) |          | Name of the schema to which this privilege applies.   |
| ALTERINAUTH  | CHAR(1)      |          | Privilege to alter or comment on objects in the named schema.<br>G = Held and grantable<br>N = Not held<br>Y = Held |
| CREATEINAUTH | CHAR(1)      |          | Privilege to create objects in the named schema.<br>G = Held and grantable<br>N = Not held<br>Y = Held              |
| DROPINAUTH   | CHAR(1)      |          | Privilege to drop objects from the named schema.<br>G = Held and grantable<br>N = Not held<br>Y = Held              |

---

**SYSCAT.SCHEMATA**

Each row represents a schema.

*Table 105. SYSCAT.SCHEMATA Catalog View*

| Column Name | Data Type    | Nullable | Description   |
|-------------|--------------|----------|---|
| SCHEMANAME  | VARCHAR(128) |          | Name of the schema.   |
| OWNER       | VARCHAR(128) |          | Authorization ID of the schema, who has the authority to drop the schema and all objects within it. The value for implicitly created schemas is 'SYSIBM'. |
| DEFINER     | VARCHAR(128) |          | Authorization ID under which the schema was created.  |
| CREATE_TIME | TIMESTAMP    |          | Time at which the schema was created.   |
| REMARKS     | VARCHAR(254) | Y        | User-provided comments, or null.  |

---

**SYSCAT.SECURITYLABELACCESS**

Each row represents a security label that was granted to the database authorization ID.

*Table 106. SYSCAT.SECURITYLABELACCESS Catalog View*

| Column Name | Data Type    | Nullable | Description  |
|-------------|--------------|----------|--|
| GRANTOR     | VARCHAR(128) |          | Grantor of the security label.   |
| GRANTEE     | VARCHAR(128) |          | Holder of the security label.  |
| GRANTEETYPE | CHAR(1)      |          | U = Grantee is an individual user  |
| SECLABELID  | INTEGER      |          | Identifier for the security label.   |
| SECPOLICYID | INTEGER      |          | Identifier for the security policy that is associated with the security label. |
| ACCESSTYPE  | CHAR(1)      |          | B = Both read and write access<br>R = Read access<br>W = Write access          |
| GRANT_TIME  | TIMESTAMP    |          | Time at which the security label was granted.                                  |

---

**SYSCAT.SECURITYLABELCOMPONENTELEMENTS**

Each row represents an element value for a security label component.

*Table 107. SYSCAT.SECURITYLABELCOMPONENTELEMENTS Catalog View*

| Column Name          | Data Type            | Nullable | Description   |
|----------------------|----------------------|----------|---|
| COMPID               | INTEGER              |          | Identifier for the security label component.  |
| ELEMENTVALUE         | VARCHAR(32)          |          | Element value for the security label component.   |
| ELEMENTVALUEENCODING | CHAR(8) FOR BIT DATA |          | Encoded form of the element value.  |
| PARENTELEMENTVALUE   | VARCHAR(32)          | Y        | Name of the parent of an element for tree components; null for set and array components, and for the ROOT node of a tree component. |

---

**SYSCAT.SECURITYLABELCOMPONENTS**

Each row represents a security label component.

*Table 108. SYSCAT.SECURITYLABELCOMPONENTS Catalog View*

| Column Name | Data Type    | Nullable | Description  |
|-------------|--------------|----------|--|
| COMPNAME    | VARCHAR(128) |          | Name of the security label component.                              |
| COMPID      | INTEGER      |          | Identifier for the security label component.                       |
| COMPTYPE    | CHAR(1)      |          | Security label component type.<br>A = Array<br>S = Set<br>T = Tree |
| NUMELEMENTS | INTEGER      |          | Number of elements in the security label component.                |
| CREATE_TIME | TIMESTAMP    |          | Time at which the security label component was created.            |
| REMARKS     | VARCHAR(254) |          | User-provided comments, or null.                                   |

---

**SYSCAT.SECURITYLABELS**

Each row represents a security label.

*Table 109. SYSCAT.SECURITYLABELS Catalog View*

| Column Name  | Data Type                | Nullable | Description   |
|--------------|--------------------------|----------|---|
| SECLABELNAME | VARCHAR(128)             |          | Name of the security label.   |
| SECLABELID   | INTEGER                  |          | Identifier for the security label.                                      |
| SECPOLICYID  | INTEGER                  |          | Identifier for the security policy to which the security label belongs. |
| SECLABEL     | SYSPROC.DB2SECURITYLABEL |          | Internal representation of the security label.                          |
| CREATE_TIME  | TIMESTAMP                |          | Time at which the security label was created.                           |
| REMARKS      | VARCHAR(254)             |          | User-provided comments, or null.  |

---

**SYSCAT.SECURITYPOLICIES**

Each row represents a security policy.

Table 110. SYSCAT.SECURITYPOLICIES Catalog View

| Column Name          | Data Type    | Nullable | Description   |
|----------------------|--------------|----------|---|
| SECPOLICYNAME        | VARCHAR(128) |          | Name of the security policy.  |
| SECPOLICYID          | INTEGER      |          | Identifier for the security policy.   |
| NUMSECLABELCOMP      | INTEGER      |          | Number of security label components in the security policy.   |
| RWSECLABELREL        | CHAR(1)      |          | Relationship between the security labels for read and write access granted to the same authorization ID.<br>S = The security label for write access granted to a user is a subset of the security label for read access granted to that same user |
| NOTAUTHWRITESECLABEL | CHAR(1)      |          | Action to take when a user is not authorized to write the security label that is specified in the INSERT or UPDATE statement.<br>O = Override<br>R = Restrict   |
| CREATE_TIME          | TIMESTAMP    |          | Time at which the security policy was created.  |
| REMARKS              | VARCHAR(254) |          | User-provided comments, or null.  |



**SYSCAT.SECURITYPOLICYCOMPONENTRULES**

Each row represents the read and write access rules for a security label component of the security policy.

Table 111. SYSCAT.SECURITYPOLICYCOMPONENTRULES Catalog View

| Column Name         | Data Type    | Nullable | Description   |
|---------------------|--------------|----------|---|
| SECPOLICYID         | INTEGER      |          | Identifier for the security policy.   |
| COMPID              | INTEGER      |          | Identifier for the security label component of the security policy.                             |
| ORDINAL             | INTEGER      |          | Position of the security label component as it appears in the security policy, starting with 1. |
| READACCESSRULENAME  | VARCHAR(128) |          | Name of the read access rule that is associated with the security label component.              |
| READACCESSRULETEXT  | VARCHAR(512) |          | Text of the read access rule that is associated with the security label component.              |
| WRITEACCESSRULENAME | VARCHAR(128) |          | Name of the write access rule that is associated with the security label component.             |
| WRITEACCESSRULETEXT | VARCHAR(512) |          | Text of the write access rule that is associated with the security label component.             |

---

**SYSCAT.SECURITYPOLICYEXEMPTIONS**

Each row represents a security policy exemption that was granted to a database authorization ID.

*Table 112. SYSCAT.SECURITYPOLICYEXEMPTIONS Catalog View*

| Column Name    | Data Type    | Nullable | Description  |
|----------------|--------------|----------|--|
| GRANTOR        | VARCHAR(128) |          | Grantor of the exemption.  |
| GRANTEE        | VARCHAR(128) |          | Holder of the exemption.   |
| GRANTEETYPE    | CHAR(1)      |          | U = Grantee is an individual user  |
| SECPOLICYID    | INTEGER      |          | Identifier for the security policy for which the exemption was granted.  |
| ACCESSRULENAME | VARCHAR(128) |          | Name of the access rule for which the exemption was granted.   |
| ACCESSTYPE     | CHAR(1)      |          | Type of access to which the rule applies.<br>R = Read access<br>W = Write access   |
| ORDINAL        | INTEGER      |          | Position of the security label component in the security policy to which the rule applies.                                   |
| ACTIONALLOWED  | CHAR(1)      |          | If the rule is DB2LBACWRITEARRAY, then:<br>B = Write down and write up<br>D = Write down<br>U = Write up<br>Blank otherwise. |
| GRANT_TIME     | TIMESTAMP    |          | Time at which the exemption was granted.   |

---

**SYSCAT.SURROGATEAUTHIDS**

Each row represents an authorization ID for which another authorization ID can act as a surrogate.

*Table 113. SYSCAT.SURROGATEAUTHIDS Catalog View*

| Column Name         | Data Type    | Nullable | Description   |
|---------------------|--------------|----------|---|
| GRANTOR             | VARCHAR(128) |          | Authorization ID that granted TRUSTEDID the ability to act as a surrogate.  |
| TRUSTEDID           | VARCHAR(128) |          | Identifier for the entity that is trusted to act as a surrogate.  |
| TRUSTEDIDTYPE       | CHAR(1)      |          | G = Group<br>U = User   |
| SURROGATEAUTHID     | VARCHAR(128) |          | Surrogate authorization ID that can be assumed by TRUSTEDID. 'PUBLIC' indicates that TRUSTEDID can assume any authorization ID. |
| SURROGATEAUTHIDTYPE | CHAR(1)      |          | G = Group<br>U = User   |
| GRANT_TIME          | TIMESTAMP    |          | Time at which the grant was made.   |

## SYSCAT.SEQUENCEAUTH

---

## SYSCAT.SEQUENCEAUTH

Each row represents a user or group that has been granted one or more privileges on a sequence.

Table 114. SYSCAT.SEQUENCEAUTH Catalog View

| Column Name | Data Type    | Nullable | Description  |
|-------------|--------------|----------|--|
| GRANTOR     | VARCHAR(128) |          | Grantor of a privilege.  |
| GRANTEE     | VARCHAR(128) |          | Holder of a privilege.   |
| GRANTEETYPE | CHAR(1)      |          | G = Grantee is a group<br>U = Grantee is an individual user                                |
| SEQSCHEMA   | VARCHAR(128) |          | Schema name of the sequence.   |
| SEQNAME     | VARCHAR(128) |          | Unqualified name of the sequence.  |
| ALTERAUTH   | CHAR(1)      |          | Privilege to alter the sequence.<br>G = Held and grantable<br>N = Not held<br>Y = Held     |
| USAGEAUTH   | CHAR(1)      |          | Privilege to reference the sequence.<br>G = Held and grantable<br>N = Not held<br>Y = Held |

---

**SYSCAT.SEQUENCES**

Each row represents a sequence.

Table 115. SYSCAT.SEQUENCES Catalog View

| Column Name          | Data Type     | Nullable | Description   |
|----------------------|---------------|----------|---|
| SEQSHEMA             | VARCHAR(128)  |          | Schema name of the sequence.  |
| SEQNAME              | VARCHAR(128)  |          | Unqualified name of the sequence.   |
| DEFINER <sup>1</sup> | VARCHAR(128)  |          | Authorization ID under which the sequence was created.  |
| OWNER                | VARCHAR(128)  |          | Authorization ID under which the sequence was created.  |
| SEQID                | INTEGER       |          | Identifier for the sequence.  |
| SEQTYPE              | CHAR(1)       |          | Type of sequence.<br>I = Identity sequence<br>S = Regular sequence  |
| INCREMENT            | DECIMAL(31,0) |          | Increment value.  |
| START                | DECIMAL(31,0) |          | Start value of the sequence.  |
| MAXVALUE             | DECIMAL(31,0) |          | Maximum value of the sequence.  |
| MINVALUE             | DECIMAL(31,0) |          | Minimum value of the sequence.  |
| NEXTCACHEFIRSTVALUE  | DECIMAL(31,0) | Y        | The first value available to be assigned in the next cache block. If no caching, the next value available to be assigned.   |
| CYCLE                | CHAR(1)       |          | Indicates whether or not the sequence can continue to generate values after reaching its maximum or minimum value.<br>N = Sequence cannot cycle<br>Y = Sequence can cycle   |
| CACHE                | INTEGER       |          | Number of sequence values to pre-allocate in memory for faster access. 0 indicates that values of the sequence are not to be preallocated. In a partitioned database, this value applies to each database partition.            |
| ORDER                | CHAR(1)       |          | Indicates whether or not the sequence numbers must be generated in order of request.<br>N = Sequence numbers are not required to be generated in order of request<br>Y = Sequence numbers must be generated in order of request |
| DATATYPEID           | INTEGER       |          | For built-in types, the internal identifier of the built-in type. For distinct types, the internal identifier of the distinct type.   |
| SOURCETYPEID         | INTEGER       |          | For a built-in type, this has a value of 0. For a distinct type, this is the internal identifier of the built-in type that is the source type for the distinct type.  |
| CREATE_TIME          | TIMESTAMP     |          | Time at which the sequence was created.   |
| ALTER_TIME           | TIMESTAMP     |          | Time at which the sequence was last altered.  |

## SYSCAT.SEQUENCES

Table 115. SYSCAT.SEQUENCES Catalog View (continued)

| Column Name | Data Type    | Nullable | Description  |
|-------------|--------------|----------|--|
| PRECISION   | SMALLINT     |          | Precision of the data type of the sequence.<br>Possible values are:<br>5 = SMALLINT<br>10 = INTEGER<br>19 = BIGINT<br><br>For DECIMAL, it is the precision of the specified DECIMAL data type. |
| ORIGIN      | CHAR(1)      |          | Origin of the sequence.<br>S = System-generated sequence<br>U = User-generated sequence  |
| REMARKS     | VARCHAR(254) |          | User-provided comments, or null.   |

**Notes:**

1. The DEFINER column is included for backwards compatibility. See OWNER.

---

## SYSCAT.SERVEROPTIONS

Each row represents a server-specific option value.

*Table 116. SYSCAT.SERVEROPTIONS Catalog View*

| Column Name     | Data Type     | Nullable | Description                          |
|-----------------|---------------|----------|--------------------------------------|
| WRAPNAME        | VARCHAR(128)  | Y        | Name of the wrapper.                 |
| SERVERNAME      | VARCHAR(128)  | Y        | Uppercase name of the server.        |
| SERVERTYPE      | VARCHAR(30)   | Y        | Type of server.                      |
| SERVERVERSION   | VARCHAR(18)   | Y        | Server version.                      |
| CREATE_TIME     | TIMESTAMP     |          | Time at which the entry was created. |
| OPTION          | VARCHAR(128)  |          | Name of the server option.           |
| SETTING         | VARCHAR(2048) |          | Value of the server option.          |
| SERVEROPTIONKEY | VARCHAR(18)   |          | Uniquely identifies a row.           |
| REMARKS         | VARCHAR(254)  | Y        | User-provided comments, or null.     |

## SYSCAT.SERVERS

---

## SYSCAT.SERVERS

Each row represents a data source.

*Table 117. SYSCAT.SERVERS Catalog View*

| <b>Column Name</b> | <b>Data Type</b> | <b>Nullable</b> | <b>Description</b>               |
|--------------------|------------------|-----------------|----------------------------------|
| WRAPNAME           | VARCHAR(128)     |                 | Name of the wrapper.             |
| SERVERNAME         | VARCHAR(128)     |                 | Uppercase name of the server.    |
| SERVERTYPE         | VARCHAR(30)      | Y               | Type of server.                  |
| SERVERVERSION      | VARCHAR(18)      | Y               | Server version.                  |
| REMARKS            | VARCHAR(254)     | Y               | User-provided comments, or null. |



---

**SYSCAT.STATEMENTS**

Each row represents an SQL statement in a package.

*Table 118. SYSCAT.STATEMENTS Catalog View*

| Column Name | Data Type               | Nullable | Description  |
|-------------|-------------------------|----------|--|
| PKGSHEMA    | VARCHAR(128)            |          | Schema name of the package.  |
| PKGNAME     | VARCHAR(128)            |          | Unqualified name of the package.   |
| UNIQUE_ID   | CHAR(8) FOR BIT<br>DATA |          | Identifier for a specific package when multiple packages having the same name exist. |
| VERSION     | VARCHAR(64)             |          | Version identifier for the package.  |
| STMTNO      | INTEGER                 |          | Line number of the SQL statement in the source module of the application program.    |
| SECTNO      | SMALLINT                |          | Number of the package section containing the SQL statement.                          |
| SEQNO       | SMALLINT                |          | Always 1.  |
| TEXT        | CLOB(2M)                |          | Text of the SQL statement.   |

---

**SYSCAT.TABAUTH**

Each row represents a user or group that has been granted one or more privileges on a table or view.

Table 119. SYSCAT.TABAUTH Catalog View

| Column Name | Data Type    | Nullable | Description   |
|-------------|--------------|----------|---|
| GRANTOR     | VARCHAR(128) |          | Grantor of the privilege.   |
| GRANTEE     | VARCHAR(128) |          | Holder of the privilege.  |
| GRANTEETYPE | CHAR(1)      |          | G = Grantee is a group<br>U = Grantee is an individual user   |
| TABSCHEMA   | VARCHAR(128) |          | Schema name of the table or view.   |
| TABNAME     | VARCHAR(128) |          | Unqualified name of the table or view.  |
| CONTROLAUTH | CHAR(1)      |          | CONTROL privilege.<br>N = Not held<br>Y = Held but not grantable  |
| ALTERAUTH   | CHAR(1)      |          | Privilege to alter the table; allow a parent table to this table to drop its primary key or unique constraint; allow a table to become a materialized query table that references this table or view in the materialized query; or allow a table that references this table or view in its materialized query to no longer be a materialized query table.<br>G = Held and grantable<br>N = Not held<br>Y = Held |
| DELETEAUTH  | CHAR(1)      |          | Privilege to delete rows from a table or updatable view.<br>G = Held and grantable<br>N = Not held<br>Y = Held  |
| INDEXAUTH   | CHAR(1)      |          | Privilege to create an index on a table.<br>G = Held and grantable<br>N = Not held<br>Y = Held  |
| INSERTAUTH  | CHAR(1)      |          | Privilege to insert rows into a table or updatable view, or to run the import utility against a table or view.<br>G = Held and grantable<br>N = Not held<br>Y = Held  |
| REFAUTH     | CHAR(1)      |          | Privilege to create and drop a foreign key referencing a table as the parent.<br>G = Held and grantable<br>N = Not held<br>Y = Held   |

Table 119. SYSCAT.TABAUTH Catalog View (continued)

| Column Name | Data Type | Nullable | Description   |
|-------------|-----------|----------|---|
| SELECTAUTH  | CHAR(1)   |          | Privilege to retrieve rows from a table or view, create views on a table, or to run the export utility against a table or view.<br>G = Held and grantable<br>N = Not held<br>Y = Held |
| UPDATEAUTH  | CHAR(1)   |          | Privilege to run the UPDATE statement against a table or updatable view.<br>G = Held and grantable<br>N = Not held<br>Y = Held  |

---

**SYSCAT.TABCONST**

Each row represents a table constraint of type CHECK, UNIQUE, PRIMARY KEY, or FOREIGN KEY. For table hierarchies, each constraint is recorded only at the level of the hierarchy where the constraint was created.

Table 120. SYSCAT.TABCONST Catalog View

| Column Name          | Data Type    | Nullable | Description  |
|----------------------|--------------|----------|--|
| CONSTNAME            | VARCHAR(128) |          | Name of the constraint.  |
| TABSCHEMA            | VARCHAR(128) |          | Schema name of the table to which this constraint applies.   |
| TABNAME              | VARCHAR(128) |          | Unqualified name of the table to which this constraint applies.  |
| OWNER                | VARCHAR(128) |          | Authorization ID under which the constraint was created.   |
| TYPE                 | CHAR(1)      |          | Indicates the constraint type.<br>F = Foreign key<br>I = Functional dependency<br>K = Check<br>P = Primary key<br>U = Unique |
| ENFORCED             | CHAR(1)      |          | N = Do not enforce constraint<br>Y = Enforce constraint  |
| CHECKEXISTINGDATA    | CHAR(1)      |          | D = Defer checking any existing data<br>I = Immediately check existing data<br>N = Never check existing data                 |
| ENABLEQUERYOPT       | CHAR(1)      |          | N = Query optimization is disabled<br>Y = Query optimization is enabled  |
| DEFINER <sup>1</sup> | VARCHAR(128) |          | Authorization ID under which the constraint was created.   |
| REMARKS              | VARCHAR(254) | Y        | User-provided comments, or null.   |

**Notes:**

1. The DEFINER column is included for backwards compatibility. See OWNER.

## SYSCAT.TABDEP

Each row represents a dependency of a view or a materialized query table on some other object. The view or materialized query table depends on the object of type BTYPE of name BNAME, so a change to the object affects the view or materialized query table. Also encodes how privileges on views depend on privileges on underlying tables and views.

Table 121. SYSCAT.TABDEP Catalog View

| Column Name          | Data Type    | Nullable | Description   |
|----------------------|--------------|----------|---|
| TABSCHEMA            | VARCHAR(128) |          | Schema name of the view or materialized query table.  |
| TABNAME              | VARCHAR(128) |          | Unqualified name of the view or materialized query table.   |
| DTYPE                | CHAR(1)      |          | Type of the depending object.<br>S = Materialized query table<br>T = Table (staging only)<br>V = View (untyped)<br>W = Typed view   |
| OWNER                | VARCHAR(128) |          | Authorization ID of the creator of the view or materialized query table.  |
| BTYPE                | CHAR(1)      |          | Type of object on which there is a dependency. Possible values are:<br>A = Alias<br>F = Routine instance<br>I = Index, if recording dependency on a base table<br>N = Nickname<br>O = Privilege dependency on all subtables or subviews in a table or view hierarchy<br>R = Structured type<br>S = Materialized query table<br>T = Table (untyped)<br>U = Typed table<br>V = View (untyped)<br>W = Typed view<br>Z = XSR object |
| BSCHEMA              | VARCHAR(128) |          | Schema name of the object on which the view or materialized query table depends.  |
| BNAME                | VARCHAR(128) |          | Unqualified name of the object on which the view or materialized query table depends.   |
| TABAUTH              | SMALLINT     | Y        | If BTYPE is 'N', 'O', 'S', 'T', 'U', 'V', or 'W', encodes the privileges on the underlying table or view on which this view or materialized query table depends; null value otherwise.  |
| DEFINER <sup>1</sup> | VARCHAR(128) |          | Authorization ID of the creator of the view or materialized query table.  |

## SYSCAT.TABDEP

Table 121. SYSCAT.TABDEP Catalog View (continued)

| Column Name | Data Type | Nullable | Description |
|-------------|-----------|----------|-------------|
|-------------|-----------|----------|-------------|

---

**Notes:**

1. The DEFINER column is included for backwards compatibility. See OWNER.

---

**SYSCAT.TABDETACHEDDEP**

Each row represents a detached dependency between a detached dependent and a detached table.

*Table 122. SYSCAT.TABDETACHEDDEP Catalog View*

| Column Name  | Data Type    | Nullable | Description                                 |
|--------------|--------------|----------|---|
| TABSCHEMA    | VARCHAR(128) |          | Schema name of the detached table.          |
| TABNAME      | VARCHAR(128) |          | Unqualified name of the detached table.     |
| DEPTABSCHEMA | VARCHAR(128) |          | Schema name of the detached dependent.      |
| DEPTABNAME   | VARCHAR(128) |          | Unqualified name of the detached dependent. |

---

**SYSCAT.TABLES**

Each row represents a table, view, alias, or nickname. Each table or view hierarchy has one additional row representing the hierarchy table or hierarchy view that implements the hierarchy. Catalog tables and views are included.

Table 123. SYSCAT.TABLES Catalog View

| Column Name     | Data Type    | Nullable | Description   |
|-----------------|--------------|----------|---|
| TABSHEMA        | VARCHAR(128) |          | Schema name of the object.  |
| TABNAME         | VARCHAR(128) |          | Unqualified name of the object.   |
| OWNER           | VARCHAR(128) |          | Authorization ID under which the table, view, alias, or nickname was created.   |
| TYPE            | CHAR(1)      |          | Type of object.<br>A = Alias<br>G = Global temporary table<br>H = Hierarchy table<br>L = Detached table<br>N = Nickname<br>S = Materialized query table<br>T = Table (untyped)<br>U = Typed table<br>V = View (untyped)<br>W = Typed view |
| STATUS          | CHAR(1)      |          | Status of the object.<br>C = Set integrity pending<br>N = Normal<br>X = Inoperative   |
| BASE_TABSCHEMA  | VARCHAR(128) | Y        | If TYPE = 'A', contains the schema name of the table, view, alias, or nickname that is referenced by this alias; null value otherwise.  |
| BASE_TABNAME    | VARCHAR(128) | Y        | If TYPE = 'A', contains the unqualified name of the table, view, alias, or nickname that is referenced by this alias; null value otherwise.   |
| ROWTYPESHEMA    | VARCHAR(128) | Y        | Schema name of the row type for this table, if applicable; null value otherwise.  |
| ROWTYPENAME     | VARCHAR(128) | Y        | Unqualified name of the row type for this table, if applicable; null value otherwise.   |
| CREATE_TIME     | TIMESTAMP    |          | Time at which the object was created.   |
| INVALIDATE_TIME | TIMESTAMP    |          | Time at which the object was last invalidated.  |
| STATS_TIME      | TIMESTAMP    | Y        | Time at which any change was last made to recorded statistics for this object. Null if statistics are not collected.  |
| COLCOUNT        | SMALLINT     |          | Number of columns, including inherited columns (if any).  |
| TABLEID         | SMALLINT     |          | Internal logical object identifier.   |
| TBSPACEID       | SMALLINT     |          | Internal logical identifier for the primary table space for this object.  |



Table 123. SYSCAT.TABLES Catalog View (continued)

| Column Name   | Data Type    | Nullable | Description  |
|---------------|--------------|----------|--|
| CARD          | BIGINT       |          | Total number of rows; -1 if statistics are not collected.  |
| NPAGES        | BIGINT       |          | Total number of pages on which the rows of the table exist; -1 for a view or alias, or if statistics are not collected; -2 for a subtable or hierarchy table.  |
| FPAGES        | BIGINT       |          | Total number of pages; -1 for a view or alias, or if statistics are not collected; -2 for a subtable or hierarchy table.   |
| OVERFLOW      | BIGINT       |          | Total number of overflow records in the table; -1 for a view or alias, or if statistics are not collected; -2 for a subtable or hierarchy table.   |
| TBSPACE       | VARCHAR(128) | Y        | Name of the primary table space for the table. If no other table space is specified, all parts of the table are stored in this table space. Null for aliases, views, and partitioned tables.   |
| INDEX_TBSPACE | VARCHAR(128) | Y        | Name of the table space that holds all indexes created on this table. Null for aliases, views, and partitioned tables, or if the INDEX IN clause was omitted or specified with the same value as the IN clause of the CREATE TABLE statement.                      |
| LONG_TBSPACE  | VARCHAR(128) | Y        | Name of the table space that holds all long data (LONG or LOB column types) for this table. Null for aliases, views, and partitioned tables, or if the LONG IN clause was omitted or specified with the same value as the IN clause of the CREATE TABLE statement. |
| PARENTS       | SMALLINT     | Y        | Number of parent tables for this object; that is, the number of referential constraints in which this object is a dependent.   |
| CHILDREN      | SMALLINT     | Y        | Number of dependent tables for this object; that is, the number of referential constraints in which this object is a parent.   |
| SELFREFS      | SMALLINT     | Y        | Number of self-referencing referential constraints for this object; that is, the number of referential constraints in which this object is both a parent and a dependent.  |
| KEYCOLUMNS    | SMALLINT     | Y        | Number of columns in the primary key.  |
| KEYINDEXID    | SMALLINT     | Y        | Index identifier for the primary key index; 0 or the null value if there is no primary key.  |
| KEYUNIQUE     | SMALLINT     |          | Number of unique key constraints (other than the primary key constraint) defined on this object.   |
| CHECKCOUNT    | SMALLINT     |          | Number of check constraints defined on this object.  |

## SYSCAT.TABLES

Table 123. SYSCAT.TABLES Catalog View (continued)

| Column Name    | Data Type | Nullable | Description  |
|----------------|-----------|----------|--|
| DATA_CAPTURE   | CHAR(1)   |          | <p>L = Table participates in data replication, including replication of LONG VARCHAR and LONG VARGRAPHIC columns</p> <p>N = Table does not participate in data replication</p> <p>Y = Table participates in data replication, excluding replication of LONG VARCHAR and LONG VARGRAPHIC columns</p>  |
| CONST_CHECKED  | CHAR(32)  |          | <p>Byte 1 represents foreign key constraint.</p> <p>Byte 2 represents check constraint.</p> <p>Byte 5 represents materialized query table.</p> <p>Byte 6 represents generated column.</p> <p>Byte 7 represents staging table.</p> <p>Byte 8 represents data partitioning constraint.</p> <p>Other bytes are reserved for future use.</p> <p>Possible values are:</p> <p>F = In byte 5, the materialized query table cannot be refreshed incrementally.</p> <p>In byte 7, the content of the staging table is incomplete and cannot be used for incremental refresh of the associated materialized query table.</p> <p>N = Not checked</p> <p>U = Checked by user</p> <p>W = Was in 'U' state when the table was placed in set integrity pending state</p> <p>Y = Checked by system</p> |
| PMAP_ID        | SMALLINT  | Y        | Identifier for the distribution map that is currently in use by this table (null for aliases or views).  |
| PARTITION_MODE | CHAR(1)   |          | <p>Indicates how data is distributed among database partitions in a partitioned database system.</p> <p>H = Hashing</p> <p>R = Replicated across database partitions</p> <p>Blank = No database partitioning</p>   |
| LOG_ATTRIBUTE  | CHAR(1)   |          | Always 0. This column is no longer used.   |
| PCTFREE        | SMALLINT  |          | Percentage of each page to be reserved for future inserts.   |

Table 123. SYSCAT.TABLES Catalog View (continued)

| Column Name        | Data Type   | Nullable | Description   |
|--------------------|-------------|----------|---|
| APPEND_MODE        | CHAR(1)     |          | Controls how rows are inserted into pages.<br>N = New rows are inserted into existing spaces, if available<br>Y = New rows are appended to the end of the data<br><br>Initial value is 'N'.   |
| REFRESH            | CHAR(1)     |          | Refresh mode.<br>D = Deferred<br>I = Immediate<br>O = Once<br>Blank = Not a materialized query table  |
| REFRESH_TIME       | TIMESTAMP   | Y        | For REFRESH = 'D' or 'O', time at which the data was last refreshed (REFRESH TABLE statement); null value otherwise.  |
| LOCKSIZE           | CHAR(1)     |          | Indicates the preferred lock granularity for tables that are accessed by data manipulation language (DML) statements. Applies to tables only. Possible values are:<br>I = Block insert<br>R = Row<br>T = Table<br>Blank = Not applicable<br><br>Initial value is 'R'.   |
| VOLATILE           | CHAR(1)     |          | C = Cardinality of the table is volatile<br>Blank = Not applicable  |
| ROW_FORMAT         | CHAR(1)     |          | Not used.   |
| PROPERTY           | VARCHAR(32) |          | Properties for a table. A single blank indicates that the table has no properties.  |
| STATISTICS_PROFILE | CLOB(10M)   | Y        | RUNSTATS command used to register a statistical profile for the object.   |
| COMPRESSION        | CHAR(1)     |          | B = Both value and row compression are activated<br>N = No compression is activated; a row format that does not support compression is used<br>R = Row compression is activated; a row format that supports compression might be used<br>V = Value compression is activated; a row format that supports compression is used<br>Blank = Not applicable |

## SYSCAT.TABLES

Table 123. SYSCAT.TABLES Catalog View (continued)

| Column Name            | Data Type  | Nullable | Description   |
|------------------------|------------|----------|---|
| ACCESS_MODE            | CHAR(1)    |          | Access restriction state of the object. These states only apply to objects that are in set integrity pending state or to objects that were processed by a SET INTEGRITY statement. Possible values are:<br>D = No data movement<br>F = Full access<br>N = No access<br>R = Read-only access   |
| CLUSTERED              | CHAR(1)    | Y        | Y = Table is multidimensionally clustered (even if only by one dimension)<br>Null value = Table is not multidimensionally clustered   |
| ACTIVE_BLOCKS          | BIGINT     |          | Total number of active blocks in the table, or -1. Applies to multidimensional clustering (MDC) tables only.  |
| DROPRULE               | CHAR(1)    |          | N = No rule<br>R = Restrict rule applies on drop  |
| MAXFREESPACESEARCH     | SMALLINT   |          | Reserved for future use.  |
| AVGCOMPRESSEDROWSIZE   | SMALLINT   |          | Average length (in bytes) of compressed rows in this table; -1 if statistics are not collected.   |
| AVGROWCOMPRESSIONRATIO | REAL       |          | For compressed rows in the table, this is the average compression ratio by row; that is, the average uncompressed row length divided by the average compressed row length; -1 if statistics are not collected.  |
| AVGROWSIZE             | SMALLINT   |          | Average length (in bytes) of both compressed and uncompressed rows in this table; -1 if statistics are not collected.   |
| PCTROWSCOMPRESSED      | REAL       |          | Compressed rows as a percentage of the total number of rows in the table; -1 if statistics are not collected.   |
| LOGINDEXBUILD          | VARCHAR(3) | Y        | Level of logging that is to be performed during create, recreate, or reorganize index operations on the table.<br>OFF = Index build operations on the table will be logged minimally<br>ON = Index build operations on the table will be logged completely<br>Null value = Value of the <i>logindexbuild</i> database configuration parameter will be used to determine whether or not index build operations are to be completely logged |
| CODEPAGE               | SMALLINT   |          | Code page of the object. This is the default code page used for all character columns, triggers, check constraints, and expression-generated columns.   |

Table 123. SYSCAT.TABLES Catalog View (continued)

| Column Name           | Data Type    | Nullable | Description  |
|-----------------------|--------------|----------|--|
| ENCODING_SCHEME       | CHAR(1)      |          | A = CCSID ASCII was specified<br>U = CCSID UNICODE was specified<br>Blank = CCSID clause was not specified   |
| PCTPAGESSAVED         | SMALLINT     |          | Approximate percentage of pages saved in the table as a result of row compression. This value includes overhead bytes for each user data row in the table, but does not include the space that is consumed by dictionary overhead; -1 if statistics are not collected. |
| LAST_REGEN_TIME       | TIMESTAMP    |          | Time at which any views or check constraints on the table were last regenerated.   |
| SECPOLICYID           | INTEGER      |          | Identifier for the security policy protecting the table; 0 for non-protected tables.   |
| PROTECTIONGRANULARITY | CHAR(1)      |          | B = Both column- and row-level granularity<br>C = Column-level granularity<br>R = Row-level granularity<br>Blank = Non-protected table   |
| DEFINER <sup>1</sup>  | VARCHAR(128) |          | Authorization ID under which the table, view, alias, or nickname was created.  |
| REMARKS               | VARCHAR(254) | Y        | User-provided comments, or null.   |

**Notes:**

1. The DEFINER column is included for backwards compatibility. See OWNER.

---

**SYSCAT.TABLESPACES**

Each row represents a table space.

Table 124. SYSCAT.TABLESPACES Catalog View

| Column Name          | Data Type    | Nullable | Description  |
|----------------------|--------------|----------|--|
| TBSPACE              | VARCHAR(128) |          | Name of the table space.   |
| OWNER                | VARCHAR(128) |          | Authorization ID under which the table space was created.  |
| CREATE_TIME          | TIMESTAMP    |          | Time at which the table space was created.   |
| TBSPACEID            | INTEGER      |          | Identifier for the table space.  |
| TBSPACETYPE          | CHAR(1)      |          | Type of table space.<br>D = Database-managed space<br>S = System-managed space   |
| DATATYPE             | CHAR(1)      |          | Type of data that can be stored in this table space.<br>A = All types of permanent data; regular table space<br>L = All types of permanent data; large table space<br>T = System temporary tables only<br>U = Declared temporary tables only |
| EXTENTSIZE           | INTEGER      |          | Size of each extent, in pages of size PAGESIZE. This many pages are written to one container in the table space before switching to the next container.  |
| PREFETCHSIZE         | INTEGER      |          | Number of pages of size PAGESIZE to be read when prefetching is performed; -1 when AUTOMATIC.  |
| OVERHEAD             | DOUBLE       |          | Controller overhead and disk seek and latency time, in milliseconds (average for the containers in this table space).  |
| TRANSFERRATE         | DOUBLE       |          | Time to read one page of size PAGESIZE into the buffer (average for the containers in this table space).   |
| PAGESIZE             | INTEGER      |          | Size (in bytes) of pages in this table space.  |
| DBPGNAME             | VARCHAR(128) |          | Name of the database partition group that is associated with this table space.   |
| BUFFERPOOLID         | INTEGER      |          | Identifier for the buffer pool that is used by this table space (1 indicates the default buffer pool).   |
| DROP_RECOVERY        | CHAR(1)      |          | Indicates whether or not tables in this table space can be recovered after a drop table operation.<br>N = Tables are not recoverable<br>Y = Tables are recoverable   |
| NGNAME <sup>1</sup>  | VARCHAR(128) |          | Name of the database partition group that is associated with this table space.   |
| DEFINER <sup>2</sup> | VARCHAR(128) |          | Authorization ID under which the table space was created.  |

Table 124. SYSCAT.TABLESPACES Catalog View (continued)

| Column Name | Data Type    | Nullable | Description                      |
|-------------|--------------|----------|----------------------------------|
| REMARKS     | VARCHAR(254) | Y        | User-provided comments, or null. |

**Notes:**

1. The NGNAME column is included for backwards compatibility. See DBPGNAME.
2. The DEFINER column is included for backwards compatibility. See OWNER.

## SYSCAT.TABOPTIONS

---

### SYSCAT.TABOPTIONS

Each row represents an option that is associated with a remote table.

*Table 125. SYSCAT.TABOPTIONS Catalog View*

| <b>Column Name</b> | <b>Data Type</b> | <b>Nullable</b> | <b>Description</b>                                     |
|--------------------|------------------|-----------------|--|
| TABSCHEMA          | VARCHAR(128)     |                 | Schema name of a table, view, alias, or nickname.      |
| TABNAME            | VARCHAR(128)     |                 | Unqualified name of a table, view, alias, or nickname. |
| OPTION             | VARCHAR(128)     |                 | Name of the table option.                              |
| SETTING            | CLOB(32K)        |                 | Value of the table option.                             |



---

## SYSCAT.TBSPACEAUTH

Each row represents a user or group that has been granted the USE privilege on a particular table space in the database.

Table 126. SYSCAT.TBSPACEAUTH Catalog View

| Column Name | Data Type    | Nullable | Description  |
|-------------|--------------|----------|--|
| GRANTOR     | VARCHAR(128) |          | Grantor of the privilege.  |
| GRANTEE     | VARCHAR(128) |          | Holder of the privilege.   |
| GRANTEETYPE | CHAR(1)      |          | G = Grantee is a group<br>U = Grantee is an individual user  |
| TBSPACE     | VARCHAR(128) |          | Name of the table space.   |
| USEAUTH     | CHAR(1)      |          | Privilege to create tables within the table space.<br>G = Held and grantable<br>N = Not held<br>Y = Held |

---

**SYSCAT.TRANSFORMS**

Each row represents the functions that handle transformations between a user-defined type and a base SQL type, or the reverse.

Table 127. SYSCAT.TRANSFORMS Catalog View

| Column Name   | Data Type    | Nullable | Description   |
|---------------|--------------|----------|---|
| TYPEID        | SMALLINT     |          | Identifier for the data type.   |
| TYPESHEMA     | VARCHAR(128) |          | Schema name of the data type. The schema name for built-in types is 'SYSIBM'.   |
| TYPENAME      | VARCHAR(128) |          | Unqualified name of the data type.  |
| GROUPNAME     | VARCHAR(128) |          | Name of the transform group.  |
| FUNCID        | INTEGER      |          | Identifier for the routine.   |
| FUNCSHEMA     | VARCHAR(128) |          | Schema name of the routine.   |
| FUNCNAME      | VARCHAR(128) |          | Unqualified name of the routine.  |
| SPECIFICNAME  | VARCHAR(128) |          | Name of the routine instance (might be system-generated).   |
| TRANSFORMTYPE | VARCHAR(8)   |          | 'FROM SQL' = Transform function transforms a structured type from SQL<br>'TO SQL' = Transform function transforms a structured type to SQL                                |
| FORMAT        | CHAR(1)      |          | Format produced by the FROM SQL transform.<br>S = DB2 Struct<br>U = User-defined  |
| MAXLENGTH     | INTEGER      |          | Maximum length (in bytes) of output from the FROM SQL transform; null value for TO SQL transforms.  |
| ORIGIN        | CHAR(1)      |          | Source of this group of transforms.<br>O = Original transform group (built-in or system-defined)<br>R = Redefined transform group (only built-in groups can be redefined) |
| REMARKS       | VARCHAR(254) | Y        | User-provided comments, or null.  |

## SYSCAT.TRIGDEP

Each row represents a dependency of a trigger on some other object. The trigger depends on the object of type BTYPE of name BNAME, so a change to the object affects the trigger.

Table 128. SYSCAT.TRIGDEP Catalog View

| Column Name | Data Type    | Nullable | Description  |
|-------------|--------------|----------|--|
| TRIGSCHEMA  | VARCHAR(128) |          | Schema name of the trigger.  |
| TRIGNAME    | VARCHAR(128) |          | Unqualified name of the trigger.   |
| BTYPE       | CHAR(1)      |          | Type of object on which there is a dependency. Possible values are:<br>A = Alias<br>B = Trigger<br>F = Routine instance<br>H = Hierachy table<br>K = Package<br>L = Detached table<br>O = Privilege dependency on all subtables or subviews in a table or view hierarchy<br>Q = Sequence<br>R = Structured type<br>S = Materialized query table<br>T = Table (not typed)<br>U = Typed table<br>V = View (not typed)<br>W = Typed view<br>X = Index extension<br>Z = XSR object |
| BSCHEMA     | VARCHAR(128) |          | Schema name of the object on which there is a dependency.  |
| BNAME       | VARCHAR(128) |          | Unqualified name of the object on which there is a dependency. For routines (BTYPE = 'F'), this is the specific name.  |
| TABAUTH     | SMALLINT     | Y        | If BTYPE = 'O', 'S', 'T', 'U', 'V' or 'W', encodes the privileges on the table or view that are required by a dependent trigger; null value otherwise.   |

## SYSCAT.TRIGGERS

### SYSCAT.TRIGGERS

Each row represents a trigger. For table hierarchies, each trigger is recorded only at the level of the hierarchy where the trigger was created.

Table 129. SYSCAT.TRIGGERS Catalog View

| Column Name          | Data Type    | Nullable | Description  |
|----------------------|--------------|----------|--|
| TRIGSCHEMA           | VARCHAR(128) |          | Schema name of the trigger.  |
| TRIGNAME             | VARCHAR(128) |          | Unqualified name of the trigger.   |
| OWNER                | VARCHAR(128) |          | Authorization ID under which the trigger was created.  |
| TABSCHEMA            | VARCHAR(128) |          | Schema name of the table or view to which this trigger applies.  |
| TABNAME              | VARCHAR(128) |          | Unqualified name of the table or view to which this trigger applies.   |
| TRIGTIME             | CHAR(1)      |          | Time at which triggered actions are applied to the base table, relative to the event that fired the trigger.<br>A = Trigger is applied after the event<br>B = Trigger is applied before the event<br>I = Trigger is applied instead of the event |
| TRIGEVENT            | CHAR(1)      |          | Event that fires the trigger.<br>D = Delete operation<br>I = Insert operation<br>U = Update operation  |
| GRANULARITY          | CHAR(1)      |          | Trigger is executed once per:<br>R = Row<br>S = Statement  |
| VALID                | CHAR(1)      |          | N = Trigger is invalid<br>Y = Trigger is valid<br>X = Trigger is inoperative and must be recreated   |
| CREATE_TIME          | TIMESTAMP    |          | Time at which the trigger was defined. Used in resolving functions and types.  |
| QUALIFIER            | VARCHAR(128) |          | Value of the default schema at the time of object definition. Used to complete any unqualified references.   |
| FUNC_PATH            | VARCHAR(254) |          | SQL path at the time the trigger was defined. Used in resolving functions and types.   |
| TEXT                 | CLOB(2M)     |          | Full text of the CREATE TRIGGER statement, exactly as typed.   |
| LAST_REGEN_TIME      | TIMESTAMP    |          | Time at which the packed descriptor for the trigger was last regenerated.  |
| DEFINER <sup>1</sup> | VARCHAR(128) |          | Authorization ID under which the trigger was created.  |
| REMARKS              | VARCHAR(254) | Y        | User-provided comments, or null.   |

#### Notes:

1. The DEFINER column is included for backwards compatibility. See OWNER.



## SYSCAT.TYPEMAPPINGS

Each row represents a data type mapping between a locally-defined data type and a data source data type. There are two mapping types (mapping directions):

- Forward type mappings map a data source data type to a locally-defined data type.
- Reverse type mappings map a locally-defined data type to a data source data type.

Table 130. SYSCAT.TYPEMAPPINGS Catalog View

| Column Name      | Data Type    | Nullable | Description  |
|------------------|--------------|----------|--|
| TYPE_MAPPING     | VARCHAR(18)  |          | Name of the type mapping (might be system-generated).  |
| MAPPINGDIRECTION | CHAR(1)      |          | Indicates whether this type mapping is a forward or a reverse type mapping.<br>F = Forward type mapping<br>R = Reverse type mapping  |
| TYPESHEMA        | VARCHAR(128) | Y        | Schema name of the local type in a data type mapping; null for built-in types.   |
| TYPENAME         | VARCHAR(128) |          | Unqualified name of the local type in a data type mapping.   |
| TYPEID           | SMALLINT     |          | Identifier for the data type.  |
| SOURCETYPEID     | SMALLINT     |          | Identifier for the source type.  |
| OWNER            | VARCHAR(128) |          | Authorization ID under which this type mapping was created. 'SYSIBM' indicates a built-in type mapping.  |
| LENGTH           | INTEGER      | Y        | Maximum length or precision of the local data type in this mapping. If null, the system determines the maximum length or precision. For character types, represents the maximum number of bytes. |
| SCALE            | SMALLINT     | Y        | Maximum number of digits in the fractional part of a local decimal value in this mapping. If null, the system determines the maximum number.   |
| LOWER_LEN        | INTEGER      | Y        | Minimum length or precision of the local data type in this mapping. If null, the system determines the minimum length or precision. For character types, represents the minimum number of bytes. |
| UPPER_LEN        | INTEGER      | Y        | Maximum length or precision of the local data type in this mapping. If null, the system determines the maximum length or precision. For character types, represents the maximum number of bytes. |
| LOWER_SCALE      | SMALLINT     | Y        | Minimum number of digits in the fractional part of a local decimal value in this mapping. If null, the system determines the minimum number.   |

Table 130. SYSCAT.TYEMAPPINGS Catalog View (continued)

| Column Name        | Data Type    | Nullable | Description  |
|--------------------|--------------|----------|--|
| UPPER_SCALE        | SMALLINT     | Y        | Maximum number of digits in the fractional part of a local decimal value in this mapping. If null, the system determines the maximum number.   |
| S_OPR_P            | CHAR(2)      | Y        | Relationship between the scale and precision of a local decimal value in this mapping. Basic comparison operators (=, <, >, <=, >=, <>) can be used. A null value indicates that no specific relationship is required.   |
| BIT_DATA           | CHAR(1)      | Y        | Indicates whether or not this character type is for bit data. Possible values are:<br>N = This type is not for bit data<br>Y = This type is for bit data<br>Null value = This is not a character data type, or the system determines the bit data attribute  |
| WRAPNAME           | VARCHAR(128) | Y        | Data access protocol (wrapper) to which this mapping applies.  |
| SERVERNAME         | VARCHAR(128) | Y        | Uppercase name of the server.  |
| SERVERTYPE         | VARCHAR(30)  | Y        | Type of server.  |
| SERVERVERSION      | VARCHAR(18)  | Y        | Server version.  |
| REMOTE_TYPESHEMA   | VARCHAR(128) | Y        | Schema name of the data source data type.  |
| REMOTE_TYPENAME    | VARCHAR(128) |          | Unqualified name of the data source data type.   |
| REMOTE_META_TYPE   | CHAR(1)      | Y        | Indicates whether this remote type is a system built-in type or a distinct type.<br>S = System built-in type<br>T = Distinct type  |
| REMOTE_LOWER_LEN   | INTEGER      | Y        | Minimum length or precision of the remote data type in this mapping, or the null value. For character types, represents the minimum number of characters (not bytes). For binary types, represents the minimum number of bytes. A value of -1 indicates that the default length or precision is used, or that the remote type does not have a length or precision. |
| REMOTE_UPPER_LEN   | INTEGER      | Y        | Maximum length or precision of the remote data type in this mapping, or the null value. For character types, represents the maximum number of characters (not bytes). For binary types, represents the maximum number of bytes. A value of -1 indicates that the default length or precision is used, or that the remote type does not have a length or precision. |
| REMOTE_LOWER_SCALE | SMALLINT     | Y        | Minimum number of digits in the fractional part of a remote decimal value in this mapping, or the null value.  |

## SYSCAT.TYPEMAPPINGS

Table 130. SYSCAT.TYPEMAPPINGS Catalog View (continued)

| Column Name          | Data Type    | Nullable | Description  |
|----------------------|--------------|----------|--|
| REMOTE_UPPER_SCALE   | SMALLINT     | Y        | Maximum number of digits in the fractional part of a remote decimal value in this mapping, or the null value.  |
| REMOTE_S_OPR_P       | CHAR(2)      | Y        | Relationship between the scale and precision of a remote decimal value in this mapping. Basic comparison operators (=, <, >, <=, >=, <>) can be used. A null value indicates that no specific relationship is required.  |
| REMOTE_BIT_DATA      | CHAR(1)      | Y        | Indicates whether or not this remote character type is for bit data. Possible values are:<br>N = This type is not for bit data<br>Y = This type is for bit data<br>Null value = This is not a character data type, or the system determines the bit data attribute |
| USER_DEFINED         | CHAR(1)      |          | Indicates whether or not the mapping is user-defined. The value is always 'Y'; that is, the mapping is always user-defined.  |
| CREATE_TIME          | TIMESTAMP    |          | Time at which this mapping was created.  |
| DEFINER <sup>1</sup> | VARCHAR(128) |          | Authorization ID under which this type mapping was created. 'SYSIBM' indicates a built-in type mapping.  |
| REMARKS              | VARCHAR(254) | Y        | User-provided comments, or null.   |

### Notes:

1. The DEFINER column is included for backwards compatibility. See OWNER.



---

## SYSCAT.USEROPTIONS

Each row represents a server-specific user option value.

*Table 131. SYSCAT.USEROPTIONS Catalog View*

| Column Name | Data Type     | Nullable | Description                                      |
|-------------|---------------|----------|--|
| AUTHID      | VARCHAR(128)  |          | Local authorization ID, in uppercase characters. |
| SERVERNAME  | VARCHAR(128)  |          | Name of the server on which the user is defined. |
| OPTION      | VARCHAR(128)  |          | Name of the user option.                         |
| SETTING     | VARCHAR(2048) |          | Value of the user option.                        |

---

**SYSCAT.VIEWS**

Each row represents a view.

Table 132. SYSCAT.VIEWS Catalog View

| Column Name          | Data Type    | Nullable | Description   |
|----------------------|--------------|----------|---|
| VIEWSCHEMA           | VARCHAR(128) |          | Schema name of the view.  |
| VIEWNAME             | VARCHAR(128) |          | Unqualified name of the view.   |
| OWNER                | VARCHAR(128) |          | Authorization ID under which the view was created.  |
| SEQNO                | SMALLINT     |          | Always 1.   |
| VIEWCHECK            | CHAR(1)      |          | Type of view checking.<br>C = Cascaded check option<br>L = Local check option<br>N = No check option  |
| READONLY             | CHAR(1)      |          | N = View can be updated by users with appropriate authorization<br>Y = View is read-only because of its definition  |
| VALID                | CHAR(1)      |          | X = View or materialized query table definition is inoperative and must be recreated<br>Y = View or materialized query table definition is valid  |
| QUALIFIER            | VARCHAR(128) |          | Value of the default schema at the time of object definition. Used to complete any unqualified references.  |
| FUNC_PATH            | VARCHAR(254) |          | SQL path in effect when the view was defined. When the view is referenced in data manipulation language (DML) statements, this path must be used to resolve function calls in the view. 'SYSIBM' for pre-Version 2 views. |
| TEXT                 | CLOB(2M)     |          | Full text of the CREATE VIEW statement, exactly as typed.   |
| DEFINER <sup>1</sup> | VARCHAR(128) |          | Authorization ID under which the view was created.  |

**Notes:**

1. The DEFINER column is included for backwards compatibility. See OWNER.

---

## SYSCAT.WRAPOPTIONS

Each row represents a wrapper-specific option.

*Table 133. SYSCAT.WRAPOPTIONS Catalog View*

| Column Name | Data Type     | Nullable | Description                  |
|-------------|---------------|----------|------------------------------|
| WRAPNAME    | VARCHAR(128)  |          | Name of the wrapper.         |
| OPTION      | VARCHAR(128)  |          | Name of the wrapper option.  |
| SETTING     | VARCHAR(2048) |          | Value of the wrapper option. |

## SYSCAT.WRAPPERS

---

## SYSCAT.WRAPPERS

Each row represents a registered wrapper.

Table 134. SYSCAT.WRAPPERS Catalog View

| Column Name | Data Type    | Nullable | Description  |
|-------------|--------------|----------|--|
| WRAPNAME    | VARCHAR(128) |          | Name of the wrapper.   |
| WRAPTYPE    | CHAR(1)      |          | Type of wrapper.<br>N = Non-relational<br>R = Relational   |
| WRAPVERSION | INTEGER      |          | Version of the wrapper.  |
| LIBRARY     | VARCHAR(255) |          | Name of the file that contains the code used to communicate with the data sources that are associated with this wrapper. |
| REMARKS     | VARCHAR(254) | Y        | User-provided comments, or null.   |

---

## SYSCAT.XDBMAPGRAPHS

Each row represents a schema graph for an XDB map (XSR object).

*Table 135. SYSCAT.XDBMAPGRAPHS Catalog View*

| Column Name   | Data Type     | Nullable | Description  |
|---------------|---------------|----------|--|
| OBJECTID      | BIGINT        |          | Unique generated identifier for an XSR object.                         |
| OBJECTSCHEMA  | VARCHAR(128)  |          | Schema name of the XSR object.   |
| OBJECTNAME    | VARCHAR(128)  |          | Unqualified name of the XSR object.                                    |
| SCHEMAGRAPHID | INTEGER       |          | Schema graph identifier, which is unique within an XDB map identifier. |
| NAMESPACE     | VARCHAR(1000) |          | String identifier for the namespace URI of the root element.           |
| ROOTELEMENT   | VARCHAR(1000) |          | String identifier for the element name of the root element.            |

---

**SYSCAT.XDBMAPSHREDTREES**

Each row represents one shred tree for a given schema graph identifier.

*Table 136. SYSCAT.XDBMAPSHREDTREES Catalog View*

| Column Name        | Data Type    | Nullable | Description  |
|--------------------|--------------|----------|--|
| OBJECTID           | BIGINT       |          | Unique generated identifier for an XSR object.                         |
| OBJECTSCHEMA       | VARCHAR(128) |          | Schema name of the XSR object.   |
| OBJECTNAME         | VARCHAR(128) |          | Unqualified name of the XSR object.                                    |
| SCHEMAGRAPHID      | INTEGER      |          | Schema graph identifier, which is unique within an XDB map identifier. |
| SHREDTREEID        | INTEGER      |          | Shred tree identifier, which is unique within an XDB map identifier.   |
| MAPPINGDESCRIPTION | CLOB(1M)     | Y        | Diagnostic mapping information.  |

---

## SYSCAT.XSROBJECTAUTH

Each row represents a user or group that has been granted the USAGE privilege on a particular XSR object.

*Table 137. SYSCAT.XSROBJECTAUTH Catalog View*

| Column Name | Data Type    | Nullable | Description   |
|-------------|--------------|----------|---|
| GRANTOR     | VARCHAR(128) |          | Grantor of the privilege.   |
| GRANTEE     | VARCHAR(128) |          | Holder of the privilege.  |
| GRANTEETYPE | CHAR(1)      |          | G = Grantee is a group<br>U = Grantee is an individual user                     |
| OBJECTID    | BIGINT       |          | Identifier for the XSR object.  |
| USAGEAUTH   | CHAR(1)      |          | Privilege to use the XSR object and its components.<br>N = Not held<br>Y = Held |

---

**SYSCAT.XSROBJECTCOMPONENTS**

Each row represents an XSR object component.

*Table 138. SYSCAT.XSROBJECTCOMPONENTS Catalog View*

| Column Name     | Data Type    | Nullable | Description  |
|-----------------|--------------|----------|--|
| OBJECTID        | BIGINT       |          | Unique generated identifier for an XSR object.           |
| OBJECTSCHEMA    | VARCHAR(128) |          | Schema name of the XSR object.                           |
| OBJECTNAME      | VARCHAR(128) |          | Unqualified name of the XSR object.                      |
| COMPONENTID     | BIGINT       |          | Unique generated identifier for an XSR object component. |
| TARGETNAMESPACE | INTEGER      |          | String identifier for the target namespace.              |
| SCHEMALOCATION  | INTEGER      |          | String identifier for the schema location.               |
| COMPONENT       | BLOB(30M)    |          | External representation of the component.                |
| STATUS          | CHAR(1)      |          | Registration status.<br>C = Complete<br>I = Incomplete   |



## SYSCAT.XSROBJECTDEP

Each row represents a dependency of an XSR object on some other object. The XSR object depends on the object of type BTYPE of name BNAME, so a change to the object affects the XSR object.

Table 139. SYSCAT.XSROBJECTDEP Catalog View

| Column Name  | Data Type    | Nullable | Description  |
|--------------|--------------|----------|--|
| OBJECTID     | BIGINT       |          | Unique generated identifier for an XSR object.   |
| OBJECTSCHEMA | VARCHAR(128) |          | Schema name of the XSR object.   |
| OBJECTNAME   | VARCHAR(128) |          | Unqualified name of the XSR object.  |
| BTYPE        | CHAR(1)      |          | Type of object on which there is a dependency. Possible values are:<br>A = Alias<br>B = Trigger<br>F = Routine instance<br>H = Hierachy table<br>K = Package<br>L = Detached table<br>O = Privilege dependency on all subtables or subviews in a table or view hierarchy<br>Q = Sequence<br>R = Structured type<br>S = Materialized query table<br>T = Table (not typed)<br>U = Typed table<br>V = View (not typed)<br>W = Typed view<br>X = Index extension<br>Z = XSR object |
| BSCHEMA      | VARCHAR(128) |          | Schema name of the object on which there is a dependency.  |
| BNAME        | VARCHAR(128) |          | Unqualified name of the object on which there is a dependency. For routines (BTYPE = 'F'), this is the specific name.  |
| TABAUTH      | SMALLINT     | Y        | If BTYPE = 'O', 'S', 'T', 'U', 'V' or 'W', encodes the privileges on the table or view that are required by a dependent trigger; null value otherwise.   |

---

**SYSCAT.XSROBJECTHIERARCHIES**

Each row represents the hierarchical relationship between an XSR object and its components.

*Table 140. SYSCAT.XSROBJECTHIERARCHIES Catalog View*

| Column Name     | Data Type     | Nullable | Description  |
|-----------------|---------------|----------|--|
| OBJECTID        | BIGINT        |          | Identifier for an XSR object.  |
| COMPONENTID     | BIGINT        |          | Identifier for an XSR component.   |
| HTYPE           | CHAR(1)       |          | Hierarchy type.<br>D = Document<br>N = Top-level namespace<br>P = Primary document |
| TARGETNAMESPACE | VARCHAR(1000) |          | String identifier for the component's target namespace.                            |
| SCHEMALOCATION  | VARCHAR(1000) |          | String identifier for the component's schema location.                             |

---

**SYSCAT.XSROBJECTS**

Each row represents an XML schema repository object.

Table 141. SYSCAT.XSROBJECTS Catalog View

| Column Name     | Data Type     | Nullable | Description  |
|-----------------|---------------|----------|--|
| OBJECTID        | BIGINT        |          | Unique generated identifier for an XSR object.   |
| OBJECTSCHEMA    | VARCHAR(128)  |          | Schema name of the XSR object.   |
| OBJECTNAME      | VARCHAR(128)  |          | Unqualified name of the XSR object.  |
| TARGETNAMESPACE | VARCHAR(1000) |          | String identifier for the target namespace, or public identifier.  |
| SCHEMALOCATION  | VARCHAR(1000) |          | String identifier for the schema location, or system identifier.   |
| OBJECTINFO      | XML           | Y        | Metadata document.   |
| OBJECTTYPE      | CHAR(1)       |          | XSR object type.<br>D = DTD<br>E = External entity<br>S = XML schema   |
| OWNER           | VARCHAR(128)  |          | Authorization ID under which the XSR object was registered.  |
| CREATE_TIME     | TIMESTAMP     |          | Time at which the object was registered.   |
| ALTER_TIME      | TIMESTAMP     |          | Time at which the object was last updated (replaced).  |
| STATUS          | CHAR(1)       |          | Registration status.<br>C = Complete<br>I = Incomplete<br>R = Replace<br>T = Temporary   |
| DECOMPOSITION   | CHAR(1)       |          | Indicates whether or not decomposition (shredding) is enabled on this XSR object.<br>N = Not enabled<br>X = Inoperative<br>Y = Enabled |
| REMARKS         | VARCHAR(254)  |          | User-provided comments, or null.   |

---

**SYSSTAT.COLDIST**

Each row represents the *n*th most frequent value of some column, or the *n*th quantile (cumulative distribution) value of the column. Applies to columns of real tables only (not views). No statistics are recorded for inherited columns of typed tables.

Table 142. SYSSTAT.COLDIST Catalog View

| Column Name            | Data Type    | Nullable | Updat-able | Description  |
|------------------------|--------------|----------|------------|--|
| TABSCHEMA              | VARCHAR(128) |          |            | Schema name of the table to which the statistics apply.  |
| TABNAME                | VARCHAR(128) |          |            | Unqualified name of the table to which the statistics apply.   |
| COLNAME                | VARCHAR(128) |          |            | Name of the column to which the statistics apply.  |
| TYPE                   | CHAR(1)      |          |            | F = Frequency value<br>Q = Quantile value  |
| SEQNO                  | SMALLINT     |          |            | If TYPE = 'F', <i>n</i> in this column identifies the <i>n</i> th most frequent value. If TYPE = 'Q', <i>n</i> in this column identifies the <i>n</i> th quantile value.     |
| COLVALUE <sup>1</sup>  | VARCHAR(254) | Y        | Y          | Data value as a character literal or a null value.   |
| VALCOUNT               | BIGINT       |          | Y          | If TYPE = 'F', VALCOUNT is the number of occurrences of COLVALUE in the column. If TYPE = 'Q', VALCOUNT is the number of rows whose value is less than or equal to COLVALUE. |
| DISTCOUNT <sup>2</sup> | BIGINT       | Y        | Y          | If TYPE = 'Q', this column records the number of distinct values that are less than or equal to COLVALUE (null if unavailable).  |

**Notes:**

1. In the catalog view, the value of COLVALUE is always shown in the database code page and can contain substitution characters. However, the statistics are gathered internally in the code page of the column's table, and will therefore use actual column values when applied during query optimization.
2. DISTCOUNT is collected only for columns that are the first key column in an index.

---

**SYSSTAT.COLGROUPDIST**

Each row represents the value of the column in a column group that makes up the  $n$ th most frequent value of the column group or the  $n$ th quantile value of the column group.

Table 143. SYSSTAT.COLGROUPDIST Catalog View

| Column Name | Data Type    | Nullable | Updat-<br>able | Description  |
|-------------|--------------|----------|----------------|--|
| COLGROUPID  | INTEGER      |          |                | Identifier for the column group.   |
| TYPE        | CHAR(1)      |          |                | F = Frequency value<br>Q = Quantile value  |
| ORDINAL     | SMALLINT     |          |                | Ordinal number of the column in the column group.  |
| SEQNO       | SMALLINT     |          |                | If TYPE = 'F', $n$ in this column identifies the $n$ th most frequent value. If TYPE = 'Q', $n$ in this column identifies the $n$ th quantile value. |
| COLVALUE    | VARCHAR(254) | Y        | Y              | Data value as a character literal or a null value.   |

---

**SYSSTAT.COLGROUPDISTCOUNTS**

Each row represents the distribution statistics that apply to the *n*th most frequent value of a column group or the *n*th quantile of a column group.

Table 144. SYSSTAT.COLGROUPDISTCOUNTS Catalog View

| Column Name | Data Type | Nullable | Updat-<br>able | Description  |
|-------------|-----------|----------|----------------|--|
| COLGROUPID  | INTEGER   |          |                | Identifier for the column group.   |
| TYPE        | CHAR(1)   |          |                | F = Frequency value<br>Q = Quantile value  |
| SEQNO       | SMALLINT  |          |                | Sequence number <i>n</i> representing the <i>n</i> th TYPE value.  |
| VALCOUNT    | BIGINT    |          | Y              | If TYPE = 'F', VALCOUNT is the number of occurrences of COLVALUE for the column group with this SEQNO. If TYPE = 'Q', VALCOUNT is the number of rows whose value is less than or equal to COLVALUE for the column group with this SEQNO. |
| DISTCOUNT   | BIGINT    | Y        | Y              | If TYPE = 'Q', this column records the number of distinct values that are less than or equal to COLVALUE for the column group with this SEQNO (null if unavailable).   |

---

## SYSSTAT.COLGROUPS

Each row represents a column group and statistics that apply to the entire column group.

Table 145. SYSSTAT.COLGROUPS Catalog View

| Column Name    | Data Type    | Nullable | Updat-<br>able | Description   |
|----------------|--------------|----------|----------------|---|
| COLGROUPSCHEMA | VARCHAR(128) |          |                | Schema name of the column group.                          |
| COLGROUPNAME   | VARCHAR(128) |          |                | Unqualified name of the column group.                     |
| COLGROUPID     | INTEGER      |          |                | Identifier for the column group.                          |
| COLGROUPCARD   | BIGINT       |          | Y              | Cardinality of the column group.                          |
| NUMFREQ_VALUES | SMALLINT     |          |                | Number of frequent values collected for the column group. |
| NUMQUANTILES   | SMALLINT     |          |                | Number of quantiles collected for the column group.       |

---

**SYSSTAT.COLUMNS**

Each row represents a column defined for a table, view, or nickname.

Table 146. SYSSTAT.COLUMNS Catalog View

| Column Name           | Data Type    | Nullable | Updat-<br>able | Description  |
|-----------------------|--------------|----------|----------------|--|
| TABSCHEMA             | VARCHAR(128) |          |                | Schema name of the table, view, or nickname that contains the column.  |
| TABNAME               | VARCHAR(128) |          |                | Unqualified name of the table, view, or nickname that contains the column.   |
| COLNAME               | VARCHAR(128) |          |                | Name of the column.  |
| COLCARD               | BIGINT       |          | Y              | Number of distinct values in the column; -1 if statistics are not collected; -2 for inherited columns and columns of hierarchy tables.   |
| HIGH2KEY <sup>1</sup> | VARCHAR(254) | Y        | Y              | Second-highest data value. Representation of numeric data changed to character literals. Empty if statistics are not collected. Empty for inherited columns and columns of hierarchy tables. |
| LOW2KEY <sup>1</sup>  | VARCHAR(254) | Y        | Y              | Second-lowest data value. Representation of numeric data changed to character literals. Empty if statistics are not collected. Empty for inherited columns and columns of hierarchy tables.  |
| AVGCOLLEN             | INTEGER      |          | Y              | Average space (in bytes) required for the column; -1 if a long field or LOB, or statistics have not been collected; -2 for inherited columns and columns of hierarchy tables.                |
| NUMNULLS              | BIGINT       |          | Y              | Number of null values in the column; -1 if statistics are not collected.   |
| SUB_COUNT             | SMALLINT     |          | Y              | Average number of sub-elements in the column. Applicable to character string columns only.   |
| SUB_DELIM_LENGTH      | SMALLINT     |          | Y              | Average length of the delimiters that separate each sub-element in the column. Applicable to character string columns only.  |

**Notes:**

1. In the catalog view, the values of HIGH2KEY and LOW2KEY are always shown in the database code page and can contain substitution characters. However, the statistics are gathered internally in the code page of the column's table, and will therefore use actual column values when applied during query optimization.



## SYSSTAT.INDEXES

Each row represents an index. Indexes on typed tables are represented by two rows: one for the “logical index” on the typed table, and one for the “H-index” on the hierarchy table.

Table 147. SYSSTAT.INDEXES Catalog View

| Column Name                | Data Type    | Nullable | Updat-able | Description   |
|----------------------------|--------------|----------|------------|---|
| INDSCHEMA                  | VARCHAR(128) |          |            | Schema name of the index.   |
| INDNAME                    | VARCHAR(128) |          |            | Unqualified name of the index.  |
| TABSCHEMA                  | VARCHAR(128) |          |            | Schema name of the table or nickname on which the index is defined.   |
| TABNAME                    | VARCHAR(128) |          |            | Unqualified name of the table or nickname on which the index is defined.  |
| COLNAMES                   | VARCHAR(640) |          |            | This column is no longer used and will be removed in the next release.  |
| NLEAF                      | BIGINT       |          | Y          | Number of leaf pages; -1 if statistics are not collected.   |
| NLEVELS                    | SMALLINT     |          | Y          | Number of index levels; -1 if statistics are not collected.   |
| FIRSTKEYCARD               | BIGINT       |          | Y          | Number of distinct first-key values; -1 if statistics are not collected.  |
| FIRST2KEYCARD              | BIGINT       |          | Y          | Number of distinct keys using the first two columns of the index; -1 if statistics are not collected, or if not applicable.   |
| FIRST3KEYCARD              | BIGINT       |          | Y          | Number of distinct keys using the first three columns of the index; -1 if statistics are not collected, or if not applicable.   |
| FIRST4KEYCARD              | BIGINT       |          | Y          | Number of distinct keys using the first four columns of the index; -1 if statistics are not collected, or if not applicable.  |
| FULLKEYCARD                | BIGINT       |          | Y          | Number of distinct full-key values; -1 if statistics are not collected.   |
| CLUSTERRATIO <sup>4</sup>  | SMALLINT     |          | Y          | Degree of data clustering with the index; -1 if statistics are not collected or if detailed index statistics are collected (in which case, CLUSTERFACTOR will be used instead). |
| CLUSTERFACTOR <sup>4</sup> | DOUBLE       |          | Y          | Finer measurement of the degree of clustering; -1 if statistics are not collected or if the index is defined on a nickname.   |
| SEQUENTIAL_PAGES           | BIGINT       |          | Y          | Number of leaf pages located on disk in index key order with few or no large gaps between them; -1 if statistics are not collected.   |

## SYSSTAT.INDEXES

Table 147. SYSSTAT.INDEXES Catalog View (continued)

| Column Name                                 | Data Type    | Nullable | Updat-able | Description  |
|---|--------------|----------|------------|--|
| DENSITY                                     | INTEGER      |          | Y          | Ratio of SEQUENTIAL_PAGES to number of pages in the range of pages occupied by the index, expressed as a percent (integer between 0 and 100); -1 if statistics are not collected.  |
| PAGE_FETCH_PAIRS <sup>4</sup>               | VARCHAR(520) |          | Y          | A list of pairs of integers, represented in character form. Each pair represents the number of pages in a hypothetical buffer, and the number of page fetches required to scan the table with this index using that hypothetical buffer. Zero-length string if no data is available. |
| NUMRIDS <sup>4</sup>                        | BIGINT       |          | Y          | Total number of row identifiers (RIDs) or block identifiers (BIDs) in the index; -1 if not known.  |
| NUMRIDS_DELETED <sup>4</sup>                | BIGINT       |          | Y          | Total number of row identifiers (or block identifiers) in the index that are marked deleted, excluding those identifiers on leaf pages on which all the identifiers are marked deleted.  |
| NUM_EMPTY_LEAFS                             | BIGINT       |          | Y          | Total number of index leaf pages that have all of their row identifiers (or block identifiers) marked deleted.   |
| AVERAGE_RANDOM_FETCH_PAGES <sup>1,2,4</sup> | DOUBLE       |          | Y          | Average number of random table pages between sequential page accesses when fetching using the index; -1 if not known.  |
| AVERAGE_RANDOM_PAGES <sup>2</sup>           | DOUBLE       |          | Y          | Average number of random table pages between sequential page accesses; -1 if not known.  |
| AVERAGE_SEQUENCE_GAP <sup>2</sup>           | DOUBLE       |          | Y          | Gap between index page sequences. Detected through a scan of index leaf pages, each gap represents the average number of index pages that must be randomly fetched between sequences of index pages; -1 if not known.  |
| AVERAGE_SEQUENCE_FETCH_GAP <sup>1,2,4</sup> | DOUBLE       |          | Y          | Gap between table page sequences when fetching using the index. Detected through a scan of index leaf pages, each gap represents the average number of table pages that must be randomly fetched between sequences of table pages; -1 if not known.                                  |
| AVERAGE_SEQUENCE_PAGES <sup>2</sup>         | DOUBLE       |          | Y          | Average number of index pages that are accessible in sequence (that is, the number of index pages that the prefetchers would detect as being in sequence); -1 if not known.  |

Table 147. SYSSTAT.INDEXES Catalog View (continued)

| Column Name                                   | Data Type    | Nullable | Updat-able | Description  |
|---|--------------|----------|------------|--|
| AVERAGE_SEQUENCE_FETCH_PAGES <sup>1,2,4</sup> | DOUBLE       |          | Y          | Average number of table pages that are accessible in sequence (that is, the number of table pages that the prefetchers would detect as being in sequence) when fetching using the index; -1 if not known.  |
| AVGPARTITION_CLUSTERRATIO <sup>3,4</sup>      | SMALLINT     |          | Y          | Degree of data clustering within a single data partition. -1 if the table is not partitioned, if statistics are not collected, or if detailed statistics are collected (in which case AVGPARTITION_CLUSTERFACTOR will be used instead).                                      |
| AVGPARTITION_CLUSTERFACTOR <sup>3,4</sup>     | DOUBLE       |          | Y          | Finer measurement of the degree of clustering within a single data partition. -1 if the table is not partitioned, if statistics are not collected, or if the index is defined on a nickname.   |
| AVGPARTITION_PAGE_FETCH_PAIRS <sup>3,4</sup>  | VARCHAR(520) |          | Y          | A list of paired integers in character form. Each pair represents a potential buffer pool size and the corresponding page fetches required to access a single data partition from the table. Zero-length string if no data is available, or if the table is not partitioned. |
| DATAPARTITION_CLUSTERFACTOR                   | DOUBLE       |          | Y          | A statistic measuring the "clustering" of the index keys with regard to data partitions. It is a number between 0 and 1, with 1 representing perfect clustering and 0 representing no clustering.  |
| INDCARD                                       | BIGINT       |          | Y          | Cardinality of the index. This might be different from the cardinality of the table for indexes that do not have a one-to-one relationship between the table rows and the index entries.   |

**Notes:**

1. When using DMS table spaces, this statistic cannot be computed.
2. Prefetch statistics are not gathered during a LOAD...STATISTICS YES, or a CREATE INDEX...COLLECT STATISTICS operation, or when the database configuration parameter *seqdetect* is turned off.
3. AVGPARTITION\_CLUSTERRATIO, AVGPARTITION\_CLUSTERFACTOR, and AVGPARTITION\_PAGE\_FETCH\_PAIRS measure the degree of clustering within a single data partition (local clustering). CLUSTERRATIO, CLUSTERFACTOR, and PAGE\_FETCH\_PAIRS measure the degree of clustering in the entire table (global clustering). Global clustering and local clustering values can diverge significantly if the table partitioning key is not a prefix of the index key, or when the table partitioning key and the index key are logically independent of each other.
4. This statistic cannot be updated if the index type is 'XPTH' (an XML path index).
5. Because logical indexes on an XML column do not have statistics, the SYSSTAT.INDEXES catalog view excludes rows whose index type is 'XVIL'.

---

**SYSSTAT.ROUTINES**

Each row represents a user-defined routine (scalar function, table function, sourced function, method, or procedure). Does not include built-in functions.

Table 148. SYSSTAT.ROUTINES Catalog View

| Column Name       | Data Type    | Nullable | Updat-able | Description   |
|-------------------|--------------|----------|------------|---|
| ROUTINESHEMA      | VARCHAR(128) |          |            | Schema name of the routine.   |
| ROUTINENAME       | VARCHAR(128) |          |            | Unqualified name of the routine.  |
| ROUTINETYPE       | CHAR(1)      |          |            | Type of routine.<br>F = Function<br>M = Method<br>P = Procedure   |
| SPECIFICNAME      | VARCHAR(128) |          |            | Name of the routine instance (might be system-generated).   |
| IOS_PER_INVOC     | DOUBLE       |          | Y          | Estimated number of inputs/outputs (I/Os) per invocation; 0 is the default; -1 if not known.                                |
| INSTS_PER_INVOC   | DOUBLE       |          | Y          | Estimated number of instructions per invocation; 450 is the default; -1 if not known.                                       |
| IOS_PER_ARGBYTE   | DOUBLE       |          | Y          | Estimated number of I/Os per input argument byte; 0 is the default; -1 if not known.  |
| INSTS_PER_ARGBYTE | DOUBLE       |          | Y          | Estimated number of instructions per input argument byte; 0 is the default; -1 if not known.                                |
| PERCENT_ARGBYTES  | SMALLINT     |          | Y          | Estimated average percent of input argument bytes that the routine will actually read; 100 is the default; -1 if not known. |
| INITIAL_IOS       | DOUBLE       |          | Y          | Estimated number of I/Os performed the first time that the routine is invoked; 0 is the default; -1 if not known.           |
| INITIAL_INSTS     | DOUBLE       |          | Y          | Estimated number of instructions executed the first time the routine is invoked; 0 is the default; -1 if not known.         |
| CARDINALITY       | BIGINT       |          | Y          | Predicted cardinality of a table function; -1 if not known, or if the routine is not a table function.                      |
| SELECTIVITY       | DOUBLE       |          | Y          | For user-defined predicates; -1 if there are no user-defined predicates.  |

## SYSSTAT.TABLES

Each row represents a table, view, alias, or nickname. Each table or view hierarchy has one additional row representing the hierarchy table or hierarchy view that implements the hierarchy. Catalog tables and views are included.

Table 149. SYSSTAT.TABLES Catalog View

| Column Name             | Data Type    | Nullable | Updat-able | Description  |
|-------------------------|--------------|----------|------------|--|
| TABSCHEMA               | VARCHAR(128) |          |            | Schema name of the object.   |
| TABNAME                 | VARCHAR(128) |          |            | Unqualified name of the object.  |
| CARD                    | BIGINT       |          | Y          | Total number of rows; -1 if statistics are not collected.  |
| NPAGES                  | BIGINT       |          | Y          | Total number of pages on which the rows of the table exist; -1 for a view or alias, or if statistics are not collected; -2 for a subtable or hierarchy table.  |
| FPAGES                  | BIGINT       |          | Y          | Total number of pages; -1 for a view or alias, or if statistics are not collected; -2 for a subtable or hierarchy table.   |
| OVERFLOW                | BIGINT       |          | Y          | Total number of overflow records in the table; -1 for a view or alias, or if statistics are not collected; -2 for a subtable or hierarchy table.   |
| CLUSTERED               | CHAR(1)      | Y        |            | Y = Table is multidimensionally clustered (even if only by one dimension)<br>Null value = Table is not multidimensionally clustered  |
| ACTIVE_BLOCKS           | BIGINT       |          | Y          | Total number of active blocks in the table, or -1. Applies to multidimensional clustering (MDC) tables only.   |
| AVGCOMPRESSEDROWSIZE    | SMALLINT     |          | Y          | Average length (in bytes) of compressed rows in this table; -1 if statistics are not collected.  |
| AVGROWCOMPRESSION-RATIO | REAL         |          | Y          | For compressed rows in the table, this is the average compression ratio by row; that is, the average uncompressed row length divided by the average compressed row length; -1 if statistics are not collected. |
| AVGROWSIZE              | SMALLINT     |          |            | Average length (in bytes) of both compressed and uncompressed rows in this table; -1 if statistics are not collected.  |
| PCTROWSCOMPRESSED       | REAL         |          | Y          | Compressed rows as a percentage of the total number of rows in the table; -1 if statistics are not collected.  |

## SYSSTAT.TABLES

Table 149. SYSSTAT.TABLES Catalog View (continued)

| Column Name   | Data Type | Nullable | Updat-<br>able | Description  |
|---------------|-----------|----------|----------------|--|
| PCTPAGESSAVED | SMALLINT  |          | Y              | Approximate percentage of pages saved in the table as a result of row compression. This value includes overhead bytes for each user data row in the table, but does not include the space that is consumed by dictionary overhead; -1 if statistics are not collected. |

---

## Appendix E. Federated systems

---

### Valid server types in SQL statements

Server types indicate the kind of data source that the server definition represents.

Server types vary by vendor, purpose, and operating system. Supported values depend on the wrapper being used.

For most data sources, you must specify a valid server type in the CREATE SERVER statement.

#### BioRS wrapper

A server type specification is optional for BioRS data sources.

| Server Type                                  | Data Source |
|--|-------------|
| Not required in the CREATE SERVER statement. | BioRS       |

#### BLAST wrapper

A server type specification is required for each type of BLAST search that you want to run for BLAST data sources supported by the BLAST daemon.

| Server Type | Data Source  |
|-------------|--|
| BLASTN      | BLAST searches in which a nucleotide sequence is compared with the contents of a nucleotide sequence database to find sequences with regions homologous to regions of the original sequence.   |
| BLASTP      | BLAST searches in which an amino acid sequence is compared with the contents of an amino acid sequence database to find sequences with regions homologous to regions of the original sequence. |
| BLASTX      | BLAST searches in which a nucleotide sequence is compared with the contents of an amino acid sequence database to find sequences with regions homologous to regions of the original sequence.  |
| TBLASTN     | BLAST searches in which an amino acid sequence is compared with the contents of a nucleotide sequence database to find sequences with regions homologous to regions of the original sequence.  |
| TBLASTX     | BLAST searches in which a nucleotide sequence is compared with the contents of a nucleotide sequence database to find sequences with regions homologous to regions of the original sequence.   |

## CTLIB wrapper

The CTLIB wrapper supports Sysbase data sources. A server type specification is required for Sybase data sources supported by the CTLIB client software.

| Server Type | Data Source |
|-------------|-------------|
| SYBASE      | Sybase      |

## DRDA wrapper

The DRDA wrapper is used for DB2 family data sources. A server type specification is required for the DB2 family data sources.

*Table 150. DB2 family data sources*

| Server Type | Data Source                                      |
|-------------|--|
| DB2/UIDB    | IBM DB2 Version 9.1 for Linux, UNIX, and Windows |
| DB2/ISERIES | IBM DB2 UDB for iSeries and AS/400               |
| DB2/ZOS     | IBM DB2 UDB for z/OS                             |
| DB2/VM      | IBM DB2 for VM                                   |

## Entrez wrapper

A server type specification is required for Entrez data sources.

| Server Type | Data Source |
|-------------|-------------|
| NUCLEOTIDE  | Entrez      |
| OMIM        | Entrez      |
| PUBMED      | Entrez      |

## Excel wrapper

A server type specification is not required for Excel data sources.

| Server Type                                  | Data Source     |
|--|-----------------|
| Not required in the CREATE SERVER statement. | Microsoft Excel |

## HMMER wrapper

A server type specification is required for each server that you want to run a HMMER search on for HMMER data sources supported by the HMMER daemon.

| Server Type | Data Source |
|-------------|-------------|
| PFAM        | HMMER       |
| SEARCH      | HMMER       |



## Informix wrapper

A server type specification is required for Informix data sources supported by Informix Client SDK software.

| Server Type | Data Source |
|-------------|-------------|
| INFORMIX    | Informix    |

## MSSQLODBC3 wrapper

A server type specification is required for Microsoft SQL Server data sources supported by the DataDirect Connect ODBC 4.2 (or later) driver or the Microsoft SQL Server ODBC 3.0 (or later) driver.

| Server Type | Data Source          |
|-------------|----------------------|
| MSSQLSERVER | Microsoft SQL Server |

## NET8 wrapper

A server type specification is required for Oracle data sources supported by Oracle NET8 client software.

| Server Type | Data Source                  |
|-------------|------------------------------|
| ORACLE      | Oracle Version 8.0. or later |

## ODBC wrapper

A server type specification is required for ODBC data sources supported by the ODBC 3.x driver.

| Server Type | Data Source |
|-------------|-------------|
| ODBC        | ODBC        |

## OLE DB wrapper

A server type definition is not required for OLE DB providers compliant with Microsoft OLE DB 2.0 or later.

| Server Type                                  | Data Source         |
|--|---------------------|
| Not required in the CREATE SERVER statement. | Any OLE DB provider |

## Table-structured files wrapper

A server type definition is not required for table-structured file data sources.

| Server Type                                  | Data Source            |
|--|------------------------|
| Not required in the CREATE SERVER statement. | Table-structured files |

## Teradata wrapper

A server type definition is required for Teradata data sources supported by the Teradata client software.

## Federated systems

| Server Type | Data Source |
|-------------|-------------|
| TERADATA    | Teradata    |

## Web services wrapper

A server type definition is not required for Web services data sources.

| Server Type                                  | Data Source                   |
|--|-------------------------------|
| Not required in the CREATE SERVER statement. | Any Web services data source. |

## WebSphere Business Integration wrapper

A server type definition is required for business application data sources supported by the WebSphere Business Integration wrapper.

| Server Type | Data Source                               |
|-------------|---|
| WBI         | WebSphere Business Integration 2.2 or 2.3 |

## XML wrapper

A server type definition is not required for XML data sources.

| Server Type                                  | Data Source |
|--|-------------|
| Not required in the CREATE SERVER statement. | XML         |

## Nickname column options for federated systems

You can specify column information in the CREATE NICKNAME or ALTER NICKNAME statements using parameters called nickname column options.

The following table lists the nickname column options for data source. Table two contains a complete listing of nickname column options.

Table 151. Nickname column options for relational data sources

| Data source                                  | DOCUMENT | ESCAPE_INPUT | FOREIGN_KEY | NUMERIC_STRING | PRIMARY_KEY | TEMPLATE | XPATH |
|--|----------|--------------|-------------|----------------|-------------|----------|-------|
| DB2 UDB for iSeries                          |          |              |             | X              |             |          |       |
| DB2 UDB for z/OS and OS/390                  |          |              |             | X              |             |          |       |
| DB2 for VM and VSE                           |          |              |             | X              |             |          |       |
| DB2 Version 9.1 for Linux, UNIX, and Windows |          |              |             | X              |             |          |       |
| Informix                                     |          |              |             | X              |             |          |       |

Table 151. Nickname column options for relational data sources (continued)

| Data source          | DOCUMENT | ESCAPE_INPUT | FOREIGN_KEY | NUMERIC_STRING | PRIMARY_KEY | TEMPLATE | XPATH |
|----------------------|----------|--------------|-------------|----------------|-------------|----------|-------|
| Microsoft SQL Server |          |              |             | X              |             |          |       |
| ODBC                 |          |              |             | X              |             |          |       |
| OLE DB               |          |              |             |                |             |          |       |
| Oracle               |          |              |             | X              |             |          |       |
| Sybase               |          |              |             | X              |             |          |       |
| Teradata             |          |              |             | X              |             |          |       |

Table 152. Nickname column options for nonrelational data sources

| Options            | BLAST | Script | Table-structured files | WebSphere Business Integration | Web services | XML |
|--------------------|-------|--------|------------------------|--------------------------------|--------------|-----|
| DELIMITER          | X     |        |                        |                                |              |     |
| DOCUMENT           |       |        | X                      |                                |              | X   |
| ESCAPE_INPUT       |       |        |                        | X                              | X            |     |
| FINAL_XDROPOFF     | X     |        |                        |                                |              |     |
| FOREIGN_KEY        |       |        |                        | X                              | X            | X   |
| INDEX              | X     |        |                        |                                |              |     |
| INPUT_MODE         |       | X      |                        |                                |              |     |
| MASK_LOWER_CASE    | X     |        |                        |                                |              |     |
| POSITION           |       | X      |                        |                                |              |     |
| PRIMARY_KEY        |       |        |                        | X                              | X            | X   |
| QUERY_GENETIC_CODE | X     |        |                        |                                |              |     |
| SWITCH             |       | X      |                        |                                |              |     |
| SWITCH_ONLY        |       | X      |                        |                                |              |     |
| TEMPLATE           |       |        |                        | X                              | X            |     |
| VALID_VALUES       |       | X      |                        |                                |              |     |
| XDROPOFF_GAPPED    | X     |        |                        |                                |              |     |
| XDROPOFF_UNGAPPED  | X     |        |                        |                                |              |     |
| XPATH              |       |        |                        | X                              | X            | X   |

## Federated systems

Table 153. Column options and their settings

| Option    | Description and valid settings   | Default setting                              |
|-----------|--|--|
| DEFAULT   | <p>Specifies a new default value for the following input fixed columns:</p> <ul style="list-style-type: none"><li>• E_value</li><li>• QueryStrands</li><li>• GapAlign</li><li>• NMisMatchPenalty</li><li>• NMatchReward</li><li>• Matrix</li><li>• FilterSequence</li><li>• NumberOfAlignments</li><li>• GapCost</li><li>• ExtendedGapCost</li><li>• WordSize</li><li>• ThresholdEx</li></ul> <p>This new value overrides the preset default values. The new default value must be of the same type as the indicated value for a given column.</p> |  |
| DELIMITER | <p>The delimiter characters to be used to determine the end point of the definition line information for the column on which this option appears. If more than one character appears in this option's value, then the first occurrence of any one of the characters signals the end of this field's information. The default is end of line. This option is required, unless you want the last specified column to contain the remainder of the definition line.</p>   | <p>The default delimiter is end of line.</p> |

Table 153. Column options and their settings (continued)

| Option   | Description and valid settings   | Default setting |
|----------|--|-----------------|
| DOCUMENT | <p data-bbox="488 254 1138 428">For table-structured files: Specifies the kind of table-structured file. This wrapper supports only the value FILE for this option. Only one column can be specified with the DOCUMENT option per nickname. The column that is associated with the DOCUMENT option must be a data type of VARCHAR or CHAR.</p> <p data-bbox="488 455 1138 653">Using the DOCUMENT nickname column option instead of the FILE_PATH nickname option implies that the file that corresponds to this nickname will be supplied when the query runs. If the DOCUMENT option has the FILE value, the value that is supplied when the query runs is the full path of the file whose schema matches the nickname definition for this nickname.</p> <p data-bbox="488 680 1138 968">For XML: Specifies that this column is a DOCUMENT column. The value of the DOCUMENT column indicates the type of XML source data that is supplied to the nickname when the query runs. This option is accepted only for columns of the root nickname (the nickname that identifies the elements at the top level of the XML document). Only one column can be specified with the DOCUMENT option per nickname. The column that is associated with the DOCUMENT option must be a VARCHAR data type.</p> <p data-bbox="488 995 1138 1108">If you use a DOCUMENT column option instead of the FILE_PATH or DIRECTORY_PATH nickname option the document that corresponds to this nickname is supplied when the query runs.</p> <p data-bbox="488 1136 1024 1163">The valid values for the DOCUMENT option are:</p> <p data-bbox="488 1178 1138 1268"><b>FILE</b> Specifies that the value of the nickname column is bound to the path name of a file. The data from this file is supplied when the query runs.</p> <p data-bbox="488 1283 1138 1577"><b>DIRECTORY</b><br/>Specifies that the value of the nickname column is bound to the path name of a directory that contains multiple XML data files. The XML data from multiple files is supplied when the query runs. The data is in XML files in the specified directory path. The XML wrapper uses only the files with an .xml extension that are located in the directory that you specify. The XML wrapper ignores all other files in this directory.</p> <p data-bbox="488 1591 1138 1705"><b>URI</b> Specifies that the value of the nickname column is bound to the path name of a remote XML file to which a URI refers. The URI address indicates the remote location of this XML file on the Web.</p> <p data-bbox="488 1732 1138 1808">The URI can contain a colon-separated IPv6 address if it is enclosed in square brackets (for example, http://[1080:0:0:0:8:800:200C:417A]).</p> <p data-bbox="488 1835 1138 1913"><b>COLUMN</b><br/>Specifies that the XML document is stored in a relational column.</p> |                 |

## Federated systems

Table 153. Column options and their settings (continued)

| Option         | Description and valid settings  | Default setting   |
|----------------|---|---|
| ELEMENT_NAME   | Specifies the BioRS element name. The case sensitivity of this name depends on the case sensitivity of the BioRS server and on the value of the CASE_SENSITIVE server option. You must specify the BioRS element name only if it is different from the column name.   |   |
| ESCAPE_INPUT   | <p>Specifies whether XML special characters are replaced in XML input values or not. Use this option to include XML fragments as input, such as XML fragments with repeating elements. The TEMPLATE column option must be defined on columns that use the ESCAPE_INPUT column option. The column data type must be VARCHAR or CHAR.</p> <p>Valid values are:</p> <p><b>Y</b> If the XML input contains special characters these are replaced with their counterpart characters that XML uses to represent the input characters.</p> <p><b>N</b> Input characters are preserved exactly as they appear.</p>  | Y   |
| FINAL_XDROPOFF | The X dropoff value for the final gapped alignment, measured in bits. The value 0 invokes the default behavior.   | 50 bits for blastn and megablast queries. 0 bits for tblastx queries. 25 bits (INTEGER data types) for all other query types. |
| FOREIGN_KEY    | <p>Indicates that this nickname is a child nickname and specifies the name of the corresponding parent nickname. A nickname can have at most one FOREIGN_KEY column option. The value for this option is case sensitive. The table that is designated with this option holds a key that is generated by the wrapper. The XPATH option must not be specified for this column. The column can be used only to join parent nicknames and child nicknames.</p> <p>A CREATE NICKNAME statement with a FOREIGN_KEY option will fail if the parent nickname has a different schema name.</p> <p>Unless the nickname that is referred to in a FOREIGN_KEY clause was explicitly defined as lowercase or mixed case by enclosing it in quotation marks in the corresponding CREATE NICKNAME statement, then when you refer to this nickname in the FOREIGN_KEY clause, you must specify the nickname in uppercase.</p> <p>When this option is set on a column, no other option can be set on the column.</p> |   |
| INDEX          | The ordinal number of the column on which this option appears in the group of definition line columns. This option is required.   |   |
| INPUT_MODE     | Specifies the input mode for a column. Valid values are CONFIG or FILE_INPUT. The wrapper passes the specified value to the script daemon.  |   |

Table 153. Column options and their settings (continued)

| Option             | Description and valid settings  | Default setting  |
|--------------------|---|--|
| IS_INDEXED         | Indicates whether the corresponding column is indexed (whether the column can be referenced in a predicate). The valid values are Y and N. The value Y can be specified only for columns whose corresponding element is indexed by the BioRS server.  | When a nickname is created, this option is automatically added with the value Y to any columns that correspond to a BioRS indexed element. |
| MASK_LOWER_CASE    | Use lowercase filtering with a FASTA sequence.  |  |
| NUMERIC_STRING     | <p>Specifies whether a column contains strings of numeric characters.</p> <p><b>Y</b> This column contains strings of numeric characters '0', '1', '2', .... '9'. It does not contain blanks. If this column contains only numeric strings followed by trailing blanks, do not specify Y.</p> <p>When you set NUMERIC_STRING to Y for a column, you are informing the optimizer that this column contains no blanks that could interfere with sorting of the column's data. Use this option when the collating sequence of a data source is different from the collating sequence that the federated server uses. Columns that use this option are not excluded from remote evaluation because of a different collating sequence.</p> <p><b>N</b> This column is either not a numeric string column or is a numeric string column that contains blanks.</p> | N  |
| POSITION           | An integer value for positional parameters. This option applies only to input columns. If the positional value is set to an integer, then this input must be in this position in the command line. If this option is set, the switch is inserted into the appropriate location when the query is run. If POSITION is set to -1, the option is added as the last command line option. POSITION integer values cannot be duplicated in a nickname. This option is not required.   |  |
| PRIMARY_KEY        | <p>Indicates that this nickname is a parent nickname. The column data type must be VARCHAR(16). A nickname can have at most one PRIMARY_KEY column option. YES is the only valid value. The column that is designated with this option holds a key that is generated by the wrapper. The XPATH option must not be specified for this column. The column can be used only to join parent nicknames and child nicknames.</p> <p>When this option is set on a column, no other option can be set on the column.</p>  |  |
| QUERY_GENETIC_CODE | Query genetic code uses default = 1.  |  |
| REFERENCED_OBJECT  | This option is valid only for columns whose BioRS data type is Reference. This option specifies the name of the BioRS databank that is referenced by the current column. The case sensitivity of this name depends on the case sensitivity of the BioRS server and on the value of the CASE_SENSITIVE server option.  |  |

## Federated systems

Table 153. Column options and their settings (continued)

| Option           | Description and valid settings   | Default setting |
|------------------|--|-----------------|
| SOAPACTIONCOLUMN | <p>A column to dynamically specify the URI SOAPACTION attribute from the Web Service Description Language (WSDL) format. This option is specified on only the root nickname.</p> <p>When this option is set on a column, no other option can be set on the column.</p> <p>The URL can contain a colon-separated IPv6 address if it is enclosed in square brackets (for example, <code>http://[1080:0:0:0:8:800:200C:417A]</code>).</p> |                 |
| SWITCH           | <p>A character string to specify a parameter for the script on the command line. This option applies only to input columns.</p>  |                 |
| SWITCH_ONLY      | <p>Enables the use of switches without a command line argument. If the SWITCH_ONLY option is specified with a value of Y, then valid input values are Y or N. For an input value of Y, only the switch is added to the command line. For an input value of N, no value is added to the command line.</p>   |                 |
| TEMPLATE         | <p>The column template fragment to use to construct the XML input document. The fragment must conform to the specified template syntax.</p>  |                 |
| URLCOLUMN        | <p>A column to dynamically specify the URL for the Web service endpoint when you run a query. This option is specified on only the root nickname.</p> <p>When this option is set on a column, no other option can be set on the column.</p> <p>The URL can contain a colon-separated IPv6 address if it is enclosed in square brackets (for example, <code>http://[1080:0:0:0:8:800:200C:417A]</code>).</p>                            |                 |
| VALID_VALUES     | <p>A semicolon-separated set of valid values for a column.</p>   |                 |



Table 153. Column options and their settings (continued)

| Option                     | Description and valid settings  | Default setting   |
|----------------------------|---|---|
| VARCHAR_NO_TRAILING_BLANKS | <p>This option applies to data sources that have variable character data types that do not pad the length with trailing blanks during comparison.</p> <p>Some data sources, such as Oracle, do not have blank-padded character comparison semantics that return the same results as the DB2 for Linux, UNIX, and Windows comparison semantics. Set this option when you want it to apply only to a specific VARCHAR or VARCHAR2 column in a data source object.</p> <p><b>Y</b> Trailing blanks are absent from these VARCHAR columns, or the data source has blank-padded character comparison semantics that are similar to the semantics on the federated server.</p> <p>The federated server sends character comparison operations to the data source for processing.</p> <p><b>N</b> Trailing blanks are present in these VARCHAR columns, and the data source has blank-padded character comparison semantics that are different than the federated server.</p> <p>The federated server processes character comparison operations if it is not possible to compensate for equivalent semantics. For example, rewriting the predicate.</p> | N for affected data sources   |
| XDROPOFF_GAPPED            | The X dropoff value for gapped alignment, measured in bits. The value 0 invokes the default behavior.   | 30 bits for blastn queries. 20 bits for megablast queries. 15 bits INTEGER data types) for all other query types. |
| XDROPOFF_UNGAPPED          | The X dropoff value for ungapped extension measured in bits. The value 0.0 invokes the default behavior. For blastn queries, the default is 20 bits. For megablast queries, the default is 10 bits. For all other query types, the default is 7 bits (REAL data types).   | 20 bits for blastn queries. 10 bits for megablast queries. 7 bits (REAL data types) for all other query types.    |
| XPATH                      | Specifies the XPath expression in the XML document that contains the data that corresponds to this column. The wrapper evaluates the XPath expression after the CREATE NICKNAME statement applies this XPath expression from this XPATH nickname option.  |   |

## Function mapping options for federated systems

The primary purpose of function mapping options, is to provide information about the potential cost of executing a data source function at the data source.

WebSphere Federation Server supplies default mappings between existing built-in data source functions and built-in DB2 functions. For most data sources, the default function mappings are in the wrappers. To use a data source function that the federated server does not recognize, you must create a function mapping between a data source function and a counterpart function at the federated database.

## Federated systems

Pushdown analysis determines if a function at the data source is able to execute a function in a query. The query optimizer decides if pushing down the function processing to the data source is the least cost alternative.

The statistical information provided in the function mapping definition helps the query optimizer compare the estimated cost of executing the data source function with the estimated cost of executing the DB2 function.

*Table 154. Function mapping options and their settings*

| Option            | Valid settings  | Default setting |
|-------------------|---|-----------------|
| DISABLE           | Disable a default function mapping. Valid values are 'Y' and 'N'.   | 'N'             |
| INITIAL_INSTS     | Estimated number of instructions processed the first and last time that the data source function is invoked.            | '0'             |
| INITIAL_IOS       | Estimated number of I/Os performed the first and last time that the data source function is invoked.                    | '0'             |
| IOS_PER_ARGBYTE   | Estimated number of I/Os expended for each byte of the argument set that's passed to the data source function.          | '0'             |
| IOS_PER_INVOC     | Estimated number of I/Os per invocation of a data source function.  | '0'             |
| INSTS_PER_ARGBYTE | Estimated number of instructions processed for each byte of the argument set that's passed to the data source function. | '0'             |
| INSTS_PER_INVOC   | Estimated number of instructions processed per invocation of the data source function.                                  | '450'           |
| PERCENT_ARGBYTES  | Estimated average percent of input argument bytes that the data source function will actually read.                     | '100'           |
| REMOTE_NAME       | Name of the data source function.   | local name      |

## Server options for federated systems

Server options are used to describe a data source server.

Server options specify data integrity, location, security, and performance information. Some server options are available for all data sources, and other server options are data source specific.

The common federated server options for relational data sources are:

- Compatibility options. COLLATING\_SEQUENCE, IGNORE\_UDT
- Data integrity options. IUD\_APP\_SVPT\_ENFORCE
- Data and time options. DATEFORMAT, TIMEFORMAT, TIMESTAMPFORMAT
- Location options. CONNECTSTRING, DBNAME, IFILE
- Security options. FOLD\_ID, FOLD\_PW, INFORMIX\_LOCK\_MODE
- Performance options. COMM\_RATE, CPU\_RATIO, DB2\_MAXIMAL\_PUSHDOWN, IO\_RATIO, LOGIN\_TIMEOUT, PACKET\_SIZE, PLAN\_HINTS, PUSHDOWN, TIMEOUT, VARCHAR\_NO\_TRAILING\_BLANKS

The following table lists the server definition server options applicable for each relational data source.

Table 155. Server options for relational data sources

| Data Source                      | C O D E P A G E | C O L L A T I N G | C O M M E N T S T R I N G | C O N V E R T I N G | C P U _ R A T I O | D A T E F O R M A T | D B 2 _ M A X I M A L _ P U N C T I O N | D B 2 _ P R E S E R V E _ C U R I O N | D B 2 _ T W O _ P H A S E _ C O M M A N D | D B 2 _ U M P L O G I N | D O L D _ I D | F O L D _ P W | I F I L E | I N F O R M I X _ C L I E N T _ L O C A L E | I N F O R M I X _ D B _ M O D E | I N F O R M I X _ L O C K _ M O D E | I O _ R A T I O | I U D _ A P P _ S V P T _ E N F O R C E | L O G I N _ T I M E O U T | N O D E | P A C K E T _ S I Z E | P A S S W O R D S | P L A N _ H I N T S | P U S H D O W N | T I M E F O R M A T | T I M E P F O R M A T | V A R C H A R _ N O _ T R A I L I N G _ B L A N K S |   |
|----------------------------------|-----------------|-------------------|---------------------------|---------------------|-------------------|---------------------|---|---------------------------------------|---|-------------------------|---------------|---------------|-----------|---|---------------------------------|-------------------------------------|-----------------|---|---------------------------|---------|-----------------------|-------------------|---------------------|-----------------|---------------------|-----------------------|---|---|
| DB2 UDB for iSeries              | X               | X                 |                           | X                   | X                 | X                   | X                                       | X                                     | X   | X                       | X             | X             |           |   |                                 | X                                   | X               |   |                           |         | X                     |                   | X                   |                 |                     |                       |   | X |
| DB2 UDB for z/OS and OS/390      |                 | X                 | X                         |                     | X                 | X                   | X                                       | X                                     | X   | X                       | X             | X             |           |   |                                 |                                     | X               | X                                       |                           |         |                       | X                 |                     | X               |                     |                       |   | X |
| DB2 for VM and VSE               |                 | X                 | X                         |                     | X                 | X                   | X                                       |                                       | X   | X                       | X             | X             |           |   |                                 |                                     | X               | X                                       |                           |         |                       | X                 |                     | X               |                     |                       |   | X |
| DB2 for Linux, UNIX, and Windows |                 | X                 | X                         |                     | X                 | X                   | X                                       | X                                     | X   | X                       | X             | X             |           |   |                                 |                                     | X               | X                                       |                           |         |                       | X                 |                     | X               |                     |                       |   | X |
| Informix                         |                 | X                 | X                         |                     | X                 | X                   | X                                       | X                                     | X   | X                       | X             | X             | X         | X   |                                 | X                                   | X               | X                                       |                           |         | X                     | X                 | X                   |                 |                     |                       |   |   |
| Microsoft SQL Server             | X               | X                 | X                         |                     | X                 | X                   | X                                       | X                                     | X   | X                       | X             | X             |           |   |                                 |                                     | X               | X                                       |                           |         | X                     | X                 | X                   |                 |                     |                       |   |   |
| ODBC                             | X               | X                 | X                         |                     | X                 | X                   | X                                       | X                                     |   | X                       | X             | X             |           |   |                                 |                                     | X               | X                                       |                           |         | X                     | X                 | X                   |                 | X                   | X                     | X   | X |
| OLE DB                           |                 | X                 |                           | X                   |                   |                     |   | X                                     |   |                         |               |               |           |   |                                 |                                     |                 |   |                           |         |                       |                   |                     |                 |                     |                       |   |   |
| Oracle                           |                 | X                 | X                         |                     | X                 | X                   | X                                       | X                                     |   | X                       | X             |               |           |   |                                 |                                     | X               |   |                           |         | X                     | X                 | X                   | X               | X                   |                       |   | X |
| Sybase                           |                 | X                 | X                         |                     | X                 | X                   | X                                       | X                                     | X   | X                       | X             | X             | X         |   |                                 |                                     | X               |   | X                         | X       | X                     | X                 | X                   | X               | X                   | X                     |   |   |
| Teradata                         |                 | X                 | X                         |                     | X                 | X                   | X                                       |                                       |   |                         |               |               |           |   |                                 |                                     | X               | X                                       |                           |         | X                     |                   |                     | X               |                     |                       |   |   |

## Federated systems

The following table lists the server definition server options applicable for each nonrelational data source, except WebSphere Business Integration. The server definition server options for WebSphere Business Integration are listed in Table 157 on page 751.

Table 156. Server options for nonrelational data sources.

| Data Source            | DAEMON-PORT | DB2-PLUGIN | MAXROWS | NODE | PROXY-AUTHID | PROXY-PASSWORD | PROXY-USERNAME | PROXY-PORT | PROXY-TYPE | SSL-CLIENT-CERTIFICATE-LABEL | SSL-KEYSTORE-FILE | SSL-KEYSTORE-PASSWORD | SSL-VERIFY-SERVER-CERTIFICATE | SOCKET-TIMEOUT | TIMEOUT | USE-CLOB-SEQUENCE |
|------------------------|-------------|------------|---------|------|--------------|----------------|----------------|------------|------------|------------------------------|-------------------|-----------------------|-------------------------------|----------------|---------|-------------------|
| BioRS                  |             | X          |         | X    |              |                |                |            | X          |                              |                   |                       |                               |                | X       |                   |
| BLAST                  | X           |            |         | X    | X            | X              | X              | X          | X          | X                            | X                 | X                     | X                             |                |         | X                 |
| Entrez                 |             |            | X       |      | X            | X              | X              | X          | X          |                              |                   |                       |                               | X              |         |                   |
| Excel                  |             |            |         |      |              |                |                |            |            |                              |                   |                       |                               |                |         |                   |
| HMMER                  | X           |            |         | X    | X            | X              | X              | X          | X          | X                            | X                 | X                     | X                             |                |         | X                 |
| SCRIPT                 | X           |            |         | X    | X            | X              | X              | X          | X          | X                            | X                 | X                     | X                             |                |         |                   |
| Table-structured files |             |            |         |      |              |                |                |            |            |                              |                   |                       |                               |                |         |                   |
| Web services           |             | X          |         |      |              |                |                |            |            | X                            | X                 | X                     | X                             |                | X       |                   |
| XML                    |             |            |         |      | X            | X              | X              | X          | X          | X                            | X                 | X                     | X                             | X              |         |                   |

The following table lists the server definition server options applicable for WebSphere Business Integration data sources.

Table 157. Server options for WebSphere Business Integration data sources.

| Data Source                    | APP<br>-<br>TYPE | FA<br>UL<br>T<br>-<br>Q<br>U<br>E<br>U<br>E | MQ<br>-<br>C<br>O<br>N<br>N<br>-<br>N<br>A<br>M<br>E | MQ<br>-<br>M<br>A<br>N<br>A<br>G<br>E<br>R | MQ<br>-<br>R<br>E<br>S<br>P<br>O<br>N<br>S<br>E<br>-<br>T<br>I<br>M<br>E<br>O<br>U<br>T | MQ<br>-<br>S<br>V<br>R<br>C<br>O<br>N<br>N<br>-<br>C<br>H<br>A<br>N<br>N<br>E<br>L<br>N<br>A<br>M<br>E | RE<br>QU<br>E<br>S<br>T<br>-<br>Q<br>U<br>E<br>U<br>E | RE<br>S<br>P<br>O<br>N<br>S<br>E<br>-<br>Q<br>U<br>E<br>U<br>E |
|--------------------------------|------------------|---|--|--|---|--|---|--|
| WebSphere Business Integration | X                | X   | X  | X  | X   | X  | X   | X  |

The following table describes each server option and lists the valid and default settings.

Table 158. Server options and their settings

| Option   | Description and valid settings  | Default setting |
|----------|---|-----------------|
| APP_TYPE | The type of remote application. Valid values are 'PSOFT', 'SAP', and 'SIEBEL'. This option is required. | None.           |

## Federated systems

Table 158. Server options and their settings (continued)

| Option         | Description and valid settings   | Default setting   |
|----------------|--|---|
| CASE_SENSITIVE | <p>Specifies whether the BioRS server treats names in a case sensitive manner. Valid values are Y or N.</p> <p>'Y' The BioRS server treats names in a case sensitive manner.</p> <p>'N' The BioRS server does not treat names in a case sensitive manner</p> <p>In the BioRS product, a configuration parameter controls the case sensitivity of the data that is stored on the BioRS server. The CASE_SENSITIVE option is the federated server counterpart to that BioRS system configuration parameter. You must synchronize the BioRS server case sensitivity configuration settings in your BioRS system and in the federated server. If you do not keep the case sensitivity configuration settings synchronized between BioRS and the federated server, errors will occur when you attempt to access BioRS data through federated server.</p> <p>You cannot change or delete the CASE_SENSITIVE option after you create a new BioRS server in federated server. If you need to change the CASE_SENSITIVE option, you must drop and then create the entire server again. If you drop the BioRS server, you must also create all of the corresponding BioRS nicknames again. Federated server automatically drops all nicknames that correspond to a dropped server.</p> | Y   |
| CODEPAGE       | <p>Specifies the DB2 code page identifier corresponding to the coded character set of the data source client configuration. You must specify the client's code page if the client's code page and the federated database code page do not match.</p> <p>For data sources that support Unicode, the CODEPAGE option can be set to the DB2 code page identifier corresponding to the supported Unicode encoding of the data source client.</p>   | <p>On UNIX or Windows systems with a non-Unicode federated database: The federated database code page.</p> <p>On UNIX systems with a Unicode federated database: 1208</p> <p>On Windows systems with a Unicode federated database: 1202</p> |

Table 158. Server options and their settings (continued)

| Option             | Description and valid settings  | Default setting |
|--------------------|---|-----------------|
| COLLATING_SEQUENCE | <p>Specifies whether the data source uses the same default collating sequence as the federated database, based on the NLS code set and the country/region information.</p> <p>'Y' The data source has the same collating sequence as the DB2 federated database.</p> <p>'N' The data source has a different collating sequence than the DB2 federated database collating sequence.</p> <p>'I' The data source has a different collating sequence than the DB2 federated database collating sequence, and the data source collating sequence is insensitive to case (for example, 'STEWART' and 'StewART' are considered equal).</p> | 'N'             |
| COMM_RATE          | <p>Specifies the communication rate between the federated server and the data source server. Expressed in megabytes per second.</p> <p>Valid values are greater than 0 and less than <math>1 \times 10^{23}</math>. Values can be expressed in any valid REAL notation.</p>   | '2'             |
| CONNECTSTRING      | Specifies initialization properties needed to connect to an OLE DB provider.  | None.           |
| CONNECTSTRING      | Specifies initialization properties needed to connect to an OLE DB provider.  | None.           |
| CONV_EMPTY_STRING  | Use for Sybase wrapper that works with replication tasks. When you set the CONV_EMPTY_STRING option into Y, the Sybase wrapper converts an empty string into a space. Set this option to Y when a source data server has a non-nullable character column that stores an empty string and the target data server is Sybase.  | N               |
| CPU_RATIO          | <p>Indicates how much faster or slower a data source CPU runs than the federated server CPU.</p> <p>Valid values are greater than 0 and less than <math>1 \times 10^{23}</math>. Values can be expressed in any valid REAL notation.</p> <p>A setting of 1 indicates that the DB2 federated CPU speed and the data source CPU speed have the same CPU speed, a 1:1 ratio. A setting of 0.5 indicates that the DB2 federated CPU speed is 50% slower than the data source CPU speed. A setting of 2 indicates that the DB2 federated CPU speed is twice as fast as the data source CPU speed.</p>                                    | '1.0'           |
| DATEFORMAT         | The date format used by the data source. Enter the format using 'DD', 'MM', and 'YY' or 'YYYY' to represent the numeric form of the date. You should also specify the delimiter such as a space or comma. For example, to represent the date format for '2003-01-01', use 'YYYY-MM-DD'. This field is nullable.   | None.           |

## Federated systems

Table 158. Server options and their settings (continued)

| Option                         | Description and valid settings  | Default setting            |
|--------------------------------|---|----------------------------|
| DAEMON_PORT                    | Specifies the port number on which the daemon will listen for BLAST or HMMER job requests. The port number must be the same number specified in the DAEMON_PORT option of the daemon configuration file.  | BLAST: 4007<br>HMMER: 4098 |
| DB2_MAXIMAL_PUSHDOWN           | Specifies the primary criteria that the query optimizer uses when choosing an access plan. The query optimizer can choose access plans based on cost or based on the user requirement that as much query processing as possible be performed by the remote data sources.<br><br><b>'Y'</b> The query optimizer chooses an access plan that pushes down more query operations to the data source than other plans. When several access plans provide the same amount of pushdown, the query optimizer then chooses the plan with the lowest cost.<br><br>If a materialized query table (MQT) on the federated server can process part or all of the query, then an access plan that includes the materialized query table might be used. The federated database does not push down queries that result in a Cartesian product.<br><br><b>'N'</b> The query optimizer chooses an access plan based on cost. | 'N'                        |
| DB2_PRESERVE_CUR_ON_CONNECTION | Specifies the behavior of cursors for committed or rolled back transactions. If value is set to Y, cursors can remain open on Microsoft SQL Server even if COMMIT or ROLLBACK is sent. If this option is not set or the value is set to N, cursors are closed if COMMIT or ROLLBACK is sent. This option is optional.   | None                       |
| DB2_TWO_PHASE_COMMIT           | Specify to allow or disallow federated two-phase commit for each data source using the CREATE SERVER or ALTER SERVER statements. Set to Y to configure and activate two-phase commit at the database level. Set to N to configure but not activate federated two-phase commit at the database level. Applications can activate or deactivate this option with the SET SERVER OPTION statement.  |                            |
| DB2_UM_PLUGIN                  | If you use a plugin for retrieving user mappings from an external repository, specify the class name including package (for example, 'com.ibm.ii.um.ldap.UserMappingRepository'). If you are using the Lightweight Directory Access Protocol (LDAP) sample plugin, you can use just the class name (for example, UserMappingRepository).  | None.                      |



Table 158. Server options and their settings (continued)

| Option  | Description and valid settings   | Default setting |
|---|--|-----------------|
| DBNAME  | Name of the data source database that you want the federated server to access. For DB2 database, this value corresponds to a specific database for the initial remote DB2 database connection. This specific database is the database alias for the remote DB2 database that is cataloged at the federated server using the CATALOG DATABASE command or the DB2 Configuration Assistant. Does not apply to Oracle data sources because Oracle instances contain only one database. Does not apply to Teradata.   | None.           |
| FAULT_QUEUE   | The name of the fault queue that delivers error messages from the adapter to the wrapper. The name must conform to the specifications for queue names for WebSphere MQ. This is a required option.   | None.           |
| FOLD_ID<br>(See notes 1 and 4 at the end of this table.)    | <p>Applies to user IDs that the federated server sends to the data source server for authentication. Valid values are:</p> <p><b>'U'</b> The federated server folds the user ID to uppercase before sending it to the data source. This is a logical choice for DB2 family and Oracle data sources (See note 2 at end of this table.)</p> <p><b>'N'</b> The federated server does nothing to the user ID before sending it to the data source. (See note 2 at end of this table.)</p> <p><b>'L'</b> The federated server folds the user ID to lowercase before sending it to the data source.</p> <p>If this option is not specified, the federated server tries to send the user ID to the data source in uppercase (unchanged) and in lowercase.</p> | None.           |
| FOLD_PW<br>(See notes 1, 3 and 4 at the end of this table.) | <p>Applies to passwords that the federated server sends to data sources for authentication. Valid values are:</p> <p><b>'U'</b> The federated server folds the password to uppercase before sending it to the data source. This is a logical choice for DB2 family and Oracle data sources.</p> <p><b>'N'</b> The federated server does nothing to the password before sending it to the data source.</p> <p><b>'L'</b> The federated server folds the password to lowercase before sending it to the data source.</p> <p>If this option is not specified, the federated server tries to send the user ID to the data source in uppercase (unchanged) and in lowercase.</p>  | None.           |

## Federated systems

Table 158. Server options and their settings (continued)

| Option                 | Description and valid settings  | Default setting |
|------------------------|---|-----------------|
| HMMPFAM_OPTIONS        | <p>Specifies hmmpfam options such as --null2, --pvm, and --xnu that have no corresponding column name in a reference table that maps options to column names.</p> <p>For example:</p> <pre>HMMPFAM_OPTIONS '--xnu --pvm'</pre> <p>In this example, the daemon runs the HMMPFAM program with options from the WHERE clause of the query, plus the additional options --xnu --pvm.</p>  |                 |
| HMMSEARCH_OPTIONS      | <p>Allows the user to provide additional command line options to the hmmsearch command. Only valid with type SEARCH. See the HMMER User's Guide for more information.</p>   | None.           |
| IFILE                  | <p>Use to specify the path and name of the Sybase Open Client interfaces file if you do not want to use the default interface file. On Windows NT<sup>®</sup> federated servers, the default is %SYBASE%\ini\sql.ini. On UNIX federated servers, the default is \$SYBASE%/interfaces.</p>   | None.           |
| INFORMIX_CLIENT_LOCALE | <p>Specifies the CLIENT_LOCALE to use for the connection between the federated server and the data source server. If the INFORMIX_CLIENT_LOCALE option is not specified, the Informix CLIENT_LOCALE environment variable is set to the value specified in the db2dj.ini file (if any). If db2dj.ini does not specify CLIENT_LOCALE, the Informix CLIENT_LOCALE environment variable is set to the Informix locale that most closely matches the code page and territory of the federated database. Any valid Informix locale is a valid value. This option is optional.</p> | None.           |
| INFORMIX_DB_LOCALE     | <p>Specifies the DB_LOCALE to use for the connection between the federated server and the data source server. If the INFORMIX_DB_LOCALE option is not specified, the Informix DB_LOCALE environment variable is set to the value specified in the db2dj.ini file (if any). If db2dj.ini does not specify DB_LOCALE, the Informix DB_LOCALE environment variable is not set. Any valid Informix locale is a valid value. This option is optional.</p>  | None.           |

Table 158. Server options and their settings (continued)

| Option             | Description and valid settings  | Default setting |
|--------------------|---|-----------------|
| INFORMIX_LOCK_MODE | <p>Specifies the lock mode to be set for an Informix data source. The Informix wrapper issues the 'SET LOCK MODE' command immediately after establishing the connection to an Informix data source. Valid values are:</p> <p>'W' Sets the Informix lock mode to WAIT. If the wrapper tries to access a locked table or row, Informix waits until the lock is released.</p> <p>'N' Sets the Informix lock mode to NOWAIT. If the wrapper tries to access a locked table or row, Informix returns an error.</p> <p>'n' Sets the Informix lock mode to WAIT <i>n</i> seconds. If the wrapper tries to access a locked table or row and the lock is not released within the specified number of seconds, Informix returns an error.</p> <p>If a deadlock or timeout error occurs when a federated server attempts to connect to an Informix data source, changing the lock mode setting on the federated server can often resolve the error. Use the ALTER SERVER statement to change the lock mode setting on the federated server.</p> <p>For example:</p> <pre>ALTER SERVER TYPE informix VERSION 9 WRAPPER informix   OPTIONS (ADD informix_lock_mode '60')</pre> | 'W'             |
| IO_RATIO           | <p>Denotes how much faster or slower a data source I/O system runs than the federated server I/O system.</p> <p>Valid values are greater than 0 and less than <math>1 \times 10^{23}</math>. Values can be expressed in any valid REAL notation.</p> <p>A setting of 1 indicates that the DB2 federated I/O speed and the data source I/O speed have the same I/O speed, a 1:1 ratio. A setting of .5 indicates that the DB2 federated I/O speed is 50% slower than the data source I/O speed. A setting of 2 indicates that the DB2 federated I/O speed is twice as fast as the data source I/O speed.</p>   | '1.0'           |

## Federated systems

Table 158. Server options and their settings (continued)

| Option               | Description and valid settings  | Default setting   |
|----------------------|---|---|
| IUD_APP_SVPT_ENFORCE | <p>Specifies whether the DB2 federated system should enforce detecting or building of application savepoint statements. When set using the SET SERVER OPTION statement, this server option will have no effect with static SQL statements.</p> <p><b>'Y'</b> The federated server rolls back insert, update, or delete transactions if an error occurs in an insert, update, or delete operation and the data source does not enforce application savepoint statements. SQL error code SQL1476N is returned.</p> <p><b>'N'</b> The federated server will not roll back transactions when an error is encountered. Your application must handle the error recovery.</p>  | 'Y'   |
| LOGIN_TIMEOUT        | Specifies the number of seconds for the DB2 federated server to wait for a response from Sybase Open Client to the login request. If you specify 0, the federated server will wait indefinitely for a response.   | '0'   |
| MAX_ROWS             | <p>For Entrez: Specifies the number of rows that the federated server returns for a query.</p> <p>For OMIM: Limits to the number of records for the root nickname that a query can return. For example, if the MAX_ROWS server option is set to 25, a maximum of 25 records for the root nickname and all of the records for the child-related nicknames are returned.</p> <p>You can specify only positive numbers and zero. When you set the option to be zero, you enable queries to retrieve an unlimited number of rows from the NCBI Web site. However, setting the MAX_ROWS server option to zero or to a very high number can impact your query performance.</p> <p>The MAX_ROWS server option is not required.</p> | <p>Microsoft Windows operating systems: 2000 rows.</p> <p>UNIX-based operating systems: 5000 rows.</p>  |
| MQ_CONN_NAME         | The hostname or network address of the computer where the Websphere MQ server is running. An example of a connection name is: 9.30.76.151(1420) where 1420 is the port number. If the port number is excluded a default value of 1414 will be used. This option is optional. If it is omitted, the MQSERVER environment variable (if specified in db2dj.ini file) is used to select the channel definition. If MQSERVER is not set, the client channel table is used.   | The wrapper uses the MQSERVER environment variable, if specified in the db2dj.ini file, to select the channel definition. If the MQSERVER environment variable is not set, the wrapper uses the client channel table. |
| MQ_MANAGER           | The name of the WebSphere MQ manager. Any valid WebSphere MQ manager name. This option is required.   | None.   |

Table 158. Server options and their settings (continued)

| Option                 | Description and valid settings   | Default setting    |
|------------------------|--|--------------------|
| MQ_RESPONSE_TIMEOUT    | The amount of time that the wrapper should wait for a response message from the response queue. The value is in milliseconds. You can specify a special value of -1 to indicate that there is no timeout period. This option is optional.  | 10000              |
| MQ_SVRCONN_CHANNELNAME | The name of the server-connection channel on the Websphere MQ Manager that the wrapper should try to connect to. This parameter can be specified only if the MQ_CONN_NAME server option is specified. The default server-connection channel, SYSTEM.DEF.SVRCONN, is used if this option is omitted.  | SYSTEM.DEF.SVRCONN |
| NODE                   | <p>Relational data sources: Name by which a data source is defined as an instance to its RDBMS.</p> <p>BLAST: Specifies the host name or IP address of the system on which the BLAST daemon process is running. The IP address can be an IPv4 address (for example, 192.168.1.1) or it can be a colon-separated IPv6 address (for example, 1080:0:0:0:8:800:200C:417A). This option is required.</p> <p>HMMER: Specifies the host name or IP address of the server on which the HMMER daemon process runs. The IP address can be an IPv4 address or it can be a colon-separated IPv6 address. This option is required.</p> <p>BioRS: Specifies the host name of the system on which the BioRS query tool is available. The IP address can be an IPv4 address or it can be a colon-separated IPv6 address. This option is optional.</p> | BioRS: localhost   |
| PACKET_SIZE            | Specifies the byte size of the packet that the Client-Library uses when sending special packets. If the Sybase wrapper needs to send or receive large amounts of text or image data, a larger packet size might improve efficiency.  |                    |
| PASSWORD               | <p>Specifies whether passwords are sent to a data source.</p> <p><b>'Y'</b> Passwords are sent to the data source and validated.</p> <p><b>'N'</b> Passwords are not sent to the data source and not validated.</p>  | 'Y'                |

## Federated systems

Table 158. Server options and their settings (continued)

| Option            | Description and valid settings  | Default setting |
|-------------------|---|-----------------|
| PLAN_HINTS        | <p>Specifies whether plan hints are to be enabled. Plan hints are statement fragments that provide extra information for data source optimizers. This information can, for certain query types, improve query performance. The plan hints can help the data source optimizer decide whether to use an index, which index to use, or which table join sequence to use.</p> <p><b>'Y'</b> Plan hints are to be enabled at the data source if the data source supports plan hints.</p> <p><b>'N'</b> Plan hints are not to be enabled at the data source.</p> <p>This option is only available for Oracle and Sybase data sources.</p> | 'N'             |
| PORT              | Specifies the number of the port the wrapper uses to connect to the BioRS server. This option is optional.  | '5014'          |
| PROCESSORS        | Specifies the number of processors that the HMMER program uses. This option is equivalent to the --cpu option of the hmmpfam command.   | None.           |
| PROXY_AUTHID      | Specifies the user name to use when the proxy server requires authentication. Contact your network administrator for the user name.   | None.           |
| PROXY_PASSWORD    | Specifies the password to use when the proxy server requires authentication. Contact your network administrator for the password.   | None.           |
| PROXY_SERVER_NAME | Specifies the proxy server name or the IP address. This field is required if the value of PROXY_TYPE is 'HTTP' or 'SOCKS'. Contact your network administrator for the server name or IP address of the proxy server. The IP address can be an IPv4 address (for example, 192.168.1.1) or it can be a colon-separated IPv6 address (for example, 1080:0:0:0:8:800:200C:417A).  | None.           |
| PROXY_SERVER_PORT | Specifies the proxy server port number. This field is required if the value of PROXY_TYPE is 'HTTP' or 'SOCKS'. Contact your network administrator for the port number of the proxy server.   | None.           |
| PROXY_TYPE        | <p>Specifies the type of proxy type that is used to access the Internet when behind a firewall. The valid values are 'NONE', 'HTTP', or 'SOCKS'. The default value is 'NONE'. Contact your network administrator for the type of proxy that is used.</p> <p>BLAST, HMMER, and SCRIPT do not support HTTP proxies.</p>   | 'NONE'          |

Table 158. Server options and their settings (continued)

| Option                        | Description and valid settings  | Default setting |
|-------------------------------|---|-----------------|
| PUSHDOWN                      | <p>'Y' DB2 will consider letting the data source evaluate operations.</p> <p>'N' DB2 will send the data source SQL statements that include only SELECT with column names. Predicates (such as WHERE=), column and scalar functions (such as MAX and MIN), sorts (such as ORDER BY or GROUP BY), and joins will not be included in any SQL sent to the data source.</p> <p>Default for the ODBC wrapper.</p> | 'Y'             |
| RESPONSE_QUEUE                | The name of the response queue that delivers query results from the adapter to the wrapper. The name must conform to the specifications for queue names for WebSphere MQ. This option is required.  | None.           |
| REQUEST_QUEUE                 | The name of the request queue that delivers query requests from the wrapper to the adapter. The name must conform to the specifications for queue names for WebSphere MQ. This option is required.  | None.           |
| SOCKET_TIMEOUT                | Specifies the maximum time in minutes that the DB2 federated server will wait for results from the proxy server. A valid value is any number that is greater than or equal to zero. The default is zero '0'. A value of zero denotes an unlimited amount of time to wait.   | 0               |
| SSL_CLIENT_CERTIFICATE_LABEL  | Specifies the client certificate that is sent during SSL authentication. If the value is not specified, the current DB2 authorization ID will be sent.  | None.           |
| SSL_KEYSTORE_FILE             | <p>Specifies the name of the certificate storage file to use for SSL/TLS communications. The value that you specify must be a full path that is accessible by the DB2 agent or FMP process.</p> <p>Optional: You can specify the value 'GSK_MS_CERTIFICATE_STORE' to use the native Microsoft certificate storage.</p>  | None.           |
| SSL_KEYSTORE_PASSWORD         | Specifies the password that is used to access the SSL certificate storage. This password is encrypted when it is stored in the DB2 catalog.   | None.           |
| SSL_VERIFY_SERVER_CERTIFICATE | Specifies if the server certificate should be verified during SSL authenticate. The values are not case sensitive. To authenticate, use one of the following values: 'Y', 'YES', 'T', or 'TRUE'. To disable, use 'F', 'FALSE', 'N', or 'NO'.  | 'NO'            |
| TIMEFORMAT                    | The time format used by the data source. Enter the format using 'hh12', 'hh24', 'mm', 'ss', 'AM', or 'A.M'. For example, to represent the time format of '16:00:00', use 'hh24:mm:ss'. To represent the time format of '8:00:00 AM', use 'hh12:mm:ss AM'. This field is nullable.   | None.           |

## Federated systems

Table 158. Server options and their settings (continued)

| Option            | Description and valid settings   | Default setting        |
|-------------------|--|------------------------|
| TIMESTAMPFORMAT   | The timestamp format used by the data source. The format follows that for date and time, plus 'n' for tenth of a second, 'nn' for hundredth of a second, 'nnn' for milliseconds, and so on, up to 'nnnnnn' for microseconds. For example, to represent the timestamp format of '2003-01-01-24:00:00.000000', use 'YYYY-MM-DD-hh24:mm:ss.nnnnnn'. This field is nullable.   | None.                  |
| TIMEOUT           | <p>The timeout value that you specify depends on which wrapper that you are using. If you specify 0, DB2 will wait indefinitely for a response.</p> <p>Sybase: Specifies the number of seconds that the DB2 federated server will wait for a response from the Sybase server for any SQL statement. The value of <i>seconds</i> is a positive whole number.</p> <p>BioRS: Specifies the time, in minutes, that the BioRS wrapper should wait for a response from the BioRS server. The default value is 10. This option is optional.</p> <p>Web services: Specifies the time, in minutes, that DB2 should wait for a network transfer and the computation of a result.</p> | Sybase: 0<br>BioRS: 10 |
| USE_CLOB_SEQUENCE | <p>This option specifies the data type the federated server uses for the BlastSeq or HmmQSeq column. The values can be 'Y' or 'N'. You can use the CREATE NICKNAME or ALTER NICKNAME statement. to override the default data type for the BlastSeq or HmmQSeq column.</p> <ul style="list-style-type: none"> <li>• If you specify a value of N, the data type is VARCHAR(32000).</li> <li>• If you specify a value of Y, the data type is CLOB(5M). The default value is N, not Y.</li> </ul>  | 'Y'                    |



Table 158. Server options and their settings (continued)

| Option                         | Description and valid settings   | Default setting              |
|--------------------------------|--|------------------------------|
| VARCHAR_NO_<br>TRAILING_BLANKS | <p>This option applies to data sources which have variable character data types that do not pad the length with trailing blanks during comparison.</p> <p>Some data sources, such as Oracle, do not have blank-padded character comparison semantics that return the same results as the DB2 for Linux, UNIX, and Windows comparison semantics. Set this option when you want it to apply to all the VARCHAR and VARCHAR2 columns in the data source objects that will be accessed from the designated server. This includes views.</p> <p><b>Y</b> Trailing blanks are absent from these VARCHAR columns, or the data source has blank-padded character comparison semantics that are similar to the semantics on the federated server.</p> <p>The federated server pushes down character comparison operations to the data source for processing.</p> <p><b>N</b> Trailing blanks are present in these VARCHAR columns and the data source has blank-padded character comparison semantics that are different than the federated server.</p> <p>The federated server processes character comparison operations if it is not possible to compensate for equivalent semantics. For example, rewriting the predicate.</p> | N for affected data sources. |

Notes on this table:

1. This field is applied regardless of the value specified for authentication.
2. Because DB2 stores user IDs in uppercase, the values 'N' and 'U' are logically equivalent to each other.
3. The setting for FOLD\_PW has no effect when the setting for password is 'N'. Because no password is sent, case cannot be a factor.
4. Avoid null settings for either of these options. A null setting can seem attractive because DB2 will make multiple attempts to resolve user IDs and passwords; however, performance might suffer (it is possible that DB2 will send a user ID and password up to nine times before successfully passing data source authentication).

## User mapping options for federated systems

These options are used with the CREATE USER MAPPING and ALTER USER MAPPING statements.

## Federated systems

Table 159. User mapping options and their settings

| Option                       | Valid settings  | Default setting  |
|------------------------------|---|--|
| ACCOUNTING                   | DRDA: Used to specify a DRDA accounting string. Valid settings include any string of length 255 or less. This option is required only if accounting information needs to be passed. See the DB2 Connect Users Guide for more information.   | None   |
| GUEST                        | Specifies if the wrapper is to use the guest access mode to the BioRS server.<br><br><b>Y</b> The wrapper uses the guest access mode to the BioRS server.<br><br><b>N</b> The wrapper does not use the guest access mode to the BioRS server.<br><br>When set to a value of Y, this option is mutually exclusive with the REMOTE_AUTHID option and the REMOTE_PASSWORD option.<br><br>Valid for the BioRS data source.  | N  |
| REMOTE_AUTHID                | Indicates the authorization ID used at the data source. Valid settings include any string of length 255 or less. Valid for the BioRS and Web services data sources.   | The authorization ID you use to connect to DB2.  |
| PROXY_AUTHID                 | Specifies the password to use when the proxy server requires authentication. Contact your network administrator for the password.<br><br>Valid for BioRS, Blast, Entrez, HMMER, Script, and Web services data sources.  |  |
| PROXY_PASSWORD               | Specifies the user name to use when the proxy server requires authentication. Contact your network administrator for the user name.<br><br>Valid for BioRS, Blast, Entrez, HMMER, Script, and Web services data sources.  |  |
| REMOTE_PASSWORD              | Indicates the authorization password used at the data source. Valid settings include any string of length 32 or less.<br><br>If your server requires a password and you do not set this option, you must ensure that the following conditions are met or the connection will fail: <ul style="list-style-type: none"> <li>• The database manager configuration parameter AUTHENTICATON is set to SERVER.</li> <li>• The server option PASSWORD is omitted or set to Y (the default).</li> <li>• When you connected to the DB2 database, you specified an authorization ID and password. The password that you specified must be the same as the password of your remote server.</li> </ul> Valid for the BioRS and Web services data sources. | The password you use to connect to the DB2 if both conditions listed in the valid settings column are met. |
| SSL_CLIENT_CERTIFICATE_LABEL | Specifies the client certificate that is sent during SSL authentication. If the value is not specified, the current DB2 authorization ID will be sent.<br><br>Valid for the Web services data source.   | None.  |

## Wrapper options for federated systems

Wrapper options are used to configure the wrapper or to define how the federated server uses the wrapper. Wrapper options can be set when you create or alter the wrapper.

All relational and nonrelational data sources use the DB2\_FENCED wrapper option. The ODBC and Teradata wrappers support the DB2\_SOURCE\_CLIENT\_MODE wrapper option. The Entrez data source uses the EMAIL wrapper option. The ODBC data source uses the MODULE wrapper option. BioRS, BLAST, Entrez, HMMER, web services, and XML data sources can use the wrapper options for proxies. The SSL options are supported by the BLAST, HMMER, SCRIPT, web services, and XML wrappers.

Table 160. Wrapper options and their settings

| Option                 | Valid settings   | Default setting   |
|------------------------|--|---|
| DB2_FENCED             | Specifies whether the wrapper runs in fenced or trusted mode.<br><br><b>Y</b> The wrapper runs in fenced mode.<br><br><b>N</b> The wrapper runs in trusted mode.   | Relational wrappers: N.<br><br>Nonrelational wrappers from IBM: N.<br><br>Nonrelational wrappers from third parties: Y. |
| DB2_SOURCE_CLIENT_MODE | Specifies that the data source client is 32-bit and that the database instance on the federated server is 64-bit. When you specify this option, you must also set the DB2_FENCED wrapper option to Y.<br><br>This option applies only to ODBC and Teradata data sources, and is currently supported only on AIX or Solaris operating systems.<br><br>The only valid value is 32BIT. The value is not case sensitive.<br><br><b>32BIT</b> The data source client that is installed on the federated server is 32-bit. | None.   |
| DB2_UM_PLUGIN          | If you use a plugin for retrieving user mappings from an external repository, specify the class name including package (for example, 'com.ibm.ii.um.Ildap.UserMappingRepository'). If you are using the Lightweight Directory Access Protocol (LDAP) sample plugin, you can use the class name (for example, UserMappingRepository).   | None.   |

## Federated systems

Table 160. Wrapper options and their settings (continued)

| Option            | Valid settings  | Default setting  |
|-------------------|---|--|
| EMAIL             | Specifies an e-mail address when you register the Entrez wrapper. This e-mail address is included with all queries and allows NCBI to contact you if there are problems, such as too many queries overloading the NCBI servers. This option is required.  |  |
| MODULE            | Specifies the full path of the library that contains the ODBC Driver Manager implementation or the SQL/CLI implementation. Required for the ODBC wrapper on UNIX federated servers.   | On Windows, the default value is <code>odbc32.dll</code> |
| PROXY_SERVER_NAME | Specifies the proxy server name or the IP address. This field is required if the value of <code>PROXY_TYPE</code> is 'HTTP' or 'SOCKS'. The IP address can be an IPv4 address (for example, 192.168.1.1) or it can be a colon-separated IPv6 address (for example, 1080:0:0:0:8:800:200C:417A). Contact your network administrator for the server name or IP address of the proxy server.                                       | None.  |
| PROXY_SERVER_PORT | Specifies the proxy server port number. This field is required if the value of <code>PROXY_TYPE</code> is 'HTTP' or 'SOCKS'. Contact your network administrator for the port number of the proxy server.<br><br>Specifying the <code>PROXY_SERVER_PORT</code> option in a <code>CREATE SERVER</code> statement overrides the <code>PROXY_SERVER_PORT</code> option in a <code>CREATE WRAPPER</code> statement overrides the the | None.  |
| PROXY_TYPE        | Specifies the type of proxy type that is used to access the Internet when behind a firewall. The valid values are 'NONE', 'HTTP', or 'SOCKS'. The default value is 'NONE'. Contact your network administrator for the type of proxy that is used.<br><br>The BLAST, HMMER, and SCRIPT wrappers do not support HTTP proxies.   | 'NONE'   |

Table 160. Wrapper options and their settings (continued)

| Option                        | Valid settings  | Default setting |
|-------------------------------|---|-----------------|
| SSL_KEYSTORE_FILE             | Specifies the name of the certificate storage file to use for SSL/TLS communications. The value that you specify must be a full path that is accessible by the DB2 agent or FMP process.<br><br>Optional: You can specify the value 'GSK_MS_CERTIFICATE_STORE' to use the native Microsoft certificate storage. | None.           |
| SSL_KEYSTORE_PASSWORD         | Specifies the password that is used to access the SSL certificate storage. This password is encrypted when it is stored in the DB2 catalog.   | None.           |
| SSL_VERIFY_SERVER_CERTIFICATE | Specifies if the server certificate should be verified during SSL authenticate. The values are not case sensitive. To authenticate, use one of the following values: 'Y', 'YES', 'T', or 'TRUE'. To disable, use 'F', 'FALSE', 'N', or 'NO'.  | 'NO'            |

## Default forward data type mappings

The two kinds of mappings between data source data types and federated database data types are forward type mappings and reverse type mappings. In a forward type mapping, the mapping is from a remote type to a comparable local type.

You can override a default type mapping, or create a new type mapping with the CREATE TYPE MAPPING statement.

These mappings are valid with all the supported versions, unless otherwise noted.

For all default forward data types mapping from a data source to the federated database, the federated schema is SYSIBM.

The following tables show the default forward mappings between federated database data types and data source data types.

## DB2 Database for Linux, UNIX, and Windows data sources

The following table lists the forward default data type mappings for DB2 Database for Linux, UNIX, and Windows data sources.

Table 161. DB2 Database for Linux, UNIX, and Windows forward default data type mappings (Not all columns shown)

| REMOTE_ TYPENAME | REMOTE_ LOWER_ LEN | REMOTE_ UPPER_LEN | REMOTE_ LOWER_ SCALE | REMOTE_ UPPER_ SCALE | REMOTE_ BIT_DATA | REMOTE_ DATA_ OPERATORS | FEDERATED_ TYPENAME | FEDERATED_ LENGTH | FEDERATED_ SCALE | FEDERATED_ BIT_DATA |
|------------------|--------------------|-------------------|----------------------|----------------------|------------------|-------------------------|---------------------|-------------------|------------------|---------------------|
| BIGINT           | -                  | -                 | -                    | -                    | -                | -                       | BIGINT              | -                 | 0                | -                   |
| BLOB             | -                  | -                 | -                    | -                    | -                | -                       | BLOB                | -                 | -                | -                   |
| CHAR             | -                  | -                 | -                    | -                    | -                | -                       | CHAR                | -                 | 0                | N                   |
| CHAR             | -                  | -                 | -                    | -                    | Y                | -                       | CHAR                | -                 | 0                | Y                   |
| CLOB             | -                  | -                 | -                    | -                    | -                | -                       | CLOB                | -                 | -                | -                   |

## Federated systems

Table 161. DB2 Database for Linux, UNIX, and Windows forward default data type mappings (Not all columns shown) (continued)

| REMOTE_TYPENAME | REMOTE_LOWER_LEN | REMOTE_UPPER_LEN | REMOTE_LOWER_SCALE | REMOTE_UPPER_SCALE | REMOTE_BIT_DATA | REMOTE_DATA_OPERATORS | FEDERATED_TYPENAME | FEDERATED_LENGTH | FEDERATED_SCALE | FEDERATED_BIT_DATA |
|-----------------|------------------|------------------|--------------------|--------------------|-----------------|-----------------------|--------------------|------------------|-----------------|--------------------|
| DATE            | -                | -                | -                  | -                  | -               | -                     | DATE               | -                | 0               | -                  |
| DBCLOB          | -                | -                | -                  | -                  | -               | -                     | DBCLOB             | -                | -               | -                  |
| DECIMAL         | -                | -                | -                  | -                  | -               | -                     | DECIMAL            | -                | -               | -                  |
| DOUBLE          | -                | -                | -                  | -                  | -               | -                     | DOUBLE             | -                | -               | -                  |
| FLOAT           | -                | -                | -                  | -                  | -               | -                     | DOUBLE             | -                | -               | -                  |
| GRAPHIC         | -                | -                | -                  | -                  | -               | -                     | GRAPHIC            | -                | 0               | N                  |
| INTEGER         | -                | -                | -                  | -                  | -               | -                     | INTEGER            | -                | 0               | -                  |
| LONGVAR         | -                | -                | -                  | -                  | N               | -                     | CLOB               | -                | -               | -                  |
| LONGVAR         | -                | -                | -                  | -                  | Y               | -                     | BLOB               | -                | -               | -                  |
| LONGVARG        | -                | -                | -                  | -                  | -               | -                     | DBCLOB             | -                | -               | -                  |
| REAL            | -                | -                | -                  | -                  | -               | -                     | REAL               | -                | -               | -                  |
| SMALLINT        | -                | -                | -                  | -                  | -               | -                     | SMALLINT           | -                | 0               | -                  |
| TIME            | -                | -                | -                  | -                  | -               | -                     | TIME               | -                | 0               | -                  |
| TIMESTAMP       | -                | -                | -                  | -                  | -               | -                     | TIMESTAMP          | -                | 0               | -                  |
| TIMESTMP        | -                | -                | -                  | -                  | -               | -                     | TIMESTAMP          | -                | 0               | -                  |
| VARCHAR         | -                | -                | -                  | -                  | -               | -                     | VARCHAR            | -                | 0               | N                  |
| VARCHAR         | -                | -                | -                  | -                  | Y               | -                     | VARCHAR            | -                | 0               | Y                  |
| VARGRAPH        | -                | -                | -                  | -                  | -               | -                     | VARGRAPHIC         | -                | 0               | N                  |
| VARGRAPHIC      | -                | -                | -                  | -                  | -               | -                     | VARGRAPHIC         | -                | 0               | N                  |

## DB2 for iSeries data sources

The following table lists the forward default data type mappings for DB2 for iSeries data sources.

Table 162. DB2 for iSeries forward default data type mappings (Not all columns shown)

| Remote Typename | Remote Lower Len | Remote Upper Len | Remote Lower Scale | Remote Upper Scale | Remote Bit Data | Remote Data Operators | Federated Typename | Federated Length | Federated Scale | Federated Bit Data |
|-----------------|------------------|------------------|--------------------|--------------------|-----------------|-----------------------|--------------------|------------------|-----------------|--------------------|
| BLOB            | -                | -                | -                  | -                  | -               | -                     | BLOB               | -                | -               | -                  |
| CHAR            | 1                | 254              | -                  | -                  | -               | -                     | CHAR               | -                | 0               | N                  |
| CHAR            | 255              | 32672            | -                  | -                  | -               | -                     | VARCHAR            | -                | 0               | N                  |
| CHAR            | 1                | 254              | -                  | -                  | Y               | -                     | CHAR               | -                | 0               | Y                  |
| CHAR            | 255              | 32672            | -                  | -                  | Y               | -                     | VARCHAR            | -                | 0               | Y                  |
| CLOB            | -                | -                | -                  | -                  | -               | -                     | CLOB               | -                | -               | -                  |
| DATE            | -                | -                | -                  | -                  | -               | -                     | DATE               | -                | 0               | -                  |
| DBCLOB          | -                | -                | -                  | -                  | -               | -                     | DBCLOB             | -                | -               | -                  |
| DECIMAL         | -                | -                | -                  | -                  | -               | -                     | DECIMAL            | -                | -               | -                  |
| FLOAT           | 4                | -                | -                  | -                  | -               | -                     | REAL               | -                | -               | -                  |
| FLOAT           | 8                | -                | -                  | -                  | -               | -                     | DOUBLE             | -                | -               | -                  |
| GRAPHIC         | 1                | 127              | -                  | -                  | -               | -                     | GRAPHIC            | -                | 0               | N                  |
| GRAPHIC         | 128              | 16336            | -                  | -                  | -               | -                     | VARGRAPHIC         | -                | 0               | N                  |
| INTEGER         | -                | -                | -                  | -                  | -               | -                     | INTEGER            | -                | 0               | -                  |
| NUMERIC         | -                | -                | -                  | -                  | -               | -                     | DECIMAL            | -                | -               | -                  |
| SMALLINT        | -                | -                | -                  | -                  | -               | -                     | SMALLINT           | -                | 0               | -                  |
| TIME            | -                | -                | -                  | -                  | -               | -                     | TIME               | -                | 0               | -                  |
| TIMESTAMP       | -                | -                | -                  | -                  | -               | -                     | TIMESTAMP          | -                | 0               | -                  |
| TIMESTMP        | -                | -                | -                  | -                  | -               | -                     | TIMESTAMP          | -                | 0               | -                  |
| VARCHAR         | 1                | 32672            | -                  | -                  | -               | -                     | VARCHAR            | -                | 0               | N                  |
| VARCHAR         | 1                | 32672            | -                  | -                  | Y               | -                     | VARCHAR            | -                | 0               | Y                  |
| VARG            | 1                | 16336            | -                  | -                  | -               | -                     | VARGRAPHIC         | -                | 0               | N                  |
| VARGRAPHIC      | 1                | 16336            | -                  | -                  | -               | -                     | VARGRAPHIC         | -                | 0               | N                  |

## DB2 for VM and VSE data sources

The following table lists the forward default data type mappings for DB2 for VM and VSE data sources.

Table 163. DB2 Server for VM and VSE forward default data type mappings (Not all columns shown)

| Remote Typename | Remote Lower Len | Remote Upper Len | Remote Lower Scale | Remote Upper Scale | Remote Bit Data | Remote Data Operators | Federated Typename | Federated Length | Federated Scale | Federated Bit Data |
|-----------------|------------------|------------------|--------------------|--------------------|-----------------|-----------------------|--------------------|------------------|-----------------|--------------------|
| BLOB            | -                | -                | -                  | -                  | -               | -                     | BLOB               | -                | -               | -                  |
| CHAR            | 1                | 254              | -                  | -                  | -               | -                     | CHAR               | -                | 0               | N                  |
| CHAR            | 1                | 254              | -                  | -                  | Y               | -                     | CHAR               | -                | 0               | Y                  |
| CLOB            | -                | -                | -                  | -                  | -               | -                     | CLOB               | -                | -               | -                  |
| DATE            | -                | -                | -                  | -                  | -               | -                     | DATE               | -                | 0               | -                  |
| DBAHW           | -                | -                | -                  | -                  | -               | -                     | SMALLINT           | -                | 0               | -                  |
| DBAINT          | -                | -                | -                  | -                  | -               | -                     | INTEGER            | -                | 0               | -                  |
| DBCLOB          | -                | -                | -                  | -                  | -               | -                     | DBCLOB             | -                | -               | -                  |
| DECIMAL         | -                | -                | -                  | -                  | -               | -                     | DECIMAL            | -                | -               | -                  |
| FLOAT           | 4                | -                | -                  | -                  | -               | -                     | REAL               | -                | -               | -                  |
| FLOAT           | 8                | -                | -                  | -                  | -               | -                     | DOUBLE             | -                | -               | -                  |
| GRAPHIC         | 1                | 127              | -                  | -                  | -               | -                     | GRAPHIC            | -                | 0               | N                  |
| INTEGER         | -                | -                | -                  | -                  | -               | -                     | INTEGER            | -                | -               | -                  |
| SMALLINT        | -                | -                | -                  | -                  | -               | -                     | SMALLINT           | -                | -               | -                  |
| TIME            | -                | -                | -                  | -                  | -               | -                     | TIME               | -                | 0               | -                  |
| TIMESTAMP       | -                | -                | -                  | -                  | -               | -                     | TIMESTAMP          | -                | 0               | -                  |
| TIMESTMP        | -                | -                | -                  | -                  | -               | -                     | TIMESTAMP          | -                | 0               | -                  |
| VARCHAR         | 1                | 32672            | -                  | -                  | -               | -                     | VARCHAR            | -                | 0               | N                  |
| VARCHAR         | 1                | 32672            | -                  | -                  | Y               | -                     | VARCHAR            | -                | 0               | Y                  |
| VARGRAPHIC      | 1                | 16336            | -                  | -                  | -               | -                     | VARGRAPHIC         | -                | 0               | N                  |
| VARGRAPH        | 1                | 16336            | -                  | -                  | -               | -                     | VARGRAPHIC         | -                | 0               | N                  |

## DB2 for z/OS data sources

The following table lists the forward default data type mappings for DB2 for z/OS data sources.

Table 164. DB2 for z/OS forward default data type mappings (Not all columns shown)

| Remote Typename | Remote Lower Len | Remote Upper Len | Remote Lower Scale | Remote Upper Scale | Remote Bit Data | Remote Data Operators | Federated Typename | Federated Length | Federated Scale | Federated Bit Data |
|-----------------|------------------|------------------|--------------------|--------------------|-----------------|-----------------------|--------------------|------------------|-----------------|--------------------|
| BLOB            | -                | -                | -                  | -                  | -               | -                     | BLOB               | -                | -               | -                  |
| CHAR            | 1                | 254              | -                  | -                  | -               | -                     | CHAR               | -                | 0               | N                  |
| CHAR            | 255              | 32672            | -                  | -                  | -               | -                     | VARCHAR            | -                | 0               | N                  |
| CHAR            | 1                | 254              | -                  | -                  | Y               | -                     | CHAR               | -                | 0               | Y                  |
| CHAR            | 255              | 32672            | -                  | -                  | Y               | -                     | VARCHAR            | -                | 0               | Y                  |
| CLOB            | -                | -                | -                  | -                  | -               | -                     | CLOB               | -                | -               | -                  |
| DATE            | -                | -                | -                  | -                  | -               | -                     | DATE               | -                | 0               | -                  |
| DBCLOB          | -                | -                | -                  | -                  | -               | -                     | DBCLOB             | -                | -               | -                  |
| DECIMAL         | -                | -                | -                  | -                  | -               | -                     | DECIMAL            | -                | -               | -                  |
| FLOAT           | 4                | -                | -                  | -                  | -               | -                     | REAL               | -                | -               | -                  |
| FLOAT           | 8                | -                | -                  | -                  | -               | -                     | DOUBLE             | -                | -               | -                  |
| GRAPHIC         | 1                | 127              | -                  | -                  | -               | -                     | GRAPHIC            | -                | 0               | N                  |
| INTEGER         | -                | -                | -                  | -                  | -               | -                     | INTEGER            | -                | 0               | -                  |
| ROWID           | -                | -                | -                  | -                  | Y               | -                     | VARCHAR            | 40               | -               | Y                  |
| SMALLINT        | -                | -                | -                  | -                  | -               | -                     | SMALLINT           | -                | 0               | -                  |
| TIME            | -                | -                | -                  | -                  | -               | -                     | TIME               | -                | 0               | -                  |
| TIMESTAMP       | -                | -                | -                  | -                  | -               | -                     | TIMESTAMP          | -                | 0               | -                  |
| TIMESTMP        | -                | -                | -                  | -                  | -               | -                     | TIMESTAMP          | -                | 0               | -                  |
| VARCHAR         | 1                | 32672            | -                  | -                  | -               | -                     | VARCHAR            | -                | 0               | N                  |
| VARCHAR         | 1                | 32672            | -                  | -                  | Y               | -                     | VARCHAR            | -                | 0               | Y                  |
| VARG            | 1                | 16336            | -                  | -                  | -               | -                     | VARGRAPHIC         | -                | 0               | N                  |
| VARGRAPHIC      | 1                | 16336            | -                  | -                  | -               | -                     | VARGRAPHIC         | -                | 0               | N                  |

## Informix data sources

The following table lists the forward default data type mappings for Informix data sources.

## Federated systems

Table 165. Informix forward default data type mappings (Not all columns shown)

| Remote Typename | Remote Lower Len | Remote Upper Len | Remote Lower Scale | Remote Upper Scale | Remote Bit Data | Remote Data Operators | Federated Typename | Federated Length | Federated Scale | Federated Bit Data |
|-----------------|------------------|------------------|--------------------|--------------------|-----------------|-----------------------|--------------------|------------------|-----------------|--------------------|
| BLOB            | -                | -                | -                  | -                  | -               | -                     | BLOB               | 2147483647       | -               | -                  |
| BOOLEAN         | -                | -                | -                  | -                  | -               | -                     | CHARACTER          | 1                | -               | -                  |
| BYTE            | -                | -                | -                  | -                  | -               | -                     | BLOB               | 2147483647       | -               | -                  |
| CHAR            | 1                | 254              | -                  | -                  | -               | -                     | CHARACTER          | -                | -               | -                  |
| CHAR            | 255              | 32672            | -                  | -                  | -               | -                     | VARCHAR            | -                | -               | -                  |
| CLOB            | -                | -                | -                  | -                  | -               | -                     | CLOB               | 2147483647       | -               | -                  |
| DATE            | -                | -                | -                  | -                  | -               | -                     | DATE               | 4                | -               | -                  |
| DATETIME        | 0                | 4                | 0                  | 4                  | -               | -                     | DATE               | 4                | -               | -                  |
| DATETIME        | 6                | 10               | 6                  | 10                 | -               | -                     | TIME               | 3                | -               | -                  |
| DATETIME        | 0                | 4                | 6                  | 15                 | -               | -                     | TIMESTAMP          | 10               | -               | -                  |
| DATETIME        | 6                | 10               | 11                 | 15                 | -               | -                     | TIMESTAMP          | 10               | -               | -                  |
| DECIMAL         | 1                | 31               | 0                  | 31                 | -               | -                     | DECIMAL            | -                | -               | -                  |
| DECIMAL         | 32               | 130              | -                  | -                  | -               | -                     | DOUBLE             | 8                | -               | -                  |
| FLOAT           | -                | -                | -                  | -                  | -               | -                     | DOUBLE             | 8                | -               | -                  |
| INTEGER         | -                | -                | -                  | -                  | -               | -                     | INTEGER            | 4                | -               | -                  |
| INTERVAL        | -                | -                | -                  | -                  | -               | -                     | VARCHAR            | 25               | -               | -                  |
| INT8            | -                | -                | -                  | -                  | -               | -                     | BIGINT             | 19               | 0               | -                  |
| LVARCHAR        | 1                | 32672            | -                  | -                  | -               | -                     | VARCHAR            | -                | -               | -                  |
| MONEY           | 1                | 31               | 0                  | 31                 | -               | -                     | DECIMAL            | -                | -               | -                  |
| MONEY           | 32               | 32               | -                  | -                  | -               | -                     | DOUBLE             | 8                | -               | -                  |
| NCHAR           | 1                | 254              | -                  | -                  | -               | -                     | CHARACTER          | -                | -               | -                  |
| NCHAR           | 255              | 32672            | -                  | -                  | -               | -                     | VARCHAR            | -                | -               | -                  |
| NVARCHAR        | 1                | 32672            | -                  | -                  | -               | -                     | VARCHAR            | -                | -               | -                  |
| REAL            | -                | -                | -                  | -                  | -               | -                     | REAL               | 4                | -               | -                  |
| SERIAL          | -                | -                | -                  | -                  | -               | -                     | INTEGER            | 4                | -               | -                  |
| SERIAL8         | -                | -                | -                  | -                  | -               | -                     | BIGINT             | -                | -               | -                  |
| SMALLFLOAT      | -                | -                | -                  | -                  | -               | -                     | REAL               | 4                | -               | -                  |
| SMALLINT        | -                | -                | -                  | -                  | -               | -                     | SMALLINT           | 2                | -               | -                  |
| TEXT            | -                | -                | -                  | -                  | -               | -                     | CLOB               | 2147483647       | -               | -                  |
| VARCHAR         | 1                | 32672            | -                  | -                  | -               | -                     | VARCHAR            | -                | -               | -                  |

### Notes:

- For the Informix DATETIME data type, the DB2 UNIX and Windows federated server uses the Informix high-level qualifier as the REMOTE\_LENGTH and the Informix low-level qualifier as the REMOTE\_SCALE.

The Informix qualifiers are the "TU\_" constants defined in the Informix Client SDK `datatime.h` file. The constants are:

|           |                  |                  |
|-----------|------------------|------------------|
| 0 = YEAR  | 8 = MINUTE       | 13 = FRACTION(3) |
| 2 = MONTH | 10 = SECOND      | 14 = FRACTION(4) |
| 4 = DAY   | 11 = FRACTION(1) | 15 = FRACTION(5) |
| 6 = HOUR  | 12 = FRACTION(2) |                  |

## Microsoft SQL Server data sources

The following table lists the forward default data type mappings for Microsoft SQL Server data sources.

Table 166. Microsoft SQL Server forward default data type mappings

| Remote Typename     | Remote Lower Len | Remote Upper Len | Remote Lower Scale | Remote Upper Scale | Remote Bit Data | Remote Data Operators | Federated Typename | Federated Length | Federated Scale | Federated Bit Data |
|---------------------|------------------|------------------|--------------------|--------------------|-----------------|-----------------------|--------------------|------------------|-----------------|--------------------|
| bigint <sup>2</sup> | -                | -                | -                  | -                  | -               | -                     | BIGINT             | -                | -               | -                  |
| binary              | 1                | 254              | -                  | -                  | -               | -                     | CHARACTER          | -                | -               | Y                  |
| binary              | 255              | 8000             | -                  | -                  | -               | -                     | VARCHAR            | -                | -               | Y                  |
| bit                 | -                | -                | -                  | -                  | -               | -                     | SMALLINT           | 2                | -               | -                  |
| char                | 1                | 254              | -                  | -                  | -               | -                     | CHAR               | -                | -               | N                  |
| char                | 255              | 8000             | -                  | -                  | -               | -                     | VARCHAR            | -                | -               | N                  |
| datetime            | -                | -                | -                  | -                  | -               | -                     | TIMESTAMP          | 10               | -               | -                  |
| datetimen           | -                | -                | -                  | -                  | -               | -                     | TIMESTAMP          | 10               | -               | -                  |
| decimal             | 1                | 31               | 0                  | 31                 | -               | -                     | DECIMAL            | -                | -               | -                  |
| decimal             | 32               | 38               | 0                  | 38                 | -               | -                     | DOUBLE             | -                | -               | -                  |



Table 166. Microsoft SQL Server forward default data type mappings (continued)

| Remote Typename    | Remote Lower Len | Remote Upper Len | Remote Lower Scale | Remote Upper Scale | Remote Bit Data | Remote Data Operators | Federated Typename | Federated Length | Federated Scale | Federated Bit Data |
|--------------------|------------------|------------------|--------------------|--------------------|-----------------|-----------------------|--------------------|------------------|-----------------|--------------------|
| decimaln           | 1                | 31               | 0                  | 31                 | -               | -                     | DECIMAL            | -                | -               | -                  |
| decimaln           | 32               | 38               | 0                  | 38                 | -               | -                     | DOUBLE             | -                | -               | -                  |
| DUMMY2000<br>1     | 1                | 38               | -84                | 127                | -               | -                     | DOUBLE             | -                | -               | -                  |
| float              | -                | 8                | -                  | -                  | -               | -                     | DOUBLE             | 8                | -               | -                  |
| floatn             | -                | 8                | -                  | -                  | -               | -                     | DOUBLE             | 8                | -               | -                  |
| float              | -                | 4                | -                  | -                  | -               | -                     | REAL               | 4                | -               | -                  |
| floatn             | -                | 4                | -                  | -                  | -               | -                     | REAL               | 4                | -               | -                  |
| image              | -                | -                | -                  | -                  | -               | -                     | BLOB               | 2147483647       | -               | Y                  |
| int                | -                | -                | -                  | -                  | -               | -                     | INTEGER            | 4                | -               | -                  |
| intn               | -                | -                | -                  | -                  | -               | -                     | INTEGER            | 4                | -               | -                  |
| money              | -                | -                | -                  | -                  | -               | -                     | DECIMAL            | 19               | 4               | -                  |
| moneyn             | -                | -                | -                  | -                  | -               | -                     | DECIMAL            | 19               | 4               | -                  |
| nchar              | 1                | 127              | -                  | -                  | -               | -                     | CHAR               | -                | -               | N                  |
| nchar              | 128              | 4000             | -                  | -                  | -               | -                     | VARCHAR            | -                | -               | N                  |
| numeric            | 1                | 31               | 0                  | 31                 | -               | -                     | DECIMAL            | -                | -               | -                  |
| numeric            | 32               | 38               | 0                  | 38                 | -               | -                     | DOUBLE             | 8                | -               | -                  |
| numericn           | 32               | 38               | 0                  | 38                 | -               | -                     | DOUBLE             | -                | -               | -                  |
| numericn           | 1                | 31               | 0                  | 31                 | -               | -                     | DECIMAL            | -                | -               | -                  |
| ntext              | -                | -                | -                  | -                  | -               | -                     | CLOB               | 2147483647       | -               | Y                  |
| nvarchar           | 1                | 4000             | -                  | -                  | -               | -                     | VARCHAR            | -                | -               | N                  |
| real               | -                | -                | -                  | -                  | -               | -                     | REAL               | 4                | -               | -                  |
| smallint           | -                | -                | -                  | -                  | -               | -                     | SMALLINT           | 2                | -               | -                  |
| smalldatetime      | -                | -                | -                  | -                  | -               | -                     | TIMESTAMP          | 10               | -               | -                  |
| smallmoney         | -                | -                | -                  | -                  | -               | -                     | DECIMAL            | 10               | 4               | -                  |
| smallmoneyn        | -                | -                | -                  | -                  | -               | -                     | DECIMAL            | 10               | 4               | -                  |
| SQL_BIGINT         | -                | -                | -                  | -                  | -               | -                     | DECIMAL            | -                | -               | -                  |
| SQL_BIGINT<br>2    | -                | -                | -                  | -                  | -               | -                     | BIGINT             | -                | -               | -                  |
| SQL_BINARY         | 1                | 254              | -                  | -                  | -               | -                     | CHARACTER          | -                | -               | Y                  |
| SQL_BINARY         | 255              | 8000             | -                  | -                  | -               | -                     | VARCHAR            | -                | -               | Y                  |
| SQL_BIT            | -                | -                | -                  | -                  | -               | -                     | SMALLINT           | 2                | -               | -                  |
| SQL_CHAR           | 1                | 254              | -                  | -                  | -               | -                     | CHAR               | -                | -               | N                  |
| SQL_CHAR           | 255              | 8000             | -                  | -                  | -               | -                     | VARCHAR            | -                | -               | N                  |
| SQL_DATE           | -                | -                | -                  | -                  | -               | -                     | DATE               | 4                | -               | -                  |
| SQL_DECIMAL        | 1                | 31               | 0                  | 31                 | -               | -                     | DECIMAL            | -                | -               | -                  |
| SQL_DECIMAL        | 32               | 38               | 0                  | 38                 | -               | -                     | DOUBLE             | 8                | -               | -                  |
| SQL_DECIMAL        | 32               | 32               | 0                  | 31                 | -               | -                     | DOUBLE             | 8                | -               | -                  |
| SQL_DOUBLE         | -                | -                | -                  | -                  | -               | -                     | DOUBLE             | 8                | -               | -                  |
| SQL_FLOAT          | -                | -                | -                  | -                  | -               | -                     | DOUBLE             | 8                | -               | -                  |
| SQL_GUID           | 1                | 4000             | -                  | -                  | Y               | -                     | VARCHAR            | 16               | -               | Y                  |
| SQL_INTEGER        | -                | -                | -                  | -                  | -               | -                     | INTEGER            | 4                | -               | -                  |
| SQL_LONG-VARCHAR   | -                | -                | -                  | -                  | -               | -                     | CLOB               | 2147483647       | -               | N                  |
| SQL_LONG-VARBINARY | -                | -                | -                  | -                  | -               | -                     | BLOB               | -                | -               | Y                  |
| SQL_NUMERIC        | 1                | 31               | 0                  | 31                 | -               | -                     | DECIMAL            | -                | -               | -                  |
| SQL_REAL           | -                | -                | -                  | -                  | -               | -                     | DOUBLE             | 8                | -               | -                  |
| SQL_SMALLINT       | -                | -                | -                  | -                  | -               | -                     | SMALLINT           | 2                | -               | -                  |
| SQL_TIME           | -                | -                | -                  | -                  | -               | -                     | TIME               | 3                | -               | -                  |
| SQL_TIMESTAMP      | -                | -                | -                  | -                  | -               | -                     | TIMESTAMP          | 10               | -               | -                  |
| SQL_TINYINT        | -                | -                | -                  | -                  | -               | -                     | SMALLINT           | 2                | -               | -                  |
| SQL_VARBINARY      | 1                | 8000             | -                  | -                  | -               | -                     | VARCHAR            | -                | -               | Y                  |
| SQL_VARCHAR        | 1                | 8000             | -                  | -                  | -               | -                     | VARCHAR            | -                | -               | N                  |

## Federated systems

Table 166. Microsoft SQL Server forward default data type mappings (continued)

| Remote Typename    | Remote Lower Len | Remote Upper Len | Remote Lower Scale | Remote Upper Scale | Remote Bit Data | Remote Data Operators | Federated Typename | Federated Length | Federated Scale | Federated Bit Data |
|--------------------|------------------|------------------|--------------------|--------------------|-----------------|-----------------------|--------------------|------------------|-----------------|--------------------|
| text               | -                | -                | -                  | -                  | -               | -                     | CLOB               | -                | -               | N                  |
| timestamp          | -                | -                | -                  | -                  | -               | -                     | VARCHAR            | 8                | -               | Y                  |
| tinyint            | -                | -                | -                  | -                  | -               | -                     | SMALLINT           | 2                | -               | -                  |
| uniqueidentifier 1 | -                | 4000             | -                  | -                  | Y               | -                     | VARCHAR            | 16               | -               | Y                  |
| varbinary          | 1                | 8000             | -                  | -                  | -               | -                     | VARCHAR            | -                | -               | Y                  |
| varchar            | 1                | 8000             | -                  | -                  | -               | -                     | VARCHAR            | -                | -               | N                  |

**Note:**

1. This type mapping is valid only with Windows 2000 operating systems.
2. This type mapping is valid only with Microsoft SQL Server Version 2000.

## ODBC data sources

The following table lists the forward default data type mappings for ODBC data sources.

Table 167. ODBC forward default data type mappings (Not all columns shown)

| Remote Typename    | Remote Lower Len | Remote Upper Len | Remote Lower Scale | Remote Upper Scale | Remote Bit Data | Remote Data Operators | Federated Typename | Federated Length | Federated Scale | Federated Bit Data |
|--------------------|------------------|------------------|--------------------|--------------------|-----------------|-----------------------|--------------------|------------------|-----------------|--------------------|
| SQL_BIGINT         | -                | -                | -                  | -                  | -               | -                     | BIGINT             | 8                | -               | -                  |
| SQL_BINARY         | 1                | 254              | -                  | -                  | -               | -                     | CHARACTER          | -                | -               | Y                  |
| SQL_BINARY         | 255              | 32672            | -                  | -                  | -               | -                     | VARCHAR            | -                | -               | Y                  |
| SQL_BIT            | -                | -                | -                  | -                  | -               | -                     | SMALLINT           | 2                | -               | -                  |
| SQL_CHAR           | 1                | 254              | -                  | -                  | -               | -                     | CHAR               | -                | -               | N                  |
| SQL_CHAR           | 255              | 32672            | -                  | -                  | -               | -                     | VARCHAR            | -                | -               | N                  |
| SQL_DECIMAL        | 1                | 31               | 0                  | 31                 | -               | -                     | DECIMAL            | -                | -               | -                  |
| SQL_DECIMAL        | 32               | 38               | 0                  | 38                 | -               | -                     | DOUBLE             | 8                | -               | -                  |
| SQL_DOUBLE         | -                | -                | -                  | -                  | -               | -                     | DOUBLE             | 8                | -               | -                  |
| SQL_FLOAT          | -                | -                | -                  | -                  | -               | -                     | DOUBLE             | 8                | -               | -                  |
| SQL_INTEGER        | -                | -                | -                  | -                  | -               | -                     | INTEGER            | 4                | -               | -                  |
| SQL_LONG-VARCHAR   | -                | -                | -                  | -                  | -               | -                     | CLOB               | 2147483647       | -               | N                  |
| SQL_LONG-VARBINARY | -                | -                | -                  | -                  | -               | -                     | BLOB               | -                | -               | Y                  |
| SQL_NUMERIC        | 1                | 31               | 0                  | 31                 | -               | -                     | DECIMAL            | -                | -               | -                  |
| SQL_NUMERIC        | 32               | 32               | 0                  | 31                 | -               | -                     | DOUBLE             | 8                | -               | -                  |
| SQL_REAL           | -                | -                | -                  | -                  | -               | -                     | REAL               | 4                | -               | -                  |
| SQL_SMALLINT       | -                | -                | -                  | -                  | -               | -                     | SMALLINT           | 2                | -               | -                  |
| SQL_TYPE_DATE      | -                | -                | -                  | -                  | -               | -                     | DATE               | 4                | -               | -                  |
| SQL_TYPE_TIME      | -                | -                | -                  | -                  | -               | -                     | TIME               | 3                | -               | -                  |
| SQL_TYPE_TIMESTAMP | -                | -                | -                  | -                  | -               | -                     | TIMESTAMP          | 10               | -               | -                  |
| SQL_TINYINT        | -                | -                | -                  | -                  | -               | -                     | SMALLINT           | 2                | -               | -                  |
| SQL_VARBINARY      | 1                | 32672            | -                  | -                  | -               | -                     | VARCHAR            | -                | -               | Y                  |
| SQL_VARCHAR        | 1                | 32672            | -                  | -                  | -               | -                     | VARCHAR            | -                | -               | N                  |
| SQL_WCHAR          | 1                | 127              | -                  | -                  | -               | -                     | CHAR               | -                | -               | N                  |
| SQL_WCHAR          | 128              | 16336            | -                  | -                  | -               | -                     | VARCHAR            | -                | -               | N                  |
| SQL_WVARCHAR       | 1                | 16336            | -                  | -                  | -               | -                     | VARCHAR            | -                | -               | N                  |
| SQL_WLONG-VARCHAR  | -                | 1073741823       | -                  | -                  | -               | -                     | CLOB               | 2147483647       | -               | N                  |

## Oracle NET8 data sources

The following table lists the forward default data type mappings for Oracle NET8 data sources.

Table 168. Oracle NET8 forward default data type mappings

| Remote Typename | Remote Lower Len | Remote Upper Len | Remote Lower Scale | Remote Upper Scale | Remote Bit Data | Remote Data Operators | Federated Typename | Federated Length | Federated Scale | Federated Bit Data |
|-----------------|------------------|------------------|--------------------|--------------------|-----------------|-----------------------|--------------------|------------------|-----------------|--------------------|
| BLOB            | 0                | 0                | 0                  | 0                  | -               | \0                    | BLOB               | 2147483647       | 0               | Y                  |
| CHAR            | 1                | 254              | 0                  | 0                  | -               | \0                    | CHAR               | 0                | 0               | N                  |
| CHAR            | 255              | 2000             | 0                  | 0                  | -               | \0                    | VARCHAR            | 0                | 0               | N                  |
| CLOB            | 0                | 0                | 0                  | 0                  | -               | \0                    | CLOB               | 2147483647       | 0               | N                  |
| DATE            | 0                | 0                | 0                  | 0                  | -               | \0                    | TIMESTAMP          | 0                | 0               | N                  |
| FLOAT           | 1                | 126              | 0                  | 0                  | -               | \0                    | DOUBLE             | 0                | 0               | N                  |
| LONG            | 0                | 0                | 0                  | 0                  | -               | \0                    | CLOB               | 2147483647       | 0               | N                  |
| LONG RAW        | 0                | 0                | 0                  | 0                  | -               | \0                    | BLOB               | 2147483647       | 0               | Y                  |
| NUMBER          | 10               | 18               | 0                  | 0                  | -               | \0                    | BIGINT             | 0                | 0               | N                  |
| NUMBER          | 1                | 38               | -84                | 127                | -               | \0                    | DOUBLE             | 0                | 0               | N                  |
| NUMBER          | 1                | 31               | 0                  | 31                 | -               | >=                    | DECIMAL            | 0                | 0               | N                  |
| NUMBER          | 1                | 4                | 0                  | 0                  | -               | \0                    | SMALLINT           | 0                | 0               | N                  |
| NUMBER          | 5                | 9                | 0                  | 0                  | -               | \0                    | INTEGER            | 0                | 0               | N                  |
| NUMBER          | -                | 10               | 0                  | 0                  | -               | \0                    | DECIMAL            | 0                | 0               | N                  |
| RAW             | 1                | 2000             | 0                  | 0                  | -               | \0                    | VARCHAR            | 0                | 0               | Y                  |
| ROWID           | 0                | 0                | 0                  | NULL               | -               | \0                    | CHAR               | 18               | 0               | N                  |
| TIMESTAMP 1     | -                | -                | -                  | -                  | -               | -                     | TIMESTAMP          | 10               | -               | -                  |
| VARCHAR2        | 1                | 4000             | 0                  | 0                  | -               | \0                    | VARCHAR            | 0                | 0               | N                  |

Note:

1. This type mapping is valid only for Oracle 9i (or later) client and server configurations.

## Sybase data sources

The following table lists the forward default data type mappings for Sybase data sources.

Table 169. Sybase CTLIB forward default data type mappings

| Remote Typename         | Remote Lower Len | Remote Upper Len | Remote Lower Scale | Remote Upper Scale | Remote Bit Data | Remote Data Operators | Federated Typename | Federated Length | Federated Scale | Federated Bit Data |
|-------------------------|------------------|------------------|--------------------|--------------------|-----------------|-----------------------|--------------------|------------------|-----------------|--------------------|
| binary                  | 1                | 254              | -                  | -                  | -               | -                     | CHAR               | -                | -               | Y                  |
| binary                  | 255              | 16384            | -                  | -                  | -               | -                     | VARCHAR            | -                | -               | Y                  |
| bit                     | -                | -                | -                  | -                  | -               | -                     | SMALLINT           | -                | -               | -                  |
| char                    | 1                | 254              | -                  | -                  | -               | -                     | CHAR               | -                | -               | N                  |
| char                    | 255              | 16384            | -                  | -                  | -               | -                     | VARCHAR            | -                | -               | N                  |
| char null (see varchar) |                  |                  |                    |                    |                 |                       |                    |                  |                 |                    |
| datetime                | -                | -                | -                  | -                  | -               | -                     | TIMESTAMP          | -                | -               | -                  |
| datetimm                | -                | -                | -                  | -                  | -               | -                     | TIMESTAMP          | -                | -               | -                  |
| decimal                 | 1                | 31               | 0                  | 31                 | -               | -                     | DECIMAL            | -                | -               | -                  |
| decimal                 | 32               | 38               | 0                  | 38                 | -               | -                     | DOUBLE             | -                | -               | -                  |
| decimaln                | 1                | 31               | 0                  | 31                 | -               | -                     | DECIMAL            | -                | -               | -                  |
| decimaln                | 32               | 38               | 0                  | 38                 | -               | -                     | DOUBLE             | -                | -               | -                  |
| float                   | -                | 4                | -                  | -                  | -               | -                     | REAL               | -                | -               | -                  |
| float                   | -                | 8                | -                  | -                  | -               | -                     | DOUBLE             | -                | -               | -                  |
| floatn                  | -                | 4                | -                  | -                  | -               | -                     | REAL               | -                | -               | -                  |
| floatn                  | -                | 8                | -                  | -                  | -               | -                     | DOUBLE             | -                | -               | -                  |
| image                   | -                | -                | -                  | -                  | -               | -                     | BLOB               | -                | -               | -                  |
| int                     | -                | -                | -                  | -                  | -               | -                     | INTEGER            | -                | -               | -                  |
| intn                    | -                | -                | -                  | -                  | -               | -                     | INTEGER            | -                | -               | -                  |
| money                   | -                | -                | -                  | -                  | -               | -                     | DECIMAL            | 19               | 4               | -                  |
| moneyn                  | -                | -                | -                  | -                  | -               | -                     | DECIMAL            | 19               | 4               | -                  |
| nchar                   | 1                | 254              | -                  | -                  | -               | -                     | CHAR               | -                | -               | N                  |
| nchar                   | 255              | 16384            | -                  | -                  | -               | -                     | VARCHAR            | -                | -               | N                  |

## Federated systems

Table 169. Sybase CTLIB forward default data type mappings (continued)

| Remote Typename                 | Remote Lower Len | Remote Upper Len | Remote Lower Scale | Remote Upper Scale | Remote Bit Data | Remote Data Operators | Federated Typename | Federated Length | Federated Scale | Federated Bit Data |
|---------------------------------|------------------|------------------|--------------------|--------------------|-----------------|-----------------------|--------------------|------------------|-----------------|--------------------|
| nchar null<br>(see nvarchar)    |                  |                  |                    |                    |                 |                       |                    |                  |                 |                    |
| numeric                         | 1                | 31               | 0                  | 31                 | -               | -                     | DECIMAL            | -                | -               | -                  |
| numeric                         | 32               | 38               | 0                  | 38                 | -               | -                     | DOUBLE             | -                | -               | -                  |
| numericn                        | 1                | 31               | 0                  | 31                 | -               | -                     | DECIMAL            | -                | -               | -                  |
| numericn                        | 32               | 38               | 0                  | 38                 | -               | -                     | DOUBLE             | -                | -               | -                  |
| nvarchar                        | 1                | 16384            | -                  | -                  | -               | -                     | VARCHAR            | -                | -               | N                  |
| real                            | -                | -                | -                  | -                  | -               | -                     | REAL               | -                | -               | -                  |
| smalldatetime                   | -                | -                | -                  | -                  | -               | -                     | TIMESTAMP          | -                | -               | -                  |
| smallint                        | -                | -                | -                  | -                  | -               | -                     | SMALLINT           | -                | -               | -                  |
| smallmoney                      | -                | -                | -                  | -                  | -               | -                     | DECIMAL            | 10               | 4               | -                  |
| sysname                         | 1                | 254              | -                  | -                  | -               | -                     | CHAR               | -                | -               | N                  |
| text                            | -                | -                | -                  | -                  | -               | -                     | CLOB               | -                | -               | -                  |
| timestamp                       | -                | -                | -                  | -                  | -               | -                     | VARCHAR            | 8                | -               | Y                  |
| tinyint                         | -                | -                | -                  | -                  | -               | -                     | SMALLINT           | -                | -               | -                  |
| unicar <sup>1</sup>             | 1                | 254              | -                  | -                  | -               | -                     | CHAR               | -                | -               | N                  |
| unicar <sup>1</sup>             | 255              | 16384            | -                  | -                  | -               | -                     | VARCHAR            | -                | -               | N                  |
| unicar null<br>(see univarchar) |                  |                  |                    |                    |                 |                       |                    |                  |                 |                    |
| univarchar <sup>1</sup>         | 1                | 16384            | -                  | -                  | -               | -                     | VARCHAR            | -                | -               | N                  |
| varbinary                       | 1                | 16384            | -                  | -                  | -               | -                     | VARCHAR            | -                | -               | Y                  |
| varchar                         | 1                | 16384            | -                  | -                  | -               | -                     | VARCHAR            | -                | -               | N                  |

Note:

1. Valid for non-Unicode federated databases.

## Teradata data sources

The following table lists the forward default data type mappings for Teradata data sources.

Table 170. Teradata forward default data type mappings (Not all columns shown)

| Remote Typename  | Remote Lower Len | Remote Upper Len | Remote Lower Scale | Remote Upper Scale | Remote Bit Data | Remote Data Operators | Federated Typename | Federated Length | Federated Scale | Federated Bit Data |
|------------------|------------------|------------------|--------------------|--------------------|-----------------|-----------------------|--------------------|------------------|-----------------|--------------------|
| BYTE             | 1                | 254              | -                  | -                  | -               | -                     | CHAR               | -                | -               | Y                  |
| BYTE             | 255              | 32672            | -                  | -                  | -               | -                     | VARCHAR            | -                | -               | Y                  |
| BYTE             | 32673            | 64000            | -                  | -                  | -               | -                     | BLOB               | -                | -               | -                  |
| BYTEINT          | -                | -                | -                  | -                  | -               | -                     | SMALLINT           | -                | -               | -                  |
| CHAR             | 1                | 254              | -                  | -                  | -               | -                     | CHARACTER          | -                | -               | -                  |
| CHAR             | 255              | 32672            | -                  | -                  | -               | -                     | VARCHAR            | -                | -               | -                  |
| CHAR             | 32673            | 64000            | -                  | -                  | -               | -                     | CLOB               | -                | -               | -                  |
| DATE             | -                | -                | -                  | -                  | -               | -                     | DATE               | -                | -               | -                  |
| DECIMAL          | 1                | 18               | 0                  | 18                 | -               | -                     | DECIMAL            | -                | -               | -                  |
| DOUBLE PRECISION | -                | -                | -                  | -                  | -               | -                     | DOUBLE             | -                | -               | -                  |
| FLOAT            | -                | -                | -                  | -                  | -               | -                     | DOUBLE             | -                | -               | -                  |
| GRAPHIC          | 1                | 127              | -                  | -                  | -               | -                     | GRAPHIC            | -                | -               | -                  |
| GRAPHIC          | 128              | 16336            | -                  | -                  | -               | -                     | VARGRAPHIC         | -                | -               | -                  |
| GRAPHIC          | 16337            | 32000            | -                  | -                  | -               | -                     | DBCLOB             | -                | -               | -                  |
| INTEGER          | -                | -                | -                  | -                  | -               | -                     | INTEGER            | -                | -               | -                  |
| INTERVAL         | -                | -                | -                  | -                  | -               | -                     | CHAR               | -                | -               | -                  |
| NUMERIC          | 1                | 18               | 0                  | 18                 | -               | -                     | DECIMAL            | -                | -               | -                  |
| REAL             | -                | -                | -                  | -                  | -               | -                     | DOUBLE             | -                | -               | -                  |
| SMALLINT         | -                | -                | -                  | -                  | -               | -                     | SMALLINT           | -                | -               | -                  |
| TIMESTAMP        | -                | -                | -                  | -                  | -               | -                     | TIMESTAMP          | -                | -               | -                  |
| VARBYTE          | 1                | 32762            | -                  | -                  | -               | -                     | VARCHAR            | -                | -               | Y                  |
| VARBYTE          | 32763            | 64000            | -                  | -                  | -               | -                     | BLOB               | -                | -               | -                  |
| VARCHAR          | 1                | 32672            | -                  | -                  | -               | -                     | VARCHAR            | -                | -               | -                  |
| VARCHAR          | 32673            | 64000            | -                  | -                  | -               | -                     | CLOB               | -                | -               | -                  |

Table 170. Teradata forward default data type mappings (Not all columns shown) (continued)

| Remote Typename | Remote Lower Len | Remote Upper Len | Remote Lower Scale | Remote Upper Scale | Remote Bit Data | Remote Data Operators | Federated Typename | Federated Length | Federated Scale | Federated Bit Data |
|-----------------|------------------|------------------|--------------------|--------------------|-----------------|-----------------------|--------------------|------------------|-----------------|--------------------|
| VARGRAPHIC      | 1                | 16336            | -                  | -                  | -               | -                     | VARGRAPHIC         | -                | -               | -                  |
| VARGRAPHIC      | 16337            | 32000            | -                  | -                  | -               | -                     | DBCLOB             | -                | -               | -                  |

## Default reverse data type mappings

For most data sources, the default type mappings are in the wrappers.

The two kinds of mappings between data source data types and federated database data types are forward type mappings and reverse type mappings. In a forward type mapping, the mapping is from a remote type to a comparable local type. The other type of mapping is a reverse type mapping, which is used with transparent DDL to create or modify remote tables.

The default type mappings for DB2 family data sources are in the DRDA wrapper. The default type mappings for Informix are in the INFORMIX wrapper, and so forth.

When you define a remote table or view to the federated database, the definition includes a reverse type mapping. The mapping is from a local federated database data type for each column, and the corresponding remote data type. For example, there is a default reverse type mapping in which the local type REAL points to the Informix type SMALLFLOAT.

Federated databases do not support mappings for LONG VARCHAR, LONG VARGRAPHIC, DATALINK, and user-defined types.

When you use the CREATE TABLE statement to create a remote table, you specify the local data types you want to include in the remote table. These default reverse type mappings will assign corresponding remote types to these columns. For example, suppose that you use the CREATE TABLE statement to define an Informix table with a column C2. You specify BIGINT as the data type for C2 in the statement. The default reverse type mapping of BIGINT depends on which version of Informix you are creating the table on. The mapping for C2 in the Informix table will be to DECIMAL in Informix Version 8 and to INT8 in Informix Version 9.

You can override a default reverse type mapping, or create a new reverse type mapping with the CREATE TYPE MAPPING statement.

The following tables show the default reverse mappings between federated database local data types and remote data source data types.

These mappings are valid with all the supported versions, unless otherwise noted.

## DB2 Database for Linux, UNIX, and Windows data sources

The following table lists the reverse default data type mappings for DB2 Database for Linux, UNIX, and Windows data sources.

Table 171. DB2 Database for Linux, UNIX, and Windows reverse default data type mappings (Not all columns shown)

| Federated Typename | Federated Lower Len | Federated Upper Len | Federated Lower Scale | Federated Upper Scale | Federated Bit Data | Federated Data Operators | Remote Typename | Remote Length | Remote Scale | Federated Bit Data |
|--------------------|---------------------|---------------------|-----------------------|-----------------------|--------------------|--------------------------|-----------------|---------------|--------------|--------------------|
| BIGINT             | -                   | 8                   | -                     | -                     | -                  | -                        | BIGINT          | -             | -            | -                  |

## Federated systems

Table 171. DB2 Database for Linux, UNIX, and Windows reverse default data type mappings (Not all columns shown) (continued)

| Federated Typename | Federated Lower Len | Federated Upper Len | Federated Lower Scale | Federated Upper Scale | Federated Bit Data | Federated Data Operators | Remote Typename | Remote Length | Remote Scale | Federated Bit Data |
|--------------------|---------------------|---------------------|-----------------------|-----------------------|--------------------|--------------------------|-----------------|---------------|--------------|--------------------|
| BLOB               | -                   | -                   | -                     | -                     | -                  | -                        | BLOB            | -             | -            | -                  |
| CHARACTER          | -                   | -                   | -                     | -                     | -                  | -                        | CHAR            | -             | -            | N                  |
| CHARACTER          | -                   | -                   | -                     | -                     | Y                  | -                        | CHAR            | -             | -            | Y                  |
| CLOB               | -                   | -                   | -                     | -                     | -                  | -                        | CLOB            | -             | -            | -                  |
| DATE               | -                   | 4                   | -                     | -                     | -                  | -                        | DATE            | -             | -            | -                  |
| DBCLOB             | -                   | -                   | -                     | -                     | -                  | -                        | DBCLOB          | -             | -            | -                  |
| DECIMAL            | -                   | -                   | -                     | -                     | -                  | -                        | DECIMAL         | -             | -            | -                  |
| DOUBLE             | -                   | 8                   | -                     | -                     | -                  | -                        | DOUBLE          | -             | -            | -                  |
| FLOAT              | -                   | 8                   | -                     | -                     | -                  | -                        | DOUBLE          | -             | -            | -                  |
| GRAPHIC            | -                   | -                   | -                     | -                     | -                  | -                        | GRAPHIC         | -             | -            | N                  |
| INTEGER            | -                   | 4                   | -                     | -                     | -                  | -                        | INTEGER         | -             | -            | -                  |
| REAL               | -                   | -                   | -                     | -                     | -                  | -                        | REAL            | -             | -            | -                  |
| SMALLINT           | -                   | 2                   | -                     | -                     | -                  | -                        | SMALLINT        | -             | -            | -                  |
| TIME               | -                   | 3                   | -                     | -                     | -                  | -                        | TIME            | -             | -            | -                  |
| TIMESTAMP          | -                   | 10                  | -                     | -                     | -                  | -                        | TIMESTAMP       | -             | -            | -                  |
| VARCHAR            | -                   | -                   | -                     | -                     | -                  | -                        | VARCHAR         | -             | -            | N                  |
| VARCHAR            | -                   | -                   | -                     | -                     | Y                  | -                        | VARCHAR         | -             | -            | Y                  |
| VARGRAPH           | -                   | -                   | -                     | -                     | -                  | -                        | VARGRAPHIC      | -             | -            | N                  |
| VARGRAPHIC         | -                   | -                   | -                     | -                     | -                  | -                        | VARGRAPHIC      | -             | -            | -                  |

## DB2 for iSeries data sources

The following table lists the reverse default data type mappings for DB2 for iSeries data sources.

Table 172. DB2 for iSeries reverse default data type mappings (Not all columns shown)

| Federated Typename | Federated Lower Len | Federated Upper Len | Federated Lower Scale | Federated Upper Scale | Federated Bit Data | Federated Data Operations | Remote Typename | Remote Length | Remote Scale | Remote Bit Data |
|--------------------|---------------------|---------------------|-----------------------|-----------------------|--------------------|---------------------------|-----------------|---------------|--------------|-----------------|
| BLOB               | -                   | -                   | -                     | -                     | -                  | -                         | BLOB            | -             | -            | -               |
| CHARACTER          | -                   | -                   | -                     | -                     | -                  | -                         | CHARACTER       | -             | -            | N               |
| CHARACTER          | -                   | -                   | -                     | -                     | Y                  | -                         | CHARACTER       | -             | -            | Y               |
| CLOB               | -                   | -                   | -                     | -                     | -                  | -                         | CLOB            | -             | -            | -               |
| DATE               | -                   | 4                   | -                     | -                     | -                  | -                         | DATE            | -             | -            | -               |
| DBCLOB             | -                   | -                   | -                     | -                     | -                  | -                         | DBCLOB          | -             | -            | -               |
| DECIMAL            | -                   | -                   | -                     | -                     | -                  | -                         | NUMERIC         | -             | -            | -               |
| DECIMAL            | -                   | -                   | -                     | -                     | -                  | -                         | DECIMAL         | -             | -            | -               |
| DOUBLE             | -                   | 8                   | -                     | -                     | -                  | -                         | FLOAT           | -             | -            | -               |
| GRAPHIC            | -                   | -                   | -                     | -                     | -                  | -                         | GRAPHIC         | -             | -            | N               |
| INTEGER            | -                   | 4                   | -                     | -                     | -                  | -                         | INTEGER         | -             | -            | -               |
| REAL               | -                   | 4                   | -                     | -                     | -                  | -                         | FLOAT           | -             | -            | -               |
| SMALLINT           | -                   | 2                   | -                     | -                     | -                  | -                         | SMALLINT        | -             | -            | -               |
| TIME               | -                   | 3                   | -                     | -                     | -                  | -                         | TIME            | -             | -            | -               |
| TIMESTAMP          | -                   | 10                  | -                     | -                     | -                  | -                         | TIMESTAMP       | -             | -            | -               |
| VARCHAR            | -                   | -                   | -                     | -                     | -                  | -                         | VARCHAR         | -             | -            | N               |
| VARCHAR            | -                   | -                   | -                     | -                     | Y                  | -                         | VARCHAR         | -             | -            | Y               |
| VARGRAPHIC         | -                   | -                   | -                     | -                     | -                  | -                         | VARG            | -             | -            | N               |

## DB2 for VM and VSE data sources

The following table lists the reverse default data type mappings for DB2 for VM and VSE data sources.

Table 173. DB2 for VM and VSE reverse default data type mappings (Not all columns shown)

| Federated Typename | Federated Lower Len | Federated Upper Len | Federated Lower Scale | Federated Upper Scale | Federated Bit Data | Federated Data Operators | Remote Typename | Remote Length | Remote Scale | Remote Bit Data |
|--------------------|---------------------|---------------------|-----------------------|-----------------------|--------------------|--------------------------|-----------------|---------------|--------------|-----------------|
| BLOB               | -                   | -                   | -                     | -                     | -                  | -                        | BLOB            | -             | -            | -               |
| CHARACTER          | -                   | -                   | -                     | -                     | -                  | -                        | CHAR            | -             | -            | -               |
| CHARACTER          | -                   | -                   | -                     | -                     | Y                  | -                        | CHAR            | -             | -            | Y               |
| CLOB               | -                   | -                   | -                     | -                     | -                  | -                        | CLOB            | -             | -            | -               |
| DATE               | -                   | 4                   | -                     | -                     | -                  | -                        | DATE            | -             | -            | -               |
| DBCLOB             | -                   | -                   | -                     | -                     | -                  | -                        | DBCLOB          | -             | -            | -               |
| DECIMAL            | -                   | -                   | -                     | -                     | -                  | -                        | DECIMAL         | -             | -            | -               |
| DOUBLE             | -                   | 8                   | -                     | -                     | -                  | -                        | FLOAT           | -             | -            | -               |
| GRAPHIC            | -                   | -                   | -                     | -                     | -                  | -                        | GRAPHIC         | -             | -            | N               |
| INTEGER            | -                   | 4                   | -                     | -                     | -                  | -                        | INTEGER         | -             | -            | -               |
| REAL               | -                   | 4                   | -                     | -                     | -                  | -                        | REAL            | -             | -            | -               |
| SMALLINT           | -                   | 2                   | -                     | -                     | -                  | -                        | SMALLINT        | -             | -            | -               |
| TIME               | -                   | 3                   | -                     | -                     | -                  | -                        | TIME            | -             | -            | -               |
| TIMESTAMP          | -                   | 10                  | -                     | -                     | -                  | -                        | TIMESTAMP       | -             | -            | -               |
| VARCHAR            | -                   | -                   | -                     | -                     | -                  | -                        | VARCHAR         | -             | -            | -               |
| VARCHAR            | -                   | -                   | -                     | -                     | Y                  | -                        | VARCHAR         | -             | -            | Y               |
| VARGRAPH           | -                   | -                   | -                     | -                     | -                  | -                        | VARGRAPH        | -             | -            | N               |

## DB2 for z/OS data sources

The following table lists the reverse default data type mappings for DB2 for z/OS data sources.

Table 174. DB2 for z/OS reverse default data type mappings (Not all columns shown)

| Federated Typename | Federated Lower Len | Federated Upper Len | Federated Lower Scale | Federated Upper Scale | Federated Bit Data | Federated Data Operators | Remote Typename | Remote Length | Remote Scale | Remote Bit Data |
|--------------------|---------------------|---------------------|-----------------------|-----------------------|--------------------|--------------------------|-----------------|---------------|--------------|-----------------|
| BLOB               | -                   | -                   | -                     | -                     | -                  | -                        | BLOB            | -             | -            | -               |
| CHARACTER          | -                   | -                   | -                     | -                     | -                  | -                        | CHAR            | -             | -            | N               |
| CHARACTER          | -                   | -                   | -                     | -                     | Y                  | -                        | CHAR            | -             | -            | Y               |
| CLOB               | -                   | -                   | -                     | -                     | -                  | -                        | CLOB            | -             | -            | -               |
| DATE               | -                   | 4                   | -                     | -                     | -                  | -                        | DATE            | -             | -            | -               |
| DBCLOB             | -                   | -                   | -                     | -                     | -                  | -                        | DBCLOB          | -             | -            | -               |
| DECIMAL            | -                   | -                   | -                     | -                     | -                  | -                        | DECIMAL         | -             | -            | -               |
| DOUBLE             | -                   | 8                   | -                     | -                     | -                  | -                        | DOUBLE          | -             | -            | -               |
| FLOAT              | -                   | 8                   | -                     | -                     | -                  | -                        | DOUBLE          | -             | -            | -               |
| GRAPHIC            | -                   | -                   | -                     | -                     | -                  | -                        | GRAPHIC         | -             | -            | N               |
| INTEGER            | -                   | 4                   | -                     | -                     | -                  | -                        | INTEGER         | -             | -            | -               |
| REAL               | -                   | 4                   | -                     | -                     | -                  | -                        | REAL            | -             | -            | -               |
| SMALLINT           | -                   | 2                   | -                     | -                     | -                  | -                        | SMALLINT        | -             | -            | -               |
| TIME               | -                   | 3                   | -                     | -                     | -                  | -                        | TIME            | -             | -            | -               |
| TIMESTAMP          | -                   | 10                  | -                     | -                     | -                  | -                        | TIMESTAMP       | -             | -            | -               |
| VARCHAR            | -                   | -                   | -                     | -                     | -                  | -                        | VARCHAR         | -             | -            | N               |
| VARCHAR            | -                   | -                   | -                     | -                     | Y                  | -                        | VARCHAR         | -             | -            | Y               |
| VARGRAPHIC         | -                   | -                   | -                     | -                     | -                  | -                        | VARGRAPHIC      | -             | -            | N               |

## Informix data sources

The following table lists the reverse default data type mappings for Informix data sources.

Table 175. Informix reverse default data type mappings

| Federated Typename  | Federated Lower Len | Federated Upper Len | Federated Lower Scale | Federated Upper Scale | Federated Bit Data | Federated Data Operators | Remote Typename | Remote Length | Remote Scale | Remote Bit Data |
|---------------------|---------------------|---------------------|-----------------------|-----------------------|--------------------|--------------------------|-----------------|---------------|--------------|-----------------|
| BIGINT <sup>1</sup> | -                   | -                   | -                     | -                     | -                  | -                        | DECIMAL         | 19            | -            | -               |
| BIGINT <sup>2</sup> | -                   | -                   | -                     | -                     | -                  | -                        | INT8            | -             | -            | -               |
| BLOB                | 1                   | 2147483647          | -                     | -                     | -                  | -                        | BYTE            | -             | -            | -               |

## Federated systems

Table 175. Informix reverse default data type mappings (continued)

| Federated Typename   | Federated Lower Len | Federated Upper Len | Federated Lower Scale | Federated Upper Scale | Federated Bit Data | Federated Data Operators | Remote Typename | Remote Length | Remote Scale | Remote Bit Data |
|----------------------|---------------------|---------------------|-----------------------|-----------------------|--------------------|--------------------------|-----------------|---------------|--------------|-----------------|
| CHARACTER            | -                   | -                   | -                     | -                     | N                  | -                        | CHAR            | -             | -            | -               |
| CHARACTER            | -                   | -                   | -                     | -                     | Y                  | -                        | BYTE            | -             | -            | -               |
| CLOB                 | 1                   | 2147483647          | -                     | -                     | -                  | -                        | TEXT            | -             | -            | -               |
| DATE                 | -                   | 4                   | -                     | -                     | -                  | -                        | DATE            | -             | -            | -               |
| DECIMAL              | -                   | -                   | -                     | -                     | -                  | -                        | DECIMAL         | -             | -            | -               |
| DOUBLE               | -                   | 8                   | -                     | -                     | -                  | -                        | FLOAT           | -             | -            | -               |
| INTEGER              | -                   | 4                   | -                     | -                     | -                  | -                        | INTEGER         | -             | -            | -               |
| REAL                 | -                   | 4                   | -                     | -                     | -                  | -                        | SMALLFLOAT      | -             | -            | -               |
| SMALLINT             | -                   | 2                   | -                     | -                     | -                  | -                        | SMALLINT        | -             | -            | -               |
| TIME                 | -                   | 3                   | -                     | -                     | -                  | -                        | DATETIME        | 6             | 10           | -               |
| TIMESTAMP            | -                   | 10                  | -                     | -                     | -                  | -                        | DATETIME        | 0             | 15           | -               |
| VARCHAR              | 1                   | 254                 | -                     | -                     | N                  | -                        | VARCHAR         | -             | -            | -               |
| VARCHAR <sup>1</sup> | 255                 | 32672               | -                     | -                     | N                  | -                        | TEXT            | -             | -            | -               |
| VARCHAR              | -                   | -                   | -                     | -                     | Y                  | -                        | BYTE            | -             | -            | -               |
| VARCHAR <sup>2</sup> | 255                 | 2048                | -                     | -                     | N                  | -                        | LVARCHAR        | -             | -            | -               |
| VARCHAR <sup>2</sup> | 2049                | 32672               | -                     | -                     | N                  | -                        | TEXT            | -             | -            | -               |

**Note:**

1. This type mapping is valid only with Informix server Version 8 (or lower).
2. This type mapping is valid only with Informix server Version 9 (or higher).

For the Informix DATETIME data type, the federated server uses the Informix high-level qualifier as the REMOTE\_LENGTH and the Informix low-level qualifier as the REMOTE\_SCALE.

The Informix qualifiers are the "TU\_" constants defined in the Informix Client SDK `datatime.h` file. The constants are:

|           |                  |                  |
|-----------|------------------|------------------|
| 0 = YEAR  | 8 = MINUTE       | 13 = FRACTION(3) |
| 2 = MONTH | 10 = SECOND      | 14 = FRACTION(4) |
| 4 = DAY   | 11 = FRACTION(1) | 15 = FRACTION(5) |
| 6 = HOUR  | 12 = FRACTION(2) |                  |

## Microsoft SQL Server data sources

The following table lists the reverse default data type mappings for Microsoft SQL Server data sources.

Table 176. Microsoft SQL Server reverse default data type mappings (Not all columns shown)

| Federated Typename  | Federated Lower Len | Federated Upper Len | Federated Lower Scale | Federated Upper Scale | Federated Bit Data | Federated Data Operators | Remote Typename | Remote Length | Remote Scale | Remote Bit Data |
|---------------------|---------------------|---------------------|-----------------------|-----------------------|--------------------|--------------------------|-----------------|---------------|--------------|-----------------|
| BIGINT <sup>1</sup> | -                   | -                   | -                     | -                     | -                  | -                        | bigint          | -             | -            | -               |
| BLOB                | -                   | -                   | -                     | -                     | -                  | -                        | image           | -             | -            | -               |
| CHARACTER           | -                   | -                   | -                     | -                     | Y                  | -                        | binary          | -             | -            | -               |
| CHARACTER           | -                   | -                   | -                     | -                     | N                  | -                        | char            | -             | -            | -               |
| CLOB                | -                   | -                   | -                     | -                     | -                  | -                        | text            | -             | -            | -               |
| DATE                | -                   | 4                   | -                     | -                     | -                  | -                        | datetime        | -             | -            | -               |
| DECIMAL             | -                   | -                   | -                     | -                     | -                  | -                        | decimal         | -             | -            | -               |
| DOUBLE              | -                   | 8                   | -                     | -                     | -                  | -                        | float           | -             | -            | -               |
| INTEGER             | -                   | -                   | -                     | -                     | -                  | -                        | int             | -             | -            | -               |
| SMALLINT            | -                   | -                   | -                     | -                     | -                  | -                        | smallint        | -             | -            | -               |
| REAL                | -                   | 4                   | -                     | -                     | -                  | -                        | real            | -             | -            | -               |
| TIME                | -                   | 3                   | -                     | -                     | -                  | -                        | datetime        | -             | -            | -               |
| TIMESTAMP           | -                   | 10                  | -                     | -                     | -                  | -                        | datetime        | -             | -            | -               |
| VARCHAR             | 1                   | 8000                | -                     | -                     | N                  | -                        | varchar         | -             | -            | -               |
| VARCHAR             | 8001                | 32672               | -                     | -                     | N                  | -                        | text            | -             | -            | -               |
| VARCHAR             | 1                   | 8000                | -                     | -                     | Y                  | -                        | varbinary       | -             | -            | -               |
| VARCHAR             | 8001                | 32672               | -                     | -                     | Y                  | -                        | image           | -             | -            | -               |

**Note:**

1. This type mapping is valid only with Microsoft SQL Server Version 2000.



## Oracle NET8 data sources

The following table lists the reverse default data type mappings for Oracle NET8 data sources.

Table 177. Oracle NET8 reverse default data type mappings

| Federated Typename     | Federated Lower Len | Federated Upper Len | Federated Lower Scale | Federated Upper Scale | Federated Bit Data | Federated Data Operators | Remote Typename | Remote Length | Remote Scale | Remote Bit Data |
|------------------------|---------------------|---------------------|-----------------------|-----------------------|--------------------|--------------------------|-----------------|---------------|--------------|-----------------|
| BIGINT                 | 0                   | 8                   | 0                     | 0                     | N                  | \0                       | NUMBER          | 19            | 0            | N               |
| BLOB                   | 0                   | 2147483647          | 0                     | 0                     | Y                  | \0                       | BLOB            | 0             | 0            | Y               |
| CHARACTER              | 1                   | 254                 | 0                     | 0                     | N                  | \0                       | CHAR            | 0             | 0            | N               |
| CHARACTER              | 1                   | 254                 | 0                     | 0                     | Y                  | \0                       | RAW             | 0             | 0            | Y               |
| CLOB                   | 0                   | 2147483647          | 0                     | 0                     | N                  | \0                       | CLOB            | 0             | 0            | N               |
| DATE                   | 0                   | 4                   | 0                     | 0                     | N                  | \0                       | DATE            | 0             | 0            | N               |
| DECIMAL                | 0                   | 0                   | 0                     | 0                     | N                  | \0                       | NUMBER          | 0             | 0            | N               |
| DOUBLE                 | 0                   | 8                   | 0                     | 0                     | N                  | \0                       | FLOAT           | 126           | 0            | N               |
| FLOAT                  | 0                   | 8                   | 0                     | 0                     | N                  | \0                       | FLOAT           | 126           | 0            | N               |
| INTEGER                | 0                   | 4                   | 0                     | 0                     | N                  | \0                       | NUMBER          | 10            | 0            | N               |
| REAL                   | 0                   | 4                   | 0                     | 0                     | N                  | \0                       | FLOAT           | 63            | 0            | N               |
| SMALLINT               | 0                   | 2                   | 0                     | 0                     | N                  | \0                       | NUMBER          | 5             | 0            | N               |
| TIME                   | 0                   | 3                   | 0                     | 0                     | N                  | \0                       | DATE            | 0             | 0            | N               |
| TIMESTAMP <sub>1</sub> | 0                   | 10                  | 0                     | 0                     | N                  | \0                       | DATE            | 0             | 0            | N               |
| TIMESTAMP <sub>2</sub> | 0                   | 10                  | 0                     | 0                     | N                  | \0                       | TIMESTAMP       | 6             | 0            | N               |
| VARCHAR                | 1                   | 4000                | 0                     | 0                     | N                  | \0                       | VARCHAR2        | 0             | 0            | N               |
| VARCHAR                | 1                   | 2000                | 0                     | 0                     | Y                  | \0                       | RAW             | 0             | 0            | Y               |

Note:

1. This type mapping is valid only with Oracle Version 8.
2. This type mapping is valid only with Oracle Version 9 and Version 10.

## Sybase data sources

The following table lists the reverse default data type mappings for Sybase data sources.

Table 178. Sybase CTLIB default reverse data type mappings

| Federated Typename   | Federated Lower Len | Federated Upper Len | Federated Lower Scale | Federated Upper Scale | Federated Bit Data | Federated Data Operators | Remote Typename | Remote Length | Remote Scale | Remote Bit Data |
|----------------------|---------------------|---------------------|-----------------------|-----------------------|--------------------|--------------------------|-----------------|---------------|--------------|-----------------|
| BIGINT               | -                   | -                   | -                     | -                     | -                  | -                        | decimal         | 19            | 0            | -               |
| BLOB                 | -                   | -                   | -                     | -                     | -                  | -                        | image           | -             | -            | -               |
| CHARACTER            | -                   | -                   | -                     | -                     | N                  | -                        | char            | -             | -            | -               |
| CHARACTER            | -                   | -                   | -                     | -                     | Y                  | -                        | binary          | -             | -            | -               |
| CLOB                 | -                   | -                   | -                     | -                     | -                  | -                        | text            | -             | -            | -               |
| DATE                 | -                   | -                   | -                     | -                     | -                  | -                        | datetime        | -             | -            | -               |
| DECIMAL              | -                   | -                   | -                     | -                     | -                  | -                        | decimal         | -             | -            | -               |
| DOUBLE               | -                   | -                   | -                     | -                     | -                  | -                        | float           | -             | -            | -               |
| INTEGER              | -                   | -                   | -                     | -                     | -                  | -                        | integer         | -             | -            | -               |
| REAL                 | -                   | -                   | -                     | -                     | -                  | -                        | real            | -             | -            | -               |
| SMALLINT             | -                   | -                   | -                     | -                     | -                  | -                        | smallint        | -             | -            | -               |
| TIME                 | -                   | -                   | -                     | -                     | -                  | -                        | datetime        | -             | -            | -               |
| TIMESTAMP            | -                   | -                   | -                     | -                     | -                  | -                        | datetime        | -             | -            | -               |
| VARCHAR <sup>1</sup> | 1                   | 255                 | -                     | -                     | N                  | -                        | varchar         | -             | -            | -               |
| VARCHAR <sup>1</sup> | 256                 | 32672               | -                     | -                     | N                  | -                        | text            | -             | -            | -               |
| VARCHAR <sup>2</sup> | 1                   | 16384               | -                     | -                     | N                  | -                        | varchar         | -             | -            | -               |
| VARCHAR <sup>2</sup> | 16385               | 32672               | -                     | -                     | N                  | -                        | text            | -             | -            | -               |
| VARCHAR <sup>1</sup> | 1                   | 255                 | -                     | -                     | Y                  | -                        | varbinary       | -             | -            | -               |
| VARCHAR <sup>1</sup> | 256                 | 32672               | -                     | -                     | Y                  | -                        | image           | -             | -            | -               |
| VARCHAR <sup>2</sup> | 1                   | 16384               | -                     | -                     | Y                  | -                        | varbinary       | -             | -            | -               |
| VARCHAR <sup>2</sup> | 16385               | 32672               | -                     | -                     | Y                  | -                        | image           | -             | -            | -               |

## Federated systems

Table 178. Sybase CTLIB default reverse data type mappings (continued)

| Federated<br>Typename | Federated<br>Lower Len | Federated<br>Upper Len | Federated<br>Lower Scale | Federated<br>Upper Scale | Federated Bit<br>Data | Federated<br>Data<br>Operators | Remote<br>Typename | Remote<br>Length | Remote Scale | Remote Bit<br>Data |
|-----------------------|------------------------|------------------------|--------------------------|--------------------------|-----------------------|--------------------------------|--------------------|------------------|--------------|--------------------|
|-----------------------|------------------------|------------------------|--------------------------|--------------------------|-----------------------|--------------------------------|--------------------|------------------|--------------|--------------------|

Note:

1. This type mapping is valid only for CTLIB with Sybase server version 12.0 (or earlier).
2. This type mapping is valid only for CTLIB with Sybase server version 12.5 (or later).

## Teradata data sources

The following table lists the reverse default data type mappings for Teradata data sources.

Table 179. Teradata reverse default data type mappings (Not all columns shown)

| Federated<br>Typename | Federated<br>Lower Len | Federated<br>Upper Len | Federated<br>Lower Scale | Federated<br>Upper Scale | Federated Bit<br>Data | Federated<br>Data<br>Operators | Remote<br>Typename | Remote<br>Length | Remote Scale | Remote Bit<br>Data |
|-----------------------|------------------------|------------------------|--------------------------|--------------------------|-----------------------|--------------------------------|--------------------|------------------|--------------|--------------------|
| BLOB <sup>1</sup>     | 1                      | 64000                  | -                        | -                        | -                     | -                              | VARBYTE            | -                | -            | -                  |
| CHARACTER             | -                      | -                      | -                        | -                        | -                     | -                              | CHARACTER          | -                | -            | -                  |
| CHARACTER             | -                      | -                      | -                        | -                        | Y                     | -                              | BYTE               | -                | -            | -                  |
| CLOB <sup>2</sup>     | 1                      | 64000                  | -                        | -                        | -                     | -                              | VARCHAR            | -                | -            | -                  |
| DATE                  | -                      | -                      | -                        | -                        | -                     | -                              | DATE               | -                | -            | -                  |
| DBCLOB <sup>3</sup>   | 1                      | 32000                  | -                        | -                        | -                     | -                              | VARGRAPHIC         | -                | -            | -                  |
| DECIMAL               | 1                      | 18                     | 0                        | 18                       | -                     | -                              | DECIMAL            | -                | -            | -                  |
| DECIMAL               | 19                     | 31                     | 0                        | 31                       | -                     | -                              | FLOAT              | -                | -            | -                  |
| DOUBLE                | -                      | -                      | -                        | -                        | -                     | -                              | FLOAT              | -                | -            | -                  |
| GRAPHIC               | -                      | -                      | -                        | -                        | -                     | -                              | GRAPHIC            | -                | -            | -                  |
| INTEGER               | -                      | -                      | -                        | -                        | -                     | -                              | INTEGER            | -                | -            | -                  |
| REAL                  | -                      | -                      | -                        | -                        | -                     | -                              | FLOAT              | -                | -            | -                  |
| SMALLINT              | -                      | -                      | -                        | -                        | -                     | -                              | SMALLINT           | -                | -            | -                  |
| TIME                  | -                      | -                      | -                        | -                        | -                     | -                              | TIME               | -                | -            | -                  |
| TIMESTAMP             | -                      | -                      | -                        | -                        | -                     | -                              | TIMESTAMP          | -                | -            | -                  |
| VARCHAR               | -                      | -                      | -                        | -                        | -                     | -                              | VARCHAR            | -                | -            | -                  |
| VARCHAR               | -                      | -                      | -                        | -                        | Y                     | -                              | VARBYTE            | -                | -            | -                  |
| VARGRAPHIC            | -                      | -                      | -                        | -                        | -                     | -                              | VARGRAPHIC         | -                | -            | -                  |

Note:

1. The Teradata VARBYTE data type can contain only the specified length (1 to 64000) of a BLOB data type.
2. The Teradata VARCHAR data type can contain only the specified length (1 to 64000) of a CLOB data type.
3. The Teradata VARGRAPHIC data type can contain only the specified length (1 to 32000) of a DBCLOB data type.

---

## Appendix F. The SAMPLE database and SQL Reference examples

Many of the code examples in the DB2 documentation use the SAMPLE database.

You can create the SAMPLE database by issuing the `db2sampl` command, or you can create it from First Steps. The SAMPLE database contains tables and data, including tables with XML columns and XML data, where supported, that are referenced by examples in the SQL Reference and by sample applications that are provided with DB2 Version 9.1.

You can use the data in the SAMPLE database to experiment with SQL statements, or to learn about and test DB2 database features.

For more information, see “`db2sampl` - Create sample database command” or “The SAMPLE database” in the DB2 Information Center.



---

## Appendix G. Reserved schema names and reserved words

There are restrictions on the use of certain names that are required by the database manager. In some cases, names are reserved, and cannot be used by application programs. In other cases, certain names are not recommended for use by application programs, although their use is not prevented by the database manager.

The reserved schema names are:

- SYSCAT
- SYSFUN
- SYSIBM
- SYSSTAT
- SYSPROC

It is strongly recommended that schema names never begin with the 'SYS' prefix, because 'SYS', by convention, is used to indicate an area that is reserved by the system. No user-defined functions, user-defined types, triggers, or aliases can be placed into a schema whose name starts with 'SYS' (SQLSTATE 42939).

The DB2QP schema and the SYSTOOLS schema are set aside for use by DB2 tools. It is recommended that users not explicitly define objects in these schemas, although their use is not prevented by the database manager.

It is also recommended that SESSION not be used as a schema name. Because declared temporary tables must be qualified by SESSION, it is possible to have an application declare a temporary table with a name that is identical to that of a persistent table, complicating the application logic. To avoid this possibility, do not use the schema SESSION except when dealing with declared temporary tables.

There are no specifically reserved words in DB2 Version 9. Keywords can be used as ordinary identifiers, except in a context where they could also be interpreted as SQL keywords. In such cases, the word must be specified as a delimited identifier. For example, COUNT cannot be used as a column name in a SELECT statement, unless it is delimited.

ISO/ANSI SQL99 and other DB2 database products include reserved words that are not enforced by DB2 Database for Linux, UNIX, and Windows; however, it is recommended that these words not be used as ordinary identifiers, because it reduces portability.

For portability across the DB2 database products, the following should be considered reserved words:

|          |            |                |                    |
|----------|------------|----------------|--------------------|
| ACTIVATE | DISALLOW   | LOCALE         | RESULT             |
| ADD      | DISCONNECT | LOCALTIME      | RESULT_SET_LOCATOR |
| AFTER    | DISTINCT   | LOCALTIMESTAMP | RETURN             |
| ALIAS    | DO         | LOCATOR        | RETURNS            |
| ALL      | DOUBLE     | LOCATORS       | REVOKE             |
| ALLOCATE | DROP       | LOCK           | RIGHT              |
| ALLOW    | DSSIZE     | LOCKMAX        | ROLLBACK           |
| ALTER    | DYNAMIC    | LOCKSIZE       | ROUTINE            |
| AND      | EACH       | LONG           | ROW                |
| ANY      | EDITPROC   | LOOP           | ROW_NUMBER         |

## Reserved schema names and reserved words

|                   |              |              |              |
|-------------------|--------------|--------------|--------------|
| AS                | ELSE         | MAINTAINED   | ROWNUMBER    |
| ASENSITIVE        | ELSEIF       | MATERIALIZED | ROWS         |
| ASSOCIATE         | ENABLE       | MAXVALUE     | ROWSET       |
| ASUTIME           | ENCODING     | MICROSECOND  | RRN          |
| AT                | ENCRYPTION   | MICROSECONDS | RUN          |
| ATTRIBUTES        | END          | MINUTE       | SAVEPOINT    |
| AUDIT             | END-EXEC     | MINUTES      | SCHEMA       |
| AUTHORIZATION     | ENDING       | MINVALUE     | SCRATCHPAD   |
| AUX               | ERASE        | MODE         | SCROLL       |
| AUXILIARY         | ESCAPE       | MODIFIES     | SEARCH       |
| BEFORE            | EVERY        | MONTH        | SECOND       |
| BEGIN             | EXCEPT       | MONTHS       | SECONDS      |
| BETWEEN           | EXCEPTION    | NEW          | SECQTY       |
| BINARY            | EXCLUDING    | NEW_TABLE    | SECURITY     |
| BUFFERPOOL        | EXCLUSIVE    | NEXTVAL      | SELECT       |
| BY                | EXECUTE      | NO           | SENSITIVE    |
| CACHE             | EXISTS       | NOCACHE      | SEQUENCE     |
| CALL              | EXIT         | NOCYCLE      | SESSION      |
| CALLED            | EXPLAIN      | NODENAME     | SESSION_USER |
| CAPTURE           | EXTERNAL     | NODENUMBER   | SET          |
| CARDINALITY       | EXTRACT      | NOMAXVALUE   | SIGNAL       |
| CASCADE           | FENCED       | NOMINVALUE   | SIMPLE       |
| CASE              | FETCH        | NONE         | SOME         |
| CAST              | FIELDPROC    | NOORDER      | SOURCE       |
| CCSID             | FILE         | NORMALIZED   | SPECIFIC     |
| CHAR              | FINAL        | NOT          | SQL          |
| CHARACTER         | FOR          | NULL         | SQLID        |
| CHECK             | FOREIGN      | NULLS        | STACKED      |
| CLOSE             | FREE         | NUMPARTS     | STANDARD     |
| CLUSTER           | FROM         | OBID         | START        |
| COLLECTION        | FULL         | OF           | STARTING     |
| COLLID            | FUNCTION     | OLD          | STATEMENT    |
| COLUMN            | GENERAL      | OLD_TABLE    | STATIC       |
| COMMENT           | GENERATED    | ON           | STAY         |
| COMMIT            | GET          | OPEN         | STOGROUP     |
| CONCAT            | GLOBAL       | OPTIMIZATION | STORES       |
| CONDITION         | GO           | OPTIMIZE     | STYLE        |
| CONNECT           | GOTO         | OPTION       | SUBSTRING    |
| CONNECTION        | GRANT        | OR           | SUMMARY      |
| CONSTRAINT        | GRAPHIC      | ORDER        | SYNONYM      |
| CONTAINS          | GROUP        | OUT          | SYSFUN       |
| CONTINUE          | HANDLER      | OUTER        | SYSIBM       |
| COUNT             | HASH         | OVER         | SYSPROC      |
| COUNT_BIG         | HASHED_VALUE | OVERRIDING   | SYSTEM       |
| CREATE            | HAVING       | PACKAGE      | SYSTEM_USER  |
| CROSS             | HINT         | PADDED       | TABLE        |
| CURRENT           | HOLD         | PAGESIZE     | TABLESPACE   |
| CURRENT_DATE      | HOURL        | PARAMETER    | THEN         |
| CURRENT_LC_CTYPE  | HOURS        | PART         | TIME         |
| CURRENT_PATH      | IDENTITY     | PARTITION    | TIMESTAMP    |
| CURRENT_SCHEMA    | IF           | PARTITIONED  | TO           |
| CURRENT_SERVER    | IMMEDIATE    | PARTITIONING | TRANSACTION  |
| CURRENT_TIME      | IN           | PARTITIONS   | TRIGGER      |
| CURRENT_TIMESTAMP | INCLUDING    | PASSWORD     | TRIM         |
| CURRENT_TIMEZONE  | INCLUSIVE    | PATH         | TYPE         |
| CURRENT_USER      | INCREMENT    | PIECESIZE    | UNDO         |
| CURSOR            | INDEX        | PLAN         | UNION        |
| CYCLE             | INDICATOR    | POSITION     | UNIQUE       |
| DATA              | INHERIT      | PRECISION    | UNTIL        |
| DATABASE          | INNER        | PREPARE      | UPDATE       |
| DATAPARTITIONNAME | INOUT        | PREVVAL      | USAGE        |
| DATAPARTITIONNUM  | INSENSITIVE  | PRIMARY      | USER         |
| DATE              | INSERT       | PRIQTY       | USING        |
| DAY               | INTEGRITY    | PRIVILEGES   | VALIDPROC    |
| DAYS              | INTERSECT    | PROCEDURE    | VALUE        |
| DB2GENERAL        | INTO         | PROGRAM      | VALUES       |
| DB2GENRL          | IS           | PSID         | VARIABLE     |

## Reserved schema names and reserved words

|                 |           |             |           |
|-----------------|-----------|-------------|-----------|
| DB2SQL          | ISOBID    | QUERY       | VARIANT   |
| DBINFO          | ISOLATION | QUERYNO     | VCAT      |
| DBPARTITIONNAME | ITERATE   | RANGE       | VERSION   |
| DBPARTITIONNUM  | JAR       | RANK        | VIEW      |
| DEALLOCATE      | JAVA      | READ        | VOLATILE  |
| DECLARE         | JOIN      | READS       | VOLUMES   |
| DEFAULT         | KEY       | RECOVERY    | WHEN      |
| DEFAULTS        | LABEL     | REFERENCES  | WHENEVER  |
| DEFINITION      | LANGUAGE  | REFERENCING | WHERE     |
| DELETE          | LATERAL   | REFRESH     | WHILE     |
| DENSE_RANK      | LC_CTYPE  | RELEASE     | WITH      |
| DENSERANK       | LEAVE     | RENAME      | WITHOUT   |
| DESCRIBE        | LEFT      | REPEAT      | WLM       |
| DESCRIPTOR      | LIKE      | RESET       | WRITE     |
| DETERMINISTIC   | LINKTYPE  | RESIGNAL    | XMLLEMENT |
| DIAGNOSTICS     | LOCAL     | RESTART     | YEAR      |
| DISABLE         | LOCALDATE | RESTRICT    | YEARS     |

The following list contains the ISO/ANSI SQL2003 reserved words that are not in the previous list:

|                                  |                 |                 |
|----------------------------------|-----------------|-----------------|
| ABS                              | GROUPING        | REGR_INTERCEPT  |
| ARE                              | INT             | REGR_R2         |
| ARRAY                            | INTEGER         | REGR_SLOPE      |
| ASYMMETRIC                       | INTERSECTION    | REGR_SXX        |
| ATOMIC                           | INTERVAL        | REGR_SXY        |
| AVG                              | LARGE           | REGR_SYY        |
| BIGINT                           | LEADING         | ROLLUP          |
| BLOB                             | LN              | SCOPE           |
| BOOLEAN                          | LOWER           | SIMILAR         |
| BOTH                             | MATCH           | SMALLINT        |
| CEIL                             | MAX             | SPECIFICITY     |
| CEILING                          | MEMBER          | SQLEXCEPTION    |
| CHAR_LENGTH                      | MERGE           | SQLSTATE        |
| CHARACTER_LENGTH                 | METHOD          | SQLWARNING      |
| CLOB                             | MIN             | SQRT            |
| COALESCE                         | MOD             | STDDEV_POP      |
| COLLATE                          | MODULE          | STDDEV_SAMP     |
| COLLECT                          | MULTISET        | SUBMULTISET     |
| CONVERT                          | NATIONAL        | SUM             |
| CORR                             | NATURAL         | SYMMETRIC       |
| CORRESPONDING                    | NCHAR           | TABLESAMPLE     |
| COVAR_POP                        | NCLOB           | TIMEZONE_HOUR   |
| COVAR_SAMP                       | NORMALIZE       | TIMEZONE_MINUTE |
| CUBE                             | NULLIF          | TRAILING        |
| CUME_DIST                        | NUMERIC         | TRANSLATE       |
| CURRENT_DEFAULT_TRANSFORM_GROUP  | OCTET_LENGTH    | TRANSLATION     |
| CURRENT_ROLE                     | ONLY            | TREAT           |
| CURRENT_TRANSFORM_GROUP_FOR_TYPE | OVERLAPS        | TRUE            |
| DEC                              | OVERLAY         | UESCAPE         |
| DECIMAL                          | PERCENT_RANK    | UNKNOWN         |
| DEREF                            | PERCENTILE_CONT | UNNEST          |
| ELEMENT                          | PERCENTILE_DISC | UPPER           |
| EXEC                             | POWER           | VAR_POP         |
| EXP                              | REAL            | VAR_SAMP        |
| FALSE                            | RECURSIVE       | VARCHAR         |
| FILTER                           | REF             | VARYING         |
| FLOAT                            | REGR_AVGX       | WIDTH_BUCKET    |
| FLOOR                            | REGR_AVGY       | WINDOW          |
| FUSION                           | REGR_COUNT      | WITHIN          |

## Reserved schema names and reserved words



## Appendix H. Interaction of triggers and constraints

This appendix describes the interaction of triggers with referential constraints and check constraints that may result from an update operation. Figure 14 and the associated description are representative of the processing that is performed for an SQL statement that updates data in the database.

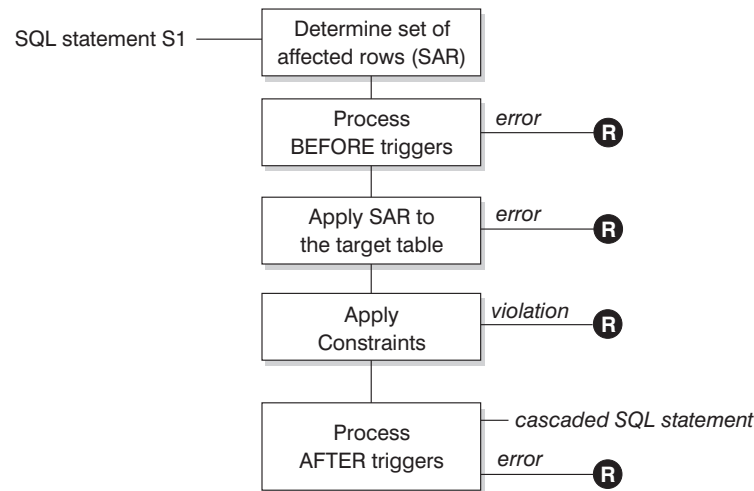

**R** = rollback changes to before S1

Figure 14. Processing an SQL statement with associated triggers and constraints

Figure 14 shows the general order of processing for an SQL statement that updates a table. It assumes a situation where the table includes before triggers, referential constraints, check constraints and after triggers that cascade. The following is a description of the boxes and other items found in Figure 14.

- SQL statement  $S_1$

This is the DELETE, INSERT, or UPDATE statement that begins the process. The SQL statement  $S_1$  identifies a table (or an updatable view over some table) referred to as the *target table* throughout this description.

- Determine set of affected rows (SAR)

This step is the starting point for a process that repeats for referential constraint delete rules of CASCADE and SET NULL and for cascaded SQL statements from after triggers.

The purpose of this step is to determine the *set of affected rows* for the SQL statement. The set of rows included in SAR is based on the statement:

- for DELETE, all rows that satisfy the search condition of the statement (or the current row for a positioned DELETE)
- for INSERT, the rows identified by the VALUES clause or the fullselect
- for UPDATE, all rows that satisfy the search condition (or the current row for a positioned update).

If SAR is empty, there will be no BEFORE triggers, changes to apply to the target table, or constraints to process for the SQL statement.

- Process BEFORE triggers

## Interaction of triggers and constraints

All BEFORE triggers are processed in ascending order of creation. Each BEFORE trigger will process the triggered action once for each row in *SAR*.

An error may occur during the processing of a triggered action in which case all changes made as a result of the original SQL statement  $S_1$  (so far) are rolled back.

If there are no BEFORE triggers or the *SAR* is empty, this step is skipped.

- Apply *SAR* to the target table

The actual delete, insert, or update is applied using *SAR* to the target table in the database.

An error may occur when applying *SAR* (such as attempting to insert a row with a duplicate key where a unique index exists) in which case all changes made as a result of the original SQL statement  $S_1$  (so far) are rolled back.

- Apply Constraints

The constraints associated with the target table are applied if *SAR* is not empty. This includes unique constraints, unique indexes, referential constraints, check constraints and checks related to the WITH CHECK OPTION on views. Referential constraints with delete rules of cascade or set null may cause additional triggers to be activated.

A violation of any constraint or WITH CHECK OPTION results in an error and all changes made as a result of  $S_1$  (so far) are rolled back.

- Process AFTER triggers

All AFTER triggers activated by  $S_1$  are processed in ascending order of creation. FOR EACH STATEMENT triggers will process the triggered action exactly once, even if *SAR* is empty. FOR EACH ROW triggers will process the triggered action once for each row in *SAR*.

An error may occur during the processing of a triggered action in which case all changes made as a result of the original  $S_1$  (so far) are rolled back.

The triggered action of a trigger may include triggered SQL statements that are DELETE, INSERT or UPDATE statements. For the purposes of this description, each such statement is considered a *cascaded SQL statement*.

A cascaded SQL statement is a DELETE, INSERT, or UPDATE statement that is processed as part of the triggered action of an AFTER trigger. This statement starts a cascaded level of trigger processing. This can be thought of as assigning the triggered SQL statement as a new  $S_1$  and performing all of the steps described here recursively.

Once all triggered SQL statements from all AFTER triggers activated by each  $S_1$  have been processed to completion, the processing of the original  $S_1$  is completed.

- **R** = roll back changes to before  $S_1$

Any error (including constraint violations) that occurs during processing results in a roll back of all the changes made directly or indirectly as a result of the original SQL statement  $S_1$ . The database is therefore back in the same state as immediately prior to the execution of the original SQL statement  $S_1$

---

## Appendix I. Explain tables

---

### Explain tables

The Explain tables capture access plans when the Explain facility is activated. The Explain tables must be created before Explain can be invoked. You can create them using the documented table definitions, or you can create them by invoking the sample command line processor (CLP) script provided in the EXPLAIN.DDL file located in the misc subdirectory of the sqllib directory. To invoke the script, connect to the database where the Explain tables are required, then issue the command:

```
db2 -tf EXPLAIN.DDL
```

The Explain facility uses the following IDs as the schema when qualifying Explain tables that it is populating:

- The session authorization ID for dynamic SQL
- The statement authorization ID for static SQL

The schema can be associated with a set of Explain tables, or aliases that point to a set of Explain tables under a different schema. If no Explain tables are found under the schema, the Explain facility checks for Explain tables under the SYSTOOLS schema and attempts to use those tables.

The population of the Explain tables by the Explain facility will not activate triggers or referential or check constraints. For example, if an insert trigger were defined on the EXPLAIN\_INSTANCE table, and an eligible statement were explained, the trigger would not be activated.

To improve the performance of the Explain facility in a partitioned database system, it is recommended that the Explain tables be created in a single partition database partition group, preferably on the same database partition to which you will be connected when compiling the query.

**Related reference:**

- “ADVISE\_INDEX table” on page 812
- “ADVISE\_INSTANCE table” on page 815
- “ADVISE\_MQT table” on page 816
- “ADVISE\_PARTITION table” on page 817
- “ADVISE\_TABLE table” on page 818
- “ADVISE\_WORKLOAD table” on page 819
- “EXPLAIN\_ARGUMENT table” on page 790
- “EXPLAIN\_INSTANCE table” on page 797
- “EXPLAIN\_OBJECT table” on page 800
- “EXPLAIN\_OPERATOR table” on page 803
- “EXPLAIN\_PREDICATE table” on page 805
- “EXPLAIN\_STATEMENT table” on page 808
- “EXPLAIN\_STREAM table” on page 810

## EXPLAIN\_ARGUMENT table

### EXPLAIN\_ARGUMENT table

The EXPLAIN\_ARGUMENT table represents the unique characteristics for each individual operator, if there are any.

*Table 180. EXPLAIN\_ARGUMENT Table.* PK means that the column is part of a primary key; FK means that the column is part of a foreign key.

| Column Name         | Data Type     | Nullable? | Key? | Description  |
|---------------------|---------------|-----------|------|--|
| EXPLAIN_REQUESTER   | VARCHAR(128)  | No        | FK   | Authorization ID of initiator of this Explain request.   |
| EXPLAIN_TIME        | TIMESTAMP     | No        | FK   | Time of initiation for Explain request.  |
| SOURCE_NAME         | VARCHAR(128)  | No        | FK   | Name of the package running when the dynamic statement was explained or name of the source file when static SQL was explained.     |
| SOURCE_SCHEMA       | VARCHAR(128)  | No        | FK   | Schema, or qualifier, of source of Explain request.  |
| SOURCE_VERSION      | VARCHAR(64)   | No        | FK   | Version of the source of the Explain request.  |
| EXPLAIN_LEVEL       | CHAR(1)       | No        | FK   | Level of Explain information for which this row is relevant.   |
| STMTNO              | INTEGER       | No        | FK   | Statement number within package to which this Explain information is related.  |
| SECTNO              | INTEGER       | No        | FK   | Section number within package to which this Explain information is related.  |
| OPERATOR_ID         | INTEGER       | No        | No   | Unique ID for this operator within this query.   |
| ARGUMENT_TYPE       | CHAR(8)       | No        | No   | The type of argument for this operator.  |
| ARGUMENT_VALUE      | VARCHAR(1024) | Yes       | No   | The value of the argument for this operator. NULL if the value is in LONG_ARGUMENT_VALUE.  |
| LONG_ARGUMENT_VALUE | CLOB(2M)      | Yes       | No   | The value of the argument for this operator, when the text will not fit in ARGUMENT_VALUE. NULL if the value is in ARGUMENT_VALUE. |

*Table 181. ARGUMENT\_TYPE and ARGUMENT\_VALUE column values*

| ARGUMENT_TYPE Value | Possible ARGUMENT_VALUE Values   | Description   |
|---------------------|--|---|
| AGGMODE             | COMPLETE<br>PARTIAL<br>INTERMEDIATE<br>FINAL                             | Partial aggregation indicators.                         |
| BITFLTR             | INTEGER<br>FALSE   | Size of bit filter used by hash join.                   |
| BLD_LEVEL           | DB2 Build Identifier   | Internal identification string for source code version. |
| BLKLOCK             | EXCLUSIVE<br>INTENT EXCLUSIVE<br>INTENT SHARE<br>NONE<br>SHARE<br>UPDATE | Block level lock intent.                                |
| CSERQY              | TRUE<br>FALSE  | Remote query is a common subexpression.                 |
| CSETEMP             | TRUE<br>FALSE  | Temporary Table over Common Subexpression Flag.         |
| DIRECT              | TRUE   | Direct fetch indicator.                                 |

Table 181. ARGUMENT\_TYPE and ARGUMENT\_VALUE column values (continued)

| ARGUMENT_TYPE Value | Possible ARGUMENT_VALUE Values   | Description  |
|---------------------|--|--|
| DPESTFLG            | TRUE<br>FALSE  | Indicates whether or not the DPNUMPRT value is based on an estimate. Possible values are 'TRUE' (DPNUMPRT represents the estimated number of accessed data partitions) or 'FALSE' (DPNUMPRT represents the actual number of accessed data partitions).           |
| DPLSTPRT            | NONE<br>CHARACTER  | Represents accessed data partitions. It is a comma-delimited list (for example: 1,3,5) or a hyphenated list (for example: 1-5) of accessed data partitions. A value of 'NONE' means that no data partition remains after specified predicates have been applied. |
| DPNUMPRT            | INTEGER  | Represents the actual or estimated number of data partitions accessed.   |
| DSTSEVER            | Server name  | Destination (ship from) server.  |
| DUPLWARN            | TRUE<br>FALSE  | Duplicates Warning flag.   |
| EARLYOUT            | LEFT<br>RIGHT<br>NONE  | Early out indicator.   |
| ENVVAR              | Each row of this type will contain: <ul style="list-style-type: none"> <li>• Environment variable name</li> <li>• Environment variable value</li> </ul>  | Environment variable affecting the optimizer   |
| ERRTOL              | Each row of this type will contain an SQLSTATE and SQLCODE pair.   | A list of errors to be tolerated.  |
| FETCHMAX            | IGNORE<br>INTEGER  | Override value for MAXPAGES argument on FETCH operator.  |
| GREEDY              | TRUE   | Indicates optimizer used greedy algorithm to plan access.  |
| GLOBLOCK            | EXCLUSIVE<br>INTENT EXCLUSIVE<br>INTENT NONE<br>INTENT SHARE<br>NO LOCK OBTAINED<br>SHARE<br>SHARE INTENT EXCLUSIVE<br>SUPER EXCLUSIVE<br>UPDATE   | Represents global lock intent information for a partitioned table object.  |
| GROUPBYC            | TRUE<br>FALSE  | Whether Group By columns were provided.  |
| GROUPBYN            | Integer  | Number of comparison columns.  |
| GROUPBYR            | Each row of this type will contain: <ul style="list-style-type: none"> <li>• Ordinal value of column in group by clause (followed by a colon and a space)</li> <li>• Name of column</li> </ul> | Group By requirement.  |
| HASHCODE            | 24<br>32   | Size (in bits) of hash code used for hash join.  |

## EXPLAIN\_ARGUMENT table

Table 181. ARGUMENT\_TYPE and ARGUMENT\_VALUE column values (continued)

| ARGUMENT_TYPE Value | Possible ARGUMENT_VALUE Values   | Description   |
|---------------------|--|---|
| INNERCOL            | Each row of this type will contain: <ul style="list-style-type: none"> <li>• Ordinal value of column in order (followed by a colon and a space)</li> <li>• Name of column</li> <li>• Order value</li> </ul> <p>(A) Ascending</p> <p>(D) Descending</p> | Inner order columns.  |
| INPUTXID            | A context node identifier  | INPUTXID identifies the input context node used by the XSCAN operator.  |
| ISCANMAX            | IGNORE<br>INTEGER  | Override value for MAXPAGES argument on ISCAN operator.   |
| JN_INPUT            | INNER<br>OUTER   | Indicates if operator is the operator feeding the inner or outer of a join.                                   |
| LISTENER            | TRUE<br>FALSE  | Listener Table Queue indicator.   |
| MAXPAGES            | ALL<br>NONE<br>INTEGER   | Maximum pages expected for Prefetch.  |
| MAXRIDS             | NONE<br>INTEGER  | Maximum Row Identifiers to be included in each list prefetch request.   |
| NUMROWS             | INTEGER  | Number of rows expected to be sorted.   |
| ONEFETCH            | TRUE<br>FALSE  | One Fetch indicator.  |
| OUTERCOL            | Each row of this type will contain: <ul style="list-style-type: none"> <li>• Ordinal value of column in order (followed by a colon and a space)</li> <li>• Name of column</li> <li>• Order value</li> </ul> <p>(A) Ascending</p> <p>(D) Descending</p> | Outer order columns.  |
| OUTERJN             | LEFT<br>RIGHT<br>FULL<br>LEFT (ANTI)<br>RIGHT (ANTI)   | Outer join indicator.   |
| PARTCOLS            | Name of Column   | Partitioning columns for operator.  |
| PREFETCH            | LIST<br>NONE<br>SEQUENTIAL   | Type of Prefetch Eligible.  |
| REOPT               | ALWAYS<br>ONCE   | The statement is optimized using bind-in values for parameter markers, host variables, and special registers. |
| RMTQTEXT            | Query text   | Remote Query Text   |
| RNG_PROD            | Function name  | Range producing function for extended index access.   |

Table 181. ARGUMENT\_TYPE and ARGUMENT\_VALUE column values (continued)

| ARGUMENT_TYPE Value | Possible ARGUMENT_VALUE Values   | Description  |
|---------------------|--|--|
| ROWLOCK             | EXCLUSIVE<br>NONE<br>REUSE<br>SHARE<br>SHORT (INSTANT) SHARE<br>UPDATE   | Row Lock Intent.   |
| ROWWIDTH            | INTEGER  | Width of row to be sorted.   |
| RSUFFIX             | Query text   | Remote SQL suffix.   |
| SCANDIR             | FORWARD<br>REVERSE   | Scan Direction.  |
| SCANGRAN            | INTEGER  | Intra-partition parallelism, granularity of the intra-partition parallel scan, expressed in SCANUNITS. |
| SCANTYPE            | LOCAL PARALLEL   | intra-partition parallelism, Index or Table scan.  |
| SCANUNIT            | ROW<br>PAGE  | Intra-partition parallelism, scan granularity unit.  |
| SHARED              | TRUE   | Intra-partition parallelism, shared TEMP indicator.  |
| SLOWMAT             | TRUE<br>FALSE  | Slow Materialization flag.   |
| SNGLPROD            | TRUE<br>FALSE  | Intra-partition parallelism sort or temp produced by a single agent.                                   |
| SORTKEY             | Each row of this type will contain: <ul style="list-style-type: none"> <li>• Ordinal value of column in key (followed by a colon and a space)</li> <li>• Name of column</li> <li>• Order value <ul style="list-style-type: none"> <li>(A) Ascending</li> <li>(D) Descending</li> </ul> </li> </ul> | Sort key columns.  |
| SORTTYPE            | PARTITIONED<br>SHARED<br>ROUND ROBIN<br>REPLICATED   | Intra-partition parallelism, sort type.  |
| SRCSEVER            | Server name  | Source (ship to) server.   |
| SPILLED             | INTEGER  | Estimated number of pages in SORT spill.   |
| SQLCA               | Warning information  | Warnings and reason codes issued during Explain operation.   |
| STMTHEAP            | INTEGER  | Size of statement heap at start of statement compile.  |
| STREAM              | TRUE<br>FALSE  | Remote source is streaming.  |
| TABLOCK             | EXCLUSIVE<br>INTENT EXCLUSIVE<br>INTENT NONE<br>INTENT SHARE<br>REUSE<br>SHARE<br>SHARE INTENT EXCLUSIVE<br>SUPER EXCLUSIVE<br>UPDATE  | Table Lock Intent.   |
| TEMPSIZE            | INTEGER  | Temporary table page size.   |
| TQDEGREE            | INTEGER  | Intra-partition parallelism, number of subagents accessing Table Queue.                                |

## EXPLAIN\_ARGUMENT table

Table 181. ARGUMENT\_TYPE and ARGUMENT\_VALUE column values (continued)

| ARGUMENT_TYPE<br>Value | Possible ARGUMENT_VALUE Values   | Description  |
|------------------------|--|--|
| TQMERGE                | TRUE<br>FALSE  | Merging (sorted) Table Queue indicator.  |
| TQREAD                 | READ AHEAD<br>STEPPING<br>SUBQUERY STEPPING  | Table Queue reading property.  |
| TQSEND                 | BROADCAST<br>DIRECTED<br>SCATTER<br>SUBQUERY DIRECTED  | Table Queue send property.   |
| TQTYPE                 | LOCAL  | Intra-partition parallelism, Table Queue.  |
| TQ_ORIGIN              | ASYNCHRONY   | The reason that Table Queue was introduced into the access plan.   |
| TRUNCSRT               | TRUE   | Truncated sort (limits number of rows produced).   |
| UNIQUE                 | TRUE<br>FALSE  | Uniqueness indicator.  |
| UNIQKEY                | Each row of this type will contain: <ul style="list-style-type: none"> <li>• Ordinal value of column in key (followed by a colon and a space)</li> <li>• Name of Column</li> </ul> | Unique key columns.  |
| VOLATILE               | TRUE   | Volatile table   |
| XDFOUT                 | DECIMAL  | XDFOUT indicates the expected number of documents to be returned by the XISCAN operator for each context node.   |
| XLOGID                 | An identifier consisting of an SQL schema name and the name of an index over XML data  | XLOGID identifies the index over XML data chosen by the optimizer for the XISCAN operator.                       |
| XPATH                  | An XPATH expression and result set in an internal format   | This argument indicates the evaluation of an XPATH expression by the XSCAN operator.                             |
| XPHYID                 | An identifier consisting of an SQL schema name and the name of a physical index over XML data  | XPHYID identifies the physical index that is associated with an index over XML data used by the XISCAN operator. |



## EXPLAIN\_DIAGNOSTIC table

The EXPLAIN\_DIAGNOSTIC table contains an entry for each diagnostic message produced for a particular instance of an explained statement in the EXPLAIN\_STATEMENT table.

The EXPLAIN\_GET\_MSGS table function queries the EXPLAIN\_DIAGNOSTIC and EXPLAIN\_DIAGNOSTIC\_DATA Explain tables and returns formatted messages.

*Table 182. EXPLAIN\_DIAGNOSTIC Table.* PK means that the column is part of a primary key; FK means that the column is part of a foreign key.

| Column Name       | Data Type    | Nullable? | Key?   | Description  |
|-------------------|--------------|-----------|--------|--|
| EXPLAIN_REQUESTER | VARCHAR(128) | No        | PK, FK | Authorization ID of initiator of this Explain request.   |
| EXPLAIN_TIME      | TIMESTAMP    | No        | PK, FK | Time of initiation for Explain request.  |
| SOURCE_NAME       | VARCHAR(128) | No        | PK, FK | Name of the package running when the dynamic statement was explained or name of the source file when the static SQL was explained.   |
| SOURCE_SCHEMA     | VARCHAR(128) | No        | PK, FK | Schema, or qualifier, of source of Explain request.  |
| SOURCE_VERSION    | VARCHAR(64)  | No        | PK, FK | Version of the source of the Explain request.  |
| EXPLAIN_LEVEL     | CHAR(1)      | No        | PK, FK | Level of Explain information for which this row is relevant. Valid values are:<br><br><b>O</b> Original text (as entered by user)<br><b>P</b> PLAN SELECTION   |
| STMTNO            | INTEGER      | No        | PK, FK | Statement number within package to which this Explain information is related. Set to 1 for dynamic Explain SQL statements. For static SQL statements, this value is the same as the value used for the SYSCAT.STATEMENTS system catalog view.  |
| SECTNO            | INTEGER      | No        | PK, FK | Section number within package that contains this SQL statement. For dynamic Explain SQL statements, this is the section number used to hold the section for this statement at run time. For static SQL statements, this value is the same as the value used for the SYSCAT.STATEMENTS system catalog view. |
| DIAGNOSTIC_ID     | INTEGER      | No        | PK     | ID of the diagnostic for a particular instance of a statement in the EXPLAIN_STATEMENT table.  |
| CODE              | INTEGER      | No        | No     | A unique number assigned to each diagnostic message. The number can be used by a message API to retrieve the full text of the diagnostic message.  |

### Related reference:

- “EXPLAIN\_DIAGNOSTIC\_DATA table” on page 796
- “EXPLAIN\_GET\_MSGS table function” in *Administrative SQL Routines and Views*
- “EXPLAIN\_STATEMENT table” on page 808
- “SYSCAT.STATEMENTS ” on page 691

---

**EXPLAIN\_DIAGNOSTIC\_DATA table**

The EXPLAIN\_DIAGNOSTIC\_DATA table contains message tokens for specific diagnostic messages that are recorded in the EXPLAIN\_DIAGNOSTIC table. The message tokens provide additional information that is specific to the execution of the SQL statement that generated the message.

The EXPLAIN\_GET\_MSGS table function queries the EXPLAIN\_DIAGNOSTIC and EXPLAIN\_DIAGNOSTIC\_DATA Explain tables, and returns formatted messages.

*Table 183. EXPLAIN\_DIAGNOSTIC\_DATA Table.* PK means that the column is part of a primary key; FK means that the column is part of a foreign key.

| Column Name       | Data Type     | Nullable? | Key? | Description  |
|-------------------|---------------|-----------|------|--|
| EXPLAIN_REQUESTER | VARCHAR(128)  | No        | FK   | Authorization ID of initiator of this Explain request.   |
| EXPLAIN_TIME      | TIMESTAMP     | No        | FK   | Time of initiation for Explain request.  |
| SOURCE_NAME       | VARCHAR(128)  | No        | FK   | Name of the package running when the dynamic statement was explained or name of the source file when the static SQL was explained.   |
| SOURCE_SCHEMA     | VARCHAR(128)  | No        | FK   | Schema, or qualifier, of source of Explain request.  |
| SOURCE_VERSION    | VARCHAR(64)   | No        | FK   | Version of the source of the Explain request.  |
| EXPLAIN_LEVEL     | CHAR(1)       | No        | FK   | Level of Explain information for which this row is relevant. Valid values are:<br><br><b>O</b> Original text (as entered by user)<br><b>P</b> PLAN SELECTION   |
| STMTNO            | INTEGER       | No        | FK   | Statement number within package to which this Explain information is related. Set to 1 for dynamic Explain SQL statements. For static SQL statements, this value is the same as the value used for the SYSCAT.STATEMENTS system catalog view.  |
| SECTNO            | INTEGER       | No        | FK   | Section number within package that contains this SQL statement. For dynamic Explain SQL statements, this is the section number used to hold the section for this statement at run time. For static SQL statements, this value is the same as the value used for the SYSCAT.STATEMENTS system catalog view. |
| DIAGNOSTIC_ID     | INTEGER       | No        | PK   | ID of the diagnostic for a particular instance of a statement in the EXPLAIN_STATEMENT table.  |
| ORDINAL           | INTEGER       | No        | No   | Position of token in the full message text.  |
| TOKEN             | VARCHAR(1000) | Yes       | No   | Message token to be inserted into the full message text; might be truncated.   |
| TOKEN_LONG        | BLOB(3M)      | Yes       | No   | More detailed information, if available.   |

**Related reference:**

- “EXPLAIN\_DIAGNOSTIC table” on page 795
- “EXPLAIN\_GET\_MSGS table function” in *Administrative SQL Routines and Views*
- “EXPLAIN\_STATEMENT table” on page 808
- “SYSCAT.STATEMENTS ” on page 691

## EXPLAIN\_INSTANCE table

The EXPLAIN\_INSTANCE table is the main control table for all Explain information. Each row of data in the Explain tables is explicitly linked to one unique row in this table. The EXPLAIN\_INSTANCE table gives basic information about the source of the SQL statements being explained as well as information about the environment in which the explanation took place.

Table 184. EXPLAIN\_INSTANCE Table. PK means that the column is part of a primary key; FK means that the column is part of a foreign key.

| Column Name       | Data Type    | Nullable? | Key? | Description  |
|-------------------|--------------|-----------|------|--|
| EXPLAIN_REQUESTER | VARCHAR(128) | No        | PK   | Authorization ID of initiator of this Explain request.   |
| EXPLAIN_TIME      | TIMESTAMP    | No        | PK   | Time of initiation for Explain request.  |
| SOURCE_NAME       | VARCHAR(128) | No        | PK   | Name of the package running when the dynamic statement was explained or name of the source file when the static SQL was explained.   |
| SOURCE_SCHEMA     | VARCHAR(128) | No        | PK   | Schema, or qualifier, of source of Explain request.  |
| SOURCE_VERSION    | VARCHAR(64)  | No        | PK   | Version of the source of the Explain request.  |
| EXPLAIN_OPTION    | CHAR(1)      | No        | No   | Indicates what Explain Information was requested for this request.<br><br>Possible values are:<br><b>P</b> PLAN SELECTION  |
| SNAPSHOT_TAKEN    | CHAR(1)      | No        | No   | Indicates whether an Explain Snapshot was taken for this request.<br><br>Possible values are:<br><b>Y</b> Yes, an Explain Snapshot(s) was taken and stored in the EXPLAIN_STATEMENT table. Regular Explain information was also captured.<br><b>N</b> No Explain Snapshot was taken. Regular Explain information was captured.<br><b>O</b> Only an Explain Snapshot was taken. Regular Explain information was not captured. |
| DB2_VERSION       | CHAR(7)      | No        | No   | Release number for the DB2 product that processed this explain request. Format is <i>vv.rr.m</i> , where:<br><b>vv</b> Version number<br><b>rr</b> Release number<br><b>m</b> Maintenance release number   |
| SQL_TYPE          | CHAR(1)      | No        | No   | Indicates whether the Explain Instance was for static or dynamic SQL.<br><br>Possible values are:<br><b>S</b> Static SQL<br><b>D</b> Dynamic SQL   |
| QUERYOPT          | INTEGER      | No        | No   | Indicates the query optimization class used by the SQL Compiler at the time of the Explain invocation. The value indicates what level of query optimization was performed by the SQL Compiler for the SQL statements being explained.  |

## EXPLAIN\_INSTANCE table

Table 184. EXPLAIN\_INSTANCE Table (continued). PK means that the column is part of a primary key; FK means that the column is part of a foreign key.

| Column Name | Data Type    | Nullable? | Key? | Description  |
|-------------|--------------|-----------|------|--|
| BLOCK       | CHAR(1)      | No        | No   | Indicates what type of cursor blocking was used when compiling the SQL statements. For more information, see the BLOCK column in SYSCAT.PACKAGES.<br><br>Possible values are:<br><b>N</b> No Blocking<br><b>U</b> Block Unambiguous Cursors<br><b>B</b> Block All Cursors                        |
| ISOLATION   | CHAR(2)      | No        | No   | Indicates what type of isolation was used when compiling the SQL statements. For more information, see the ISOLATION column in SYSCAT.PACKAGES.<br><br>Possible values are:<br><b>RR</b> Repeatable Read<br><b>RS</b> Read Stability<br><b>CS</b> Cursor Stability<br><b>UR</b> Uncommitted Read |
| BUFFPAGE    | INTEGER      | No        | No   | Contains the value of the BUFFPAGE database configuration setting at the time of the Explain invocation.   |
| AVG_APPLS   | INTEGER      | No        | No   | Contains the value of the AVG_APPLS configuration parameter at the time of the Explain invocation.   |
| SORTHEAP    | INTEGER      | No        | No   | Contains the value of the SORTHEAP database configuration setting at the time of the Explain invocation.   |
| LOCKLIST    | INTEGER      | No        | No   | Contains the value of the LOCKLIST database configuration setting at the time of the Explain invocation.   |
| MAXLOCKS    | SMALLINT     | No        | No   | Contains the value of the MAXLOCKS database configuration setting at the time of the Explain invocation.   |
| LOCKS_AVAIL | INTEGER      | No        | No   | Contains the number of locks assumed to be available by the optimizer for each user. (Derived from LOCKLIST and MAXLOCKS.)   |
| CPU_SPEED   | DOUBLE       | No        | No   | Contains the value of the CPUSPEED database manager configuration setting at the time of the Explain invocation.   |
| REMARKS     | VARCHAR(254) | Yes       | No   | User-provided comment.   |
| DBHEAP      | INTEGER      | No        | No   | Contains the value of the DBHEAP database configuration setting at the time of Explain invocation.   |
| COMM_SPEED  | DOUBLE       | No        | No   | Contains the value of the COMM_BANDWIDTH database configuration setting at the time of Explain invocation.   |
| PARALLELISM | CHAR(2)      | No        | No   | Possible values are:<br>• N = No parallelism<br>• P = Intra-partition parallelism<br>• IP = Inter-partition parallelism<br>• BP = Intra-partition parallelism and inter-partition parallelism  |
| DATAJOINER  | CHAR(1)      | No        | No   | Possible values are:<br>• N = Non-federated systems plan<br>• Y = Federated systems plan   |



## EXPLAIN\_OBJECT table

### EXPLAIN\_OBJECT table

The EXPLAIN\_OBJECT table identifies those data objects required by the access plan generated to satisfy the SQL statement.

Table 185. EXPLAIN\_OBJECT Table. PK means that the column is part of a primary key; FK means that the column is part of a foreign key.

| Column Name       | Data Type    | Nullable? | Key? | Description   |
|-------------------|--------------|-----------|------|---|
| EXPLAIN_REQUESTER | VARCHAR(128) | No        | FK   | Authorization ID of initiator of this Explain request.  |
| EXPLAIN_TIME      | TIMESTAMP    | No        | FK   | Time of initiation for Explain request.   |
| SOURCE_NAME       | VARCHAR(128) | No        | FK   | Name of the package running when the dynamic statement was explained or name of the source file when the static SQL was explained.  |
| SOURCE_SCHEMA     | VARCHAR(128) | No        | FK   | Schema, or qualifier, of source of Explain request.   |
| SOURCE_VERSION    | VARCHAR(64)  | No        | FK   | Version of the source of the Explain request.   |
| EXPLAIN_LEVEL     | CHAR(1)      | No        | FK   | Level of Explain information for which this row is relevant.  |
| STMTNO            | INTEGER      | No        | FK   | Statement number within package to which this explain information is related.   |
| SECTNO            | INTEGER      | No        | FK   | Section number within package to which this explain information is related.   |
| OBJECT_SCHEMA     | VARCHAR(128) | No        | No   | Schema to which this object belongs.  |
| OBJECT_NAME       | VARCHAR(128) | No        | No   | Name of the object.   |
| OBJECT_TYPE       | CHAR(2)      | No        | No   | Descriptive label for the type of object.   |
| CREATE_TIME       | TIMESTAMP    | Yes       | No   | Time of Object's creation; null if a table function.  |
| STATISTICS_TIME   | TIMESTAMP    | Yes       | No   | Last time of update to statistics for this object; null if statistics do not exist for this object.   |
| COLUMN_COUNT      | SMALLINT     | No        | No   | Number of columns in this object.   |
| ROW_COUNT         | INTEGER      | No        | No   | Estimated number of rows in this object.  |
| WIDTH             | INTEGER      | No        | No   | The average width of the object in bytes. Set to -1 for an index.   |
| PAGES             | BIGINT       | No        | No   | Estimated number of pages that the object occupies in the buffer pool. Set to -1 for a table function.  |
| DISTINCT          | CHAR(1)      | No        | No   | Indicates whether the rows in the object are distinct (that is, whether there are duplicates).<br><br>Possible values are:<br><br>Y                    Yes<br>N                    No                 |
| TABLESPACE_NAME   | VARCHAR(128) | Yes       | No   | Name of the table space in which this object is stored; set to null if no table space is involved.  |
| OVERHEAD          | DOUBLE       | No        | No   | Total estimated overhead, in milliseconds, for a single random I/O to the specified table space. Includes controller overhead, disk seek, and latency times. Set to -1 if no table space is involved. |
| TRANSFER_RATE     | DOUBLE       | No        | No   | Estimated time to read a data page, in milliseconds, from the specified table space. Set to -1 if no table space is involved.   |
| PREFETCHSIZE      | INTEGER      | No        | No   | Number of data pages to be read when prefetch is performed. Set to -1 for a table function.   |
| EXTENTSIZE        | INTEGER      | No        | No   | Size of extent, in data pages. This many pages are written to one container in the table space before switching to the next container. Set to -1 for a table function.                                |

Table 185. EXPLAIN\_OBJECT Table (continued). PK means that the column is part of a primary key; FK means that the column is part of a foreign key.

| Column Name                  | Data Type | Nullable? | Key? | Description  |
|------------------------------|-----------|-----------|------|--|
| CLUSTER                      | DOUBLE    | No        | No   | Degree of data clustering with the index. If $\geq 1$ , this is the CLUSTERRATIO. If $\geq 0$ and $< 1$ , this is the CLUSTERFACTOR. Set to -1 for a table, table function, or if this statistic is not available.             |
| NLEAF                        | BIGINT    | No        | No   | Number of leaf pages this index object's values occupy. Set to -1 for a table, table function, or if this statistic is not available.  |
| NLEVELS                      | INTEGER   | No        | No   | Number of index levels in this index object's tree. Set to -1 for a table, table function, or if this statistic is not available.  |
| FULLKEYCARD                  | BIGINT    | No        | No   | Number of distinct full key values contained in this index object. Set to -1 for a table, table function, or if this statistic is not available.   |
| OVERFLOW                     | BIGINT    | No        | No   | Total number of overflow records in the table. Set to -1 for an index, table function, or if this statistic is not available.  |
| FIRSTKEYCARD                 | BIGINT    | No        | No   | Number of distinct first key values. Set to -1 for a table, table function, or if this statistic is not available.   |
| FIRST2KEYCARD                | BIGINT    | No        | No   | Number of distinct first key values using the first {2,3,4} columns of the index. Set to -1 for a table, table function, or if this statistic is not available.  |
| FIRST3KEYCARD                | BIGINT    | No        | No   |  |
| FIRST4KEYCARD                | BIGINT    | No        | No   |  |
| SEQUENTIAL_PAGES             | BIGINT    | No        | No   | Number of leaf pages located on disk in index key order with few or no large gaps between them. Set to -1 for a table, table function, or if this statistic is not available.  |
| DENSITY                      | INTEGER   | No        | No   | Ratio of SEQUENTIAL_PAGES to number of pages in the range of pages occupied by the index, expressed as a percentage (integer between 0 and 100). Set to -1 for a table, table function, or if this statistic is not available. |
| STATS_SRC                    | CHAR(1)   | No        | No   | Indicates the source for the statistics. Set to 1 if from single node.   |
| AVERAGE_SEQUENCE_GAP         | DOUBLE    | No        | No   | Gap between sequences.   |
| AVERAGE_SEQUENCE_FETCH_GAP   | DOUBLE    | No        | No   | Gap between sequences when fetching using the index.   |
| AVERAGE_SEQUENCE_PAGES       | DOUBLE    | No        | No   | Average number of index pages accessible in sequence.  |
| AVERAGE_SEQUENCE_FETCH_PAGES | DOUBLE    | No        | No   | Average number of table pages accessible in sequence when fetching using the index.  |
| AVERAGE_RANDOM_PAGES         | DOUBLE    | No        | No   | Average number of random index pages between sequential page accesses.   |
| AVERAGE_RANDOM_FETCH_PAGES   | DOUBLE    | No        | No   | Average number of random table pages between sequential page accesses when fetching using the index.   |
| NUMRIDS                      | BIGINT    | No        | No   | Total number of row identifiers in the index.  |
| NUMRIDS_DELETED              | BIGINT    | No        | No   | Total number of psuedo-deleted row identifiers in the index.   |
| NUM_EMPTY_LEAFS              | BIGINT    | No        | No   | Total number of empty leaf pages in the index.   |
| ACTIVE_BLOCKS                | BIGINT    | No        | No   | Total number of active multidimensional clustering (MDC) blocks in the table.  |
| NUM_DATA_PART                | INTEGER   | No        | No   | Number of data partitions for a partitioned table. Set to 1 if the table is not partitioned.   |

## EXPLAIN\_OBJECT table

Table 186. Possible OBJECT\_TYPE Values

| Value    | Description                    |
|----------|--------------------------------|
| IX       | Index                          |
| NK       | Nickname                       |
| RX       | RCT Index                      |
| DP_TABLE | Data partitioned table         |
| TA       | Table                          |
| TF       | Table Function                 |
| +A       | Compiler-referenced Alias      |
| +C       | Compiler-referenced Constraint |
| +F       | Compiler-referenced Function   |
| +G       | Compiler-referenced Trigger    |
| +N       | Compiler-referenced Nickname   |
| +T       | Compiler-referenced Table      |
| +V       | Compiler-referenced View       |



## EXPLAIN\_OPERATOR table

The EXPLAIN\_OPERATOR table contains all the operators needed to satisfy the query statement by the query compiler.

Table 187. EXPLAIN\_OPERATOR Table. PK means that the column is part of a primary key; FK means that the column is part of a foreign key.

| Column Name       | Data Type    | Nullable? | Key? | Description  |
|-------------------|--------------|-----------|------|--|
| EXPLAIN_REQUESTER | VARCHAR(128) | No        | FK   | Authorization ID of initiator of this Explain request.   |
| EXPLAIN_TIME      | TIMESTAMP    | No        | FK   | Time of initiation for Explain request.  |
| SOURCE_NAME       | VARCHAR(128) | No        | FK   | Name of the package running when the dynamic statement was explained or name of the source file when the static SQL was explained.   |
| SOURCE_SCHEMA     | VARCHAR(128) | No        | FK   | Schema, or qualifier, of source of Explain request.  |
| SOURCE_VERSION    | VARCHAR(64)  | No        | FK   | Version of the source of the Explain request.  |
| EXPLAIN_LEVEL     | CHAR(1)      | No        | FK   | Level of Explain information for which this row is relevant.   |
| STMTNO            | INTEGER      | No        | FK   | Statement number within package to which this explain information is related.  |
| SECTNO            | INTEGER      | No        | FK   | Section number within package to which this explain information is related.  |
| OPERATOR_ID       | INTEGER      | No        | No   | Unique ID for this operator within this query.   |
| OPERATOR_TYPE     | CHAR(6)      | No        | No   | Descriptive label for the type of operator.  |
| TOTAL_COST        | DOUBLE       | No        | No   | Estimated cumulative total cost (in timerons) of executing the chosen access plan up to and including this operator.   |
| IO_COST           | DOUBLE       | No        | No   | Estimated cumulative I/O cost (in data page I/Os) of executing the chosen access plan up to and including this operator.   |
| CPU_COST          | DOUBLE       | No        | No   | Estimated cumulative CPU cost (in instructions) of executing the chosen access plan up to and including this operator.   |
| FIRST_ROW_COST    | DOUBLE       | No        | No   | Estimated cumulative cost (in timerons) of fetching the first row for the access plan up to and including this operator. This value includes any initial overhead required.                            |
| RE_TOTAL_COST     | DOUBLE       | No        | No   | Estimated cumulative cost (in timerons) of fetching the next row for the chosen access plan up to and including this operator.   |
| RE_IO_COST        | DOUBLE       | No        | No   | Estimated cumulative I/O cost (in data page I/Os) of fetching the next row for the chosen access plan up to and including this operator.   |
| RE_CPU_COST       | DOUBLE       | No        | No   | Estimated cumulative CPU cost (in instructions) of fetching the next row for the chosen access plan up to and including this operator.   |
| COMM_COST         | DOUBLE       | No        | No   | Estimated cumulative communication cost (in TCP/IP frames) of executing the chosen access plan up to and including this operator.  |
| FIRST_COMM_COST   | DOUBLE       | No        | No   | Estimated cumulative communications cost (in TCP/IP frames) of fetching the first row for the chosen access plan up to and including this operator. This value includes any initial overhead required. |
| BUFFERS           | DOUBLE       | No        | No   | Estimated buffer requirements for this operator and its inputs.  |
| REMOTE_TOTAL_COST | DOUBLE       | No        | No   | Estimated cumulative total cost (in timerons) of performing operation(s) on remote database(s).  |

## EXPLAIN\_OPERATOR table

Table 187. EXPLAIN\_OPERATOR Table (continued). PK means that the column is part of a primary key; FK means that the column is part of a foreign key.

| Column Name      | Data Type | Nullable? | Key? | Description   |
|------------------|-----------|-----------|------|---|
| REMOTE_COMM_COST | DOUBLE    | No        | No   | Estimated cumulative communication cost of executing the chosen remote access plan up to and including this operator. |

Table 188. OPERATOR\_TYPE values

| Value    | Description                          |
|----------|--------------------------------------|
| DELETE   | Delete                               |
| EISCAN   | Extended Index Scan                  |
| FETCH    | Fetch                                |
| FILTER   | Filter rows                          |
| GENROW   | Generate Row                         |
| GRPBY    | Group By                             |
| HSJOIN   | Hash Join                            |
| INSERT   | Insert                               |
| IXAND    | Dynamic Bitmap Index ANDing          |
| IXSCAN   | Relational index scan                |
| MSJOIN   | Merge Scan Join                      |
| NLJOIN   | Nested loop Join                     |
| RETURN   | Result                               |
| RIDSCN   | Row Identifier (RID) Scan            |
| SHIP     | Ship query to remote system          |
| SORT     | Sort                                 |
| TBSCAN   | Table Scan                           |
| TEMP     | Temporary Table Construction         |
| TQ       | Table Queue                          |
| UNION    | Union                                |
| UNIQUE   | Duplicate Elimination                |
| UPDATE   | Update                               |
| XISCAN   | Index scan over XML data             |
| XSCAN    | XML document navigation scan         |
| XANDOR   | Index ANDing and ORing over XML data |
| XITERATE | XML sequence iterator                |
| XUNNEST  | XML sequence unnest                  |

## EXPLAIN\_PREDICATE table

The EXPLAIN\_PREDICATE table identifies which predicates are applied by a specific operator.

Table 189. EXPLAIN\_PREDICATE Table. PK means that the column is part of a primary key; FK means that the column is part of a foreign key.

| Column Name       | Data Type    | Nullable? | Key? | Description  |
|-------------------|--------------|-----------|------|--|
| EXPLAIN_REQUESTER | VARCHAR(128) | No        | FK   | Authorization ID of initiator of this Explain request.   |
| EXPLAIN_TIME      | TIMESTAMP    | No        | FK   | Time of initiation for Explain request.  |
| SOURCE_NAME       | VARCHAR(128) | No        | FK   | Name of the package running when the dynamic statement was explained or name of the source file when the static SQL was explained.   |
| SOURCE_SCHEMA     | VARCHAR(128) | No        | FK   | Schema, or qualifier, of source of Explain request.  |
| SOURCE_VERSION    | VARCHAR(64)  | No        | FK   | Version of the source of the Explain request.  |
| EXPLAIN_LEVEL     | CHAR(1)      | No        | FK   | Level of Explain information for which this row is relevant.   |
| STMTNO            | INTEGER      | No        | FK   | Statement number within package to which this explain information is related.  |
| SECTNO            | INTEGER      | No        | FK   | Section number within package to which this explain information is related.  |
| OPERATOR_ID       | INTEGER      | No        | No   | Unique ID for this operator within this query.   |
| PREDICATE_ID      | INTEGER      | No        | No   | Unique ID for this predicate for the specified operator.<br><br>A value of "-1" is shown for operator predicates constructed by the Explain tool which are not optimizer objects and do not exist in the optimizer plan.   |
| HOW_APPLIED       | CHAR(10)     | No        | No   | How predicate is being used by the specified operator.   |
| WHEN_EVALUATED    | CHAR(3)      | No        | No   | Indicates when the subquery used in this predicate is evaluated.<br><br>Possible values are:<br><br><b>blank</b> This predicate does not contain a subquery.<br><br><b>EAA</b> The subquery used in this predicate is evaluated at application (EAA). That is, it is re-evaluated for every row processed by the specified operator, as the predicate is being applied.<br><br><b>EAO</b> The subquery used in this predicate is evaluated at open (EAO). That is, it is re-evaluated only once for the specified operator, and its results are re-used in the application of the predicate for each row.<br><br><b>MUL</b> There is more than one type of subquery in this predicate. |
| RELOP_TYPE        | CHAR(2)      | No        | No   | The type of relational operator used in this predicate.  |
| SUBQUERY          | CHAR(1)      | No        | No   | Whether or not a data stream from a subquery is required for this predicate. There may be multiple subquery streams required.<br><br>Possible values are:<br><br><b>N</b> No subquery stream is required<br><br><b>Y</b> One or more subquery streams is required  |

## EXPLAIN\_PREDICATE table

Table 189. EXPLAIN\_PREDICATE Table (continued). PK means that the column is part of a primary key; FK means that the column is part of a foreign key.

| Column Name    | Data Type | Nullable? | Key? | Description  |
|----------------|-----------|-----------|------|--|
| FILTER_FACTOR  | DOUBLE    | No        | No   | The estimated fraction of rows that will be qualified by this predicate.<br><br>A value of "-1" is shown when FILTER_FACTOR is not applicable. FILTER_FACTOR is not applicable for operator predicates constructed by the Explain tool which are not optimizer objects and do not exist in the optimizer plan.   |
| PREDICATE_TEXT | CLOB(2M)  | Yes       | No   | The text of the predicate as recreated from the internal representation of the SQL or XQuery statement. If the value of a host variable, special register, or parameter marker is used during compilation of the statement, this value will appear at the end of the predicate text enclosed in brackets.<br><br>The value will be stored in the EXPLAIN_PREDICATE table only if the statement is executed by a user who has DBADM authority, or if the DB2 registry variable DB2_VIEW_REOPT_VALUES is set to YES; otherwise, empty brackets will appear at the end of the predicate text.<br><br>Null if not available. |
| RANGE_NUM      | INTEGER   | Yes       | No   | Range of data partition elimination predicates, which enables the grouping of predicates that are used for data partition elimination by range. Null value for all other predicate types.  |

Table 190. Possible HOW\_APPLIED Values

| Value   | Description  |
|---------|--|
| BSARG   | Evaluated as a sargable predicate once for every block   |
| DPSTART | Start key predicate used in data partition elimination   |
| DPSTOP  | Stop key predicate used in data partition elimination    |
| JOIN    | Used to join tables                                      |
| RESID   | Evaluated as a residual predicate                        |
| SARG    | Evaluated as a sargable predicate for index or data page |
| START   | Used as a start condition                                |
| STOP    | Used as a stop condition                                 |

Table 191. Possible RELOP\_TYPE Values

| Value  | Description           |
|--------|-----------------------|
| blanks | Not Applicable        |
| EQ     | Equals                |
| GE     | Greater Than or Equal |
| GT     | Greater Than          |
| IN     | In list               |
| LE     | Less Than or Equal    |
| LK     | Like                  |
| LT     | Less Than             |
| NE     | Not Equal             |
| NL     | Is Null               |
| NN     | Is Not Null           |



## EXPLAIN\_STATEMENT table

### EXPLAIN\_STATEMENT table

The EXPLAIN\_STATEMENT table contains the text of the SQL statement as it exists for the different levels of Explain information. The original SQL statement as entered by the user is stored in this table along with the version used (by the optimizer) to choose an access plan to satisfy the SQL statement. The latter version may bear little resemblance to the original as it may have been rewritten and/or enhanced with additional predicates as determined by the SQL Compiler.

Table 192. EXPLAIN\_STATEMENT Table. PK means that the column is part of a primary key; FK means that the column is part of a foreign key.

| Column Name       | Data Type    | Nullable? | Key?   | Description   |
|-------------------|--------------|-----------|--------|---|
| EXPLAIN_REQUESTER | VARCHAR(128) | No        | PK, FK | Authorization ID of initiator of this Explain request.  |
| EXPLAIN_TIME      | TIMESTAMP    | No        | PK, FK | Time of initiation for Explain request.   |
| SOURCE_NAME       | VARCHAR(128) | No        | PK, FK | Name of the package running when the dynamic statement was explained or name of the source file when the static SQL was explained.  |
| SOURCE_SCHEMA     | VARCHAR(128) | No        | PK, FK | Schema, or qualifier, of source of Explain request.   |
| SOURCE_VERSION    | VARCHAR(64)  | No        | FK     | Version of the source of the Explain request.   |
| EXPLAIN_LEVEL     | CHAR(1)      | No        | PK     | Level of Explain information for which this row is relevant.<br><br>Valid values are:<br><b>O</b> Original Text (as entered by user)<br><b>P</b> PLAN SELECTION   |
| STMTNO            | INTEGER      | No        | PK     | Statement number within package to which this explain information is related. Set to 1 for dynamic Explain SQL statements. For static SQL statements, this value is the same as the value used for the SYSCAT.STATEMENTS catalog view.  |
| SECTNO            | INTEGER      | No        | PK     | Section number within package that contains this SQL statement. For dynamic Explain SQL statements, this is the section number used to hold the section for this statement at runtime. For static SQL statements, this value is the same as the value used for the SYSCAT.STATEMENTS catalog view.                              |
| QUERYNO           | INTEGER      | No        | No     | Numeric identifier for explained SQL statement. For dynamic SQL statements (excluding the EXPLAIN SQL statement) issued through CLP or CLI, the default value is a sequentially incremented value. Otherwise, the default value is the value of STMTNO for static SQL statements and 1 for dynamic SQL statements.              |
| QUERYTAG          | CHAR(20)     | No        | No     | Identifier tag for each explained SQL statement. For dynamic SQL statements issued through CLP (excluding the EXPLAIN SQL statement), the default value is 'CLP'. For dynamic SQL statements issued through CLI (excluding the EXPLAIN SQL statement), the default value is 'CLI'. Otherwise, the default value used is blanks. |
| STATEMENT_TYPE    | CHAR(2)      | No        | No     | Descriptive label for type of query being explained.<br><br>Possible values are:<br><b>S</b> Select<br><b>D</b> Delete<br><b>DC</b> Delete where current of cursor<br><b>I</b> Insert<br><b>U</b> Update<br><b>UC</b> Update where current of cursor  |

Table 192. EXPLAIN\_STATEMENT Table (continued). PK means that the column is part of a primary key; FK means that the column is part of a foreign key.

| Column Name    | Data Type | Nullable? | Key? | Description   |
|----------------|-----------|-----------|------|---|
| UPDATABLE      | CHAR(1)   | No        | No   | Indicates if this statement is considered updatable. This is particularly relevant to SELECT statements which may be determined to be potentially updatable.<br><br>Possible values are:<br>'' Not applicable (blank)<br>N No<br>Y Yes  |
| DELETABLE      | CHAR(1)   | No        | No   | Indicates if this statement is considered deletable. This is particularly relevant to SELECT statements which may be determined to be potentially deletable.<br><br>Possible values are:<br>'' Not applicable (blank)<br>N No<br>Y Yes  |
| TOTAL_COST     | DOUBLE    | No        | No   | Estimated total cost (in timerons) of executing the chosen access plan for this statement; set to 0 (zero) if EXPLAIN_LEVEL is 0 (original text) since no access plan has been chosen at this time.   |
| STATEMENT_TEXT | CLOB(2M)  | No        | No   | Text or portion of the text of the SQL statement being explained. The text shown for the Plan Selection level of Explain has been reconstructed from the internal representation and is SQL-like in nature; that is, the reconstructed statement is not guaranteed to follow correct SQL syntax.                                  |
| SNAPSHOT       | BLOB(10M) | Yes       | No   | Snapshot of internal representation for this SQL statement at the Explain_Level shown.<br><br>This column is intended for use with DB2 Visual Explain. Column is set to null if EXPLAIN_LEVEL is 0 (original statement) since no access plan has been chosen at the time that this specific version of the statement is captured. |
| QUERY_DEGREE   | INTEGER   | No        | No   | Indicates the degree of intra-partition parallelism at the time of Explain invocation. For the original statement, this contains the directed degree of intra-partition parallelism. For the PLAN SELECTION, this contains the degree of intra-partition parallelism generated for the plan to use.                               |

## EXPLAIN\_STREAM table

### EXPLAIN\_STREAM table

The EXPLAIN\_STREAM table represents the input and output data streams between individual operators and data objects. The data objects themselves are represented in the EXPLAIN\_OBJECT table. The operators involved in a data stream are to be found in the EXPLAIN\_OPERATOR table.

*Table 193. EXPLAIN\_STREAM Table.* PK means that the column is part of a primary key; FK means that the column is part of a foreign key.

| Column Name       | Data Type    | Nullable? | Key? | Description  |
|-------------------|--------------|-----------|------|--|
| EXPLAIN_REQUESTER | VARCHAR(128) | No        | FK   | Authorization ID of initiator of this Explain request.   |
| EXPLAIN_TIME      | TIMESTAMP    | No        | FK   | Time of initiation for Explain request.  |
| SOURCE_NAME       | VARCHAR(128) | No        | FK   | Name of the package running when the dynamic statement was explained or name of the source file when the static SQL was explained. |
| SOURCE_SCHEMA     | VARCHAR(128) | No        | FK   | Schema, or qualifier, of source of Explain request.  |
| SOURCE_VERSION    | VARCHAR(64)  | No        | FK   | Version of the source of the Explain request.  |
| EXPLAIN_LEVEL     | CHAR(1)      | No        | FK   | Level of Explain information for which this row is relevant.   |
| STMTNO            | INTEGER      | No        | FK   | Statement number within package to which this explain information is related.  |
| SECTNO            | INTEGER      | No        | FK   | Section number within package to which this explain information is related.  |
| STREAM_ID         | INTEGER      | No        | No   | Unique ID for this data stream within the specified operator.  |
| SOURCE_TYPE       | CHAR(1)      | No        | No   | Indicates the source of this data stream:<br><b>O</b> Operator<br><b>D</b> Data Object   |
| SOURCE_ID         | SMALLINT     | No        | No   | Unique ID for the operator within this query that is the source of this data stream. Set to -1 if SOURCE_TYPE is 'D'.              |
| TARGET_TYPE       | CHAR(1)      | No        | No   | Indicates the target of this data stream:<br><b>O</b> Operator<br><b>D</b> Data Object   |
| TARGET_ID         | SMALLINT     | No        | No   | Unique ID for the operator within this query that is the target of this data stream. Set to -1 if TARGET_TYPE is 'D'.              |
| OBJECT_SCHEMA     | VARCHAR(128) | Yes       | No   | Schema to which the affected data object belongs. Set to null if both SOURCE_TYPE and TARGET_TYPE are 'O'.                         |
| OBJECT_NAME       | VARCHAR(128) | Yes       | No   | Name of the object that is the subject of data stream. Set to null if both SOURCE_TYPE and TARGET_TYPE are 'O'.                    |
| STREAM_COUNT      | DOUBLE       | No        | No   | Estimated cardinality of data stream.  |
| COLUMN_COUNT      | SMALLINT     | No        | No   | Number of columns in data stream.  |
| PREDICATE_ID      | INTEGER      | No        | No   | If this stream is part of a subquery for a predicate, the predicate ID will be reflected here, otherwise the column is set to -1.  |



Table 193. EXPLAIN\_STREAM Table (continued). PK means that the column is part of a primary key; FK means that the column is part of a foreign key.

| Column Name       | Data Type | Nullable? | Key? | Description   |
|-------------------|-----------|-----------|------|---|
| COLUMN_NAMES      | CLOB(2M)  | Yes       | No   | <p>This column contains the names and ordering information of the columns involved in this stream.</p> <p>These names will be in the format of:<br/>NAME1(A)+NAME2(D)+NAME3+NAME4</p> <p>Where (A) indicates a column in ascending order, (D) indicates a column in descending order, and no ordering information indicates that either the column is not ordered or ordering is not relevant.</p>  |
| PMID              | SMALLINT  | No        | No   | Distribution map ID.  |
| SINGLE_NODE       | CHAR(5)   | Yes       | No   | <p>Indicates whether this data stream is on a single or on multiple database partitions:</p> <p><b>MULT</b> On multiple database partitions</p> <p><b>COOR</b> On coordinator node</p> <p><b>HASH</b> Directed using hashing</p> <p><b>RID</b> Directed using the row ID</p> <p><b>FUNC</b> Directed using a function (HASHEDVALUE() or DBPARTITIONNUM())</p> <p><b>CORR</b> Directed using a correlation value</p> <p><b>Numeric</b><br/>Directed to predetermined single node</p> |
| PARTITION_COLUMNS | CLOB(2M)  | Yes       | No   | List of the columns on which this data stream is distributed.   |
| SEQUENCE_SIZES    | CLOB(2M)  | Yes       | No   | <p>Lists the expected sequence size for XML columns, or shows "NA" (not applicable) for any non-XML columns in the data stream.</p> <p>Set to null if there is not at least one XML column in the data stream.</p>  |

---

**ADVISE\_INDEX table**

The ADVISE\_INDEX table represents the recommended indexes.

Table 194. ADVISE\_INDEX Table. PK means that the column is part of a primary key; FK means that the column is part of a foreign key.

| Column Name       | Data Type    | Nullable? | Key? | Description   |
|-------------------|--------------|-----------|------|---|
| EXPLAIN_REQUESTER | VARCHAR(128) | No        | No   | Authorization ID of initiator of this Explain request.  |
| EXPLAIN_TIME      | TIMESTAMP    | No        | No   | Time of initiation for Explain request.   |
| SOURCE_NAME       | VARCHAR(128) | No        | No   | Name of the package running when the dynamic statement was explained or name of the source file when static SQL was explained.  |
| SOURCE_SCHEMA     | VARCHAR(128) | No        | No   | Schema, or qualifier, of source of Explain request.   |
| SOURCE_VERSION    | VARCHAR(64)  | No        | No   | Version of the source of the Explain request.   |
| EXPLAIN_LEVEL     | CHAR(1)      | No        | No   | Level of Explain information for which this row is relevant.  |
| STMTNO            | INTEGER      | No        | No   | Statement number within package to which this explain information is related.   |
| SECTNO            | INTEGER      | No        | No   | Section number within package to which this explain information is related.   |
| QUERYNO           | INTEGER      | No        | No   | Numeric identifier for explained SQL statement. For dynamic SQL statements (excluding the EXPLAIN SQL statement) issued through CLP or CLI, the default value is a sequentially incremented value. Otherwise, the default value is the value of STMTNO for static SQL statements and 1 for dynamic SQL statements.              |
| QUERYTAG          | CHAR(20)     | No        | No   | Identifier tag for each explained SQL statement. For dynamic SQL statements issued through CLP (excluding the EXPLAIN SQL statement), the default value is 'CLP'. For dynamic SQL statements issued through CLI (excluding the EXPLAIN SQL statement), the default value is 'CLI'. Otherwise, the default value used is blanks. |
| NAME              | VARCHAR(128) | No        | No   | Name of the index.  |
| CREATOR           | VARCHAR(128) | No        | No   | Qualifier of the index name.  |
| TBNAME            | VARCHAR(128) | No        | No   | Name of the table or nickname on which the index is defined.  |
| TBCREATOR         | VARCHAR(128) | No        | No   | Qualifier of the table name.  |
| COLNAMES          | CLOB(2M)     | No        | No   | List of column names.   |
| UNIQUERULE        | CHAR(1)      | No        | No   | Unique rule:<br>D = Duplicates allowed<br>P = Primary index<br>U = Unique entries only allowed  |
| COLCOUNT          | SMALLINT     | No        | No   | Number of columns in the key plus the number of include columns if any.   |
| IID               | SMALLINT     | No        | No   | Internal index ID.  |
| NLEAF             | BIGINT       | No        | No   | Number of leaf pages; -1 if statistics are not gathered.  |
| NLEVELS           | SMALLINT     | No        | No   | Number of index levels; -1 if statistics are not gathered.  |
| FIRSTKEYCARD      | BIGINT       | No        | No   | Number of distinct first key values; -1 if statistics are not gathered.   |
| FULLKEYCARD       | BIGINT       | No        | No   | Number of distinct full key values; -1 if statistics are not gathered.  |

Table 194. ADVISE\_INDEX Table (continued). PK means that the column is part of a primary key; FK means that the column is part of a foreign key.

| Column Name                       | Data Type    | Nullable? | Key? | Description   |
|-----------------------------------|--------------|-----------|------|---|
| CLUSTERRATIO                      | SMALLINT     | No        | No   | Degree of data clustering with the index; -1 if statistics are not gathered or if detailed index statistics are gathered (in which case, CLUSTERFACTOR will be used instead).   |
| AVGPARTITION_<br>CLUSTERRATIO     | SMALLINT     | No        | No   | Degree of data clustering within a single data partition. -1 if the table is not table partitioned, if statistics are not gathered, or if detailed statistics are gathered (in which case AVGPARTITION_CLUSTERFACTOR will be used instead).   |
| AVGPARTITION_<br>CLUSTERFACTOR    | DOUBLE       | No        | No   | Finer measurement of the degree of clustering within a single data partition. -1 if the table is not table partitioned, if statistics are not gathered, or if the index is defined on a nickname.   |
| AVGPARTITION_PAGE_<br>FETCH_PAIRS | VARCHAR(520) | No        | No   | A list of paired integers in character form. Each pair represents a potential buffer pool size and the corresponding page fetches required to access a single data partition from the table. Zero-length string if no data is available, or if the table is not table partitioned.  |
| DATAPARTITION_<br>CLUSTERFACTOR   | DOUBLE       | No        | No   | A statistic measuring the "clustering" of the index keys with regard to data partitions. This field holds a number between zero and one, with one representing perfect clustering and zero representing no clustering.  |
| CLUSTERFACTOR                     | DOUBLE       | No        | No   | Finer measurement of degree of clustering, or -1 if detailed index statistics have not been gathered or if the index is defined on a nickname.  |
| USERDEFINED                       | SMALLINT     | No        | No   | Defined by the user.  |
| SYSTEM_REQUIRED                   | SMALLINT     | No        | No   | 1 if one or the other of the following conditions is met: <ul style="list-style-type: none"> <li>- This index is required for a primary or unique key constraint, or this index is a dimension block index or composite block index for a multi-dimensional clustering (MDC) table.</li> <li>- This is an index on the (OID) column of a typed table.</li> </ul> 2 if both of the following conditions are met: <ul style="list-style-type: none"> <li>- This index is required for a primary or unique key constraint, or this index is a dimension block index or composite block index for an MDC table.</li> <li>- This is an index on the (OID) column of a typed table.</li> </ul> 0 otherwise. |
| CREATE_TIME                       | TIMESTAMP    | No        | No   | Time when the index was created.  |
| STATS_TIME                        | TIMESTAMP    | Yes       | No   | Last time when any change was made to recorded statistics for this index. Null if no statistics available.  |
| PAGE_FETCH_PAIRS                  | VARCHAR(520) | No        | No   | A list of pairs of integers, represented in character form. Each pair represents the number of pages in a hypothetical buffer, and the number of page fetches required to scan the table with this index using that hypothetical buffer. (Zero-length string if no data available.)   |
| REMARKS                           | VARCHAR(254) | Yes       | No   | User-supplied comment, or null.   |
| DEFINER                           | VARCHAR(128) | No        | No   | User who created the index.   |
| CONVERTED                         | CHAR(1)      | No        | No   | Reserved for future use.  |

## ADVISE\_INDEX table

Table 194. ADVISE\_INDEX Table (continued). PK means that the column is part of a primary key; FK means that the column is part of a foreign key.

| Column Name      | Data Type  | Nullable? | Key? | Description  |
|------------------|------------|-----------|------|--|
| SEQUENTIAL_PAGES | BIGINT     | No        | No   | Number of leaf pages located on disk in index key order with few or no large gaps between them. (-1 if no statistics are available.)   |
| DENSITY          | INTEGER    | No        | No   | Ratio of SEQUENTIAL_PAGES to number of pages in the range of pages occupied by the index, expressed as a percent (integer between 0 and 100, -1 if no statistics are available.)   |
| FIRST2KEYCARD    | BIGINT     | No        | No   | Number of distinct keys using the first two columns of the index (-1 if no statistics or inapplicable)   |
| FIRST3KEYCARD    | BIGINT     | No        | No   | Number of distinct keys using the first three columns of the index (-1 if no statistics or inapplicable)   |
| FIRST4KEYCARD    | BIGINT     | No        | No   | Number of distinct keys using the first four columns of the index (-1 if no statistics or inapplicable)  |
| PCTFREE          | SMALLINT   | No        | No   | Percentage of each index leaf page to be reserved during initial building of the index. This space is available for future inserts after the index is built.   |
| UNIQUE_COLCOUNT  | SMALLINT   | No        | No   | The number of columns required for a unique key. Always <=COLCOUNT. < COLCOUNT only if there are include columns. -1 if index has no unique key (permits duplicates)   |
| MINPCTUSED       | SMALLINT   | No        | No   | If not zero, then online index defragmentation is enabled, and the value is the threshold of minimum used space before merging pages.  |
| REVERSE_SCANS    | CHAR(1)    | No        | No   | Y = Index supports reverse scans<br>N = Index does not support reverse scans   |
| USE_INDEX        | CHAR(1)    | Yes       | No   | Y = index recommended or evaluated<br>N = index not to be recommended<br>R = an existing clustering RID index was recommended (by the Design Advisor) to be unclustered; this is the case when a new clustering RID index is recommended for the table |
| CREATION_TEXT    | CLOB(2M)   | No        | No   | The SQL statement used to create the index.  |
| PACKED_DESC      | BLOB(1M)   | Yes       | No   | Internal description of the table.   |
| RUN_ID           | TIMESTAMP  | Yes       | FK   | A value corresponding to the START_TIME of a row in the ADVISE_INSTANCE table, linking it to the same Design Advisor run.  |
| INDEXTYPE        | VARCHAR(4) | No        | No   | Type of index.<br>CLUS = Clustering<br>REG = Regular<br>DIM = Dimension block index<br>BLOK = Block index  |
| EXISTS           | CHAR(1)    | No        | No   | Set to 'Y' if the index exists in the database catalog.  |
| RIDTOBLOCK       | CHAR(1)    | No        | No   | Set to 'Y' if the RID index was used to make a block index in the Design Advisor.  |

## ADVISE\_INSTANCE table

The ADVISE\_INSTANCE table contains information about db2advis execution, including start time. Contains one row for each execution of db2advis. Other ADVISE tables have a foreign key (RUN\_ID) that links to the START\_TIME column of the ADVISE\_INSTANCE table for rows created during the same Design Advisor run.

*Table 195. ADVISE\_INSTANCE Table.* PK means that the column is part of a primary key; FK means that the column is part of a foreign key.

| Column Name      | Data Type  | Nullable? | Key? | Description   |
|------------------|------------|-----------|------|---|
| START_TIME       | TIMESTAMP  | No        | PK   | Time at which db2advis execution begins.  |
| END_TIME         | TIMESTAMP  | No        | No   | Time at which db2advis execution ends.  |
| MODE             | VARCHAR(4) | No        | No   | The value that was specified with the -m option on the Design Advisor; for example, 'MC' to specify MQT and MDC.  |
| WKLD_COMPRESSION | CHAR(4)    | No        | No   | The workload compression under which the Design Advisor was run.  |
| STATUS           | CHAR(9)    | No        | No   | The status of a Design Advisor run. Status can be 'STARTED', 'COMPLETED' (if successful), or an error number that is prefixed by 'EI' for internal errors or 'EX' for external errors, in which case the error number represents the SQLCODE. |

## ADVISE\_MQT table

### ADVISE\_MQT table

The ADVISE\_MQT table contains information about materialized query tables (MQT) recommended by the Design Advisor.

Table 196. ADVISE\_MQT Table. PK means that the column is part of a primary key; FK means that the column is part of a foreign key.

| Column Name       | Data Type    | Nullable? | Key? | Description  |
|-------------------|--------------|-----------|------|--|
| EXPLAIN_REQUESTER | VARCHAR(128) | No        | No   | Authorization ID of initiator of this Explain request.   |
| EXPLAIN_TIME      | TIMESTAMP    | No        | No   | Time of initiation for Explain request.  |
| SOURCE_NAME       | VARCHAR(128) | No        | No   | Name of the package running when the dynamic statement was explained or name of the source file when the static SQL was explained.   |
| SOURCE_SCHEMA     | VARCHAR(128) | No        | No   | Schema, or qualifier, of source of Explain request.  |
| SOURCE_VERSION    | VARCHAR(64)  | No        | No   | Version of the source of the Explain request.  |
| EXPLAIN_LEVEL     | CHAR(1)      | No        | No   | Level of Explain information for which this row is relevant.   |
| STMTNO            | INTEGER      | No        | No   | Statement number within package to which this Explain information is related.  |
| SECTNO            | INTEGER      | No        | No   | Statement number within package to which this Explain information is related.  |
| NAME              | VARCHAR(128) | No        | No   | MQT name.  |
| CREATOR           | VARCHAR(128) | No        | No   | MQT creator name.  |
| IID               | SMALLINT     | No        | No   | Internal identifier.   |
| CREATE_TIME       | TIMESTAMP    | No        | No   | Time at which the MQT was created.   |
| STATS_TIME        | TIMESTAMP    | Yes       | No   | Time at which statistics were taken.   |
| NUMROWS           | DOUBLE       | No        | No   | The number of estimated rows in the MQT.   |
| NUMCOLS           | SMALLINT     | No        | No   | Number of columns defined in the MQT.  |
| ROWSIZE           | DOUBLE       | No        | No   | Average length (in bytes) of a row in the MQT.   |
| BENEFIT           | FLOAT        | No        | No   | Reserved for future use.   |
| USE_MQT           | CHAR(1)      | Yes       | No   | Set to 'Y' when the MQT is recommended.  |
| MQT_SOURCE        | CHAR(1)      | Yes       | No   | Indicates where the MQT candidate was generated. Set to 'I' if the MQT candidate is a refresh-immediate MQT, or 'D' if it can only be created as a full refresh-deferred MQT.  |
| QUERY_TEXT        | CLOB(2M)     | No        | No   | Contains the query that defines the MQT.   |
| CREATION_TEXT     | CLOB(2M)     | No        | No   | Contains the CREATE TABLE DDL for the MQT.   |
| SAMPLE_TEXT       | CLOB(2M)     | No        | No   | Contains the sampling query that is used to get detailed statistics for the MQT. Only used when detailed statistics are required for the Design Advisor. The resulting sampled statistics will be shown in this table. If null, then no sampling query was created for this MQT. |
| COLSTATS          | CLOB(2M)     | No        | No   | Contains the column statistics for the MQT (if not null). These statistics are in XML format and include the column name, column cardinality and, optionally, the HIGH2KEY and LOW2KEY values.   |
| EXTRA_INFO        | BLOB(2M)     | No        | No   | Reserved for miscellaneous output.   |
| TBSPACE           | VARCHAR(128) | No        | No   | The table space that is recommended for the MQT.   |
| RUN_ID            | TIMESTAMP    | Yes       | FK   | A value corresponding to the START_TIME of a row in the ADVISE_INSTANCE table, linking it to the same Design Advisor run.  |
| REFRESH_TYPE      | CHAR(1)      | No        | No   | Set to 'I' for immediate or 'D' for deferred.  |
| EXISTS            | CHAR(1)      | No        | No   | Set to 'Y' if the MQT exists in the database catalog.  |

## ADVISE\_PARTITION table

The ADVISE\_PARTITION table contains information about database partitions recommended by the Design Advisor, and can only be populated in a partitioned database environment.

Table 197. ADVISE\_PARTITION Table. PK means that the column is part of a primary key; FK means that the column is part of a foreign key.

| Column Name       | Data Type    | Nullable? | Key? | Description   |
|-------------------|--------------|-----------|------|---|
| EXPLAIN_REQUESTER | VARCHAR(128) | No        | No   | Authorization ID of initiator of this Explain request.  |
| EXPLAIN_TIME      | TIMESTAMP    | No        | No   | Time of initiation for Explain request.   |
| SOURCE_NAME       | VARCHAR(128) | No        | No   | Name of the package running when the dynamic statement was explained or name of the source file when the static SQL was explained.  |
| SOURCE_SCHEMA     | VARCHAR(128) | No        | No   | Schema, or qualifier, of source of Explain request.   |
| SOURCE_VERSION    | VARCHAR(64)  | No        | No   | Version of the source of the Explain request.   |
| EXPLAIN_LEVEL     | CHAR(1)      | No        | No   | Level of Explain information for which this row is relevant.  |
| STMTNO            | INTEGER      | No        | No   | Statement number within package to which this Explain information is related.   |
| SECTNO            | INTEGER      | No        | No   | Statement number within package to which this Explain information is related.   |
| QUERYNO           | INTEGER      | No        | No   | Numeric identifier for explained SQL statement. For dynamic SQL statements (excluding the EXPLAIN SQL statement) issued through CLP or CLI, the default value is a sequentially incremented value. Otherwise, the default value is the value of STMTNO for static SQL statements and 1 for dynamic SQL statements.              |
| QUERYTAG          | CHAR(20)     | No        | No   | Identifier tag for each explained SQL statement. For dynamic SQL statements issued through CLP (excluding the EXPLAIN SQL statement), the default value is 'CLP'. For dynamic SQL statements issued through CLI (excluding the EXPLAIN SQL statement), the default value is 'CLI'. Otherwise, the default value used is blanks. |
| TBNAME            | VARCHAR(128) | Yes       | No   | Specifies the table name.   |
| TBCREATOR         | VARCHAR(128) | Yes       | No   | Specifies the table creator name.   |
| PMID              | SMALLINT     | Yes       | No   | Specifies the distribution map ID.  |
| TBSPACE           | VARCHAR(128) | Yes       | No   | Specifies the table space in which the table resides.   |
| COLNAMES          | CLOB(2M)     | Yes       | No   | Specifies database partition column names, separated by commas.   |
| COLCOUNT          | SMALLINT     | Yes       | No   | Specifies the number of database partitioning columns.  |
| REPLICATE         | CHAR(1)      | Yes       | No   | Specifies whether or not the database partition is replicated.  |
| COST              | DOUBLE       | Yes       | No   | Specifies the cost of using the database partition.   |
| USEIT             | CHAR(1)      | Yes       | No   | Specifies whether or not the database partition is used in EVALUATE PARTITION mode. A database partition is used if USEIT is set to 'Y' or 'y'.   |
| RUN_ID            | TIMESTAMP    | Yes       | FK   | A value corresponding to the START_TIME of a row in the ADVISE_INSTANCE table, linking it to the same Design Advisor run.   |

## ADVISE\_TABLE table

---

### ADVISE\_TABLE table

The ADVISE\_TABLE table stores the data definition language (DDL) for table creation, using the final Design Advisor recommendations for materialized query tables (MQTs), multidimensional clustered tables (MDCs), and database partitioning.

*Table 198. ADVISE\_TABLE Table.* PK means that the column is part of a primary key; FK means that the column is part of a foreign key.

| Column Name    | Data Type    | Nullable? | Key? | Description   |
|----------------|--------------|-----------|------|---|
| RUN_ID         | TIMESTAMP    | Yes       | FK   | A value corresponding to the START_TIME of a row in the ADVISE_INSTANCE table, linking it to the same Design Advisor run.   |
| TABLE_NAME     | VARCHAR(128) | No        | No   | Name of the table.  |
| TABLE_SCHEMA   | VARCHAR(128) | No        | No   | Name of the table creator.  |
| TABLESPACE     | VARCHAR(128) | No        | No   | The table space in which the table is to be created.  |
| SELECTION_FLAG | VARCHAR(4)   | No        | No   | Indicates the recommendation type. Valid values are 'M' for MQT, 'P' for database partitioning, and 'C' for MDC. This field can include any subset of these values. For example, 'MC' indicates that the table is recommended as an MQT and an MDC table. |
| TABLE_EXISTS   | CHAR(1)      | No        | No   | Set to 'Y' if the table exists in the database catalog.   |
| USE_TABLE      | CHAR(1)      | No        | No   | Set to 'Y' if the table has recommendations from the Design Advisor.  |
| GEN_COLUMNS    | CLOB(2M)     | No        | No   | Contains a generated columns string if this row includes an MDC recommendation that requires generated columns in the create table DDL.   |
| ORGANIZE_BY    | CLOB(2M)     | No        | No   | For MDC recommendations, contains the ORGANIZE BY clause of the create table DDL.   |
| CREATION_TEXT  | CLOB(2M)     | No        | No   | Contains the create table DDL.  |
| ALTER_COMMAND  | CLOB(2M)     | No        | No   | Contains an ALTER TABLE statement for the table.  |



## ADVISE\_WORKLOAD table

The ADVISE\_WORKLOAD table represents the statement that makes up the workload.

*Table 199. ADVISE\_WORKLOAD Table.* PK means that the column is part of a primary key; FK means that the column is part of a foreign key.

| Column Name    | Data Type    | Nullable? | Key? | Description  |
|----------------|--------------|-----------|------|--|
| WORKLOAD_NAME  | CHAR(128)    | No        | No   | Name of the collection of SQL statements (workload) to which this statement belongs.   |
| STATEMENT_NO   | INTEGER      | No        | No   | Statement number within the workload to which this explain information is related.   |
| STATEMENT_TEXT | CLOB(1M)     | No        | No   | Content of the SQL statement.  |
| STATEMENT_TAG  | VARCHAR(256) | No        | No   | Identifier tag for each explained SQL statement.   |
| FREQUENCY      | INTEGER      | No        | No   | The number of times this statement appears within the workload.  |
| IMPORTANCE     | DOUBLE       | No        | No   | Importance of the statement.   |
| WEIGHT         | DOUBLE       | No        | No   | Priority of the statement.   |
| COST_BEFORE    | DOUBLE       | Yes       | No   | The cost of the query (in timerons) if the recommendations are not created.  |
| COST_AFTER     | DOUBLE       | Yes       | No   | The cost of the query (in timerons) if the recommendations are created. COST_AFTER reflects all recommendations except those that pertain to clustered indexes and multidimensional clustering (MDC).  |
| COMPILABLE     | CHAR(17)     | Yes       | No   | Indicates any query compile errors that occurred while trying to prepare the statement. If this column is NULL or does not start with SQLCA, the SQL query could be compiled by db2advis. If a compile error is found by db2advis or the Design Advisor, the COMPILABLE column value consists of an 8 byte long SQLCA.sqlcaid field, followed by a colon (:), and an 8 byte long SQLCA.sqlstate field, which is the return code for the SQL statement. |

## ADVISE\_WORKLOAD table

## Appendix J. Explain register values

Following is a description of the interaction of the CURRENT EXPLAIN MODE and CURRENT EXPLAIN SNAPSHOT special register values, both with each other and with the PREP and BIND commands.

With dynamic SQL, the CURRENT EXPLAIN MODE and CURRENT EXPLAIN SNAPSHOT special register values interact as follows.

Table 200. Interaction of Explain Special Register Values (Dynamic SQL)

| EXPLAIN<br>SNAPSHOT<br>values | EXPLAIN MODE values   |  |  |  |  |  |
|-------------------------------|---|--|--|--|--|--|
|                               | NO  | YES  | EXPLAIN  | REOPT  | RECOMMEND<br>INDEXES   | EVALUATE<br>INDEXES  |
| NO                            | <ul style="list-style-type: none"> <li>Results of query returned.</li> </ul>                                  | <ul style="list-style-type: none"> <li>Explain tables populated.</li> <li>Results of query returned.</li> </ul>                                  | <ul style="list-style-type: none"> <li>Explain tables populated.</li> <li>Results of query not returned (dynamic statements not executed).</li> </ul>                                  | <ul style="list-style-type: none"> <li>Explain tables populated when a statement qualifies for reoptimization at execution time.</li> <li>Results of query returned.</li> </ul>                                  | <ul style="list-style-type: none"> <li>Explain tables populated.</li> <li>Results of query not returned (dynamic statements not executed).</li> <li>Indexes recommended.</li> </ul>                                  | <ul style="list-style-type: none"> <li>Explain tables populated.</li> <li>Results of query not returned (dynamic statements not executed).</li> <li>Indexes evaluated.</li> </ul>                                  |
| YES                           | <ul style="list-style-type: none"> <li>Explain Snapshot taken.</li> <li>Results of query returned.</li> </ul> | <ul style="list-style-type: none"> <li>Explain tables populated.</li> <li>Explain Snapshot taken.</li> <li>Results of query returned.</li> </ul> | <ul style="list-style-type: none"> <li>Explain tables populated.</li> <li>Explain Snapshot taken.</li> <li>Results of query not returned (dynamic statements not executed).</li> </ul> | <ul style="list-style-type: none"> <li>Explain tables populated when a statement qualifies for reoptimization at execution time.</li> <li>Explain Snapshot taken.</li> <li>Results of query returned.</li> </ul> | <ul style="list-style-type: none"> <li>Explain tables populated.</li> <li>Explain Snapshot taken.</li> <li>Results of query not returned (dynamic statements not executed).</li> <li>Indexes recommended.</li> </ul> | <ul style="list-style-type: none"> <li>Explain tables populated.</li> <li>Explain Snapshot taken.</li> <li>Results of query not returned (dynamic statements not executed).</li> <li>Indexes evaluated.</li> </ul> |

## Explain register values

Table 200. Interaction of Explain Special Register Values (Dynamic SQL) (continued)

| EXPLAIN<br>SNAPSHOT<br>values | EXPLAIN MODE values   |  |  |  |  |  |
|-------------------------------|---|--|--|--|--|--|
|                               | NO  | YES  | EXPLAIN  | REOPT  | RECOMMEND<br>INDEXES   | EVALUATE<br>INDEXES  |
| EXPLAIN                       | <ul style="list-style-type: none"> <li>Explain Snapshot taken.</li> <li>Results of query not returned (dynamic statements not executed).</li> </ul>                           | <ul style="list-style-type: none"> <li>Explain tables populated.</li> <li>Explain Snapshot taken.</li> <li>Results of query not returned (dynamic statements not executed).</li> </ul>                           | <ul style="list-style-type: none"> <li>Explain tables populated.</li> <li>Explain Snapshot taken.</li> <li>Results of query not returned (dynamic statements not executed).</li> </ul>   | <ul style="list-style-type: none"> <li>Explain tables populated when a statement qualifies for reoptimization at execution time.</li> <li>Explain Snapshot taken when a statement qualifies for reoptimization at execution time.</li> <li>Results of query not returned (dynamic or incremental-bind statements not executed).</li> </ul> | <ul style="list-style-type: none"> <li>Explain tables populated.</li> <li>Explain Snapshot taken.</li> <li>Results of query not returned (dynamic statements not executed).</li> <li>Indexes recommended.</li> </ul>   | <ul style="list-style-type: none"> <li>Explain tables populated.</li> <li>Explain Snapshot taken.</li> <li>Results of query not returned (dynamic statements not executed).</li> <li>Indexes evaluated.</li> </ul>   |
| REOPT                         | <ul style="list-style-type: none"> <li>Explain Snapshot taken when a statement qualifies for reoptimization at execution time.</li> <li>Results of query returned.</li> </ul> | <ul style="list-style-type: none"> <li>Explain tables populated.</li> <li>Explain Snapshot taken when a statement qualifies for reoptimization at execution time.</li> <li>Results of query returned.</li> </ul> | <ul style="list-style-type: none"> <li>Explain tables populated.</li> <li>Explain Snapshot taken when a statement qualifies for reoptimization at execution time.</li> <li>Results of query not returned (dynamic or incremental-bind statements not executed).</li> </ul> | <ul style="list-style-type: none"> <li>Explain tables populated when a statement qualifies for reoptimization at execution time.</li> <li>Explain Snapshot taken when a statement qualifies for reoptimization at execution time.</li> <li>Results of query returned.</li> </ul>   | <ul style="list-style-type: none"> <li>Explain tables populated.</li> <li>Explain Snapshot taken when a statement qualifies for reoptimization at execution time.</li> <li>Results of query not returned (dynamic or incremental-bind statements not executed).</li> <li>Indexes recommended.</li> </ul> | <ul style="list-style-type: none"> <li>Explain tables populated.</li> <li>Explain Snapshot taken when a statement qualifies for reoptimization at execution time.</li> <li>Results of query not returned (dynamic or incremental-bind statements not executed).</li> <li>Indexes evaluated.</li> </ul> |

The CURRENT EXPLAIN MODE special register interacts with the EXPLAIN bind option in the following way for dynamic SQL.

Table 201. Interaction of EXPLAIN Bind Option and CURRENT EXPLAIN MODE

| EXPLAIN MODE values | EXPLAIN Bind option values  |   |   |   |
|---------------------|---|---|---|---|
|                     | NO  | YES   | REOPT   | ALL   |
| NO                  | <ul style="list-style-type: none"> <li>Results of query returned.</li> </ul>  | <ul style="list-style-type: none"> <li>Explain tables populated for static SQL.</li> <li>Results of query returned.</li> </ul>  | <ul style="list-style-type: none"> <li>Explain tables populated for static SQL when statement qualifies for reoptimization at execution time.</li> <li>Explain tables populated for dynamic SQL when statement qualifies for reoptimization at execution time.</li> <li>Results of query returned.</li> </ul>                                       | <ul style="list-style-type: none"> <li>Explain tables populated for static SQL.</li> <li>Explain tables populated for dynamic SQL.</li> <li>Results of query returned.</li> </ul>                                       |
| YES                 | <ul style="list-style-type: none"> <li>Explain tables populated for dynamic SQL.</li> <li>Results of query returned.</li> </ul>                                       | <ul style="list-style-type: none"> <li>Explain tables populated for static SQL.</li> <li>Explain tables populated for dynamic SQL.</li> <li>Results of query returned.</li> </ul>                                       | <ul style="list-style-type: none"> <li>Explain tables populated for static SQL when statement qualifies for reoptimization at execution time.</li> <li>Explain tables populated for dynamic SQL when statement qualifies for reoptimization at execution time.</li> <li>Results of query returned.</li> </ul>                                       | <ul style="list-style-type: none"> <li>Explain tables populated for static SQL.</li> <li>Explain tables populated for dynamic SQL.</li> <li>Results of query returned.</li> </ul>                                       |
| EXPLAIN             | <ul style="list-style-type: none"> <li>Explain tables populated for dynamic SQL.</li> <li>Results of query not returned (dynamic statements not executed).</li> </ul> | <ul style="list-style-type: none"> <li>Explain tables populated for static SQL.</li> <li>Explain tables populated for dynamic SQL.</li> <li>Results of query not returned (dynamic statements not executed).</li> </ul> | <ul style="list-style-type: none"> <li>Explain tables populated for static SQL when statement qualifies for reoptimization at execution time.</li> <li>Explain tables populated for dynamic SQL when statement qualifies for reoptimization at execution time.</li> <li>Results of query not returned (dynamic statements not executed).</li> </ul> | <ul style="list-style-type: none"> <li>Explain tables populated for static SQL.</li> <li>Explain tables populated for dynamic SQL.</li> <li>Results of query not returned (dynamic statements not executed).</li> </ul> |

## Explain register values

Table 201. Interaction of EXPLAIN Bind Option and CURRENT EXPLAIN MODE (continued)

| EXPLAIN MODE values | EXPLAIN Bind option values  |   |   |   |
|---------------------|---|---|---|---|
|                     | NO  | YES   | REOPT   | ALL   |
| REOPT               | <ul style="list-style-type: none"> <li>Explain tables populated for dynamic SQL when statement qualifies for reoptimization at execution time.</li> <li>Results of query returned.</li> </ul>     | <ul style="list-style-type: none"> <li>Explain tables populated for static SQL when statement qualifies for reoptimization at execution time.</li> <li>Explain tables populated for dynamic SQL when statement qualifies for reoptimization at execution time.</li> <li>Results of query returned.</li> </ul> | <ul style="list-style-type: none"> <li>Explain tables populated for static SQL when statement qualifies for reoptimization at execution time.</li> <li>Explain tables populated for dynamic SQL when statement qualifies for reoptimization at execution time.</li> <li>Results of query returned.</li> </ul>   | <ul style="list-style-type: none"> <li>Explain tables populated for static SQL when statement qualifies for reoptimization at execution time.</li> <li>Explain tables populated for dynamic SQL when statement qualifies for reoptimization at execution time.</li> <li>Results of query returned.</li> </ul> |
| RECOMMEND INDEXES   | <ul style="list-style-type: none"> <li>Explain tables populated for dynamic SQL.</li> <li>Results of query not returned (dynamic statements not executed).</li> <li>Recommend indexes.</li> </ul> | <ul style="list-style-type: none"> <li>Explain tables populated for static SQL.</li> <li>Explain tables populated for dynamic SQL.</li> <li>Results of query not returned (dynamic statements not executed).</li> <li>Recommend indexes.</li> </ul>   | <ul style="list-style-type: none"> <li>Explain tables populated for static SQL when statement qualifies for reoptimization at execution time.</li> <li>Explain tables populated for dynamic SQL when statement qualifies for reoptimization at execution time.</li> <li>Results of query not returned (dynamic statements not executed).</li> <li>Recommend indexes.</li> </ul> | <ul style="list-style-type: none"> <li>Explain tables populated for static SQL.</li> <li>Explain tables populated for dynamic SQL.</li> <li>Results of query not returned (dynamic statements not executed).</li> <li>Recommend indexes.</li> </ul>   |
| EVALUATE INDEXES    | <ul style="list-style-type: none"> <li>Explain tables populated for dynamic SQL.</li> <li>Results of query not returned (dynamic statements not executed).</li> <li>Evaluate indexes.</li> </ul>  | <ul style="list-style-type: none"> <li>Explain tables populated for static SQL.</li> <li>Explain tables populated for dynamic SQL.</li> <li>Results of query not returned (dynamic statements not executed).</li> <li>Evaluate indexes.</li> </ul>  | <ul style="list-style-type: none"> <li>Explain tables populated for static SQL when statement qualifies for reoptimization at execution time.</li> <li>Explain tables populated for dynamic SQL when statement qualifies for reoptimization at execution time.</li> <li>Results of query not returned (dynamic statements not executed).</li> <li>Evaluate indexes.</li> </ul>  | <ul style="list-style-type: none"> <li>Explain tables populated for static SQL.</li> <li>Explain tables populated for dynamic SQL.</li> <li>Results of query not returned (dynamic statements not executed).</li> <li>Evaluate indexes.</li> </ul>  |

The CURRENT EXPLAIN SNAPSHOT special register interacts with the EXPLSNAP bind option in the following way for dynamic SQL.

Table 202. Interaction of EXPLSNAP bind Option and CURRENT EXPLAIN SNAPSHOT

| EXPLAIN<br>SNAPSHOT values | EXPLSNAP Bind option values   |   |   |   |
|----------------------------|---|---|---|---|
|                            | NO  | YES   | REOPT   | ALL   |
| NO                         | <ul style="list-style-type: none"> <li>Results of query returned.</li> </ul>  | <ul style="list-style-type: none"> <li>Explain Snapshot taken for static SQL.</li> <li>Results of query returned.</li> </ul>  | <ul style="list-style-type: none"> <li>Explain Snapshot taken for static SQL when statement qualifies for reoptimization at execution time.</li> <li>Explain Snapshot taken for dynamic SQL when statement qualifies for reoptimization at execution time.</li> <li>Results of query returned.</li> </ul>                                       | <ul style="list-style-type: none"> <li>Explain Snapshot taken for static SQL.</li> <li>Explain Snapshot taken for dynamic SQL.</li> <li>Results of query returned.</li> </ul>                                       |
| YES                        | <ul style="list-style-type: none"> <li>Explain Snapshot taken for dynamic SQL.</li> <li>Results of query returned.</li> </ul>                                       | <ul style="list-style-type: none"> <li>Explain Snapshot taken for static SQL.</li> <li>Explain Snapshot taken for dynamic SQL.</li> <li>Results of query returned.</li> </ul>                                       | <ul style="list-style-type: none"> <li>Explain Snapshot taken for static SQL when statement qualifies for reoptimization at execution time.</li> <li>Explain Snapshot taken for dynamic SQL when statement qualifies for reoptimization at execution time.</li> <li>Results of query returned.</li> </ul>                                       | <ul style="list-style-type: none"> <li>Explain Snapshot taken for static SQL.</li> <li>Explain Snapshot taken for dynamic SQL.</li> <li>Results of query returned.</li> </ul>                                       |
| EXPLAIN                    | <ul style="list-style-type: none"> <li>Explain Snapshot taken for dynamic SQL.</li> <li>Results of query not returned (dynamic statements not executed).</li> </ul> | <ul style="list-style-type: none"> <li>Explain Snapshot taken for static SQL.</li> <li>Explain Snapshot taken for dynamic SQL.</li> <li>Results of query not returned (dynamic statements not executed).</li> </ul> | <ul style="list-style-type: none"> <li>Explain Snapshot taken for static SQL when statement qualifies for reoptimization at execution time.</li> <li>Explain Snapshot taken for dynamic SQL when statement qualifies for reoptimization at execution time.</li> <li>Results of query not returned (dynamic statements not executed).</li> </ul> | <ul style="list-style-type: none"> <li>Explain Snapshot taken for static SQL.</li> <li>Explain Snapshot taken for dynamic SQL.</li> <li>Results of query not returned (dynamic statements not executed).</li> </ul> |

## Explain register values

Table 202. Interaction of EXPLSNAP bind Option and CURRENT EXPLAIN SNAPSHOT (continued)

| EXPLAIN<br>SNAPSHOT values | EXPLSNAP Bind option values   |   |   |   |
|----------------------------|---|---|---|---|
|                            | NO  | YES   | REOPT   | ALL   |
| REOPT                      | <ul style="list-style-type: none"> <li>Explain Snapshot taken for dynamic SQL when statement qualifies for reoptimization at execution time.</li> <li>Results of query returned.</li> </ul> | <ul style="list-style-type: none"> <li>Explain Snapshot taken for static SQL when statement qualifies for reoptimization at execution time.</li> <li>Explain Snapshot taken for dynamic SQL when statement qualifies for reoptimization at execution time.</li> <li>Results of query returned.</li> </ul> | <ul style="list-style-type: none"> <li>Explain Snapshot taken for static SQL when statement qualifies for reoptimization at execution time.</li> <li>Explain Snapshot taken for dynamic SQL when statement qualifies for reoptimization at execution time.</li> <li>Results of query returned.</li> </ul> | <ul style="list-style-type: none"> <li>Explain Snapshot taken for static SQL when statement qualifies for reoptimization at execution time.</li> <li>Explain Snapshot taken for dynamic SQL when statement qualifies for reoptimization at execution time.</li> <li>Results of query returned.</li> </ul> |



---

## Appendix K. Exception tables

Exception tables are user-created tables that mimic the definition of the tables that are specified to be checked using the SET INTEGRITY statement with the IMMEDIATE CHECKED option. They are used to store copies of the rows that violate constraints in the tables being checked.

The exception tables that are used by the load utility are identical to the ones described here, and can therefore be reused during checking with the SET INTEGRITY statement.

---

### Rules for creating an exception table

The rules for creating an exception table are as follows:

- If the table is protected by a security policy, the exception table must be protected by the same security policy.
- The first “n” columns of the exception table are the same as the columns of the table being checked. All column attributes, including name, data type, and length should be identical. For protected columns, the security label protecting the column must be the same in both tables.
- All of the columns of the exception table must be free of constraints and triggers. Constraints include referential integrity and check constraints, as well as unique index constraints that could cause errors on insert.
- The “(n+1)” column of the exception table is an optional TIMESTAMP column. This serves to identify successive invocations of checking by the SET INTEGRITY statement on the same table, if the rows within the exception table have not been deleted before issuing the SET INTEGRITY statement to check the data.
- The “(n+2)” column should be of type CLOB(32K) or larger. This column is optional but recommended, and will be used to give the names of the constraints that the data within the row violates. If this column is not provided (as could be warranted if, for example, the original table had the maximum number of columns allowed), then only the row where the constraint violation was detected is copied.
- The exception table should be created with both “(n+1)” and “(n+2)” columns.
- There is no enforcement of any particular name for the above additional columns. However, the type specification must be exactly followed.
- No additional columns are allowed.
- If the original table has generated columns (including the IDENTITY property), the corresponding columns in the exception table should not specify the generated property.
- Users invoking the SET INTEGRITY statement to check data must hold the INSERT privilege on the exception tables.
- The exception table cannot be a data partitioned table, a range clustered table, or a detached table.
- The exception table cannot be a materialized query table or a staging table.
- The exception table cannot have any dependent refresh immediate materialized query tables or any dependent propagate immediate staging tables.

The information in the “message” column has the following structure:

## Rules for creating an exception table

Table 203. Exception Table Message Column Structure

| Field number | Contents  | Size                           | Comments  |
|--------------|---|--------------------------------|---|
| 1            | Number of constraint violations                                 | 5 bytes                        | Right justified padded with '0'   |
| 2            | Type of first constraint violation                              | 1 byte                         | 'K' - Check Constraint violation<br>'F' - Foreign Key violation<br>'G' - Generated Column violation<br>'I' - Unique Index violation <sup>a</sup><br>'D' - Delete Cascade violation<br>'P' - Data Partitioning violation<br>'S' - Invalid Row Security Label<br>'L' - DB2 LBAC Write rules violation |
| 3            | Length of constraint/column <sup>b</sup> /index ID <sup>c</sup> | 5 bytes                        | Right justified padded with '0'   |
| 4            | Constraint name/Column name <sup>b</sup> /index ID <sup>c</sup> | length from the previous field |   |
| 5            | Separator   | 3 bytes                        | <space><colon><space>   |
| 6            | Type of next constraint violation                               | 1 byte                         | 'K' - Check Constraint violation<br>'F' - Foreign Key violation<br>'G' - Generated Column violation<br>'I' - Unique Index violation<br>'D' - Delete Cascade violation<br>'P' - Data Partitioning violation<br>'S' - Invalid Row Security Label<br>'L' - DB2 LBAC Write rules violation              |
| 7            | Length of constraint/column/index ID                            | 5 bytes                        | Right justified padded with '0'   |
| 8            | Constraint name/Column name/Index ID                            | length from the previous field |   |
| .....        | .....   | .....                          | Repeat Field 5 through 8 for each violation   |

- <sup>a</sup> Unique index violations will not occur during checking using the SET INTEGRITY statement, unless it is after an attach operation. This will be reported, however, when running LOAD if the FOR EXCEPTION option is chosen. LOAD, on the other hand, will not report check constraint, generated column, foreign key, delete cascade, or data partitioning violations in the exception tables.

- <sup>b</sup> To retrieve the expression of a generated column from the catalog views, use a select statement. For example, if field 4 is MYSCHEMA.MYTABLE.GEN\_1, then SELECT SUBSTR(TEXT, 1, 50) FROM SYSCAT.COLUMNS WHERE TABSCHEMA='MYSCHEMA' AND TABNAME='MYNAME' AND COLNAME='GEN\_1'; will return the first fifty bytes of the expression, in the form "AS (<expression>)"

- <sup>c</sup> To retrieve an index ID from the catalog views, use a select statement. For example, if field 4 is 1234, then SELECT INDSHEMA, INDNAME FROM SYSCAT.INDEXES WHERE IID=1234.

## Handling rows in an exception table

The information in exception tables can be processed in various ways. Data can be corrected and rows re-inserted into the original tables.

If there are no INSERT triggers on the original table, transfer the corrected rows by issuing an INSERT statement with a subquery on the exception table.

If there are INSERT triggers, and you want to complete the load operation with the corrected rows from exception tables without firing the triggers:

- Design the INSERT triggers to be fired depending on the value in a column that has been defined explicitly for the purpose.
- Unload data from the exception tables and append it using the load utility. In this case, if you want to recheck the data, note that constraints checking is not confined to the appended rows.
- Save the trigger definition text from the relevant system catalog view. Then drop the INSERT trigger and use INSERT to transfer the corrected rows from the exception tables. Finally, recreate the trigger using the saved trigger definition.

No explicit provision is made to prevent the firing of triggers when inserting rows from exception tables.

Only one violation per row is reported for unique index violations.

If values with long string or LOB data types are in the table, the values are not inserted into the exception table in the case of unique index violations.

---

## Querying exception tables

The message column structure in an exception table is a concatenated list of constraint names, lengths, and delimiters, as described earlier. This information can be queried.

For example, to retrieve a list of all violations, repeating each row with only the constraint name, assume that the original table T1 had two columns, C1 and C2. Assume also, that the corresponding exception table, E1, has columns C1 and C2, corresponding to those in T1, as well as a message column, MSGCOL. The following query uses recursion to list one constraint name per row (repeating rows that have more than one violation):

```
WITH IV (C1, C2, MSGCOL, CONSTNAME, I, J) AS
  (SELECT C1, C2, MSGCOL,
    CHAR(SUBSTR(MSGCOL, 12,
      INTEGER(DECIMAL (VARCHAR(SUBSTR(MSGCOL,7,5)),5,0))))),
    1,
    15+INTEGER(DECIMAL (VARCHAR(SUBSTR(MSGCOL,7,5)),5,0))
  FROM E1
  UNION ALL
  SELECT C1, C2, MSGCOL,
    CHAR(SUBSTR(MSGCOL, J+6,
      INTEGER(DECIMAL (VARCHAR(SUBSTR(MSGCOL,J+1,5)),5,0))))),
    I+1,
    J+9+INTEGER(DECIMAL (VARCHAR(SUBSTR(MSGCOL,J+1,5)),5,0))
  FROM IV
  WHERE I < INTEGER(DECIMAL (VARCHAR(SUBSTR(MSGCOL,1,5)),5,0))
) SELECT C1, C2, CONSTNAME FROM IV;
```

To list all of the rows that violated a particular constraint, the previous query could be extended as follows:

```
WITH IV (C1, C2, MSGCOL, CONSTNAME, I, J) AS
  (SELECT C1, C2, MSGCOL,
    CHAR(SUBSTR(MSGCOL, 12,
      INTEGER(DECIMAL (VARCHAR(SUBSTR(MSGCOL,7,5)),5,0))))),
    1,
    15+INTEGER(DECIMAL (VARCHAR(SUBSTR(MSGCOL,7,5)),5,0))
  FROM E1
  UNION ALL
  SELECT C1, C2, MSGCOL,
    CHAR(SUBSTR(MSGCOL, J+6,
      INTEGER(DECIMAL (VARCHAR(SUBSTR(MSGCOL,J+1,5)),5,0))))),
    I+1,
    J+9+INTEGER(DECIMAL (VARCHAR(SUBSTR(MSGCOL,J+1,5)),5,0))
  FROM IV
  WHERE I < INTEGER(DECIMAL (VARCHAR(SUBSTR(MSGCOL,1,5)),5,0))
) SELECT C1, C2, CONSTNAME FROM IV;
```

## Querying exception tables

```
      I+1,  
      J+9+INTEGER(DECIMAL(VARCHAR(SUBSTR(MSGCOL,J+1,5)),5,0))  
    FROM IV  
    WHERE I < INTEGER(DECIMAL(VARCHAR(SUBSTR(MSGCOL,1,5)),5,0))  
  ) SELECT C1, C2, CONSTNAME FROM IV WHERE CONSTNAME = 'constraintname';
```

The following query could be used to obtain all of the check constraint violations:

```
WITH IV (C1, C2, MSGCOL, CONSTNAME, CONSTTYPE, I, J) AS  
  (SELECT C1, C2, MSGCOL,  
    CHAR(SUBSTR(MSGCOL, 12,  
      INTEGER(DECIMAL(VARCHAR(SUBSTR(MSGCOL,7,5)),5,0)))),  
    CHAR(SUBSTR(MSGCOL, 6, 1)),  
    1,  
    15+INTEGER(DECIMAL(VARCHAR(SUBSTR(MSGCOL,7,5)),5,0))  
  FROM E1  
 UNION ALL  
  SELECT C1, C2, MSGCOL,  
    CHAR(SUBSTR(MSGCOL, J+6,  
      INTEGER(DECIMAL(VARCHAR(SUBSTR(MSGCOL,J+1,5)),5,0)))),  
    CHAR(SUBSTR(MSGCOL, J, 1)),  
    I+1,  
    J+9+INTEGER(DECIMAL(VARCHAR(SUBSTR(MSGCOL,J+1,5)),5,0))  
  FROM IV  
  WHERE I < INTEGER(DECIMAL(VARCHAR(SUBSTR(MSGCOL,1,5)),5,0))  
 ) SELECT C1, C2, CONSTNAME FROM IV WHERE CONSTTYPE = 'K';
```

## Appendix L. SQL statements allowed in routines

The following table indicates whether or not an SQL statement (specified in the first column) is allowed to execute in a routine with the specified SQL data access indication. If an executable SQL statement is encountered in a routine defined with NO SQL, SQLSTATE 38001 is returned. For other execution contexts, SQL statements that are not supported in any context return SQLSTATE 38003. For other SQL statements not allowed in a CONTAINS SQL context, SQLSTATE 38004 is returned. In a READS SQL DATA context, SQLSTATE 38002 is returned. During creation of an SQL routine, a statement that does not match the SQL data access indication will cause SQLSTATE 42985 to be returned.

If a statement invokes a routine, the effective SQL data access indication for the statement will be the greater of:

- The SQL data access indication of the statement from the following table.
- The SQL data access indication of the routine specified when the routine was created.

For example, the CALL statement has an SQL data access indication of CONTAINS SQL. However, if a stored procedure defined as READS SQL DATA is called, the effective SQL data access indication for the CALL statement is READS SQL DATA.

When a routine invokes an SQL statement, the effective SQL data access indication for the statement must not exceed the SQL data access indication declared for the routine. For example, a function defined as READS SQL DATA could not call a stored procedure defined as MODIFIES SQL DATA.

Table 204. SQL Statement and SQL Data Access Indication

| SQL Statement                  | NO SQL | CONTAINS SQL | READS SQL DATA | MODIFIES SQL DATA |
|--------------------------------|--------|--------------|----------------|-------------------|
| ALTER...                       | N      | N            | N              | Y                 |
| BEGIN DECLARE SECTION          | Y(1)   | Y            | Y              | Y                 |
| CALL                           | N      | Y            | Y              | Y                 |
| CLOSE                          | N      | N            | Y              | Y                 |
| COMMENT ON                     | N      | N            | N              | Y                 |
| COMMIT                         | N      | N(4)         | N(4)           | N(4)              |
| COMPOUND SQL                   | N      | Y            | Y              | Y                 |
| CONNECT(2)                     | N      | N            | N              | N                 |
| CREATE                         | N      | N            | N              | Y                 |
| DECLARE CURSOR                 | Y(1)   | Y            | Y              | Y                 |
| DECLARE GLOBAL TEMPORARY TABLE | N      | N            | N              | Y                 |
| DELETE                         | N      | N            | N              | Y                 |
| DESCRIBE                       | N      | Y            | Y              | Y                 |
| DISCONNECT(2)                  | N      | N            | N              | N                 |
| DROP ...                       | N      | N            | N              | Y                 |
| END DECLARE SECTION            | Y(1)   | Y            | Y              | Y                 |

## SQL statements allowed in routines

Table 204. SQL Statement and SQL Data Access Indication (continued)

| SQL Statement         | NO SQL | CONTAINS SQL | READS SQL DATA | MODIFIES SQL DATA |
|-----------------------|--------|--------------|----------------|-------------------|
| EXECUTE               | N      | Y(3)         | Y(3)           | Y                 |
| EXECUTE IMMEDIATE     | N      | Y(3)         | Y(3)           | Y                 |
| EXPLAIN               | N      | N            | N              | Y                 |
| FETCH                 | N      | N            | Y              | Y                 |
| FREE LOCATOR          | N      | Y            | Y              | Y                 |
| FLUSH EVENT MONITOR   | N      | N            | N              | Y                 |
| GRANT ...             | N      | N            | N              | Y                 |
| INCLUDE               | Y(1)   | Y            | Y              | Y                 |
| INSERT                | N      | N            | N              | Y                 |
| LOCK TABLE            | N      | Y            | Y              | Y                 |
| OPEN                  | N      | N            | Y(5)           | Y                 |
| PREPARE               | N      | Y            | Y              | Y                 |
| REFRESH TABLE         | N      | N            | N              | Y                 |
| RELEASE CONNECTION(2) | N      | N            | N              | N                 |
| RELEASE SAVEPOINT     | N      | N            | N              | Y                 |
| RENAME TABLE          | N      | N            | N              | Y                 |
| REVOKE ...            | N      | N            | N              | Y                 |
| ROLLBACK              | N      | N(4)         | N(4)           | N(4)              |
| ROLLBACK TO SAVEPOINT | N      | N            | N              | Y                 |
| SAVEPOINT             | N      | N            | N              | Y                 |
| SELECT INTO           | N      | N            | Y(5)           | Y                 |
| SET CONNECTION(2)     | N      | N            | N              | N                 |
| SET INTEGRITY         | N      | N            | N              | Y                 |
| SET special register  | N      | Y            | Y              | Y                 |
| UPDATE                | N      | N            | N              | Y                 |
| VALUES INTO           | N      | N            | Y              | Y                 |
| WHENEVER              | Y(1)   | Y            | Y              | Y                 |

### Notes:

1. Although the NO SQL option implies that no SQL statements can be specified, non-executable statements are not restricted.
2. Connection management statements are not allowed in any routine execution context.
3. It depends on the statement being executed. The statement specified for the EXECUTE statement must be a statement that is allowed in the context of the particular SQL access level in effect. For example, if the SQL access level READS SQL DATA is in effect, the statement cannot be INSERT, UPDATE, or DELETE.
4. The COMMIT statement and the ROLLBACK statement without the TO SAVEPOINT clause can be used in a stored procedure, but only if the stored

procedure is called directly from an application, or indirectly through nested stored procedure calls from an application. (If any trigger, function, method, or atomic compound statement is in the call chain to the stored procedure, COMMIT or ROLLBACK of a unit of work is not allowed.)

5. If the SQL access level READS SQL DATA is in effect, no SQL data change statement can be embedded in the SELECT INTO statement or in the cursor referenced by the OPEN statement.

## SQL statements allowed in routines



---

## Appendix M. CALL invoked from a compiled statement

Invokes a procedure stored at the location of a database. A procedure, for example, executes at the location of the database, and returns data to the client application.

Programs using the SQL CALL statement are designed to run in two parts, one on the client and the other on the server. The server procedure at the database runs within the same transaction as the client application. If the client application and procedure are on the same database partition, the stored procedure is executed locally.

**Note:** This form of the CALL statement is deprecated, and is only being provided for compatibility with previous versions of DB2.

### Invocation:

This form of the CALL statement can only be embedded in an application program that is precompiled with the CALL\_RESOLUTION DEFERRED option. It cannot invoke a federated procedure. It cannot be used in triggers, SQL procedures, or any other non-application contexts. It is an executable statement that cannot be dynamically prepared. However, the procedure name can be specified through a host variable and this, coupled with the use of the USING DESCRIPTOR clause, allows both the procedure name and the parameter list to be provided at run time, which achieves an effect similar to that of a dynamically prepared statement.

### Authorization:

The privileges held by the authorization ID of the statement *at run time* must include at least one of the following:

- EXECUTE privilege on the package that is associated with the procedure; EXECUTE privilege on the procedure is not checked
- CONTROL privilege on the package that is associated with the procedure
- SYSADM or DBADM authority

### Syntax:

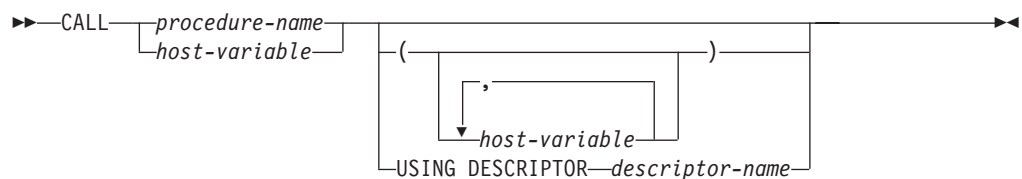

### Description:

*procedure-name* **or** *host-variable*

Identifies the procedure to call. The procedure name may be specified either directly or within a host variable. The procedure identified must exist at the current server (SQLSTATE 42724).

If *procedure-name* is specified, it must be an ordinary identifier that is not greater than 254 bytes. Because this can only be an ordinary identifier, it cannot

## CALL invoked from a compiled statement

contain blanks or special characters. The value is converted to uppercase. If it is necessary to use lowercase names, blanks, or special characters, the name must be specified via a *host-variable*.

If *host-variable* is specified, it must be a CHAR or VARCHAR variable with a length attribute that is not greater than 254 bytes, and it must not include an indicator variable. The value is *not* converted to uppercase. The character string must be left-justified.

The procedure name can take one of several forms:

### *procedure-name*

The name (with no extension) of the procedure to execute. The procedure that is invoked is determined as follows.

1. The *procedure-name* is used to search the defined procedures (in SYSCAT.ROUTINES) for a matching procedure. A matching procedure is determined using the steps that follow.
  - a. Find the procedures (ROUTINETYPE is 'P') from the catalog (SYSCAT.ROUTINES), where the ROUTINENAME matches the specified *procedure-name*, and the ROUTINESHEMA is a schema name in the SQL path (CURRENT PATH special register). If the schema name is explicitly specified, the SQL path is ignored, and only procedures with the specified schema name are considered.
  - b. Next, eliminate any of these procedures that do not have the same number of parameters as the number of arguments specified in the CALL statement.
  - c. Chose the remaining procedure that is earliest in the SQL path.

If a procedure is selected, DB2 will invoke the procedure defined by the external name.

2. If no matching procedure was found, *procedure-name* is used both as the name of the procedure library, and the function name within that library. For example, if *procedure-name* is `proclib`, the DB2 server will load the procedure library named `proclib` and execute the function routine `proclib()` within that library.

On UNIX systems, the default directory for procedure libraries is `sqllib/function`. The default directory for unfenced procedures is `sqllib/function/unfenced`.

In Windows-based systems, the default directory for procedure libraries is `sqllib\function`. The default directory for unfenced procedures is `sqllib\function\unfenced`.

If the library or function could not be found, an error is returned (SQLSTATE 42884).

### *procedure-library!function-name*

The exclamation character (!) acts as a delimiter between the library name and the function name of the procedure. For example, if `proclib!func` is specified, `proclib` is loaded into memory, and the function `func` from that library is executed. This allows multiple functions to be placed in the same procedure library.

The procedure library is located in the directories or specified in the LIBPATH variable, as described in *procedure-name*.

### *absolute-path!function-name*

The *absolute-path* specifies the complete path to the stored procedure library.

## CALL invoked from a compiled statement

On a UNIX system, for example, if `/u/terry/proclib!func` is specified, the procedure library `proclib` is obtained from the directory `/u/terry`, and the function `func` from that library is executed.

In all of these cases, the total length of the procedure name, including its implicit or explicit full path, must not be longer than 254 bytes.

*(host-variable,...)*

Each specification of *host-variable* is a parameter of the CALL statement. The *n*th parameter of the CALL corresponds to the *n*th parameter of the server's procedure.

Each *host-variable* is assumed to be used for exchanging data in both directions between client and server. To avoid sending unnecessary data between client and server, the client application should provide an indicator variable with each parameter, and set the indicator to -1 if the parameter is not used to transmit data to the procedure. The procedure should set the indicator variable to -128 for any parameter that is not used to return data to the client application.

If the server is DB2 9.1 database server, the parameters must have matching data types in both the client and server program.

### USING DESCRIPTOR *descriptor-name*

Identifies an SQLDA that must contain a valid description of host variables. The *n*th SQLVAR element corresponds to the *n*th parameter of the server's procedure.

Before the CALL statement is processed, the application must set the following fields in the SQLDA:

- SQLN to indicate the number of SQLVAR occurrences provided in the SQLDA
- SQLDABC to indicate the number of bytes of storage allocated for the SQLDA
- SQLD to indicate the number of variables used in the SQLDA when processing the statement
- SQLVAR occurrences to indicate the attributes of the variables. The following fields of each Base SQLVAR element passed must be initialized:
  - SQLTYPE
  - SQLLEN
  - SQLDATA
  - SQLIND

The following fields of each Secondary SQLVAR element passed must be initialized:

- LEN.SQLLONGLEN
- SQLDATALEN
- SQLDATATYPE\_NAME

The SQLDA is assumed to be used for exchanging data in both directions between client and server. To avoid sending unnecessary data between client and server, the client application should set the SQLIND field to -1 if the parameter is not used to transmit data to the procedure. The procedure should set the SQLIND field -128 for any parameter that is not used to return data to the client application.

## CALL invoked from a compiled statement

### Notes:

- *Use of Large Object (LOB) data types:*

If the client and server application needs to specify LOB data from an SQLDA, allocate double the number of SQLVAR entries.

LOB data types have been supported by procedures since DB2 Version 2. The LOB data types are not supported by all down level clients or servers.

- *Retrieving the DB2\_RETURN\_STATUS from an SQL procedure:*

If an SQL procedure successfully issues a RETURN statement with a status value, this value is returned in the first SQLERRD field of the SQLCA. If the CALL statement is issued in an SQL procedure, use the GET DIAGNOSTICS statement to retrieve the DB2\_RETURN\_STATUS value. The value is -1 if the SQLSTATE indicates an error.

- *Returning result sets from procedures:*

If the client application program is written using CLI, result sets can be returned directly to the client application. The procedure indicates that a result set is to be returned by declaring a cursor on that result set, opening a cursor on the result set, and leaving the cursor open when exiting the procedure.

At the end of a procedure:

- For every cursor that has been left open, a result set is returned to the application.
- If more than one cursor is left open, the result sets are returned in the order in which their cursors were opened.
- Only unread rows are passed back. For example, if the result set of a cursor has 500 rows, and 150 of those rows have been read by the procedure at the time the procedure is terminated, rows 151 through 500 will be returned to the procedure.

- *Handling of special registers:*

The settings of special registers for the caller are inherited by the procedure on invocation, and restored upon return to the caller. Special registers may be changed within a procedure, but these changes do not affect the caller. This is not true for legacy procedures (those defined with parameter style DB2DARI, or found in the default library), where the changes made to special registers in a procedure become the settings for the caller.

- *Compatibilities*

There is a newer, preferred, form of the CALL statement that can be embedded in an application (by precompiling the application with the CALL\_RESOLUTION IMMEDIATE option), or that can be dynamically prepared.

### Examples:

#### Example 1:

In C, invoke a procedure called TEAMWINS in the ACHIEVE library, passing it a parameter stored in the host variable HV\_ARGUMENT.

```
strcpy(HV_PROCNAME, "ACHIEVE!TEAMWINS");  
CALL :HV_PROCNAME (:HV_ARGUMENT);
```

#### Example 2:

In C, invoke a procedure called :SALARY\_PROC, using the SQLDA named INOUT\_SQLDA.

## CALL invoked from a compiled statement

```
struct sqllda *INOUT_SQLDA;
/* Setup code for SQLDA variables goes here */
CALL :SALARY_PROC
USING DESCRIPTOR :*INOUT_SQLDA;
```

Example 3:

A Java procedure is defined in the database, using the following statement:

```
CREATE PROCEDURE PARTS_ON_HAND (IN PARTNUM INTEGER,
                                OUT COST DECIMAL(7,2),
                                OUT QUANTITY INTEGER)
    EXTERNAL NAME 'parts!onhand'
    LANGUAGE JAVA
    PARAMETER STYLE DB2GENERAL;
```

A Java application calls this procedure using the following code fragment:

```
...
CallableStatement stpCall;

String sql = "CALL PARTS_ON_HAND (?,?,?)";

stpCall = con.prepareStatement( sql ); /* con is the connection */

stpCall.setInt( 1, variable1 );
stpCall.setBigDecimal( 2, variable2 );
stpCall.setInt( 3, variable3 );

stpCall.registerOutParameter( 2, Types.DECIMAL, 2 );
stpCall.registerOutParameter( 3, Types.INTEGER );

stpCall.execute();

variable2 = stpCall.getBigDecimal(2);
variable3 = stpCall.getInt(3);
...
```

This application code fragment will invoke the Java method *onhand* in class *parts*, because the procedure name specified on the CALL statement is found in the database and has the external name 'parts!onhand'.

### Related reference:

- "CALL statement" in *SQL Reference, Volume 2*

**CALL invoked from a compiled statement**

---

## Appendix N. Japanese and traditional-Chinese extended UNIX code (EUC) considerations

Extended UNIX Code (EUC) for Japanese and Traditional-Chinese defines a set of encoding rules that can support from 1 to 4 character sets. In some cases, such as Japanese EUC (eucJP) and Traditional-Chinese EUC (eucTW), a character may be encoded using more than two bytes. Use of such an encoding scheme has implications when used as the code page of the database server or the database client. The key considerations involve the following:

- Expansion or contraction of strings when converting between EUC code pages and double-byte code pages
- Use of Universal Character Set-2 (UCS-2) as the code page for graphic data stored in a database server defined with the eucJP (Japanese) or eucTW (Traditional-Chinese) code pages.

With the exception of these considerations, the use of EUC is consistent with the double-byte character set (DBCS) support. Throughout this book (and others), references to *double-byte* have been changed to *multi-byte* to reflect support for encoding rules that allow for character representations that require more than 2 bytes. Detailed considerations for support of Japanese and Traditional-Chinese EUC are included here. This information should be considered by anyone using SQL with an EUC database server or an EUC database client, and used in conjunction with application development information.

---

### Language elements

#### Characters

Each multi-byte character is considered a *letter* with the exception of the double-byte blank character which is considered a *special character*.

#### Tokens

Multi-byte lowercase alphabetic letters are not folded to uppercase. This differs from the single byte lowercase alphabetic letters in tokens which are generally folded to uppercase.

#### Identifiers

##### SQL identifiers

Conversion between a double-byte code page and an EUC code page may result in the conversion of double-byte characters to multi-byte characters encoded with more than 2 bytes. As a result, an identifier that fits the length maximum in the double-byte code page may exceed the length in the EUC code page. Selecting identifiers for this type of environment must be done carefully to avoid expansion beyond the maximum identifier length.

#### Data types

##### Character strings

In an MBCS database, character strings may contain a mixture of characters from a single-byte character set (SBCS) and from multi-byte character sets (MBCS). When using such strings, operations may provide different results if they are character

## Character strings

based (treat the data as characters) or byte based (treat the data as bytes). Check the function or operation description to determine how mixed strings are processed.

### Graphic strings

A graphic string is defined as a sequence of double-byte character data. In order to allow Japanese or Traditional-Chinese EUC data to be stored in graphic columns, EUC characters are encoded in UCS-2. Characters that are not double-byte characters under all supported encoding schemes (for example, PC or EBCDIC DBCS) should not be used with graphic columns. The results of using other than double-byte characters may result in replacement by substitution characters during conversion. Retrieval of such data will not return the same value as was entered.

### Assignments and comparisons

**String assignments:** Conversion of a string is performed prior to the assignment. In cases involving an eucJP/eucTW code page and a DBCS code page, a character string may become longer (DBCS to eucJP/eucTW) or shorter (eucJP/eucTW to DBCS). This may result in errors on storage assignment and truncation on retrieval assignment. When the error on storage assignment is due to expansion during conversion, SQLSTATE 22524 is returned instead of SQLSTATE 22001.

Similarly, assignments involving graphic strings may result in the conversion of a UCS-2 encoded double-byte character to a substitution character in a PC or EBCDIC DBCS code page for characters that do not have a corresponding double-byte character. Assignments that replace characters with substitution characters will indicate this by setting the SQLWARN10 field of the SQLCA to 'W'.

In cases of truncation during retrieval assignment involving multi-byte character strings, the point of truncation may be part of a multi-byte character. In this case, each byte of the character fragment is replaced with a single-byte blank. This means that more than one single-byte blank may appear at the end of a truncated character string.

**String comparisons:** String comparisons are performed on a byte basis. Character strings also use the collating sequence defined for the database. Graphic strings do not use the collating sequence and, in an eucJP or eucTW database, are encoded using UCS-2. Thus, the comparison of two mixed character strings may have a different result from the comparison of two graphic strings even though they contain the same characters. Similarly, the resulting sort order of a mixed character column and a graphic column may be different.

### Rules for result data types

The resulting data type for character strings is not affected by the possible expansion of the string. For example, a union of two CHAR operands will still be a CHAR. However, if one of the character string operands will be converted such that the maximum expansion makes the length attribute the largest of the two operands, then the resulting character string length attribute is affected. For example, consider the result expressions of a CASE expression that have data types of VARCHAR(100) and VARCHAR(120). Assume the VARCHAR(100) expression is a mixed string host variable (that may require conversion) and the VARCHAR(120) expression is a column in the eucJP database. The resulting data type is VARCHAR(200) since the VARCHAR(100) is doubled to allow for possible conversion. The same scenario without the involvement of an eucJP or eucTW database would have a result type of VARCHAR(120).



Notice that the doubling of the host variable length is based on the fact that the database server is Japanese EUC or Traditional-Chinese EUC. Even if the client is also eucJP or eucTW, the doubling is still applied. This allows the same application package to be used by double-byte or multi-byte clients.

### Rules for string conversions

The types of operations listed in the corresponding section of the SQL Reference may convert operands to either the application or the database code page.

If such operations are done in a mixed code page environment that includes Japanese or Traditional-Chinese EUC, expansion or contraction of mixed character string operands can occur. Therefore, the resulting data type has a length attribute that accommodates the maximum expansion, if possible. In cases where there are restrictions on the length attribute of the data type, the maximum allowed length for the data type is used. For example in an environment where maximum growth is double, a VARCHAR(200) host variable is treated as if it is a VARCHAR(400), but CHAR(200) host variable is treated as if it is a CHAR(254). A run-time error may occur when conversion is performed if the converted string would exceed the maximum length for the data type. For example, the union of CHAR(200) and CHAR(10) would have a result type of CHAR(254). If more than 254 bytes are required when the value from the left side of the UNION is converted, an error is returned.

In some cases, allowing for the maximum growth for conversion will cause the length attribute to exceed a limit. For example, UNION only allows columns up to 254 bytes. Thus, a query with a union that included a host variable in the column list (call it :hv1) that was a DBCS mixed character string defined as a varying length character string 128 bytes long, would set the data type to VARCHAR(256) resulting in an error preparing the query, even though the query in the application does not appear to have any columns greater than 254. In a situation where the actual string is not likely to cause expansion beyond 254 bytes, the following can be used to prepare the statement.

```
SELECT CAST(:hv1 CONCAT ' AS VARCHAR(254)), C2 FROM T1
UNION
SELECT C1, C2 FROM T2
```

The concatenation of the null string with the host variable will force the conversion to occur before the cast is done. This query can be prepared in the DBCS to eucJP/eucTW environment although a truncation error may occur at run time.

This technique (null string concat with cast) can be used to handle the similar 254-byte limit for SELECT DISTINCT or use of the column in ORDER BY or GROUP BY clauses.

## Constants

### Graphic string constants

Japanese or Traditional-Chinese EUC client, may contain single or multi-byte characters (like a mixed character string). The string should not contain more than 2000 bytes. It is recommended that only characters that convert to double-byte characters in all related PC and EBCDIC double-byte code pages be used in graphic constants. A graphic string constant in an SQL statement is converted from the client code page to the double-byte encoding at the database server. For a Japanese or Traditional-Chinese EUC server, the constant is converted to UCS-2,

## Graphic string constants

the double-byte encoding used for graphic strings. For a double-byte server, the constant is converted from the client code page to the DBCS code page of the server.

## Functions

The design of user-defined functions should consider the impact of supporting Japanese or Tradition-Chinese EUC on the parameter data types. One part of function resolution considers the data types of the arguments to a function call. Mixed character string arguments involving a Japanese or Traditional-Chinese EUC client may require additional bytes to specify the argument. This may require that the data type change to allow the increased length. For example, it may take 4001 bytes to represent a character string in the application (a LONG VARCHAR) that fits into a VARCHAR(4000) string at the server. If a function signature is not included that allows the argument to be a LONG VARCHAR, function resolution will fail to find a function.

Some functions exist that do not allow long strings for various reasons. Use of LONG VARCHAR or CLOB arguments with such functions will not succeed. For example, LONG VARCHAR as the second argument of the built-in POSSTR function, will fail function resolution (SQLSTATE 42884).

## Expressions

### With the concatenation operator

The potential expansion of one of the operands of concatenation may cause the data type and length of concatenated operands to change when in an environment that includes a Japanese or Traditional-Chinese EUC database server. For example, with an EUC server where the value from a host variable may double in length, consider the following example.

```
CHAR200 CONCAT :char50
```

The column *CHAR200* is of type CHAR(200). The host variable *char50* is defined as CHAR(50). The result type for this concatenation operation would normally be CHAR(250). However, given an eucJP or eucTW database server, the assumption is that the string may expand to double the length. Hence *char50* is treated as a CHAR(100) and the resulting data type is VARCHAR(300). Note that even though the result is a VARCHAR, it will always have 300 bytes of data including trailing blanks. If the extra trailing blanks are not desired, define the host variable as VARCHAR(50) instead of CHAR(50).

## Predicates

### LIKE predicate

For a LIKE predicate involving mixed character strings in an EUC database:

- An SBCS halfwidth underscore character refers to one SBCS character.
- A non-SBCS fullwidth underscore character refers to one non-SBCS character.
- An SBCS halfwidth or non-SBCS fullwidth percent sign character refers to zero or more SBCS or non-SBCS characters.

The escape character must be one SBCS or non-SBCS character. In a character column, the escape character can also be a binary string containing exactly one byte.

Note that use of the underscore character may produce different results, depending on the code page of the LIKE operation. For example, Katakana characters in

Japanese EUC are multi-byte characters (CS2) but in the Japanese DBCS code page they are single-byte characters. A query with the single-byte underscore in the *pattern-expression* would return occurrences of Katakana character in the position of the underscore from a Japanese DBCS server. However, the same rows from the equivalent table in a Japanese EUC server would not be returned, since the Katakana characters will only match with a double-byte underscore.

For a LIKE predicate involving graphic strings in an EUC database:

- A fullwidth underscore character (U+FF3F) refers to one Unicode character.
- A fullwidth percent sign character (U+FF05) refers to zero or more Unicode characters.

---

## Functions

### LENGTH

The processing of this function is no different for mixed character strings in an EUC environment. The value returned is the length of the string in the code page of the argument. As of Version 8, if the argument is a host variable, the value returned is the length of the string in the database code page. When using this function to determine the length of a value, careful consideration should be given to how the length is used. This is especially true for mixed string constants since the length is given in bytes, not characters. For example, the length of a mixed string column in a DBCS database returned by the LENGTH function may be less than the length of the retrieved value of that column on an eucJP or eucTW client due to the conversion of some DBCS characters to multi-byte eucJP or eucTW characters.

### SUBSTR

The SUBSTR function operates on mixed character strings on a byte basis. The resulting string may therefore include fragments of multi-byte characters at the beginning or end of the resulting string. No processing is provided to detect or process fragments of characters.

### TRANSLATE

The TRANSLATE function supports mixed character strings including multi-byte characters. The corresponding characters of the *to-string-exp* and the *from-string-exp* must have the same number of bytes and cannot end with part of a multi-byte character.

The *pad-char-exp* must result in a single-byte character when the *char-string-exp* is a character string. Since TRANSLATE is performed in the code page of the *char-string-exp*, the *pad-char-exp* may be converted from a multi-byte character to a single-byte character.

A *char-string-exp* that ends with part of a multi-byte character will not have those bytes translated.

### VARGRAPHIC

The VARGRAPHIC function on a character string operand in a Japanese or Traditional-Chinese EUC code page returns a graphic string in the UCS-2 code page.

- Single-byte characters are converted first to their corresponding double-byte character in the code set to which they belong (eucJP or eucTW). Then they are

converted to the corresponding UCS-2 representation. If there is no double-byte representation, the character is converted to the double-byte substitution character defined for that code set before being converted to UCS-2 representation.

- Characters from eucJP that are Katakana (eucJP CS2) are actually single byte characters in some encoding schemes. They are thus converted to corresponding double-byte characters in eucJP or to the double-byte substitution character before converting to UCS-2.
- Multi-byte characters are converted to their UCS-2 representations.

---

## Statements

### CONNECT

The processing of a successful CONNECT statement returns information in the SQLCA that is important when the possibility exists for applications to process data in an environment that includes a Japanese or Traditional-Chinese EUC code page at the client or server. The *SQLERRD(1)* field gives the maximum expansion of a mixed character string when converted from the application code page to the database code page. The *SQLERRD(2)* field gives the maximum expansion of a mixed character string when converted from the database code page to the application code page. The value is positive if expansion could occur and negative if contraction could occur. If the value is negative, the value is always -1 since the worst case is that no contraction occurs and the full length of the string is required after conversion. Positive values may be as large as 2, meaning that in the worst case, double the string length may be required for the character string after conversion.

The code page of the application server and the application client are also available in the SQLERRMC field of the SQLCA.

### PREPARE

The data types determined for untyped parameter markers are not changed in an environment that includes Japanese or Traditional-Chinese EUC. As a result, it may be necessary in some cases to use typed parameter markers to provide sufficient length for mixed character strings in eucJP or eucTW. For example, consider an insert to a CHAR(10) column. Preparing the statement:

```
INSERT INTO T1 (CH10) VALUES (?)
```

would result in a data type of CHAR(10) for the parameter marker. If the client was eucJP or eucTW, more than 10 bytes may be required to represent the string to be inserted but the same string in the DBCS code page of the database is not more than 10 bytes. In this case, the statement to prepare should include a typed parameter marker with a length greater than 10. Thus, preparing the statement:

```
INSERT INTO T1 (CH10) VALUES (CAST(? AS VARCHAR(20)))
```

would result in a data type of VARCHAR(20) for the parameter marker.

#### Related reference:

- "PREPARE statement" in *SQL Reference, Volume 2*

---

## Appendix O. Backus-Naur form (BNF) specifications for DATALINKs

A DATALINK value is an encapsulated value that contains a logical reference from the database to a file stored outside the database.

The data location attribute of this encapsulated value is a logical reference to a file in the form of a uniform resource locator (URL). The value of this attribute conforms to the syntax for URLs as specified by the following BNF, based on RFC 1738 : Uniform Resource Locators (URL), T. Berners-Lee, L. Masinter, M. McCahill, December 1994. (BNF is an acronym for "Backus-Naur Form", a formal notation to describe the syntax of a given language.)

The following conventions are used in the BNF specification:

- "|" is used to designate alternatives
- brackets [ ] are used around optional or repeated elements
- literals are quoted with ""
- elements may be preceded with [n]\* to designate n or more repetitions of the following element; if n is not specified, the default is 0

The BNF specification for DATALINKs:

### URL

```
url          =  httpurl | fileurl | uncurl | emptyurl
```

### HTTP

```
httpurl     =  "http://" hostport [ "/" hpath ]
hpath       =  hsegment *[ "/" hsegment ]
hsegment    =  *[ uchar | ";" | ":" | "@" | "&" | "=" ]
```

Note that the search element from the original BNF in RFC1738 has been removed, because it is not an essential part of the file reference and does not make sense in DATALINKs context.

### FILE

```
fileurl     =  "file://" host "/" fpath
fpath       =  fsegment *[ "/" fsegment ]
fsegment    =  *[ uchar | "?" | ":" | "@" | "&" | "=" ]
```

Note that host is not optional and the "localhost" string does not have any special meaning, in contrast with RFC1738. This avoids confusing interpretations of "localhost" in client/server and partitioned database configurations.

### UNC

```
uncurl      =  "unc:\\\" hostname "\" sharename "\" uncpath
sharename   =  *uchar
uncpath     =  fsegment *[ "\" fsegment ]
```

Supports the commonly used UNC naming convention on Windows. This is not a standard scheme in RFC1738.

### EMPTYURL

```
emptyurl    =  ""
hostport    =  host [ ":" port ]
host        =  hostname | hostnumber
```

## Backus-Naur form (BNF) specifications for DATALINKs

```
hostname = *[ domainlabel "." ] toplabel
domainlabel = alphanumerical | alphanumerical *[ alphanumerical | "-" ] alphanumerical
toplabel = alpha | alpha *[ alphanumerical | "-" ] alphanumerical
alphanumerical = alpha | digit
hostnumber = digits "." digits "." digits "." digits
port = digits
```

Empty (zero-length) URLs are also supported for DATALINK values. These are useful to update DATALINK columns when reconcile exceptions are reported and non-nullable DATALINK columns are involved. A zero-length URL is used to update the column and cause a file to be unlinked.

### Miscellaneous Definitions

```
lowalpha = "a" | "b" | "c" | "d" | "e" | "f" | "g" | "h" |
           "i" | "j" | "k" | "l" | "m" | "n" | "o" | "p" |
           "q" | "r" | "s" | "t" | "u" | "v" | "w" | "x" |
           "y" | "z"
hialpha = "A" | "B" | "C" | "D" | "E" | "F" | "G" | "H" |
           "I" | "J" | "K" | "L" | "M" | "N" | "O" | "P" |
           "Q" | "R" | "S" | "T" | "U" | "V" | "W" | "X" |
           "Y" | "Z"
alpha = lowalpha | hialpha
digit = "0" | "1" | "2" | "3" | "4" | "5" | "6" | "7" |
        "8" | "9"
safe = "$" | "-" | " " | "." | "+"
extra = "!" | "*" | "~" | "(" | ")" | ","
hex = digit | "A" | "B" | "C" | "D" | "E" | "F" |
      "a" | "b" | "c" | "d" | "e" | "f"
escape = "%" hex hex
unreserved = alpha | digit | safe | extra
uchar = unreserved | escape
digits = 1*digit
```

Leading and trailing blank characters are trimmed by DB2 while parsing. Also, the scheme names ('HTTP', 'FILE', 'UNC') and host are case-insensitive, and are always stored in the database in uppercase.

---

## Appendix P. DB2 Database technical information

---

### Overview of the DB2 technical information

DB2 technical information is available through the following tools and methods:

- DB2 Information Center
  - Topics
  - Help for DB2 tools
  - Sample programs
  - Tutorials
- DB2 books
  - PDF files (downloadable)
  - PDF files (from the DB2 PDF CD)
  - printed books
- Command line help
  - Command help
  - Message help
- Sample programs

IBM periodically makes documentation updates available. If you access the online version on the DB2 Information Center at [ibm.com](http://ibm.com)<sup>®</sup>, you do not need to install documentation updates because this version is kept up-to-date by IBM. If you have installed the DB2 Information Center, it is recommended that you install the documentation updates. Documentation updates allow you to update the information that you installed from the *DB2 Information Center CD* or downloaded from Passport Advantage as new information becomes available.

**Note:** The DB2 Information Center topics are updated more frequently than either the PDF or the hard-copy books. To get the most current information, install the documentation updates as they become available, or refer to the DB2 Information Center at [ibm.com](http://ibm.com).

You can access additional DB2 technical information such as technotes, white papers, and Redbooks<sup>™</sup> online at [ibm.com](http://ibm.com). Access the DB2 Information Management software library site at <http://www.ibm.com/software/data/sw-library/>.

### Documentation feedback

We value your feedback on the DB2 documentation. If you have suggestions for how we can improve the DB2 documentation, send an e-mail to [db2docs@ca.ibm.com](mailto:db2docs@ca.ibm.com). The DB2 documentation team reads all of your feedback, but cannot respond to you directly. Provide specific examples wherever possible so that we can better understand your concerns. If you are providing feedback on a specific topic or help file, include the topic title and URL.

Do not use this e-mail address to contact DB2 Customer Support. If you have a DB2 technical issue that the documentation does not resolve, contact your local IBM service center for assistance.

**Related concepts:**

- “Features of the DB2 Information Center” in *Online DB2 Information Center*
- “Sample files” in *Samples Topics*

**Related tasks:**

- “Invoking command help from the command line processor” in *Command Reference*
- “Invoking message help from the command line processor” in *Command Reference*
- “Updating the DB2 Information Center installed on your computer or intranet server” on page 855

**Related reference:**

- “DB2 technical library in PDF format” on page 850

---

## DB2 technical library in PDF format

The following tables describe the DB2 library available from the IBM Publications Center at [www.ibm.com/shop/publications/order](http://www.ibm.com/shop/publications/order).

Although the tables identify books available in print, the books might not be available in your country or region.

The information in these books is fundamental to all DB2 users; you will find this information useful whether you are a programmer, a database administrator, or someone who works with DB2 Connect or other DB2 products.

*Table 205. DB2 technical information*

| <b>Name</b>  | <b>Form Number</b> | <b>Available in print</b> |
|--|--------------------|---------------------------|
| <i>Administration Guide: Implementation</i>                    | SC10-4221          | Yes                       |
| <i>Administration Guide: Planning</i>                          | SC10-4223          | Yes                       |
| <i>Administrative API Reference</i>                            | SC10-4231          | Yes                       |
| <i>Administrative SQL Routines and Views</i>                   | SC10-4293          | No                        |
| <i>Call Level Interface Guide and Reference, Volume 1</i>      | SC10-4224          | Yes                       |
| <i>Call Level Interface Guide and Reference, Volume 2</i>      | SC10-4225          | Yes                       |
| <i>Command Reference</i>                                       | SC10-4226          | No                        |
| <i>Data Movement Utilities Guide and Reference</i>             | SC10-4227          | Yes                       |
| <i>Data Recovery and High Availability Guide and Reference</i> | SC10-4228          | Yes                       |
| <i>Developing ADO.NET and OLE DB Applications</i>              | SC10-4230          | Yes                       |
| <i>Developing Embedded SQL Applications</i>                    | SC10-4232          | Yes                       |
| <i>Developing SQL and External Routines</i>                    | SC10-4373          | No                        |



Table 205. DB2 technical information (continued)

| Name   | Form Number | Available in print |
|--|-------------|--------------------|
| <i>Developing Java Applications</i>  | SC10-4233   | Yes                |
| <i>Developing Perl and PHP Applications</i>  | SC10-4234   | No                 |
| <i>Getting Started with Database Application Development</i>   | SC10-4252   | Yes                |
| <i>Getting started with DB2 installation and administration on Linux and Windows</i>   | GC10-4247   | Yes                |
| <i>Message Reference Volume 1</i>  | SC10-4238   | No                 |
| <i>Message Reference Volume 2</i>  | SC10-4239   | No                 |
| <i>Migration Guide</i>   | GC10-4237   | Yes                |
| <i>Net Search Extender Administration and User's Guide</i><br><b>Note:</b> HTML for this document is not installed from the HTML documentation CD. | SH12-6842   | Yes                |
| <i>Performance Guide</i>   | SC10-4222   | Yes                |
| <i>Query Patroller Administration and User's Guide</i>   | GC10-4241   | Yes                |
| <i>Quick Beginnings for DB2 Clients</i>  | GC10-4242   | No                 |
| <i>Quick Beginnings for DB2 Servers</i>  | GC10-4246   | Yes                |
| <i>Spatial Extender and Geodetic Data Management Feature User's Guide and Reference</i>  | SC18-9749   | Yes                |
| <i>SQL Guide</i>   | SC10-4248   | Yes                |
| <i>SQL Reference, Volume 1</i>   | SC10-4249   | Yes                |
| <i>SQL Reference, Volume 2</i>   | SC10-4250   | Yes                |
| <i>System Monitor Guide and Reference</i>  | SC10-4251   | Yes                |
| <i>Troubleshooting Guide</i>   | GC10-4240   | No                 |
| <i>Visual Explain Tutorial</i>   | SC10-4319   | No                 |
| <i>What's New</i>  | SC10-4253   | Yes                |
| <i>XML Extender Administration and Programming</i>   | SC18-9750   | Yes                |
| <i>XML Guide</i>   | SC10-4254   | Yes                |
| <i>XQuery Reference</i>  | SC18-9796   | Yes                |

Table 206. DB2 Connect-specific technical information

| Name   | Form Number | Available in print |
|--|-------------|--------------------|
| <i>DB2 Connect User's Guide</i>                          | SC10-4229   | Yes                |
| <i>Quick Beginnings for DB2 Connect Personal Edition</i> | GC10-4244   | Yes                |

Table 206. DB2 Connect-specific technical information (continued)

| Name                                     | Form Number | Available in print |
|--|-------------|--------------------|
| Quick Beginnings for DB2 Connect Servers | GC10-4243   | Yes                |

Table 207. WebSphere Information Integration technical information

| Name   | Form Number | Available in print |
|--|-------------|--------------------|
| WebSphere Information Integration: Administration Guide for Federated Systems                    | SC19-1001   | Yes                |
| WebSphere Information Integration: ASNCLP Program Reference for Replication and Event Publishing | SC19-1000   | Yes                |
| WebSphere Information Integration: Configuration Guide for Federated Data Sources                | SC19-1034   | No                 |
| WebSphere Information Integration: SQL Replication Guide and Reference                           | SC19-1002   | Yes                |

**Note:** The DB2 Release Notes provide additional information specific to your product's release and fix pack level. For more information, see the related links.

**Related concepts:**

- "Overview of the DB2 technical information" on page 849
- "About the Release Notes" in *Release notes*

**Related tasks:**

- "Ordering printed DB2 books" on page 852

---

## Ordering printed DB2 books

If you require printed DB2 books, you can buy them online in many but not all countries or regions. You can always order printed DB2 books from your local IBM representative. Keep in mind that some softcopy books on the *DB2 PDF Documentation* CD are unavailable in print. For example, neither volume of the *DB2 Message Reference* is available as a printed book.

Printed versions of many of the DB2 books available on the DB2 PDF Documentation CD can be ordered for a fee from IBM. Depending on where you are placing your order from, you may be able to order books online, from the IBM Publications Center. If online ordering is not available in your country or region, you can always order printed DB2 books from your local IBM representative. Note that not all books on the DB2 PDF Documentation CD are available in print.

**Note:** The most up-to-date and complete DB2 documentation is maintained in the DB2 Information Center at <http://publib.boulder.ibm.com/infocenter/db2help/>.

**Procedure:**

To order printed DB2 books:

- To find out whether you can order printed DB2 books online in your country or region, check the IBM Publications Center at <http://www.ibm.com/shop/publications/order>. You must select a country, region, or language to access publication ordering information and then follow the ordering instructions for your location.
- To order printed DB2 books from your local IBM representative:
  - Locate the contact information for your local representative from one of the following Web sites:
    - The IBM directory of world wide contacts at [www.ibm.com/planetwide](http://www.ibm.com/planetwide)
    - The IBM Publications Web site at <http://www.ibm.com/shop/publications/order>. You will need to select your country, region, or language to the access appropriate publications home page for your location. From this page, follow the "About this site" link.
  - When you call, specify that you want to order a DB2 publication.
  - Provide your representative with the titles and form numbers of the books that you want to order.

**Related concepts:**

- "Overview of the DB2 technical information" on page 849

**Related reference:**

- "DB2 technical library in PDF format" on page 850

---

## Displaying SQL state help from the command line processor

DB2 returns an SQLSTATE value for conditions that could be the result of an SQL statement. SQLSTATE help explains the meanings of SQL states and SQL state class codes.

**Procedure:**

To invoke SQL state help, open the command line processor and enter:

```
? sqlstate or ? class code
```

where *sqlstate* represents a valid five-digit SQL state and *class code* represents the first two digits of the SQL state.

For example, ? 08003 displays help for the 08003 SQL state, and ? 08 displays help for the 08 class code.

**Related tasks:**

- "Invoking command help from the command line processor" in *Command Reference*
- "Invoking message help from the command line processor" in *Command Reference*

---

## Accessing different versions of the DB2 Information Center

For DB2 Version 9 topics, the DB2 Information Center URL is <http://publib.boulder.ibm.com/infocenter/db2luw/v9/>.

For DB2 Version 8 topics, go to the Version 8 Information Center URL at:  
<http://publib.boulder.ibm.com/infocenter/db2luw/v8/>.

**Related tasks:**

- “Setting up access to DB2 contextual help and documentation” in *Administration Guide: Implementation*

---

## Displaying topics in your preferred language in the DB2 Information Center

The DB2 Information Center attempts to display topics in the language specified in your browser preferences. If a topic has not been translated into your preferred language, the DB2 Information Center displays the topic in English.

**Procedure:**

To display topics in your preferred language in the Internet Explorer browser:

1. In Internet Explorer, click the **Tools** → **Internet Options** → **Languages...** button. The Language Preferences window opens.
2. Ensure your preferred language is specified as the first entry in the list of languages.
  - To add a new language to the list, click the **Add...** button.

**Note:** Adding a language does not guarantee that the computer has the fonts required to display the topics in the preferred language.

- To move a language to the top of the list, select the language and click the **Move Up** button until the language is first in the list of languages.
3. Clear the browser cache and then refresh the page to display the DB2 Information Center in your preferred language.

To display topics in your preferred language in a Firefox or Mozilla browser:

1. Select the **Tools** → **Options** → **Languages** button. The Languages panel is displayed in the Preferences window.
2. Ensure your preferred language is specified as the first entry in the list of languages.
  - To add a new language to the list, click the **Add...** button to select a language from the Add Languages window.
  - To move a language to the top of the list, select the language and click the **Move Up** button until the language is first in the list of languages.
3. Clear the browser cache and then refresh the page to display the DB2 Information Center in your preferred language.

On some browser and operating system combinations, you might have to also change the regional settings of your operating system to the locale and language of your choice.

**Related concepts:**

- “Overview of the DB2 technical information” on page 849

---

## Updating the DB2 Information Center installed on your computer or intranet server

If you have a locally-installed DB2 Information Center, updated topics can be available for download. The 'Last updated' value found at the bottom of most topics indicates the current level for that topic.

To determine if there is an update available for the entire DB2 Information Center, look for the 'Last updated' value on the Information Center home page. Compare the value in your locally installed home page to the latest value which is available on the IBM hosted Information Center home page. If they are the same, you have the latest documentation level and no update is required. If they are not the same, you should update your locally-installed Information Center.

Updating your locally-installed DB2 Information Center requires that you:

1. Stop the DB2 Information Center on your computer, and restart the Information Center in stand-alone mode. Running the Information Center in stand-alone mode prevents other users on your network from accessing the Information Center, and allows you to download and apply updates.
2. Use the Update feature to determine if update packages are available from IBM. If update packages are available, use the Update feature to download the packages. (The Update feature is only available in stand-alone mode.)
3. Stop the stand-alone Information Center, and restart the DB2 Information Center service on your computer.

### Procedure:

To update the DB2 Information Center installed on your computer or intranet server:

1. Stop the DB2 Information Center service.
  - On Windows, click **Start** → **Control Panel** → **Administrative Tools** → **Services**. Then right-click on **DB2 Information Center** service and select **Stop**.
  - On Linux, enter the following command:  

```
/etc/init.d/db2icdv9 stop
```
2. Start the Information Center in stand-alone mode.
  - On Windows:
    - a. Open a command window.
    - b. Navigate to the path where the Information Center is installed. By default, the DB2 Information Center is installed in the C:\Program Files\IBM\DB2 Information Center\Version 9 directory.
    - c. Run the help\_start.bat file using the fully qualified path for the DB2 Information Center:  

```
<DB2 Information Center dir>\doc\bin\help_start.bat
```
  - On Linux:
    - a. Navigate to the path where the Information Center is installed. By default, the DB2 Information Center is installed in the /opt/ibm/db2ic/V9 directory.
    - b. Run the help\_start.sh file using the fully qualified path for the DB2 Information Center:  

```
<DB2 Information Center dir>/doc/bin/help_start
```

The systems default Web browser launches to display the stand-alone Information Center.

3. Click the Update button (🔄). On the right hand panel of the Information Center, click **Find Updates**. A list of updates for existing documentation displays.
4. To initiate the download process, check the selections you want to download, then click **Install Updates**.
5. After the download and installation process has completed, click **Finish**.
6. Stop the stand-alone Information Center.
  - On Windows, run the help\_end.bat file using the fully qualified path for the DB2 Information Center:  

```
<DB2 Information Center dir>\doc\bin\help_end.bat
```
  - On Linux, run the help\_end.sh file using the fully qualified path for the DB2 Information Center:  

```
<DB2 Information Center dir>/doc/bin/help_end
```
7. Restart the DB2 Information Center service.
  - On Windows, click **Start** → **Control Panel** → **Administrative Tools** → **Services**. Then right-click on **DB2 Information Center** service and select **Start**.
  - On Linux, enter the following command:  

```
/etc/init.d/db2icdv9 start
```

The updated DB2 Information Center displays the new and updated topics.

**Related concepts:**

- “DB2 Information Center installation options” in *Quick Beginnings for DB2 Servers*

**Related tasks:**

- “Installing the DB2 Information Center using the DB2 Setup wizard (Linux)” in *Quick Beginnings for DB2 Servers*
- “Installing the DB2 Information Center using the DB2 Setup wizard (Windows)” in *Quick Beginnings for DB2 Servers*

---

## DB2 Visual Explain tutorial

The DB2 Visual Explain tutorial helps you learn about analyzing, optimizing, and tuning SQL statements for better performance. Lessons provide step-by-step instructions.

**Before you begin:**

You can view the XHTML version of the tutorial from the Information Center at <http://publib.boulder.ibm.com/infocenter/db2help/>.

Some lessons use sample data or code. See the tutorial for a description of any prerequisites for its specific tasks.

**DB2 Visual Explain tutorial:**

To view the tutorial, click on the title.

*Visual Explain Tutorial*

Analyze, optimize, and tune SQL statements for better performance using Visual Explain.

**Related concepts:**

- “Visual Explain overview” in *Administration Guide: Implementation*

---

## DB2 troubleshooting information

A wide variety of troubleshooting and problem determination information is available to assist you in using DB2 products.

**DB2 documentation**

Troubleshooting information can be found in the DB2 Troubleshooting Guide or the Support and Troubleshooting section of the DB2 Information Center. There you will find information on how to isolate and identify problems using DB2 diagnostic tools and utilities, solutions to some of the most common problems, and other advice on how to solve problems you might encounter with your DB2 products.

**DB2 Technical Support Web site**

Refer to the DB2 Technical Support Web site if you are experiencing problems and want help finding possible causes and solutions. The Technical Support site has links to the latest DB2 publications, TechNotes, Authorized Program Analysis Reports (APARs or bug fixes), fix packs, and other resources. You can search through this knowledge base to find possible solutions to your problems.

Access the DB2 Technical Support Web site at <http://www.ibm.com/software/data/db2/udb/support.html>

**Related concepts:**

- “Introduction to problem determination” in *Troubleshooting Guide*
- “Overview of the DB2 technical information” on page 849

---

## Terms and Conditions

Permissions for the use of these publications is granted subject to the following terms and conditions.

**Personal use:** You may reproduce these Publications for your personal, non commercial use provided that all proprietary notices are preserved. You may not distribute, display or make derivative work of these Publications, or any portion thereof, without the express consent of IBM.

**Commercial use:** You may reproduce, distribute and display these Publications solely within your enterprise provided that all proprietary notices are preserved. You may not make derivative works of these Publications, or reproduce, distribute or display these Publications or any portion thereof outside your enterprise, without the express consent of IBM.

Except as expressly granted in this permission, no other permissions, licenses or rights are granted, either express or implied, to the Publications or any information, data, software or other intellectual property contained therein.

IBM reserves the right to withdraw the permissions granted herein whenever, in its discretion, the use of the Publications is detrimental to its interest or, as determined by IBM, the above instructions are not being properly followed.

You may not download, export or re-export this information except in full compliance with all applicable laws and regulations, including all United States export laws and regulations.

IBM MAKES NO GUARANTEE ABOUT THE CONTENT OF THESE PUBLICATIONS. THE PUBLICATIONS ARE PROVIDED "AS-IS" AND WITHOUT WARRANTY OF ANY KIND, EITHER EXPRESSED OR IMPLIED, INCLUDING BUT NOT LIMITED TO IMPLIED WARRANTIES OF MERCHANTABILITY, NON-INFRINGEMENT, AND FITNESS FOR A PARTICULAR PURPOSE.



---

## Appendix Q. Notices

IBM may not offer the products, services, or features discussed in this document in all countries. Consult your local IBM representative for information on the products and services currently available in your area. Any reference to an IBM product, program, or service is not intended to state or imply that only that IBM product, program, or service may be used. Any functionally equivalent product, program, or service that does not infringe any IBM intellectual property right may be used instead. However, it is the user's responsibility to evaluate and verify the operation of any non-IBM product, program, or service.

IBM may have patents or pending patent applications covering subject matter described in this document. The furnishing of this document does not give you any license to these patents. You can send license inquiries, in writing, to:

IBM Director of Licensing  
IBM Corporation  
North Castle Drive  
Armonk, NY 10504-1785  
U.S.A.

For license inquiries regarding double-byte (DBCS) information, contact the IBM Intellectual Property Department in your country/region or send inquiries, in writing, to:

IBM World Trade Asia Corporation  
Licensing  
2-31 Roppongi 3-chome, Minato-ku  
Tokyo 106, Japan

**The following paragraph does not apply to the United Kingdom or any other country/region where such provisions are inconsistent with local law:**

INTERNATIONAL BUSINESS MACHINES CORPORATION PROVIDES THIS PUBLICATION "AS IS" WITHOUT WARRANTY OF ANY KIND, EITHER EXPRESS OR IMPLIED, INCLUDING, BUT NOT LIMITED TO, THE IMPLIED WARRANTIES OF NON-INFRINGEMENT, MERCHANTABILITY, OR FITNESS FOR A PARTICULAR PURPOSE. Some states do not allow disclaimer of express or implied warranties in certain transactions; therefore, this statement may not apply to you.

This information could include technical inaccuracies or typographical errors. Changes are periodically made to the information herein; these changes will be incorporated in new editions of the publication. IBM may make improvements and/or changes in the product(s) and/or the program(s) described in this publication at any time without notice.

Any references in this information to non-IBM Web sites are provided for convenience only and do not in any manner serve as an endorsement of those Web sites. The materials at those Web sites are not part of the materials for this IBM product, and use of those Web sites is at your own risk.

IBM may use or distribute any of the information you supply in any way it believes appropriate without incurring any obligation to you.

Licensees of this program who wish to have information about it for the purpose of enabling: (i) the exchange of information between independently created programs and other programs (including this one) and (ii) the mutual use of the information that has been exchanged, should contact:

IBM Canada Limited  
Office of the Lab Director  
8200 Warden Avenue  
Markham, Ontario  
L6G 1C7  
CANADA

Such information may be available, subject to appropriate terms and conditions, including in some cases payment of a fee.

The licensed program described in this document and all licensed material available for it are provided by IBM under terms of the IBM Customer Agreement, IBM International Program License Agreement, or any equivalent agreement between us.

Any performance data contained herein was determined in a controlled environment. Therefore, the results obtained in other operating environments may vary significantly. Some measurements may have been made on development-level systems, and there is no guarantee that these measurements will be the same on generally available systems. Furthermore, some measurements may have been estimated through extrapolation. Actual results may vary. Users of this document should verify the applicable data for their specific environment.

Information concerning non-IBM products was obtained from the suppliers of those products, their published announcements, or other publicly available sources. IBM has not tested those products and cannot confirm the accuracy of performance, compatibility, or any other claims related to non-IBM products. Questions on the capabilities of non-IBM products should be addressed to the suppliers of those products.

All statements regarding IBM's future direction or intent are subject to change or withdrawal without notice, and represent goals and objectives only.

This information may contain examples of data and reports used in daily business operations. To illustrate them as completely as possible, the examples include the names of individuals, companies, brands, and products. All of these names are fictitious, and any similarity to the names and addresses used by an actual business enterprise is entirely coincidental.

#### COPYRIGHT LICENSE:

This information may contain sample application programs, in source language, which illustrate programming techniques on various operating platforms. You may copy, modify, and distribute these sample programs in any form without payment to IBM for the purposes of developing, using, marketing, or distributing application programs conforming to the application programming interface for the operating platform for which the sample programs are written. These examples have not been thoroughly tested under all conditions. IBM, therefore, cannot guarantee or imply reliability, serviceability, or function of these programs.

Each copy or any portion of these sample programs or any derivative work must include a copyright notice as follows:

© (*your company name*) (*year*). Portions of this code are derived from IBM Corp. Sample Programs. © Copyright IBM Corp. *\_enter the year or years\_*. All rights reserved.

---

## Trademarks

Company, product, or service names identified in the documents of the DB2 Version 9 documentation library may be trademarks or service marks of International Business Machines Corporation or other companies. Information on the trademarks of IBM Corporation in the United States, other countries, or both is located at <http://www.ibm.com/legal/copytrade.shtml>.

The following terms are trademarks or registered trademarks of other companies and have been used in at least one of the documents in the DB2 documentation library:

Microsoft, Windows, Windows NT, and the Windows logo are trademarks of Microsoft Corporation in the United States, other countries, or both.

Intel<sup>®</sup>, Itanium<sup>®</sup>, Pentium<sup>®</sup>, and Xeon<sup>®</sup> are trademarks of Intel Corporation in the United States, other countries, or both.

Java and all Java-based trademarks are trademarks of Sun Microsystems, Inc. in the United States, other countries, or both.

UNIX is a registered trademark of The Open Group in the United States and other countries.

Linux is a trademark of Linus Torvalds in the United States, other countries, or both.

Other company, product, or service names may be trademarks or service marks of others.



---

# Index

## Special characters

- (asterisk)
  - in select column names 506
  - in subselect column names 506

## A

- ABS or ABSVAL function
  - detailed format description 280
  - values and arguments, rules for 280
- access plans
  - description 49
- ACCOUNTING\_STRING user option
  - valid settings 764
- ACOS scalar function
  - description 281
  - values and arguments 281
- administrative SQL routines
  - supported 233
- ADVISE\_INDEX table 812
- ADVISE\_INSTANCE table 815
- ADVISE\_MQT table 816
- ADVISE\_PARTITION table 817
- ADVISE\_TABLE table 818
- ADVISE\_WORKLOAD table 819
- aggregate function
  - COUNT 262
  - description 258
  - MIN 270
- alias name
  - definition 57
- aliases
  - definition 12
  - description 57
  - TABLE\_NAME function 417
  - TABLE\_SCHEMA function 418
- ALL clause
  - quantified predicate 212
  - SELECT statement 506
- ALL option 543
- ambiguous reference errors 57
- AND truth table 208
- ANY clause 212
- application process
  - connection states 27
  - definition 18
- application requesters 27
- arguments of COALESCE 116
- arithmetic
  - AVG function, operation of 259
  - columns, adding values (SUM) 277
  - CORRELATION function operation 261
  - COVARIANCE function operation 265
  - decimal values from numeric expressions 315
  - expressions, adding values (SUM) 277
  - finding maximum value 268
  - floating point values from numeric expressions 325, 386
  - integer values, returning from expressions 287, 348
  - operators 173
  - regression functions 273

- arithmetic (*continued*)
  - returning small integer values from expressions 406
  - STDDEV function 276
  - VARIANCE function operation 278
- AS clause
  - in SELECT clause 506
  - ORDER BY clause 506
- ASC clause
  - SELECT statement 506
- ASCII scalar function
  - description 282
  - values and arguments 282
- ASIN scalar function
  - description 283
  - values and arguments 283
- assignments
  - basic SQL operations 105
- asterisk (\*)
  - in COUNT 262
  - in COUNT\_BIG 263
  - in select column names 506
  - in subselect column names 506
- ATAN scalar function
  - description 284
  - values and arguments 284
- ATAN2 scalar function
  - description 285
  - values and arguments 285
- ATANH scalar function
  - description 286
  - values and arguments 286
- attribute name
  - definition 57
- authority levels
  - See privileges 13
- authorization ID 57
- authorization names
  - definition 57
  - description 57
  - restrictions governing 57
- AVG aggregate function 259

## B

- base table 4
- basic predicate 211
- best fit (function) 157
- best fit (method) 165
- BETWEEN predicate 215
- big integer 80
- BIGINT function 287
- BIGINT SQL data type
  - sign and precision 80
- binary large objects (BLOBs)
  - definition 86
  - scalar function description 289
- binary string data types 86
- binding
  - data retrieval, role in optimizing 1
  - function semantics 157
  - method semantics 157

- bit data 81
- BLAST
  - supported versions 45
- BLOB data type
  - description 86
- buffer pool name 57
- buffer pools
  - definition 23
- built-in functions
  - description 157
  - string units in 81
- business rules
  - transitional 10
- byte length
  - data type values 354

## C

- call level interface (CLI)
  - definition 2
- CALL statement
  - invoked from a compiled statement 835
- CASE
  - expressions 185
- case sensitivity
  - in token identifiers 55
- CAST
  - specifications 187
- casting
  - between data types 99
  - data type 187
  - reference types 99
  - structured type expression to a subtype 202
  - user-defined types 99
  - XML values 190
- catalog views
  - ATTRIBUTES 590
  - BUFFERPOOLDBPARTITIONS 592
  - BUFFERPOOLNODES (see BUFFERPOOLDBPARTITIONS) 592
  - BUFFERPOOLS 593
  - CASTFUNCTIONS 594
  - CHECKS 595
  - COLAUTH 596
  - COLCHECKS 597
  - COLDIST 598
  - COLGROUPCOLS 599
  - COLGROUPDIST 600, 727
  - COLGROUPDISTCOUNTS 601, 728
  - COLGROUPS 602, 729
  - COLIDENTATTRIBUTES 603
  - COLOPTIONS 604
  - COLUMNS 605
  - COLUSE 610
  - CONSTDEP 611
  - DATAPARTITIONEXPRESSION 612
  - DATAPARTITIONS 613
  - DATATYPES 615
  - DBAUTH 617
  - DBPARTITIONGROUPDEF 618
  - DBPARTITIONGROUPS 619
  - description 18
  - EVENTMONITORS 620
  - EVENTS 622
  - EVENTTABLES 623
  - FULLHIERARCHIES 624
  - FUNCDEP (see ROUTINEDEP) 661

- catalog views (*continued*)
  - FUNCMAPOPTIONS 625
  - FUNCMAPPARMOPTIONS 626
  - FUNCMAPPINGS 627
  - FUNCPARMS (see ROUTINEPARMS) 664
  - FUNCTIONS (see ROUTINES) 666
  - HIERARCHIES 628
  - INDEXAUTH 629
  - INDEXCOLUSE 630
  - INDEXDEP 631
  - INDEXES 632
  - INDEXEXPLOITRULES 637
  - INDEXEXTENSIONDEP 638
  - INDEXEXTENSIONMETHODS 639
  - INDEXEXTENSIONPARMS 640
  - INDEXEXTENSIONS 641
  - INDEXOPTIONS 642
  - INDEXXMLPATTERNS 643
  - KEYCOLUSE 644
  - NAMEMAPPINGS 645
  - NODEGROUPDEF (see DBPARTITIONGROUPDEF) 618
  - NODEGROUPS (see DBPARTITIONGROUPS) 619
  - overview 583
  - PACKAGEAUTH 649
  - PACKAGEDEP 650
  - PACKAGES 651
  - PARTITIONMAPS 656
  - PASSTHROUGHAUTH 657
  - PREDICATESPECS 658
  - PROCEDURES (see ROUTINES) 666
  - PROCOPTIONS (see ROUTINEOPTIONS) 662
  - PROCPARMOPTIONS (see ROUTINEPARMOPTIONS) 663
  - PROCPARMS (see ROUTINEPARMS) 664
  - read-only 583
  - REFERENCES 659
  - ROUTINEAUTH 660
  - ROUTINEDEP (formerly FUNCDEP) 661
  - ROUTINEOPTIONS (formerly PROCOPTIONS) 662
  - ROUTINEPARMOPTIONS (formerly PROCPARMOPTIONS) 663
  - ROUTINEPARMS (formerly FUNCPARMS, PROCPARMS) 664
  - ROUTINES (formerly FUNCTIONS, PROCEDURES) 666
  - ROUTINESFEDERATED 674
  - SCHEMAAUTH 676
  - SCHEMATA 677
  - SECURITYLABELACCESS 678
  - SECURITYLABELCOMPONENTELEMENTS 679
  - SECURITYLABELCOMPONENTS 680
  - SECURITYLABELS 681
  - SECURITYPOLICIES 682
  - SECURITYPOLICYCOMPONENTRULES 683
  - SECURITYPOLICYEXEMPTIONS 684
  - SEQUENCEAUTH 686
  - SEQUENCES 687
  - SERVEROPTIONS 689
  - SERVERS 690
  - STATEMENTS 691
  - SURROGATEAUTHIDS 685
  - SYSCAT.DATAPARTITIONEXPRESSION 612
  - SYSCAT.DATAPARTITIONS 613
  - SYSDDUMMY1 589
  - SYSSTAT.COLDIST 726
  - SYSSTAT.COLUMNS 730
  - SYSSTAT.FUNCTIONS (see SYSSTAT.ROUTINES) 734

- catalog views (*continued*)
  - SYSSTAT.ROUTINES (formerly SYSSTAT.FUNCTIONS) 734
  - SYSSTAT.TABLES 735
  - SYSSTAT.INDEXES 731
  - TABAUTH 692
  - TABCONST 694
  - TABDEP 695
  - TABDETACHEDDEP 697
  - TABLES 698
  - TABLESPACES 704
  - TABOPTIONS 706
  - TBSPACEAUTH 707
  - TRANSFORMS 708
  - TRIGDEP 709
  - TRIGGERS 710
  - TYPEMAPPINGS 712
  - updatable 583
  - USEROPTIONS 715
  - VIEWS 716
  - WRAPOPTIONS 717
  - WRAPPERS 718
  - XDBMAPGRAPHS 719
  - XDBMAPSHREDTREES 720
  - XSROBJECTAUTH 721
  - XSROBJECTCOMPONENTS 722
  - XSROBJECTDEP 723
  - XSROBJECTHIERARCHIES 724
  - XSROBJECTS 725
- CEIL function
  - description 290
  - values and arguments 290
- CEILING function
  - description 290
  - values and arguments 290
- CHAR data type
  - description 81
- CHAR scalar function
  - description 291
- character conversion
  - rules for assignments 105
  - rules for comparison 105
  - rules for operations combining strings 120
  - rules when comparing strings 120
- character sets
  - definition 25
  - description 50
- character string constant 124
- character strings
  - assignment 105
  - BLOB string representation 289
  - comparisons 105
  - data types 81
  - double-byte character string 445
  - equality
    - collating sequence examples 105
    - definition 105
  - POSSTR scalar function 379
  - returning from host variable name 431
  - translating string syntax 431
  - VARCHAR scalar function 441
  - VARGRAPHIC scalar function 445
- character subtypes 81
- CHARACTER\_LENGTH scalar function
  - description 295
- characters
  - conversion 25
- characters (*continued*)
  - SQL language elements 53
- CHR scalar function
  - description 297
  - values and arguments 297
- CLI (call level interface)
  - definition 2
- CLIENT ACCTNG special register 129
- CLIENT APPLNAME special register 130
- CLIENT USERID special register 131
- CLIENT WRKSTNNAME special register 132
- CLOB (character large object)
  - data type
    - description 81
  - function
    - description 298
    - values and arguments 298
- COALESCE function 299
- code pages
  - attributes 25
  - definition 25
  - description 50
- code point 25
- collating sequences
  - description 50
  - planning 50
  - string comparison rules 105
- COLLATING\_SEQUENCE server option
  - example 50
  - valid settings 748
- collocation
  - table 36
- column database functions
  - description 157
- column options
  - description 44
  - valid settings 740
- columns
  - adding values (SUM) 277
  - ambiguous name reference errors 57
  - averaging a set of values (AVG) 259
  - BASIC predicate, use in matching strings 211
  - BETWEEN predicate, in matching strings 215
  - column name
    - definition 57
    - qualification in COMMENT ON statement 57
    - uses 57
  - correlation between a set of number pairs (CORRELATION) 261
  - covariance of a set of number pairs (COVARIANCE) 265
  - definition
    - tables 4
  - EXISTS predicate, in matching strings 216
  - finding maximum value 268
  - GROUP BY, use in limiting in SELECT clause 506
  - grouping column names in GROUP BY 506
  - HAVING clause, search names, rules 506
  - HAVING, use in limiting in SELECT clause 506
  - IN predicate, fullselect, values returned 217
  - LIKE predicate, in matching strings 219
  - names
    - in ORDER BY clause 506
    - qualified conditions 57
    - unqualified conditions 57
  - naming conventions 57
  - nested table expression 57

- columns (*continued*)
  - null values
    - in result columns 506
  - qualified column name rules 57
  - result data 506
  - scalar fullselect 57
  - searching using WHERE clause 506
  - SELECT clause syntax diagram 506
  - standard deviation of a set of values (STDDEV) 276
  - string assignment rules 105
  - subquery 57
  - undefined name reference errors 57
  - variance of a column set of values (VARIANCE) 278
- combining grouping sets 506
- COMM\_RATE server option
  - valid settings 748
- comments
  - host language, format 55
  - SQL, format 55
- commit
  - release of locks 18
- common table expressions
  - definition 548
  - recursive 548
  - select statement 548
- comparing
  - a value with a collection 215
  - LONG VARCHAR strings, restricted use 105
  - two predicates, truth conditions 211, 225
- comparison
  - SQL operation 105
- compatibility
  - data types 105
  - rules 105
  - rules for operation types 105
- component-name
  - description 57
- composite column values 506
- composite keys
  - definition 5
- CONCAT scalar function
  - description 300
  - values and arguments 300
- concatenation
  - distinct type 173
  - operators 173
- condition name
  - SQL procedures 57
- connection states
  - described 27
  - description 27
  - remote unit of work 27
- CONNECTSTRING server option
  - valid settings 748
- consistency
  - points of 18
- constants
  - character string 124
  - decimal 124
  - floating-point 124
  - graphic string 124
  - hexadecimal 124
  - integer 124
  - SQL language element 124
  - with user-defined types 124
- constraints
  - Explain tables 789
- constraints (*continued*)
  - informational 5
  - names, definition 57
  - referential 5
  - table check 5
  - unique 5
- contacting IBM 865
- containers
  - definition 23
- conversions
  - CHAR, returning converted datetime values 291
  - character string to timestamp 423
  - datetime to string variable 105
  - DBCS from mixed SBCS and DBCS 445
  - decimal values from numeric expressions 315
  - double-byte character string 445
  - floating point values from numeric expressions 325, 386
  - numeric, scale and precision, summary 105
  - rules
    - assignments 105
    - comparisons 105
    - operations combining strings 120
    - string comparisons 120
- correlated reference
  - in nested table expression 57
  - in scalar fullselect 57
  - in subquery 57
  - in subselect 506
- CORRELATION function 261
- correlation name
  - definition 57
  - FROM clause, subselect rules 506
  - in SELECT clause, syntax diagram 506
  - qualified reference 57
  - rules 57
- COS scalar function
  - description 301
  - values and arguments 301
- COSH scalar function
  - description 302
  - values and arguments 302
- COT scalar function
  - description 303
  - values and arguments 303
- COUNT function 262
- COUNT\_BIG function
  - detailed format description 263
  - values and arguments 263
- COVARIANCE function 265
- CPU\_RATIO server option
  - valid settings 748
- CREATE SERVER statement 45
- cross-tabulation rows 506
- CS (cursor stability)
  - isolation level 20
- CUBE grouping
  - examples 506
  - query description 506
- CURRENT CLIENT\_ACCTNG special register 129
- CURRENT CLIENT\_APPLNAME special register 130
- CURRENT CLIENT\_USERID special register 131
- CURRENT CLIENT\_WRKSTNNAME special register 132
- current connection state 27
- CURRENT DATE special register 133
- CURRENT DBPARTITIONNUM special register 134
- CURRENT DEFAULT TRANSFORM GROUP special register 135



- CURRENT DEGREE special register
  - description 136
- CURRENT EXPLAIN MODE special register
  - description 137
- CURRENT EXPLAIN SNAPSHOT special register
  - description 138
- CURRENT FEDERATED ASYNCHRONY special register 139
- CURRENT FUNCTION PATH special register
  - description 145
- CURRENT IMPLICIT XMLPARSE OPTION special register 140
- CURRENT ISOLATION special register 141
- CURRENT LOCK TIMEOUT special register 142
- CURRENT MAINTAINED TABLE TYPES FOR OPTIMIZATION special register 143
- CURRENT PACKAGE PATH special register 144
- CURRENT PATH special register
  - description 145
- CURRENT QUERY OPTIMIZATION special register
  - description 146
- CURRENT REFRESH AGE special register
  - description 147
- CURRENT SCHEMA special register 148
- CURRENT SERVER special register 149
- CURRENT SQLID special register 148
- CURRENT TIME special register 150
- CURRENT TIMESTAMP special register 151
- CURRENT TIMEZONE special register 152
- CURRENT USER special register 153
- cursor name
  - definition 57
- cursor stability (CS)
  - isolation level 20

## D

- data
  - partitioning 36
- data definition language (DDL)
  - definition 1
- data source name 57
- data source objects
  - description 43
- data sources 40, 41
  - description 40
  - valid server types 737
- data structures
  - packed decimal 573
- data type mappings
  - description 44
  - forward 767
  - reverse 775
- data types
  - BIGINT 80
  - binary string 86
  - BLOB 86
  - casting between 99
  - CHAR 81
  - character string 81
  - CLOB 81
  - DATALINK 91
  - DATE 88
  - datetime 88
  - DBCLOB 85
  - DECIMAL or NUMERIC 80
  - DOUBLE or FLOAT 80
  - GRAPHIC 85

- data types (*continued*)
  - graphic string 85
  - INTEGER 80
  - LONG VARCHAR 81
  - LONG VARGRAPHIC 85
  - numeric 80
  - partition compatibility 122
  - promotion 97
  - promotion in a Unicode database 97
  - REAL 80
  - result columns 506
  - SMALLINT 80
  - SQL language element 78
  - TIME 88
  - TIMESTAMP 88
  - TYPE\_ID function 436
  - TYPE\_NAME function 437
  - TYPE\_SCHEMA function 438
  - unsupported 44
  - user-defined 94
  - VARCHAR 81
  - VARGRAPHIC 85
  - XML 93
- database manager
  - limits 559
  - SQL interpretation 1
- database partition groups (nodegroups)
  - definition 23
- DATALINK data type
  - BNF specifications 847
  - description 91
  - unsupported 44
- DATAPARTITIONNUM scalar function
  - description 304
  - values and arguments 304
- DATE data type
  - CHAR, use in format conversion 291
  - day durations, finding from range 311
  - description 88
  - WEEK scalar function 447
  - WEEK\_ISO scalar function 448
- DATE function
  - description 305
  - value to date format conversion 305
- DATEFORMAT server option
  - valid settings 748
- dates
  - month, returning from datetime value 370
  - string representation formats 88
  - using year in expressions 486
- datetime
  - arithmetic 180
  - operations 180
- datetime data types
  - description 88
  - string representation of 88
  - VARCHAR scalar function 441
- DAY function 306
- DAYNAME scalar function
  - description 307
- DAYOFWEEK scalar function
  - description 308
- DAYOFWEEK\_ISO scalar function
  - description 309
- DAYOFYEAR scalar function
  - description 310
  - values and arguments 310

- DAYS scalar function 311
- DB2 for iSeries
  - default forward type mappings 767
  - default reverse type mappings 775
  - supported versions 45
  - valid server types 737
- DB2 for Linux, UNIX and Windows
  - default forward type mappings 767
  - default reverse type mappings 775
  - supported versions 45
  - valid server types 737
- DB2 for VM and VSE
  - default forward type mappings 767
  - default reverse type mappings 775
  - supported versions 45
  - valid server types 737
- DB2 for z/OS
  - supported versions 45
- DB2 for z/OS and OS/390
  - default forward type mappings 767
  - default reverse type mappings 775
  - valid server types 737
- DB2 Information Center
  - updating 855
  - versions 853
  - viewing in different languages 854
- DB2\_FENCED wrapper option
  - valid settings 765
- DB2\_MAXIMAL\_PUSHDOWN server option
  - valid settings 748
- DB2\_SOURCE\_CLIENT\_MODE wrapper option
  - valid settings 765
- DB2\_UM\_PLUGIN server option
  - valid settings 748
- DB2\_UM\_PLUGIN wrapper option
  - valid settings 765
- db2nodes.cfg file
  - DBPARTITIONNUM function 313
- DBCLOB data type
  - description 85
- DBCLOB function
  - description 312
  - values and arguments 312
- DBNAME server option
  - valid settings 748
- DBPARTITIONNUM function
  - description 313
  - values and arguments 313
- DDL (data definition language)
  - definition 1
- decimal constant
  - description 124
- decimal conversion
  - integers 105
- DECIMAL data type
  - conversion from floating-point 105
  - sign and precision 80
- DECIMAL function
  - description 315
  - values and arguments 315
- declarations
  - XMLNAMESPACES 466
- declared temporary tables
  - definition 4
- declustering
  - partial 36
- DECRYPT function
  - description 319
  - values and arguments 319
- decrypting information
  - DECRYPT function 319
- DEGREES scalar function
  - description 321
  - values and arguments 321
- delete rule
  - with referential constraint 5
- delimiter token
  - definition 55
- dependent row 5
- dependent table 5
- DEREF function
  - description 322
  - reference types 322
  - values and arguments 322
- dereference
  - operations 192
- DESC clause
  - of select statement 506
- descendent row 5
- descendent table 5
- descriptor-name
  - definition 57
- diagnostic string
  - in RAISE\_ERROR function 384
- DIFFERENCE scalar function
  - description 323
  - values and arguments 323
- DIGITS function
  - description 324
  - values and arguments 324
- DISABLE function mapping option
  - valid settings 747
- DISTINCT keyword
  - aggregate function 258
  - AVG function 259
  - COUNT\_BIG function 263
  - MAX function restriction 268
  - STDDEV function 276
  - subselect statement 506
  - SUM function 277
  - VARIANCE function 278
- distinct types
  - as arithmetic operands 173
  - comparison 105
  - concatenation 173
  - constants 124
  - description 94
  - names 57
- distributed database management system 39
- Distributed Relational Database Architecture (DRDA) 27
- distributed relational databases
  - application requester 27
  - application server 27
  - application-directed distributed unit of work 27
  - definition 27
  - remote unit of work 27
  - requester-server protocols 27
- distributed unit of work
  - description 27
- distributing data
  - compatibility table 122
- documentation 849, 850
  - terms and conditions of use 857

- dormant connection state 27
- DOUBLE data type
  - CHAR, use in format conversion 291
  - sign and precision 80
- DOUBLE function
  - description 325
  - values and arguments 325
- double-byte character sets (DBCS)
  - characters truncated during assignment 105
  - returning strings 445
- double-precision floating-point data type 80
- durations
  - labeled 180
- dynamic dispatch 165
- dynamic SQL
  - definition 1
  - EXECUTE statement 1
  - PREPARE statement 1
  - SQLDA used with 573

## E

- EMAIL wrapper option
  - valid settings 765
- embedded SQL for Java (SQLJ)
  - Java database connectivity 2
- empty string 81, 85
- encoding scheme 25
- ENCRYPT scalar function 327
- encrypting information
  - ENCRYPT function 327
  - GETHINT function 333
- Entrez
  - supported versions 45
- error messages
  - SQLCA definitions 567
- ESCAPE clauses
  - LIKE predicate 219
- EUC (extended UNIX code)
  - considerations 841
- evaluation order
  - expressions 173
- event monitors
  - definition 35
  - EVENT\_MON\_STATE function 329
  - name 57
- Excel files
  - supported versions 45
- EXCEPT operator of fullselect 543
- exception tables
  - structure 827
- exclusive lock 20
- EXECUTE IMMEDIATE statement
  - dynamic SQL 1
- EXECUTE privilege
  - functions 157
  - methods 165
- EXECUTE statement
  - dynamic SQL 1
- EXISTS predicate 216
- EXP function
  - description 330
  - values and arguments 330
- explain tables
  - overview 789
- EXPLAIN\_ARGUMENT table 790
- EXPLAIN\_DIAGNOSTIC table 795

- EXPLAIN\_DIAGNOSTIC\_DATA table 796
- EXPLAIN\_INSTANCE table 797
- EXPLAIN\_OBJECT table 800
- EXPLAIN\_OPERATOR table 803
- EXPLAIN\_PREDICATE table 805
- EXPLAIN\_STATEMENT table 808
- EXPLAIN\_STREAM table 810
- exposed correlation-name in FROM clause 57
- expression
  - structured type
    - casting to a subtype 202
- expressions
  - arithmetic operators 173
  - CASE 185
  - concatenation operators 173
  - decimal operands 173
  - floating-point operands 173
  - grouping-expressions in GROUP BY 506
  - in a subselect 506
  - in ORDER BY clause 506
  - in SELECT clause, syntax diagram 506
  - integer operands 173
  - mathematical operators 173
  - precedence of operation 173
  - scalar fullselect 173
  - without operators 173
- external functions
  - description 157

## F

- federated database
  - wrapper modules 41
  - wrappers 41
- federated databases
  - definition 1
  - description 40
  - system catalog 48
- federated server 40
  - description 45
- federated systems
  - overview 39
- file reference variables
  - BLOB 57
  - CLOB 57
  - DBCLOB 57
- fixed-length character string 81
- fixed-length graphic string 85
- flat files
  - See also table-structured files 45
- FLOAT data type
  - sign and precision 80
- FLOAT function
  - description 331
  - values and arguments 331
- floating-point constant 124
- floating-point to decimal conversion 105
- FLOOR function
  - description 332
  - values and arguments 332
- FOLD\_ID server option
  - valid settings 748
- FOLD\_PW server option
  - valid settings 748
- FOR FETCH ONLY clause
  - SELECT statement 548

- FOR READ ONLY clause
  - SELECT statement 548
- foreign keys
  - constraints 5
  - definition 5
- forward type mappings
  - default mappings 767
- FROM clause
  - correlation-name example 57
  - exposed names explained 57
  - non-exposed names explained 57
  - subselect syntax 506
  - use of correlation names 57
- fullselect
  - detailed syntax 543
  - examples 543
  - initialization 548
  - iterative 548
  - multiple operations, order of execution 543
  - ORDER BY clause 506
  - scalar 173
  - subquery role, search condition 57
  - table reference 506
- function mapping name 57
- function mappings
  - options
    - valid settings 747
- function name 57
- function signature 157
- functions
  - aggregate
    - COUNT 262
    - description 258
    - MIN 270
    - XMLAGG 271
  - arguments 231
  - built-in 157
  - casting
    - CAST 187
    - XMLCAST 190
  - column
    - aggregate 258
    - AVG 259
    - CORR 261
    - CORRELATION 261
    - COUNT 262
    - COUNT\_BIG 263
    - COVAR 265
    - COVARIANCE 265
    - description 157
    - MAX 268
    - MIN 270
    - REGR\_AVGX 273
    - REGR\_AVGY 273
    - REGR\_COUNT 273
    - REGR\_ICPT 273
    - REGR\_INTERCEPT 273
    - REGR\_R2 273
    - REGR\_SLOPE 273
    - REGR\_SXX 273
    - REGR\_SXY 273
    - REGR\_SYY 273
    - regression functions 273
    - STDDEV 276
    - SUM 277
    - VAR, options 278
    - VAR, results 278

- functions (*continued*)
  - column (*continued*)
    - VARIANCE, options 278
    - VARIANCE, results 278
    - XMLAGG 271
  - description 231
  - external 157
  - in a Unicode database 279
  - in expressions 231
  - OLAP (Online Analytical Processing) 194
  - overloaded 157
  - procedures 495
  - row 157
  - scalar
    - ABS 280
    - ABSVAL 280
    - ACOS 281
    - ASCII 282
    - ASIN 283
    - ATAN 284
    - ATAN2 285
    - ATANH 286
    - AVG 259
    - BIGINT 287
    - BLOB 289
    - CEIL 290
    - CEILING 290
    - CHAR 291
    - CHARACTER\_LENGTH 295
    - CHR 297
    - CLOB 298
    - COALESCE 299
    - CONCAT 300
    - COS 301
    - COSH 302
    - COT 303
    - DATAPARTITIONNUM 304
    - DATE 305
    - DAY 306
    - DAYNAME 307
    - DAYOFWEEK 308
    - DAYOFWEEK\_ISO 309
    - DAYOFYEAR 310
    - DAYS 311
    - DBCLOB 312
    - DBPARTITIONNUM 313
    - DECIMAL 315
    - DECRYPTBIN 319
    - DECRYPTCHAR 319
    - DEGREES 321
    - DEREF 322
    - description 157, 279
    - DIFFERENCE 323
    - DIGITS 324
    - DOUBLE 325
    - DOUBLE\_PRECISION 325
    - ENCRYPT 327
    - EVENT\_MON\_STATE 329
    - EXP 330
    - FLOAT 331
    - FLOOR 332
    - GENERATE\_UNIQUE 334
    - GETHINT 333
    - GRAPHIC 336
    - GROUPING 266
    - HASHEDVALUE 338
    - HEX 340

functions (continued)

scalar (continued)

HOUR 342  
 IDENTITY\_VAL\_LOCAL 343  
 INSERT 347  
 INTEGER 348  
 JULIAN\_DAY 350  
 LCASE 352  
 LCASE or LOWER 351  
 LEFT 353  
 LENGTH 354  
 LN 356  
 LOCATE 357  
 LOG 360  
 LOG10 361  
 LONG\_VARCHAR 362  
 LONG\_VARGRAPHIC 363  
 LTRIM 364, 365  
 MICROSECOND 366  
 MIDNIGHT\_SECONDS 367  
 MINUTE 368  
 MOD 369  
 MONTH 370  
 MONTHNAME 371  
 MULTIPLY\_ALT 372  
 NODENUMBER (see DBPARTITIONNUM) 313  
 NULLIF 374  
 OCTET\_LENGTH 375  
 PARTITION (see HASHEDVALUE) 338  
 POSITION 376  
 POSSTR 379  
 POWER 381, 383  
 QUARTER 382  
 RAISE\_ERROR 384  
 RAND 385  
 REAL 386  
 REC2XML 387  
 REPEAT 391  
 REPLACE 392  
 RIGHT 393  
 ROUND 394  
 RTRIM 396, 397  
 SECLABEL 398  
 SECLABEL\_BY\_NAME 399  
 SECLABEL\_TO\_CHAR 400  
 SECOND 402  
 SIGN 403  
 SIN 404  
 SINH 405  
 SMALLINT 406  
 SOUNDEX 407  
 SPACE 408  
 SQRT 409  
 STRIP 410  
 SUBSTR 411  
 SUBSTRING 414  
 TABLE\_NAME 417  
 TABLE\_SCHEMA 418  
 TAN 420  
 TANH 421  
 TIME 422  
 TIMESTAMP 423  
 TIMESTAMP\_FORMAT 424  
 TIMESTAMP\_ISO 426  
 TIMESTAMPDIFF 427  
 TO\_CHAR 429  
 TO\_DATE 430

functions (continued)

scalar (continued)

TRANSLATE 431  
 TRIM 433  
 TRUNC 435  
 TRUNCATE 435  
 TYPE\_ID 436  
 TYPE\_NAME 437  
 TYPE\_SCHEMA 438  
 UCASE 439  
 UPPER 439  
 VALUE 440  
 VARCHAR 441  
 VARCHAR\_FORMAT 443  
 VARGRAPHIC 445  
 WEEK 447  
 WEEK\_ISO 448  
 XMLATTRIBUTES 449  
 XMLCOMMENT 451  
 XMLCONCAT 452  
 XMLDOCUMENT 454  
 XMLELEMENT 456  
 XMLFOREST 462  
 XMLNAMESPACES 466  
 XMLPARSE 469  
 XMLPI 471  
 XMLQUERY 473  
 XMLSERIALIZE 476  
 XMLTEXT 479  
 XMLVALIDATE 481  
 XMLXSROBJECTID 485  
 YEAR 486  
 sourced 157  
 SQL 157  
 SQL language element 157  
 supported 233  
 table  
   XMLTABLE 488  
 table functions  
   description 157, 487  
 user-defined 157, 492

## G

GENERATE\_UNIQUE function  
   syntax 334  
 GETHINT function  
   description 333  
   values and arguments 333  
 global catalog  
   description 48  
 grand total row 506  
 GRAPHIC data type  
   description 85  
 GRAPHIC function  
   description 336  
   values and arguments 336  
 graphic string constant  
   description 124  
 graphic string data type  
   description 85  
 graphic strings  
   returning from host variable name 431  
   translating string syntax 431  
 GROUP BY clause  
   subselect results 506  
   subselect rules and syntax 506

- group name
  - definition 57
- GROUPING function 266
- grouping sets 506
- grouping-expression 506

## H

- hash partitioning 36
- HASHEDVALUE function
  - description 338
  - values and arguments 338
- HAVING clause
  - search conditions with subselect 506
  - subselect results 506
- held connection state 27
- help
  - displaying 854
  - for SQL statements 853
- HEX function
  - description 340
  - values and arguments 340
- hexadecimal constant 124
- HMMER data source
  - supported versions 45
- host identifiers in host variable 57
- host variables
  - BLOB 57
  - CLOB 57
  - DBCLOB 57
  - definition 57
  - indicator variables 57
  - syntax diagram 57
- HOUR function
  - description 342
  - values and arguments 342

## I

- identifiers
  - delimited 57
  - host 57
  - length limits 559
  - ordinary 57
  - SQL 57
- IDENTITY\_VAL\_LOCAL function
  - description 343
  - values and arguments 343
- IFILE server option
  - valid settings 748
- IGNORE\_UDT server option
  - valid settings 748
- IMPLICITSCHEMA authority 3
- IN predicate 217
- index name
  - definition 57
- indexes
  - description 10
- indicator variables
  - description 57
  - host variable, uses in declaring 57
- Information Center
  - updating 855
  - versions 853
  - viewing in different languages 854
- informational constraints
  - description 5
- Informix
  - default forward type mappings 767
  - default reverse type mappings 775
  - supported versions 45
  - valid server types 737
- INFORMIX\_CLIENT\_LOCALE server option
  - valid settings 748
- INFORMIX\_DB\_LOCALE server option
  - valid settings 748
- INFORMIX\_LOCK\_MODE server option
  - valid settings 748
- INITIAL\_INSTS function mapping option
  - valid settings 747
- INITIAL\_IOS function mapping option
  - valid settings 747
- initialization fullselect 548
- INSERT function
  - description 347
  - values and arguments 347
- insert rule with referential constraint 5
- INSTS\_PER\_ARGBYTE function mapping option
  - valid settings 747
- INSTS\_PER\_INVOC function mapping option
  - valid settings 747
- integer constant
  - description 124
- INTEGER data type
  - sign and precision 80
- INTEGER function
  - description 348
  - values and arguments 348
- integer values from expressions
  - INTEGER function 348
- integers
  - decimal conversion summary 105
  - in ORDER BY clause 506
- interactive SQL 1
- intermediate result tables 506
- INTERSECT operator
  - duplicate rows, use of ALL 543
  - of fullselect, role in comparison 543
- INTO clause
  - FETCH statement, use in host variable 57
  - SELECT INTO statement, use in host variable 57
  - values from applications programs 57
- invocation
  - function 157
- invoking
  - methods 200
- IO\_RATIO server option
  - valid settings 748
- IOS\_PER\_ARGBYTE function mapping option
  - valid settings 747
- IOS\_PER\_INVOC function mapping option
  - valid settings 747
- isolation levels
  - cursor stability 20
  - description 20
  - in DELETE statement 548
  - read stability (RS) 20
  - repeatable read (RR) 20
  - uncommitted read (UR) 20
- iterative fullselect 548
- IUD\_APP\_SVPT\_ENFORCE server option
  - valid settings 748

## J

- Java database connectivity (JDBC)
  - embedded SQL for Java 2
- JDBC (Java database connectivity)
  - embedded SQL for Java 2
  - overview 2
- joined tables
  - subselect clause 506
  - table reference 506
- joins
  - examples 506
  - subselect examples 506
  - types
    - full outer 506
    - inner 506
    - left outer 506
    - right outer 506
- JULIAN\_DAY function
  - description 350
  - values and arguments 350

## K

- KEGG data source
  - supported versions 45
- keys
  - composite 5
  - definition 5
  - foreign 5
  - parent 5
  - partitioning 5
  - primary 5
  - unique 5

## L

- label-based access control (LBAC)
  - effect on exception tables 827
  - limits 559
- labeled durations 180
- labels
  - object names in SQL procedures 57
- large integers 80
- large object (LOB) data types
  - description 87
- large object locator 87
- large objects (LOBs)
  - behavior 37
  - with partitioned tables 37
- LBAC (label-based access control)
  - effect on exception tables 827
  - limits 559
- LBAC security labels
  - component name length 559
  - name length 559
- LBAC security policies
  - name length 559
- LCASE or LOWER scalar function
  - detailed format description 351
  - values and arguments, rules for 351
- LCASE scalar function
  - description 352
  - values and arguments 352
- LEFT scalar function
  - description 353
  - values and arguments 353

- length
  - LENGTH scalar function 354
- LENGTH scalar function
  - description 354
  - values and arguments 354
- LIKE predicate 219
- limits
  - identifier length 559
  - SQL 559
- literals
  - description 124
- LN function
  - description 356
  - values and arguments 356
- LOB (large object) data types
  - description 87
- LOB locators 87
- local catalog
  - See global catalog 48
- LOCATE scalar function
  - description 357
  - values and arguments 357
- locators
  - large object (LOB) 87
  - variable description 57
- locking
  - definition 18
- locks
  - exclusive (X) 20
  - share (S) 20
  - update (U) 20
- LOG function
  - description 360
  - values and arguments 360
- LOG10 scalar function
  - description 361
  - values and arguments 361
- logical operators, search rules 208
- LOGIN\_TIMEOUT server option
  - valid settings 748
- LONG VARCHAR data type
  - description 81
- LONG VARGRAPHIC data type
  - description 85
- LONG\_VARCHAR function
  - description 362
  - values and arguments 362
- LONG\_VARGRAPHIC function
  - description 363
  - values and arguments 363
- LTRIM scalar function
  - description 364, 365
  - values and arguments 364, 365

## M

- map, partitioning 23
- MAX function
  - detailed format description 268
  - values and arguments 268
- method name 57
- method signature 165
- methods
  - built-in 165
  - dynamic dispatch of 165
  - external 165
  - invoking 200

- methods (*continued*)
  - overloaded 165
  - SQL 165
  - SQL language element 165
  - type preserving 165
  - user-defined 165
- MICROSECOND function
  - description 366
  - values and arguments 366
- Microsoft Excel
  - See Excel files 45
- Microsoft SQL Server
  - default forward type mappings 767
  - default reverse type mappings 775
  - supported versions 45
  - valid server types 737
- MIDNIGHT\_SECONDS function
  - description 367
  - values and arguments 367
- MIN function 270
- MINUTE scalar function
  - description 368
  - values and arguments 368
- mixed data
  - definition 81
  - LIKE predicate 219
- MOD function
  - description 369
  - values and arguments 369
- MODULE wrapper option
  - valid settings 765
- monitoring
  - database events 35
- MONTH function
  - description 370
  - values and arguments 370
- MONTHNAME function
  - description 371
  - values and arguments 371
- multiple row VALUES clause
  - result data type 116
- MULTIPLY\_ALT function
  - detailed format description 372
  - values and arguments, rules for 372

## N

- names
  - identifying columns in subselect 506
- naming conventions
  - identifiers 57
  - qualified column rules 57
- nested table expressions 506
- nickname column options
  - description 44
- nicknames
  - definition 57
  - description 43
  - FROM clause 506
    - exposed names in 57
    - nonexposed names in 57
  - qualifying a column name 57
  - SELECT clause, syntax diagram 506
- NODE server option, valid settings 748
- nodegroups (database partition groups)
  - definition 23
- NODENUMBER function (see DBPARTITIONNUM) 313

- nonexposed correlation-name in FROM clause 57
- nonrelational data sources
  - specifying data type mappings 44
- NOT NULL clause
  - in NULL predicate 224
- notices 859
- NUL-terminated character strings 81
- NULL predicate rules 224
- null value
  - definition 78
- null value, SQL
  - assignment 105
  - grouping-expressions, allowable uses 506
  - occurrences in duplicate rows 506
  - result columns 506
  - specified by indicator variable 57
  - unknown condition 208
- NULLIF function
  - description 374
  - values and arguments 374
- numbers
  - precision 573
  - scale 573
- numeric
  - assignments in SQL operations 105
  - comparisons 105
- numeric data types
  - description 80
- NUMERIC or DECIMAL data type
  - sign and precision 80
- NUMERIC\_STRING column option
  - valid settings 740

## O

- object table 57
- OCTET\_LENGTH scalar function
  - description 375
- ODBC
  - default forward type mappings 767
  - supported versions 45
  - valid server types 737
- ODBC (open database connectivity)
  - description 2
- OLAP (Online Analytical Processing)
  - functions 194
- OLE DB
  - supported versions 45
  - valid server types 737
- online analytical processing (OLAP)
  - functions 194
- open database connectivity (ODBC) 2
- operands
  - decimal 173
  - floating-point 173
  - integer 173
  - result data type 116
  - strings 173
- operations
  - assignments 105
  - comparisons 105
  - datetime 180
  - dereference 192
- operators
  - arithmetic 173
- optimizer
  - description 49



- OR truth table 208
- Oracle
  - default forward type mappings 767
  - default reverse type mappings 775
- ORDER BY clause
  - select statement 506
- order of evaluation
  - expressions 173
- ordering DB2 books 852
- ordinary tokens 55
- outer join
  - joined table 506
- overloaded function
  - multiple function instances 157
- overloaded method 165
- ownership
  - database objects 13

**P**

- package names
  - definition 57
- packages
  - authorization IDs
    - and binding 57
    - in dynamic statements 57
  - definition 13
- PACKET\_SIZE server option
  - valid settings 748
- parameter markers
  - host variables in dynamic SQL 57
- parameters
  - naming conventions 57
- parent key 5
- parent row 5
- parent table 5
- partial declustering 36
- PARTITION function (see HASHEDVALUE) 338
- partitioned database environments
  - description 1
- partitioned relational database; see partitioned database environments 1
- partitioned tables
  - with large objects (LOBs) 37
- partitioning data
  - across multiple partitions 36
  - partition compatibility 122
- partitioning keys
  - description 5
- partitioning maps
  - definition 23
- partitions
  - compatibility 122
- PASSWORD server option
  - valid settings 748
- path, SQL 157
- PERCENT\_ARGBYTES function mapping option
  - valid settings 747
- phantom row 20
- PLAN\_HINTS server option
  - valid settings 748
- point of consistency, database 18
- POSITION scalar function
  - description 376
- POSSTR function
  - description 379
  - values and arguments 379

- POWER scalar function
  - description 381
  - values and arguments 381
- precedence
  - order of evaluating operations 173
- precision
  - numbers, determined by SQLLEN variable 573
- precision-integer DECIMAL function 315
- predicates
  - basic, detailed diagram 211
  - BETWEEN, detailed diagram 215
  - description 207
  - EXISTS 216
  - IN 217
  - LIKE 219
  - NULL 224
  - quantified 212
  - TYPE 225
  - VALIDATED 227
  - XMLEXISTS 228
- PREPARE statement
  - dynamic SQL 1
- primary keys
  - definition 5
- printed books
  - ordering 852
- privileges
  - description 13
  - EXECUTE 157, 165
  - hierarchy 13
  - implicit for packages 13
  - individual 13
  - ownership (CONTROL) 13
- problem determination
  - online information 857
  - tutorials 857
- procedure name
  - definition 57
- promoting
  - data types 97
- PROXY\_AUTHID user option
  - valid settings 764
- PROXY\_PASSWORD user option
  - valid settings 764
- PROXY\_SERVER\_NAME wrapper option
  - valid settings 765
- PROXY\_SERVER\_PORT wrapper option
  - valid settings 765
- PROXY\_TYPE wrapper option
  - valid settings 765
- pushdown analysis
  - description 49
- PUSHDOWN server option
  - valid settings 748

**Q**

- qualified column names 57
- qualifiers
  - object name 57
  - reserved 783
- quantified predicate 212
- QUARTER function
  - description 382
  - values and arguments 382
- queries
  - authorization IDs 505

- queries (*continued*)
  - definition 505
  - description 1
  - examples
    - SELECT statement 548
  - fragments 49
  - recursive 548
- query optimization
  - description 49

## R

- RADIANS scalar function
  - description 383
  - values and arguments 383
- RAISE\_ERROR scalar function
  - description 384
  - values and arguments 384
- RAND scalar function
  - description 385
  - values and arguments 385
- read stability (RS)
  - description 20
- REAL function
  - description 386
  - single precision conversion 386
  - values and arguments 386
- REAL SQL data type
  - sign and precision 80
- REC2XML scalar function
  - description 387
  - values and arguments 387
- recursion queries 548
- recursive common table expression 548
- reference types
  - casting 99
  - comparisons 105
  - DEREF function 322
  - description 94
- referential constraints
  - description 5
- referential integrity
  - constraints 5
- regression functions
  - description 273
  - REGR\_AVGX 273
  - REGR\_AVGY 273
  - REGR\_COUNT 273
  - REGR\_ICPT 273
  - REGR\_INTERCEPT 273
  - REGR\_R2 273
  - REGR\_SLOPE 273
  - REGR\_SXX 273
  - REGR\_SXY 273
  - REGR\_SYY 273
- relational database
  - definition 1
- release-pending connection state 27
- remote
  - function name 57
  - type name 57
- remote authorization name 57
- remote catalog information 48
- remote unit of work
  - description 27
- REMOTE\_AUTHID user option
  - valid settings 764

- REMOTE\_DOMAIN user option
  - valid settings 764
- REMOTE\_NAME function mapping option
  - valid settings 747
- REMOTE\_PASSWORD user option
  - valid settings 764
- remote-object-name 57
- remote-schema-name 57
- remote-table-name 57
- REPEAT scalar function
  - description 391
  - values and arguments 391
- repeatable read (RR)
  - description 20
- REPLACE scalar function
  - description 392
  - values and arguments 392
- requester, application 27
- reserved
  - qualifiers 783
  - schemas 783
  - words 783
- resolution
  - function 157
  - method 165
- result columns
  - subselect 506
- result data type
  - arguments of COALESCE 116
  - multiple row VALUES clause 116
  - operands 116
  - result expressions of CASE 116
  - set operator 116
- result expressions of CASE
  - result data type 116
- result table
  - definition 4
  - query 505
- return identity column value
  - IDENTITY\_VAL\_LOCAL function 343
- returning hour part of values
  - HOUR function 342
- returning microsecond from value
  - MICROSECOND function 366
- returning minute from value
  - MINUTE function 368
- returning month from value
  - MONTH function 370
- returning seconds from value
  - SECOND function 402
- returning substrings from a string
  - SUBSTR function 411
- returning timestamp from values
  - TIMESTAMP function 423
- reverse type mappings
  - default mappings 775
- RIGHT scalar function
  - description 393
  - values and arguments 393
- rollback
  - definition 18
- ROLLUP grouping of GROUP BY clause 506
- ROUND scalar function
  - description 394
  - values and arguments 394
- routines
  - procedures 495

- routines (*continued*)
  - SQL administrative supported 233
  - SQL statements allowed 831
- row function
  - description 157
- rows
  - COUNT\_BIG function 263
  - definition 4
  - dependent 5
  - descendent 5
  - GROUP BY clause 506
  - HAVING clause 506
  - parent 5
  - search conditions, syntax 208
  - SELECT clause, syntax diagram 506
  - self-referencing 5
- RR (repeatable read) isolation level
  - description 20
- RS (read stability) isolation level
  - description 20
- RTRIM (SYSFUN schema) scalar function 397
- RTRIM scalar function
  - description 396
- run-time authorization ID 57

## S

- sampling
  - in a subselect
    - tablesample-clause 506
- savepoints
  - names 57
- SBCS (single-byte character set) data
  - definition 81
- scalar fullselect expressions 173
- scalar functions
  - DECIMAL function 315
  - description 157, 279
- scale
  - of data
    - comparisons in SQL 105
    - determined by SQLLEN variable 573
    - number conversion in SQL 105
  - of numbers
    - determined by SQLLEN variable 573
- schema names
  - definition 57
- schemas
  - controlling use 3
  - definition 3
  - privileges 3
  - reserved 783
- scope
  - definition 94
- Script
  - supported versions 45
- search conditions
  - AND logical operator 208
  - description 208
  - HAVING clause
    - arguments and rules 506
  - NOT logical operator 208
  - OR logical operator 208
  - order of evaluation 208
  - WHERE clause 506
- SECADM database authority 13
- SECLABEL scalar function
  - description 398
- SECLABEL\_BY\_NAME scalar function
  - description 399
- SECLABEL\_TO\_CHAR scalar function
  - description 400
- SECOND scalar function
  - description 402
  - values and arguments 402
- sections
  - definition 13
- security administrator authority (SECADM)
  - XXXX 13
- security labels (LBAC)
  - component name length 559
  - name length 559
  - policies
    - name length 559
- security-label-name XXXX 57
- security-policy-name XXXX 57
- SELECT clause
  - list notation, column reference 506
  - with DISTINCT keyword 506
- select list
  - application rules and syntax 506
  - description 506
  - notation rules and conventions 506
- SELECT statement
  - definition 548
  - examples 548
  - fullselect detailed syntax 543
  - subselects 506
  - VALUES clause 543
- self-referencing row 5
- self-referencing table 5
- sequence
  - values 203
- sequences
  - values, ordering 334
- server definitions
  - description 42
- server options
  - description 42
  - temporary 42
  - valid settings 748
- server types
  - valid federated types 737
- server-name 57
- servers
  - application
    - connecting applications to 27
- SESSION USER special register 154
- set integrity pending state 5
- set operators
  - EXCEPT, comparing differences 543
  - INTERSECT, role of AND in comparisons 543
  - result data type 116
  - UNION, correspondence to OR 543
- SET SERVER OPTION statement
  - setting an option temporarily 42
- share locks 20
- shift-in characters, not truncated by assignments 105
- SIGN scalar function
  - description 403
  - values and arguments 403
- signatures
  - function 157

- signatures (*continued*)
  - method 165
- SIN scalar function
  - description 404
  - values and arguments 404
- single-precision floating-point data type 80
- SINH scalar function
  - description 405
  - values and arguments 405
- size limits
  - identifier length 559
  - SQL 559
- small integer values from expressions, SMALLINT function 406
- small integers
  - See SMALLINT data type 80
- SMALLINT data type
  - sign and precision 80
- SMALLINT function
  - description 406
  - values and arguments 406
- SOME quantified predicate 212
- sorting 50
  - ordering of results 105
  - string comparisons 105
- SOUNDEX scalar function
  - description 407
  - values and arguments 407
- sourced functions 157
- SPACE scalar function
  - description 408
  - values and arguments 408
- space, rules governing 55
- special registers
  - CURRENT CLIENT\_ACCTNG 129
  - CURRENT CLIENT\_APPLNAME 130
  - CURRENT CLIENT\_USERID 131
  - CURRENT CLIENT\_WRKSTNNAME 132
  - CURRENT DATE 133
  - CURRENT DBPARTITIONNUM 134
  - CURRENT DEFAULT TRANSFORM GROUP 135
  - CURRENT DEGREE 136
  - CURRENT EXPLAIN MODE 137
  - CURRENT EXPLAIN SNAPSHOT 138
  - CURRENT FEDERATED ASYNCHRONY 139
  - CURRENT FUNCTION PATH 145
  - CURRENT IMPLICIT XMLPARSE OPTION 140
  - CURRENT ISOLATION 141
  - CURRENT LOCK TIMEOUT 142
  - CURRENT MAINTAINED TABLE TYPES FOR OPTIMIZATION 143
  - CURRENT NODE (see CURRENT DBPARTITIONNUM) 134
  - CURRENT PACKAGE PATH 144
  - CURRENT PATH 145
  - CURRENT QUERY OPTIMIZATION 146
  - CURRENT REFRESH AGE 147
  - CURRENT SCHEMA 148
  - CURRENT SERVER 149
  - CURRENT SQLID 148
  - CURRENT TIME 150
  - CURRENT TIMESTAMP 151
  - CURRENT TIMEZONE 152
  - CURRENT USER 153
  - interaction, Explain 821
  - SESSION USER 154
  - SQL language element 127
- special registers (*continued*)
  - SYSTEM USER 155
  - updatable 127
  - USER 156
- specific name
  - definition 57
- specifications
  - CAST 187
  - XMLCAST 190
- SQL (Structured Query Language)
  - limits 559
  - path 157
- SQL compiler
  - in a federated system 41
- SQL functions 157
- SQL operations
  - basic 105
- SQL path
  - built-in 157
- SQL statements
  - allowed in routines 831
  - CALL 835
  - displaying help 853
  - dynamic SQL, definition 1
  - immediate execution of dynamic SQL 1
  - interactive SQL, definition 1
  - preparing and executing dynamic SQL 1
  - static SQL, definition 1
- SQL subquery, WHERE clause 506
- SQL syntax
  - AVG aggregate function, results on column set 259
  - basic predicate, detailed diagram 211
  - BETWEEN predicate, rules 215
  - comparing two predicates, truth conditions 211, 225
  - CORRELATION aggregate function results 261
  - COUNT\_BIG function, arguments and results 263
  - COVARIANCE aggregate function results 265
  - EXISTS predicate 216
  - GENERATE\_UNIQUE function 334
  - GROUP BY clause, use in subselect 506
  - IN predicate description 217
  - LIKE predicate, rules 219
  - multiple operations, order of execution 543
  - regression functions results 273
  - search conditions, detailed formats and rules 208
  - SELECT clause description 506
  - STDDEV aggregate function, results 276
  - TYPE predicate 225
  - VARIANCE aggregate function results 278
  - WHERE clause search conditions 506
- SQL variable name 57
- SQLCA (SQL communication area)
  - description 567
  - error reporting 567
  - partitioned database systems 567
  - viewing interactively 567
- SQLD field in SQLDA 573
- SQLDA (SQL descriptor area)
  - contents 573
- SQLDABC field in SQLDA 573
- SQLDAID field in SQLDA 573
- SQLDATA field in SQLDA 573
- SQLDATALEN field in SQLDA 573
- SQLDATATYPE\_NAME field in SQLDA 573
- SQLIND field in SQLDA 573
- SQLJ (embedded SQL for Java)
  - connectivity 2

- SQLLEN field in SQLDA 573
- SQLLONGLEN field in SQLDA 573
- SQLN field in SQLDA 573
- SQLNAME field in SQLDA 573
- SQLSTATE
  - in RAISE\_ERROR function 384
- SQLTYPE field in SQLDA 573
- SQLVAR field in SQLDA 573
- SQRT scalar function
  - description 409
- SSL\_CLIENT\_CERTIFICATE\_LABEL user option
  - valid settings 764
- SSL\_KEYSTORE\_FILE wrapper option
  - valid settings 765
- SSL\_KEYSTORE\_PASSWORD wrapper option
  - valid settings 765
- SSL\_VERIFY\_SERVER\_CERTIFICATE wrapper option
  - valid settings 765
- statements
  - names 57
- states
  - connection 27
- static SQL
  - description 1
- STDDEV function 276
- storage
  - structures 23
- stored procedures
  - CALL statement 835
  - XSR\_COMPLETE 498
  - XSR\_DTD 499
  - XSR\_ENTITY 501
  - XSR\_REGISTER 503
- string units
  - built-in functions 81
- strings
  - assignment conversion rules 105
  - collating sequences 50
  - definition 25
- STRIP scalar function
  - description 410
- Structured Query Language (SQL)
  - assignments 105
  - basic operands, assignments and comparisons 105
  - comparison operation, overview 105
- structured type expression
  - casting to a subtype 202
- structured types
  - description 94
  - host variables 57
- sub-total rows 506
- subqueries
  - HAVING clause 506
  - using fullselect as search condition 57
  - WHERE clause 506
- subselect
  - description 506
  - example sequence of operations 506
  - examples 506
  - FROM clause, relation to subselect 506
- SUBSTR function
  - fragments 411
- SUBSTR scalar function
  - description 411
  - values and arguments 411
- SUBSTRING scalar function
  - description 414

- substrings 411
- SUM functions
  - detailed format description 277
  - values and arguments 277
- summary tables
  - definition 4
- super-aggregate rows 506
- super-groups 506
- supertypes
  - identifier names 57
- supported functions 233
- Sybase
  - default forward type mappings 767
  - default reverse type mappings 775
  - supported versions 45
  - valid server types 737
- symmetric super-aggregate rows 506
- synonyms
  - qualifying a column name 57
- syntax
  - description xvi
- system catalogs
  - views on system tables 583
- SYSTEM USER special register 155

## T

- TABLE clause
  - table reference 506
- table expressions
  - common 1
  - common table expressions 548
  - description 1
- table functions
  - description 157, 487
- table reference
  - alias 506
  - nested table expressions 506
  - nickname 506
  - table name 506
  - view name 506
- table spaces
  - description 23
  - name 57
- TABLE\_NAME function
  - alias 417
  - description 417
  - values and arguments 417
- TABLE\_SCHEMA function
  - alias 418
  - description 418
  - values and arguments 418
- table-structured files
  - supported versions 45
- tables
  - base 4
  - catalog views on system tables 583
  - check constraints
    - types 5
  - collocation 36
  - correlation name 57
  - declared temporary
    - description 4
  - definition 4
  - dependent 5
  - descendent 5
  - designator to avoid ambiguity 57

- tables *(continued)*
  - distribution key 5
  - exception 827
  - exposed names in FROM clause 57
  - foreign key 5
  - FROM clause, subselect naming conventions 506
  - names
    - description 57
    - in FROM clause 506
    - in SELECT clause, syntax diagram 506
  - nested table expression 57
  - non-exposed names in FROM clause 57
  - parent 5
  - partitioning key 5
  - primary key 5
  - qualified column name 57
  - results 4
  - scalar fullselect 57
  - self-referencing 5
  - subquery 57
  - summary 4
  - tablereference 506
  - transition 10
  - typed 4
  - unique correlation names 57
- TAN scalar function
  - description 420
  - values and arguments 420
- TANH scalar function
  - description 421
  - values and arguments 421
- Teradata
  - default forward type mappings 767
  - default reverse type mappings 775
  - valid server types 737
- terms and conditions
  - use of publications 857
- time
  - CHAR, use in format conversion 291
  - hour values, using in an expression (HOUR) 342
  - in expressions, TIME function 422
  - returning
    - microseconds, from datetime value 366
    - minutes, from datetime value 368
    - seconds, from datetime value 402
    - timestamp from values 423
    - values based on time 422
  - string representation formats 88
  - using time in expressions 422
- TIME data type
  - description 88
- TIME function
  - description 422
  - values and arguments 422
- TIMEFORMAT server option
  - valid settings 748
- TIMEOUT server option
  - valid settings 748
- TIMESTAMP data type
  - description 88
  - WEEK scalar function 447
  - WEEK\_ISO scalar function 448
- TIMESTAMP function
  - description 423
  - values and arguments 423
- TIMESTAMP\_FORMAT function
  - description 424
- TIMESTAMP\_FORMAT function *(continued)*
  - values and arguments 424
- TIMESTAMP\_ISO function
  - description 426
  - values and arguments 426
- TIMESTAMPDIFF scalar function
  - description 427
  - values and arguments 427
- TIMESTAMPFORMAT server option
  - valid settings 748
- timestamps
  - from GENERATE\_UNIQUE 334
  - string representation formats 88
- TO\_CHAR function
  - description 429
  - values and arguments 429
- TO\_DATE function
  - description 430
  - values and arguments 430
- tokens
  - case sensitivity 55
  - delimiter 55
  - ordinary 55
  - SQL language element 55
- TRANSLATE scalar function
  - character string 431
  - description 431
  - graphic string 431
  - values and arguments 431
- triggers
  - cascading 10
  - constraints, interaction 787
  - description 10
  - Explain tables 789
  - interactions 787
  - maximum name length 559
  - names 57
- TRIM scalar function
  - description 433
- troubleshooting
  - online information 857
  - tutorials 857
- TRUNCATE or TRUNC scalar function
  - description 435
  - values and arguments 435
- truncation
  - numbers 105
- truth tables 208
- truth valued logic 208
- tutorials
  - troubleshooting and problem determination 857
  - Visual Explain 856
- type mapping
  - name 57
- type name 57
- TYPE predicate
  - format 225
- type preserving method 165
- TYPE\_ID function
  - data types 436
  - description 436
  - values and arguments 436
- TYPE\_NAME function
  - description 437
  - values and arguments 437
- TYPE\_SCHEMA function
  - data types 438

- TYPE\_SCHEMA function (*continued*)
  - description 438
  - values and arguments 438
- typed tables
  - description 4
  - names 57
- typed views
  - description 12
  - names 57
- types
  - distinct 94
  - reference 94
  - structured 94

## U

- UCASE scalar function
  - description 439
  - values and arguments 439
- UDFs (user-defined functions)
  - description 492
- unary operator
  - minus sign 173
  - plus sign 173
- uncommitted reads (UR)
  - isolation levels 20
- unconnected state 27
- undefined reference errors 57
- Unicode
  - conversion to uppercase 55
- Unicode (UCS-2)
  - functions in 279
- UNION operator, role in comparison of fullselect 543
- unique constraints
  - definition 5
- unique correlation names
  - table designators 57
- unique keys
  - description 5
- units of work (UOW)
  - definition 18
  - distributed 27
  - remote 27
- unknown condition, null value 208
- updatable special registers 127
- update lock 20
- update rule, with referential constraints 5
- updates
  - DB2 Information Center 855
  - Information Center 855
- UPPER function
  - description 439
  - values and arguments 439
- UR (uncommitted read) isolation level 20
- user mappings
  - description 42
  - options 42
  - valid settings 764
- USER special register 156
- user-defined functions (UDFs)
  - description 157, 231, 492
- user-defined methods
  - description 165
- user-defined types (UDTs)
  - casting 99
  - description 94

- user-defined types (UDTs) (*continued*)
  - distinct types
    - description 94
  - reference type 94
  - structured types 94
  - unsupported data types 44

## V

- VALIDATED predicate 227
- value
  - definition 4, 78
  - null 78
- VALUE function
  - description 440
  - values and arguments 440
- values
  - sequence 203
- VALUES clause
  - fullselect 543
- VARCHAR data type
  - description 81
  - DOUBLE scalar function 325
  - WEEK scalar function 447
  - WEEK\_ISO scalar function 448
- VARCHAR function
  - description 441
  - values and arguments 441
- VARCHAR\_FORMAT function
  - description 443
  - values and arguments 443
- VARCHAR\_NO\_TRAILING\_ BLANKS column option
  - valid settings 740
- VARCHAR\_NO\_TRAILING\_ BLANKS server option
  - valid settings 748
- VARGRAPHIC data type
  - description 85
- VARGRAPHIC function
  - description 445
  - values and arguments 445
- variables
  - transition 10
- VARIANCE aggregate function 278
- varying-length character string 81
- varying-length graphic string 85
- view name
  - definition 57
- VIEWDEP catalog view
  - see catalog views, TABDEP 695
- views
  - description 12
  - exposed names in FROM clause 57
  - FROM clause, subselect naming conventions 506
  - names in FROM clause 506
  - names in SELECT clause, syntax diagram 506
  - non-exposed names in FROM clause 57
  - qualifying a column name 57
- Visual Explain
  - tutorial 856

## W

- WEEK scalar function
  - description 447
  - values and arguments 447

- WEEK\_ISO scalar function
  - description 448
  - values and arguments 448
- WHERE clause
  - search function, subselect 506
- wild cards, in LIKE predicate 219
- WITH common table expression 548
- words, SQL reserved 783
- wrapper options
  - valid settings 765
- wrappers
  - description 41
  - names 57

## X

- XML
  - data type 93
  - supported versions 45
- XMLAGG aggregate function
  - description 271
- XMLATTRIBUTES scalar function
  - description 449
- XMLCAST
  - specifications 190
- XMLCOMMENT scalar function
  - description 451
- XMLCONCAT scalar function
  - description 452
- XMLDOCUMENT scalar function
  - description 454
- XMLELEMENT scalar function
  - description 456
- XML EXISTS predicate 228
- XMLFOREST scalar function
  - description 462
- XMLNAMESPACES declaration
  - description 466
- XMLPARSE scalar function
  - description 469
- XMLPI scalar function
  - description 471
- XMLQUERY scalar function
  - description 473
- XMLSERIALIZE scalar function
  - description 476
- XMLTABLE table function
  - description 488
- XMLTEXT scalar function
  - description 479
- XMLVALIDATE scalar function
  - description 481
- XMLXSROBJECTID scalar function
  - description 485
- XSR\_COMPLETE stored procedure 498
- XSR\_DTD stored procedure 499
- XSR\_ENTITY stored procedure 501
- XSR\_REGISTER stored procedure 503

## Y

- YEAR scalar function
  - description 486
  - values and arguments 486



---

## Contacting IBM

To contact IBM in your country or region, check the IBM Directory of Worldwide Contacts at <http://www.ibm.com/planetwide>

To learn more about DB2 products, go to <http://www.ibm.com/software/data/db2/>.







Printed in USA

SC10-4249-00



DB2 9 BETA

Spine information:

IBM DB2  
DB2 9.5  
DB2 9.5

DB2 Version 9

SQL Reference Volume 1

