

IBM DB2 10.1  
for Linux, UNIX, and Windows

*pureXML Guide*





IBM DB2 10.1  
for Linux, UNIX, and Windows

*pureXML Guide*



**Note**

Before using this information and the product it supports, read the general information under Appendix E, "Notices," on page 501.

**Edition Notice**

This document contains proprietary information of IBM. It is provided under a license agreement and is protected by copyright law. The information contained in this publication does not include any product warranties, and any statements provided in this manual should not be interpreted as such.

You can order IBM publications online or through your local IBM representative.

- To order publications online, go to the IBM Publications Center at <http://www.ibm.com/shop/publications/order>
- To find your local IBM representative, go to the IBM Directory of Worldwide Contacts at <http://www.ibm.com/planetwide/>

To order DB2 publications from DB2 Marketing and Sales in the United States or Canada, call 1-800-IBM-4YOU (426-4968).

When you send information to IBM, you grant IBM a nonexclusive right to use or distribute the information in any way it believes appropriate without incurring any obligation to you.

© Copyright IBM Corporation 2006, 2012.

US Government Users Restricted Rights – Use, duplication or disclosure restricted by GSA ADP Schedule Contract with IBM Corp.

# Contents

## About this book. . . . . vii

## Chapter 1. pureXML overview -- DB2 as an XML database. . . . . 1

XML data type . . . . .	3
XML input and output overview . . . . .	3
Comparison of the XML model and the relational model . . . . .	8
XQuery and XPath data model . . . . .	10
Sequences and items . . . . .	10
Atomic values . . . . .	11
Node hierarchies . . . . .	11
Node properties . . . . .	12
Node kinds . . . . .	13
Document order of nodes. . . . .	15
Node identity . . . . .	16
Typed values and string values of nodes . . . . .	16
Tools that support XML . . . . .	16
Federation support for pureXML . . . . .	18
Replication and event publishing support for pureXML . . . . .	18
Articles on XML support . . . . .	19

## Chapter 2. pureXML tutorial. . . . . 21

Lesson 1: Creating a DB2 database and table that can store XML data. . . . .	22
Lesson 2: Creating indexes over XML data . . . . .	22
Lesson 3: Inserting XML documents into XML type columns . . . . .	23
Lesson 4: Updating XML documents stored in XML columns . . . . .	24
Lesson 5: Deleting XML data . . . . .	25
Lesson 6: Querying XML data . . . . .	27
Lesson 7: Validating XML documents against XML schemas . . . . .	30
Lesson 8: Transforming with XSLT stylesheets. . . . .	31

## Chapter 3. XML storage . . . . . 35

XML storage object . . . . .	35
XML base table row storage . . . . .	36
Storage requirements for XML documents . . . . .	37
Data types for archiving XML documents . . . . .	38

## Chapter 4. Inserting XML data. . . . . 39

Creation of tables with XML columns. . . . .	39
Addition of XML columns to existing tables . . . . .	40
Insertion into XML columns . . . . .	40
XML parsing . . . . .	41
XML data integrity . . . . .	46
Check constraints on XML columns . . . . .	46
Trigger processing of XML data. . . . .	48
XML validation . . . . .	50
XSR_GET_PARSING_DIAGNOSTICS stored procedure . . . . .	53

Displaying detailed XML parsing and validation errors . . . . .	55
ErrorLog XML schema definition for enhanced error message support. . . . .	57
Using XML in a non-Unicode database . . . . .	60

## Chapter 5. Querying XML data . . . . . 65

Introduction to XQuery . . . . .	65
Retrieving DB2 data with XQuery functions . . . . .	66
Introduction to querying XML data with SQL . . . . .	67
Comparison of XQuery to SQL . . . . .	68
Comparison of methods for querying XML data . . . . .	69
Specifying XML namespaces. . . . .	70
Example: Changing the namespace prefix of an element. . . . .	72
XMLQUERY function overview. . . . .	73
Non-empty sequences returned by XMLQUERY . . . . .	74
Empty sequences returned by XMLQUERY. . . . .	75
Casting of XMLQUERY results to non-XML types . . . . .	76
Casting between data types . . . . .	77
XMLQUERY . . . . .	85
XMLTABLE function overview . . . . .	87
Example: Inserting values returned from XMLTABLE . . . . .	89
Example: Returning one row for each occurrence of an item using XMLTABLE . . . . .	90
Example: Processing elements from multiple trees in an XML document using XMLTABLE. . . . .	92
Example: Processing hierarchical data using XMLTABLE . . . . .	93
XMLTABLE . . . . .	95
XMLEXISTS predicate when querying XML data . . . . .	99
XMLEXISTS predicate usage . . . . .	100
XMLEXISTS predicate . . . . .	101
Passing parameters between SQL statements and XQuery expressions . . . . .	104
Constant and parameter marker passing to XMLEXISTS and XMLQUERY . . . . .	104
Simple column name passing with XMLEXISTS, XMLQUERY, or XMLTABLE . . . . .	105
Passing parameters from XQuery to SQL . . . . .	106
Data retrieval with XQuery. . . . .	107
Guidelines for matching indexes with queries overview . . . . .	109
Restrictiveness of index definitions . . . . .	110
Considerations when specifying text() nodes . . . . .	112
Data type of literals . . . . .	113
Join predicate conversion . . . . .	114
Indeterminate query evaluation . . . . .	115
Full-text search in XML documents . . . . .	116
Retrieval of data in XML columns to earlier DB2 clients . . . . .	117
SQL/XML publishing functions for constructing XML values . . . . .	118
Examples of publishing XML values. . . . .	119

Special character handling in SQL/XML publishing functions . . . . .	123
XML serialization . . . . .	124
Transforming with XSLT stylesheets . . . . .	125
Passing parameters to XSLT stylesheets at runtime . . . . .	128
Example: Using XSLT as a formatting engine	128
Example: Using XSLT for data exchange . . . . .	130
Example: Using XSLT to remove namespaces	131
Example: Using the document function of XSLT	134
Important considerations for transforming XML documents . . . . .	136
Differences in an XML document after storage and retrieval . . . . .	136

## Chapter 6. Indexing XML data . . . . . 139

Index XML pattern expressions . . . . .	140
Examples of using case insensitive XML indexes	143
Examples of using indexes that specify fn:exists	145
Examples of using indexes with queries that specify fn:starts-with . . . . .	148
Context steps and function expression steps . . . . .	150
XML namespace declarations . . . . .	150
Data types associated with index XML pattern expressions . . . . .	152
Data type conversion for indexes over XML data	153
Invalid XML values . . . . .	154
Document rejection or CREATE INDEX statement failure . . . . .	156
Summary table for conversion to the index XML data type. . . . .	157
XML schemas and index key generation . . . . .	158
UNIQUE keyword semantics . . . . .	159
Database objects associated with XML data indexing . . . . .	160
Logical and physical indexes over XML data	160
Other database objects associated with XML columns . . . . .	161
Recreation of indexes over XML data . . . . .	162
CREATE INDEX . . . . .	163
Sample queries against indexes over XML data . . . . .	183
Restrictions on indexes over XML data . . . . .	186
Common XML indexing issues . . . . .	188
Troubleshooting SQL20305N messages issued by INSERT or UPDATE statements . . . . .	188
Troubleshooting SQL20306N messages issued by CREATE INDEX statements on populated tables	191

## Chapter 7. Updating XML data . . . . . 193

Use of updating expressions in a transform expression . . . . .	194
Updating XML documents with information from other tables . . . . .	197
Deletion of XML data from tables . . . . .	198

## Chapter 8. XML schema repository 201

XSR objects . . . . .	201
XSR object registration . . . . .	201
Registering XSR objects through stored procedures . . . . .	202

Registering XSR objects through the command line processor . . . . .	203
Java support for XML schema registration and removal . . . . .	204
Altering registered XSR objects . . . . .	206
Evolving an XML schema . . . . .	206
Compatibility requirements for evolving an XML schema . . . . .	207
Scenario: Evolving an XML schema . . . . .	214
Examples of extracting XML schema information	216
Listing XML schemas registered with the XSR	216
Retrieving all components of an XML schema registered with the XSR . . . . .	216
Retrieving the XML schema of an XML document . . . . .	217

## Chapter 9. XML data movement . . . . . 219

Important considerations for XML data movement	220
Query and XPath Data Model . . . . .	221
LOB and XML file behavior when importing and exporting. . . . .	221
XML data specifier . . . . .	222
Exporting XML data . . . . .	223
Importing XML data . . . . .	226
Loading XML data . . . . .	227
Resolving indexing errors when loading XML data . . . . .	228

## Chapter 10. Application programming language support . . . . . 235

CLI. . . . .	236
XML data handling in CLI applications - Overview. . . . .	236
XML column inserts and updates in CLI applications . . . . .	237
XML data retrieval in CLI applications . . . . .	238
Changing of default XML type handling in CLI applications . . . . .	239
Embedded SQL . . . . .	239
Declaring XML host variables in embedded SQL applications . . . . .	239
Example: Referencing XML host variables in embedded SQL applications . . . . .	240
Executing XQuery expressions in embedded SQL applications . . . . .	242
Recommendations for developing embedded SQL applications with XML and XQuery . . . . .	243
Identifying XML values in an SQLDA . . . . .	244
Java . . . . .	244
Binary XML format in Java applications . . . . .	244
JDBC . . . . .	246
SQLJ . . . . .	254
PHP . . . . .	258
PHP application development for IBM data servers . . . . .	258
XML data retrieval using PHP applications . . . . .	259
PHP downloads and related resources . . . . .	260
Perl . . . . .	260
pureXML and Perl. . . . .	260
Database connections in Perl . . . . .	262

Perl Restrictions . . . . .	263	Registering and enabling XML schemas for decomposition . . . . .	340
Routines . . . . .	264	Multiple XML document decomposition examples . . . . .	341
SQL procedures . . . . .	264	Annotated XML schema decomposition and recursive XML documents . . . . .	342
SQL functions . . . . .	266	Disabling of annotated XML schema decomposition	347
External routines . . . . .	268	xdbDecompXML procedures for annotated schema decomposition . . . . .	348
Performance of routines . . . . .	280	DECOMPOSE XML DOCUMENT . . . . .	351
Sample applications . . . . .	287	XDB_DECOMP_XML_FROM_QUERY stored procedure for annotated schema decomposition . . . . .	352
pureXML Samples . . . . .	287	XML decomposition annotations . . . . .	356
pureXML - Administration samples . . . . .	288	XML decomposition annotations - Specification and scope . . . . .	357
pureXML - Application Development samples	290	XML decomposition annotations - Summary . . . . .	358
<b>Chapter 11. XML performance . . . . .</b>	<b>297</b>	db2-xdb:defaultSQLSchema decomposition annotation . . . . .	359
The pureXML feature and data organization schemes . . . . .	297	db2-xdb:rowSet decomposition annotation . . . . .	360
Example using XQuery transform in a partitioned database environment . . . . .	298	db2-xdb:table decomposition annotation . . . . .	364
Using declared temporary tables with XML data	301	db2-xdb:column decomposition annotation . . . . .	368
Using optimization guidelines with XML data and XQuery expressions . . . . .	303	db2-xdb:locationPath decomposition annotation	370
Examples of optimization guidelines with XML data . . . . .	304	db2-xdb:expression decomposition annotation	373
Preference of DMS table spaces for pureXML data store performance . . . . .	309	db2-xdb:condition decomposition annotation	376
<b>Chapter 12. XML data encoding . . . . .</b>	<b>311</b>	db2-xdb:contentHandling decomposition annotation . . . . .	379
Internally encoded XML data . . . . .	311	db2-xdb:normalization decomposition annotation . . . . .	384
Encoding considerations when storing or passing XML data . . . . .	312	db2-xdb:order decomposition annotation . . . . .	386
Encoding considerations for input of XML data to a database . . . . .	312	db2-xdb:truncate decomposition annotation . . . . .	388
Encoding considerations for retrieval of XML data from a database . . . . .	313	db2-xdb:rowSetMapping decomposition annotation . . . . .	390
Encoding considerations for passing XML data in routine parameters. . . . .	313	db2-xdb:rowSetOperationOrder decomposition annotation . . . . .	394
Encoding considerations for XML data in JDBC, SQLJ, and .NET applications . . . . .	313	Keywords for annotated XML schema decomposition . . . . .	395
Effects of XML encoding and serialization on data conversion . . . . .	314	How decomposition results are formed in annotated XML schema decomposition . . . . .	396
Encoding scenarios for input of internally encoded XML data to a database . . . . .	314	Effect of validation on XML decomposition results . . . . .	396
Encoding scenarios for input of externally encoded XML data to a database . . . . .	316	Treatment of CDATA sections in annotated XML schema decomposition . . . . .	397
Encoding scenarios for retrieval of XML data with implicit serialization . . . . .	318	NULL values and empty strings in annotated XML schema decomposition . . . . .	398
Encoding scenarios for retrieval of XML data with explicit XMLSERIALIZE . . . . .	320	Checklist for annotated XML schema decomposition . . . . .	399
Mapping internally encoded XML data and CCSIDs . . . . .	323	Annotations of derived complex types for annotated XML schema decomposition . . . . .	400
Mappings of encoding names to effective CCSIDs for stored XML data . . . . .	323	XML schema structuring recommendations for decomposition . . . . .	403
Mappings of CCSIDs to encoding names for serialized XML output data. . . . .	334	Examples of mappings in annotated XML schema decomposition . . . . .	404
<b>Chapter 13. Annotated XML schema decomposition . . . . .</b>	<b>339</b>	rowSets in annotated XML schema decomposition . . . . .	404
Advantage of annotated XML schema decomposition . . . . .	339	Decomposition annotation example: Mapping to an XML column . . . . .	407
Decomposing XML documents with annotated XML schemas . . . . .	340	Decomposition annotation example: A value mapped to a single table that yields a single row . . . . .	409

Decomposition annotation example: A value mapped to a single table that yields multiple rows . . . . .	410
Decomposition annotation example: A value mapped to multiple tables . . . . .	412
Decomposition annotation example: Grouping multiple values mapped to a single table . . . . .	413
Decomposition annotation example: Multiple values from different contexts mapped to a single table . . . . .	415
XML schema to SQL types compatibility for annotated schema decomposition. . . . .	417
Limits and restrictions for annotated XML schema decomposition . . . . .	421
Troubleshooting considerations for annotated XML schema decomposition . . . . .	423
Schema for XML decomposition annotations . . . . .	425

**Chapter 14. Restrictions on pureXML 427**  
Restrictions on the pureXML feature. . . . . 427

**Appendix A. Encoding mappings . . . 431**  
Mappings of encoding names to effective CCSIDs for stored XML data . . . . . 431  
Mappings of CCSIDs to encoding names for serialized XML output data. . . . . 442

**Appendix B. SQL/XML publishing functions . . . . . 447**  
XMLAGG . . . . . 447  
XMLATTRIBUTES. . . . . 448  
XMLCOMMENT . . . . . 450  
XMLCONCAT . . . . . 450  
XMLDOCUMENT. . . . . 451  
XMLELEMENT. . . . . 452  
XMLFOREST . . . . . 458  
XMLGROUP . . . . . 461  
XMLNAMESPACES . . . . . 464  
XMLPI . . . . . 466

XMLROW . . . . .	467
XMLTEXT . . . . .	469
XSLTRANSFORM . . . . .	470

**Appendix C. XSR stored procedures and commands . . . . . 475**

XSR stored procedures . . . . .	475
XSR_REGISTER . . . . .	475
XSR_ADDSCHEMADOC . . . . .	476
XSR_COMPLETE . . . . .	477
XSR_DTD . . . . .	478
XSR_EXTENTITY . . . . .	480
XSR_UPDATE . . . . .	481
XSR commands. . . . .	482
REGISTER XMLSCHEMA . . . . .	482
ADD XMLSCHEMA DOCUMENT . . . . .	484
COMPLETE XMLSCHEMA . . . . .	485
REGISTER XSROBJECT . . . . .	486
UPDATE XMLSCHEMA. . . . .	488

**Appendix D. Overview of the DB2 technical information . . . . . 491**

DB2 technical library in hardcopy or PDF format	491
Displaying SQL state help from the command line processor . . . . .	494
Accessing different versions of the DB2 Information Center . . . . .	494
Updating the DB2 Information Center installed on your computer or intranet server . . . . .	494
Manually updating the DB2 Information Center installed on your computer or intranet server . . . . .	496
DB2 tutorials . . . . .	497
DB2 troubleshooting information. . . . .	498
Terms and conditions. . . . .	498

**Appendix E. Notices . . . . . 501**

**Index . . . . . 505**



---

## About this book

The pureXML<sup>®</sup> Guide describes how you work with XML data in DB2<sup>®</sup> databases. It tells you about the XML data type and XML storage, how you work with XML data using the SQL and XQuery languages, and how you can index XML data for performance. Additional topics cover pureXML application development, data movement, and the decomposition of XML data into relational formats.



---

## Chapter 1. pureXML overview -- DB2 as an XML database

The pureXML feature allows you to store well-formed XML documents in database table columns that have the XML data type. By storing XML data in XML columns, the data is kept in its native hierarchical form, rather than stored as text or mapped to a different data model.

Because pureXML data storage is fully integrated, the stored XML data can be accessed and managed by leveraging existing DB2 database server functionality.

The storage of XML data in its native hierarchical form enables efficient search, retrieval, and updates of XML. XQuery, SQL, or a combination of both can be used to query and update XML data. SQL functions that return XML data or take XML arguments (referred to as SQL/XML functions) also enable XML data to be constructed or published from values retrieved from the database.

### Querying and updating

XML documents stored in XML columns can be queried and updated using the following methods:

#### XQuery

XQuery is a generalized language for interpreting, retrieving, and modifying XML data. The DB2 database server allows XQuery to be invoked directly or from within SQL. Because the XML data is stored in DB2 tables and views, functions are provided that extract the XML data from specified tables and views by naming the table or view directly, or by specifying an SQL query. XQuery supports various expressions for processing XML data, for updating existing XML objects such as elements and attributes, and for constructing new XML objects. The programming interface to XQuery provides facilities similar to those of SQL to execute queries and retrieve results.

#### SQL statements and SQL/XML functions

Many SQL statements support the XML data type. This enables you to perform many common database operations with XML data, such as creating tables with XML columns, adding XML columns to existing tables, creating indexes over XML columns, creating triggers on tables with XML columns, and inserting, updating, or deleting XML documents. The set of SQL/XML functions, expressions, and specifications supported by DB2 database server has been enhanced to take full advantage of the XML data type.

XQuery can be invoked from within an SQL query. In this case, the SQL query can pass data to XQuery in the form of bound variables.

### Application development

Support for application development is provided by several programming languages, and through SQL and external procedures:

#### Programming language support

Application development support of the new pureXML feature enables applications to combine XML and relational data access and storage. The following programming languages support the XML data type:

- C or C++ (embedded SQL or CLI)
- COBOL
- Java (JDBC or SQLJ)
- C# and Visual Basic (IBM® Data Server Provider for .NET)
- PHP
- Perl

### **SQL and external procedures**

XML data can be passed to SQL procedures and external procedures by including parameters of data type XML in CREATE PROCEDURE parameter signatures. Existing procedure features support the implementation of procedural logic flow around SQL statements that produce or make use of XML values as well as the temporary storage of XML data values in variables.

## **Administration**

The pureXML feature provides a repository for managing the URI dependencies of XML documents and enables XML data movement for database administration:

### **XML schema repository (XSR)**

The XML schema repository (XSR) is a repository for all XML artifacts required to process XML instance documents stored in XML columns. It stores XML schemas, DTDs, and external entities referenced in XML documents.

### **Import, export and load utilities**

The import, export and load utilities have been updated to support the native XML data type. These utilities treat XML data like LOB data: both types of data are stored outside the actual table. Application development support for importing, exporting and loading XML data is also provided by updated db2Import, db2Export and db2Load APIs. These updated utilities permit data movement of XML documents stored in XML columns that is similar to the data movement support for relational data.

## **Performance**

Several performance oriented features are available to you when working with XML documents stored in XML columns:

### **Indexes over XML data**

Indexing support is available for data stored in XML columns. The use of indexes over XML data can improve the efficiency of queries issued against XML documents. Similar to a relational index, an index over XML data indexes a column. They differ, however, in that a relational index indexes an entire column, while an index over XML data indexes part of a column. You indicate which parts of an XML column are indexed by specifying an XML pattern, which is a limited XPath expression.

### **Optimizer**

The optimizer has been updated to support the evaluation of SQL, XQuery, and SQL/XML functions that embed XQuery, against XML and relational data. The optimizer exploits statistics gathered over XML data, as well as data from indexes over XML data, to produce efficient query execution plans.

### **Explain and Visual Explain**

The Explain facility has been updated to support SQL enhancements for

querying XML data and to support XQuery expressions. These updates to the Explain facility allow you to see quickly how DB2 database server evaluates query statements against XML data.

## Tooling

Support for the XML data type is available in tools including the Control Center, command line processor, IBM Data Studio, and IBM Database Add-Ins for Microsoft Visual Studio.

## Annotated XML schema decomposition

The pureXML feature enables you to store and access XML data as XML, in its hierarchical form, there can be cases where accessing XML data as relational data is required. Annotated XML schema decomposition decomposes documents based on annotations specified in an XML schema.

---

## XML data type

The XML data type is used to define columns of a table that store XML values, where all stored XML values must be well-formed XML documents. The introduction of this native XML data type provides the ability to store well-formed XML documents in their native hierarchical format in the database alongside other relational data.

XML values are processed in an internal representation that is not a string and not directly comparable to string values. An XML value can be transformed into a serialized string value representing the XML document using the XMLSERIALIZE function or by binding the value to an application variable of an XML, string, or binary type. Similarly, a string value that represents an XML document can be transformed to an XML value using the XMLPARSE function or by binding an application string, binary, or XML application type to an XML value. In SQL data change statements (such as INSERT) involving XML columns, a string or binary value that represents an XML document is transformed into an XML value using an injected XMLPARSE function. An XML value can be implicitly parsed or serialized when exchanged with application string and binary data types.

There is no architectural limit on the size of an XML value in a database. However, note that serialized XML data exchanged with DB2 database server is effectively limited to 2 GB.

XML documents can be inserted, updated and deleted using SQL data manipulation statements. Validation of an XML document against an XML schema, typically performed during insert or update, is supported by the XML schema repository (XSR). The DB2 database system also provides mechanisms for constructing and querying XML values, as well as exporting and importing XML data. An index over XML data can be defined on an XML column, providing improved search performance of XML data. The XML data in table or view columns can be retrieved as serialized string data through various application interfaces.

---

## XML input and output overview

The DB2 database server, which manages both relational and XML data, offers various methods for the input and output of XML documents.

XML documents are stored in columns defined with the XML data type. Each row of an XML column stores a single well-formed XML document. The stored document is kept in its hierarchical form, preserving the XML data model; the document is not stored as text or mapped to a different data model.

XML columns can be defined in tables that contain columns of other types, which hold relational data, and multiple XML columns can be defined for a single table.

## **Input**

Figure 1 on page 5 shows the various ways that XML data can be put into the database system.

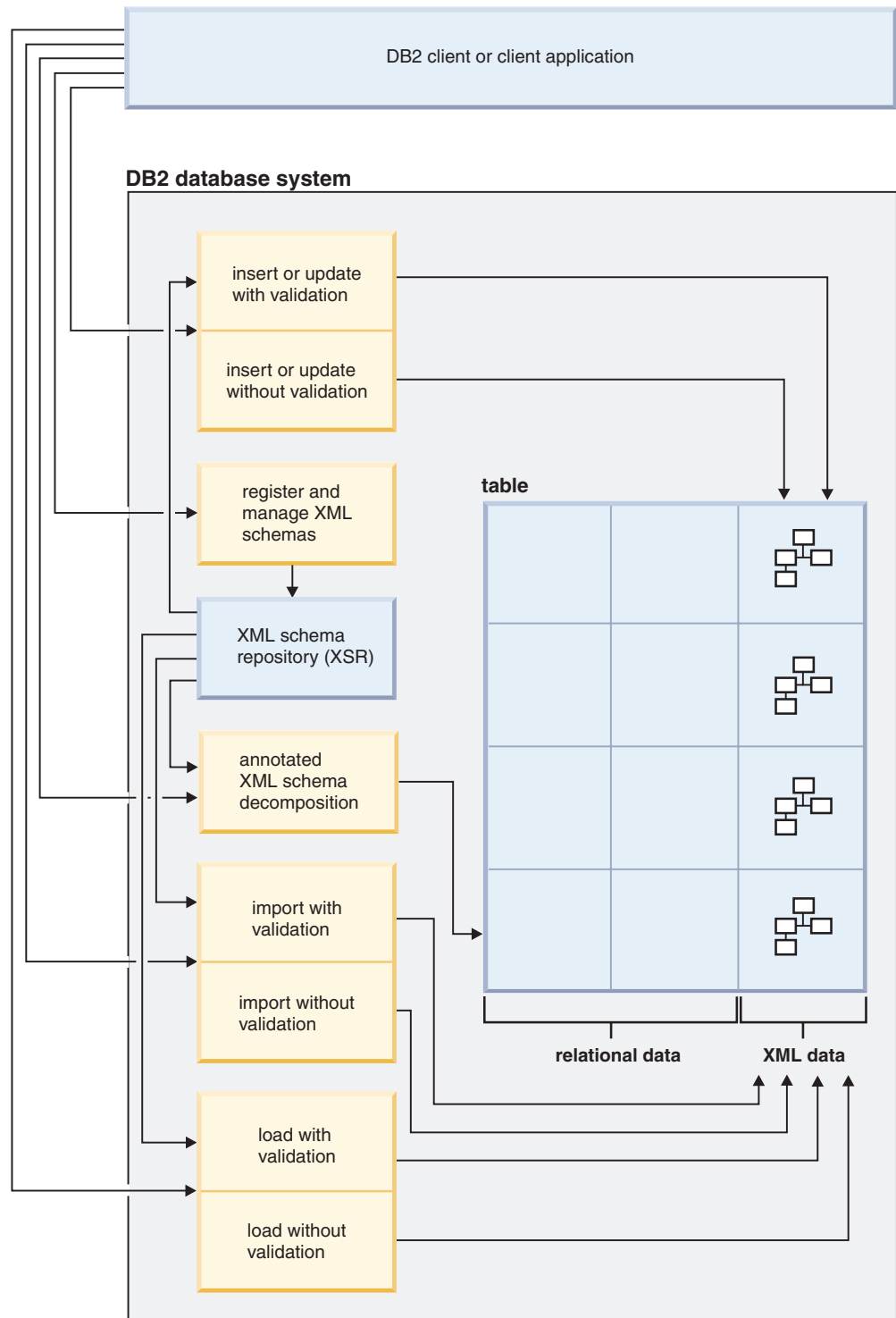

Figure 1. Methods for input of XML data

Which input method you use depends on the task you wish to accomplish:

**Insert or update**

Well-formed documents are inserted into XML columns using the INSERT SQL statement. A document is well-formed when it can be parsed successfully. Validation of the XML documents during an insert or update operation is optional. If validation is performed, the XML schema must

first be registered with the XML schema repository (XSR). Documents are updated using the UPDATE SQL statement, or using XQuery updating expressions.

### **Annotated XML schema decomposition**

Data from XML documents can be decomposed or stored into relational and XML columns using annotated XML schema decomposition. Decomposition stores data in columns according to annotations that are added to XML schema documents. These annotations map the data in XML documents to columns of tables.

XML schema documents referenced by the decomposition feature are stored in the XML schema repository (XSR).

### **Import**

XML documents can be imported into XML columns using the import utility. Validation of the XML documents being imported is optional. If validation is performed, the XML schema against which the documents are validated, must first be registered with the XML schema repository (XSR).

### **XML schema repository (XSR) registration**

The XML schema repository (XSR) stores XML schemas that are used for the validation or decomposition of XML documents. Registration of XML schemas is usually a prerequisite for other tasks that are performed on XML documents which have a dependency on these schemas. XML schemas are registered with the XSR using stored procedures or commands.

## **Output**

Figure 2 on page 7 shows the various ways that XML data can be retrieved from the database system.



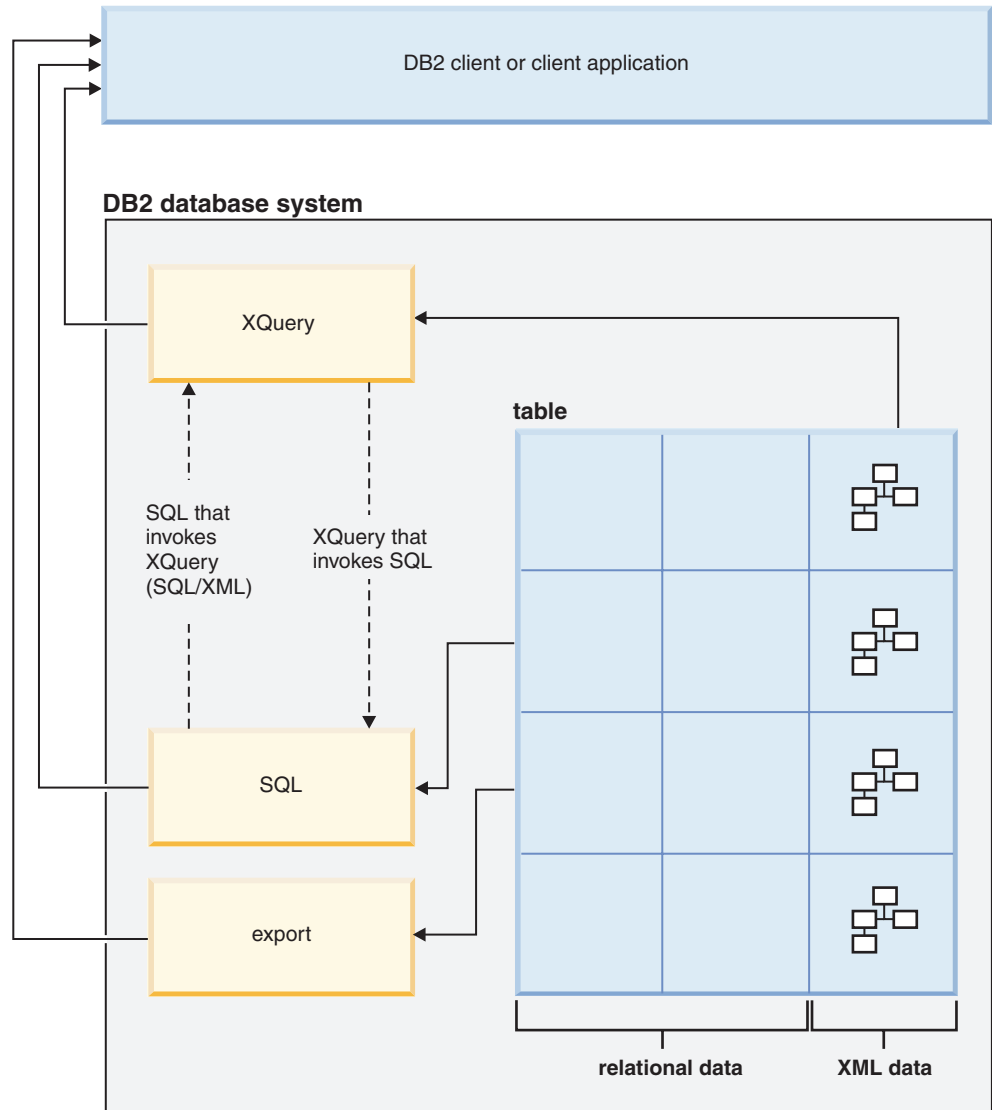

Figure 2. Methods for output of XML data

Which output method you use depends on the task you wish to accomplish:

### XQuery

XQuery is a language that enables you to query within XML documents. It addresses specific requirements of querying XML data that is highly variable in structure, unlike queries on relational data that expect a predictable structure.

XQuery can be invoked on its own, or it can invoke SQL to query XML stored in a DB2 database, through the `db2-fn.xmlcolumn` and `db2-fn.sqlquery` XQuery functions. `db2-fn.xmlcolumn` retrieves an entire XML column, whereas `db2-fn.sqlquery` retrieves XML values that are based on an SQL fullselect.

### SQL

When querying XML data using an SQL fullselect, the query occurs at the column level. For this reason, only entire XML documents can be returned from the query; it is not possible to return fragments of an XML document using only SQL. To query within XML documents, XQuery must be used. XQuery can be invoked from SQL using the `XMLQUERY` or `XMLTABLE`

SQL/XML functions, or the XMLEXISTS predicate. The XMLQUERY function returns the result of an XQuery expression as an XML sequence. The XMLTABLE function returns the result of an XQuery expression as a table. The XMLEXISTS SQL predicate determines whether an XQuery expression returns a non-empty sequence.

A number of publishing functions are also available to construct XML values from XML data stored in DB2 database server. XML values constructed with these publishing functions do not have to be well-formed XML documents.

**Export** XML documents can be exported from XML columns using the export utility. Exported XML data is stored separately from the exported relational data in the main data file. Details about each exported XML document is not stored directly in the main exported data file. The details are instead represented in the main data file by an XML data specifier (XDS).

---

## Comparison of the XML model and the relational model

When you design your databases, you need to decide whether your data is better suited to the XML model or the relational model. Your design can also take advantage of the hybrid nature of a DB2 database, that is, the ability to support both relational and XML data in a single database.

While this discussion explains some of the main differences between the models and the factors that apply to each, there are numerous factors that can determine the most suitable choice for your implementation. Use this discussion as a guideline to assess the factors that can impact your specific implementation.

### Major differences between XML data and relational data

**XML data is hierarchical; relational data is represented in a model of logical relationships**

An XML document contains information about the relationship of data items to each other in the form of the hierarchy. With the relational model, the only types of relationships that can be defined are parent table and dependent table relationships.

**XML data is self-describing; relational data is not**

An XML document contains not only the data, but also tagging for the data that explains what it is. A single document can have different types of data. With the relational model, the content of the data is defined by its column definition. All data in a column must have the same type of data.

**XML data has inherent ordering; relational data does not**

For an XML document, the order in which data items are specified is assumed to be the order of the data in the document. There is often no other way to specify order within the document. For relational data, the order of the rows is not guaranteed unless you specify an ORDER BY clause on one or more columns.

### Factors influencing data model choice

What kind of data you store can help you determine how you store it. For example, if the data is naturally hierarchical and self-describing, you might store it as XML data. However, there are other factors that might influence your decision about which model to use:

**When you need maximum flexibility**

Relational tables follow a fairly rigid model. For example, normalizing one table into many or denormalizing many tables into one can be very difficult. If the data design changes often, representing it as XML data is a better choice. XML schemas can be evolved over time, for example.

**When you need maximum performance for data retrieval**

Some expense is associated with serializing and interpreting XML data. If performance is more of an issue than flexibility, relational data might be the better choice.

**When data is processed later as relational data**

If subsequent processing of the data depends on the data being stored in a relational database, it might be appropriate to store parts of the data as relational, using decomposition. An example of this situation is when online analytical processing (OLAP) is applied to the data in a data warehouse. Also, if other processing is required on the XML document as a whole, then storing some of the data as relational as well as storing the entire XML document might be a suitable approach in this case.

**When data components have meaning outside a hierarchy**

Data might be inherently hierarchical in nature, but the child components do not need the parents to provide value. For example, a purchase order might contain part numbers. The purchase orders with the part numbers might be best represented as XML documents. However, each part number has a part description associated with it. It might be better to include the part descriptions in a relational table, because the relationship between the part numbers and the part descriptions is logically independent of the purchase orders in which the part numbers are used.

**When data attributes apply to all data, or to only a small subset of the data**

Some sets of data have a large number of possible attributes, but only a small number of those attributes apply to any particular data value. For example, in a retail catalog, there are many possible data attributes, such as size, color, weight, material, style, weave, power requirements, or fuel requirements. For any given item in the catalog, only a subset of those attributes is relevant: power requirements are meaningful for a table saw, but not for a coat. This type of data is difficult to represent and search with a relational model, but relatively easy to represent and search with an XML model.

**When the ratio of data complexity to volume is high**

Many situations involve highly structured information in very small quantities. Representation of that data with a relational model can involve complex star schemas in which each dimension table is joined to many more dimension tables, and most of the tables have only a few rows. A better way to represent this data is to use a single table with an XML column, and to create views on that table, where each view represents a dimension.

**When referential integrity is required**

XML columns cannot be defined as part of referential constraints. Therefore, if values in XML documents need to participate in referential constraints, you should store the data as relational data.

**When the data needs to be updated often**

You update XML data in an XML column only by replacing full documents. If you need to frequently update small fragments of very large documents for a large number of rows, it can be more efficient to store the

data in non-XML columns. If, however, you are updating small documents and only a few documents at a time, storing as XML can be efficient as well.

---

## XQuery and XPath data model

XQuery expressions operate on instances of the XQuery and XPath data model (XDM) and return instances of the data model. The XDM provides an abstract representation of one or more XML documents or fragments. The data model defines all permissible values of expressions in XQuery, including values that are used during intermediate calculations.

Parsing of XML data into the XDM and validating the data against a schema occur before data is processed by XQuery. During data model generation, the input XML document is parsed and converted into an instance of the XDM. The document can be parsed with or without validation.

The XDM is described in terms of sequences of atomic values and nodes.

### Sequences and items

An instance of the XQuery and XPath data model (XDM) is a sequence. A *sequence* is an ordered collection of zero or more items. An *item* is either an atomic value or a node.

A sequence can contain nodes, atomic values, or any mixture of nodes and atomic values. For example, each entry in the following list is a sequence:

- 36
- <dog/>
- (2, 3, 4)
- (36, <dog/>, "cat")
- ()

In addition the entries in the list, an XML document stored in an XML column in a DB2 database is a sequence.

The examples use a notation to represent sequences that is consistent with the syntax that is used to construct sequences in XQuery:

- Each item in the sequence is separated by a comma.
- An entire sequence is enclosed in parentheses.
- A pair of empty parentheses represents an empty sequence.
- A single item that appears on its own is equivalent to a sequence that contains one item.

For example, there is no distinction between the sequence (36) and the atomic value 36.

Sequences cannot be nested. When two sequences are combined, the result is always a flattened sequence of nodes and atomic values. For example, appending the sequence (2, 3) to the sequence (3, 5, 6) results in the single sequence (3, 5, 6, 2, 3). Combining these sequences does not produce the sequence (3, 5, 6, (2, 3)) because nested sequences never occur.

A sequence that contains zero items is called an *empty sequence*. Empty sequences can be used to represent missing or unknown information.

## Atomic values

An *atomic value* is an instance of one of the built-in atomic data types that are defined by XML Schema. These data types include strings, integers, decimals, dates, and other atomic types. These types are described as atomic because they cannot be subdivided.

Unlike nodes, atomic values do not have an identity. Every instance of an atomic value (for example, the integer 7) is identical to every other instance of that value.

The following examples are some of ways that atomic values are made:

- Extracted from nodes through a process called atomization. Atomization is used by expressions whenever a sequence of atomic values is required.
- Specified as a numeric or string literal. Literals are interpreted by XQuery as atomic values. For example, the following literals are interpreted as atomic values:
  - "this is a string" (type is xs:string)
  - 45 (type is xs:integer)
  - 1.44 (type is xs:decimal)
- Computed by constructor functions. For example, the following constructor function builds a value of type xs:date out of the string "2005-01-01":

```
xs:date("2005-01-01")
```
- Returned by the built-in functions fn:true() and fn:false(). These functions return the boolean values true and false. These values cannot be expressed as literals.
- Returned by many kinds of expressions, such as arithmetic expressions and logical expressions.

## Node hierarchies

The nodes of a sequence form one or more *hierarchies*, or *trees*, that consist of a root node and all of the nodes that are reachable directly or indirectly from the root node.

Every node belongs to exactly one hierarchy, and every hierarchy has exactly one root node. DB2 supports six node kinds: document, element, attribute, text, processing instruction, and comment.

The following XML document, `products.xml`, includes a root element, named `products`, which contains product elements. Each product element has an attribute named `pid` (product ID) and a child element named `description`. The `description` element contains child elements named `name` and `price`.

```
<products>
  <product pid="10">
    <description>
      <name>Fleece jacket</name>
      <price>19.99</price>
    </description>
  </product>
  <product pid="11">
    <description>
      <name>Nylon pants</name>
      <price>9.99</price>
    </description>
  </product>
</products>
```

Figure 3 shows a simplified representation of the data model for `products.xml`. The figure includes a document node (D), element nodes (E), attribute nodes (A), and text nodes (T).

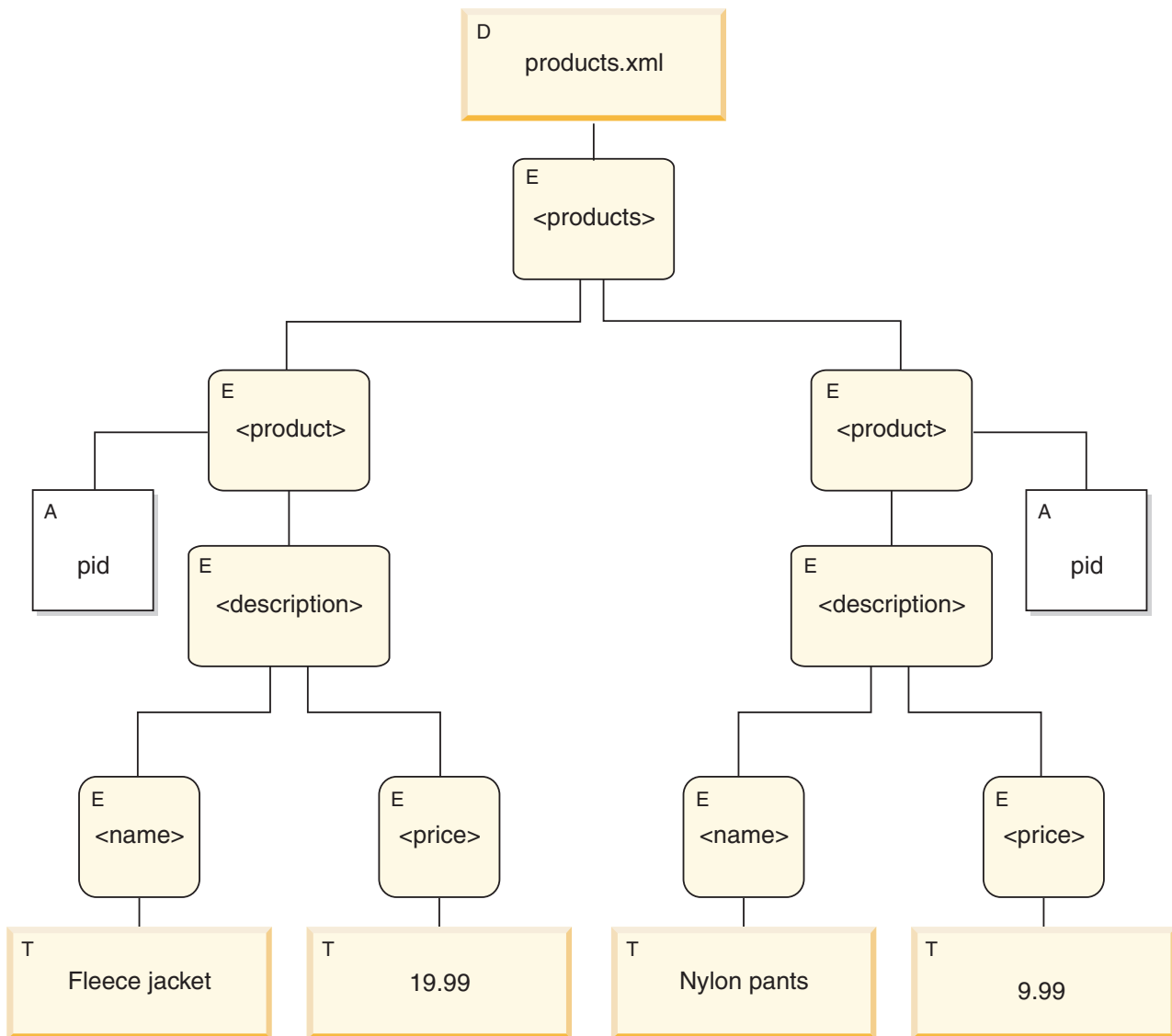

Figure 3. Data model diagram for `products.xml` document

As the example illustrates, a node can have other nodes as children, thus forming one or more *node hierarchies*. In the example, the element `product` is a child of `products`. The element `description` is a child of `product`. The elements `name` and `price` are children of the element `description`. The text node with the value `Fleece Jacket` is a child of the element `name`, and the text node `19.99` is a child of the element `price`.

## Node properties

Each node has *properties* that describe characteristics of that node. For example, a node's properties might include the name of the node, its children, its parent, its attributes, and other information that describes the node. The node kind determines which properties are present for specific nodes.

A node can have one or more of the following properties:

**node-name**

The name of the node, expressed as a QName.

**parent** The node that is the parent of the current node.

**type-name**

The dynamic (run-time) type of the node (also known as the *type annotation*).

**children**

The sequence of nodes that are children of the current node.

**attributes**

The set of attribute nodes that belong to the current node.

**string-value**

A string value that can be extracted from the node.

**typed-value**

A sequence of zero or more atomic values that can be extracted from the node.

**in-scope namespaces**

The in-scope namespaces that are associated with the node.

**content**

The content of the node.

## Node kinds

DB2 supports six node kinds: document, element, attribute, text, processing instruction, and comment.

### Document nodes

A document node encapsulates an XML document.

A document node can have zero or more children. The children can include element nodes, processing instruction nodes, comment nodes, and text nodes.

The string value of a document node is equal to the concatenated contents of all its descendant text nodes in document order. The type of the string value is `xs:string`. The typed value of a document node is the same as its string value, except that the type of the typed value is `xdt:untypedAtomic`.

A document node has the following node properties:

- children, possibly empty
- string-value
- typed-value

Document nodes can be constructed in XQuery expressions by using computed constructors. A sequence of document nodes can also be returned by the `db2-fn:xmlcolumn` function.

### Element nodes

An element node encapsulates an XML element.

An element can have zero or one parent and zero or more children. The children can include element nodes, processing instruction nodes, comment nodes, and text

nodes. Document and attribute nodes are never children of element nodes. However, an element node is considered to be the parent of its attributes. The attributes of an element node must have unique QNames.

An element node has the following node properties:

- node-name
- parent, possibly empty
- type-name
- children, possibly empty
- attributes, possibly empty
- string-value
- typed-value
- in-scope-namespaces

Element nodes can be constructed in XQuery expressions by using direct or computed constructors.

The type-name property of an element node indicates the relationship between its typed value and its string value. For example, if an element node has the type-name property `xs:decimal` and the string value "47.5", the typed value is the decimal value 47.5. If the type-name property of an element node is `xdt:untyped`, the element's typed value is equal to its string value and has the type `xdt:untypedAtomic`.

### **Attribute nodes**

An attribute node represents an XML attribute.

An attribute node can have zero or one parent. The element node that owns an attribute is considered to be its parent, even though an attribute node is not a child of its parent element.

An attribute node has the following node properties:

- node-name
- parent, possibly empty
- type-name
- string-value
- typed-value

Attribute nodes can be constructed in XQuery expressions by using direct or computed constructors.

The type-name property of an attribute node indicates the relationship between its typed value and its string value. For example, if an attribute node has the type-name property `xs:decimal` and the string value "47.5", its typed value is the decimal value 47.5.

### **Text nodes**

A text node encapsulates XML character content.

A text node can have zero or one parent. Text nodes that are children of a document or element node never appear as adjacent siblings. When a document or element node is constructed, any adjacent text node siblings are combined into a single text node. If the resulting text node is empty, it is discarded.



Text nodes have the following node properties:

- content, possibly empty
- parent, possibly empty

Text nodes can be constructed in XQuery expressions by computed constructors or by the action of a direct element constructor.

### Processing instruction nodes

A processing instruction node encapsulates an XML processing instruction.

A processing instruction node can have zero or one parent. The content of a processing instruction cannot include the string `?>`. The target of a processing instruction must be an NCName. The target is used to identify the application to which the instruction is directed.

A processing instruction node has the following node properties:

- target
- content
- parent, possibly empty

Processing instruction nodes can be constructed in XQuery expressions by using direct or computed constructors.

### Comment nodes

A comment node encapsulates an XML comment.

A comment node can have zero or one parent. The content of a comment node cannot include the string `--` (two hyphens) or contain the hyphen character ( `-` ) as the last character.

A comment node has the following node properties:

- content
- parent, possibly empty

Comment nodes can be constructed in XQuery expressions by using direct or computed constructors.

## Document order of nodes

All of the nodes in a hierarchy conform to an order, called *document order*, in which each node appears before its children. Document order corresponds to the order in which the nodes would appear if the node hierarchy were represented in serialized XML.

Nodes in a hierarchy appear in the following order:

- The root node is the first node.
- Element nodes occur before their children.
- Attribute nodes immediately follow the element node with which they are associated. The relative order of attribute nodes is arbitrary, but this order does not change during the processing of a query.
- The relative order of siblings is determined by their order in the node hierarchy.
- Children and descendants of a node occur before siblings that follow the node.

## Node identity

Each node has a unique identity. Two nodes are distinguishable even though their names and values might be the same. In contrast, atomic values do not have an identity.

Node identity is not the same as an ID-type attribute. An element in an XML document can be given an ID-type attribute by the document author. A node identity, however, is automatically assigned to every node by the system but is not directly visible to users.

Node identity is used to process the following types of expressions:

- Node comparisons. Node identity is used by the **is** operator to determine if two nodes have the same identity.
- Path expressions. Node identity is used by path expressions to eliminate duplicate nodes.
- Sequence expressions. Node identity is used by the **union**, **intersect**, or **except** operators to eliminate duplicate nodes.

## Typed values and string values of nodes

Each node has both a *typed value* and a *string value*. These two node properties are used in the definitions of certain XQuery operations (such as atomization) and functions (such as `fn:data`, `fn:string`, and `fn:deep-equal`).

Table 1. String values and typed values of nodes

Node kind	String value	Typed value
Document	An instance of the <code>xs:string</code> data type that is the concatenated contents of all its descendant text nodes, in document order.	An instance of the <code>xdt:untypedAtomic</code> data type that is the concatenated contents of all its descendant text nodes, in document order.
Element in an XML document	An instance of the <code>xs:string</code> data type that is the concatenated contents of all its text node descendants in document order.	An instance of the <code>xdt:untypedAtomic</code> data type that is the concatenated contents of all its text node descendants in document order.
Attribute in an XML document	An instance of the <code>xs:string</code> data type that represents the attribute value in the original XML document.	An instance of the <code>xdt:untypedAtomic</code> data type that represents the attribute value in the original XML document.
Text	The content as an instance of the <code>xs:string</code> data type.	The content as an instance of the <code>xdt:untypedAtomic</code> data type.
Comment	The content as an instance of the <code>xs:string</code> data type.	The content as an instance of the <code>xs:string</code> data type.
Processing instruction	The content as an instance of the <code>xs:string</code> data type.	The content as an instance of the <code>xs:string</code> data type.

---

## Tools that support XML

Both IBM and third-party tools provide support for working with the pureXML feature. Shipped with DB2 database server, or available separately for download, the following tools are available to you from IBM:

**IBM Data Studio:** Support for XML includes the following:

- **Stored procedures:** You can create and run stored procedures that contain XML data types as input or output parameters.
- **Data output:** You can view documents contained in XML columns as a tree or text.

- **SQL editor:** You can create SQL statements and XQuery expressions that work with both relational and XML data.
- **XML schemas:** You can manage schema documents in the XML schema repository (XSR), including registering and dropping schemas, as well as editing schema documents.
- **XML document validation:** You can perform validation of XML documents against schemas registered in the XSR.
- **SQL user-defined functions:** You can create and run SQL user-defined functions that use XML parameters.

**Command line processor:** Several DB2 commands support the native storage of XML data. You can work with XML data alongside relational data from the DB2 command line processor (CLP). Examples of tasks that you can perform from the CLP include:

- Issuing XQuery statements by prefixing them with the XQUERY keyword.
- Importing and exporting XML data.
- Collecting statistics on XML columns.
- Calling stored procedures with IN, OUT, or INOUT parameters of XML data type.
- Working with the XML schemas, DTDs, and external entities required to process XML documents.
- Reorganizing indexes over XML data and tables containing XML columns.
- Decomposing XML documents.

**IBM Database Add-Ins for Microsoft Visual Studio:** You can use the IBM Database Add-Ins for Microsoft Visual Studio to create tables with XML columns and indexes over XML data. You create an XML column as you would any other column in this tool. Simply specify the data type as XML. You can create an index by using the XML Index Designer in this tool. You do not have to manually specify the XML pattern expression as required by the CREATE INDEX syntax for an index over XML data. Instead, you can graphically select the XML nodes that you want to index from either a tree representation of a registered XML schema, a document from the XML column, or an XML schema in a local file. The tool generates the XML pattern expression for you. Alternatively, you can manually specify the XML pattern expression. After you have specified all of the other index attributes, the tool generates the index for you.

**EXPLAIN:** You can issue the EXPLAIN statement on XQuery statements and SQL/XML statements to quickly see the access plan for these statements, including whether DB2 database server uses indexes. To issue the EXPLAIN statement for an XQuery statement, use the XQuery keyword followed by an XQuery statement that is enclosed in single or double quotation marks, as in the following example:

```
EXPLAIN PLAN SELECTION FOR XQUERY 'for $c in
db2-fn:xmlcolumn("XISCANTABLE.XMLCOL" )/a[@x="1"]/b[@y="2"] return $c'
```

DB2 captures the access plan information in the EXPLAIN tables. The expected sequence size for any XML columns are stored in the SEQUENCE\_SIZES column of the EXPLAIN\_STREAM table. You might also notice data in the EXPLAIN\_PREDICATE table for several predicates that you do not recognize. These predicates are generated by the DB2 database server during the EXPLAIN operation to evaluate XPath expressions that are used in an index scan. You do not

need to evaluate this predicate information. These predicates not part of the optimizer plan and thus have a value of -1 in the PREDICATE\_ID and FILTER\_FACTOR columns.

Alternatively, you can avoid manually interpreting the EXPLAIN tables by using the Visual Explain tool to view graphical depictions of these access plans. The following nodes are displayed in the graphs to show XML operations:

**IXAND**

Indicates that the DB2 database server applied the AND predicate to the results of multiple index scans.

**XISCAN**

Indicates that the DB2 database server used an index over XML data to access the data.

**XSCAN**

Indicates that the DB2 database server evaluated XPath expressions and extracted XML document fragments from XML documents.

**XANDOR**

Indicates that the DB2 database server applied the AND and OR predicates to the results of multiple index scans.

**XTQ**

Indicates that the DB2 database server used a special table queue (TQ) to route each item in a global XML sequence to its original database partition, retrieve XML data from XML documents based on the evaluation of the item, and aggregate XML data into an output sequence.

---

## Federation support for pureXML

In a federated environment you can work with remote data sources that contain XML documents stored in XML columns. You can both query and manipulate remote XML data, including decomposing XML documents into remote tables.

Before you can work with remote XML data, you need to create a nickname for the remote table that contains the XML column where the documents you want to work with are stored.

For more information on setting up a federated system that includes XML data sources, see "Working with remote XML data" in the Federation Server documentation.

---

## Replication and event publishing support for pureXML

WebSphere® Replication Server and WebSphere® Data Event Publisher support for the XML data type allows you to replicate and publish XML documents that are stored in XML columns.

You can use Q replication to replicate XML documents between databases, or you can use event publishing to publish documents to applications.

For more information on setting up Q replication and event publishing for databases that include XML documents stored in XML columns, see "XML data type" and parent topics in the WebSphere Replication Server and WebSphere Data Event Publisher documentation.

---

## Articles on XML support

Additional articles on leveraging XML support are available through developerWorks® Information Management. These articles cover a broad range of topics, including migration and data movement, general overviews, step-by-step tutorials, and best practices for working with XML data.

The articles are available at [www.ibm.com/developerworks/data/zones/xml/](http://www.ibm.com/developerworks/data/zones/xml/).

**Note:** developerWorks is not part of the DB2 Information Center. This link will open outside of the DB2 Information Center.



---

## Chapter 2. pureXML tutorial

You can use the pureXML XML data type to define table columns so that you can store a single, well-formed XML document in each row. This tutorial demonstrates how to set up a DB2 database to store XML data and to perform basic operations with the pureXML feature.

After completing this tutorial, you will be able to do the following tasks:

- Create a DB2 database and table that can store XML data
- Create indexes over XML data
- Insert XML documents into XML typed columns
- Update XML documents stored in an XML column
- Delete rows based on the content of XML documents
- Query XML data
- Validate XML documents against XML schemas
- Transform XML documents with XSLT stylesheets

Application programming languages such as C++, Java, and PHP support the XML data type. You can write applications to store XML data in DB2 databases tables, retrieve data from tables, or call stored procedures or user-defined functions with XML parameters.

This tutorial is written for a single-partition database environment, however you can also use the pureXML feature in a partitioned database environment.

### Prerequisites

In a DB2 command window, start the DB2 command-line processor by issuing the `db2 -td~` command, the **db2** command with the `-td~` option.<sup>1</sup>

The `-td` option sets the tilde (~) as the statement termination character. Specifying a termination character other than the default semicolon (`-t` option) ensures that statements or queries that use namespace declarations are not misinterpreted, because namespace declarations are also terminated by a semicolon. The examples throughout this tutorial use the ~ termination character.

You can enter or copy and paste the examples in the lessons into the DB2 command-line processor, in interactive mode.

**Namespaces:** The XML documents used in the tutorial contain namespaces. When using XML documents that contain namespaces, all queries and associated operations that specify a namespace, such as creating an index over XML data by using the CREATE INDEX statement or querying XML data using an XQuery expression, must declare the same namespace to yield expected results. Declaring namespaces when using XML documents that contain namespaces is standard namespace behavior.

---

1. On Windows operating systems, use the `db2cmd` command to start a DB2 command window before issuing the `db2 -td~` command.

---

## Lesson 1: Creating a DB2 database and table that can store XML data

This lesson shows you how to create a database with a table that contains an XML column.

In the tutorial, you store XML data in a table that contains a table with a column of type XML. Follow these steps to create the database and table used in the tutorial:

1. Create a database called XMLTUT by issuing the following command:

```
CREATE DATABASE xmltut~
```

By default, databases use the UTF-8 (Unicode) code set. If you choose to store XML data in a database with a code set other than UTF-8, it is best to insert this data in a form that does not undergo code page conversion, such as BIT DATA, BLOB, or XML. To block the use of character data types during XML parsing, preventing possible character substitution from occurring, set the **ENABLE\_XMLCHAR** configuration parameter to **NO**.

2. Connect to the database:

```
CONNECT TO xmltut~
```

3. Create a table named Customer that contains an XML column called INFO:

```
CREATE TABLE Customer (Cid BIGINT NOT NULL PRIMARY KEY, Info XML)~
```

A primary key is not required to store or index XML data.

You can also add one or more XML columns to a table by using the ALTER TABLE SQL statement.

Return to the tutorial

---

## Lesson 2: Creating indexes over XML data

This lesson shows you how to create an index over XML data. Indexes over XML data can improve the performance of queries on XML columns. Index XML elements or attributes that you frequently use in predicates and cross-document joins.

A relational index and an index over XML data both index a column. However, a relational index indexes an entire column, and an index over XML data indexes part of a column. You indicate which parts of an XML column to index by specifying an XML pattern, which is a limited XPath expression. You also must specify the data type that the indexed values will be stored as. Generally, the type that you choose should be the same type that you use in queries.

Like relational indexes, it is recommended that you index XML elements or attributes that are frequently used in predicates and cross-document joins.

You can index only a single XML column; composite indexes are not supported. You can have multiple indexes on an XML column, however.

Not all clauses of the CREATE INDEX statement apply to indexes over XML data. Refer to the CREATE INDEX statement for details.

To create an index over XML data, issue the following statement:

```
CREATE INDEX cust_cid_xmlidx ON Customer(Info)
GENERATE KEY USING XMLPATTERN
  'declare default element namespace "http://posample.org"; /customerinfo/@Cid'
AS SQL DOUBLE~
```



The statement indexes the values of the Cid attribute of <customerinfo> elements from the INFO column of the CUSTOMER table. As the default, when the XML data is indexed, if the XML data fails to cast to the specified data type, SQL DOUBLE, no index entry is created, and no error is returned.

The XML pattern that you specify is case sensitive. If, for example, the XML documents contained the attribute cid instead of Cid, those documents would not match this index.

Return to the tutorial

---

## Lesson 3: Inserting XML documents into XML type columns

Well-formed XML documents are inserted into XML typed columns using the INSERT SQL statement. This lesson shows you how to insert well-formed XML documents into XML columns by using the INSERT SQL statement.

This lesson shows how to insert XML documents into XML type columns manually, by using the command-line processor. Typically, however, XML documents are inserted by using application programs.

Although you can insert XML data by using XML, binary, or character types, to avoid code page conversion issues, use XML or binary types. In this lesson, the XML documents are character literals. In most cases, you cannot directly assign string data to a target with an XML data type; you must first explicitly parse the data by using the XMLPARSE function. In INSERT, UPDATE, or DELETE operations, however, you can assign string data directly to XML columns, without an explicit call to the XMLPARSE function. In these three cases, the string data is implicitly parsed. Refer to the XML parsing documentation for more information.

To insert three XML documents into the Customer table that you created in Lesson 1, issue the following statements:

```
INSERT INTO Customer (Cid, Info) VALUES (1000,  
'<customerinfo xmlns="http://posample.org" Cid="1000">  
  <name>Kathy Smith</name>  
  <addr country="Canada">  
    <street>5 Rosewood</street>  
    <city>Toronto</city>  
    <prov-state>Ontario</prov-state>  
    <pcode-zip>M6W 1E6</pcode-zip>  
  </addr>  
  <phone type="work">416-555-1358</phone>  
</customerinfo>')~
```

```
INSERT INTO Customer (Cid, Info) VALUES (1002,  
'<customerinfo xmlns="http://posample.org" Cid="1002">  
  <name>Jim Noodle</name>  
  <addr country="Canada">  
    <street>25 EastCreek</street>  
    <city>Markham</city>  
    <prov-state>Ontario</prov-state>  
    <pcode-zip>N9C 3T6</pcode-zip>  
  </addr>  
  <phone type="work">905-555-7258</phone>  
</customerinfo>')~
```

```
INSERT INTO Customer (Cid, Info) VALUES (1003,  
'<customerinfo xmlns="http://posample.org" Cid="1003">  
  <name>Robert Shoemaker</name>  
  <addr country="Canada">
```

```

    <street>1596 Baseline</street>
    <city>Aurora</city>
    <prov-state>Ontario</prov-state>
    <pcode-zip>N8X 7F8</pcode-zip>
  </addr>
  <phone type="work">905-555-2937</phone>
</customerinfo>')~

```

To confirm that the records were successfully inserted, issue the following statement:

```
SELECT * from Customer~
```

Return to the tutorial

## Lesson 4: Updating XML documents stored in XML columns

This lesson shows you how to update XML documents by using an UPDATE SQL statement with or without an XQuery updating expression.

### Updating without an XQuery updating expression

If you use the UPDATE statement without an XQuery updating expression, you must perform a full-document update.

To update the values of the <street>, <city>, and <pcode-zip> elements for one of the documents that you inserted in Lesson 3, issue the following statement:

```

UPDATE customer SET info =
'<customerinfo xmlns="http://posample.org" Cid="1002">
  <name>Jim Noodle</name>
  <addr country="Canada">
    <street>1150 Maple Drive</street>
    <city>Newtown</city>
    <prov-state>Ontario</prov-state>
    <pcode-zip>Z9Z 2P2</pcode-zip>
  </addr>
  <phone type="work">905-555-7258</phone>
</customerinfo>'
WHERE XMLEXISTS (
  'declare default element namespace "http://posample.org";
  $doc/customerinfo[@Cid = 1002]'
  passing INFO as "doc")~

```

The XMLEXISTS predicate ensures that only the document containing the attribute Cid="1002" is replaced. Notice how the predicate expression in XMLEXISTS, [@Cid = 1002], is not specified as a string comparison: [@Cid = "1002"]. The reason is that you used the DOUBLE data type when you created the index for the Cid attribute in Exercise 2. For the index to match this query, you cannot specify Cid as a string in the predicate expression.

To confirm that the XML document was updated, issue the following statement:

```
SELECT * from Customer~
```

The record containing Cid="1002" contains the changed <street>, <city>, and <pcode-zip> values.

If you can identify XML documents in a table by using values in the non-XML columns of the same table, you can use SQL comparison predicates to identify which rows to update. In the previous example, where the Cid value from the XML document is also stored in the CID column of the CUSTOMER table, you

could have used an SQL comparison predicate on the CID column to identify the row. In the previous example, you can replace the WHERE clause with the following clause:

```
WHERE Cid=1002
```

## Updating with an XQuery updating expression

If you use the UPDATE statement with an XQuery updating expression, you can update portions of an existing XML document.

To update the customer address in an existing XML document, issue the following SQL statement, which uses an XQuery transform expression:

```
UPDATE Customer set Info =
  XMLQUERY( 'declare default element namespace "http://posample.org";
  transform
  copy $mycust := $cust
  modify
  do replace $mycust/customerinfo/addr with
    <addr country="Canada">
      <street>25 EastCreek</street>
      <city>Markham</city>
      <prov-state>Ontario</prov-state>
      <pcode-zip>N9C 3T6</pcode-zip>
    </addr>
  return $mycust'
  passing INFO as "cust")
WHERE CID = 1002~
```

To update the customer address, the XMLQUERY function executes an XQuery transform expression that uses a replace expression and then returns the updated information to the UPDATE statement, as follows:

- The XMLQUERY passing clause uses the identifier cust to pass the customer information to the XQuery expression from the XML column INFO.
- In the **copy** clause of the transform expression, a logical snapshot of the customer information is taken and assigned to the \$mycust variable.
- In the **modify** clause of the transform expression, the replace expression replaces the address information in the copy of the customer information.
- XMLQUERY returns the updated customer document in the \$mycust variable.

To confirm that the XML document contains the updated customer address, issue the following statement:

```
SELECT Info FROM Customer WHERE Cid = 1002~
```

Return to the tutorial

---

## Lesson 5: Deleting XML data

This lesson shows you how to use SQL statements to delete entire XML documents or only sections of XML documents.

### Deleting entire XML documents

To delete entire XML documents, use the DELETE SQL statement. Use the XMLEXISTS predicate to identify particular documents to delete.

To delete only XML documents that have a <customerinfo> element with an attribute Cid=1003 from the Info column, issue the following statement:

```
DELETE FROM Customer
WHERE XMLEXISTS (
  'declare default element namespace "http://posample.org";
  $doc/customerinfo[@Cid = 1003]'
  passing INFO as "doc")~
```

If you can identify XML documents in a table by using values in the non-XML columns of the same table, you can use SQL comparison predicates to identify which rows to delete. In the previous example, where the Cid value from the XML document is also stored in the CID column of the CUSTOMER table, you could have performed the same operation by using the following DELETE statement, which applies an SQL comparison predicate to the CID column to identify the row:

```
DELETE FROM Customer WHERE Cid=1003~
```

To confirm that the XML documents were deleted, issue the following SQL statement:

```
SELECT * FROM Customer~
```

Two records are returned.

## Deleting sections of XML documents

To delete only sections of an XML document instead of deleting the entire document, use an UPDATE SQL statement that contains a delete XQuery updating expression.

To delete all phone information from a customer record where the value of Cid is 1002, issue the following SQL statement, which uses the XMLQUERY function:

```
UPDATE Customer
SET info = XMLQUERY(
  'declare default element namespace "http://posample.org";
  transform
  copy $newinfo := $info
  modify do delete ($newinfo/customerinfo/phone)
  return $newinfo' passing info as "info")
WHERE cid = 1002~
```

To remove the <phone> element, the XMLQUERY function executes an XQuery transform expression that uses a delete expression and then returns the updated information to the UPDATE statement, as follows:

- The XMLQUERY passing clause uses the identifier `info` to pass the customer information to the XQuery expression from the XML column INFO.
- In the **copy** clause of the transform expression, a logical snapshot of the customer information is taken and assigned to the `$newinfo` variable.
- In the **modify** clause of the transform expression, the delete expression deletes the <phone> element in the copy of the customer information.
- XMLQUERY returns the updated customer document in the `$newinfo` variable.

To confirm that the customer record no longer contains a <phone> element, issue the following statement:

```
SELECT * FROM Customer WHERE Cid=1002~
```

Return to the tutorial

---

## Lesson 6: Querying XML data

This lesson shows you how to query XML data by using SQL, XQuery (with XQuery expressions), or a combination of both.

If you use only SQL, you can query only at the column level. That is, you can return an entire XML document stored in the column, but you cannot query within the document or return fragments of the document. To query values within an XML document or return fragments of a document, you must use XQuery.

The queries in this lesson use XQuery in an SQL context and SQL in an XQuery context.

**Important:** XQuery is case sensitive, but SQL is not. Therefore, when using XQuery, carefully specify names such as table and SQL schema names, which are both uppercase by default. Even in an SQL context, XQuery expressions remain case sensitive.

### Querying in an SQL context

#### Retrieving entire XML documents

To retrieve all of the XML documents stored in the column named INFO and values from the CID primary key column, issue the following SELECT statement:

```
SELECT cid, info FROM customer~
```

This query returns the two stored XML documents.

#### Retrieving and filtering XML values

To query within the XML documents in the INFO column, issue the following SELECT statement, which uses the XMLQUERY function to invoke an XQuery expression:

```
SELECT XMLQUERY (  
  'declare default element namespace "http://posample.org";  
  for $d in $doc/customerinfo  
  return <out>{$d/name}</out>'  
  passing INFO as "doc")  
FROM Customer as c  
WHERE XMLEXISTS ('declare default element namespace "http://posample.org";  
  $i/customerinfo/addr[city="Toronto"]' passing c.INFO as "i")~
```

In the XMLQUERY function, a default namespace is first specified. This namespace matches the namespace of the documents previously inserted. The **for** clause specifies iteration through the <customerinfo> elements in each document from the Info column. The INFO column is specified by using the **passing** clause, which binds the INFO column to the variable named doc that is referenced in the **for** clause. The **return** clause then constructs an <out> element, which contains the <name> element from each iteration of the **for** clause.

The WHERE clause uses the XMLEXISTS predicate to consider only a subset of the documents in the Info column. This filtering yields only those documents that have a <city> element (along the path specified) with a value of Toronto.

The SELECT statement returns the following constructed element:

```
<out xmlns="http://posample.org"><name>Kathy Smith</name></out>
```

#### Using db2-fn:sqlquery with parameters

To pass a value to the SQL fullselect in the db2-fn:sqlquery function, run the following query:

```
VALUES XMLQUERY (  
  'declare default element namespace "http://posample.org";  
  for $d in db2-fn:sqlquery(  
    'SELECT INFO FROM CUSTOMER WHERE Cid = parameter(1)',  
    $testval)/customerinfo  
  return <out>{$d/name}</out>'  
  passing 1000 as "testval" )~
```

The XMLQUERY function passes the value 1000 to the XQuery expression by using the identifier testval. The XQuery expression then passes the value to the db2-fn:sqlquery function by using the PARAMETER scalar function.

The XQuery expression returns the following constructed element:

```
<out xmlns="http://posample.org">  
  <name>Kathy Smith</name>  
</out>
```

## Querying in an XQuery context

DB2 XQuery offers two built-in functions specifically for use with DB2 databases: db2-fn:sqlquery and db2-fn:xmlcolumn. db2-fn:sqlquery retrieves a sequence that is the result table of an SQL fullselect. db2-fn:xmlcolumn retrieves a sequence from an XML column.

If your query invokes an XQuery expression directly, you must prefix it with the case-insensitive keyword XQUERY.

**Note:** There are several options that you can set to customize your command-line processor environment, particularly for displaying the results of an XQuery expression. For example, set the **-i** option to make the results from XQuery expressions easier to read, as follows:

```
UPDATE COMMAND OPTIONS USING i ON~
```

### Retrieving entire XML documents

To retrieve all of the XML documents previously inserted into the INFO column, you can use XQuery with either db2-fn:xmlcolumn or db2-fn:sqlquery.

#### Using db2-fn:xmlcolumn

To retrieve all XML documents in the INFO column, run the following query:

```
XQUERY db2-fn:xmlcolumn ('CUSTOMER.INFO')~
```

Names in SQL statements are automatically converted to uppercase by default. Therefore, when you created the CUSTOMER table by using the CREATE TABLE SQL statement, the names of the table and columns were made uppercase. Because XQuery is case sensitive, you must be careful to use the correct case when specifying the table and column names when using db2-fn:xmlcolumn.

This query is equivalent to the SQL query SELECT Info FROM Customer.

### Using db2-fn:sqlquery

To retrieve all XML documents in the INFO column, run the following query:

```
XQUERY db2-fn:sqlquery ('SELECT Info FROM Customer')~
```

You do not have to specify the INFO and CUSTOMER names in uppercase because the SELECT statement is processed in an SQL context and is therefore not case sensitive.

### Retrieving partial XML documents

Instead of retrieving an entire XML document, you can retrieve fragments of the document and filter on values present in the document by using XQuery with either db2-fn:xmlcolumn or db2-fn:sqlquery.

### Using db2-fn:xmlcolumn

To return elements containing <name> nodes for all documents in the Info column that have a <city> element (along the path specified) with a value of Toronto, run the following query:

```
XQUERY declare default element namespace "http://posample.org";
for $d in db2-fn:xmlcolumn('CUSTOMER.INFO')/customerinfo
where $d/addr/city="Toronto"
return <out>{$d/name}</out>~
```

The db2-fn:xmlcolumn function retrieves a sequence from the INFO column of the CUSTOMER table. The **for** clause binds the variable \$d to each <customerinfo> element in the CUSTOMER.INFO column. The **where** clause restricts the items to only those that have a <city> element (along the path specified) with a value of Toronto. The **return** clause constructs the returned XML value. This value is an element <out> that contains the <name> element for all documents that satisfy the condition specified in the **where** clause, as follows:

```
<out xmlns="http://posample.org">
<name>
    Kathy Smith
</name>
</out>
```

### Using db2-fn:sqlquery

To issue a fullselect within an XQuery expression, run the following query:

```
XQUERY declare default element namespace "http://posample.org";
for $d in db2-fn:sqlquery(
'SELECT INFO
FROM CUSTOMER
WHERE Cid < 2000')/customerinfo
where $d/addr/city="Toronto"
return <out>{$d/name}</out>~
```

In this example, the set of XML documents being queried is first restricted, in the fullselect, by particular values in the non-XML CID column. This example demonstrates an advantage of db2-fn:sqlquery: it allows SQL predicates to be applied within an XQuery expression. The documents that result from the SQL query are then further restricted in the **where** clause of the XQuery expression to those documents that have a <city> element (along the path specified) with a value of Toronto.

The query yields the same results as in the previous example, which used `db2-fn:xmlcolumn`:

```
<out xmlns="http://posample.org">
<name>
    Kathy Smith
</name>
</out>
```

### Using `db2-fn:sqlquery` with parameters

To pass a value to the SQL fullselect in the `db2-fn:sqlquery` function, run the following query:

```
XQUERY declare default element namespace "http://posample.org";
let $testval := 1000
for $d in db2-fn:sqlquery(
    'SELECT INFO FROM CUSTOMER WHERE Cid = parameter(1)',
    $testval)/customerinfo
return <out>{$d/name}</out>~
```

In the XQuery expression, the **let** clause sets the value of `$testval` to 1000. In the **for** clause, the expression then passes the value to the `db2-fn:sqlquery` function using the `PARAMETER` scalar function.

The XQuery expression returns the following constructed element:

```
<out xmlns="http://posample.org">
    <name>Kathy Smith</name>
</out>
```

[Return to the tutorial](#)

---

## Lesson 7: Validating XML documents against XML schemas

This lesson shows you how to validate XML documents. You can validate your XML documents against XML schemas only; validation against DTDs is not supported. However, although you cannot validate against DTDs, you can insert documents that contain a `DOCTYPE` or that refer to DTDs.

You can use tools such as those in IBM Rational® Application Developer to help generate XML schemas from various sources, including DTDs, tables, and XML documents.

Before you can validate, you must register your XML schema with the built-in XML schema repository (XSR). This process involves registering each XML schema document that makes up the XML schema and then completing the registration. One method of registering an XML schema is through commands.

To register the schema document and complete the registration of the `posample.customer` XML schema, run the following command. (Because this XML schema consists of only one schema document, you can use a single command to both register the document and complete the registration.) The command specifies the absolute path to the `sqllib/samples/xml` directory. If the path on your system does not begin with `c:/sqllib/`, modify the file path in the command accordingly.

```
REGISTER XMLSCHEMA 'http://posample.org'
FROM 'file:///c:/sqllib/samples/xml/customer.xsd' AS posample.customer COMPLETE~
```

You can verify that the XML schema was successfully registered by querying the `SYSCAT.XSROBJECTS` catalog view, which contains information about objects stored in the XSR. This query and its result, formatted for clarity, are as follows:



```
SELECT OBJECTSCHEMA, OBJECTNAME FROM SYSCAT.XSROBJECTS~
```

```
OBJECTSCHEMA      OBJECTNAME
-----
POSAMPLE          CUSTOMER
```

You can now use the XML schema for validation. You typically perform validation during an INSERT or UPDATE operation, using the XMLVALIDATE function. The INSERT or UPDATE operation for which you specify XMLVALIDATE occurs only if the validation succeeds.

To insert an XML document into the INFO column of the CUSTOMER table if the document is valid according to the posample.customer XML schema, issue the following statement:

```
INSERT INTO Customer(Cid, Info) VALUES (1003, XMLVALIDATE (XMLPARSE (DOCUMENT
'<customerinfo xmlns="http://posample.org" Cid="1003">
  <name>Robert Shoemaker</name>
  <addr country="Canada">
    <street>1596 Baseline</street>
    <city>Aurora</city>
    <prov-state>Ontario</prov-state>
    <pcode-zip>N8X 7F8</pcode-zip>
  </addr>
  <phone type="work">905-555-7258</phone>
  <phone type="home">416-555-2937</phone>
  <phone type="cell">905-555-8743</phone>
  <phone type="cottage">613-555-3278</phone>
</customerinfo>' PRESERVE WHITESPACE )
ACCORDING TO XMLSCHEMA ID posample.customer ))~
```

The XML document in this example is passed as character data. However, XMLVALIDATE operates only on XML data. Because the XML document is passed as character data, you must explicitly parse the data using the XMLPARSE function. The XMLPARSE function parses its argument as an XML document and returns an XML value.

The DB2 database server performs implicit parsing for some operations. For example, implicit parsing occurs when you assign a host variable, parameter marker, or SQL expression with a string data type (character, graphic or binary) to an XML column in an INSERT, UPDATE, DELETE, or MERGE statement. .

To verify that the validation and insert were successful, query the INFO column:

```
SELECT Info FROM Customer~
```

This query should return three XML documents, one of which is the document that you just inserted.

Return to the tutorial

---

## Lesson 8: Transforming with XSLT stylesheets

This lesson shows you how to use an Extensible Stylesheet Language Transformation (XSLT) stylesheet and the XSLTRANSFORM built-in function to convert XML data in a database into other formats.

Consider an XML document that contains an arbitrary number of university student records. Each student element contains a student's ID, given name, family name, age, and university that the student attends. The following document contains two students:

```
<?xml version="1.0"?>
<students xmlns:xsi="http://www.w3.org/2001/XMLSchema-instance">
  <student studentID="1" givenName="Steffen" familyName="Siegmund"
    age="21" university="Rostock"/>
  <student studentID="2" givenName="Helena" familyName="Schmidt"
    age="23" university="Rostock"/>
</students>
```

Also, assume that you want to extract the information in the XML records and create an HTML Web page that you can view in a browser. To transform the information, you require the following XSLT stylesheet:

```
<?xml version="1.0" encoding="UTF-8"?>
<xsl:stylesheet version="1.0"
  xmlns:xsl="http://www.w3.org/1999/XSL/Transform">
  <xsl:param name="headline"/>
  <xsl:param name="showUniversity"/>
  <xsl:template match="students">
    <html>
      <head/>
      <body>
        <h1><xsl:value-of select="$headline"/></h1>
        <table border="1">
          <thead>
            <tr>
              <th>
                <table border="1">
                  <tr>
                    <td width="80">StudentID</td>
                    <td width="200">Given Name</td>
                    <td width="200">Family Name</td>
                    <td width="50">Age</td>
                    <xsl:choose>
                      <xsl:when test="$showUniversity = 'true'">
                        <td width="200">University</td>
                      </xsl:when>
                    </xsl:choose>
                  </tr>
                </table>
              </th>
            </tr>
          </thead>
          <xsl:apply-templates/>
        </table>
      </body>
    </html>
  </xsl:template>
  <xsl:template match="student">
    <tr>
      <td><xsl:value-of select="@studentID"/></td>
      <td><xsl:value-of select="@givenName"/></td>
      <td><xsl:value-of select="@familyName"/></td>
      <td><xsl:value-of select="@age"/></td>
      <xsl:choose>
        <xsl:when test="$showUniversity = 'true'">
          <td><xsl:value-of select="@university"/></td>
        </xsl:when>
      </xsl:choose>
    </tr>
  </xsl:template>
</xsl:stylesheet>
```

To transform the data:

1. Create two tables into which you store the XML document and stylesheet document by running the following commands:

```
CREATE TABLE XML_DATA (DOCID INTEGER, XML_DOC XML )~
CREATE TABLE XML_TRANS (XSLID INTEGER, XSLT_DOC CLOB(1M))~
```

2. Insert the XML document and entire XSLT stylesheet into the tables by using the following INSERT statements.

For brevity, a truncated version of the XSLT stylesheet is shown in second INSERT statement in this step. Replace truncated stylesheet with the XSLT stylesheet listed previously before using the statement.

```
INSERT INTO XML_DATA VALUES
(1,
'<?xml version="1.0"?>
<students xmlns:xsi="http://www.w3.org/2001/XMLSchema-instance">
  <student studentID="1" givenName="Steffen" familyName="Siegmond"
    age="21" university="Rostock"/>
  <student studentID="2" givenName="Helena" familyName="Schmidt"
    age="23" university="Rostock"/>
</students>'
)~
```

```
INSERT INTO XML_TRANS VALUES
(1,
'<?xml version="1.0" encoding="UTF-8"?>
<xsl:stylesheet version="1.0"
...
</xsl:stylesheet>'
)~
```

3. Transform the XML document by calling the XSLTRANSFORM function:

```
SELECT XSLTRANSFORM (XML_DOC USING XSLT_DOC AS CLOB(1M))
FROM XML_DATA, XML_TRANS WHERE DOCID = 1 and XSLID = 1 ~
```

The output of the transformation is the following HTML file:

```
<html>
<head>
<META http-equiv="Content-Type" content="text/html; charset=UTF-8">
</head>
<body>
<h1></h1>
<table border="1">
<th>
<tr>
<td width="80">StudentID</td>
<td width="200">Given Name</td>
<td width="200">Family Name</td>
<td width="50">Age</td>
</tr>
</th>
<tr>
<td>1</td>
<td>Steffen</td><td>Siegmond</td>
<td>21</td>
</tr>
<tr>
<td>2</td><td>Helena</td><td>Schmidt</td>
<td>23</td>
</tr>
</table>
</body>
</html>
```

You might want to alter the behavior of the XSLT stylesheet at run time, either to add information not contained in the XML records or to change the nature of the output itself (to create XHTML output instead of standard HTML output, for example). To alter the behavior, you can pass parameters to the XSLT process by

using a parameter file. The parameter file is itself an XML document and contains param statements that correspond to similar statements in the XSLT stylesheet file.

Consider the following two parameters that are defined in the stylesheet but were not used in the previous transform:

```
<xsl:param name="showUniversity"/>
<xsl:param name="headline"/>
```

To transform the XML document using these parameters we store a parameters file in a table and use the file with the XSLTRANSFORM function.

1. Create the table PARAM\_TAB to store the parameters file:

```
CREATE TABLE PARAM_TAB (DOCID INTEGER, PARAM VARCHAR(1000))~
```

2. Create a parameter file as follows:

```
INSERT INTO PARAM_TAB VALUES
(1,
'<?xml version="1.0"?>
<params xmlns="http://www.ibm.com/XSLTransformParameters">
  <param name="showUniversity" value="true"/>
  <param name="headline">The student list</param>
</params>'
)~
```

3. Transform the XML document by calling the XSLTRANSFORM function:

```
SELECT XSLTRANSFORM (XML_DOC USING XSLT_DOC WITH PARAM AS CLOB(1M) )
FROM XML_DATA X , PARAM_TAB P, XML_TRANS
WHERE X.DOCID=P.DOCID and XSLID = 1 ~
```

The output of this process is the following HTML file:

```
<html>
<head>
<META http-equiv="Content-Type" content="text/html; charset=UTF-8">
</head>
<body>
<h1>The student list</h1>
<table border="1">
<th>
<tr>
<td width="80">StudentID</td>
<td width="200">Given Name</td>
<td width="200">Family Name</td>
<td width="50">Age</td>
<td width="200">University</td>
</tr>
</th>
<tr>
<td>1</td>
<td>Steffen</td><td>Siegmond</td>
<td>21</td>
<td>Rostock</td>
</tr>
<tr>
<td>2</td>
<td>Helena</td><td>Schmidt</td>
<td>23</td>
<td>Rostock</td>
</tr>
</table>
</body>
</html>
```

Return to the tutorial

---

## Chapter 3. XML storage

XML documents you insert into columns of type XML can reside either in the default storage object, or directly in the base table row. Base table row storage is under your control and is available only for small documents; larger documents are always stored in the default storage object.

The decision to store documents in the base table row depends on your storage and performance requirements, and on accepted trade-offs.

### XML storage object

This is the default method of storing XML documents. Documents that require more than 32 KB of storage space, or larger than the page size, are always stored in the default storage object, regardless of your storage choice. Storage in the default storage object allows you to insert and retrieve XML documents up to 2 gigabytes in size.

### Base table row storage

For XML documents that require less than 32 KB of storage space, you can choose to store your XML documents directly in the base table row. This option can increase performance for any operation that queries, inserts, updates, or deletes XML documents, because fewer I/O operations are required.

If you enable data row compression for the table, XML documents that are stored in the default XML storage object and in the base table row are subject to compression. Compression can improve I/O efficiency for operations on XML documents as well as reduce storage space requirements.

---

## XML storage object

By default, DB2 database server stores XML documents contained in table columns of type XML in XML storage objects, in much the same way that LOB data is stored apart from the other contents of a table.

XML storage objects are separate from, but dependent upon, their parent table objects. For each XML value stored in a row of an XML table column, DB2 maintains a record called an XML data specifier (XDS), which specifies where to retrieve the XML data stored on disk from the associated XML storage object. When stored in system managed space, the files associated with XML storage objects have the file type extension .xda. An XML storage object is sometimes called an XML data area (XDA).

You can store XML documents of up to 2 gigabytes in size in a database. Because XML data can be quite large, you may want to monitor the buffering activity for XML data separately from the buffering activity for other data. A number of monitor elements are available to help you gauge the buffer pool activity for XML storage objects.

For additional information on space requirements for XML columns that use XML storage objects, see "Byte Counts" for XML columns without the `INLINE LENGTH` specified in "CREATE TABLE statement".

---

## XML base table row storage

You can optionally store smaller and medium-size XML documents in the row of the base table instead of storing them in the default XML storage object. Row storage of XML documents is similar to how a structured type instance can be stored inline in the row of a table.

Before you enable base table row storage, you need to decide how much row space you want to dedicate to row storage for each XML column. How much space you can dedicate depends on the maximum row size available, which in turn depends on the page size of the table space in which the table is created, and on the other columns you specify as part of the table. To calculate the row space available to you, see "Row Size" and "Byte Counts" for XML columns with the `INLINE LENGTH` specified in "CREATE TABLE statement".

### Enabling base table row storage

You can specify that XML documents should be stored in base table rows instead of the default XML storage object when you create a table with an XML column, or when you alter an existing table with an XML column. To enable base table row storage, you need to include the `INLINE LENGTH` keywords with your `CREATE TABLE` or `ALTER TABLE` statement for each XML column that should use row storage, followed by the maximum size of XML documents in bytes to store in the base table row.

Note that altering the XML column of an existing table will not move the XML documents already stored in that column into base table rows automatically. To move the XML documents, you must update all XML documents with an `UPDATE` statement.

### Restrictions

Base table row storage is available only for XML documents with an internal representation of 32 KB or less (smaller, if your row size is less), minus the required byte count overhead for an XML column with the `INLINE LENGTH` option specified. The 32 KB size assumes the table space page size is 32 KB. When you store XML documents that exceed the specified inline length, the oversize documents are stored automatically in the default XML storage object.

Once you have specified an inline length for an XML column, you can only increase the inline length size to use for row storage of XML documents, but not reduce it.

### Examples

The following example enables base table row storage of XML documents for the XML column `DESCRIPTION` of the `PRODUCT` table in the `SAMPLE` database. This example sets the maximum inline length of XML documents to be stored in the base table row to 32000 bytes, which leaves room for the additional space required by overhead. Using the value 32000 bytes assumes the table space page size is 32 KB. After the XML column has been altered, an `UPDATE` statement moves the XML documents into the base table row.

```
ALTER TABLE PRODUCT
ALTER COLUMN DESCRIPTION
SET INLINE LENGTH 32000

UPDATE PRODUCT SET DESCRIPTION = DESCRIPTION
```

The following example creates a table MYCUSTOMER similar to the CUSTOMER table of the SAMPLE database, except that base table row storage is specified for the XML column Info. Documents that have an internal representation of 2000 bytes or less will be stored in the base table row when inserted into the Info column.

```
CREATE TABLE MYCUSTOMER (Cid BIGINT NOT NULL,
Info XML INLINE LENGTH 2000,
History XML,
CONSTRAINT PK_CUSTOMER PRIMARY KEY (Cid)) in IBMDB2SAMPLEXML
```

---

## Storage requirements for XML documents

The amount of space that an XML document occupies in a DB2 database is determined by the initial size of the document in raw form and by a number of other factors.

The following list includes the most important of these factors:

### Document structure

XML documents that contain complex markup tagging require a larger amount of storage space than documents with simple markup. For example, an XML document that has many nested elements, each containing a small amount of text or having short attribute values, occupies more storage space than an XML document composed primarily of textual content.

### Node names

The length of element names, attribute names, namespace prefixes and similar, non-content data also affect storage size. Any information unit of this type that exceeds 4 bytes in raw form is compressed for storage, resulting in comparatively greater storage efficiency for longer node names.

### Ratio of attributes to elements

Typically, the more attributes that are used per element, the lower the amount of storage space that is required for the XML document.

### Document codepage

XML documents with encoding that uses more than one byte per character occupy a larger amount storage space than documents using a single-byte character set.

### Compression

If you enable data row compression for a table containing XML columns, XML documents will require less storage space.

Compression of data in the XML storage object of a table is not supported if the table contains XML columns using the DB2 Version 9.5 or earlier XML record format. If you enable such a table for data row compression, only the table row data in the table object is compressed. To make the data in the XML storage object of the table eligible for compression, use the ADMIN\_MOVE\_TABLE stored procedure to migrate the table and then enable data row compression.

---

## Data types for archiving XML documents

Although you can store XML serialized string data in a column of any binary or character type, non-XML columns should be used only for archiving XML data. The best column data type for archiving XML data is a binary data type, such as BLOB.

Use of a character column for archiving introduces code page conversion, which can make a document inconsistent with its original form.



---

## Chapter 4. Inserting XML data

Before you can insert XML documents, you must create a table that contains an XML column, or add an XML column to an existing table.

---

### Creation of tables with XML columns

To create tables with XML columns, you specify columns with the XML data type in the CREATE TABLE statement. A table can have one or more XML columns.

You do not specify a length when you define an XML column. However, serialized XML data that is exchanged with a DB2 database is limited to 2 GB per value of type XML, so the effective limit of an XML document is 2 GB.

Like a LOB column, an XML column holds only a descriptor of the column. The data is stored separately.

**Note:**

- If you enable data row compression for the table, XML documents require less storage space.
- You can optionally store smaller and medium-size XML documents in the row of the base table instead of storing them in the default XML storage object.

**Example:** The sample database contains a table for customer data that contains two XML columns. The definition looks like this:

```
CREATE TABLE Customer (Cid BIGINT NOT NULL PRIMARY KEY,
                        Info XML,
                        History XML)
```

**Example:** The VALIDATED predicate checks whether the value in the specified XML column has been validated. You can define a table check constraint on XML columns, using the VALIDATED predicate, to ensure that all documents inserted or updated in a table are valid.

```
CREATE TABLE TableValid (id BIGINT,
                          xmlcol XML,
                          CONSTRAINT valid_check CHECK (xmlcol IS VALIDATED))
```

**Example:** Setting the COMPRESS attribute to YES enables data row compression. XML documents stored in XML columns are subject to row compression. Compressing data at the row level allows repeating patterns to be replaced with shorter symbol strings.

```
CREATE TABLE TableXmlCol (id BIGINT,
                           xmlcol XML) COMPRESS YES
```

**Example:** The following CREATE TABLE statement creates a patient table partitioned by visit date. All records between January 01, 2000 and December 31, 2006 are in the first partition. The more recent data are partitioned every 6 months.

```
CREATE TABLE Patients ( patientID BIGINT, visit_date DATE, diagInfo XML,
                        prescription XML )
INDEX IN indexTbsp LONG IN ltbps
PARTITION BY ( visit_date )
( STARTING '1/1/2000' ENDING '12/31/2006',
  STARTING '1/1/2007' ENDING '6/30/2007',
```

```
ENDING '12/31/2007',
ENDING '6/30/2008',
ENDING '12/31/2008',
ENDING '6/30/2009' );
```

---

## Addition of XML columns to existing tables

To add XML columns to existing tables, you specify columns with the XML data type in the ALTER TABLE statement with the ADD clause. A table can have one or more XML columns.

**Example** The sample database contains a table for customer data that contains two XML columns. The definition looks like this:

```
CREATE TABLE Customer (Cid BIGINT NOT NULL PRIMARY KEY,
                        Info XML,
                        History XML)
```

Create a table named MyCustomer that is a copy of Customer, and add an XML column to describe customer preferences:

```
CREATE TABLE MyCustomer LIKE Customer;
ALTER TABLE MyCustomer ADD COLUMN Preferences XML;
```

**Example:** Setting the COMPRESS attribute to YES enables data row compression. XML documents stored in XML columns are subject to row compression. Compressing data at the row level allows repeating patterns to be replaced with shorter symbol strings.

```
ALTER TABLE MyCustomer ADD COLUMN Preferences XML COMPRESS YES;
```

**Example:** The following CREATE TABLE statement creates a patient table partitioned by visit date. All records between January 01, 2000 and December 31, 2006 are in the first partition. The more recent data are partitioned every 6 months.

```
CREATE TABLE Patients ( patientID INT, Name Varchar(20), visit_date DATE,
                        diagInfo XML )
PARTITION BY ( visit_date )
( STARTING '1/1/2000' ENDING '12/31/2006',
  STARTING '1/1/2007' ENDING '6/30/2007',
  ENDING '12/31/2007',
  ENDING '6/30/2008',
  ENDING '12/31/2008',
  ENDING '6/30/2009' );
```

The following ALTER table statement adds another XML column for patient prescription information:

```
ALTER TABLE Patients ADD COLUMN prescription XML ;
```

---

## Insertion into XML columns

To insert data into an XML column, use the SQL INSERT statement. The input to the XML column must be a well-formed XML document, as defined in the XML 1.0 specification. The application data type can be an XML, character, or binary type.

It is recommended that XML data be inserted from host variables, rather than literals, so that the DB2 database server can use the host variable data type to determine some of the encoding information.

XML data in an application is in its serialized string format. When you insert the data into an XML column, it must be converted to its XML hierarchical format. If

the application data type is an XML data type, the DB2 database server performs this operation implicitly. If the application data type is not an XML type, you can invoke the XMLPARSE function explicitly when you perform the insert operation, to convert the data from its serialized string format to the XML hierarchical format.

During document insertion, you might also want to validate the XML document against a registered XML schema. You can do that with the XMLVALIDATE function.

The following examples demonstrate how XML data can be inserted into XML columns. The examples use table MyCustomer, which is a copy of the sample Customer table. The XML data that is to be inserted is in file c6.xml, and looks like this:

```
<customerinfo Cid="1015">
  <name>Christine Haas</name>
  <addr country="Canada">
    <street>12 Topgrove</street>
    <city>Toronto</city>
    <prov-state>Ontario</prov-state>
    <pcode-zip>N8X-7F8</pcode-zip>
  </addr>
  <phone type="work">905-555-5238</phone>
  <phone type="home">416-555-2934</phone>
</customerinfo>
```

**Example:** In a JDBC application, read XML data from file c6.xml as binary data, and insert the data into an XML column:

```
PreparedStatement insertStmt = null;
String sqls = null;
int cid = 1015;
sqls = "INSERT INTO MyCustomer (Cid, Info) VALUES (?, ?)";
insertStmt = conn.prepareStatement(sqls);
insertStmt.setInt(1, cid);
File file = new File("c6.xml");
insertStmt.setBinaryStream(2, new FileInputStream(file), (int)file.length());
insertStmt.executeUpdate();
```

**Example:** In a static embedded C application, insert data from a binary XML host variable into an XML column:

```
EXEC SQL BEGIN DECLARE SECTION;
  sqlint64 cid;
  SQL TYPE IS XML AS BLOB (10K) xml_hostvar;
EXEC SQL END DECLARE SECTION;
...
cid=1015;
/* Read data from file c6.xml into xml_hostvar */
...
EXEC SQL INSERT INTO MyCustomer (Cid,Info) VALUES (:cid, :xml_hostvar);
```

---

## XML parsing

XML parsing is the process of converting XML data from its serialized string format to its hierarchical format.

You can let the DB2 database server perform parsing implicitly, or you can perform XML parsing explicitly.

*Implicit XML parsing* occurs in the following cases:

- When you pass data to the database server using a host variable of type XML, or use a parameter marker of type XML  
The database server does the parsing when it binds the value for the host variable or parameter marker for use in statement processing.  
You must use implicit parsing in this case.
- When you assign a host variable, parameter marker, or SQL expression with a string data type (character, graphic or binary) to an XML column in an INSERT, UPDATE, DELETE, or MERGE statement. The parsing occurs when the SQL compiler implicitly adds an XMLPARSE function to the statement.

You perform *explicit XML parsing* when you invoke the XMLPARSE function on the input XML data. You can use the result of XMLPARSE in any context that accepts an XML data type. For example, you can use assign the result to an XML column or use it as a stored procedure parameter of type XML.

The XMLPARSE function takes a non-XML, character or binary data type as input. For embedded dynamic SQL applications, you need to cast the parameter marker that represents the input document for XMLPARSE to the appropriate data type. For example:

```
INSERT INTO MyCustomer (Cid, Info)
VALUES (?, xmlparse(document cast(? as clob(1k)) preserve whitespace))
```

For static embedded SQL applications, a host variable argument of the XMLPARSE function cannot be declared as an XML type (XML AS BLOB, XML AS CLOB, or XML AS DBCLOB type).

## XML parsing and whitespace handling

During implicit or explicit XML parsing, you can control the preservation or stripping of boundary whitespace characters when you store the data in the database.

According to the XML standard, whitespace is space characters (U+0020), carriage returns (U+000D), line feeds (U+000A), or tabs (U+0009) that are in the document to improve readability. When any of these characters appear as part of a text string, they are not considered to be whitespace.

*Boundary whitespace* is whitespace characters that appear between elements. For example, in the following document, the spaces between <a> and <b> and between </b> and </a> are boundary whitespace.

```
<a> <b> and between </b> </a>
```

With explicit invocation of XMLPARSE, you use the STRIP WHITESPACE or PRESERVE WHITESPACE option to control preservation of boundary whitespace. The default is stripping of boundary whitespace.

With implicit XML parsing:

- If the input data type is not an XML type or is not cast to an XML data type, the DB2 database server always strips whitespace.
- If the input data type is an XML data type, you can use the CURRENT IMPLICIT XMLPARSE OPTION special register to control preservation of boundary whitespace. You can set this special register to STRIP WHITESPACE or PRESERVE WHITESPACE. The default is stripping of boundary whitespace.

If you use XML validation, the DB2 database server ignores the CURRENT IMPLICIT XMLPARSE OPTION special register and uses only the validation rules to determine stripping or preservation of whitespace in the following cases:

```
xmlvalidate(? ACCORDING TO XMLSCHEMA ID schemaname)
xmlvalidate(?)
xmlvalidate(:hvxml ACCORDING TO XMLSCHEMA ID schemaname)
xmlvalidate(:hvxml)
xmlvalidate(cast(? as xml) ACCORDING TO XMLSCHEMA ID schemaname)
xmlvalidate(cast(? as xml))
```

In these cases, ? represents XML data, and :hvxml is an XML host variable.

See XML validation for information on how XML validation influences whitespace handling.

The XML standard specifies an xml:space attribute that controls the stripping or preservation of whitespace within XML data. xml:space attributes override any whitespace settings for implicit or explicit XML parsing.

For example, in the following document, the spaces immediately before and after <b> are always preserved, regardless of any XML parsing options, because the spaces are within a node with the attribute xml:space="preserve":

```
<a xml:space="preserve"> <b> <c>c</c>b </b></a>
```

However, in the following document, the spaces immediately before and after <b> can be controlled by the XML parsing options, because the spaces are within a node with the attribute xml:space="default":

```
<a xml:space="default"> <b> <c>c</c>b </b></a>
```

## XML parsing in a non-Unicode database

When an XML document is passed into a non-Unicode database, code page conversion can occur first as the document is passed from the client to the target database server, and then as the document is passed to the DB2 XML parser. Passing an XML document using a host variable or parameter marker of type XML prevents code page conversion from occurring. If an XML document is passed using a character data type (CHAR, VARCHAR, CLOB, or LONG VARCHAR), code page conversion can result in the introduction of substitution characters for any character in the XML data that is not part of the target database code page.

To prevent substitution characters from being introduced, and from potentially degrading the inserted XML data, ensure that if XML data is parsed using a character data type, all code points in the source document are a part of the target database code page. For any character that is not part of this code page you can use a decimal or hexadecimal character entity reference specifying the correct Unicode code point. For example, either &#x003E or &#0062 can be used to specify the > (greater-than) sign character.

You can also use the ENABLE\_XMLCHAR configuration parameter to control whether or not XML parsing is enabled for character data types. Setting ENABLE\_XMLCHAR to "NO" blocks both explicit and implicit XML parsing when character data types are used.

## XML parsing and DTDs

If the input data contains an internal document type declaration (DTD) or references an external DTD, the XML parsing process also checks the syntax of those DTDs. In addition, the parsing process:

- Applies default values that are defined by the internal and external DTDs
- Expands entity references and parameter entities

### Examples

The following examples demonstrate how whitespace in an XML document is handled in different situations.

**Example:** File `c8.xml` contains the following document:

```
<customerinfo xml:space="preserve" Cid='1008'>
  <name>Kathy Smith</name>
  <addr country='Canada'>
    <street>14 Rosewood</street>
    <city>Toronto</city>
    <prov-state>Ontario</prov-state>
    <pcode-zip>M6W 1E6</pcode-zip>
  </addr>
  <phone type='work'>416-555-3333</phone>
</customerinfo>
```

In a JDBC application, read the XML document from the file, and insert the data into XML column INFO of table MYCUSTOMER, which is a copy of the sample Customer table. Let the DB2 database server perform an implicit XML parse operation.

```
PreparedStatement insertStmt = null;
String sqls = null;
int cid = 1008;
sqls = "INSERT INTO MyCustomer (Cid, Info) VALUES (?, ?)";
insertStmt = conn.prepareStatement(sqls);
insertStmt.setInt(1, cid);
File file = new File("c8.xml");
insertStmt.setBinaryStream(2, new FileInputStream(file), (int)file.length());
insertStmt.executeUpdate();
```

No whitespace handling is specified, so the default behavior of stripping whitespace is assumed. However, the document contains the `xml:space="preserve"` attribute, so whitespace is preserved. This means that the carriage returns, line feeds, and spaces between the elements in the document remain.

If you retrieve the stored data, content looks like this:

```
<customerinfo xml:space="preserve" Cid='1008'>
  <name>Kathy Smith</name>
  <addr country='Canada'>
    <street>14 Rosewood</street>
    <city>Toronto</city>
    <prov-state>Ontario</prov-state>
    <pcode-zip>M6W 1E6</pcode-zip>
  </addr>
  <phone type='work'>416-555-3333</phone>
</customerinfo>
```

**Example:** Assume that the following document is in BLOB host variable `blob_hostvar`.

```

<customerinfo xml:space="default" Cid='1009'>
  <name>Kathy Smith</name>
  <addr country='Canada'>
    <street>15 Rosewood</street>
    <city>Toronto</city>
    <prov-state>Ontario</prov-state>
    <pcode-zip>M6W 1E6</pcode-zip>
  </addr>
  <phone type='work'>416-555-4444</phone>
</customerinfo>

```

In a static embedded C application, insert the document from the host variable into XML column Info of table MyCustomer. The host variable is not an XML type, so you need to execute XMLPARSE explicitly. Specify STRIP WHITESPACE to remove any boundary whitespace.

```

EXEC SQL BEGIN DECLARE SECTION;
  SQL TYPE BLOB (10K) blob_hostvar;
EXEC SQL END DECLARE SECTION;
...
EXEC SQL INSERT INTO MyCustomer (Cid, Info)
  VALUES (1009,
  XMLPARSE(DOCUMENT :blob_hostvar STRIP WHITESPACE));

```

The document contains the xml:space="default" attribute, so the XMLPARSE specification of STRIP WHITESPACE controls whitespace handling. This means that the carriage returns, line feeds, and spaces between the elements in the document are removed.

If you retrieve the stored data, you see a single line with the following content:

```

<customerinfo xml:space="default" Cid='1009'>
<name>Kathy Smith</name><addr country='Canada'><street>15 Rosewood</street>
<city>Toronto</city><prov-state>Ontario</prov-state><pcode-zip>M6W 1E6</pcode-zip>
</addr><phone type='work'>416-555-4444</phone></customerinfo>

```

**Example:** In a C language application, host variable clob\_hostvar contains the following document, which contains an internal DTD:

```

<!DOCTYPE prod [<!ELEMENT description (name,details,price,weight)>
  <!ELEMENT name (#PCDATA)>
  <!ELEMENT details (#PCDATA)>
  <!ELEMENT price (#PCDATA)>
  <!ELEMENT weight (#PCDATA)>
  <!ENTITY desc "Anvil">
]>
<product pid='110-100-01' >
  <description>
    <name>&desc;</name>
    <details>Very heavy</details>
    <price>          9.99          </price>
    <weight>1 kg</weight>
  </description>
</product>'

```

Insert the data into table MYPRODUCT, which is a copy of the sample PRODUCT table:

```

EXEC SQL BEGIN DECLARE SECTION;
  SQL TYPE CLOB (10K) clob_hostvar;
EXEC SQL END DECLARE SECTION;
...
EXEC SQL insert into
  Product ( pid, name, Price, PromoPrice, PromoStart, PromoEnd, description )
  values ( '110-100-01', 'Anvil', 9.99, 7.99, '11-02-2004', '12-02-2004',
  XMLPARSE ( DOCUMENT :clob_hostvar STRIP WHITESPACE ));

```

XMLPARSE specifies stripping of whitespace, so boundary whitespace within the document is removed. In addition, when the database server executes XMLPARSE, it replaces the entity reference &desc; with its value.

If you retrieve the stored data, you see a single line with the following content:

```
<product pid="110-100-01"><description><name>Anvil
</name><details>Very heavy</details><price>          9.99          </price>
<weight>1 kg</weight></description></product>
```

---

## XML data integrity

When you need to ensure that your XML documents adhere to certain rules or fulfill certain processing requirements, you can perform additional XML data integrity checks or specify additional conditions that must be met before an action is performed.

Several different methods for ensuring XML data integrity are available; which method you choose depends on your specific data integrity and processing requirements.

If you are indexing XML documents, you can also enforce uniqueness within the XML column across all documents whose nodes are qualified by the XML pattern you are indexing on. See "UNIQUE keyword semantics" for more information.

## Check constraints on XML columns

A check constraint allows you to place certain restrictions on XML columns. The constraint is enforced whenever an attempt is made to insert or update data in the XML column; only when the criteria specified by the constraint evaluate as true is the operation performed.

When working with XML documents, an important consideration is whether or not these documents have previously been validated against XML schemas. If you need to ensure that you query, insert, update or delete only those documents that meet certain validation criteria, use the VALIDATED predicate to provide your criteria. Note that a check constraint never validates XML documents, it only tests whether or not XML documents have already been validated.<sup>2</sup>

The VALIDATED predicate checks the validation state of the value specified by *XML-expression*, which must have an XML data type. If the optional according-to-clause is not specified, then the XML schema used for validation does not impact the result. Check constraints do not validate the XML documents themselves; only the current validation state of the document is tested by the constraint (IS VALIDATED or IS NOT VALIDATED). If the according-to-clause is specified, then the XML schema used to validate the value specified by *XML-expression* must be an XML schema identified by the according-to-clause. XML schemas need to be registered with the XML schema repository before they can be referenced in a VALIDATED predicate.

### Notes:

- Check constraints have a dependency on the XML schemas they reference. If the XSR object of an XML schema is dropped, any constraint that references the schema is also dropped.
- XML columns support NOT NULL constraints.

---

2. If you need to automatically validate XML documents before they are stored in an XML column, you can use a BEFORE trigger.



- XML columns support information constraints defined for XML validation.

## Evaluation of check constraints

Check constraints test the validation state of documents based on the outcome of the IS VALIDATED predicate. If the condition you specified is satisfied, the constraint evaluates as true; if not satisfied, the outcome evaluates as false. If the value specified by *XML-expression* is null, the result of the predicate is unknown.

The result of the VALIDATED predicate is **true** if the value specified by *XML-expression* is not null AND:

- an according-to-clause was not specified and the value specified by *XML-expression* has been validated OR
- an according-to-clause was specified and the value specified by *XML-expression* has been validated using one of the XML schemas identified by the according-to clause.

The result of the predicate is **false** if the value specified by *XML-expression* is not null AND:

- an according-to-clause was not specified and the value specified by *XML-expression* has not been validated OR
- an according-to-clause was specified and the value specified by *XML-expression* has not been validated using one of the XML schemas identified by the according-to clause.

In those cases where the optional according-to-clause is specified, IS NOT VALIDATED will return true when the value specified by *XML-expression* has not been validated or the value specified by *XML-expression* has been validated but not according to any of the specified XML schemas.

## Equivalence of expressions

The VALIDATED predicate

```
value1 IS NOT VALIDATED optional-clause
```

is equivalent to the search condition

```
NOT(value1 IS VALIDATED optional-clause)
```

## Examples

**Example:** Select only validated XML documents. Assume that column XMLCOL is defined in table T1. Retrieve only those XML values that have been validated by any XML schema:

```
SELECT XMLCOL FROM T1
WHERE XMLCOL IS VALIDATED
```

**Example:** Enforce the rule that values cannot be inserted or updated unless they have been validated. Assume that column XMLCOL is defined in table T1 and add a check constraint to XMLCOL:

```
ALTER TABLE T1 ADD CONSTRAINT CK_VALIDATED
CHECK (XMLCOL IS VALIDATED)
```

**Example:** The constraint INFO\_CONSTRAINT is an informational constraint. The rule that values cannot be inserted or updated unless they have been validated is not enforced:

```
CREATE TABLE xmltab (ID INT,
                     DOC XML, CONSTRAINT INFO_CONSTRAINT CHECK (DOC IS VALIDATED) NOT ENFORCED)
```

Informational constraints are used to improve query performance.

## Trigger processing of XML data

Triggers act in response to operations performed by INSERT, UPDATE, or DELETE statements. When working with XML data, you can use the CREATE TRIGGER statement to create BEFORE or AFTER triggers with the UPDATE option on XML columns. You can also create BEFORE or AFTER triggers with the INSERT or DELETE option on tables that include XML columns.

In the trigger body, transition variables that reference columns of type XML in affected rows can be used only for validation with the XMLVALIDATE function, to set XML column values to NULL, or to leave XML columns values unchanged.

A BEFORE trigger used with INSERT or UPDATE statements can be used to automatically validate XML documents before they are stored in an XML column. Validation of XML documents against registered XML schemas is optional, but highly recommended when data integrity is in question, because it ensures that only valid XML documents are inserted or updated.

The trigger is activated when the condition you set for it is met; if you do not specify any condition, the trigger always becomes activated. To trigger validation of XML documents against XML schemas only when it is necessary, you can specify a condition for the XML column with the WHEN clause of the BEFORE trigger. In the WHEN clause you include the required validation state for the XML documents, either that the documents must already be validated or that they must not be validated in order to activate the trigger (IS VALIDATED or IS NOT VALIDATED). Optionally, you can include one or several XML schemas by specifying the ACCORDING TO XMLSCHEMA clause that tells the trigger which XML schemas it should consider in the evaluation of the constraint.

**Note:** A trigger that specifies the WHEN clause will incur additional overhead. If validation before inserting XML documents should always be performed, the WHEN clause can be omitted.

Any trigger that references an XML schema has a dependency on that schema. Before you can reference an XML schema, it must be registered in the XML schema repository. If the XML schema the trigger depends on is later dropped from the XML schema repository, the trigger is marked inoperative.

**Example 1:** Create a BEFORE trigger that automatically validates XML documents containing new product descriptions before they are inserted into the PRODUCT table of the SAMPLE database. This trigger is activated any time before XML documents are updated.

```
CREATE TRIGGER NEWPROD NO CASCADE BEFORE INSERT ON PRODUCT
REFERENCING NEW AS N
FOR EACH ROW MODE DB2SQL
BEGIN ATOMIC
  SET (N.DESCRPTION) = XMLVALIDATE(N.DESCRPTION
  ACCORDING TO XMLSCHEMA URI 'http://posample.org/product.xsd');
END
```

**Example 2:** After you evolve an XML schema product2.xsd, already stored XML documents are guaranteed to be valid under the evolved schema, if they were valid against the original XML schema product.xsd. However, you might want to

ensure that any updates to these XML documents are in fact also valid under the evolved schema product2.xsd. After you registered product2.xsd with the XML schema repository, a BEFORE UPDATE trigger can validate the XML documents before any updates are made:

```
CREATE TRIGGER UPDPDPROD NO CASCADE BEFORE UPDATE ON PRODUCT
REFERENCING NEW AS N
FOR EACH ROW MODE DB2SQL
BEGIN ATOMIC
    SET (N.DESCRPTION) = XMLVALIDATE(N.DESCRPTION
    ACCORDING TO XMLSCHEMA ID product2);
END
```

**Example 3:** You want to log inserted or updated customer records in another table. This requires you to create two triggers, one AFTER INSERT for newly inserted records and one AFTER UPDATE for updated records. In the following example, the triggers are created on the XML column Info of table MyCustomer, which is a copy of the sample Customer table. The triggers cause a record with the timestamp and the Customer ID to be written to a table called CustLog each time a record is inserted or updated in the MyCustomer table. The next example, Example 4, shows how to keep a copy of the actual data as well in the CustLog table

First create the AFTER INSERT trigger on the MyCustomer table:

```
CREATE TRIGGER INSAFTR
AFTER INSERT ON MyCustomer
REFERENCING NEW AS N
FOR EACH ROW
BEGIN ATOMIC
    INSERT INTO CustLog VALUES(N.CID, CURRENT TIMESTAMP, 'Insert');
END
```

Then create the AFTER UPDATE trigger on the MyCustomer table:

```
CREATE TRIGGER UPDAFTR
AFTER UPDATE OF Info
ON MyCustomer
REFERENCING NEW AS N
FOR EACH ROW
BEGIN ATOMIC
    INSERT INTO CustLog VALUES(N.CID, CURRENT TIMESTAMP, 'Update');
END
```

**Example 4:** This example demonstrates how to set up a table to act as an audit log for inserted or updated customer records. As in Example 3, you create two triggers, one AFTER INSERT for newly inserted records and one AFTER UPDATE for updated records. The triggers are created on the XML column Info of table MyCustomer, which is a copy of the sample Customer table. Each time a record is inserted or updated in the MyCustomer table, the triggers cause a record with the timestamp, the Customer ID, and the contents of the XML type column, Info, to be written to a table called CustLog.

First create the AFTER INSERT trigger on the MyCustomer table:

```
CREATE TRIGGER INSAFTR
AFTER INSERT ON MyCustomer
REFERENCING NEW AS N
FOR EACH ROW
BEGIN ATOMIC
    INSERT INTO CustLog VALUES(N.CID, CURRENT TIMESTAMP, 'Insert',
    (SELECT Info FROM MyCustomer WHERE CID = N.CID));
END
```

Then create the AFTER UPDATE trigger on the MyCustomer table:

```

CREATE TRIGGER UPDAFTR
  AFTER UPDATE OF Info
  ON MyCustomer
  REFERENCING NEW AS N
  FOR EACH ROW
  BEGIN ATOMIC
    INSERT INTO CustLog VALUES(N.CID, CURRENT TIMESTAMP, 'Update',
      (SELECT Info FROM MyCustomer WHERE CID = N.CID));
  END

```

## XML validation

XML validation is the process of determining whether the structure, content, and data types of an XML document are valid. XML validation also strips off *ignorable whitespace* in the XML document.

Validation is optional but highly recommended when data integrity is in question, since it ensures that XML documents abide by the rules provided by their XML schemas on top of being well-formed.

Note that you can validate your XML documents against XML schemas only. You cannot validate an XML document against a DTD.

To validate an XML document, use the XMLVALIDATE function. You can specify XMLVALIDATE with an SQL statement that inserts or updates XML documents in a DB2 database. For automatic validation of XML documents, a BEFORE trigger on an XML column can also invoke the XMLVALIDATE function. To enforce validation of XML documents, you create a check constraint.

Before you can invoke the XMLVALIDATE function, all schema documents that make up an XML schema must be registered in the built-in XML schema repository. An XML document itself does not need to be in a database in order for you to be able to validate it with XMLVALIDATE.

### XML validation and ignorable whitespace

According to the XML standard, *whitespace* is space characters (U+0020), carriage returns (U+000D), line feeds (U+000A), or tabs (U+0009) that are in the document to improve readability. When any of these characters appear as part of a text string, they are not considered to be whitespace.

*Ignorable whitespace* is whitespace that can be eliminated from the XML document. The XML schema document determines which whitespace is ignorable whitespace. If an XML document defines an element-only complex type (an element that contains only other elements), the whitespace between the elements is ignorable. If the XML schema defines a simple element that contains a non-string type, the whitespace within that element is ignorable.

**Example:** The description element in the sample product.xsd XML schema document is defined like this:

```

<xs:element name="description" minOccurs="0" maxOccurs="unbounded">
  <xs:complexType>
    <xs:sequence>
      <xs:element name="name" type="xs:string" minOccurs="0" />
      <xs:element name="details" type="xs:string" minOccurs="0" />
      <xs:element name="price" type="xs:decimal" minOccurs="0" />
    </xs:sequence>
  </xs:complexType>
</xs:element>

```

```

        <xs:element name="weight" type="xs:string" minOccurs="0" />
    ...
</xs:complexType>
</xs:element>

```

The description element has an element-only complex type because it contains only other elements. Therefore, whitespace between elements in a description element is ignorable whitespace. The price element can also contain ignorable whitespace because it is a simple element that contains a non-string type.

In the XMLVALIDATE function, you can explicitly specify the XML schema document to use for validation. If you do not specify an XML schema document, the DB2 database server looks in the input document for an xsi:schemaLocation or xsi:noNamespaceSchemaLocation attribute that identifies the XML schema document. xsi:schemaLocation or xsi:noNamespaceSchemaLocation attributes are defined by the XML Schema specification, and are called *XML schema hints*. An xsi:schemaLocation attribute contains one or more pairs of values that help to locate the XML schema document. The first value in each pair is a namespace, and the second value is a hint that indicates where to find the XML schema for the namespace. An xsi:noNamespaceSchemaLocation value contains only a hint. If an XML schema document is specified in the XMLVALIDATE function, it overrides the xsi:schemaLocation or xsi:noNamespaceSchemaLocation attribute.

The following examples assume that schema product is registered in the XML schema repository (XSR). You might use CLP statements like this to complete the registration:

```

REGISTER XMLSCHEMA http://posample.org/product.xsd FROM product.xsd \
AS myschema.product
COMPLETE XMLSCHEMA myschema.product

```

Alternatively, because the XML schema consists of a single schema document, you can use a single statement to register the XML schema and complete registration:

```

REGISTER XMLSCHEMA http://posample.org/product.xsd FROM product.xsd \
AS myschema.product COMPLETE

```

**Example:** Suppose that you create table MyProduct like this:

```

CREATE TABLE MyProduct LIKE Product

```

You want to insert the following document into XML column Info in the MyProduct table using a dynamic SQL application, and you want to validate the XML data against the XML schema document product.xsd, which is located in the XML schema repository on the same database server as the MyProduct table.

```

<product xmlns="http://posample.org" pid='110-100-01' >
  <description>
    <name>Anvil</name>
    <details>Very heavy</details>
    <price>          9.99          </price>
    <weight>1 kg</weight>
  </description>
</product>'

```

In your INSERT statement, the XMLVALIDATE function specifies the XML schema to use for validation:

```

Insert into MyProduct
(pid, name, Price, PromoPrice, PromoStart, PromoEnd, description)
values ( '110-100-01','Anvil', 9.99, 7.99, '11-02-2004','12-02-2004',
XMLVALIDATE(? ACCORDING TO XMLSCHEMA ID myschema.product))

```

When you retrieve the stored data, you can see where XMLVALIDATE removes ignorable whitespace. The retrieved data is a single line with the following content:

```
<product xmlns="http://posample.org" pid="110-100-01"><description><name>Anvil
</name><details>Very heavy</details><price>9.99</price><weight>1 kg</weight>
</description></product>
```

The product schema defines the whitespace around the name, details, price, and weight elements, and the whitespace within the price element as ignorable whitespace, so XMLVALIDATE removes it.

If you need to ensure that you insert only documents that are validated into an XML column or retrieve only documents that are validated from an XML column, use the VALIDATED predicate.

To test whether or not an XML document has been validated before inserting or updating the document, create a check constraint that contains the VALIDATED predicate on the XML column. To retrieve only validated documents from an XML column, or to retrieve only those documents that have been inserted without validation, you use the VALIDATED predicate in a WHERE clause. If you need to check whether or not an XML document has been validated according to certain XML schemas, include the XML schemas with the VALIDATED predicate in the ACCORDING TO XMLSCHEMA clause.

The VALIDATED predicate can also be used as part of a trigger. To trigger validation of XML documents that have not yet been validated before you insert or update them in an XML column, create a BEFORE trigger that contains the VALIDATED predicate on the XML column in the WHEN clause to invoke the XMLVALIDATE function.

**Example:** Suppose that you want to retrieve only validated XML documents from the Info column of the MyCustomer table. Execute SELECT statements like this one:

```
SELECT Info FROM MyCustomer WHERE Info IS VALIDATED
```

**Example:** Suppose that you want to insert only validated XML documents into the Info column of the MyCustomer table. You can define a check constraint to enforce this condition. Alter the MyCustomer table in the following way:

```
ALTER TABLE MyCustomer ADD CONSTRAINT CK_VALIDATED CHECK (Info IS VALIDATED)
```

Issuing this statement, however, makes the use of the VALIDATED predicate in the previous example unnecessary, as only valid documents would be successfully inserted or updated in the table.

**Example:** Suppose that you want to validate the following document with the customer schema, but you do not want to store it in a database.

```
<customerinfo xml:space="default"
xmlns="http://posample.org"
Cid='1011'>
  <name>Kathy Smith</name>
  <addr country='Canada'>
    <street>25 Rosewood</street>
    <city>Toronto</city>
    <prov-state>Ontario</prov-state>
    <pcode-zip>M6W 1E6</pcode-zip>
  </addr>
  <phone type='work'>416-555-6676</phone>
</customerinfo>
```

Assume that you have assigned the document to an application variable. You can use a VALUES statement like this to do the validation:

```
VALUES XMLVALIDATE(? according to xmlschema id myschema.customer)
```

This document is valid according to the XML schema, so the VALUES statement returns a result table that contains the document. If the document is not valid, VALUES returns an SQL error.

## XSR\_GET\_PARSING\_DIAGNOSTICS stored procedure

The stored procedure XSR\_GET\_PARSING\_DIAGNOSTICS generates detailed error information that occur when parsing or validating an XML document. This stored procedure can be used to report both parsing and validation errors or only parsing errors.

Call the XSR\_GET\_PARSING\_DIAGNOSTICS stored procedure from the DB2 command window or add the stored procedure to an application when an error occurs during parsing or validating XML files. For example when validating an XML document using the XMLVALIDATE scalar function, use this stored procedure to generate detailed information about errors that occur during validation.

### Syntax

```
►►XSR_GET_PARSING_DIAGNOSTICS(—instance—,—rschema—,—name—,—  
►—schemaLocation—,—implicitValidation—,—errorDialog—,—errorCount—)►►
```

The schema of the stored procedure is SYSPROC.

### Authorization

**XML schema authorization:** The XML schema used for validation must be registered in the XML schema repository prior to use. The privileges and authorities held by the authorization ID of the stored procedure must include at least one of the following:

- USAGE privilege on the XML schema that is to be used for validation
- DBADM authority

### Procedure parameters

#### *instance*

An input argument of type BLOB(30M) that contains the content of the XML document. A XML document must be provided. The value cannot be NULL.

#### *rschema*

An input argument of type VARCHAR(128) that specifies the SQL schema part of the two-part XSR object name registered with the XML schema repository. The value can be NULL. If this value is NULL, the SQL schema part is assumed to be the current value of the CURRENT SCHEMA special register.

#### *name*

An input argument of type VARCHAR(128) that specifies the schema name of the two-part XSR object name registered with the XML schema repository. The complete SQL identifier for the XML schema is *rschema.name*. It should be unique among all objects in the XSR. The value can be NULL.

### *schemaLocation*

An input argument of type VARCHAR(1000) that indicates the schema location of the primary XML schema document. This argument is the external name of the XML schema, that is, the primary document can be identified in the XML instance document with the `xsi:schemaLocation` attribute. The value can be NULL.

### *implicitValidation*

An input argument of type INTEGER that indicates whether the schema location from the instance document should be used to find the XML schema. The value cannot be NULL. The possible values are 0 for no and 1 for yes.

- 0 Do not use schema location from the instance document. If a 0 value is passed you can specify the schema in using one of the following methods:
- Provide the XSR object name as arguments *rschema* and *name* for schema that is registered in the XML schema repository.
  - Provide the schema location using the argument *schemaLocation*

If both the XSR object name and the *schemaLocation* are specified, the XSR object name is used. If neither are specified validation is not performed. Only an XML parse is performed and any XML parsing errors are reported.

- 1 Use schema location from the value of the `xsi:schemaLocation` attribute in the instance document.

Validation is performed on the input document against XML schema documents previously registered with the XML schema repository.

The instance document is parsed without validation if value of *implicitValidation* argument is 0 and the value of the *rschema*, *name*, and *schemaLocation* arguments are NULL.

### *errorDialog*

An output argument of type VARCHAR(32000) that contains a UTF-8 XML document that lists parsing and validation errors. The document is generated only when there is at least one error.

### *errorCount*

An output argument of type INTEGER that specifies the total number of XML parsing and validation errors.

## Usage

There are three ways to validate an XML document against a registered XML Schema:

- Provide the XSR object name for the XML schema using the *rschema* and *name* arguments.
- Provide the schema location using the *schemaLocation* argument.
- Set *implicitValidation* to 1 if the XML instance document specifies the schema as the value of the `xsi:schemaLocation` attribute.

If a parsing or validation error occurs when using the `XSR_GET_PARSING_DIAGNOSTICS` stored procedure, *errorDialog* and *errorCount* output parameters are set. The *errorDialog* contains an XML document that lists the errors. You can call the `XSR_GET_PARSING_DIAGNOSTICS` stored procedure from applications that use CLI, Java or C++ and use a parameter marker to get the output of the stored procedure.



## Displaying detailed XML parsing and validation errors

You can use the information in the **errorDialog** output parameter from the XSR\_GET\_PARSING\_DIAGNOSTICS stored procedure to resolve XML parsing and validation errors.

If errors occur when validating an XML document using the XMLVALIDATE scalar function, use the XSR\_GET\_PARSING\_DIAGNOSTICS stored procedure to generate detailed error information. The following example uses the XSR\_GET\_PARSING\_DIAGNOSTICS stored procedure with a simple XML schema and XML document to generate detailed validation error information.

### Sample XML schema

The example uses the following XML schema definition (XSD). The schema has various elements, of which a type attribute of integer is assigned to the Age element.

```
<?xml version="1.0"?>
<xs:schema xmlns:xs="http://www.w3.org/2001/XMLSchema"
           targetNamespace="http://my.simpletest"
           xmlns="http://my.simpletest"
           elementFormDefault="qualified">
<xs:element name="Person">
  <xs:complexType>
    <xs:sequence>
      <xs:element name="Name">
        <xs:complexType>
          <xs:sequence>
            <xs:element name="FirstName" type="xs:string"/>
            <xs:element name="LastName" type="xs:string"/>
          </xs:sequence>
        </xs:complexType>
      </xs:element>
      <xs:element name="Age" type="xs:integer"/>
    </xs:sequence>
  </xs:complexType>
</xs:element>
</xs:schema>
```

### Sample XML document

The following XML document will be validated by the sample XML schema. The document does not conform to some of the schema rules. The Age element is not numeric and the Notes<sup>®</sup> element is not defined in the schema as a subelement of the Person element.

```
<?xml version="1.0"?>
<Person xmlns="http://my.simpletest"
        xmlns:xsi="http://www.w3.org/2001/XMLSchema-instance"
        xsi:schemaLocation="http://my.simpletest http://my.simpletest/simple">
  <Name>
    <FirstName>Thomas</FirstName>
    <LastName>Watson</LastName>
  </Name>
  <Age>30x</Age>
  <Notes/>
</Person>
```

### Command to register the XML schema

Before using the XSR\_GET\_PARSING\_DIAGNOSTICS stored procedure to validate an XML document, the XML schema used for validation must be registered in DB2

XML schema repository (XSR). The following REGISTER XMLSCHEMA command assumes the schema is in c:\temp\simpleschema.xsd and the SQL schema is USER1:

```
REGISTER XMLSCHEMA 'http://my.simpletest/simple'
FROM 'file:///c:/temp/simpleschema.xsd'
AS user1.simple COMPLETE
```

## Call to generate detailed validation error information

The following call uses the XSR\_GET\_PARSING\_DIAGNOSTICS stored procedure from the CLP to generate validation error information:

```
CALL XSR_GET_PARSING_DIAGNOSTICS(
blob('<?xml version="1.0"?>
<Person xmlns="http://my.simpletest"
      xmlns:xsi="http://www.w3.org/2001/XMLSchema-instance"
      xsi:schemaLocation="http://my.simpletest http://my.simpletest/simple">
<Name>
  <FirstName>Thomas</FirstName>
  <LastName>Watson</LastName>
</Name>
<Age>30x</Age>
<Notes />
</Person>
)',',',' ',' ','1,?,?)@
```

## Detailed validation error information

The call to the XSR\_GET\_PARSING\_DIAGNOSTICS stored procedure returns the following output. The value of the **errorDialog** parameter is an XML document that contains the detailed validation error information. In the XML document, the contents of the errText, location, lineNumber and colNum elements identifies the specific errors and the location of the errors. The following output is written to standard output when the previous call is run from a CLP command line:

```
Value of output parameters
-----
Parameter Name : ERRORDIALOG
Parameter Value : <ErrorLog>
<XML_Error parser="XML4C">
  <errCode>238</errCode>
  <errDomain>http://apache.org/xml/messages/XML4CErrors</errDomain>
  <errText>Datatype error: Type:InvalidDatatypeValueException,
    Message:Value '30x' does not match regular expression facet '[+\-]?[0-9]+' .
  </errText>
  <lineNum>1</lineNum>
  <colNum>272</colNum>
  <location>/Person/Age</location>
  <schemaType>http://www.w3.org/2001/XMLSchema:integer</schemaType>
  <tokenCount>2</tokenCount>
  <token1>30x</token1>
  <token2>13</token2>
</XML_Error>
<XML_Error parser="XML4C">
  <errCode>2</errCode>
  <errDomain>http://apache.org/xml/messages/XMLValidity</errDomain>
  <errText>Unknown element 'Notes' </errText>
  <lineNum>1</lineNum>
  <colNum>282</colNum>
  <location>/Person</location>
  <schemaType>http://www.w3.org/2001/XMLSchema:integer</schemaType>
  <tokenCount>2</tokenCount>
  <token1>Notes</token1>
  <token2>37</token2>
</XML_Error>
```

```

<XML_Error parser="XML4C">
  <errCode>7</errCode>
  <errDomain>http://apache.org/xml/messages/XMLValidity</errDomain>
  <errText>Element 'Notes' is not valid for content model: '(Name,Age)'
  </errText>
  <lineNum>1</lineNum>
  <colNum>292</colNum>
  <location>/Person</location>
  <schemaType>http://www.w3.org/2001/XMLSchema:anyType</schemaType>
  <tokenCount>2</tokenCount>
  <token1>Notes</token1>
  <token2>31</token2>
</XML_Error>
<DB2_Error>
  <sqlstate>2200M</sqlstate>
  <sqlcode>-16210</sqlcode>
  <errText>
    [IBM][CLI Driver][DB2/NT] SQL16210N XML document contained a value "30x"
    that violates a facet constraint. Reason code = "13". SQLSTATE=2200M
  </errText>
</DB2_Error>
</ErrorLog>

Parameter Name : ERRORCOUNT
Parameter Value : 3
Return Status = 0

```

## ErrorLog XML schema definition for enhanced error message support

The ErrorLog XML schema definition (XSD) describes the UTF-8 XML document generated by the XSR\_GET\_PARSING\_DIAGNOSTICS stored procedure as result of a parsing and validation errors in a XML document. The output XML document is stored in the *errorDialog* argument.

### ErrorLogType

The root element of the XML schema definition is ErrorLog and is of type ErrorLogType.

### XML schema definition

```

<xs:complexType name="ErrorLogType">
  <xs:sequence>
    <xs:element name="XML_Error" type="XML_ErrorType" minOccurs="0"
      maxOccurs="unbounded"/>
    <xs:element name="XML_FatalError" type="XML_ErrorType" minOccurs="0"
      maxOccurs="unbounded"/>
    <xs:element name="DB2_Error" type="DB2_ErrorType"/>
  </xs:sequence>
</xs:complexType>

```

### Subelements

#### XML\_Error

#### XML\_FatalError

**Type:** XML\_ErrorType

**Usage notes:**

An XML\_Error or XML\_FatalError element contains an XML parser generated error message. Both elements XML\_Error and

XML\_FatalError are of the same XML schema type. XML\_FatalError is an error that causes the XML parser to abort the parsing process.

```
xs:complexType name="XML_ErrorType">
  <xs:sequence>
    <xs:element name="errCode" type="xs:int"/>
    <xs:element name="errDomain" type="xs:string"/>
    <xs:element name="errText" type="xs:string"/>
    <xs:element name="lineNum" type="xs:unsignedInt"/>
    <xs:element name="colNum" type="xs:unsignedInt"/>
    <xs:element name="location" type="xs:string"/>
    <xs:element name="schemaType" type="xs:string"/>
    <xs:element name="tokens">
      <xs:complexType>
        <xs:sequence minOccurs="0">
          <xs:element name="token" type="xs:string" minOccurs="0"
            maxOccurs="unbounded"/>
        </xs:sequence>
        <xs:attribute name="count" type="xs:unsignedByte"
          use="required"/>
      </xs:complexType>
    </xs:element>
  </xs:sequence>
  <xs:attribute name="parser" type="xs:string" use="required"/>
</xs:complexType>
```

XML\_ErrorType element contains the following subelements:

**errCode**

A XML Parser returned error code.

**errDomain**

A XML Parser returned error domain.

**errText**

A original XML parser error message.

**lineNum**

A line number where the error occurred.

**colNum**

A column number where the error occurred.

**location**

Location is an XPath expression that points to the last XML element before the error occurred.

**schemaType**

A XML Schematype of the last parsed XML Element.

**tokens**

A numeric value that shows how many token are reported.

**token** A Token is string value that is used to produce the DB2 error message.

**Attributes**

**parser (required)**

The parser attribute specifies the underlying XML parser that was used.

**DB2\_Error**

**Type:** DB2\_ErrorType

**Usage notes:**

A DB2\_Error element contains the DB2 error message.

```

<xs:complexType name="DB2_ErrorType">
  <xs:sequence>
    <xs:element name="sqlstate" type="xs:string"/>
    <xs:element name="sqlcode" type="xs:int"/>
    <xs:element name="errText" type="xs:string"/>
  </xs:sequence>
  <xs:attribute name="parser" type="xs:string" use="required"/>
</xs:complexType>

```

DB2\_ErrorType element contains the following subelements:

**sqlstate**  
A SQLSTATE

**sqlcode**  
A SQLCCODE

**errText**  
A DB2 error message

### XML schema for enhanced error message support

The stored procedure XSR\_GET\_PARSING\_DIAGNOSTICS generates detailed information about errors that occur during parsing and validation of an XML document. The information is generated as an XML document. The schema defines the valid XML output of the stored procedure.

The following listing represents the ErrorLog XML schema for the XML document generated by the stored procedure XSR\_GET\_PARSING\_DIAGNOSTICS.

```

<?xml version="1.0" encoding="UTF-8"?>
<xs:schema xmlns="http://www.ibm.com/db2/XMLParser/Diagnosticsv10"
  xmlns:xs="http://www.w3.org/2001/XMLSchema"
  targetNamespace="http://www.ibm.com/db2/XMLParser/Diagnosticsv10"
  elementFormDefault="qualified" attributeFormDefault="unqualified">
  <xs:element name="ErrorLog">
    <xs:complexType>
      <xs:sequence>
        <xs:element name="XML_Error" type="XML_ErrorType" minOccurs="0"
          maxOccurs="unbounded"/>
        <xs:element name="XML_FatalError" type="XML_ErrorType" minOccurs="0"/>
        <xs:element name="DB2_Error" type="DB2_ErrorType"/>
        <xs:any namespace="##any" maxOccurs="unbounded"/>
      </xs:sequence>
    </xs:complexType>
  </xs:element>
  <xs:complexType name="XML_ErrorType">
    <xs:attribute name="parser" type="xs:string" use="required"/>
    <xs:sequence>
      <xs:element name="errCode" type="xs:int"/>
      <xs:element name="errDomain" type="xs:string"/>
      <xs:element name="errText" type="xs:string"/>
      <xs:element name="lineNum" type="xs:unsignedInt"/>
      <xs:element name="colNum" type="xs:unsignedInt"/>
      <xs:element name="location" type="xs:string"/>
      <xs:element name="schemaType" type="xs:string"/>
      <xs:element name="tokens">
        <xs:complexType>
          <xs:sequence minOccurs="0">
            <xs:element name="token" type="xs:string" minOccurs="0"
              maxOccurs="unbounded"/>
          </xs:sequence>
          <xs:attribute name="count" type="xs:unsignedByte" use="required"/>
        </xs:complexType>
      </xs:element>
      <xs:any namespace="##any"/>
    </xs:sequence>
  </xs:complexType>

```

```

</xs:complexType>
<xs:complexType name="DB2_ErrorType">
  <xs:attribute name="parser" type="xs:string" use="required"/>
  <xs:sequence>
    <xs:element name="sqlstate" type="xs:string"/>
    <xs:element name="sqlcode" type="xs:int"/>
    <xs:element name="errText" type="xs:string"/>
    <xs:any namespace="##any"/>
  </xs:sequence>
</xs:complexType>
</xs:schema>

```

---

## Using XML in a non-Unicode database

Beginning with Version 9.5, XML data can be stored and retrieved from a database that does not use a Unicode code page.

Internally, XML data is always managed by the DB2 database server in a Unicode format, regardless of the database code page. Non-XML, relational data is managed in the database code page. In cases where SQL or XQuery statements involve both XML data and SQL relational data, such as in the casting of one data type to another, or in comparisons involving both the XML data type and SQL data types, code page conversion is often required. Comparisons of XML data to XML data do not require code page conversion because both sets of data are already in UTF-8 format. Similarly, comparisons of SQL data to SQL data do not require code page conversion because both sets of data are already in the database code page.

For operations involving XML data and SQL data, the need for code page conversion is eliminated in a Unicode database because the database uses the same encoding for all data types. In a non-Unicode database, however, operations that involve code page conversion can potentially result in the corruption or loss of data. If the XML data undergoing conversion contains characters with code points that are not part of the database code page, character substitution occurs. As a result, casting or comparison operations can have an unexpected outcome, and XML data retrieved from the database may contain incorrect values. The following section discusses different means of avoiding code page conversion problems so as to ensure the integrity of stored XML data and the operations that involve it.

### XML document insertion and code page conversion

Whenever XML data is inserted into a DB2 database server through a host variable or parameter marker that has a character data type (a data type of CHAR, VARCHAR or CLOB that is not a FOR BIT DATA type), code page conversion occurs if the database code page differs from that of the client or application issuing the request. A second conversion occurs as the inserted character data is converted from the database code page to Unicode, the format in which XML data is managed internally.

The following table shows the various possible encoding combinations between a database and an XML document string inserted from a client or application. The XML document encoding is the same as the client code page because the client inserts the XML data via a character data type. For each combination, the implications for code page conversion and the possibility of resultant character substitution during XML document insertion are described.

Table 2. Encoding scenarios between a database and an inserted XML document string

Scenario	XML document encoding	Database encoding	Code pages match?
1.	Unicode (UTF-8)	Unicode (UTF-8)	yes
2.	Non-Unicode	Unicode (UTF-8)	no
3.	Non-Unicode	Non-Unicode	yes
4.	Unicode (UTF-8)	Non-Unicode	no
5.	Non-Unicode	Non-Unicode	no

1. In Scenario 1, an XML document and a database share a Unicode encoding. No character conversion occurs as the XML document is inserted. It is always safe to insert XML data in this way.
2. In Scenario 2, a non-Unicode XML document is converted to UTF-8 for insertion into a Unicode database. No character substitution occurs through this process. It is always safe to insert XML data in this way
3. In Scenario 3, an XML document and a database share the same non-Unicode encoding. In this case, the XML document can contain only code points that are part of the database code page, so no character substitution occurs during code page conversion. It is always safe to insert XML data in this way
4. In Scenario 4, a Unicode XML document is inserted into a non-Unicode database. Code page conversion occurs if the XML document is inserted from a UTF-8 client or application through either a host variable or a parameter marker that has a character data type. Any characters in the XML document that do not have matching code points in the database code page will be substituted.
5. In Scenario 5, an XML document is inserted into a database server where the two have different encodings, neither of which is UTF-8. In this case, like in Scenario 4, if the XML document is inserted using a character data type, character substitution occurs in any case where the XML document contains characters that are not valid in the database code page.

## Safely inserting XML data into a non-Unicode database

The safest way to ensure the integrity of XML data is to use a Unicode database. However, if this is not possible, there are other ways to prevent character substitution from occurring. The following list describes various methods of inserting XML data safely, whether or not a Unicode database is used:

### Use a Unicode database, or ensure that the database and client use the same encoding

As illustrated in Table 2, code page conversion issues for XML data are always avoided when:

- The database is Unicode
- The database and the client share the same encoding, whether or not this is Unicode

### Avoid using a host variable or parameter marker with a character data type

When a Unicode database cannot be used, code page conversion of XML data can also be avoided by binding the XML data using a host variable or parameter marker of type XML or any binary data type. That is, specifying a data type other than CHAR, VARCHAR, or CLOB for the XML data allows it to be passed directly from the client or application code page to Unicode, bypassing conversion to the database code page.

The ENABLE\_XMLCHAR configuration parameter allows you to control whether or not inserting is allowed via character data types. Setting ENABLE\_XMLCHAR to "NO" will block the usage of character data types during XML document insertion, preventing possible character substitution and ensuring the integrity of stored XML data. The BLOB and FOR BIT DATA types are still allowed, since these data types are safe from code page conversion. By default, ENABLE\_XMLCHAR is set to "YES" so that insertion of character data types is allowed.

When a Unicode database is used code page conversion is never a problem, so in this case the ENABLE\_XMLCHAR configuration parameter has no effect; character data types can be used for XML document insertion regardless of the setting for ENABLE\_XMLCHAR.

**Use character entity references for characters that are not in the database code page** In cases where code page conversion cannot be avoided and a character data type must be used for the XML data stream, it is best to ensure that all characters in the XML document have matching code points in the database code page. For any characters in the XML data that do not have matching code points in the target database you can use a character entity reference to specify the Unicode code point of the character. Code page conversion is always bypassed for character entity references, so that the correct character is preserved in the XML data. For example, the character entity references `&#X003E;` and `&#0062;` are, respectively, the hexadecimal and decimal equivalents of the greater than sign ("`>`").

## Querying XML data in a non-Unicode database

As with inserting XML data into a database, the safest way to ensure data integrity during a query involving XML data is to use a Unicode database. If this is not possible, character substitution is avoided by making sure that all XML data is representable in the database code page, or by using character entity references for characters that are not in the database code page.

In the event that a query contains XML content that includes characters not representable in the database code page, the following two types of character substitution may occur, potentially causing unexpected results for the query:

### Replacement by default substitution character

The default substitution character for the code page is introduced in place of the unmatchable character in the XML data. For example, if a Chinese character is passed into an ASCII encoded database (ISO-8859-1), the original character is substituted with the ASCII code point 0x1A, a control character which typically displays as a question mark ('?') when displayed on a client. When the XML data is converted from the database code page to Unicode, the substitution character is preserved.

### Replacement by nearest character equivalent ("folding")

The original input character is replaced by a character in the target code page that is similar, but not necessarily identical, to the original character. It is sometimes the case that two or more characters with distinct Unicode code points map onto a single code point in a database code page (the nearest character equivalent in the target code page), so that after insertion into a database the distinction between the values is lost. This scenario is illustrated in Example 2.



## Examples

The following examples demonstrate the possible effects of code page conversion when a client or application with a UTF-8 encoding is used to query XML data in a non-Unicode database. In these examples, assume that the database is created using code page ISO8859-7 (Greek). XQuery expressions are used to match XML data stored in table T1, where the stored XML data consists of the Unicode Greek sigma character ( $\Sigma_G$ ) and the Unicode mathematical sigma character ( $\Sigma_M$ ). The code point 0xD3 identifies the sigma character in the ISO8859-7 database.

The table T1 is created and populated using the following commands:

```
CREATE TABLE T1 (DOCID BIGINT NOT NULL, XMLCOL XML);
INSERT INTO T1 VALUES (1, XMLPARSE(
    document '<?xml version="1.0" encoding="utf-8" ?> <Specialchars>
    <sigma> $\Sigma_G$ </sigma>
    <summation> $\Sigma_M$ </summation>
    </Specialchars>'
    preserve whitespace));
```

### Example 1: Successful code page conversion (character is representable in database code page)

```
XQUERY for $test in db2-fn:xmlcolumn("T1.XMLCOL")//*[. = " $\Sigma_G$ "] return $test
```

This expression produces the desired result:

```
<sigma> $\Sigma_G$ </sigma>
```

In this case, the expression  $\Sigma_G$  begins at the client as the Unicode code point for the Greek sigma character (U+03A3), is converted to the sigma character in the Greek database code page (0xD3), and is then converted back to the correct Unicode character for XML processing. Because the Greek sigma character is representable in the database code page, the expression matches correctly. This character conversion is shown in the following table:

Table 3. Character data conversion (Example 1)

	Client (UTF-8)		Database (ISO8859-7)		XML parser (UTF-8)
Character	U+03A3 (Greek sigma)	→	0xD3 (Greek sigma)	→	U+03A3 (Greek sigma)

### Example 2: Unsuccessful code page conversion (character is not representable in database code page)

```
XQUERY for $test in db2-fn:xmlcolumn("T1.XMLCOL")//*[. = " $\Sigma_M$ "] return $test
```

This expression does not produce the desired result:

```
<sigma> $\Sigma_G$ </sigma>
```

In this case, the expression  $\Sigma_M$  begins at the client as the Unicode code point for the mathematical symbol sigma (U+2211), is converted to the sigma character in the Greek database code page (0xD3) and then matches the  $\Sigma_G$  character when the XML comparison occurs. For the return expression, the process is identical to that in Example 1. The Unicode XML character  $\Sigma_G$  converts first to the sigma character in the Greek database code page ( $\Sigma_A$ ), and then back to the Greek sigma character in the client UTF-8 code page ( $\Sigma_G$ ). This character conversion is shown in the following table:

Table 4. Character data conversion (Example 2)

	Client (UTF-8)		Database (ISO8859-7)		XML parser (UTF-8)
Character	U+2211 (Mathematical sigma)	→	0xD3 (Greek sigma)	→	U+03A3 (Greek sigma)

**Example 3: Bypassing code page conversion using a character entity reference**

```
XQUERY for $test in db2-fn:xmlcolumn("T1.XMLCOL")//*[. = "&#2211;"]
return $test
```

This expression produces the desired result:

```
<summation> $\Sigma_M$ </summation>
```

In this case, the expression  $\Sigma_M$  begins at the client as the Unicode code point for the mathematical symbol sigma (U+2211), and because it is escaped as character reference `&#2211`, the Unicode code point is preserved when it is passed to the XML parser, allowing for successful comparison against the stored XML value  $\Sigma_M$ . The bypassing of character conversion is shown in the following table:

Table 5. Character data conversion (Example 3)

	Client (UTF-8)		Database (ISO8859-7)		XML parser (UTF-8)
Character	U+2211 (character reference for mathematical sigma)	→	"&#2211" (character reference for mathematical sigma)	→	U+2211 (mathematical sigma)

**Example 4: Unsuccessful code page conversion (character is not representable in database code page)**

This example is like Example 1, except that here an ASCII encoded database is used and the default substitution character for the code page is introduced into the XML expression.

```
XQUERY for $test in db2-fn:xmlcolumn("T1.XMLCOL")//*[. = " $\Sigma_6$ "] return $test
```

This query fails to match the correct value in table T1. In this case, the Unicode character U+2211 (Greek sigma) does not have a matching code point in the ASCII code page so a default substitution character is introduced, in this case the question mark character ('?'). This character conversion is shown in the following table:

Table 6. Character data conversion (Example 4)

	Client (UTF-8)		Database (ISO8859-1)		XML parser (UTF-8)
Character	U+2211 (mathematical sigma)	→	0x003F ('?')	→	0x003F ('?')

---

## Chapter 5. Querying XML data

You can query or retrieve XML data stored in the database through two main query languages, either by using each language on its own or by using a combination of the two.

The following options are available to you:

- XQuery expressions only
- XQuery expressions that invoke SQL statements
- SQL statements only
- SQL statements that executes XQuery expressions

These various methods allow you to query or retrieve XML and other relational data from either an SQL or XQuery context.

Pieces of or entire XML documents can be queried and retrieved using these methods. Queries can return fragments or entire XML documents, and results returned from queries can be limited by using predicates. Because queries on XML data return XML sequences, a query's result can be used in the construction of XML data as well.

---

### Introduction to XQuery

XQuery is a functional programming language that was designed by the World Wide Web Consortium (W3C) to meet specific requirements for querying and modifying XML data.

Unlike relational data, which is predictable and has a regular structure, XML data is highly variable. XML data is often unpredictable, sparse, and self-describing.

Because the structure of XML data is unpredictable, the queries that you need to perform on XML data often differ from typical relational queries. The XQuery language provides the flexibility required to perform these kinds of operations. For example, you might need to use the XQuery language to perform the following operations:

- Search XML data for objects that are at unknown levels of the hierarchy.
- Perform structural transformations on the data (for example, you might want to invert a hierarchy).
- Return results that have mixed types.
- Update existing XML data.

#### Components of an XQuery query

In XQuery, expressions are the main building blocks of a query. Expressions can be nested and form the body of a query. A query can also have a prolog before this body. The *prolog* contains a series of declarations that define the processing environment for the query. The *query body* consists of an expression that defines the result of the query. This expression can be composed of multiple XQuery expressions that are combined using operators or keywords.

Figure 4 illustrates the structure of a typical query. In this example, the prolog contains two declarations: a version declaration, which specifies the version of the XQuery syntax to use to process the query, and a default namespace declaration that specifies the namespace URI to use for unprefixed element and type names. The query body contains an expression that constructs a `price_list` element. The content of the `price_list` element is a list of product elements that are sorted in descending order by price.



Figure 4. Structure of a typical query in XQuery

## Retrieving DB2 data with XQuery functions

In XQuery, a query can call one of the following functions to obtain input XML data from a DB2 database: `db2-fn:sqlquery` and `db2-fn:xmlcolumn`.

The function `db2-fn:xmlcolumn` retrieves an entire XML column, whereas `db2-fn:sqlquery` retrieves XML values that are based on an SQL fullselect.

### **db2-fn:xmlcolumn**

The `db2-fn:xmlcolumn` function takes a string literal argument that identifies an XML column in a table or a view and returns a sequence of XML values that are in that column. The argument of this function is case sensitive. The string literal argument must be a qualified column name of type XML. This function allows you to extract a whole column of XML data without applying a search condition.

In the following example, the query uses the `db2-fn:xmlcolumn` function to get all of the purchase orders in the `PURCHASE_ORDER` column of the `BUSINESS.ORDERS` table. The query then operates on this input data to extract the cities from the shipping address in these purchase orders. The result of the query is a list of all cities to which orders are shipped:

```
db2-fn:xmlcolumn('BUSINESS.ORDERS.PURCHASE_ORDER')/shipping_address/city
```

### **db2-fn:sqlquery**

The `db2-fn:sqlquery` function takes a string argument that represents a fullselect and returns an XML sequence that is a concatenation of the XML values that are returned by the fullselect. The fullselect must specify a single-column result set, and the column must have a data type of XML.

Specifying a fullselect allows you to use the power of SQL to present XML data to XQuery. The function supports using parameters to pass values to the SQL statement.

In the following example, a table called BUSINESS.ORDERS contains an XML column called PURCHASE\_ORDER. The query in the example uses the db2-fn:sqlquery function to call SQL to get all of the purchase orders where the ship date is June 15, 2005. The query then operates on this input data to extract the cities from the shipping addresses in these purchase orders. The result of the query is a list of all of the cities to which orders are shipped on June 15:

```
db2-fn:sqlquery("
SELECT purchase_order FROM business.orders
WHERE ship_date = '2005-06-15' ")/shipping_address/city
```

**Important:** An XML sequence that is returned by the db2-fn:sqlquery or db2-fn:xmlcolumn function can contain any XML values, including atomic values and nodes. These functions do not always return a sequence of well-formed documents. For example, the function might return a single atomic value, like 36, as an instance of the XML data type.

SQL and XQuery have different conventions for case-sensitivity of names. You should be aware of these differences when using the db2-fn:sqlquery and db2-fn:xmlcolumn functions.

#### **SQL is not a case-sensitive language**

By default, all ordinary identifiers, which are used in SQL statements, are automatically converted to uppercase. Therefore, the names of SQL tables and columns are customarily uppercase names, such as BUSINESS.ORDERS and PURCHASE\_ORDER in the previous examples. In an SQL statement, these columns can be referenced by using lowercase names, such as business.orders and purchase\_order, which are automatically converted to uppercase during processing of the SQL statement. (You can also create a case-sensitive name that is called a *delimited identifier* in SQL by enclosing the name in double quotation marks.)

#### **XQuery is a case-sensitive language**

XQuery does not convert lowercase names to uppercase. This difference can lead to some confusion when XQuery and SQL are used together. The string that is passed to db2-fn:sqlquery is interpreted as an SQL query and is parsed by the SQL parser, which converts all names to uppercase. Thus, in the db2-fn:sqlquery example, the table name business.orders and the column names purchase\_order and ship\_date can appear in either uppercase or lowercase. The operand of db2-fn:xmlcolumn, however, is not an SQL query. The operand is a case-sensitive XQuery string literal that represents the name of a column. Because the actual name of the column is BUSINESS.ORDERS.PURCHASE\_ORDER, this name must be specified in uppercase in the operand of db2-fn:xmlcolumn.

---

## **Introduction to querying XML data with SQL**

XML data can be queried using an SQL fullselect or with the SQL/XML query functions of XMLQUERY and XMLTABLE. The XMLEXISTS predicate can also be used in SQL queries on XML data.

When querying XML data using only SQL, without any XQuery, you can query only at the column level by issuing a fullselect. For this reason, only entire XML documents can be returned from the query; it is not possible to return fragments of a document using only SQL.

To query within XML documents, you need to use XQuery. XQuery can be invoked from SQL using any of the following SQL/XML functions or predicate:

#### **XMLQUERY**

An SQL scalar function that returns the result of an XQuery expression as an XML sequence.

#### **XMLTABLE**

An SQL table function that returns the result of an XQuery expression as a table.

#### **XMLEXISTS**

An SQL predicate that determines whether an XQuery expression returns a non-empty sequence.

---

## **Comparison of XQuery to SQL**

DB2 databases support storing well-formed XML data in a column of a table and retrieving the XML data from the database by using SQL, XQuery, or a combination of SQL and XQuery. Both languages are supported as primary query languages, and both languages provide functions for invoking the other language.

#### **XQuery**

A query that invokes XQuery directly begins with the keyword XQUERY. This keyword indicates that XQuery is being used and that the DB2 server must therefore use case sensitivity rules that apply to the XQuery language. Error handling is based on the interfaces that are used to process XQuery expressions. XQuery errors are reported with an SQLCODE and SQLSTATE in the same way that SQL error errors are reported. No warnings are returned from processing XQuery expressions. XQuery obtains data by calling functions that extract XML data from DB2 tables and views. XQuery can also be invoked from an SQL query. In this case, the SQL query can pass XML data to XQuery in the form of bound variables. XQuery supports various expressions for processing XML data and for constructing new XML objects such as elements and attributes. The programming interface to XQuery provides facilities similar to those of SQL to prepare queries and retrieve query results.

**SQL** SQL provides capabilities to define and instantiate values of the XML data type. Strings that contain well-formed XML documents can be parsed into XML values, optionally validated against an XML schema, and inserted or updated in tables. Alternatively, XML values can be constructed by using SQL constructor functions, which convert other relational data into XML values. Functions are also provided to query XML data by using XQuery and to convert XML data into a relational table for use within an SQL query. Data can be cast between SQL and XML data types in addition to serializing XML values into string data.

SQL/XML provides the following functions and predicates for calling XQuery from SQL:

#### **XMLQUERY**

XMLQUERY is a scalar function that takes an XQuery expression as an argument and returns an XML sequence. The function

includes optional parameters that can be used to pass SQL values to the XQuery expression as XQuery variables. The XML values that are returned by XMLQUERY can be further processed within the context of the SQL query.

#### **XMLTABLE**

XMLTABLE is a table function that uses XQuery expressions to generate an SQL table from XML data, which can be further processed by SQL.

#### **XMLEXISTS**

XMLEXISTS is an SQL predicate that determines if an XQuery expression returns a sequence of one or more items (and not an empty sequence).

---

## **Comparison of methods for querying XML data**

Because XML data can be queried in a number of ways, using XQuery, SQL, or a combination of these, the method to choose can differ depending on your situation. The following sections describe conditions that are advantageous for a particular query method.

### **XQuery only**

Querying with XQuery alone can be a suitable choice when:

- applications access only XML data, without the need to query non-XML relational data
- migrating queries previously written in XQuery to DB2 Database for Linux, UNIX, and Windows
- returning query results to be used as values for constructing XML documents
- the query author is more familiar with XQuery than SQL

### **XQuery that invokes SQL**

Querying with XQuery that invokes SQL can be a suitable choice when (in addition to the scenarios identified in the previous section on using XQuery only):

- queries involve XML data and relational data; SQL predicates and indexes defined on the relational columns can be leveraged in the query
- you want to apply XQuery expressions to the results of:
  - UDF calls, as these cannot be invoked directly from XQuery
  - XML values constructed from relational data using SQL/XML publishing functions
  - queries that use DB2 Net Search Extender which offers full text search of XML documents but which must be used with SQL

### **SQL only**

When retrieving XML data using only SQL, without any XQuery, you can query only at the XML column level. For this reason, only entire XML documents can be returned from the query. This usage is suitable when:

- you want to retrieve entire XML documents
- you do not need to query based on values within the stored documents, or where the predicates of your query are on other non-XML columns of the table

## SQL/XML functions that execute XQuery expressions

The SQL/XML functions XMLQUERY and XMLTABLE, as well as the XMLEXISTS predicate, enable XQuery expressions to be executed from within the SQL context. Executing XQuery within SQL can be a suitable choice when:

- existing SQL applications need to be enabled for querying within XML documents. To query within XML documents, XQuery expressions need to be executed, which can be done using SQL/XML
- applications querying XML data need to pass parameter markers to the XQuery expression. (The parameter markers are first bound to XQuery variables in XMLQUERY or XMLTABLE.)
- the query author is more familiar with SQL than XQuery
- both relational and XML data needs to be returned in a single query
- you need to join XML and relational data
- you want to group or aggregate XML data. You can apply the GROUP BY or ORDER BY clauses of a subselect to the XML data (for example, after the XML data has been retrieved and collected in table format by using the XMLTABLE function)

---

## Specifying XML namespaces

In an XML document, an XML namespace is optional and is used as a prefix for node names in the XML document. To access the nodes in an XML document that uses a namespace, your XQuery expressions must also specify the same namespace as part of the node name.

A default XML namespace can be specified for a document, and XML namespaces can be specified for specific elements in a document.

Note that namespace declarations are terminated by a semicolon (;). This means that you cannot use the semicolon as a statement termination character if you also want to work with SQL statements and XQuery expressions that contain the semicolon, for example, by invoking the command line processor with db2 -t. You can specify a termination character other than the semicolon with the -td option, which ensures that statements containing namespace declarations are not misinterpreted. The examples in the tutorial use the tilde (~) as the termination character (-td~), but % is also commonly used (-td%).

For example, the tutorial for pureXML uses XML documents that specify a default element namespace for an XML document. The following XML is one of the XML documents used in the tutorial:

```
<customerinfo xmlns="http://posample.org" Cid="1002">
  <name>Jim Noodle</name>
  <addr country="Canada">
    <street>25 EastCreek</street>
    <city>Markham</city>
    <prov-state>Ontario</prov-state>
    <pcode-zip>N9C 3T6</pcode-zip>
  </addr>
  <phone type="work">905-555-7258</phone>
</customerinfo>
```

The root node of the XML document binds the default element namespace for the document to the Universal Resource Identifier (URI) <http://posample.org>.

```
<customerinfo xmlns="http://posample.org" Cid="1002">
```



The XQuery expressions you run in the tutorial also bind a URI as the default element namespace by including a **declare default element namespace** prolog. For example, the XQuery expression in the following SELECT statement declares a default element namespace; if you run the SELECT statement against the CUSTOMER table created in the tutorial, one Customer ID is returned:

```
SELECT cid FROM customer
WHERE XMLEXISTS('declare default element namespace "http://posample.org";
$i/customerinfo/addr/city[ . = "Markham"]' passing INFO as "i")
```

By using the same URI as the default element namespace in the XML document, the expression qualifies the node names in the expression with the correct namespace prefix. Without a default element namespace declaration, or with a different URI bound as the default element namespace, the expression does not qualify the node names with the correct namespace and no data is returned. For example, the following SELECT statement is similar to the previous statement but does not have a default namespace declaration. If you run this statement against the CUSTOMER table created in the tutorial, no data is returned.

```
SELECT cid FROM customer
WHERE XMLEXISTS('$i/customerinfo/addr/city[ . = "Markham"]'
passing INFO as "i")
```

## Using a namespace prefix with a node name

To qualify a node name with a namespace, you can add the namespace prefix for each node name. You separate the prefix and the node name with a colon. For the node `po:addr`, the namespace prefix `po` is separated from the local node name `addr`. If you qualify a namespace prefix with a node name, you must ensure that the prefix is bound to a URI. For example, the XQuery expression in the following SELECT statement binds the namespace prefix `po` to the URI `http://posample.org` by declaring the namespace `po`. When you run the following statement against the CUSTOMER table created in the tutorial, one result is returned.

```
SELECT cid FROM customer
WHERE XMLEXISTS('
declare namespace po = "http://posample.org";
$i/po:customerinfo/po:addr/po:city[ . = "Markham"]' passing INFO as "i")
```

The namespace prefix `po` could be any prefix; what matters is the URI that is bound to the prefix. For example, the XQuery expression in the following SELECT statement uses the namespace prefix `mytest` but is equivalent to the expression in the previous statement:

```
SELECT cid FROM customer
WHERE XMLEXISTS('declare namespace mytest = "http://posample.org";
$i/mytest:customerinfo/mytest:addr/mytest:city[ . = "Markham"]'
passing INFO as "i")
```

## Using a wildcard as a namespace prefix

You can use a wildcard character in an XQuery expression to match any namespace used in the XML data. The XQuery expression in the following SELECT statement uses a wildcard character to match all namespace prefixes.

```
SELECT cid FROM customer
WHERE XMLEXISTS('$i/*:customerinfo/*:addr/*:city[ . = "Markham"]'
passing INFO as "i")
```

When you run the SELECT statement against the CUSTOMER table created in the tutorial, one Customer ID is returned.

---

## Example: Changing the namespace prefix of an element

These examples demonstrate how add and remove the namespace binding assigned to the QName of an element.

A QName of an element is the optional namespace prefix and the local name. The namespace prefix and the local name are separated by a colon. The namespace prefix, if present, is bound to a URI (Universal Resource Identifier) and provides a shortened form of the URI. The expanded QName includes the namespace URI and a local name.

Using functions such as `fn:QName`, `fn:local-name`, and `fn:namespace-uri` you can rename attribute and node names, and find the URI associated with a node's namespace prefix.

An XQuery namespace declaration is terminated by a semicolon (;). You cannot use the semicolon as a statement termination character. The examples use the tilde (~) as the termination character, which is the same termination character used by the pureXML tutorial.

### Adding a namespace prefix to an element

The examples use an XML document from a table. The following statements create the table and inserts an XML document into the table:

```
CREATE TABLE XMLTEST (ID BIGINT NOT NULL PRIMARY KEY, XMLDOC XML ) ~
INSERT INTO XMLTEST Values (4,
'<depts>
  <dept id="A07">
    <emp id="31201" >
      <location region="31" />
    </emp>
    <emp type="new" id = "23322" >
      <moved:location xmlns:moved="http://oldcompany.com" region="43" />
    </emp>
  </dept>
</depts> ') ~
```

The XQuery expression in the following SELECT statement adds a namespace prefix to an element. The XQuery expression uses `fn:QName` to create a QName with a namespace binding.

The XQuery **let** clause creates an empty element with name `emp` and namespace `http://example.com/new`. In the **transform** expression, the **rename** expression changes the name of the element identified by the XPath expression `$newdept/depts/dept/emp[@type="new"]`. The element is named `emp` but has no namespace prefix.

```
SELECT XMLQUERY ( '
  let $newemp := fn:QName( "http://mycompany.com", "new:emp")
  return
  transform
    copy $newdept := $doc
    modify
      do rename $newdept/depts/dept/emp[@type="new"] as $newemp
    return
  $newdept ' passing XMLDOC as "doc" )
from XMLTEST where ID = 4 ~
```

The XQuery expression returns the following XML data with the namespace binding specified as part of the node `new:emp`. The modified document is valid

XML that includes namespace prefixes that are bound to a namespace. A namespace declaration is added to the newly renamed element.

```
<depts>
  <dept id="A07">
    <emp id="31201">
      <location region="31" />
    </emp>
    <new:emp xmlns:new="http://mycompany.com" type="new" id="23322">
      <moved:location xmlns:moved="http://oldcompany.com" region="43" />
    </new:emp>
  </dept>
</depts>
```

## Removing a namespace prefix from an element

You can remove a namespace prefix from a node name by renaming the node to a QName without a namespace binding. The following XQuery expression in the SELECT statement uses a for clause and the fn:namespace-uri function to determine the URI of the element nodes within each emp node. If the URI is http://oldcompany.com the rename expression uses the fn:QName and fn:local-name functions to remove the namespace prefix from the element node.

```
SELECT XMLQUERY ( '
  transform
    copy $newdept := $x
    modify
      for $testemp in $newdept/depts/dept/*:emp/*
      return
        if ( fn:namespace-uri( $testemp ) eq "http://oldcompany.com")
        then
          do rename $testemp as fn:QName( "", fn:local-name($testemp) )
        else()
    return
      $newdept
  ' passing XMLDOC as "x" )
from XMLTEST where ID = 4 ~
```

The XQuery expression returns the following XML data. The node name new:location is replaced with location. The namespace binding is not removed from the node.

```
<depts>
  <dept id="A07">
    <emp id="31201">
      <location region="31" />
    </emp>
    <emp type="new" id="23322">
      <location xmlns:moved="http://oldcompany.com" region="43" />
    </emp>
  </dept>
</depts>
```

---

## XMLQUERY function overview

XMLQUERY is an SQL scalar function that enables you to execute an XQuery expression from within an SQL context. You can pass variables to the XQuery expression specified in XMLQUERY. XMLQUERY returns an XML value, which is an XML sequence. This sequence can be empty or contain one or more items.

By executing XQuery expressions from within the SQL context, you can:

- operate on parts of stored XML documents, instead of entire XML documents (only XQuery can query within an XML document; SQL alone queries at the whole document level)
- enable XML data to participate in SQL queries
- operate on both relational and XML data
- apply further SQL processing to the returned XML values (for example, ordering results with the ORDER BY clause of a subselect)

Refer to the documentation on the comparison of querying methods for more details.

Note that XQuery is case-sensitive, so the XQuery expressions and variables specified in XMLQUERY must be carefully specified.

For cases where the full functionality for passing SQL expressions is not needed, a simpler syntax for passing column names without having to specify the names in the **passing** clause explicitly is also available. See Simple column name passing with XMLEXISTS, XMLQUERY, and XMLTABLE.

## Non-empty sequences returned by XMLQUERY

The XMLQUERY function returns a non-empty sequence, if the XQuery expression specified within it results in a non-empty sequence.

For example, consider the following two XML documents that are stored in the XML column INFO of the CUSTOMER table:

```
<customerinfo Cid="1002">
  <name>Jim Noodle</name>
  <addr country="Canada">
    <street>25 EastCreek</street>
    <city>Markham</city>
    <prov-state>Ontario</prov-state>
    <pcode-zip>N9C 3T6</pcode-zip>
  </addr>
  <phone type="work">905-555-7258</phone>
</customerinfo>

<customerinfo Cid="1003">
  <name>Robert Shoemaker</name>
  <addr country="Canada">
    <street>1596 Baseline</street>
    <city>Aurora</city>
    <prov-state>Ontario</prov-state>
    <pcode-zip>N8X 7F8</pcode-zip>
  </addr>
  <phone type="work">905-555-7258</phone>
  <phone type="home">416-555-2937</phone>
  <phone type="cell">905-555-8743</phone>
  <phone type="cottage">613-555-3278</phone>
</customerinfo>
```

If you issue the following query

```
SELECT XMLQUERY ('$d/customerinfo/phone' passing INFO as "d")
FROM CUSTOMER
```

the results set contains two rows as follows (the output has been formatted for clarity):

```
1
-----
```

```

<phone type="work">905-555-7258</phone>
<phone type="work">905-555-7258</phone><phone type="home">416-555-2937</
phone><phone type="cell">905-555-8743</phone><phone type="cottage">613-
555-3278</phone>

```

2 record(s) selected.

Notice that the first row contains a sequence of one <phone> element, while the second row has a sequence of four <phone> elements. This result occurs because the second XML document contains four <phone> elements, and XMLQUERY returns a sequence of all elements that satisfy the XQuery expression. (Note that the result in the second row is not a well-formed document. Ensure that any application receiving this result can properly handle this behavior.)

The previous example shows how XMLQUERY is commonly used: applied to one XML document at a time, where each row in the resulting table represents the result from one document. XMLQUERY, however, can also be applied to multiple documents at once, as is the case when multiple documents are contained in a single sequence. In this case, the results from applying XMLQUERY to all documents in the sequence are returned in a single row.

For example, assume that the same documents presented previously are stored in the INFO column of the CUSTOMER table. The db2-fn:xmlcolumn function in the following query returns one sequence that contains the two XML documents in the INFO column.

```

VALUES
(XMLQUERY
 ('db2-fn:xmlcolumn("CUSTOMER.INFO")/customerinfo/phone'))

```

XMLQUERY is then applied to this single sequence of XML documents, and the result set contains only one row, as follows:

```

1
-----
<phone type="work">905-555-7258</phone><phone type="work">905-555-7258</
phone><phone type="home">416-555-2937</phone><phone type="cell">905-555-
8743</phone><phone type="cottage">613-555-3278</phone>

```

1 record(s) selected.

All <phone> elements from the XML documents in the INFO column are returned in a single row, because XMLQUERY operates on a single value: the sequence of XML documents returned from db2-fn:xmlcolumn.

## Empty sequences returned by XMLQUERY

The XMLQUERY functions returns an empty sequence, if the XQuery expression specified within it returns an empty sequence.

For example, in the following query, XMLQUERY will return an empty sequence for each row of the CUSTOMER table that does not have a <city> element with a value of "Aurora", in the INFO column.

```

SELECT Cid, XMLQUERY ('$d//addr[city="Aurora"]' passing INFO as "d") AS ADDRESS
FROM CUSTOMER

```

Assume that there are three rows of the CUSTOMER table, but only one XML document that contains a <city> element with the value of "Aurora". The following table would result from the previous SELECT statement (the output has been formatted for clarity).

Table 7. Result table

CID	ADDRESS
1001	
1002	
1003	<addr country="Canada"><street>1596 Baseline</street><city>Aurora</city><prov-state>Ontario</prov-state><pcode-zip>N8X-7F8</pcode-zip></addr>

Notice how empty sequences of zero-length serialized XML, rather than NULL values, are returned for rows that do not have a <city> element with the value of "Aurora". The <addr> element is returned in the third row, however, because it satisfies the XQuery expression. In the third row, a non-empty sequence is returned.

You can avoid returning rows that contain empty sequences by applying a predicate, such as XMLEXISTS, in the WHERE clause of your statement, rather than in the SELECT clause. For example, the previous query can be rewritten as follows, moving the filtering predicate from the XMLQUERY function, to the WHERE clause:

```
SELECT CID, XMLQUERY ('$d/customerinfo/addr' passing c.INFO as "d")
FROM Customer as c
WHERE XMLEXISTS ('$d//addr[city="Aurora"]' passing c.INFO as "d")
```

The table that results from this query is as follows:

Table 8. Result table

CID	ADDRESS
1003	<addr country="Canada"><street>1596 Baseline</street><city>Aurora</city><prov-state>Ontario</prov-state><pcode-zip>N8X-7F8</pcode-zip></addr>

XMLQUERY is commonly used in a SELECT clause to return fragments of selected documents. Predicates specified in the XQuery expression of XMLQUERY do not filter rows from the result set, they are used only to determine what fragments are returned. To actually eliminate rows from your result set, you need to apply a predicate in the WHERE clause. The XMLEXISTS predicate can be used to apply predicates that depend on values within stored XML documents.

## Casting of XMLQUERY results to non-XML types

If you want to return the results of the XMLQUERY function to the SQL context for further processing, such as for comparison or ordering operations, you need to cast the XML value that is returned to a compatible SQL type. The XMLCAST specification enables you to cast between XML and non-XML values.

### Note:

1. You can cast the result of XMLQUERY to an SQL data type only when the XQuery expression specified in XMLQUERY returns a sequence that contains one item that has been atomized.
2. In a non-UTF-8 database, casting the result of XMLQUERY to an SQL data type causes code page conversion to occur as the returned value is converted from an internal UTF-8 encoding to the database code page. Any code points in the returned value that are not part of the database code page will be replaced by

substitution characters. The introduction of substitution characters might cause unexpected behavior for comparisons between XML and non-XML values, so care should be taken to ensure that the stored XML data contains only code points that are included in the database code page.

### Example: Comparing XML values to non-XML values in a query

In the following query, the sequence returned by XMLQUERY is cast from its XML type to a character type, so that it can be compared with the NAME column of the PRODUCT table. (If the XML value that results from XMLQUERY is not a serialized string, then the XMLCAST operation could fail.)

```
SELECT R.Pid
FROM PURCHASEORDER P, PRODUCT R
WHERE R.NAME =
      XMLCAST( XMLQUERY ('$d/PurchaseOrder/item/name'
                        PASSING P.PORDER AS "d") AS VARCHAR(128))
```

### Example: Ordering by XMLQUERY results

In the following query, product IDs are returned in an order sorted by the value of the <name> element of the product's description, which is stored as an XML document. Because SQL cannot sort on XML values, the sequence must be cast to a value that SQL can order on, in this case, character.

```
SELECT Pid
FROM PRODUCT
ORDER BY XMLCAST(XMLQUERY ('$d/product/description/name'
                          PASSING DESCRIPTION AS "d") AS VARCHAR(128))
```

## Casting between data types

There are many occasions where a value with a given data type needs to be *cast* to a different data type or to the same data type with a different length, precision, or scale.

Data type promotion is one example where the promotion of one data type to another data type requires that the value be cast to the new data type. A data type that can be cast to another data type is *castable* from the source data type to the target data type.

The casting of one data type to another can occur implicitly or explicitly. The cast functions, CAST specification, or XMLCAST specification can be used to explicitly change a data type, depending on the data types involved. In addition, when a sourced user-defined function is created, the data types of the parameters of the source function must be castable to the data types of the function that is being created.

The supported casts between built-in data types are shown in Table 9 on page 79. The first column represents the data type of the cast operand (source data type), and the data types across the header row represent the target data type of the cast operation. A 'Y' indicates that the CAST specification can be used for the combination of source and target data types. Cases in which only the XMLCAST specification can be used are noted.

If truncation occurs when any data type is cast to a character or graphic data type, a warning is returned if any non-blank characters are truncated. This truncation behavior is unlike the assignment to a character or graphic data type, when an error occurs if any non-blank characters are truncated.

The following casts involving distinct types are supported (using the CAST specification unless noted otherwise):

- Cast from distinct type *DT* to its source data type *S*
- Cast from the source data type *S* of distinct type *DT* to distinct type *DT*
- Cast from distinct type *DT* to the same distinct type *DT*
- Cast from a data type *A* to distinct type *DT* where *A* is promotable to the source data type *S* of distinct type *DT*
- Cast from an INTEGER to distinct type *DT* with a source data type SMALLINT
- Cast from a DOUBLE to distinct type *DT* with a source data type REAL
- Cast from a DECFLOAT to distinct type *DT* with a source data type of DECFLOAT
- Cast from a VARCHAR to distinct type *DT* with a source data type CHAR
- Cast from a VARGRAPHIC to distinct type *DT* with a source data type GRAPHIC
- For a Unicode database, cast from a VARCHAR or a VARGRAPHIC to distinct type *DT* with a source data type CHAR or GRAPHIC
- Cast from a distinct type *DT* with a source data type *S* to XML using the XMLCAST specification
- Cast from an XML to a distinct type *DT* with a source data type of any built-in data type, using the XMLCAST specification depending on the XML schema data type of the XML value

FOR BIT DATA character types cannot be cast to CLOB.

For casts that involve an array type as a target, the data type of the elements of the source array value must be castable to the data type of the elements of the target array data (SQLSTATE 42846). If the target array type is an ordinary array, the source array value must be an ordinary array (SQLSTATE 42821) and the cardinality of the source array value must be less than or equal to the maximum cardinality of the target array data type (SQLSTATE 2202F). If the target array type is an associative array, the data type of the index for the source array value must be castable to data type of the index for the target array type. A user-defined array type value can be cast only to the same user-defined array type (SQLSTATE 42846).

A cursor type cannot be either the source data type or the target data type of a CAST specification, except to cast a parameter marker to a cursor type.

For casts that involve a row type as a target, the degree of the source row value expression and degree of the target row type must match and each field in the source row value expression must be castable to the corresponding target field. A user-defined row type value can only be cast to another user-defined row-type with the same name (SQLSTATE 42846).

It is not possible to cast a structured type value to something else. A structured type *ST* should not need to be cast to one of its supertypes, because all methods on the supertypes of *ST* are applicable to *ST*. If the required operation is only applicable to a subtype of *ST*, use the subtype-treatment expression to treat *ST* as one of its subtypes.

When a user-defined data type involved in a cast is not qualified by a schema name, the *SQL path* is used to find the first schema that includes the user-defined data type by that name.



The following casts involving reference types are supported:

- cast from reference type *RT* to its representation data type *S*
- cast from the representation data type *S* of reference type *RT* to reference type *RT*
- cast from reference type *RT* with target type *T* to a reference type *RS* with target type *S* where *S* is a supertype of *T*.
- cast from a data type *A* to reference type *RT*, where *A* is promotable to the representation data type *S* of reference type *RT*.

When the target type of a reference data type involved in a cast is not qualified by a schema name, the *SQL path* is used to find the first schema that includes the user-defined data type by that name.

Table 9. Supported Casts between Built-in Data Types

Source Data Type	Target Data Type																				
	S	M	A	N	B	I	D	E	D	C	H	V	H	C	C	G	R	R	D	T	B
SMALLINT	Y	Y	Y	Y	Y	Y	Y	Y	Y	Y	Y	Y	-	Y <sup>1</sup>	Y <sup>1</sup>	-	-	-	-	Y <sup>3</sup>	Y <sup>7</sup>
INTEGER	Y	Y	Y	Y	Y	Y	Y	Y	Y	Y	Y	Y	-	Y <sup>1</sup>	Y <sup>1</sup>	-	-	-	-	Y <sup>3</sup>	Y <sup>7</sup>
BIGINT	Y	Y	Y	Y	Y	Y	Y	Y	Y	Y	Y	Y	-	Y <sup>1</sup>	Y <sup>1</sup>	-	-	-	-	Y <sup>3</sup>	Y <sup>7</sup>
DECIMAL	Y	Y	Y	Y	Y	Y	Y	Y	Y	Y	Y	Y	-	Y <sup>1</sup>	Y <sup>1</sup>	-	-	-	-	Y <sup>3</sup>	-
REAL	Y	Y	Y	Y	Y	Y	Y	Y	Y	Y	Y	Y	-	Y <sup>1</sup>	Y <sup>1</sup>	-	-	-	-	Y <sup>3</sup>	-
DOUBLE	Y	Y	Y	Y	Y	Y	Y	Y	Y	Y	Y	Y	-	Y <sup>1</sup>	Y <sup>1</sup>	-	-	-	-	Y <sup>3</sup>	-
DECFLOAT	Y	Y	Y	Y	Y	Y	Y	Y	Y	Y	Y	Y	-	Y <sup>1</sup>	Y <sup>1</sup>	-	-	-	-	-	-
CHAR	Y	Y	Y	Y	Y	Y	Y	Y	Y	Y	Y	Y	Y	Y <sup>1</sup>	Y <sup>1</sup>	Y <sup>1</sup>	Y	Y	Y	Y	Y <sup>4</sup>
CHAR FOR BIT DATA	Y	Y	Y	Y	Y	Y	Y	Y	Y	Y	Y	Y	-	-	-	-	Y	Y	Y	Y	Y <sup>3</sup>
VARCHAR	Y	Y	Y	Y	Y	Y	Y	Y	Y	Y	Y	Y	Y	Y <sup>1</sup>	Y <sup>1</sup>	Y <sup>1</sup>	Y	Y	Y	Y	Y <sup>4</sup>
VARCHAR FOR BIT DATA	Y	Y	Y	Y	Y	Y	Y	Y	Y	Y	Y	Y	-	-	-	-	Y	Y	Y	Y	Y <sup>3</sup>
CLOB	-	-	-	-	-	-	-	Y	-	Y	-	Y	Y <sup>1</sup>	Y <sup>1</sup>	Y <sup>1</sup>	Y	Y	Y	Y	Y <sup>4</sup>	-
GRAPHIC	Y <sup>1</sup>	Y <sup>1</sup>	Y <sup>1</sup>	Y <sup>1</sup>	Y <sup>1</sup>	Y <sup>1</sup>	Y <sup>1</sup>	Y <sup>1</sup>	-	Y <sup>1</sup>	-	Y <sup>1</sup>	Y	Y	Y	Y	Y	Y <sup>1</sup>	Y <sup>1</sup>	Y <sup>1</sup>	Y <sup>3</sup>
VARGRAPHIC	Y <sup>1</sup>	Y <sup>1</sup>	Y <sup>1</sup>	Y <sup>1</sup>	Y <sup>1</sup>	Y <sup>1</sup>	Y <sup>1</sup>	Y <sup>1</sup>	-	Y <sup>1</sup>	-	Y <sup>1</sup>	Y	Y	Y	Y	Y	Y <sup>1</sup>	Y <sup>1</sup>	Y <sup>1</sup>	Y <sup>3</sup>
DBCLOB	-	-	-	-	-	-	-	Y <sup>1</sup>	-	Y <sup>1</sup>	-	Y <sup>1</sup>	Y	Y	Y	Y	Y	-	-	-	Y <sup>3</sup>
BLOB	-	-	-	-	-	-	-	-	Y	-	Y	-	-	-	-	-	Y	-	-	-	Y <sup>4</sup>
DATE	-	Y	Y	Y	-	-	-	Y	Y	Y	Y	-	Y <sup>1</sup>	Y <sup>1</sup>	-	-	Y	-	Y	Y <sup>3</sup>	-
TIME	-	Y	Y	Y	-	-	-	Y	Y	Y	Y	-	Y <sup>1</sup>	Y <sup>1</sup>	-	-	-	Y	-	Y <sup>3</sup>	-
TIMESTAMP	-	-	Y	Y	-	-	-	Y	Y	Y	Y	-	Y <sup>1</sup>	Y <sup>1</sup>	-	-	Y	Y	Y	Y <sup>3</sup>	-
XML	Y <sup>5</sup>	Y <sup>5</sup>	Y <sup>5</sup>	Y <sup>5</sup>	Y <sup>5</sup>	Y <sup>5</sup>	Y <sup>5</sup>	Y <sup>5</sup>	Y <sup>5</sup>	Y <sup>5</sup>	Y <sup>5</sup>	Y <sup>5</sup>	Y <sup>5</sup>	Y <sup>5</sup>	Y <sup>5</sup>	Y <sup>5</sup>	Y <sup>5</sup>	Y <sup>5</sup>	Y <sup>5</sup>	Y <sup>5</sup>	Y

Table 9. Supported Casts between Built-in Data Types (continued)

Source Data Type	Target Data Type																																		
	S	M	A	L	I	G	N	T	D	E	H	A	A	R	D <sup>2</sup>	V	H	A	A	B	C	R	D <sup>2</sup>	B	C	C	B	B	E	E	P	L	N		
BOOLEAN	Y <sup>7</sup>	Y <sup>7</sup>	Y <sup>7</sup>	-	-	-	-	-	-	-	-	-	-	-	-	-	-	-	-	-	-	-	-	-	-	-	-	-	-	-	-	-	-	-	Y <sup>7</sup>

**Notes**

- See the description preceding the table for information about supported casts involving user-defined types and reference types.
- It is not possible to cast a structured type value to anything else.
- The LONG VARCHAR and LONG VARGRAPHIC data types continue to be supported but are deprecated, not recommended, and might be removed in a future release.

<sup>1</sup> Cast is only supported for Unicode databases.

<sup>2</sup> FOR BIT DATA

<sup>3</sup> Cast can only be performed using XMLCAST.

<sup>4</sup> An XMLPARSE function is implicitly processed to convert a string to XML on assignment (INSERT or UPDATE) of a string to an XML column. The string must be a well-formed XML document for the assignment to succeed.

<sup>5</sup> Cast can only be performed using XMLCAST and depends on the underlying XML schema data type of the XML value. For details, see "XMLCAST".

<sup>6</sup> A cursor type cannot be either the source data type or the target data type of a CAST specification, except to cast a parameter marker to a cursor type.

<sup>7</sup> Only supported using the CAST specification. No cast function exists.

Table 10 shows where to find information about the rules that apply when casting to the identified target data types.

Table 10. Rules for Casting to a Data Type

Target Data Type	Rules
SMALLINT	If the source type is BOOLEAN, then TRUE is cast to 1 and FALSE is cast to 0. For all other source types, see "SMALLINT scalar function" in <i>SQL Reference Volume 1</i>
INTEGER	If the source type is BOOLEAN, then TRUE is cast to 1 and FALSE is cast to 0. For all other source types, see "INTEGER scalar function" in <i>SQL Reference Volume 1</i>
BIGINT	If the source type is BOOLEAN, then TRUE is cast to 1 and FALSE is cast to 0. For all other source types, see "BIGINT scalar function" in <i>SQL Reference Volume 1</i>

Table 10. Rules for Casting to a Data Type (continued)

Target Data Type	Rules
DECIMAL	"DECIMAL scalar function" in <i>SQL Reference Volume 1</i>
NUMERIC	"DECIMAL scalar function" in <i>SQL Reference Volume 1</i>
REAL	"REAL scalar function" in <i>SQL Reference Volume 1</i>
DOUBLE	"DOUBLE scalar function" in <i>SQL Reference Volume 1</i>
DECFLOAT	"DECFLOAT scalar function" in <i>SQL Reference Volume 1</i>
CHAR	"CHAR scalar function" in <i>SQL Reference Volume 1</i>
VARCHAR	"VARCHAR scalar function" in <i>SQL Reference Volume 1</i>
CLOB	"CLOB scalar function" in <i>SQL Reference Volume 1</i>
GRAPHIC	"GRAPHIC scalar function" in <i>SQL Reference Volume 1</i>
VARGRAPHIC	"VARGRAPHIC scalar function" in <i>SQL Reference Volume 1</i>
DBCLOB	"DBCLOB scalar function" in <i>SQL Reference Volume 1</i>
BLOB	"BLOB scalar function" in <i>SQL Reference Volume 1</i>
DATE	"DATE scalar function" in <i>SQL Reference Volume 1</i>
TIME	"TIME scalar function" in <i>SQL Reference Volume 1</i>
TIMESTAMP	If the source type is a character string, see "TIMESTAMP scalar function" in <i>SQL Reference Volume 1</i> , where one operand is specified. If the source data type is a DATE, the timestamp is composed of the specified date and a time of 00:00:00.
BOOLEAN	If the source type is numeric, then 0 is cast to FALSE and 1 is cast to TRUE. NULL is cast to NULL.

## Casting non-XML values to XML values

Table 11. Supported Casts from Non-XML Values to XML Values

Source Data Type	Target Data Type	
	XML	Resulting XML Schema Type
SMALLINT	Y	xs:short
INTEGER	Y	xs:int
BIGINT	Y	xs:long
DECIMAL or NUMERIC	Y	xs:decimal

Table 11. Supported Casts from Non-XML Values to XML Values (continued)

Source Data Type	Target Data Type	
	XML	Resulting XML Schema Type
REAL	Y	xs:float
DOUBLE	Y	xs:double
DECFLOAT	N	-
CHAR	Y	xs:string
VARCHAR	Y	xs:string
CLOB	Y	xs:string
GRAPHIC	Y	xs:string
VARGRAPHIC	Y	xs:string
DBCLOB	Y	xs:string
DATE	Y	xs:date
TIME	Y	xs:time
TIMESTAMP	Y	xs:dateTime <sup>1</sup>
BLOB	Y	xs:base64Binary
character type FOR BIT DATA	Y	xs:base64Binary
distinct type		use this chart with the source type of the distinct type

#### Notes

<sup>1</sup> The source data type TIMESTAMP supports timestamp precision of 0 to 12. The maximum fractional seconds precision of xs:dateTime is 6. If the timestamp precision of a TIMESTAMP source data type exceeds 6, the value is truncated when cast to xs:dateTime.

The LONG VARCHAR and LONG VARGRAPHIC data types continue to be supported but are deprecated, not recommended, and might be removed in a future release.

When character string values are cast to XML values, the resulting xs:string atomic value cannot contain illegal XML characters (SQLSTATE 0N002). If the input character string is not in Unicode, the input characters are converted to Unicode.

Casting to SQL binary types results in XQuery atomic values with the type xs:base64Binary.

### Casting XML values to non-XML values

An XMLCAST from an XML value to a non-XML value can be described as two casts: an XQuery cast that converts the source XML value to an XQuery type corresponding to the SQL target type, followed by a cast from the corresponding XQuery type to the actual SQL type.

An XMLCAST is supported if the target type has a corresponding XQuery target type that is supported, and if there is a supported XQuery cast from the source value's type to the corresponding XQuery target type. The target type that is used in the XQuery cast is based on the corresponding XQuery target type and might contain some additional restrictions.

The following table lists the XQuery types that result from such conversion.

Table 12. Supported Casts from XML Values to Non-XML Values

Target Data Type	Source Data Type	
	XML	Corresponding XQuery Target Type
SMALLINT	Y	xs:short
INTEGER	Y	xs:int
BIGINT	Y	xs:long
DECIMAL or NUMERIC	Y	xs:decimal
REAL	Y	xs:float
DOUBLE	Y	xs:double
DECFLOAT	Y	no matching type <sup>1</sup>
CHAR	Y	xs:string
VARCHAR	Y	xs:string
CLOB	Y	xs:string
GRAPHIC	Y	xs:string
VARGRAPHIC	Y	xs:string
DBCLOB	Y	xs:string
DATE	Y	xs:date
TIME (without time zone)	Y	xs:time
TIMESTAMP (without time zone)	Y	xs:dateTime <sup>2</sup>
BLOB	Y	xs:base64Binary
CHAR FOR BIT DATA	N	not castable
VARCHAR FOR BIT DATA	Y	xs:base64Binary
distinct type		use this chart with the source type of the distinct type
row, reference, structured or abstract data type (ADT), other	N	not castable

**Notes**

<sup>1</sup> DB2 supports XML Schema 1.0, which does not provide a matching XML schema type for a DECFLOAT. Processing of the XQuery cast step of XMLCAST is handled as follows:

- If the source value is typed with an XML schema numeric type, use that numeric type.
- If the source value is typed with the XML schema type xs:boolean, use xs:double.
- Otherwise, use xs:string with additional checking for a valid numeric format.

<sup>2</sup> The maximum fractional seconds precision of xs:dateTime is 6. The source data type TIMESTAMP supports timestamp precision of 0 to 12. If the timestamp precision of a TIMESTAMP target data type is less than 6, the value is truncated when cast from xs:dateTime. If the timestamp precision of a TIMESTAMP target data type exceeds 6, the value is padded with zeros when cast from xs:dateTime.

In the following restriction cases, a derived by restriction XML schema data type is effectively used as the target data type for the XQuery cast.

- XML values that are to be converted to string types other than CHAR and VARCHAR must fit within the length limits of those DB2 types without truncation of any characters or bytes. The name used for the derived XML schema type is the uppercase SQL type name followed by an underscore

character and the maximum length of the string; for example, CLOB\_1048576 if the XMLCAST target data type is CLOB(1M) .

If an XML value is converted to a CHAR or VARCHAR type that is too small to contain all of the data, the data is truncated to fit the specified data type and no error is returned. If any non-blank characters are truncated, a warning (SQLSTATE 01004) is returned. If truncation of the value leads to the truncation of a multibyte character, the whole multibyte character is removed. Therefore, in some cases, truncation can produce a shorter string than expected. For example, the character, ñ, is represented in UTF-8 by 2 bytes, 'C3 B1'. When this character is cast as VARCHAR(1), the truncation of 'C3 B1' to 1 byte would leave a partial character of 'C3'. This partial character, 'C3', is also removed, therefore the final result is an empty string.

- XML values that are to be converted to DECIMAL values must have no more than (*precision - scale*) digits before the decimal point; excess digits after the decimal point beyond the scale are truncated. The name used for the derived XML schema type is DECIMAL\_*precision\_scale*, where *precision* is the precision of the target SQL data type, and *scale* is the scale of the target SQL data type; for example, DECIMAL\_9\_2 if the XMLCAST target data type is DECIMAL(9,2).
- XML values that are to be converted to TIME values cannot contain a seconds component with nonzero digits after the decimal point. The name used for the derived XML schema type is TIME.

The derived XML schema type name only appears in a message if an XML value does not conform to one of these restrictions. This type name helps one to understand the error message, and does not correspond to any defined XQuery type. If the input value does not conform to the base type of the derived XML schema type (the corresponding XQuery target type), the error message might indicate that type instead. Because this derived XML schema type name format might change in the future, it should not be used as a programming interface.

Before an XML value is processed by the XQuery cast, any document node in the sequence is removed and each direct child of the removed document node becomes an item in the sequence. If the document node has multiple direct children nodes, the revised sequence will have more items than the original sequence. The XML value without any document nodes is then atomized using the XQuery fn:data function, with the resulting atomized sequence value used in the XQuery cast. If the atomized sequence value is an empty sequence, a null value is returned from the cast without any further processing. If there are multiple items in the atomized sequence value, an error is returned (SQLSTATE 10507).

If the target type of XMLCAST is the SQL data type DATE, TIME, or TIMESTAMP, the resulting XML value from the XQuery cast is also adjusted to UTC, and the time zone component of the value is removed.

When the corresponding XQuery target type value is converted to the SQL target type, binary XML data types, such as xs:base64Binary or xs:hexBinary, are converted from character form to actual binary data.

If an xs:double or xs:float value of INF, -INF, or NaN is cast (using XMLCAST) to an SQL data type DOUBLE or REAL value, an error is returned (SQLSTATE 22003). An xs:double or xs:float value of -0 is converted to +0.

The target type can be a user-defined distinct type if the source operand is not a user-defined distinct type. In this case, the source value is cast to the source type

of the user-defined distinct type (that is, the target type) using the XMLCAST specification, and then this value is cast to the user-defined distinct type using the CAST specification.

In a non-Unicode database, casting from an XML value to a non-XML target type involves code page conversion from an internal UTF-8 format to the database code page. This conversion will result in the introduction of substitution characters if any code point in the XML value is not present in the database code page.

## XMLQUERY

The XMLQUERY function returns an XML value from the evaluation of an XQuery expression possibly using specified input arguments as XQuery variables.

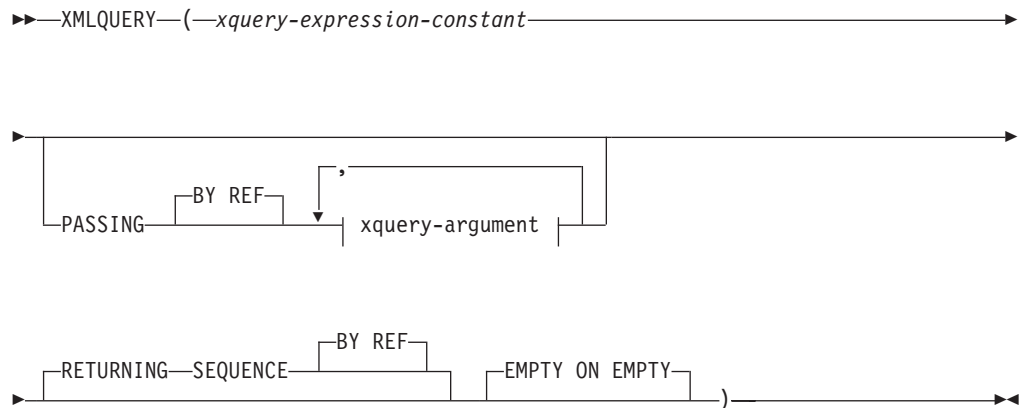

### xquery-argument:

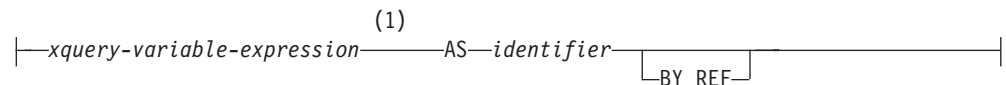

### Notes:

- 1 The data type of the expression cannot be DECFLOAT.

The schema is SYSIBM. The function name cannot be specified as a qualified name.

### xquery-expression-constant

Specifies an SQL character string constant that is interpreted as an XQuery expression using supported XQuery language syntax. The constant string is converted to UTF-8 before being parsed as an XQuery statement. The XQuery expression executes using an optional set of input XML values, and returns an output sequence that is also returned as the value of the XMLQUERY expression. The value for *xquery-expression-constant* must not be an empty string or a string of blank characters (SQLSTATE 10505).

### PASSING

Specifies input values and the manner in which these values are passed to the XQuery expression specified by *xquery-expression-constant*. By default, every unique column name that is in the scope where the function is invoked is implicitly passed to the XQuery expression using the name of the column as the variable name. If an *identifier* in a specified *xquery-argument* matches an in-scope column name, then the explicit *xquery-argument* is passed to the XQuery expression overriding that implicit column.

**BY REF**

Specifies that the default passing mechanism is by reference for any *xquery-variable-expression* of data type XML and for the returned value. When XML values are passed by reference, the XQuery evaluation uses the input node trees, if any, directly from the specified input expressions, preserving all properties, including the original node identities and document order. If two arguments pass the same XML value, node identity comparisons and document ordering comparisons involving some nodes contained between the two input arguments might refer to nodes within the same XML node tree.

This clause has no impact on how non-XML values are passed. The non-XML values create a new copy of the value during the cast to XML.

**xquery-argument**

Specifies an argument that is to be passed to the XQuery expression specified by *xquery-expression-constant*. An argument specifies a value and the manner in which that value is to be passed. The argument includes an SQL expression that is evaluated.

- If the resulting value is of type XML, it becomes an *input-xml-value*. A null XML value is converted to an XML empty sequence.
- If the resulting value is not of type XML, it must be castable to the XML data type. A null value is converted to an XML empty sequence. The converted value becomes an *input-xml-value*.

When the *xquery-expression-constant* is evaluated, an XQuery variable is presented with a value equal to *input-xml-value* and a name specified by the AS clause.

*xquery-variable-expression*

Specifies an SQL expression whose value is available to the XQuery expression specified by *xquery-expression-constant* during execution. The expression cannot contain a sequence reference (SQLSTATE 428F9) or an OLAP function (SQLSTATE 42903). The data type of the expression cannot be DECFLOAT.

**AS identifier**

Specifies that the value generated by *xquery-variable-expression* will be passed to *xquery-expression-constant* as an XQuery variable. The variable name will be *identifier*. The leading dollar sign (\$) that precedes variable names in the XQuery language is not included in *identifier*. The identifier must be a valid XQuery variable name and is restricted to an XML NCName (SQLSTATE 42634). The identifier must not be greater than 128 bytes in length. Two arguments within the same PASSING clause cannot use the same identifier (SQLSTATE 42711).

**BY REF**

Indicates that an XML input value is to be passed by reference. When XML values are passed by reference, the XQuery evaluation uses the input node trees, if any, directly from the specified input expressions, preserving all properties, including the original node identities and document order. If two arguments pass the same XML value, node identity comparisons and document ordering comparisons involving some nodes contained between the two input arguments might refer to nodes within the same XML node tree. If BY REF is not specified following an *xquery-variable-expression*, XML arguments are passed by way of the default passing mechanism that is provided through the syntax that follows the PASSING keyword. This option cannot be



specified for non-XML values. When a non-XML value is passed, the value is converted to XML; this process creates a copy.

#### **RETURNING SEQUENCE**

Indicates that the XMLQUERY expression returns a sequence.

#### **BY REF**

Indicates that the result of the XQuery expression is returned by reference. If this value contains nodes, any expression using the return value of the XQuery expression will receive node references directly, preserving all node properties, including the original node identities and document order. Referenced nodes will remain connected within their node trees. If the BY REF clause is not specified and the PASSING is specified, the default passing mechanism is used. If BY REF is not specified and PASSING is not specified, the default returning mechanism is BY REF.

#### **EMPTY ON EMPTY**

Specifies that an empty sequence result from processing the XQuery expression is returned as an empty sequence.

The data type of the result is XML; it cannot be null.

If the evaluation of the XQuery expression results in an error, then the XMLQUERY function returns the XQuery error (SQLSTATE class '10').

### **Notes**

- **XMLQUERY usage restrictions:** The XMLQUERY function cannot be:
  - Part of the ON clause that is associated with a JOIN operator or a MERGE statement (SQLSTATE 42972)
  - Part of the GENERATE KEY USING or RANGE THROUGH clause in the CREATE INDEX EXTENSION statement (SQLSTATE 428E3)
  - Part of the FILTER USING clause in the CREATE FUNCTION (External Scalar) statement, or the FILTER USING clause in the CREATE INDEX EXTENSION statement (SQLSTATE 428E4)
  - Part of a check constraint or a column generation expression (SQLSTATE 42621)
  - Part of a group-by-clause (SQLSTATE 42822)
  - Part of an argument for a column-function (SQLSTATE 42607)
- **XMLQUERY as a subquery:** An XMLQUERY expression that acts as a subquery can be restricted by statements that restrict subqueries.

---

## **XMLTABLE function overview**

XMLTABLE is an SQL table function that returns a table from the evaluation of XQuery expressions. XQuery expressions normally return values as a sequence, however, XMLTABLE allows you to execute an XQuery expression and return values as a table instead. The table that is returned can contain columns of any SQL data type, including XML.

Like the XMLQUERY function, you can pass variables to the XQuery expression specified in XMLTABLE. The result of the XQuery expression is used to generate the column values of the resulting table. The structure of the resulting table is defined by the COLUMNS clause of XMLTABLE. In this clause, you define characteristics of the column by specifying the column name, data type, and how the column value is generated. A simpler syntax for passing the column name

without having to specify the name explicitly is also available. See “Simple column name passing with XMLEXISTS, XMLQUERY, or XMLTABLE” on page 105.

The column value of the resulting table can be generated by specifying an XQuery expression in the PATH clause of XMLTABLE. If an XQuery expression is not specified for the PATH clause, the column name is used as the XQuery expression to generate the column value, and the result of the XQuery expression specified earlier in XMLTABLE becomes the external context item when generating the column value. An optional default clause can also be specified to provide a default value for the column, for the case when the XQuery expression of the PATH clause that generates the column value returns an empty sequence.

For example, the following SELECT statement references the INFO column of the CUSTOMER table in the XQuery expression in the XMLTABLE function.

```
SELECT X.*
FROM CUSTOMER C, XMLTABLE ('$INFO/customerinfo'
    COLUMNS
    CUSTNAME CHAR(30) PATH 'name',
    PHONENUM XML PATH 'phone')
    as X
WHERE C.CID < 1003
```

If the column type in the resulting table is not XML, and the result of the XQuery expression that defines the value of the column is not an empty sequence, XMLCAST is implicitly used to convert the XML value to a value of the target data type.

The XMLTABLE function allows you to optionally declare namespaces. If you specify namespaces with the XMLNAMESPACES declaration, then these namespace bindings apply to all XQuery expressions in the XMLTABLE function call. If you declare namespace bindings without using the XMLNAMESPACES declaration, then the bindings apply only to the row XQuery expression, which follows the namespace declaration.

## XMLTABLE advantages

Returning a table instead of a sequence enables the following operations to be performed from within an SQL query context:

- iterate over results of an XQuery expression from within an SQL fullselect

For example, in the following query, the SQL fullselect iterates over the table that results from executing the XQuery expression "db2-fn:xmlcolumn("CUSTOMER.INFO")/customerinfo" in XMLTABLE.

```
SELECT X.*
FROM XMLTABLE ('db2-fn:xmlcolumn("CUSTOMER.INFO")/customerinfo'
    COLUMNS "CUSTNAME" CHAR(30) PATH 'name',
    "PHONENUM" XML PATH 'phone')
    as X
```

- insert values from stored XML documents into tables (refer to the XMLTABLE example on inserting values)

- sort on values from an XML doc

For example, in the following query, results are sorted by the customer names that are stored in XML documents in the INFO column of the CUSTOMER table.

```

SELECT X.*
FROM XMLTABLE ('db2-fn:xmlcolumn("CUSTOMER.INFO")/customerinfo'
              COLUMNS "CUSTNAME" CHAR(30) PATH 'name',
                      "PHONENUM" XML PATH 'phone')
              as X
ORDER BY X.CUSTNAME

```

- store some XML values as relational and some as XML (refer to the XMLTABLE example on inserting values)

**Important:** If the XQuery expression specified in the PATH option of XMLTABLE returns:

- a sequence of more than one item, then the data type of the column must be XML. If you are inserting values returned from XMLTABLE into XML columns, ensure that the values inserted are well-formed XML documents. Refer to the XMLTABLE example on inserting values for an example of handling sequences that return more than one item.
- an empty sequence, then a NULL value is returned for that column value.

## Example: Inserting values returned from XMLTABLE

The XMLTABLE SQL table function can be used to retrieve values from within stored XML documents, which can then be inserted into a table.

This technique is a simple form of decomposition, where decomposition is the process of storing fragments of an XML document in columns of relational tables. (A more general type of decomposition is available with the annotated XML schema decomposition functionality. With annotated XML schema decomposition, you can decompose multiple XML documents at once into multiple tables.)

For example, if the following two XML documents were stored in a table named CUSTOMER:

```

<customerinfo Cid="1001">
  <name>Kathy Smith</name>
  <addr country="Canada">
    <street>25 EastCreek</street>
    <city>Markham</city>
    <prov-state>Ontario</prov-state>
    <pcode-zip>N9C 3T6</pcode-zip>
  </addr>
  <phone type="work">905-555-7258</phone>
</customerinfo>

<customerinfo Cid="1003">
  <name>Robert Shoemaker</name>
  <addr country="Canada">
    <street>1596 Baseline</street>
    <city>Aurora</city>
    <prov-state>Ontario</prov-state>
    <pcode-zip>N8X 7F8</pcode-zip>
  </addr>
  <phone type="work">905-555-7258</phone>
  <phone type="home">416-555-2937</phone>
  <phone type="cell">905-555-8743</phone>
  <phone type="cottage">613-555-3278</phone>
</customerinfo>

```

and you wanted to insert values from these documents into a table defined as:

```
CREATE TABLE CUSTPHONE (custname char(30), numbers XML)
```

then the following INSERT statement using XMLTABLE populates CUSTPHONE with values from the XML documents:

```
INSERT INTO CUSTPHONE
SELECT X.*
FROM XMLTABLE ('db2-fn:xmlcolumn("CUSTOMER.INFO")/customerinfo'
COLUMNS
    "CUSTNAME" CHAR(30) PATH 'name',
    "PHONENUM" XML PATH 'document{<allphones>{phone}</allphones>}'
) as X
```

Notice that the XQuery node constructor function "document{<allphones>{phone}</allphones>}" is specified in the path expression for the PHONENUM column in XMLTABLE. The document constructor is needed because values inserted into XML columns (the NUMBERS column, in this case), must be well-formed XML documents. In this example, all <phone> elements for the <customerinfo> document with Cid="1003" are returned in a single sequence that contains four items:

```
{<phone type="work">905-555-7258</phone>, <phone type="home">416-555-2937</phone>,
<phone type="cell">905-555-8743</phone>, <phone type="cottage">613-555-3278</phone>}
```

This sequence on its own is not a well-formed XML document, and so cannot be inserted into the NUMBERS XML column. To ensure that the phone values are successfully inserted, all items of the sequence are constructed into a single well-formed document.

The resulting table is as follows (the output has been formatted for clarity):

Table 13. Result table

CUSTNAME	NUMBER
Kathy Smith	<allphones> <phone type="work">905-555-7258</phone> </allphones>
Robert Shoemaker	<allphones> <phone type="work">905-555-7258</phone> <phone type="home">416-555-2937</phone> <phone type="cell">905-555-8743</phone> <phone type="cottage">613-555-3278</phone> </allphones>

## Example: Returning one row for each occurrence of an item using XMLTABLE

If your XML documents contain multiple occurrences of an element and you want to generate a row for each occurrence of this element, you can use XMLTABLE to achieve this effect.

For example, if the following two XML documents were stored in a table named CUSTOMER:

```
<customerinfo Cid="1001">
  <name>Kathy Smith</name>
  <addr country="Canada">
    <street>25 EastCreek</street>
    <city>Markham</city>
    <prov-state>Ontario</prov-state>
    <pcode-zip>N9C 3T6</pcode-zip>
  </addr>
  <phone type="work">905-555-7258</phone>
```

```

</customerinfo>

<customerinfo Cid="1003">
  <name>Robert Shoemaker</name>
  <addr country="Canada">
    <street>1596 Baseline</street>
    <city>Aurora</city>
    <prov-state>Ontario</prov-state>
    <pcode-zip>N8X 7F8</pcode-zip>
  </addr>
  <phone type="work">905-555-7258</phone>
  <phone type="home">416-555-2937</phone>
  <phone type="cell">905-555-8743</phone>
  <phone type="cottage">613-555-3278</phone>
</customerinfo>

```

to create a table where every <phone> value is stored in a separate row, use XMLTABLE as follows:

```

SELECT X.*
FROM CUSTOMER C, XMLTABLE ('$cust/customerinfo/phone' PASSING C.INFO as "cust"
                           COLUMNS "CUSTNAME" CHAR(30) PATH '../name',
                                   "PHONETYPE" CHAR(30) PATH '@type',
                                   "PHONENUM" CHAR(15) PATH '.'
                           ) as X

```

This query yields the following result for the two XML documents:

*Table 14. Result table*

CUSTNAME	PHONETYPE	PHONENUM
Kathy Smith	work	905-555-7258
Robert Shoemaker	work	905-555-7258
Robert Shoemaker	home	416-555-2937
Robert Shoemaker	cell	905-555-8743
Robert Shoemaker	cottage	613-555-3278

Notice how each <phone> element for the XML document with the name "Robert Shoemaker" are returned in a separate row.

For the same documents, you can also extract the <phone> elements as XML, as follows:

```

SELECT X.*
FROM CUSTOMER C, XMLTABLE ('$cust/customerinfo/phone' PASSING C.INFO as "cust"
                           COLUMNS "CUSTNAME" CHAR(30) PATH '../name',
                                   "PHONETYPE" CHAR(30) PATH '@type',
                                   "PHONENUM" XML PATH '.'
                           ) as X

```

This query yields the following result for the two XML documents (the output has been formatted for clarity):

*Table 15. Result table*

CUSTNAME	PHONETYPE	PHONENUM
Kathy Smith	work	<phone type="work">416-555-1358</phone>
Robert Shoemaker	work	<phone type="work">905-555-7258</phone>

Table 15. Result table (continued)

CUSTNAME	PHONETYPE	PHONENUM
Robert Shoemaker	home	<phone type="home">416-555-2937</phone>
Robert Shoemaker	cell	<phone type="cell">905-555-8743</phone>
Robert Shoemaker	cottage	<phone type="cottage">613-555-3278</phone>

## Example: Processing elements from multiple trees in an XML document using XMLTABLE

In an XML document that contains multiple hierarchies, or trees, an element in one tree of the document can have a relationship to an element in another tree of the document. You can use XPath expressions to process the related elements in XML documents.

The following example generates a table for moving equipment and furniture to a new building based on information in an XML document. The XML document contains information related the location of the items in the new building.

The following statement creates the table MOVE that stores the XML document:  
 CREATE TABLE MOVE (ID BIGINT NOT NULL PRIMARY KEY, MOVEINFO XML )

The following XML data contains information about the companies items and the location of the items. The XML information is separated into two trees. One tree contains information about the items such as the department, tag number and a description of the item. The other tree contains information about the move, such as the new location of the departments and the floor assigned to offices, the common public area, and storage area.

The following statement inserts the XML document into the table MOVE:

```
INSERT into MOVE (ID, MOVEINFO) values ( 1, '
<listing>
  <items>
    <item dept="acct" tag="12223">
      <name>laser printer</name>
      <area>common</area>
    </item>
    <item dept="recptn" tag="23665">
      <name>monitor, CRT</name>
      <area>storage</area>
    </item>
    <item dept="acct" tag="42345">
      <name>CPU, desktop</name>
      <area>office</area>
    </item>
    <item dept="recptn" tag="33301">
      <name>monitor, LCD</name>
      <area>office</area>
    </item>
    <item dept="mfg" tag="10002">
      <name>cabinet, 3 dwr</name>
      <area>office</area>
    </item>
    <item dept="acct" tag="65436">
      <name>table, round 1m</name>
      <area>storage</area>
    </item>
```

```

</items>

<locations>
<building dept="recptn" >
  <wing>main</wing>
  <floor area="storage">1</floor>
  <floor area="common">1</floor>
  <floor area="office">2</floor>
</building>

<building dept="mfg" >
  <wing>east</wing>
  <floor area="storage">1</floor>
  <floor area="common">2</floor>
  <floor area="office">2</floor>
</building>

<building dept="acct" >
  <wing>west</wing>
  <floor area="storage">2</floor>
  <floor area="common">1</floor>
  <floor area="office">2</floor>
</building>
</locations>

</listing>
')
```

The following SELECT statement combines the items information and location information and creates a table that lists the item information, the department, and the new location.

The key to the mapping is using the relative XPath axis `$x/../../` to match the items information with the location information

```

SELECT T.*
  from MOVE,
 XMLTABLE( '$doc/listing/items/item' PASSING MOVE.MOVEINFO AS "doc"
 COLUMNS
  ITEM_ID  VARCHAR(10) PATH 'let $x := . return $x/@tag' ,
  DESC    VARCHAR(20) PATH 'let $x := . return $x/name' ,
  DEPT    VARCHAR(15) PATH 'let $x := . return $x/@dept' ,
  WING    VARCHAR(10) PATH 'let $x := . return $x/../../locations/
                        building[@dept = $x/@dept]/wing',
  FLOOR   VARCHAR(10) PATH 'let $x := . return $x/../../locations/
                        building/floor[@area = $x/area
                        and ../@dept = $x/@dept ]'
 )as T
```

When run against the sample data, the statement returns the following data:

ITEM_ID	DESC	DEPT	WING	FLOOR
12223	printer, laser	acct	west	1
23665	monitor, CRT	recptn	main	1
42345	CPU, desktop	acct	west	2
33301	monitor, LCD	recptn	main	2
10002	cabinet, 3 dwr	mfg	east	2
65436	table, round 1m	acct	west	2

## Example: Processing hierarchical data using XMLTABLE

XML documents can contain a hierarchy of data with a variable number of nested levels. You can use XPath expressions to process the hierarchical data.

The following example creates list of parts for a computer and the parent component of each part. The information is based on an XML document that contains the computer's components and the relationship of the components.

The following statement creates the table BOMLIST that stores the XML document:

```
CREATE TABLE BOMLIST (Cid BIGINT NOT NULL PRIMARY KEY, ITEMS XML )
```

The XML document contains a list of components and subcomponents. The list of components is related in a hierarchy that describes the subcomponents of a component. If a component consists of subcomponents, each subcomponent of the component is listed as a sub element of the component.

The following statement inserts the XML document into the table BOMLIST

```
CREATE TABLE BOMLIST (Cid BIGINT NOT NULL PRIMARY KEY, ITEMS XML )
insert into BOMLIST (Cid, ITEMS) values ( 1, '
<item desc="computersystem" model="L1234123">
  <part desc="computer" partnum="5423452345">
    <part desc="motherboard" partnum="5423452345">
      <part desc="CPU" partnum="6109486697">
        <part desc="register" partnum="6109486697"/>
      </part>
      <part desc="memory" partnum="545454232">
        <part desc="transistor" partnum="6109486697"/>
      </part>
    </part>

    <part desc="diskdrive" partnum="6345634563456">
      <part desc="spindlemotor" partnum="191986123"/>
    </part>
    <part desc="powersupply" partnum="098765343">
      <part desc="powercord" partnum="191986123"/>
    </part>
  </part>

  <part desc="monitor" partnum="898234234">
    <part desc="cathoderaytube" partnum="191986123"/>
  </part>

  <part desc="keyboard" partnum="191986123">
    <part desc="keycaps" partnum="191986123"/>
  </part>

  <part desc="mouse" partnum="98798734">
    <part desc="mouseball" partnum="98798734"/>
  </part>
</item>
')
```

The following SELECT statement navigates through the document and creates a table listing the part and the parent part.

The key feature is the creation of table B using the XMLTABLE function. Using the // in the XPath axis \$doc//part navigates through all part elements in the Item node.

```
SELECT
  A.ITEMNAME,
  B.PART,
  B.PARENT
FROM BOMLIST ,
XMLTABLE('$doc/item' PASSING BOMLIST.ITEMS AS "doc"
COLUMNS
  ITEMNAME VARCHAR(20) PATH './@desc',
```



```

ITEM XML PATH '.'
)AS A,
XMLTABLE('$doc//part' PASSING A.ITEM AS "doc"
COLUMNS
PART VARCHAR(20) PATH './@desc',
PARENT VARCHAR(20) PATH '../@desc'
)AS B

```

When the following statement is run against the data, the following table is displayed, listing the part and the parent part:

ITEMNAME	PART	PARENT
computersystem	computer	computersystem
computersystem	motherboard	computer
computersystem	CPU	motherboard
computersystem	register	CPU
computersystem	memory	motherboard
computersystem	transistor	memory
computersystem	diskdrive	computer
computersystem	spindlemotor	diskdrive
computersystem	powersupply	computer
computersystem	powercord	powersupply
computersystem	monitor	computersystem
computersystem	cathoderaytube	monitor
computersystem	keyboard	computersystem
computersystem	keycaps	keyboard
computersystem	mouse	computersystem
computersystem	mouseball	mouse

## XMLTABLE

The XMLTABLE function returns a result table from the evaluation of XQuery expressions, possibly using specified input arguments as XQuery variables. Each sequence item in the result sequence of the row XQuery expression represents a row of the result table.

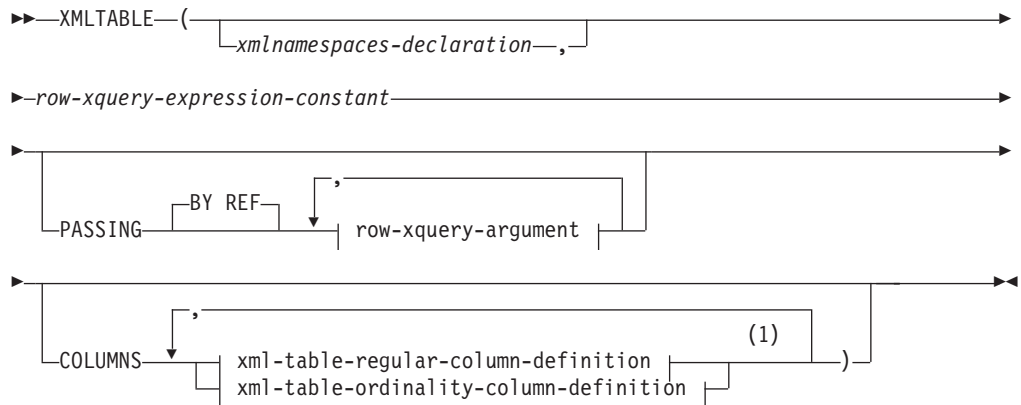

### row-xquery-argument:

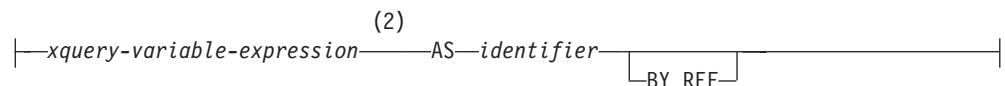

### xml-table-regular-column-definition:

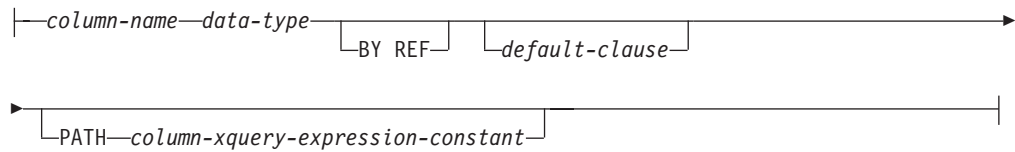

### xml-table-ordinality-column-definition:



#### Notes:

- 1 The `xml-table-ordinality-column-definition` clause must not be specified more than once (SQLSTATE 42614).
- 2 The data type of the expression cannot be `DECFLOAT`.

The schema is `SYSIBM`. The function name cannot be specified as a qualified name.

#### *xmlnamespaces-declaration*

Specifies one or more XML namespace declarations that become part of the static context of the *row-xquery-expression-constant* and the *column-xquery-expression-constant*. The set of statically known namespaces for XQuery expressions which are arguments of `XMLTABLE` is the combination of the pre-established set of statically known namespaces and the namespace declarations specified in this clause. The XQuery prolog within an XQuery expression may override these namespaces.

If *xmlnamespaces-declaration* is not specified, only the pre-established set of statically known namespaces apply to the the XQuery expressions.

#### *row-xquery-expression-constant*

Specifies an SQL character string constant that is interpreted as an XQuery expression using supported XQuery language syntax. The constant string is converted directly to UTF-8 without conversion to the database or section code page. The XQuery expression executes using an optional set of input XML values, and returns an output XQuery sequence where a row is generated for each item in the sequence. The value for *row-xquery-expression-constant* must not be an empty string or a string of all blanks (SQLSTATE 10505).

#### **PASSING**

Specifies input values and the manner in which these values are passed to the XQuery expression specified by *row-xquery-expression-constant*. By default, every unique column name that is in the scope where the function is invoked is implicitly passed to the XQuery expression using the name of the column as the variable name. If an *identifier* in a specified *row-xquery-argument* matches an in-scope column name, then the explicit *row-xquery-argument* is passed to the XQuery expression overriding that implicit column.

#### **BY REF**

Specifies that any XML input arguments are, by default, passed by reference. When XML values are passed by reference, the XQuery evaluation uses the input node trees, if any, directly from the specified input expressions, preserving all properties, including the original node identities and document order. If two arguments pass the same XML value, node identity comparisons and document ordering comparisons involving

some nodes contained between the two input arguments might refer to nodes within the same XML node tree.

This clause has no impact on how non-XML values are passed. The non-XML values create a new copy of the value during the cast to XML.

#### **row-xquery-argument**

Specifies an argument that is to be passed to the XQuery expression specified by *row-xquery-expression-constant*. An argument specifies a value and the manner in which that value is to be passed. The argument includes an SQL expression that is evaluated before passing the result to the XQuery expression.

- If the resulting value is of type XML, it becomes an *input-xml-value*. A null XML value is converted to an XML empty sequence.
- If the resulting value is not of type XML, it must be castable to the XML data type. A null value is converted to an XML empty sequence. The converted value becomes an *input-xml-value*.

When the *row-xquery-expression-constant* is evaluated, an XQuery variable is presented with a value equal to *input-xml-value* and a name specified by the AS clause.

#### *xquery-variable-expression*

Specifies an SQL expression whose value is available to the XQuery expression specified by *row-xquery-expression-constant* during execution. The expression cannot contain a NEXT VALUE expression, PREVIOUS VALUE expression (SQLSTATE 428F9), or an OLAP function (SQLSTATE 42903). The data type of the expression cannot be DECFLOAT.

#### **AS identifier**

Specifies that the value generated by *xquery-variable-expression* will be passed to *row-xquery-expression-constant* as an XQuery variable. The variable name will be *identifier*. The leading dollar sign (\$) that precedes variable names in the XQuery language is not included in *identifier*. The identifier must be a valid XQuery variable name and is restricted to an XML NCName. The identifier must not be greater than 128 bytes in length. Two arguments within the same PASSING clause cannot use the same identifier (SQLSTATE 42711).

#### **BY REF**

Indicates that an XML input value is to be passed by reference. When XML values are passed by reference, the XQuery evaluation uses the input node trees, if any, directly from the specified input expressions, preserving all properties, including the original node identities and document order. If two arguments pass the same XML value, node identity comparisons and document ordering comparisons involving some nodes contained between the two input arguments might refer to nodes within the same XML node tree. If BY REF is not specified following an *xquery-expression-variable*, XML arguments are passed by way of the default passing mechanism that is provided through the syntax that follows the PASSING keyword. This option cannot be specified for non-XML values (SQLSTATE 42636). When a non-XML value is passed, the value is converted to XML; this process creates a copy.

#### **COLUMNS**

Specifies the output columns of the result table. If this clause is not specified, a single unnamed column of data type XML is returned by reference, with the

value based on the sequence item from evaluating the XQuery expression in the *row-xquery-expression-constant* (equivalent to specifying PATH '.'). To reference the result column, a *column-name* must be specified in the *correlation-clause* following the function.

#### **xml-table-regular-column-definition**

Specifies the output columns of the result table including the column name, data type, XML passing mechanism and an XQuery expression to extract the value from the sequence item for the row

##### *column-name*

Specifies the name of the column in the result table. The name cannot be qualified and the same name cannot be used for more than one column of the table (SQLSTATE 42711).

##### *data-type*

Specifies the data type of the column. See CREATE TABLE for the syntax and a description of types available. A *data-type* may be used in XMLTable if there is a supported XMLCAST from the XML data type to the specified *data-type*.

#### **BY REF**

Specifies that XML values are returned by reference for columns of data type XML. By default, XML values are returned BY REF. When XML values are returned by reference, the XML value includes the input node trees, if any, directly from the result values, and preserves all properties, including the original node identities and document order. This option cannot be specified for non-XML columns (SQLSTATE 42636). When a non-XML column is processed, the value is converted from XML; this process creates a copy.

##### *default-clause*

Specifies a default value for the column. See CREATE TABLE for the syntax and a description of the *default-clause*. For XMLTABLE result columns, the default is applied when the processing the XQuery expression contained in *column-xquery-expression-constant* returns an empty sequence.

##### **PATH** *column-xquery-expression-constant*

Specifies an SQL character string constant that is interpreted as an XQuery expression using supported XQuery language syntax. The constant string is converted directly to UTF-8 without conversion to the database or section code page. The *column-xquery-expression-constant* specifies an XQuery expression that determines the column value with respect to an item that is the result of evaluating the XQuery expression in *row-xquery-expression-constant*. Given an item from the result of processing the *row-xquery-expression-constant* as the externally provided context item, the *column-xquery-expression-constant* is evaluated, returning an output sequence. The column value is determined based on this output sequence as follows.

- If the output sequence contains zero items, the *default-clause* provides the value of the column.
- If an empty sequence is returned and no *default-clause* was specified, a null value is assigned to the column.
- If a non-empty sequence is returned, the value is XMLCAST to the *data-type* specified for the column. An error could be returned from processing this XMLCAST.

The value for *column-xquery-expression-constant* must not be an empty string or a string of all blanks (SQLSTATE 10505). If this clause is not specified, the default XQuery expression is simply the *column-name*.

#### **xml-table-ordinality-column-definition**

Specifies the ordinality column of the result table.

##### *column-name*

Specifies the name of the column in the result table. The name cannot be qualified and the same name cannot be used for more than one column of the table (SQLSTATE 42711).

#### **FOR ORDINALITY**

Specifies that *column-name* is the ordinality column of the result table. The data type of this column is BIGINT. The value of this column in the result table is the sequential number of the item for the row in the resulting sequence from evaluating the XQuery expression in *row-xquery-expression-constant*.

If the evaluation of any of the XQuery expressions results in an error, then the XMLTABLE function returns the XQuery error (SQLSTATE class '10').

### **Example**

List as a table result the purchase order items for orders with a status of 'NEW'.

```
SELECT U."PO ID", U."Part #", U."Product Name",
       U."Quantity", U."Price", U."Order Date"
FROM PURCHASEORDER P,
     XMLTABLE('$po/PurchaseOrder/item' PASSING P.PORDER AS "po"
              COLUMNS "PO ID"          INTEGER      PATH './@PoNum',
                       "Part #"         CHAR(10)     PATH 'partid',
                       "Product Name"   VARCHAR(50)  PATH 'name',
                       "Quantity"       INTEGER      PATH 'quantity',
                       "Price"          DECIMAL(9,2)  PATH 'price',
                       "Order Date"     DATE         PATH './@OrderDate'
              ) AS U
WHERE P.STATUS = 'Unshipped'
```

---

## **XMLEXISTS predicate when querying XML data**

The XMLEXISTS predicate determines whether an XQuery expression returns a sequence of one or more items. If the XQuery expression specified in this predicate returns an empty sequence, XMLEXISTS returns false; otherwise, true is returned.

The XMLEXISTS predicate can be used in the WHERE clauses of SELECT statements. This usage means that values from stored XML documents can be used to restrict the set of rows that the SELECT query operates on.

For example, the following SQL query shows how the XMLEXISTS predicate can be used to restrict the rows returned, to only those that contain an XML document with a <city> element that has the value "Toronto". (Note that XQuery expressions are case-sensitive, while SQL is case-insensitive.)

```
SELECT Cid
FROM CUSTOMER
WHERE XMLEXISTS ('$d//addr[city="Toronto"]' passing INFO as "d")
```

Note how you can pass values to XQuery variables in the XQuery expression of XMLEXISTS. In this case, the XQuery variable \$d is bound to the documents of the INFO column of the CUSTOMER table. A simpler syntax for passing column

names without having to specify the names in the **passing** clause explicitly is also available. See “Simple column name passing with XMLEXISTS, XMLQUERY, or XMLTABLE” on page 105.

Ensure that the XQuery expression in XMLEXISTS is correctly specified in order to return expected results. For example, assume that there are multiple documents stored in the XML INFO column of the CUSTOMER table, but only one document contains a Cid attribute (along the path specified) with a value of 1000:

```
<customerinfo Cid="1000">
  <name>Kathy Smith</name>
  <addr country="Canada">
    <street>5 Rosewood</street>
    <city>Toronto</city>
    <prov-state>Ontario</prov-state>
    <pcode-zip>M6W 1E6</pcode-zip>
  </addr>
  <phone type="work">416-555-1358</phone>
</customerinfo>
```

The following two queries return different results, because of the slight difference in the XQuery expressions:

```
SELECT *
FROM CUSTOMER
WHERE XMLEXISTS ('$d/customerinfo[@Cid=1000]' passing INFO as "d")
```

```
SELECT *
FROM CUSTOMER
WHERE XMLEXISTS ('$d/customerinfo/@Cid=1000' passing INFO as "d")
```

The first query returns the row containing the XML document presented previously, as expected. The second query, however, returns all rows of the CUSTOMER table because the XMLEXISTS predicate always returns true for the XQuery expression specified. The XQuery expression in the second query returns a sequence of boolean items, which is a non-empty sequence, causing XMLEXISTS to always return true. This then causes every row in the CUSTOMER table to be selected, which is not the intended result.

## XMLEXISTS predicate usage

If XMLEXISTS includes an XPath expression with a value predicate (*expression*), enclose the predicate in square brackets, such that [*expression*] is the result. Enclosing the value predicate in square brackets ensures evaluation of *expression* in accordance with what may be semantically expected.

### XMLEXISTS predicate behavior

The following scenario demonstrates how a non-empty sequence causes XMLEXISTS to evaluate *true*, even though the non-empty sequence itself consists of the single value *false*. No index matching takes place and the query returns a much greater set of results than expected. The issue is avoided by bracketing value predicates appropriately with square brackets ([]).

Consider a table, an index and two queries:

```
CREATE TABLE mytable (id BIGINT, xmlcol XML);
CREATE INDEX myidx ON mytable(xmlcol)
GENERATE KEY USING XMLPATTERN '//text()' AS SQL VARCHAR(255);
SELECT xmlcol FROM mytable
WHERE XMLEXISTS('$doc/CUSTOMER/ORDERS/ORDERKEY/text()='A512' '
PASSING xmlcol AS "doc")
```

```

SELECT xmlcol FROM mytable
WHERE XMLEXISTS('$doc/CUSTOMER[ORDERS/ORDERKEY/text()='A512'] '
PASSING xmlcol AS "doc") ;

```

The cause for this behavior is as follows: XMLEXISTS evaluates the XQuery expression and returns *false* (for XMLEXISTS) if the result is the empty sequence, and *true* (for XMLEXISTS) if the result is a non-empty sequence. This is followed by a possibly non-intuitive next step in the query evaluation: In the first query the expression instructs to 'compare the order key to A512'. The result of that expression is either the value *false* or *true* depending on the actual value of the order key. Therefore, the XMLEXISTS function always sees a return sequence with a single item in it, that is, an item that is *false* or an item that is *true*. Since a sequence with one item is a non-empty sequence, XMLEXISTS **always** returns *true* (for XMLEXISTS) overall and therefore the query returns all rows. Indexes cannot be leveraged if XMLEXISTS is used such that all rows are qualified.

Below are 5 examples of non-empty sequences, where 3 are sequences which contain just 1 item:

```

(42, 3,4,78, 1966)
(true)
(abd, def)
(false)
(5)

```

Any such non-empty sequence will cause XMLEXISTS to return the value *true* (for XMLEXISTS), even if the non-empty sequence it encounters itself returns (*false*).

In the second query, the expression inside XMLEXISTS instructs to 'return the customers which contain an order with an orderkey equal to A512'. If no such customer exists in a document, then the result is indeed an empty sequence. This query will use an index and it will return the expected results.

### XMLEXISTS predicate usage

When the entire *expression* is placed in square brackets, the meaning is fixed to be 'return XML data if [*expression*]', and you should always be returned an empty sequence if the XML data does not satisfy *expression*.

Since the value comparison is always within square brackets, each of the following sample fragments for XMLEXISTS predicate usage works as expected:

```

... WHERE XMLEXISTS('$doc[CUSTOMER/ORDERS/ORDERKEY/text()='A512'] '
PASSING xmlcol as "doc") ;
... WHERE XMLEXISTS('$doc/CUSTOMER[ORDERS/ORDERKEY/text()='A512'] '
PASSING xmlcol AS "doc") ;
... WHERE XMLEXISTS('$doc/CUSTOMER[ORDERS[ORDERKEY/text()='A512'] '
PASSING xmlcol AS "doc") ;

```

The guideline also works for queries where there is no value comparison, for example, when you want to return the documents for all customers which happen to have a *COMMENT* child element:

```

... WHERE XMLEXISTS('$doc[CUSTOMER/COMMENT ] '
PASSING xmlcol AS "doc") ;

```

## XMLEXISTS predicate

The XMLEXISTS predicate tests whether an XQuery expression returns a sequence of one or more items.

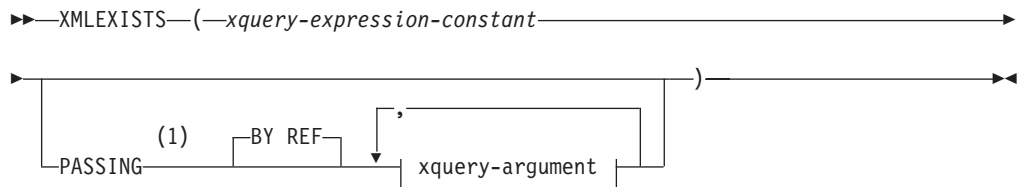

**xquery-argument:**

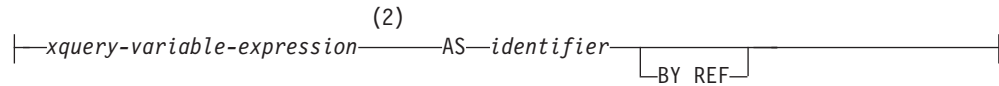

**Notes:**

- 1 The data type cannot be DECFLOAT.
- 2 The data type of the expression cannot be DECFLOAT.

*xquery-expression-constant*

Specifies an SQL character string constant that is interpreted as an XQuery expression. The constant string is converted directly to UTF-8 without conversion to the database or section code page. The XQuery expression executes using an optional set of input XML values, and returns an output sequence that is tested to determine the result of the XMLEXISTS predicate. The value for *xquery-expression-constant* must not be an empty string or a string of blank characters (SQLSTATE 10505).

**PASSING**

Specifies input values and the manner in which these values are passed to the XQuery expression specified by *xquery-expression-constant*. By default, every unique column name that is in the scope where the function is invoked is implicitly passed to the XQuery expression using the name of the column as the variable name. If an *identifier* in a specified *xquery-argument* matches an in-scope column name, then the explicit *xquery-argument* is passed to the XQuery expression overriding that implicit column.

**BY REF**

Specifies that the default passing mechanism is by reference for any *xquery-variable-expression* of data type XML. When XML values are passed by reference, the XQuery evaluation uses the input node trees, if any, directly from the specified input expressions, preserving all properties, including the original node identities and document order. If two arguments pass the same XML value, node identity comparisons and document ordering comparisons involving some nodes contained between the two input arguments might refer to nodes within the same XML node tree.

This clause has no impact on how non-XML values are passed. The non-XML values create a new copy of the value during the cast to XML.

**xquery-argument**

Specifies an argument that is to be passed to the XQuery expression specified by *xquery-expression-constant*. An argument specifies a value and the manner in which that value is to be passed. The argument includes an SQL expression that is evaluated.

- If the resulting value is of type XML, it becomes an *input-xml-value*. A null XML value is converted to an XML empty sequence.



- If the resulting value is not of type XML, it must be castable to the XML data type. A null value is converted to an XML empty sequence. The converted value becomes an *input-xml-value*.

When the *xquery-expression-constant* is evaluated, an XQuery variable is presented with a value equal to *input-xml-value* and a name specified by the AS clause.

#### *xquery-variable-expression*

Specifies an SQL expression whose value is available to the XQuery expression specified by *xquery-expression-constant* during execution. The expression cannot contain a sequence reference (SQLSTATE 428F9) or an OLAP function (SQLSTATE 42903). The data type of the expression cannot be DECFLOAT.

#### **AS** *identifier*

Specifies that the value generated by *xquery-variable-expression* will be passed to *xquery-expression-constant* as an XQuery variable. The variable name will be *identifier*. The leading dollar sign (\$) that precedes variable names in the XQuery language is not included in *identifier*. The identifier must be a valid XQuery variable name and is restricted to an XML NCName. The identifier must not be greater than 128 bytes in length. Two arguments within the same PASSING clause cannot use the same identifier (SQLSTATE 42711).

#### **BY REF**

Indicates that an XML input value is to be passed by reference. When XML values are passed by reference, the XQuery evaluation uses the input node trees, if any, directly from the specified input expressions, preserving all properties, including the original node identities and document order. If two arguments pass the same XML value, node identity comparisons and document ordering comparisons involving some nodes contained between the two input arguments might refer to nodes within the same XML node tree. If BY REF is not specified following an *xquery-variable-expression*, XML arguments are passed by way of the default passing mechanism that is provided through the syntax that follows the PASSING keyword. This option cannot be specified for non-XML values. When a non-XML value is passed, the value is converted to XML; this process creates a copy.

## Notes

The XMLEXISTS predicate cannot be:

- Part of the ON clause that is associated with a JOIN operator or a MERGE statement (SQLSTATE 42972)
- Part of the GENERATE KEY USING or RANGE THROUGH clause in the CREATE INDEX EXTENSION statement (SQLSTATE 428E3)
- Part of the FILTER USING clause in the CREATE FUNCTION (External Scalar) statement, or the FILTER USING clause in the CREATE INDEX EXTENSION statement (SQLSTATE 428E4)
- Part of a check constraint or a column generation expression (SQLSTATE 42621)
- Part of a group-by-clause (SQLSTATE 42822)
- Part of an argument for a column-function (SQLSTATE 42607)

An XMLEXISTS predicate that involves a subquery might be restricted by statements that restrict subqueries.

## Example

```
SELECT c.cid FROM customer c
WHERE XMLEXISTS('$d/*:customerinfo/*:addr[ *:city = "Aurora" ]'
PASSING info AS "d")
```

---

## Passing parameters between SQL statements and XQuery expressions

When issuing combined SQL statements and XQuery expressions, you can pass data between the statements and expressions to modify the execution of the statements and expressions.

### Constant and parameter marker passing to XMLEXISTS and XMLQUERY

The XMLEXISTS predicate and the XMLQUERY scalar function execute XQuery expressions from within an SQL statement. Use constants and parameter markers to pass data from the SQL statement to variables in an XQuery expression executed within the SQL statement.

XQuery variables can be specified as part of the XQuery expression in XMLEXISTS and XMLQUERY. Values are passed into these variables through the passing clause. These values are SQL expressions. Because the values passed to the XQuery expression are non-XML values, they must be cast, either implicitly or explicitly, to types supported by DB2 XQuery. Refer to the documentation on casting between data types for more information on supported casts.

The method of passing constants and parameter markers to XMLQUERY is the same as that of XMLEXISTS, however, the XMLEXISTS usage is more common. This is because parameterized predicates in XMLQUERY, when used in SELECT clauses, do not eliminate any rows from the result set. Instead, the predicates are used to determine which fragments of a document are returned. To actually eliminate rows from a result set, the XMLEXISTS predicate should be used in the WHERE clause. Rows that contain empty sequences are therefore not returned as part of the result set. The examples discussed here show this more common usage with XMLEXISTS.

#### Example: Implicit casting

In the following query, the SQL character string constant 'Aurora', which is not an XML type, is implicitly cast to an XML type in the XMLEXISTS predicate. Following the implicit cast, the constant has the XML schema subtype of xs:string, and is bound to the variable \$cityName. This constant can then be used in the predicate of the XQuery expression.

```
SELECT XMLQUERY ('$d/customerinfo/addr' passing c.INFO as "d")
FROM Customer as c
WHERE XMLEXISTS('$d//addr[city=$cityName]'
                passing c.INFO as "d",
                'Aurora' AS "cityName")
```

#### Example: Explicit casting

In the following query, the parameter marker must be explicitly cast to a data type because the type of the parameter marker cannot be determined. The parameter marker that is explicitly cast to an SQL VARCHAR type is then implicitly cast to the xs:string XML schema type.

```

SELECT XMLQUERY ('$d/customerinfo/addr' passing c.INFO as "d")
FROM Customer as c
WHERE XMLEXISTS('$d//addr[city=$cityName]'
               passing c.INFO as "d",
               CAST (? AS VARCHAR(128)) AS "cityName")

```

## Simple column name passing with XMLEXISTS, XMLQUERY, or XMLTABLE

To simplify using the XMLEXISTS predicate, the XMLQUERY scalar function, or the XMLTABLE table function, you can use a column name as a parameter in the XQuery expression specified by XMLEXISTS, XMLQUERY, or XMLTABLE without specifying the name in the **passing** clause.

You must use the **passing** clause that passes the column name as a parameter, if the parameter name being used is different from the column name being passed.

If a variable is specified explicitly in the **passing** clause and if the name conflicts with any variable referenced by the XQuery expression, precedence will be given to the variable in the **passing** clause. Assuming in the CUSTOMER table contains two XML columns named INFO and CUST, the following example retrieves XML data from INFO column:

```

SELECT XMLQuery('$CUST/customerinfo/name' PASSING INFO as "CUST") FROM customer

```

The variable CUST specified in the **passing** clause will be used to substitute the column INFO in the XQuery expression. The column CUST from the CUSTOMER table will not be used.

### Examples: XMLQUERY and XMLEXISTS

Note that column names are case-sensitive in these examples, since they are enclosed by double quotes. When not surrounded by double quotes, regular column name rules apply: the name of the column is case-insensitive and stored in upper case.

The following example shows several SELECT statements that return the same sequence of documents from the PURCHASEORDER table. The XML documents are in column PORDER. The first two SELECT statements use the **passing** clause to pass the column name PORDER to the XQuery expression within the XMLQUERY scalar function. The third SELECT uses the PORDER column name as an implicitly passed parameter:

```

SELECT XMLQuery('$PORDER/PurchaseOrder/item/name' PASSING porder AS "PORDER")
FROM purchaseorder
SELECT XMLQuery('$PORDER/PurchaseOrder/item/name' PASSING porder AS "porder")
FROM purchaseorder
SELECT XMLQuery('$PORDER/PurchaseOrder/item/name') FROM purchaseorder

```

The following two examples shows several function calls that use both XMLQUERY and XMLEXISTS. Both examples return the same sequence of documents from the CUSTOMER table.

The following example uses the **passing** clause to explicitly specify the INFO column name as a parameter in the XMLQUERY scalar function and the XMLEXISTS predicate:

```

SELECT XMLQUERY ('$INFO/customerinfo/addr' passing Customer.INFO as "INFO")
FROM Customer
WHERE XMLEXISTS('$INFO//addr[city=$cityName]'
                passing Customer.INFO as "INFO",
                'Aurora' AS "cityName")

```

In the following example, the XMLQUERY function does not use a passing clause and XMLEXISTS **passing** clause does not specify the INFO column. The column name INFO is passed implicitly to XQuery expression in both the XMLQUERY scalar function and the XMLEXISTS predicate:

```

SELECT XMLQUERY ('$INFO/customerinfo/addr')
FROM Customer
WHERE XMLEXISTS('$INFO//addr[city=$cityName]'
                passing 'Aurora' AS "cityName")

```

## Examples: XMLTABLE

The following two examples show two INSERT statements that use the XMLTABLE table function. Both examples insert the same data into the table CUSTOMER from the table T1. The table T1 contains an XML column named CUSTLIST. The XMLTABLE function retrieves the data from the column T1.CUSTLIST and returns a table with three columns, Cid, Info, and History. The INSERT statement inserts data from the XMLTABLE function into three columns of the table CUSTOMER.

The following example uses the **passing** clause to explicitly specify the CUSTLIST column name as a parameter in the XMLTABLE table function:

```

INSERT INTO customer SELECT X.* FROM T1,
XMLTABLE( '$custlist/customers/customerinfo' passing T1.custlist as "custlist"
COLUMNS
"Cid" BIGINT PATH '@Cid',
"Info" XML PATH 'document{.}',
"History" XML PATH 'NULL') as X

```

In the following example, the XMLTABLE table function does not use a **passing** clause. XMLTABLE uses the column name CUSTLIST from the table T1 as an implicitly passed parameter:

```

INSERT INTO customer SELECT X.* FROM T1,
XMLTABLE( '$custlist/customers/customerinfo'
COLUMNS
"Cid" BIGINT PATH '@Cid',
"Info" XML PATH 'document{.}',
"History" XML PATH 'NULL') as X

```

## Passing parameters from XQuery to SQL

From within an XQuery expression, the db2-fn:sqlquery function executes an SQL fullselect that retrieves an XML node sequence. When using db2-fn:sqlquery, use the PARAMETER function to reference the passed data from the XQuery expression to the SQL fullselect statement specified by db2-fn:sqlquery.

Using the PARAMETER function, parameters can be specified as part of an SQL fullselect expression in db2-fn:sqlquery. If you use PARAMETER functions in the db2-fn:sqlquery invocation, you must also specify XQuery expressions that will be used by the PARAMETER functions. During the processing of the SQL fullselect, each PARAMETER function call is replaced with the result value of the corresponding XQuery expression in the db2-fn:sqlquery function invocation. The value supplied by the PARAMETER function can be referenced multiple times within the same SQL statement.

The XQuery expressions that are part of the `db2-fn:sqlquery` function invocation return a value. Because the values passed to the `fullselect` are XML values, they must be cast, either implicitly or explicitly, to types supported by DB2 SQL. Refer to the `db2-fn:sqlquery` documentation and the documentation on casting between data types for more information on supported casts.

### Example: Passing a parameter to `db2-fn:sqlquery`

The following example is an XQuery expression that uses `db2-fn:sqlquery`. During processing of the `db2-fn:sqlquery` function, both references to `parameter(1)` return the value of the order date attribute `$po/@OrderDate`.

When run against the DB2 SAMPLE database the XQuery expression returns the purchase ID, part ID, and the purchase date for all the parts sold within the promotion dates.

```
xquery
for $po in db2-fn:xmlcolumn('PURCHASEORDER.PORDER')/PurchaseOrder,
  $item in $po/item/partid
for $p in db2-fn:sqlquery(
  "select description
  from product
  where promotstart < parameter(1)
  and
  promoend > parameter(1)",
  $po/@OrderDate )
where $p//@pid = $item
return
<RESULT>
  <PoNum>{data($po/@PoNum)}</PoNum>
  <PartID>{data($item)} </PartID>
  <PoDate>{data($po/@OrderDate)}</PoDate>
</RESULT>
```

---

## Data retrieval with XQuery

The XQuery specification defines the result of an XQuery expression as a sequence that contains 0, 1, or more items. XQuery expressions can be executed either using XQuery as the primary language or using SQL with the `XMLQUERY` SQL function as the primary language. When an XQuery expression is executed using either method, an XML sequence is returned.

How the resulting sequence appears in a result set differs depending on whether SQL or XQuery is used as the primary language:

### XQuery as the primary language

When an XQuery expression is executed using XQuery as the primary language, the result is returned to a client application as a result table with one column, which is of type XML. Each row in this result table is an item of the sequence that resulted from the evaluation of the XQuery expression. When an application fetches from this result table using a cursor, each fetch retrieves a serialized item of the resulting sequence.

### SQL as the primary language, using `XMLQUERY`

`XMLQUERY` is a scalar function that returns an XML value. The value that is returned is a sequence of 0, 1, or more items. All items of the resulting sequence are returned to an application as a single serialized value.

To fetch results from queries that use XQuery or `XMLQUERY`, fetch results from within your application, as you normally would any other result set. Bind your

application variable to the result set and fetch until the end of the result set. If the XQuery expression (issued directly or through XMLQUERY) returned an empty sequence, then the row in the result set is also empty.

## Managing query result sets

If your application requires that the XML values returned when querying with XQuery are well-formed XML documents (for example, if you plan to insert these values into a column of type XML), then you can ensure that the values are well-formed XML documents by including an element or document constructor in your XQuery expression.

### Example: Difference in result sets from XQuery and XMLQUERY

This example illustrates the difference between the result sets from the two querying methods.

If the following two XML documents are stored in an XML column, to retrieve all <phone> elements, you can use either XQuery or XMLQUERY. The result sets that are returned by these two methods differ, however, and should be handled accordingly by the application when fetching from the result set.

```
<customerinfo Cid="1000">
  <name>Kathy Smith</name>
  <addr country="Canada">
    <street>5 Rosewood</street>
    <city>Toronto</city>
    <prov-state>Ontario</prov-state>
    <pcode-zip>M6W 1E6</pcode-zip>
  </addr>
  <phone type="work">416-555-1358</phone>
</customerinfo>

<customerinfo Cid="1003">
  <name>Robert Shoemaker</name>
  <addr country="Canada">
    <street>1596 Baseline</street>
    <city>Aurora</city>
    <prov-state>Ontario</prov-state>
    <pcode-zip>N8X 7F8</pcode-zip>
  </addr>
  <phone type="work">905-555-7258</phone>
  <phone type="home">416-555-2937</phone>
  <phone type="cell">905-555-8743</phone>
  <phone type="cottage">613-555-3278</phone>
</customerinfo>
```

Executing an XQuery expression using XQuery as the primary language such as the following example:

```
XQUERY
  db2-fn:xmlcolumn ('CUSTOMER.INFO')/customerinfo/phone
```

The result set returns five rows, as follows:

```
<phone type="work">416-555-1358</phone>
<phone type="work">905-555-2937</phone>
<phone type="home">416-555-2937</phone>
<phone type="cell">905-555-8743</phone>
<phone type="cottage">613-555-3278</phone>
```

Executing an XQuery expression through XMLQUERY such as the following example:

```
SELECT XMLQUERY ('$doc/customerinfo/phone' PASSING INFO AS "doc")
FROM CUSTOMER
```

The result set returns two rows, as follows, where all <phone> elements of the second row in the table are concatenated in a single scalar value (an XML sequence):

```
<phone type="work">416-555-1358</phone>
<phone type="work">905-555-2937</phone><phone type="home">416-555-2937</
phone><phone type="cell">905-555-8743</phone><phone type="cottage">613-
555-3278</phone>
```

Notice that the second row of this result set contains a value that is not a well-formed XML document.

These differences in the result sets exist because XMLQUERY is a scalar function. It executes on each row of the table and the resulting sequence from a row of the table, forms a row of the result set. XQuery, however, returns each item of a sequence as a separate row of the result set.

### Example: Managing query result sets

In this example, the previous SQL query can be modified to include an XQuery document node constructor that ensures the resulting rows all contain well-formed documents:

```
SELECT XMLQUERY ('document{<phonelist>{$doc/customerinfo/phone}</phonelist>}'
  PASSING INFO AS "doc")
FROM CUSTOMER
```

The result set from this query returns two rows, assuming the same documents presented previously exist in database, is as follows (The output has been formatted for clarity).

```
<phonelist><phone type="work">416-555-1358</phone></phonelist>
<phonelist><phone type="work">905-555-7258</phone><phone
type="home">416-555-2937</phone><phone type="cell">905-555-8743</
phone><phone type="cottage">613-555-3278</phone></phonelist>
```

---

## Guidelines for matching indexes with queries overview

This section provides you with some guidelines and examples for matching queries with indexes over XML data.

Whether a query can make use of an index depends on whether the index or indexes you created are compatible with your query (also known as index matching), and whether the optimizer chooses to perform an index scan during query evaluation. The access plan of the Explain facility will tell you if query evaluation involved an index scan.

A query must meet at least the following conditions before it can use an index over XML data:

- The data types in the query search condition match the indexed data types.
- The query search condition includes a subset of the nodes that are indexed.

## SQL and XQuery optimizer

The optimizer plans the evaluation of queries and chooses which indexes to use during evaluation. During query compilation, a query is matched with all the patterns in the XML index definitions to find candidate indexes that contain sufficient information to answer some part of the query.

The optimizer may take one of the following steps during query evaluation:

- Scan the table containing the XML documents, without using an index
- Use a relational index
- Use relational index ANDing or index ORing
- Use a new XML index operator
- Use an index over XML data for the evaluation of a single XML pattern
- Use index over XML data ANDing and ORing for the evaluation of complex XML patterns from a single query

## Explain facility

The Explain facility and the Visual Explain tool can provide you with the access plan that is chosen to evaluate your query. When you look at an access plan, the following operators will tell you whether one or several indexes were used during query evaluation:

### IXAND

ANDs the row IDs from two or more index scans.

### XISCAN

Scans an index over XML data.

### XANDOR

Allows ANDed predicates to be applied to multiple XML indexes.

## Restrictiveness of index definitions

Whether or not the evaluation of a query can make use of an index often depends on how restrictive the index definition is compared to your query. The following examples show a number of queries and indexes that can be used together.

### Indexes for queries with a range predicate

The following query retrieves company information for employees with a salary greater than 35000 from the table *companyinfo* with the XML column *companydocs*:

```
SELECT companydocs FROM companyinfo
WHERE XMLEXISTS('$x/company/emp[@salary > 35000]'
PASSING companydocs AS "x")
```

To be compatible, an index over XML data needs to include employee salary attribute nodes among the indexed nodes, and to store values as DOUBLE or DECIMAL type.

The query could use either one of the following indexes over XML data, for example:

```
CREATE INDEX empindex on companyinfo(companydocs)
GENERATE KEY USING XMLPATTERN '//@salary' AS SQL DECIMAL(10,2)
```

```
CREATE INDEX empindex on companyinfo(companydocs)
GENERATE KEY USING XMLPATTERN '/company/emp/@salary'
AS SQL DECIMAL(10,2)
```



## Indexes that can be used by multiple queries

The following query retrieves company information for employees with the employee ID 31664.

```
SELECT companydocs FROM companyinfo
WHERE XMLEXISTS('$x/company/emp[@id="31664"]'
PASSING companydocs AS "x")
```

A second query retrieves company information for departments with the ID K55.

```
SELECT companydocs FROM companyinfo
WHERE XMLEXISTS('$x/company/emp/dept[@id="K55"]'
PASSING companydocs AS "x")
```

To be compatible with both queries, the index over XML data needs to include employee ID attribute nodes and department ID attribute nodes among the indexed nodes, and to store values in the index as a VARCHAR type.

The queries can use this index over XML data:

```
CREATE INDEX empdeptindex on companyinfo(companydocs)
GENERATE KEY USING XMLPATTERN '//@id' AS SQL VARCHAR(25)
```

## Inclusion of namespaces when restricting XQuery predicates

Consider the following table with an XML column that contains customer information, and an index that is created on the XML column:

```
CREATE TABLE customer(xmlcol XML) %

CREATE UNIQUE INDEX customer_id_index ON customer(xmlcol)
GENERATE KEY USING XMLPATTERN
'DECLARE DEFAULT ELEMENT NAMESPACE
"http://mynamespace.org/cust";/Customer/@id'
AS SQL DOUBLE %
```

**Note:** The statement terminator used in this section is the percentage sign (%), since the semicolon (;) already serves as the namespace delimiter.

The following query fails to match the index:

```
SELECT xmlcol FROM customer
WHERE XMLEXISTS('$xmlcol/*:Customer[@id=1042]'
PASSING xmlcol AS "xmlcol") %
```

In order for the query to be able to use the index, the query must be as restrictive as or more restrictive than the index. The index `customer_id_index` covers only customer elements in one particular namespace (`http://mynamespace.org/cust`). Since `*` is used in the query to denote any namespace, the index is not used. This can be counter-intuitive if one expects `*` to match the namespace in the index definition.

For the query to make use of the index, either the index needs to become less restrictive, or the query needs to become more restrictive.

The following less restrictive index `customer_id_index2` could be used successfully with the same query:

```
CREATE UNIQUE INDEX customer_id_index2 ON customer(xmlcol)
GENERATE KEY USING XMLPATTERN '/*:Customer/@id' AS SQL DOUBLE %
```

The following more restrictive query can make use of the initial index `customer_id_index`:

```

SELECT xmlcol FROM customer
WHERE XMLEXISTS('
  DECLARE NAMESPACE ns = "http://mynamespace.org/cust";
  $xmlcol/ns:Customer[@id=1042]'
  PASSING xmlcol AS "xmlcol") %

```

When the appropriate namespace is specified explicitly in the query, the index *customer\_id\_index* can be used, since the query is now just as restrictive as the index. The index *customer\_id\_index2* could also be used, since it is less restrictive than the query in this example.

## Considerations when specifying text() nodes

The inclusion of text() nodes with XML pattern expressions may affect the generation of index entries. Use /text() consistently in index definitions and predicates.

### How specification of the text() node affects index keys

Consider the following sample XML document fragment:

```

<company name="Company1">
  <emp id="31201" salary="60000" gender="Female">
    <name><first>Laura</first><last>Brown</last></name>
    <dept id="M25">
      Finance
    </dept>
  </emp>
</company>

```

If the following index is created with text() specified at the end of the pattern, no index entries will be inserted because the *name* elements in the sample XML document fragments do not contain text themselves. Text is found only in the child elements, *first* and *last*.

```

CREATE INDEX nameindex on company(companydocs)
  GENERATE KEY USING XMLPATTERN '/company/emp/name/text()' AS SQL
  VARCHAR(30)

```

However, if the next index is created with the element *name* specified at the end of the pattern, the text from the *first* and *last* child elements will be concatenated in the inserted index entries.

```

CREATE INDEX nameindex on company(companydocs)
  GENERATE KEY USING XMLPATTERN '/company/emp/name'
  AS SQL VARCHAR(30)

```

The presence or absence of the text() node will affect index entry generation for non leaf elements, but not for leaf elements. If you are indexing leaf elements, specifying text() is not recommended. If you do specify text(), queries must also use text() for successful index matching. In addition, schema validation applies only to elements and not to text nodes.

Caution must be used when specifying XML patterns that can match elements which are non leaf nodes without text(). The concatenation of descendant element text nodes can cause unexpected results. Especially specifying //*\** with an XML pattern will most likely index a non leaf element.

In some cases, concatenation can be useful for indexes using VARCHAR. For example, an index on /*title* in the following document fragment may be useful for ignoring the bold formatting within the title:

```

<title>This is a <bold>great</bold> book about XML</title>

```

A query predicate to look for a specific employee name could be written as follows:

```
db2-fn:xmlcolumn('COMPANY.COMPANYDOCS')/company/emp[name='LauraBrown']
```

Whitespace is significant in the predicate and the document. If a space is inserted between 'Laura' and 'Brown' in the predicate, nothing will be returned for the following query, since the sample XML document fragment itself does not contain a space between the first and last names:

```
db2-fn:xmlcolumn('COMPANY.COMPANYDOCS')/company/emp[name='Laura Brown']
```

### Indexes for queries with a compound equal predicate

The following query retrieves company information for employees who are in the Finance or Marketing departments.

```
SELECT companydocs FROM companyinfo WHERE
  XMLExists('$x/company/emp[dept/text()='Finance'
    or dept/text()='Marketing']')
  PASSING companydocs AS "x")
```

To be compatible, the index over XML data needs to index the text node for the department of each employee among the indexed nodes and to store values as a VARCHAR type.

The query can use this index over XML data:

```
CREATE INDEX empindex on companyinfo(companydocs)
  GENERATE KEY USING XMLPATTERN '/company/emp/dept/text()'
  AS SQL VARCHAR(30)
```

## Data type of literals

The data types of literals need to match the data type of the index in order for the query to be able to make use of the index.

### Matching data types of literals

The following query retrieves company information for employees with the ID 31201.

```
SELECT companydocs FROM companyinfo
  WHERE XMLEXISTS('$x/company/emp[@id="31201"]')
  PASSING companydocs AS "x")
```

To be compatible, the index over XML data needs to include the employee ID attribute nodes among the indexed nodes, and to store values in the index as a VARCHAR type.

```
CREATE INDEX empindex on companyinfo(companydocs)
  GENERATE KEY USING XMLPATTERN '/company/emp/@id'
  AS SQL VARCHAR(5)
```

If a similar index were defined AS SQL DOUBLE it could not be used by the query, since the query predicate includes a string comparison. The double quotation marks used in the predicate `@id="31201"` make it a string comparison, which can be evaluated only with a string index (VARCHAR), not with a numeric index (DOUBLE).

To highlight the difference between numeric predicates and string predicates, consider the following inequality predicates:

```
@id > 3
@id > "3"
```

The numeric predicate `@id > 3` is different from the string predicate `@id > "3"`. The numeric predicate `@id > 3` would be fulfilled by an `@id` value of `10`, but the string predicate `@id > "3"` would not be, because in a string comparison `"3"` is greater than `"10"`.

## Join predicate conversion

Join predicates should be converted to the appropriate data type on both sides.

### What join predicates can preclude index usage?

Consider two tables with XML columns for customer information and purchase orders, respectively:

```
CREATE TABLE customer(info XML);
```

```
CREATE TABLE PurchaseOrder(POrder XML);
```

The XML documents that contain customer information include an attribute `@cid`, the numeric customer ID (`cid`). The XML documents that contain purchase order information also include `@cid` attributes, so that each order is uniquely associated with a particular customer. Since we expect customers and orders to be frequently searched by `cid`, it makes sense to define indexes:

```
CREATE UNIQUE INDEX idx1 ON customer(info)
  GENERATE KEY USING XMLPATTERN '/customerinfo/@cid' AS SQL INTEGER;
```

```
CREATE INDEX idx2 ON PurchaseOrder(POrder)
  GENERATE KEY USING XMLPATTERN '/porder/@cid' AS SQL INTEGER;
```

We want to find the purchase orders for all customers in a specific ZIP code. Intuitively, we can write the query like this:

```
XQUERY
  for $i in db2-fn:xmlcolumn("CUSTOMER.INFO")/customerinfo
  for $j in db2-fn:xmlcolumn("PURCHASEORDER.PORDER")/porder[@cid = $i/@cid]
  where $i/zipcode = "95141"
  return $j;
```

Note that the join predicate `@cid = $i/@cid` requires the purchase order's `cid` to be equal to the customer `cid`.

This query returns the correct result, but neither of the two indexes can be used. The query is executed as a nested loop join with table scans for both tables. To avoid repeated table scans, a single table scan on `customer` to find all customers within ZIP code `95141` is preferable, followed by index lookups into the purchase order table using `@cid`. Note that it is necessary to scan the customer table since we have no index on `zipcode`.

The index is not used, because it would be incorrect to do so. If the index were used, DB2 may miss some matching purchase orders and return an incomplete result. This is because some values in the `@cid` attribute could potentially be non numeric. For example, `@cid` could equal `YPS` and thus not be included in the numeric index which is defined `AS SQL INTEGER`.

**Note:** If a value of an indexed node cannot be converted to the specified index data type, the index entry for that value is not inserted and no error or warning is raised.

### Enabling index usage with join predicates

It is possible to enable the index, which is desirable if we are certain that

all our @cid values are numeric. The index will be used if we convert the join predicate explicitly to match the type of the index:

```
XQUERY
  for $i in db2-fn:xmlcolumn("CUSTOMER.INFO")/customerinfo
  for $j in db2-fn:xmlcolumn("PURCHASEORDER.PORDER")/porder
  where $i/@cid/xs:int(.) = $j/@cid/xs:int(.)
  and $i/zipcode = "95141"
  return $j;
```

Intuitively, the conversion advises DB2 that it should consider matching only @cid attributes which are convertible to INTEGER. With this directive, we can be sure that all required matches are represented in the index defined AS SQL INTEGER, and thus that it is safe to use that index. If there does exist a non numeric @cid value in one of the documents, then the conversion will fail with a run-time error.

Note that within XQuery, casting works only for singletons. Especially for elements (*a*, *b*, and *c* in the following example), it is recommended that you convert them like this:

```
/a/b/c/xs:double(.)
```

If you were to convert the elements as follows, a run-time error would result if multiple elements *c* exist under any given element *b*:

```
/a/b/xs:double(c)
```

For indexes that are defined AS SQL VARCHAR, the corresponding join predicates need to convert the compared values to the xs:string data type using the fn:string() function. The same applies to DATE and TIMESTAMP indexes. The following example shows how the fn:string() function is used in a string join:

```
XQUERY
  for $i in db2-fn:xmlcolumn("CUSTOMER.INFO")/customerinfo
  for $j in db2-fn:xmlcolumn("PURCHASEORDER.PORDER")/porder
  where $i/zipcode/fn:string(.) = $j/supplier/zip/fn:string(.)
  return <pair>{$i}{$j}</pair>
```

### Summary of conversion rules for join predicates

The following table shows a summary of how join predicates should be converted to the appropriate data type on both sides in order to enable index usage.

Table 16. Conversion rules for join predicates

Index SQL type	Convert join predicate to XML type
DOUBLE	xs:double
DECIMAL	xs:decimal
INTEGER	xs:int
VARCHAR <i>integer</i> , VARCHAR HASHED	xs:string
DATE	xs:date
TIMESTAMP	xs:dateTime

## Indeterminate query evaluation

A query might evaluate indeterminately and return an error when no index scan is involved. The same query might return matching XML data without error when

query evaluation involves an index scan, because non-castable XML fragments that cause the error are not included in the index.

The example uses the following VALUES statement that contains an XQuery expression. The expression uses a numeric comparison to return the XML document whose ID is 17:

```
VALUES( XMLQUERY('
  for $i in db2-fn:xmlcolumn("T.DOC")
  where $i/emp/id = 17
  return $i'))
```

The table T consists of a single XML column DOC and contains two XML documents. The following statements create the table and insert the documents:

```
CREATE TABLE t (doc XML) ;
INSERT INTO t VALUES ( '<emp><id>17</id></emp>' );
INSERT INTO t VALUES ( '<emp><id>ABC</id></emp>' );
```

The XQuery expression returns an error unless an index over XML data defined as SQL INTEGER or as SQL DOUBLE is used to find the matching document in the table. The following CREATE INDEX statement creates the index:

```
CREATE INDEX EMPDBL ON t (doc) GENERATE KEY USING XMLPATTERN '/emp/id'
  as SQL INTEGER IGNORE INVALID VALUES
```

If the index does not exist on the table, the numeric comparison in the **where** clause is applied to both the matching and nonmatching document in the table. Applying the comparison to the nonmatching document results in a runtime error because the value ABC cannot be converted to a number. If the index over XML data that indexes employee IDs exists on the table, the expression uses the index and returns the first XML document without error. The non-castable value in the second document was not included in the index over XML data because the clause IGNORE INVALID VALUES specifies ignoring and not indexing invalid pattern values during index creation. Ignoring invalid values is the default option.

The access plan provided by the Explain facility shows whether the evaluation of a query involves an index scan.

To ensure that all pattern values are valid during index creation, use the REJECT INVALID VALUES clause. An error is raised for invalid pattern values during index creation or during index updates.

---

## Full-text search in XML documents

Full-text search of natively stored XML data is available through DB2 Net Search Extender.

### DB2 Net Search Extender

DB2 Net Search Extender fully supports the XML data type. It provides full-text indexing of documents stored in XML columns. By creating a text index on an XML column, you can query all text within an XML document and perform searches such as proximity or wildcard searches. DB2 Net Search Extender is part of all DB2 data server products for Linux, UNIX, and Windows, but must be installed separately.

The following example shows a simple full-text search that finds the word "marketing" anywhere within the path /dept/description of XML documents stored in the DEPTDOC column:

```
SELECT DEPTDOC
FROM DEPT
WHERE contains (DEPTDOC, SECTIONS("/dept/description") "marketing") = 1
```

The contains function, provided by DB2 Net Search Extender, searches for the string "marketing" in any text under the path /dept/description, including element or attribute names, and element or attribute values.

To use full-text search, SQL must be used. The results from the SQL query, however, can still be returned to an XQuery context for further processing. The following example shows how the results from an SQL query that used full-text search can participate in an XQuery expression:

```
XQUERY for $i in db2-fn:sqlquery ('SELECT DEPTDOC FROM DEPT
WHERE contains
(DEPTDOC, SECTIONS("/dept/description") "marketing") = 1')//employee
return $i/name
```

In this example, the results of the SQL query, which exploited full-text search, are returned to the for clause of the XQuery FLWOR expression. The for clause then returns all <employee> elements, and the return clause returns the <name> elements within the retrieved <employee> elements.

For more information on DB2 Net Search Extender, refer to the DB2 Net Search Extender documentation or see the Web at [www.ibm.com/software/data/db2/extendors/netsearch](http://www.ibm.com/software/data/db2/extendors/netsearch).

---

## Retrieval of data in XML columns to earlier DB2 clients

If you retrieve data from an XML column to a client that is at an earlier release than DB2 Version 9.1, your database client cannot handle XML data.

During DRDA<sup>®</sup> processing, when the database server recognizes a client that cannot support XML data, by default, the DB2 database server describes XML data values as BLOB values and sends the data to the client as BLOB data. The BLOB data is the serialized string representation of the XML data, with a complete XML declaration.

If you want to receive the data as a data type other than a BLOB data type, use one of the following methods:

- To retrieve the data as CLOB data, ask the administrator of the database server to use the db2set command to set the DB2\_MAP\_XML\_AS\_CLOB\_FOR\_DLC registry variable to YES on the server.

**Important:** When you set the DB2\_MAP\_XML\_AS\_CLOB\_FOR\_DLC registry variable to YES on the database server, all DB2 clients at earlier release levels that connect to any database within the instance receive XML data as CLOB data.

**Important:** When DB2\_MAP\_XML\_AS\_CLOB\_FOR\_DLC registry variable to YES on the database server, clients receive CLOB data that is the serialized string representation of the XML data, **without** an XML declaration.

- To retrieve the data as CLOB, CHAR, or VARCHAR data, invoke the XMLSERIALIZE function on the column data to instruct the DB2 database server to convert the data to the specified data type before it sends the data to the client.

When you do not invoke XMLSERIALIZE to retrieve data from a database server to a client at an earlier release level, the column from which you retrieve the data does not behave exactly like a BLOB or CLOB column. For example, although you can use the LIKE predicate on a BLOB column, you cannot use the LIKE predicate on an XML column that returns BLOB or CLOB data.

---

## SQL/XML publishing functions for constructing XML values

You can construct XML values, which do not necessarily have to be well-formed XML documents, by combining those publishing functions that correspond to the components you want in the resulting the XML value. The functions must be specified in the order that you want the results to appear.

Values constructed using the SQL/XML publishing functions are returned as XML. Depending on what you want to do with the XML value, you might need to explicitly serialize the value to convert it to another SQL data type. Refer to the documentation on XML serialization for details.

The following SQL/XML publishing functions can be used to construct XML values. For a description of each function's syntax, see Appendix B, "SQL/XML publishing functions," on page 447:

### **XMLAGG aggregate function**

Returns an XML sequence containing an item for each non-null value in a set of XML values.

### **XMLATTRIBUTES scalar function**

Constructs XML attributes from the arguments. This function can be used only as an argument of the XMLELEMENT function.

### **XMLCOMMENT scalar function**

Returns an XML value with a single XQuery comment node with the input argument as the content.

### **XMLCONCAT scalar function**

Returns a sequence containing the concatenation of a variable number of XML input arguments.

### **XMLDOCUMENT scalar function**

Returns an XML value with a single XQuery document node with zero or more child nodes. This function creates a document node, which by definition, every XML document must have. A document node is not visible in the serialized representation of XML, however, every document that is to be stored in a DB2 table must contain a document node.

### **XMLELEMENT scalar function**

Returns an XML value that is an XML element node. Note that the XMLELEMENT function does not create a document node, only an element node. When constructing XML documents that are to be inserted, it is not sufficient to create only an element node. The document must contain a document node, created with the XMLDOCUMENT function.

### **XMLFOREST scalar function**

Returns an XML value that is a sequence of XML element nodes.



**XMLGROUP aggregate function**

Returns a single top-level element to represent a table or the result of a query. By default each row in the result set is mapped to a row subelement and each input expression is mapped to a subelement of the row subelement. Optionally, each row in the result can be mapped to a row subelement and each input expression to be mapped to an attribute of the row subelement.

**XMLNAMESPACES declaration**

Constructs namespace declarations from the arguments. This declaration can be used only as an argument of the XMLELEMENT, XMLFOREST, and XMLTABLE functions.

**XMLPI scalar function**

Returns an XML value with a single XQuery processing instruction node.

**XMLROW scalar function**

Returns a sequence of row elements to represent a table or the result of a query. By default each input expression is transformed into a subelement of a row element. Optionally, each input expression can be transformed into an attribute of a row element.

**XMLTEXT scalar function**

Returns an XML value with a single XQuery text node having the input argument as the content.

**XSLTRANSFORM scalar function**

Converts XML data into other formats, including other XML schemas.

**Null element values**

When an XML value is constructed using XMLELEMENT or XMLFOREST, it is possible that a null value is encountered when determining the element's content. The EMPTY ON NULL and NULL ON NULL options of XMLELEMENT and XMLFOREST allow you to specify whether an empty element or no element is generated when an element's content is null. The default null handling for XMLEXISTS is EMPTY ON NULL. The default null handling for XMLFOREST is NULL ON NULL.

**Examples of publishing XML values**

The following examples show how you can construct XML values with SQL/XML publishing functions and with XQuery expressions.

**Example: Construct an XML document with constant values**

This simple example shows how you can construct constant XML values suitable for publishing with SQL/XML publishing functions.

As a simple example, consider the following XML element:

```
<elem1 xmlns="http://posample.org" id="111">
  <!-- example document -->
  <child1>abc</child1>
  <child2>def</child2>
</elem1>
```

The document consists of:

- three element nodes (elem1, child1, and child2)
- a namespace declaration
- an "id" attribute on <elem1>

- a comment node

To construct this document, perform the following steps:

1. Create an element node named "elem1", using XMLELEMENT.
2. Add a default namespace declaration to the XMLELEMENT function call for <elem1>, using XMLNAMESPACES.
3. Create an attribute named "id" using XMLATTRIBUTES, placing it after the XMLNAMESPACES declaration.
4. Create a comment node using XMLCOMMENT, within the XMLELEMENT function call for <elem1>.
5. Create a forest of elements that are named "child1" and "child2" using the XMLFOREST function, within the XMLELEMENT function call for <elem1>.

These steps are combined into the following query:

```
VALUES XMLELEMENT (NAME "elem1",
                  XMLNAMESPACES (DEFAULT 'http://posample.org'),
                  XMLATTRIBUTES ('111' AS "id"),
                  XMLCOMMENT ('example document'),
                  XMLFOREST('abc' as "child1",
                           'def' as "child2"))
```

### Example: Construct an XML document with values from a single table

This example shows how you can construct XML values suitable for publishing from a single table with SQL/XML publishing functions.

This example shows how an XML document can be constructed from values stored in a single table. In the following query, each <item> element is constructed with values from the name column of the PRODUCT table, using the XMLELEMENT function. All <item> elements are then aggregated, using XMLAGG, within the constructed <allProducts> element.

```
SELECT XMLELEMENT (NAME "allProducts",
                  XMLAGG(XMLELEMENT (NAME "item", p.name)))
FROM Product p
<allProducts>
  <item>Snow Shovel, Basic 22 inch</item>
  <item>Snow Shovel, Deluxe 24 inch</item>
  <item>Snow Shovel, Super Deluxe 26 inch</item>
  <item>Ice Scraper, Windshield 4 inch</item>
</allProducts>
```

You can construct a similar XML document that contains a sequence of row elements by using the XMLROW function instead of aggregating the elements with XMLAGG.

```
SELECT XMLELEMENT (NAME "products",
                  XMLROW(NAME as "po:item"))
FROM Product
```

The resulting output is as follows:

```
<products>
  <row>
    <po:item>Snow Shovel, Basic 22 inch</po:item>
  </row>
</products>
<products>
  <row>
    <po:item>Snow Shovel, Deluxe 24 inch</po:item>
  </row>
```

```

</products>
<products>
  <row><po:item>Snow Shovel, Super Deluxe 26 inch</po:item>
  </row>
</products>
<products>
  <row><po:item>Ice Scraper, Windshield 4 inch</po:item>
  </row>
</products>

```

4 record(s) selected.

### Example: Construct an XML document with values from multiple tables

This example shows how you can construct XML values suitable for publishing from multiple tables with SQL/XML publishing functions.

This example shows how an XML document can be constructed from values stored in multiple tables. In the following query, <prod> elements are constructed from a forest of elements, which are called name and numInStock, using the XMLFOREST function. This forest is built with values from the PRODUCT and INVENTORY tables. All <prod> elements are then aggregated within the constructed <saleProducts> element.

```

SELECT XMLELEMENT (NAME "saleProducts",
                  XMLAGG (XMLELEMENT (NAME "prod",
                                      XMLATTRIBUTES (p.Pid AS "id"),
                                      XMLFOREST (p.name as "name",
                                                i.quantity as "numInStock"))))
FROM PRODUCT p, INVENTORY i
WHERE p.Pid = i.Pid

```

The previous query yields the following XML document:

```

<saleProducts>
  <prod id="100-100-01">
    <name>Snow Shovel, Basic 22 inch</name>
    <numInStock>5</numInStock>
  </prod>
  <prod id="100-101-01">
    <name>Snow Shovel, Deluxe 24 inch</name>
    <numInStock>25</numInStock>
  </prod>
  <prod id="100-103-01">
    <name>Snow Shovel, Super Deluxe 26 inch</name>
    <numInStock>55</numInStock>
  </prod>
  <prod id="100-201-01">
    <name>Ice Scraper, Windshield 4 inch</name>
    <numInStock>99</numInStock>
  </prod>
</saleProducts>

```

### Example: Construct an XML document with values from table rows that contain null elements

This example shows how you can construct XML values suitable for publishing from table rows that contain null elements with SQL/XML publishing functions.

This example assumes that the LOCATION column of the INVENTORY table contains a null value in one row. The following query therefore does not return the <loc> element, because XMLFOREST treats nulls as null by default:

```

SELECT XMLELEMENT (NAME "newElem",
                  XMLATTRIBUTES (PID AS "prodID"),
                  XMLFOREST (QUANTITY as "quantity",
                             LOCATION as "loc"))
FROM INVENTORY
<newElem prodID="100-100-01"><quantity>5</quantity></newElem>

```

The same query, with the EMPTY ON NULL option specified, returns an empty <loc> element:

```

SELECT XMLELEMENT (NAME "newElem",
                  XMLATTRIBUTES (PID AS "prodID"),
                  XMLFOREST (QUANTITY as "quantity",
                             LOCATION as "loc" OPTION EMPTY ON NULL))
FROM INVENTORY
<newElem prodID="100-100-01"><quantity>5</quantity><loc /></newElem>

```

### Example: Publishing data with XQuery

This example shows how you can construct XML values suitable for publishing not only with SQL/XML publishing functions but also with XQuery expressions.

The following XQuery expression uses the delete updating expression to create a simple customer list. The expression removes the customer ID, address, assistant information, and non-work phone numbers from the customer information and moves the country attribute from the address node element to the customerinfo node element.

```

xquery
<phonenumberlist>
  {for $d in db2-fn:xmlcolumn("CUSTOMER.INFO")/customerinfo
   return
    transform
      copy $mycust := $d
      modify (
        do delete ( $mycust/@Cid ,
                    $mycust/addr ,
                    $mycust/assistant ,
                    $mycust/phone[@type!="work"] ),
        do insert attribute country { $mycust/addr/@country } into $mycust )
    return $mycust }
</phonenumberlist>

```

Note that although address element is deleted, the address information is accessible within the **modify** clause and the country attribute from the address element is used by the insert expression.

The query returns the following results:

```

<phonenumberlist>
  <customerinfo country="Canada">
    <name>Kathy Smith</name>
    <phone type="work">416-555-1358</phone>
  </customerinfo>
  <customerinfo country="Canada">
    <name>Kathy Smith</name>
    <phone type="work">905-555-7258</phone>
  </customerinfo>
  <customerinfo country="Canada">
    <name>Jim Noodle</name>
    <phone type="work">905-555-7258</phone>
  </customerinfo>
  <customerinfo country="Canada">
    <name>Robert Shoemaker</name>
    <phone type="work">905-555-7258</phone>

```

```

</customerinfo>
<customerinfo country="Canada">
  <name>Matt Foreman</name>
  <phone type="work">905-555-4789</phone>
</customerinfo>
<customerinfo country="Canada">
  <name>Larry Menard</name>
  <phone type="work">905-555-9146</phone>
</customerinfo>
</phonenumberlist>

```

## Special character handling in SQL/XML publishing functions

SQL/XML publishing functions have a default behavior for handling special characters.

### SQL values to XML values

Certain characters are considered special characters within XML documents, and must appear in their escaped format, using their entity representation. These special characters are as follows:

*Table 17. Special characters and their entity representations*

Special character	Entity representation
<	&lt;
>	&gt;
&	&amp;
"	&quot;

When publishing SQL values as XML values using the SQL/XML publishing functions, these special characters are escaped and replaced with their predefined entities.

### SQL identifiers and QNames

When publishing or constructing XML values from SQL values, it can be necessary to map an SQL identifier to an XML qualified name, or QName. The set of characters that are allowed in delimited SQL identifiers differs, however, from those permitted in a QName. This difference means that some characters used in SQL identifiers will not be valid in QNames. These characters are therefore substituted with their entity representation in the QName.

For example, consider the delimited SQL identifier "phone@work". Because the @ character is not a valid character in a QName, the character is escaped, and the QName becomes: phone&#x0040;work.

Note that this default escape behavior applies only to column names. For SQL identifiers that are provided as the element name in XMLELEMENT, or as alias names in the AS clause of XMLFOREST and XMLATTRIBUTES, there are no escape defaults. You must provide valid QNames in these cases. Refer to the W3C XML namespace specifications for more details on valid names.

## XML serialization

XML serialization is the process of converting XML data from its representation in the XQuery and XPath data model, which is the hierarchical format it has in a DB2 database, to the serialized string format that it has in an application.

You can let the DB2 database manager perform serialization implicitly, or you can invoke the XMLSERIALIZE function to explicitly request XML serialization. The most common usage of XML serialization is when XML data is sent from the database server to the client.

Implicit serialization is the preferred method in most cases because it is simpler to code, and sending XML data to the client allows the DB2 client to handle the XML data properly. Explicit serialization requires additional handling which is automatically handled by the client during implicit serialization.

In general, implicit serialization is preferable because it is more efficient to send data to the client as XML data. However, under certain circumstances (described later), it is better to do an explicit XMLSERIALIZE.

The best data type to which to convert XML data is the BLOB data type, because retrieval of binary data results in fewer encoding issues.

### Implicit XML serialization

With implicit serialization, the data has the XML type when it is sent to the client, if the client supports the XML data type. For CLI and embedded SQL applications, the DB2 database server adds an XML declaration, with the appropriate encoding specification, to the data. For Java and .NET applications, the DB2 database server does not add an XML declaration, but if you retrieve the data into a DB2Xml object and use certain methods to retrieve the data from that object, the IBM Data Server Driver for JDBC and SQLJ adds an XML declaration.

**Example:** In a C program, implicitly serialize the customerinfo document for customer ID '1000' and retrieve the serialized document into a binary XML host variable. The retrieved data is in the UTF-8 encoding scheme, and it contains an XML declaration.

```
EXEC SQL BEGIN DECLARE SECTION;
  SQL TYPE IS XML AS BLOB (1M) xmlCustInfo;
EXEC SQL END DECLARE SECTION;
...
EXEC SQL SELECT INFO INTO :xmlCustInfo
  FROM Customer
  WHERE Cid=1000;
```

### Explicit XML serialization

After an explicit XMLSERIALIZE invocation, the data has a non-XML data type in the database server, and is sent to the client as that data type.

XMLSERIALIZE lets you specify:

- The SQL data type to which the data is converted when it is serialized  
The data type is a character or binary data type.
- Whether the output data should include the following explicit encoding specification (EXCLUDING XMLDECLARATION or INCLUDING XMLDECLARATION):

```
<?xml version="1.0" encoding="UTF-8"?>
```

The output from XMLSERIALIZE is Unicode UTF-8-encoded data.

If you retrieve the serialized data into a non-binary data type, the data is converted to the application encoding, but the encoding specification is not modified. Therefore, the encoding of the data most likely will not agree with the encoding specification. This situation results in XML data that cannot be parsed by application processes that rely on the encoding name.

In general, implicit serialization is preferable because it is more efficient to send data to the client as XML data. However, under the following circumstances it is better to do an explicit XMLSERIALIZE:

- When XML documents are very large  
Because there are no XML locators, if the XML documents are very large, you should use XMLSERIALIZE to convert the data to a LOB type so that you can use LOB locators.
- When the client does not support XML data  
If the client is an earlier version that does not support the XML data type, and you use implicit XML serialization, the DB2 database server converts the data to one of the following data types before sending the data to the client:
  - The BLOB data type, by default
  - The CLOB data type, if you use the db2set command to set the DB2\_MAP\_XML\_AS\_CLOB\_FOR\_DLC registry variable to YES on the server

If you want the retrieved data to be some other data type, you can execute XMLSERIALIZE.

**Example:** XML column Info in sample table Customer contains a document that contains the hierarchical equivalent of the following data:

```
<customerinfo Cid='1000'>  
  <name>Kathy Smith</name>  
  <addr country='Canada'>  
    <street>5 Rosewood</street>  
    <city>Toronto</city>  
    <prov-state>Ontario</prov-state>  
    <pcode-zip>M6W 1E6</pcode-zip>  
  </addr>  
  <phone type='work'>416-555-1358</phone>  
</customerinfo>
```

Invoke XMLSERIALIZE to serialize the data and convert it to a BLOB type before retrieving it into a host variable.

```
SELECT XMLSERIALIZE(Info as BLOB(1M)) from Customer  
WHERE CID=1000
```

---

## Transforming with XSLT stylesheets

The standard way to transform XML data into other formats is by Extensible Stylesheet Language Transformations (XSLT). You can use the built-in XSLTRANSFORM function to convert XML documents into HTML, plain text, or different XML schemas.

XSLT uses stylesheets to convert XML into other data formats. You can convert part or all of an XML document and select or rearrange the data using the XPath query language and the built-in functions of XSLT. XSLT is commonly used to convert XML to HTML, but can also be used to transform XML documents that

comply with one XML schema into documents that comply with another schema. XSLT can also be used to convert XML data into unrelated formats, like comma-delimited text or formatting languages such as troff. XSLT has two main areas of applicability:

- Formatting (conversion of XML into HTML or formatting languages such as FOP);
- Data exchange (querying, reorganizing and converting data from one XML schema to another, or into a data exchange format such as SOAP).

Both cases may require that an entire XML document or only selected parts of it be transformed. XSLT incorporates the XPath specification, permitting query and retrieval of arbitrary data from the source XML document. An XSLT template may also contain or create additional information such as file headers and instruction blocks that will be added to the output file.

## How XSLT Works

XSLT stylesheets are written in Extensible Stylesheet Language (XSL), an XML schema. XSL is a template language rather than an algorithmic language such as C or Perl, a feature that limits XSL's power but makes it uniquely suited to its purpose. XSL stylesheets contain one or more template elements, which describe what action to take when a given XML element or query is encountered in the target file. A typical XSLT template element will start by specifying which element it applies to. For instance,

```
<xsl:template match="product">
```

declares that the contents of this template will be used to replace the content of any <product> tag encountered in the target XML file. An XSLT file consists of a list of such templates, in no necessary order.

The following example shows typical elements of an XSLT template. In this case the target will be XML documents containing inventory information, such as this record describing an ice scraper:

```
<?xml version="1.0"?>
<product pid="100-201-01">
  <description>
    <name>Ice Scraper, Windshield 4 inch</name>
    <details>Basic Ice Scraper 4 inches wide, foam handle</details>
    <price>3.99</price>
  </description>
</product>
```

This record includes such information as the part number, description and price of a windshield ice scraper. Some of this information is contained within elements, such as <name>. Some, like the part number, are contained in attributes (in this case the pid attribute of the <product> element). To display this information as a web page, you could apply the following XSLT template:

```
<?xml version="1.0" encoding="UTF-8"?>
<xsl:stylesheet version="1.0"
  xmlns:xsl="http://www.w3.org/1999/XSL/Transform">
<xsl:output method="html"/>
  <xsl:template match="/">
    <html>
      <body>
        <h1><xsl:value-of select="/product/description/name"/></h1>
        <table border="1">
          <th>
            <xsl:apply-templates select="product"/>
          </th>
        </table>
      </body>
    </html>
  </template>
</xsl:stylesheet>
```



```

                </th>
            </table>
        </body>
    </html>
</xsl:template>
<xsl:template match="product">
    <tr>
        <td width="80">product ID</td>
        <td><xsl:value-of select="@pid"/></td>
    </tr>
    <tr>
        <td width="200">product name</td>
        <td><xsl:value-of select="/product/description/name"/></td>
    </tr>
    <tr>
        <td width="200">price</td>
        <td><xsl:value-of select="/product/description/price"/></td>
    </tr>
    <tr>
        <td width="50">details</td>
        <td><xsl:value-of select="/product/description/details"/></td>
    </tr>
</xsl:template>
</xsl:stylesheet>

```

When an XSLT processor receives as input both the template and target documents shown previously, it will output the following HTML document:

```

<html>
<body>
<h1>Ice Scraper, Windshield 4 inch</h1>
<table border="1">
<th>
<tr>
<td width="80">product ID</td><td>100-201-01</td>
</tr>
<tr>
<td width="200">product name</td><td>Ice Scraper, Windshield 4 inch</td>
</tr>
<tr>
<td width="200">price</td><td>$3.99</td>
</tr>
<tr>
<td width="50">details</td><td>Basic Ice Scraper 4 inches wide, foam handle</td>
</tr>
</th>
</table>
</body>
</html>

```

The XSLT processor tests the incoming XML document for given conditions (typically one condition per template). If a condition is true the template contents are inserted into the output, and if they are false the template is passed over by the processor. The stylesheet may add its own data to the output, for example in the HTML table tagging and strings such as "product ID."

XPath can be used both to define template conditions, as in `<xsl:template match="product">` and to select and insert data from anywhere in the XML stream, as in `<h1><xsl:value-of select="/product/description/name"/></h1>`.

## Using XSLTRANSFORM

You can use the XSLTRANSFORM function to apply XSLT stylesheets to XML data. If you supply the function with the name of an XML document and an XSLT stylesheet, the function will apply the stylesheet to the document and return the result.

If you specify the document function of XSLT in your XSLT stylesheet, ensure that the `DB2_XSLT_ALLOWED_PATH` registry variable is set to the directories from where you can download additional XML documents.

## Passing parameters to XSLT stylesheets at runtime

Parameter can be passed at runtime when using the built-in XSLTRANSFORM function to convert XML documents.

An important feature of the XSLTRANSFORM function is its ability to accept XSLT parameters at runtime. In the absence of this ability you would need to maintain a large library of XSLT stylesheets, one for each variant of a query against the XML data; or, you would need to manually edit your stylesheets for each new kind of query. Parameter passing allows you to design generic stylesheets that can be left alone, while you accumulate a library of parameter files or potentially build them on the fly.

The XSLT parameters are contained in a separate XML document, for instance:

```
<?xml version="1.0"?>
<params xmlns="http://www.ibm.com/XSLTransformParameters">
  <param name="headline">BIG BAZAAR super market</param>
  <param name="supermarketname" value="true"/>
</params>
```

Each `<param>` element names a parameter and contains its values, either within the value attribute or for longer values, within the element itself. The preceding example shows both variations.

The parameters allowed by the XSLT template file are defined as variables using the `<xsl:param>` element, as follows:

```
<xsl:param name="headline"/>
<xsl:param name="supermarketname"/>
```

In this example you can call the `$headline` or `$supermarketname` variables anywhere inside the stylesheet and they will contain the data defined in the parameter file (in this case the string "BIG BAZAAR super market" and the value "true", respectively).

## Example: Using XSLT as a formatting engine

An example that illustrates how to use the built-in XSLTRANSFORM function as a formatting engine.

This example illustrates how to use XSLT as a formatting engine. To get set up, first insert the following two example documents into the database.

```
INSERT INTO XML_TAB VALUES
(1,
 '<?xml version="1.0"?>
 <students xmlns:xsi="http://www.w3.org/2001/XMLSchema-instance"
  xsi:noNamespaceSchemaLocation = "/home/steffen/xsd/xslt.xsd">
 <student studentID="1" firstName="Steffen" lastName="Siegmund"
```

```

    age="23" university="Rostock"/>
</students>',
  '<?xml version="1.0" encoding="UTF-8"?>
<xsl:stylesheet version="1.0"
  xmlns:xsl="http://www.w3.org/1999/XSL/Transform">
<xsl:param name="headline"/>
<xsl:param name="showUniversity"/>
<xsl:template match="students">
  <html>
    <head/>
    <body>
      <h1><xsl:value-of select="$headline"/></h1>
      <table border="1">
        <thead>
          <tr>
            <td width="80">StudentID</td>
            <td width="200">First Name</td>
            <td width="200">Last Name</td>
            <td width="50">Age</td>
            <xsl:choose>
              <xsl:when test="$showUniversity = 'true'">
                <td width="200">University</td>
              </xsl:when>
            </xsl:choose>
          </tr>
        </thead>
        <xsl:apply-templates/>
      </table>
    </body>
  </html>
</xsl:template>
<xsl:template match="student">
  <tr>
    <td><xsl:value-of select="@studentID"/></td>
    <td><xsl:value-of select="@firstName"/></td>
    <td><xsl:value-of select="@lastName"/></td>
    <td><xsl:value-of select="@age"/></td>
    <xsl:choose>
      <xsl:when test="$showUniversity = 'true' ">
        <td><xsl:value-of select="@university"/></td>
      </xsl:when>
    </xsl:choose>
  </tr>
</xsl:template>
</xsl:stylesheet>'
);

```

Next, call the XSLTRANSFORM function to convert the XML data into HTML and display it.

```
SELECT XSLTRANSFORM (XML_DOC USING XSL_DOC AS CLOB(1M)) FROM XML_TAB;
```

The result is this document:

```

<html>
<head>
<META http-equiv="Content-Type" content="text/html; charset=UTF-8">
</head>
<body>
<h1></h1>
<table border="1">
<thead>
<tr>
<td width="80">StudentID</td>
<td width="200">First Name</td>
<td width="200">Last Name</td>
<td width="50">Age</td>

```

```

</tr>
</th>
  <tr>
<td>1</td>
<td>Steffen</td><td>Siegmond</td>
<td>23</td>
</tr>
  </table>
</body>
</html>

```

In this example, the output is HTML and the parameters influence only what HTML is produced and what data is brought over to it. As such it illustrates the use of XSLT as a formatting engine for end-user output.

## Example: Using XSLT for data exchange

An example that illustrates how to use the built-in XSLTRANSFORM function to convert XML documents for data exchange.

This example illustrates how to use XSLT for data exchange by using parameters with the stylesheet to produce different data exchange formats at runtime.

We use a stylesheet that incorporates `xsl:param` elements to capture data from a parameter file.

```

INSERT INTO Display_productdetails values(1, '<?xml version="1.0" encoding="UTF-8"?>
<xsl:stylesheet version="1.0"
  xmlns:xsl="http://www.w3.org/1999/XSL/Transform">
<xsl:param name="headline"/>
<xsl:param name="supermarket"/>
<xsl:template match="product">
  <html>
    <head/>
    <body>
      <h1><xsl:value-of select="$headline"/></h1>
      <table border="1">
        <thead>
          <tr>
            <td width="80">product ID</td>
            <td width="200">product name</td>
            <td width="200">price</td>
            <td width="50">details</td>
            <xsl:choose>
              <xsl:when test="$supermarket = 'true' ">
                <td width="200">BIG BAZAAR super market</td>
              </xsl:when>
            </xsl:choose>
          </tr>
        </thead>
        <xsl:apply-templates/>
      </table>
    </body>
  </html>
</xsl:template>
<xsl:template match="product">
  <tr>
    <td><xsl:value-of select="@pid"/></td>
    <td><xsl:value-of select="/product/description/name"/></td>
    <td><xsl:value-of select="/product/description/price"/></td>
    <td><xsl:value-of select="/product/description/details"/></td>
  </tr>
</xsl:template>
</xsl:stylesheet>'
);

```

The parameter file contains parameters corresponding to the ones in the XSLT template, with content:

```
CREATE TABLE PARAM_TAB (DOCID INTEGER, PARAM VARCHAR (10K));

INSERT INTO PARAM_TAB VALUES
(1,
'<?xml version="1.0"?>
<params xmlns="http://www.ibm.com/XSLTransformParameters">
  <param name="supermarketname" value="true"/>
  <param name="headline">BIG BAZAAR super market</param>
</params>'
);
```

You can then apply the parameter file at runtime using the following command:

```
SELECT XSLTRANSFORM (XML_DOC USING XSL_DOC WITH PARAM AS CLOB (1M))
FROM product_details X, PARAM_TAB P WHERE X.DOCID=P.DOCID;
```

The result is HTML, but with content determined by the parameter file and tests done against the content of the XML document:

```
<html>
<head>
<META http-equiv="Content-Type" content="text/html; charset=UTF-8">
</head>
<body>
<h1></h1>
<table border="1">
<th>
<tr>
<td width="80">product ID</td>
<td width="200">product Name</td>
<td width="200">price</td>
<td width="50">Details</td>
</tr>
</th>
</table>
</body>
</html>
```

In other applications, the output of XSLTRANSFORM might not be HTML but rather another XML document or a file using a different data format, such as an EDI file.

For data exchange applications, the parameter file could contain EDI or SOAP file header information such as e-mail or port addresses, or other critical data unique to a particular transaction. Since the XML used in the previous examples is an inventory record, it is easy to imagine using XSLT to repackage this record for exchange with a client's purchasing system.

## Example: Using XSLT to remove namespaces

XML documents you receive might contain unneeded or incorrect namespace information. You can use XSLT style sheets to remove or manipulate the namespace information in the documents.

The following examples shows how to use XSLT to remove namespace information from an XML document. The examples store the XML document and the XSLT stylesheets in XML columns and use the XSLTRANSFORM function to convert the XML document using one of the XSLT stylesheets.

The following CREATE statements create the tables XMLDATA and XMLTRANS. XMLDATA contains a sample XML document, and XMLTRANS contains XSLT stylesheets.

```
CREATE TABLE XMLDATA (ID BIGINT NOT NULL PRIMARY KEY, XMLDOC XML );
CREATE TABLE XMLTRANS (XSLID BIGINT NOT NULL PRIMARY KEY, XSLT XML );
```

Add the sample XML document to the XMLDATA table using the following INSERT statement.

```
insert into XMLDATA (ID, XMLDOC) values ( 1, '
<newinfo xmlns="http://mycompany.com">
<!-- merged customer information -->
  <customerinfo xmlns="http://oldcompany.com" xmlns:d="http://test" Cid="1004">
    <name>Matt Foreman</name>
    <addr country="Canada">
      <street>1596 Baseline</street>
      <city>Toronto</city>
      <prov-state>Ontario</prov-state>
      <pcode-zip>M3Z 5H9</pcode-zip>
    </addr >
    <phone type="work" >905-555-4789</phone>
    <h:phone xmlns:h="http://test1" type="home">416-555-3376</h:phone>
    <d:assistant>
      <name>Gopher Runner</name>
      <h:phone xmlns:h="http://test1" type="home">416-555-3426</h:phone>
    </d:assistant>
  </customerinfo>
</newinfo>
');
```

## Example XSLT stylesheet that removes all namespaces

The following example uses an XSLT stylesheet to remove all namespace information from the XML document stored in the table XMLDATA. The examples stores the stylesheet in the table XMLTRANS and uses a SELECT statement to apply the stylesheet to the XML document.

Add the stylesheet to the XMLTRANS table using the INSERT statement.

```
insert into XMLTRANS (XSLID, XSLT) values ( 1, '
<xsl:stylesheet version="1.0" xmlns:xsl="http://www.w3.org/1999/XSL/Transform">
  <xsl:output method="xml" version="1.0" encoding="UTF-8" indent="yes"/>

  <!-- keep comments -->
  <xsl:template match="comment()">
    <xsl:copy>
      <xsl:apply-templates/>
    </xsl:copy>
  </xsl:template>

  <xsl:template match="*">
    <!-- remove element prefix -->
    <xsl:element name="{local-name()}">
      <!-- process attributes -->
      <xsl:for-each select="@*">
        <!-- remove attribute prefix -->
        <xsl:attribute name="{local-name()}">
          <xsl:value-of select="."/>
        </xsl:attribute>
      </xsl:for-each>
      <xsl:apply-templates/>
    </xsl:element>
  </xsl:template>
</xsl:stylesheet>
');
```

The following SELECT statement converts the sample XML document using the XSLT stylesheet.

```
SELECT XSLTRANSFORM (XMLDOC USING XSLT ) FROM XMLDATA, XMLTRANS
WHERE ID = 1 and XSLID = 1
```

The XSLTRANSFORM command converts the XML document using the first XSLT stylesheet and returns the following XML with all the namespace information removed.

```
<?xml version="1.0" encoding="UTF-8"?>
<newinfo>
  <!-- merged customer information -->
  <customerinfo Cid="1004">
    <name>Matt Foreman</name>
    <addr country="Canada">
      <street>1596 Baseline</street>
      <city>Toronto</city>
      <prov-state>Ontario</prov-state>
      <pcode-zip>M3Z 5H9</pcode-zip>
    </addr>
    <phone type="work">905-555-4789</phone>
    <phone type="home">416-555-3376</phone>
    <assistant>
      <name>Gopher Runner</name>
      <phone type="home">416-555-3426</phone>
    </assistant>
  </customerinfo>
</newinfo>
```

## Example XSLT stylesheet that keeps the namespace binding for an element

The following example uses an XSLT stylesheet keeps the namespace binding for only the phone element nodes. The name of the node is specified in the XSLT variable mynode. The examples stores the stylesheet in the table XMLTRANS and uses a SELECT statement to apply the stylesheet to the XML document.

Add the stylesheet to the XMLTRANS table using the following INSERT statement.

```
insert into XMLTRANS (XSLID, XSLT) values ( 2, '
<xsl:stylesheet version="1.0" xmlns:xsl="http://www.w3.org/1999/XSL/Transform">
  <xsl:output method="xml" version="1.0" encoding="UTF-8" indent="yes"/>
  <xsl:variable name ="mynode">phone</xsl:variable>

  <!-- keep comments -->
  <xsl:template match="comment() ">
    <xsl:copy>
      <xsl:apply-templates/>
    </xsl:copy>
  </xsl:template>

  <xsl:template xmlns:d="http://test" xmlns:h="http://test1" match="*">
  <xsl:choose>

  <!-- keep namespace prefix for node names $mynode -->
  <xsl:when test="local-name() = $mynode " >
    <xsl:element name="{name()}">
      <!-- process node attributes -->
      <xsl:for-each select="@*">
        <!-- remove attribute prefix -->
        <xsl:attribute name="{local-name()}">
          <xsl:value-of select="."/>
        </xsl:attribute>
      </xsl:for-each>
    </xsl:element>
  </xsl:when>
  <xsl:apply-templates/>
  </xsl:choose>
</xsl:stylesheet>
```

```

        </xsl:element>
    </xsl:when>

    <!-- remove namespace prefix from node -->
    <xsl:otherwise>
        <xsl:element name="{local-name()}">
            <!-- process node attributes -->
            <xsl:for-each select="@*">
                <!-- remove attribute prefix -->
                <xsl:attribute name="{local-name()}">
                    <xsl:value-of select="."/>
                </xsl:attribute>
            </xsl:for-each>
            <xsl:apply-templates/>
        </xsl:element>
    </xsl:otherwise>
</xsl:choose>
</xsl:template>
</xsl:stylesheet>
');

```

The following SELECT statement converts the sample XML document using the second XSLT stylesheet.

```

SELECT XSLTRANSFORM (XMLDOC USING XSLT) FROM XMLDATA, XMLTRANS
WHERE ID = 1 and XSLID = 2 ;

```

The XSLTRANSFORM command converts the XML document using the second XSLT stylesheet and returns the following XML with the namespaces for only the phone elements.

```

<?xml version="1.0" encoding="UTF-8"?>
<newinfo>
  <!-- merged customer information -->
  <customerinfo Cid="1004">
    <name>Matt Foreman</name>
    <addr country="Canada">
      <street>1596 Baseline</street>
      <city>Toronto</city>
      <prov-state>Ontario</prov-state>
      <pcode-zip>M3Z 5H9</pcode-zip>
    </addr>
    <phone type="work">905-555-4789</phone>
    <h:phone xmlns:h="http://test1" type="home">
      416-555-3376
    </h:phone>
    <assistant>
      <name>Gopher Runner</name>
      <h:phone xmlns:h="http://test1" type="home">
        416-555-3426
      </h:phone>
    </assistant>
  </customerinfo>
</newinfo>

```

## Example: Using the document function of XSLT

The use of built-in functions of XSLT is not recommended in pureXML. However, if you decide to use the document function of XSLT, you must set up the **DB2\_XSLT\_ALLOWED\_PATH** registry variable to the list of directories containing your XML documents to limit the references to a list of URIs. By default, the document function of XSLT cannot access any XML document.

The following examples illustrate how to use the document function of XSLT in a secure fashion.



The examples store the XML document and the XSLT stylesheets in XML columns and use the XSLTRANSFORM function to convert the XML document using one of the XSLT stylesheets. The examples use the XMLDATA and XMLTRANS tables created for “Example: Using XSLT to remove namespaces” on page 131.

## Example for Linux and UNIX environments

In this example, the XML files are located in the /home/user/xml\_files directory. Set the **DB2\_XSLT\_ALLOWED\_PATH** registry variable to this directory.

```
db2set DB2_XSLT_ALLOWED_PATH="/home/user/xml_files"
```

Restart the instance to make this registry variable setting effective.

Add the stylesheet to the XMLTRANS table using the INSERT statement.

```
INSERT INTO XMLTRANS (XSLID, XSLT)
VALUES ( 3, '<xsl:stylesheet version="1.0" xmlns:xsl="http://www.w3.org/1999/XSL/Transform">
  <xsl:template match="/">
    <xsl:value-of select="document(''/home/user/xml_files/n.xml'')/*"/>
  </xsl:template>
</xsl:stylesheet>') ;
```

The following SELECT statement converts the sample XML document using the XSLT stylesheet with XSLID = 3.

```
SELECT XSLTRANSFORM (XMLDOC USING XSLT ) FROM XMLDATA, XMLTRANS
WHERE ID = 1 and XSLID = 3
```

The XSLTRANSFORM command converts the XML document using the XSLT stylesheet and returns the converted XML document. If the database manager cannot open the document specified in the document function of XSLT, then call to the document function is ignored.

## Example for Windows environments

In this example, the XML files are located in the C:\Documents and Settings\user\xml\_files directory. Set the **DB2\_XSLT\_ALLOWED\_PATH** registry variable to this directory using one of the following ways:

- db2set DB2\_XSLT\_ALLOWED\_PATH="C:\Documents%20and%20Settings\user\xml\_files"
- db2set DB2\_XSLT\_ALLOWED\_PATH="file:///C:/Documents%20and%20Settings/user/xml\_files"

Use %20 to represent a blank space.

Restart the instance to make this registry variable setting effective.

Add the stylesheet to the XMLTRANS table using the INSERT statement.

```
INSERT INTO XMLTRANS (XSLID, XSLT)
VALUES ( 4, '<xsl:stylesheet version="1.0" xmlns:xsl="http://www.w3.org/1999/XSL/Transform">
  <xsl:template match="/">
    <xsl:value-of select="document(''C:\Documents and Settings\user\xml_files\t.xml'')"/>
  </xsl:template>
</xsl:stylesheet>') ;
```

The following SELECT statement converts the sample XML document using the XSLT stylesheet with XSLID = 4.

```
SELECT XSLTRANSFORM (XMLDOC USING XSLT ) FROM XMLDATA, XMLTRANS
WHERE ID = 1 and XSLID = 4
```

The XSLTRANSFORM command converts the XML document using the XSLT stylesheet and returns the converted XML document. If the database manager cannot open the document specified in the document function of XSLT, then call to the document function is ignored.

## Important considerations for transforming XML documents

When using the built-in XSLTRANSFORM function to convert XML documents some important considerations and restrictions apply.

Note the following when transforming XML documents:

- Source XML documents must be single-rooted and well-formed.
- Because XSLT transformation by default produces UTF-8 characters, the output stream might lose characters if inserted into columns defined with a character data type.

### Restrictions

- Only the W3C XSLT Version 1.0 Recommendation is supported.
- All parameters and the result type must be SQL types; they cannot be file names.
- Transformation with more than one stylesheet document (using an `xsl:include` or `xsl:import` declaration) is not supported.

### Usage note

There are many methods you can use to transform XML documents including the XSLTRANSFORM function, an XQuery update expression, and XSLT processing by an external application server. For documents stored in a DB2 XML column, many transformations can be performed more efficiently by using an XQuery update expression rather than with XSLT because XSLT always requires parsing of the XML documents that are being transformed.

If you decide to transform XML documents with XSLT, you should make careful decisions about whether to transform the document in the database or in an application server.

If you specify the document function of XSLT in your XSLT stylesheet, ensure that the `DB2_XSLT_ALLOWED_PATH` registry variable is set to the directories from where you can download additional XML documents.

---

## Differences in an XML document after storage and retrieval

When you store an XML document in a DB2 database and then retrieve that copy from the database, the retrieved document might not be exactly the same as the original document. This behavior is defined by the XML and SQL/XML standard and matches that of the Xerces open source XML parser.

Some of the changes to the document occur when the document is stored. Those changes are:

- If you execute XMLVALIDATE, the database server:
  - Adds default values from the XML schema that is specified in the XMLVALIDATE invocation to the input document
  - Strips ignorable whitespace from the input document
- If you do not request XML validation, the database server:

- Strips boundary whitespace, if you do not request preservation
- Performs end-of-line normalization, as specified in the XML 1.0 specification
- Performs attribute-value normalization, as specified in the XML 1.0 specification

This process causes line feed (U+000A) characters in attributes to be replaced with space characters (U+0020).

Additional changes occur when you retrieve the data from an XML column. Those changes are:

- If the data has an XML declaration before it is sent to the database server, the XML declaration is not preserved.

With implicit serialization, for CLI and embedded SQL applications, the DB2 database server adds an XML declaration, with the appropriate encoding specification, to the data. For Java and .NET applications, the DB2 database server does not add an XML declaration, but if you retrieve the data into a DB2XML object and use certain methods to retrieve the data from that object, the IBM Data Server Driver for JDBC and SQLJ adds an XML declaration.

If you execute the XMLSERIALIZE function, the DB2 database server adds an XML declaration with an encoding specification for UTF-8 encoding, if you specify the INCLUDING XMLDECLARATION option.

- Within the content of a document or in attribute values, certain characters are replaced with their predefined XML entities. Those characters and their predefined entities are:

Character	Unicode value	Entity representation
AMPERSAND	U+0026	&amp;
LESS-THAN SIGN	U+003C	&lt;
GREATER-THAN SIGN	U+003E	&gt;

- Within attribute values or text values, certain characters are replaced with their numeric representations. Those characters and their numeric representations are:

Character	Unicode value	Entity representation
CHARACTER TABULATION	U+0009	&#x9;
LINE FEED	U+000A	&#xA;
CARRIAGE RETURN	U+000D	&#xD;
NEXT LINE	U+0085	&#x85;
LINE SEPARATOR	U+2028	&#x2028;

- Within attribute values, the QUOTATION MARK (U+0022) character is replaced with its predefined XML entity &quot;.
- If the input document has a DTD declaration, the declaration is not preserved, and no markup based on the DTD is generated.
- If the input document contains CDATA sections, those sections are not preserved in the output.



---

## Chapter 6. Indexing XML data

An index over XML data can be used to improve the efficiency of queries on XML documents that are stored in an XML column.

In contrast to traditional relational indexes, where index keys are composed of one or more table columns you specify, an index over XML data uses a particular XML pattern expression to index paths and values in XML documents stored within a single column. The data type of that column must be XML.

Instead of providing access to the beginning of a document, index entries in an index over XML data provide access to nodes within the document by creating index keys based on XML pattern expressions. Because multiple parts of a XML document can satisfy an XML pattern, multiple index keys may be inserted into the index for a single document.

You create an index over XML data using the CREATE INDEX statement, and drop an index over XML data using the DROP INDEX statement. The GENERATE KEY USING XMLPATTERN clause you include with the CREATE INDEX statement specifies what you want to index.

Some of the keywords used with the CREATE INDEX statement for indexes on non-XML columns do not apply to indexes over XML data. The UNIQUE keyword also has a different meaning for indexes over XML data.

### Example: Creating an index over XML data

Suppose that table companyinfo has an XML column named companydocs, which contains XML document fragments like these:

#### Document for Company1

```
<company name="Company1">
  <emp id="31201" salary="60000" gender="Female">
    <name>
      <first>Laura</first>
      <last>Brown</last>
    </name>
    <dept id="M25">
      Finance
    </dept>
  </emp>
</company>
```

#### Document for Company2

```
<company name="Company2">
  <emp id="31664" salary="60000" gender="Male">
    <name>
      <first>Chris</first>
      <last>Murphy</last>
    </name>
    <dept id="M55">
      Marketing
    </dept>
  </emp>
  <emp id="42366" salary="50000" gender="Female">
    <name>
      <first>Nicole</first>
      <last>Murphy</last>
    </name>
  </emp>
</company>
```

```

        </name>
        <dept id="K55">
            Sales
        </dept>
    </emp>
</company>

```

Users of the companyinfo table often retrieve employee information using the employee ID. You might use an index like this one to make that retrieval more efficient:

```

CREATE INDEX empindex on companyinfo(companydocs)
    GENERATE KEY USING XMLPATTERN '/company/emp/@id'
    AS SQL DOUBLE

```

Figure 5. Example of an index over XML data

Notes to Figure 5:

- 1** The index over XML data is defined on the companydocs column of the companyinfo table. companydocs must be of the XML data type.
- 2** The GENERATE KEY USING XMLPATTERN clause provides information about what you want to index. This clause is called an XML index specification. The XML index specification contains an XML pattern clause. The XML pattern clause in this example indicates that you want to index the values of the id attribute of each employee element.
- 3** AS SQL DOUBLE indicates that indexed values are stored as DOUBLE values.

---

## Index XML pattern expressions

Only those parts of an XML document stored in an XML column that satisfy an XML pattern expression are indexed. To index on an XML pattern, you provide an index specification clause together with the CREATE INDEX statement.

The index specification clause begins with GENERATE KEY USING XMLPATTERN, followed by an XML pattern and a data type for the index over XML data. Alternatively, you can specify the clause GENERATE KEYS USING XMLPATTERN.

Only one index specification clause is allowed per CREATE INDEX statement. Multiple XML indexes can be created on an XML column.

### XML pattern expressions

To identify those parts of the document that will be indexed, an XML pattern is used to specify a set of nodes within the XML document. This pattern expression is similar to the path expression defined in the XQuery language, but it differs in that only a subset of the XQuery language is supported.

Path expression steps are separated by the forward slash (/). The double forward slash (//) which is the abbreviated syntax for /descendant-or-self::node()/ can also be specified. In each step, a forward axis (child::, @, attribute::, descendant::, self::, and descendant-or-self::) is chosen, followed by an XML name test or XML kind test. If no forward axis is specified, the child axis is used as the default.

If the XML name test is used, a qualified XML name or a wildcard is used to specify the node name to match for the step in the path. Instead of matching node names, the XML kind test can also be used to specify what kind of nodes to match in the pattern: text nodes, comment nodes, processing instruction nodes, or any other type of node.

Pattern expressions can include calls to supported functions to create indexes with special properties, such as case insensitivity. Only one function step is allowed per XMLPATTERN clause.

The following examples show statements that are logically equivalent with different pattern expressions.

Statements 1 and 2 are logically equivalent. Statement 1 uses the abbreviated syntax.

```
CREATE INDEX empindex on company(companydocs)
  GENERATE KEY USING XMLPATTERN '/company/emp/@id' AS SQL DOUBLE
```

*Figure 6. Statement 1*

```
CREATE INDEX empindex on company(companydocs)
  GENERATE KEY USING XMLPATTERN '/child::company/child::emp/attribute::id'
  AS SQL DOUBLE
```

*Figure 7. Statement 2*

Statement 3 and Statement 4 are logically equivalent. Statement 3 uses the abbreviated syntax.

```
CREATE INDEX idindex on company(companydocs)
  GENERATE KEY USING XMLPATTERN '//@id' AS SQL DOUBLE
```

*Figure 8. Statement 3*

```
CREATE INDEX idindex on company(companydocs)
  GENERATE KEY USING XMLPATTERN '/descendant-or-self::node()/attribute::id'
  AS SQL DOUBLE
```

*Figure 9. Statement 4*

Statement 5 uses the XML kind test to match text type nodes in the specified pattern:

*Figure 10. Statement 5*

```
CREATE INDEX empindex on company(companydocs)
  GENERATE KEY USING XMLPATTERN '/company/emp/name/last/text()' AS SQL
  VARCHAR(25)
```

Statements 6 and 7 create a case-insensitive index. Statement 7 specifies in which locale the values stored in the index should be converted.

```
CREATE INDEX empindex on company(companydocs)
  GENERATE KEY USING XMLPATTERN '/company/emp/name/last/fn:upper-case(.)'
  AS SQL VARCHAR(25)
```

*Figure 11. Statement 6*

Figure 12. Statement 7

```
CREATE INDEX empindex on company(companydocs)
    GENERATE KEY USING XMLPATTERN '/company/emp/name/last/fn:upper-case(.,
    "en_US")' AS SQL VARCHAR(25)
```

Statement 8 creates an index that indicates the existence of the middle name of an employee in the XML document structure.

Figure 13. Statement 8

```
CREATE INDEX empindex on company(companydocs)
    GENERATE KEY USING XMLPATTERN
    '/company/emp/name/fn:exists(middle)' AS SQL VARCHAR(1)
```

Statement 9 creates a VARCHAR index.

```
CREATE INDEX varcharidx on company(companydocs)
    GENERATE KEY USING XMLPATTERN '/company/emp/name/last'
    AS SQL VARCHAR(30)
```

Figure 14. Statement 9

Starting with DB2 V10.1, the optimizer can choose to use VARCHAR-type indexes for queries that have predicates containing the fn:starts-with function. The fn:starts-with function determines whether a string begins with a specific substring. No changes are necessary to existing VARCHAR indexes, and no special syntax needs to be used in the CREATE INDEX statement for new indexes.

## Qualifying Paths and Nodes

Consider a table named company with XML documents stored in an XML column, companydocs. The XML documents have a hierarchy with the two paths: '/company/emp/dept/@id' and '/company/emp/@id'. If the XML pattern specifies a single path, then a set of nodes in the document might qualify.

For example, if you want to search for a specific employee id attribute (@id) on the employee elements, they could create an index on the XML pattern '/company/emp/@id'. Then queries with predicates of the form '/company/emp[@id=42366]' could utilize the index on an XML column. In this case, the XMLPATTERN '/company/emp/@id' in the CREATE INDEX statement specifies a single path that refers to many different nodes in the document, since every employee element in the document might have an employee id attribute.

```
CREATE INDEX empindex on company(companydocs)
    GENERATE KEY USING XMLPATTERN '/company/emp/@id' AS SQL DOUBLE
```

If the XML pattern uses wildcard expressions, the descendant axis, or the descendant-or-self axis, then a set of paths and nodes might qualify. In the following example, the descendant-or-self axis is specified, so that the XML pattern '//@id' references paths for both department id attributes and employee id attributes since they both contain @id.

```
CREATE INDEX idindex on company(companydocs)
    GENERATE KEYS USING XMLPATTERN '//@id' AS SQL DOUBLE
```

If you want to search for a specific employee last name (<last>) on the name elements in a case-insensitive manner, for example, you can create an index on the XML pattern '/company/emp/name/last/fn:upper-case(.)'. Then queries with



predicates of the form '/company/emp/name/last[fn:upper-case(.)="SMITH"]' could utilize the index on an XML column. In this case, the context step of the XML pattern specifies a single path, '/company/emp/name/last'. For this path, many different nodes in the document might qualify, since each name element in the document might have a <last> element. All employee last names are indexed in the uppercase form.

```
CREATE INDEX empindex on company(companydocs)
    GENERATE KEY USING XMLPATTERN '/company/emp/name/last/fn:upper-case(.)'
    AS SQL VARCHAR(25)
```

If the XML pattern contains the fn:exists function, the index value is stored as a single character T or F, to indicate whether it is true or false that the item to be indexed exists in the XML document structure. In the following example, all employee middle names are indexed in a Boolean fashion.

```
CREATE INDEX midnameidx on company(companydocs)
    GENERATE KEY USING XMLPATTERN '/company/emp/name/fn:exists(middle)'
    AS SQL VARCHAR(1)
```

## Examples of using case insensitive XML indexes

To speed up queries that search string data, you can use the fn:upper-case() function to create indexes that store values as case-insensitive entries.

### Creating case-insensitive indexes

This example demonstrates how to create a table with an XML column, insert data into it, and create case-insensitive indexes.

First, create the table called CLIENTS, which has a column called CONTACTINFO that is of type XML:

```
CREATE TABLE clients (
    ID          INT PRIMARY KEY NOT NULL,
    NAME        VARCHAR(50),
    STATUS      VARCHAR(10),
    CONTACTINFO XML
);
```

Insert two records into the CLIENTS table:

```
INSERT INTO clients VALUES('0092', 'Johny Peterson', 'Standard',
'<Client>
  <address type="permanent">
    <street>8734 Zuze Ave.</street>
    <city>New York</city>
    <state>New York</state>
    <zip>95443</zip>
  </address>
</Client>');
```

```
INSERT INTO clients VALUES('0093', 'Rose Locke', 'Golden',
'<Client>
  <address type="PERMANENT">
    <street>1121 Oxford Street</street>
    <city>Albany</city>
    <state>new york</state>
    <zip>19232</zip>
  </address>
</Client>');
```

You can create a case-insensitive index, for example called `clients_state_idx`, on the `/Client/address/state` path. The first parameter of the `fn:upper-case()` function must always be a context item expression (`.`).

```
CREATE INDEX clients_state_idx ON clients(contactinfo)
  GENERATE KEYS USING XMLPATTERN '/Client/address/state/fn:upper-case(.)'
  AS SQL VARCHAR(50);
```

You can also create case-insensitive indexes on attributes. For example, you can create the index, called `client_address_type_idx`, on the `address` attribute, type, `/Client/address/@type` path.

```
CREATE INDEX client_address_type_idx ON clients(contactinfo)
  GENERATE KEYS USING XMLPATTERN '/Client/address/@type/fn:upper-case(.)'
  AS SQL VARCHAR(50);
```

For both the `clients_state_idx` index and the `client_address_type_idx` index, the index key values are stored in the upper-case form in the US English encoding set. For example, for the first data record that was inserted earlier, the value associated with the `/Client/address/state` path is `New York`, but is stored as `NEW YORK`. The value associated with the `/Client/address/@type` attribute is the lowercase string, `permanent`, but will be stored as `PERMANENT`.

## Running queries that use case-insensitive indexes

A case-insensitive index is considered by the optimizer only when the index pattern and predicate satisfy the following conditions:

- The path of the context step in the `GENERATE KEYS USING XMLPATTERN` clause of the `CREATE INDEX` statement matches the XML path in the query predicate.
- The locale name, if specified in the `CREATE INDEX` statement, matches the locale specified by the `fn:upper-case()` function in the query predicate.
- The first parameter of `fn:upper-case()` used in the query predicate is a context item expression (`.`).

For the following query, the optimizer might choose to use the case-insensitive index, `clients_state_idx`, if it exists. Instead of performing a table scan to find records where the state element has the value `New York` (in either upper or lower case), the optimizer can choose to scan the `clients_state_idx` index, if it involves less work.

```
XQUERY db2-fn:xmlcolumn('CLIENTS.CONTACTINFO')
  /Client/address/state[fn:upper-case(.)="NEW YORK"];
```

```
-----
<state>New York</state>
<state>new york</state>
```

2 record(s) selected.

## Specifying the locale parameter

When you create a case-insensitive index, you can use the optional locale parameter of the `fn:upper-case` function. For example, the following statement creates an index on the `address` attribute, type (with the path `/Client/address/@type`) for the `tr_TR` locale:

```
CREATE INDEX client_address_type_idx_tr ON clients(contactinfo)
  GENERATE KEYS USING XMLPATTERN '/Client/address/@type/fn:upper-case(., "tr_TR")'
  AS SQL VARCHAR(50);
```

Note that if you do not correctly specify the locale string, for example by omitting the surrounding quotes, a default value is used for the locale name. To verify the locale used during index creation, you can use the **db2look** command or the **DESCRIBE** statement. For example: DESCRIBE INDEXES FOR TABLE CLIENTS SHOW DETAIL.

The optimizer might choose to use the `client_address_type_idx_tr` index only if the query also specifies the locale, `tr_TR`, with `fn:upper-case()` in the query predicate. For example:

```
SELECT id FROM clients client1
WHERE XMLEXISTS('$XMLDOC/Client/address/@type[fn:upper-case(., "tr_TR")="PERMANENT"]'
PASSING client1.contactinfo as "XMLDOC")
```

```
ID
-----
      92
      93
```

2 record(s) selected.

For a query such as the following example, the index `client_address_type_idx_tr` is not used, because it specifies a different locale:

```
SELECT id FROM clients client1
WHERE XMLEXISTS('$XMLDOC/Client/address/@type[fn:upper-case(., "en_US")="PERMANENT"]'
PASSING client1.contactinfo as "XMLDOC")
```

```
ID
-----
      92
      93
```

2 record(s) selected.

## Examples of using indexes that specify `fn:exists`

You can use the `fn:exists` function to create an index that stores a Boolean value (a single character T or F) to indicate whether it is true or false that an element or attribute holds a data value (rather than the empty sequence).

### Creating an index with `fn:exists`

This example demonstrates how to create a table with an XML column, insert data into it, and create an index using the `fn:exists` function.

First, create the table called `INCOME`, which has a column called `INCOMEINFO` that is of type XML:

```
CREATE TABLE income (
  ID          INT PRIMARY KEY NOT NULL,
  INCOMEINFO XML
);
```

Insert three records into the `INCOME` table:

```
INSERT INTO income VALUES('1',
'<Employee>
  <salary type="regular">
    <base>5500.00</base>
    <bonus>1000.00</bonus>
  </salary>
</Employee>');
```

```
INSERT INTO income VALUES('2',
'<Employee>
```

```

    <salary type="contractor">
      <base>7600.00</base>
    </salary>
  </Employee>');

INSERT INTO income VALUES('3',
'<Employee>
  <salary>
    <base>2600.00</base>
    <bonus>500.00</bonus>
  </salary>
</Employee>');

```

You can create an index, for example called **exists\_bonus\_idx**, to check which employees have bonuses, by using the path `/Employee/salary/fn:exists(bonus)`:

```

CREATE INDEX exists_bonus_idx ON
  income(incomeinfo) GENERATE KEYS USING XMLPATTERN
  '/Employee/salary/fn:exists(bonus)' AS SQL VARCHAR(1);

```

You can also create an index, for example called **exists\_any\_attrib\_idx**, that checks for the existence of any attributes for the salary element, by using the path `/Employee/salary/fn:exists(@*)`:

```

CREATE INDEX exists_any_attrib_idx ON
  income(incomeinfo) GENERATE KEYS USING XMLPATTERN
  '/Employee/salary/fn:exists(@*)' AS SQL VARCHAR(1);

```

## Running queries that use these indexes

An index that was created using the `fn:exists` function is considered by the optimizer only when both of the following statements are true:

- The path of the index pattern matches the XML path in the query predicate.
- The query predicate performs a search for the element or attribute that is specified as the parameter of `fn:exists` in the `CREATE INDEX` statement

For the following query, the optimizer might choose to use the index, **exists\_bonus\_idx**, instead of performing a table scan, if it involves less work:

```

XQUERY db2-fn:xmlcolumn('INCOME.INCOMEINFO')
  /Employee/salary[fn:exists(bonus)];

```

```

-----
<salary type="regular"><base>5500.00</base><bonus>1000.00</bonus></salary>
<salary><base>2600.00</base><bonus>500.00</bonus></salary>

```

2 record(s) selected.

When this query is rewritten in the following form, the **exists\_bonus\_idx** index is also considered:

```

XQUERY db2-fn:xmlcolumn('INCOME.INCOMEINFO')/Employee/salary[bonus];

```

```

-----
<salary type="regular"><base>5500.00</base><bonus>1000.00</bonus></salary>
<salary><base>2600.00</base><bonus>500.00</bonus></salary>

```

2 record(s) selected.

The **exists\_bonus\_idx** index is considered for the following two queries, which find all employees who do not have a bonus:

```

XQUERY db2-fn:xmlcolumn('INCOME.INCOMEINFO')
  /Employee/salary[not(fn:exists(bonus))];

```

```
-----
<salary type="contractor"><base>7600.00</base></salary>
```

1 record(s) selected.

```
XQUERY db2-fn:xmlcolumn('INCOME.INCOMEINFO')
  /Employee/salary[fn:not(fn:exists(bonus))];
```

```
-----
<salary type="contractor"><base>7600.00</base></salary>
```

1 record(s) selected.

For the following query, the optimizer might choose to use the index, **exists\_any\_attrib\_idx**. This index checks for any attributes for the salary element. In our example data, only the type attribute exists. Therefore, in this case, the query predicate is true only if the attribute @type exists in the XML path /Employee/salary:

```
XQUERY db2-fn:xmlcolumn('INCOME.INCOMEINFO')
  /Employee/salary[fn:exists(@type)];
```

```
-----
<salary type="regular"><base>5500.00</base><bonus>1000.00</bonus></salary>
<salary type="contractor"><base>7600.00</base></salary>
```

2 record(s) selected.

The **exists\_any\_attrib\_idx** index is also considered by the optimizer for queries written in the following forms:

```
XQUERY db2-fn:xmlcolumn('INCOME.INCOMEINFO')/Employee/salary[bonus and @type];
```

```
-----
<salary type="regular"><base>5500.00</base><bonus>1000.00</bonus></salary>
```

1 record(s) selected.

```
XQUERY db2-fn:xmlcolumn('INCOME.INCOMEINFO')
  /Employee/salary[bonus and base > 3000];
```

```
-----
<salary type="regular"><base>5500.00</base><bonus>1000.00</bonus></salary>
```

1 record(s) selected.

```
XQUERY db2-fn:xmlcolumn('INCOME.INCOMEINFO')
  /Employee/salary[bonus and bonus > 600];
```

```
-----
<salary type="regular"><base>5500.00</base><bonus>1000.00</bonus></salary>
```

1 record(s) selected.

```
XQUERY db2-fn:xmlcolumn('INCOME.INCOMEINFO')
  /Employee/salary[bonus][bonus > 600];
```

```
-----
<salary type="regular"><base>5500.00</base><bonus>1000.00</bonus></salary>
```

1 record(s) selected.

```
XQUERY for $e in db2-fn:xmlcolumn('INCOME.INCOMEINFO')
  /Employee/salary where $e/bonus return $e;
```

```
-----
<salary type="regular"><base>5500.00</base><bonus>1000.00</bonus></salary>
<salary><base>2600.00</base><bonus>500.00</bonus></salary>
```

1 record(s) selected.

## Indexes created with the UNIQUE keyword

For an index created with the UNIQUE keyword that also specifies the fn:exists function in the XMLPATTERN clause, the unique semantics constrain the appearance of xml-wildcard (and other syntax, such as "/" ) over only the context step of the index pattern, but not over the input argument of fn:exists. For example, the following statement is valid:

```
CREATE UNIQUE INDEX i2 ON tbx1(x1) GENERATE KEYS USING XMLPATTERN
'/node/node1/fn:exists(*)' AS SQL VARCHAR(1)
```

Whereas, this second statement returns an error, because the context step of the index pattern is not unique:

```
CREATE UNIQUE INDEX i2 ON tbx1(x1) GENERATE KEYS USING XMLPATTERN
'/node/*/fn:exists(a)' AS SQL VARCHAR(1)
```

## Examples of using indexes with queries that specify fn:starts-with

Starting in DB2 V10.1, for queries with predicates that contain the fn:starts-with function, the optimizer can choose to use a VARCHAR-type index to speed up the query.

No changes are necessary to existing VARCHAR indexes, and you do not need to use any special syntax in the CREATE INDEX statement when you create new VARCHAR indexes.

The fn:starts-with function determines whether a string begins with a specific substring.

### Creating a VARCHAR type index

This example demonstrates how to create a table with an XML column, insert data into it, and create an index of VARCHAR type.

First, create the table called FAVORITE\_CDS, which has a column called CDINFO that is of type XML:

```
CREATE TABLE favorite_cds (
  NAME          CHAR(20) NOT NULL,
  CDID          BIGINT,
  CDINFO       XML
);
```

Insert a record into the FAVORITE\_CDS table:

```
INSERT INTO favorite_cds VALUES('John Peterson', 01,
'<FAVORITECDS>
  <CD>
    <TITLE>Top hits</TITLE>
    <ARTIST>Good Singer</ARTIST>
    <COMPANY>Top Records</COMPANY>
    <YEAR>1999</YEAR>
  </CD>
  <CD>
    <TITLE>More top hits</TITLE>
```

```

        <ARTIST>Better Singer</ARTIST>
        <COMPANY>Better Music </COMPANY>
        <YEAR>2005</YEAR>
    </CD>
    <CD>
        <TITLE>Even more top hits</TITLE>
        <ARTIST>Best Singer</ARTIST>
        <COMPANY>Best Music</COMPANY>
        <YEAR>2010</YEAR>
    </CD>
</FAVORITECDS>');

```

You can create a VARCHAR index, for example called **year\_idx**, on the /FAVORITECDS/CD/YEAR path, for example:

```

CREATE INDEX year_idx ON favorite_cds (cdinfo)
  GENERATE KEYS USING XMLPATTERN '/FAVORITECDS/CD/YEAR'
  AS SQL VARCHAR(20);

```

You can also create a VARCHAR index, for example called **company\_idx**, on the /FAVORITECDS/CD/COMPANY path. The following example creates a case insensitive index on company name by using the fn:upper-case function:

```

CREATE INDEX company_idx ON favorite_cds (cdinfo)
  GENERATE KEYS USING XMLPATTERN '/FAVORITECDS/CD/COMPANY/fn:upper-case(.)'
  AS SQL VARCHAR(20);

```

## Running queries that have predicates containing fn:starts-with

For the following query, the optimizer might choose to use the VARCHAR index, **year\_idx**, instead of performing a table scan to find CDs from the 1990s (in this example, the fn:starts-with function finds CDs having a year that starts with 199). The optimizer can choose to use the **year\_idx** index, if it involves less work.

```

XQUERY for $y in db2-fn:xmlcolumn
  ('FAVORITE_CDS.CDINFO')/FAVORITECDS/CD
  [YEAR/fn:starts-with(., "199")] return $y

```

```

-----
<CD>
  <TITLE>Top hits</TITLE>
  <ARTIST>Good Singer</ARTIST>
  <COMPANY>Top Records</COMPANY>
  <YEAR>1999</YEAR>
</CD>
1 record(s) selected.

```

Note that queries written in a format where you specify a context item expression (.) for the first parameter of the fn:starts-with function enable the optimizer to choose only one index scan, whereas other formats might require two index scans. For this reason, a similar query written in the following format will likely run more slowly:

```

XQUERY for $y in db2-fn:xmlcolumn
  ('FAVORITE_CDS.CDINFO')/FAVORITECDS/CD
  [fn:starts-with(YEAR, "199")] return $y

```

For the next query, the optimizer might choose to use the VARCHAR index, **company\_idx**, instead of performing a table scan to find records where the company name starts with BES. The optimizer can choose to use the **company\_idx** index, if it involves less work.

```

XQUERY for $y in db2-fn:xmlcolumn
  ('FAVORITE_CDS.CDINFO')/FAVORITECDS/CD
  [COMPANY/fn:starts-with(fn:upper-case(.), "BES")] return $y

```

```

-----
<CD>
  <TITLE>Even more top hits</TITLE>
  <ARTIST>Best Singer</ARTIST>
  <COMPANY>Best Music</COMPANY>
  <YEAR>2010</YEAR>
</CD>
1 record(s) selected.

```

## Context steps and function expression steps

The context step and function expression step are part of the XML index pattern specified when creating functional indexes over XML data. The context step defines the XML index pattern of the set of element or attribute nodes to be indexed. The function expression step specifies the function that defines the key values to be stored in the index.

In general, when you create functional indexes over XML data, for example by using the `fn:exists` and `fn:upper-case` functions, the XML pattern expression that you specify in the `GENERATE KEYS USING XMLPATTERN` clause has two parts.

The first part is called the *context step*. The context step specifies the XML path of the element nodes or attribute nodes for which index entries will be created. The syntax of the context step follows the same syntax as the index pattern expression for XML indexes in general, but has certain restrictions when used together with specific functions, such as `fn:upper-case` and `fn:exists`. See information about using the `CREATE INDEX` statement for details.

The second part is called the *function expression step*. The function expression step specifies the function, such as `fn:exists` or `fn:upper-case`, and its parameters. The function expression step produces the actual key value to be stored in the index for each node specified by the context step.

For example, for the index XML pattern `/a/b/fn:upper-case(.)`:

- The context step is `/a/b`
- The function expression step is `fn:upper-case(.)`

As another example, for the index XML pattern `/a/b/fn:exists(c)`:

- The context step is `/a/b`
- The function expression step `fn:exists(c)`

---

## XML namespace declarations

Qualified XML names (QNames) are used to define the element and attribute tags in XML pattern expressions. The qualifier for a QName is a namespace prefix which has been associated with a namespace URI.

The XML pattern can be specified using an optional namespace declaration to map a namespace prefix to a namespace URI string literal or to define a default namespace URI for the XML pattern. The namespace prefix is then used to qualify names of elements and attributes in the XML pattern to match them with the namespace used in the document.

In the following example, the shorthand namespace prefix `m` is mapped to `http://www.mycompanyname.com/`



```
CREATE INDEX empindex on department(deptdocs)
  GENERATE KEYS USING XMLPATTERN
  'declare namespace m="http://www.mycompanyname.com/";
  /m:company/m:emp/m:name/m:last' AS SQL VARCHAR(30)
```

Note that if this CREATE INDEX statement is issued from the command line processor (CLP), the embedded semicolon becomes problematic, because the semicolon is the default statement terminator. To avoid this issue, use one of the following workarounds:

- Ensure the semicolon is not the last non whitespace character on the line (by adding an empty XQuery comment after the semicolon, for example).
- Change the default statement terminator in the CLP from the command line.

Multiple namespace declarations can also be specified in the same XMLPATTERN expression, but the namespace prefix must be unique within the list of namespace declarations. In addition, the user has the option to declare a default namespace for elements that do not have a prefix. If a namespace or namespace prefix is not explicitly specified for an element, then the default namespace will be used. Default namespace declarations do not apply to attributes. If the user does not specify a default namespace, then the namespace will be *no namespace*. Only one default namespace can be declared. This namespace declaration behavior follows XQuery rules.

The previous example can also be written using a default namespace:

```
CREATE INDEX empindex on department(deptdocs)
  GENERATE KEY USING XMLPATTERN
  'declare default element namespace "http://www.mycompany.com/";
  /company/emp/name/last') AS SQL VARCHAR(30)
```

In the next example, the *@id* attribute has the *no namespace* namespace, since the default namespace *http://www.mycompany.com/* applies only to the *company* and *emp* elements, but not the *@id* attribute. This follows basic XQuery rules, since in an XML document default namespace declarations do not apply to attributes.

```
CREATE INDEX empindex on department(deptdocs)
  GENERATE KEY USING XMLPATTERN
  'declare default element namespace "http://www.mycompany.com/";
  /company/emp/@id' AS SQL VARCHAR(30)
```

Since the *@id* attribute should have the same namespace as the *company* and *emp* elements, the statement could be rewritten as:

```
CREATE INDEX empindex on department(deptdocs)
  GENERATE KEY USING XMLPATTERN
  'declare default element namespace "http://www.mycompany.com/";
  declare namespace m="http://www.mycompanyname.com/";
  /company/emp/@m:id' AS SQL VARCHAR(30)
```

The namespace prefix used to create the index and the namespace prefix used in the instance documents do not need to match to be indexed, but the fully expanded QName does need to match. The value of the namespace to which the prefix expands is important, not the prefix name itself. For example, if the namespace prefix for the index is defined as *m="http://www.mycompany.com/"* and the namespace prefix used in the instance document is *c="http://www.mycompany.com/"*, then *c:company/c:emp/@id* in the instance documents would be indexed, since both shorthand namespace prefixes *m* and *c* expand to the same namespace.

---

## Data types associated with index XML pattern expressions

Every XML pattern expression specified in the CREATE INDEX statement must be associated with a data type. The following SQL data types are supported: VARCHAR, DATE, TIMESTAMP, INTEGER, DECIMAL, and DOUBLE.

You can choose to interpret the result of the expression as multiple data types. For example, the value 123 has a character representation but it can also be interpreted as the number 123. If you would like to index the path `/company/emp/@id` as both a character string and as a numeric value, then two indexes must be created, one for the VARCHAR data type and one for the DOUBLE data type. The values in the document are converted to the specified data type for each index.

The following example shows how to create two indexes with different data types on the same XML column `deptdocs`:

```
CREATE INDEX empindex1 on department(deptdocs)
    GENERATE KEY USING XMLPATTERN '/company/emp/@id' AS SQL VARCHAR(10)
CREATE INDEX empindex2 on department(deptdocs)
    GENERATE KEY USING XMLPATTERN '/company/emp/@id' AS SQL DOUBLE
```

Description of supported SQL data types:

### **VARCHAR**(*integer*)

VARCHAR data will be stored in the index on an XML column in the UTF-8 code page. If the data type VARCHAR is used with the specified length *integer* (in bytes), the specified length is treated as a constraint. If documents are inserted into the table or exist in the table at the same time the index is created, then the document insertion or index creation will fail if there are nodes to be indexed with values longer than the specified length. If the insertion or creation succeeds, the index is guaranteed to store all character string values in their entirety and it can support both range scans and equality lookups. The length *integer* is a value in the range from 1 to the page size dependent maximum. See the CREATE INDEX statement for the list of maximum allowed lengths. XQuery semantics are used for string comparisons, where trailing blanks are significant. This differs from SQL semantics, where trailing blanks are insignificant during comparisons.

```
CREATE INDEX empindex1 on department(deptdocs)
    GENERATE KEY USING XMLPATTERN '/company/emp/@id' AS SQL VARCHAR(50)
```

### **VARCHAR HASHED**

VARCHAR HASHED may be specified to handle indexing of character strings with arbitrary lengths. If documents contain character strings to be indexed that exceed the maximum length *integer* allowed for the index based on the page size-dependent maximum, then you can specify VARCHAR HASHED instead. In this case, the system generates an 8 byte hash code over the entire string and there is no limit on the length of the indexed string. Range scans cannot be performed if you specify VARCHAR HASHED, since the index contains hash codes instead of the actual character data. Indexes using these hashed character strings may be used only for equality lookups. XQuery semantics are used for string equality comparisons, where trailing blanks are significant. This differs from SQL semantics, where trailing blanks are insignificant during comparisons. The hash on the string preserves XQuery semantics for equality, and not SQL semantics for equality.

```
CREATE INDEX empindex on company(companydocs)
    GENERATE KEY USING XMLPATTERN '/company/emp/name/last' AS SQL
    VARCHAR HASHED
```

## DOUBLE

All numeric values will be converted and stored in the index as the DOUBLE data type. Unbounded decimal types and 64 bit integers may lose precision when they are stored as a DOUBLE. The values for the index SQL data type DOUBLE may include the special numeric values *NaN*, *INF*, *-INF*, *+0*, and *-0*, even though the SQL data type DOUBLE itself does not support these values.

## INTEGER

All numeric values that conform to the XML Schema type *xs:int* will be converted and stored in the index as the INTEGER data type. Note that XML Schema defines multiple integer data types, including *xs:int* and *xs:integer*. The boundaries of *xs:int* correspond to the boundaries of the SQL type INTEGER, whereas *xs:integer* defines no boundaries. If a value is encountered that exceeds the boundaries of *xs:int*, an error is returned.

```
CREATE INDEX intidx on favorite_cds(cdinfo)
  GENERATE KEYS USING XMLPATTERN '/favoritecds/cd/year'
  AS SQL INTEGER
```

The word INT can be used as a synonym for the SQL data type INTEGER.

## DECIMAL(*integer*, *integer*)

All numeric values will be converted and stored in the index as the DECIMAL data type. The first integer is the precision of the number; that is, the total number of digits; it may range from 1 to 31. The second integer is the scale of the number; that is, the number of digits to the right of the decimal point; it may range from 0 to the precision of the number. If precision and scale are not specified, the default values of 5,0 are used.

```
CREATE INDEX decidx on favorite_cds(cdinfo) GENERATE KEYS USING XMLPATTERN
  '//price' AS SQL DECIMAL(5,2)
```

The words DEC, NUMERIC, and NUM can be used as synonyms for DECIMAL.

## DATE

DATE data type values will be normalized to UTC (Coordinated Universal Time) or Zulu time before being stored in the index. Note that the XML schema data type for DATE allows greater precision than the SQL data type. If an out-of-range value is encountered, an error is returned.

```
CREATE INDEX BirthdateIndex ON personnel(xmlDoc)
  GENERATE KEY USING XMLPATTERN '/Person/Confidential/Birthdate' AS SQL DATE
```

## TIMESTAMP

TIMESTAMP data type values will be normalized to UTC (Coordinated Universal Time) or Zulu time before being stored in the index. Note that the XML schema data type for timestamps allows greater precision than the SQL data type. If an out-of range value is encountered, an error is returned.

```
CREATE INDEX LastLogonIndex ON machines(xmlDoc)
  GENERATE KEY USING XMLPATTERN '/Machine/Employee/LastLogon' AS SQL TIMESTAMP
```

---

## Data type conversion for indexes over XML data

Before values can be inserted into the index over XML data, they are first converted to the index XML type corresponding to the index SQL data type.

For *VARCHAR(integer)* and *VARCHAR HASHED*, the value is converted to an *xs:string* value using the XQuery function *fn:string*. The length attribute of *VARCHAR(integer)* is applied as a constraint to the resulting *xs:string* value. An index SQL data type of *VARCHAR HASHED* applies a hash algorithm to the

resulting `xs:string` value to generate a hash code that is inserted into the index. Data for `VARCHAR` types is stored directly in the index without first being normalized to the schema data type.

For `DOUBLE`, `INTEGER`, `DECIMAL`, `DATE`, and `TIMESTAMP` indexes, the value is converted to the index XML type using the XQuery cast expression. `DATE` and `TIMESTAMP` data type values will be normalized to UTC (Coordinated Universal Time) or Zulu time before being stored in the index. XML data that is valid according to XQuery rules that cannot be converted to the index data type due to system limitations will result in an indexing error. The values for the index SQL data type `DOUBLE` may include the special numeric values `NaN`, `INF`, `-INF`, `+0`, and `-0`, even though the SQL data type `DOUBLE` itself does not support these values.

## Corresponding index data types

Table 18. Corresponding index data types

XML data type	SQL data type
<code>xs:string</code>	<code>VARCHAR(integer)</code> and <code>VARCHAR HASHED</code>
<code>xs:double</code>	<code>DOUBLE</code>
<code>xs:date</code>	<code>DATE</code>
<code>xs:dateTime</code>	<code>TIMESTAMP</code>
<code>xs:int</code>	<code>INTEGER</code>
<code>xs:decimal</code>	<code>DECIMAL(integer, integer)</code>

## Invalid XML values

XML pattern values are the indexed values generated by the `xmlpattern-clause` of the `CREATE INDEX` statement.

For indexes using the data types `DOUBLE`, `INTEGER`, `DECIMAL`, `DATE`, and `TIMESTAMP`, an XML pattern value is converted to the index XML data type using the XQuery cast expression. XML values that do not have a valid lexical form for the target index XML data type are considered to be invalid XML values.

For example, `ABC` is an invalid XML value for the `xs:double` data type. How the index handles the invalid XML values depends whether the `REJECT INVALID VALUES` option or the `IGNORE INVALID VALUES` option is specified in the `xmltype-clause` of the `CREATE INDEX` statement.

### REJECT INVALID VALUES

Specifies that all XML pattern values must be valid in the context of the lexical definition of the index XML data type. In addition the value must be in the range of the value space of the index XML data type. See the Related reference section, later, for links to details on the lexical definition and value space for each data type. For example, when you specify the `REJECT INVALID VALUES` clause, if you create an index of `INTEGER` type, XML pattern values such as `3.5`, `3.0`, `3e0`, `'A123'` and `'hello'` will return an error (SQLSTATE 23525). XML data is not inserted or updated in the table if the index already exists (SQLSTATE 23525). If the index does not exist, the index is not created (SQLSTATE 23526).

For example, suppose the user creates the index `EMPID`, which indexes the numeric employee IDs as a `DOUBLE` data type. Numeric values like `31201`

are indexed. However, if one of the documents uses the department ID value M55 as one of the employee ID attribute values by mistake, then the insert of the document fails with an error message because M55 is an invalid DOUBLE value.

```
CREATE INDEX EMPID ON DEPARTMENT(DEPTDOCS)
  GENERATE KEY USING XMLPATTERN '//@id' AS SQL DOUBLE
  REJECT INVALID VALUES
```

## IGNORE INVALID VALUES

Specifies that XML pattern values that are invalid lexical forms for the target index XML data type are ignored and that the corresponding values in the stored XML documents are not indexed by the CREATE INDEX statement. By default, invalid values are ignored. During insert and update operations, the invalid XML pattern values are not indexed, but XML documents are still inserted into the table. No error or warning is raised, because specifying these data types is not a constraint on the XML pattern values (XQuery expressions that search for the specific XML index data type will not consider these values).

The rules for what XML pattern values can be ignored are determined by the specified SQL data type.

- If the SQL data type is a character string data type, XML pattern values are never ignored since any sequence of characters is valid.
- If the SQL data type is a numeric data type, any XML pattern value that does not conform to the lexical format of the XML data type `xs:double` is ignored. If the XML pattern value does not conform to the more specific lexical formats of the XML data type corresponding to the numeric SQL data type of the index, an error is returned. For example, if the SQL data type is `INTEGER`, the XML pattern values of `3.5`, `3.0`, and `3e0` conform to the lexical format of `xs:double` but return an error (`SQLSTATE 23525`) because they do not conform to the lexical format of `xs:int`. XML pattern values such as `'A123'` or `'hello'` are ignored for the same index.
- If the SQL data type is a datetime data type, any XML pattern value that does not conform to the lexical format of the corresponding XML data type (`xs:date` or `xs:dateTime`) is ignored.

If an XML pattern value does conform to the appropriate lexical format, an error is returned if the value is outside the value space for the data type or exceeds the maximum length or precision and scale of the specified SQL data type. If the index does not exist, the index is not created (`SQLSTATE 23526`).

When invalid XML pattern values for the data type are ignored, the target index XML data type acts like a filter and is not a constraint since the user may have multiple indexes with different data types on the same XML column. For example, suppose the user creates two indexes on the same pattern but with different data types. The index `ALLID` uses the `VARCHAR` data type and indexes on all the IDs in the document (both department IDs and employee IDs). The index `EMPID` indexes only on the numeric employee IDs and uses the `DOUBLE` data type as a filter:

### Using the explicit IGNORE INVALID VALUES option

```
CREATE INDEX ALLID ON DEPARTMENT(DEPTDOCS)
  GENERATE KEY USING XMLPATTERN '//@id' AS SQL VARCHAR(10)
  IGNORE INVALID VALUES
```

```
CREATE INDEX EMPID ON DEPARTMENT(DEPTDOCS)
  GENERATE KEY USING XMLPATTERN '//@id' AS SQL DOUBLE
  IGNORE INVALID VALUES
```

### Logically equivalent statements using the default

```
CREATE INDEX ALLID ON DEPARTMENT(DEPTDOCS)
GENERATE KEY USING XMLPATTERN '//@id' AS SQL VARCHAR(10)
```

```
CREATE INDEX EMPID ON DEPARTMENT(DEPTDOCS)
GENERATE KEY USING XMLPATTERN '//@id' AS SQL DOUBLE
```

The department ID value M25 is a valid VARCHAR data type value and will be inserted into the index ALLID. However, M25 cannot be converted to the DOUBLE data type so that the value will not be inserted into EMPID and no error or warning is raised. The value is inserted for the document stored in the table.

Although the value M25 does not exist in the DOUBLE index EMPID, queries may still use the DOUBLE index to retrieve all the matching numeric values and no conversion errors will occur, because the document that contains M25 will not be accessed.

However, if the query does not use the DOUBLE index EMPID and scans the document using the `//@id=25` predicate, then a conversion error will occur because the value M25 matches the pattern and still exists in the document but is not a numeric value.

Note that all values in the document are valid for the `xs:string` (SQL VARCHAR) data type.

## Document rejection or CREATE INDEX statement failure

For the following types of indexing errors, the XML document is rejected for INSERT or UPDATE statements (SQLSTATE 23525, sqlcode -20305). For a CREATE INDEX statement on a populated table where the XML document already exists in the table, the CREATE INDEX statement fails (SQLSTATE 23526, sqlcode -20306) and the document remains stored in the table.

### VARCHAR(*integer*) length constraint errors

The length of a resulting index value from one or more XML pattern expressions exceeds the user-specified length constraint for the VARCHAR data type.

### Unsupported list data type node error

One or more XML node values in an XML value is a list data type node that cannot be indexed by the specified index. List data type nodes are not supported by indexes over XML data.

### Conversion errors

An error is returned if the source value is invalid for the index XML data type and the REJECT INVALID VALUES option was specified with the CREATE INDEX statement. An error is also issued if the source value is a valid XML value which cannot be converted to the DB2 database server representation for either the schema data type or for the index XML data type because of internal DB2 limitations. The error must be issued to maintain consistent results: If a query were to be executed that used the index, the correct result of the query could include a value that exceeds the supported limit since the value would be a valid XML value. To prevent the query from returning an incomplete result, an error is issued to maintain consistent results.

Table 19. Some examples of internal DB2 limitations

XML data type	XML schema	DB2 range (min : max)
xs:date	No maximum limit for years Negative dates are supported	0001-01-01: 9999-12-31
xs:dateTime	No maximum limit for years Negative dates are supported Arbitrary precision is supported for fractional seconds	0001-01-01T00:00:00.000000Z: 9999-12-31T23:59:59.999999Z
xs:integer	No limit on minimum or maximum range	-9223372036854775808: 9223372036854775807

DB2 database server does not support the entire range of XML values. Value ranges that are unsupported include:

- Date or dateTime values with year > 9999 or < 0
- Date or dateTime values with fractional second precision > 6 digits
- Out-of-range numeric values

## Summary table for conversion to the index XML data type

For data to convert successfully to the target index XML data type, the source value must be lexically valid according to the schema data type and index XML data type and the value must be within DB2 limits for the schema data type and index XML data type.

The following table summarizes how values are handled when being converted to an index XML data type.

Table 20. Summary table for conversion to the index XML data type

The value is valid according to the index XML data type (all values are valid for the xs:string data type)	The value is within DB2 limits for the index XML data type	Indexing result
No	not applicable	REJECT INVALID VALUES: Error  IGNORE INVALID VALUES (default): The value is ignored and not indexed.
Yes	Yes	The value is indexed.
Yes	No	Error: the value is outside of DB2 limits.

---

## XML schemas and index key generation

You should examine your XML schemas so that you can create indexes on XML columns with data types that match your XML schemas data type specifications. The queries that you want to run should also be taken into account when deciding which XML patterns to choose for your indexes.

If an XML schema is used, then the structure of XML documents to be stored in an XML column will be validated so that the data types of the elements and attributes in the XML documents are constrained against the XML schema. If a document does not match the schema's specifications, then the document is rejected by the parser. For example, if the schema specifies that an attribute is constrained to the DOUBLE data type and the value of the document's attribute is *ABC*, then the document is rejected. If an XML schema is not used, then document data is not validated by the parser and is considered to be untyped data.

For example, suppose the following XML schema is used:

```
<xsd:schema xmlns:xsd="http://www.w3.org/2001/XMLSchema">
  <xsd:element name="product" type="ProdType"/>
  <xsd:simpleType name="ColorType">
    <xsd:restriction base="xsd:string">
      <xsd:maxLength value='20' />
    </xsd:restriction>
  </xsd:simpleType>
  <xsd:complexType name="ProdType">
    <xsd:sequence>
      <xsd:element name="name" type="xsd:string" />
      <xsd:element name="SKU" type="xsd:string" />
      <xsd:element name="price" type="xsd:integer" />
      <xsd:element name="comment" type="xsd:string" />
    </xsd:sequence>
    <xsd:attribute name="color" type="ColorType" />
    <xsd:attribute name="weight" type="xsd:integer" />
  </xsd:complexType>
</xsd:schema>
```

After looking at the queries you need to issue, you may decide they need indexes on price and color. Analyzing the queries will help you decide what XML pattern expression to include in your CREATE INDEX statement. The XML schema provides guidance on what data type to pick for the index: you can tell that the price element is a decimal number, so the numeric data type of DECIMAL can be chosen for the index *priceindex* and the color attribute is a string so the data type of VARCHAR can be chosen for the index *colorindex*.

```
XQUERY for $i in db2-fn:xmlcolumn('COMPANY.PRODUCTDOCS')/product[price > 5.00]
  return $i/name
XQUERY for $i in db2-fn:xmlcolumn('COMPANY.PRODUCTDOCS')/product[@color = 'pink']
  return $i/name
CREATE INDEX priceindex on company(productdocs)
  GENERATE KEY USING XMLPATTERN '/product/price' AS DECIMAL(7,2)
CREATE INDEX colorindex on company(productdocs)
  GENERATE KEY USING XMLPATTERN '//@color' AS SQL VARCHAR(80)
```

The schema may also specify other constraints for the string data type, such as *maxLength* which is shown in the example under *ColorType* where the string is restricted to 20 unicode characters. Since the CREATE INDEX statement specifies the VARCHAR length in bytes and not in characters, the schema length may be multiplied by a factor of 4 to calculate the maximum number of bytes that will be



required to store the longest string allowed by the schema in the index. In this case,  $4 * 20 = 80$  so VARCHAR(80) is chosen for *colorindex*.

If the schema does not specify a length restriction for a string data type and the maximum string lengths for the values in the documents are not known, then you can use the maximum length allowed by the page size used by the index. An index stores strings of varying lengths, but since only the actual number of bytes required for each string is stored there is no storage penalty for specifying a longer maximum length than is needed. However, larger key buffers in memory do need to be allocated to handle the maximum key size during index scans. See the CREATE INDEX statement for the list of maximum allowed lengths for an index on an XML column specifying the VARCHAR data type.

If the maximum length for the VARCHAR data type is not sufficiently long to index the document values, then the VARCHAR HASHED data type may be used, which does not have a length limit. However, indexes using VARCHAR HASHED can be used only for equality look-ups and not for range scans. Note that documents which contain strings longer than the length specified for VARCHAR(*integer*) will be rejected.

The XML schema may also specify default attribute and element values. If there are no corresponding values specified in the XML document and the document is validated, then the default values from the schema are used when the document is stored. These default values will be indexed, along with the other values that were in the original input document. If the document is not validated, then the default values are not added to document and they are not indexed.

---

## UNIQUE keyword semantics

The same UNIQUE keyword that is used for indexes on non-XML columns is also used for indexes on XML columns, but it has a different meaning.

For relational indexes, the UNIQUE keyword in the CREATE INDEX statement enforces uniqueness across all rows in a table. For indexes over XML data, the UNIQUE keyword enforces uniqueness within a single XML column across all documents whose nodes are qualified by the XML pattern. The insertion of a single document may cause multiple values to be inserted into a unique index; these values must be unique in that document and in all other documents in the same XML column. Note also that the insertion of some documents may not result in any values being inserted into an index; uniqueness is not enforced for these documents.

Uniqueness is enforced for the data type of the index, the XML path to the node, and the value of the node after the XML value has been converted to the SQL data type that is specified for the index.

Caution should be used when specifying the UNIQUE keyword. Because converting to the specified data type for the index might result in a loss of precision or range, or different values might be hashed to the same key value, multiple values that appear to be unique in the XML document might result in duplicate key errors. Situations under which duplicate key errors can occur are:

- When VARCHAR HASHED is specified, unique character strings may hash to the same hash code and result in a duplicate key error.
- For an index of type DOUBLE, a loss of precision or values that are beyond the range of the DOUBLE data type can cause duplicate key errors during insertion.

For example, big integer and unbounded decimal values may lose precision when they are stored as the DOUBLE data type in the index. For these kinds of data, it is better to create an index of type INTEGER, or DECIMAL, respectively.

If VARCHAR(*integer*) is specified, then the entire character string from the XML document is stored in the index so that incorrect duplicate key errors cannot occur. In addition, uniqueness of character strings follows XQuery semantics, where trailing blanks are significant. Therefore, values that would be duplicates in SQL but differ in trailing blanks are considered unique values in an index over XML data.

```
CREATE UNIQUE INDEX EMPINDEX ON company(companydocs)
  GENERATE KEY USING XMLPATTERN '/company/emp/name/last' AS SQL
  VARCHAR(100)
```

For UNIQUE indexes, the XML pattern must specify a single complete path and may not contain any of the following:

- a descendant axis
- a descendant-or-self axis
- a /descendant-or-self::node()/ (//)
- any wildcards for the XML name test
- a node() or processing instruction() for the XML kind test

---

## Database objects associated with XML data indexing

### Logical and physical indexes over XML data

When you create an index over XML data, two B-tree indexes are created, a logical index and a physical index.

The logical index contains the XML pattern information specified by the CREATE INDEX statement. The physical index has DB2 generated key columns to support the logical index and contains the indexed document values, converted to the data type specified in the *xmltype-clause* of the CREATE INDEX statement.

You work with an index over XML data at the logical level (with the CREATE INDEX and DROP INDEX statements, for example). Processing of the underlying physical index by DB2 is transparent to you. Note that the physical index is not recognized by any application programming interface that returns index metadata.

In the SYSCAT.INDEXES catalog view, the logical index has the index name you specified in the CREATE INDEX statement and the index type *XVIL*. The physical index has a system generated name and the index type *XVIP*. The logical index is always created and assigned an index ID (IID) first. The physical index is created immediately afterwards and is assigned the next consecutive index ID.

The relationship between logical and physical indexes is demonstrated in the following example: Consider two indexes over XML data, *EMPINDEX* and *IDINDEX*. For *EMPINDEX*, the logical index has the name *EMPINDEX*, the index ID 3, and the index type *XVIL*. The corresponding physical index has the system generated name *SQL060414134408390*, the index ID 4, and the index type *XVIP*.

Table 21. The relationship between logical and physical indexes

Index name (INDNAME)	Index ID (IID)	Table name (TABNAME)	Index type (INDEXTYPE)
SQL060414133259940	1	COMPANY	XRGN
SQL060414133300150	2	COMPANY	XPTH
EMPINDEX	3	COMPANY	XVIL
SQL060414134408390	4	COMPANY	XVIP
IDINDEX	5	COMPANY	XVIL
SQL060414134408620	6	COMPANY	XVIP

## Catalog views

Please refer to the Related reference section for more information on each of these catalog views.

### SYSCAT.INDEXES

Each row represents an index, including logical and physical indexes over XML data.

### SYSCAT.INDEXXMLPATTERNS

Each row represents a pattern clause in an index over XML data.

## Indexes in a database partitioned environment

You can issue CREATE INDEX and ALTER INDEX statements from any database partition.

If you create an index on a table that is partitioned across multiple data partitions, the index is also partitioned across the data partitions.

## Auditing

Indexes on XML columns use the existing index object type for audits. Only the logical index is audited, and not the physical index.

## Other database objects associated with XML columns

There are two indexes associated with XML columns that are internal and system generated. The indexes are represented in the SYSCAT.INDEXES catalog view. In addition, index partitions for data partitioned tables with XML data are represented in the SYSCAT.INDEXPARTITIONS catalog view.

### XML path index and XML regions index

Whenever you create an XML column, an XML path index is automatically created by DB2 on the XML column. DB2 also creates a single XML regions index for all XML columns within a table.

The XML path index records all unique paths which exist within XML documents stored within an XML column.

The XML regions index captures how an XML document is divided up internally into regions, which are sets of nodes within a page. Since regions are sets of nodes

within a page, the number of regions index entries can be reduced, and performance may be improved, if a larger page size that can store more nodes within a page is used.

For a data partitioned table, the XML regions index is always a partitioned index, and the XML column path indexes are always nonpartitioned indexes.

The table space id and object id of the XML regions index in SYSCAT.INDEXES are logical values, because the regions index is always partitioned and the single entry in SYSCAT.INDEXES is a logical representative. The table space id and object id equal those of the partitioned table with which they are associated.

Every index partition associated with a data partition in a partitioned table has an entry in the SYSIBM.SYSINDEXPARTITIONS catalog table, containing information and statistics about that index partition. This information is accessed through the SYSCAT.INDEXPARTITIONS catalog view. Nonpartitioned indexes do not have any entries in this catalog table.

Both the XML path and the XML regions indexes are recorded in SYSCAT.INDEXES. Note that these indexes are not recognized by any application programming interface that returns index metadata.

These internal indexes associated with XML columns are distinct from user-created indexes over XML data. For indexing XML data as stored in XML columns, you work only with the logical indexes on XML columns, using statements such as CREATE INDEX and DROP INDEX.

## Catalog views

Refer to the Related reference section for more information on these catalog views.

### SYSCAT.INDEXES

Each row represents an index, including XML path and XML regions indexes. The XML path index is shown as *XPTH* in SYSCAT.INDEXES.INDEXTYPE, and the XML regions index is shown as *XRGN* in SYSCAT.INDEXES.INDEXTYPE.

### SYSCAT.INDEXPARTITIONS

Each row represents an index partition associated with a data partition in a partitioned table.

## Recreation of indexes over XML data

An index over XML data is recreated under the following circumstances:

- During a **REORG INDEX** or **REORG INDEXES** command.
- During a **REORG TABLE** command.
- When you issue an **IMPORT** command with the REPLACE option specified.
- When a query, insert, delete, or update operation attempts to access a table or an index and detects that the index object is marked invalid.

## Usage notes

- All indexes associated with native XML data store functionality are contained in the same index object for a table as relational indexes. This includes any XML path indexes, XML regions indexes, and indexes over XML data that may exist. Single indexes are not recreated alone. If index recreation becomes necessary, all indexes in the index object are recreated together.

- During a **REORG TABLE** command on a partitioned table, if the **LOBGLOBDATA** option is not specified, the XML path index will not be created.

## CREATE INDEX

The **CREATE INDEX** statement is used to define an index on a DB2 table. An index can be defined on XML data, or on relational data. The **CREATE INDEX** statement is also used to create an index specification (metadata that indicates to the optimizer that a data source table has an index).

### Invocation

This statement can be embedded in an application program or issued through the use of dynamic SQL statements. It is an executable statement that can be dynamically prepared only if **DYNAMICRULES** run behavior is in effect for the package (SQLSTATE 42509).

### Authorization

The privileges held by the authorization ID of the statement must include at least one of the following authorities:

- One of:
  - **CONTROL** privilege on the table or nickname on which the index is defined
  - **INDEX** privilege on the table or nickname on which the index is defined
- and one of:
  - **IMPLICIT\_SCHEMA** authority on the database, if the implicit or explicit schema name of the index does not exist
  - **CREATEIN** privilege on the schema, if the schema name of the index refers to an existing schema
- **DBADM** authority

No explicit privilege is required to create an index on a declared temporary table.

### Syntax

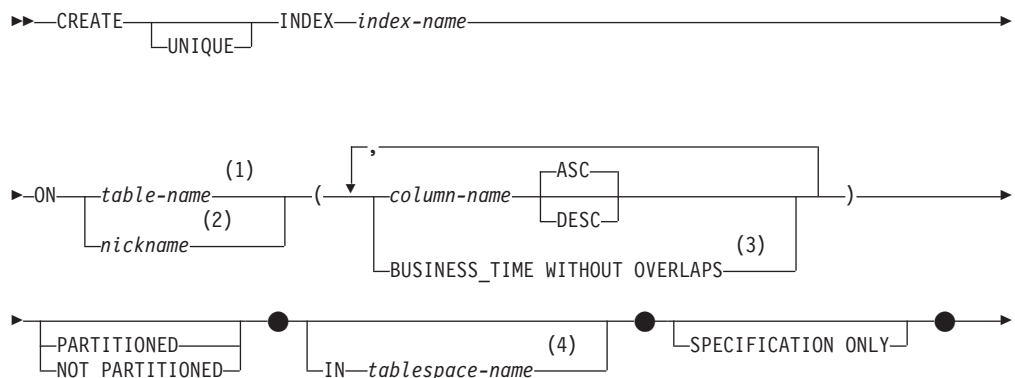

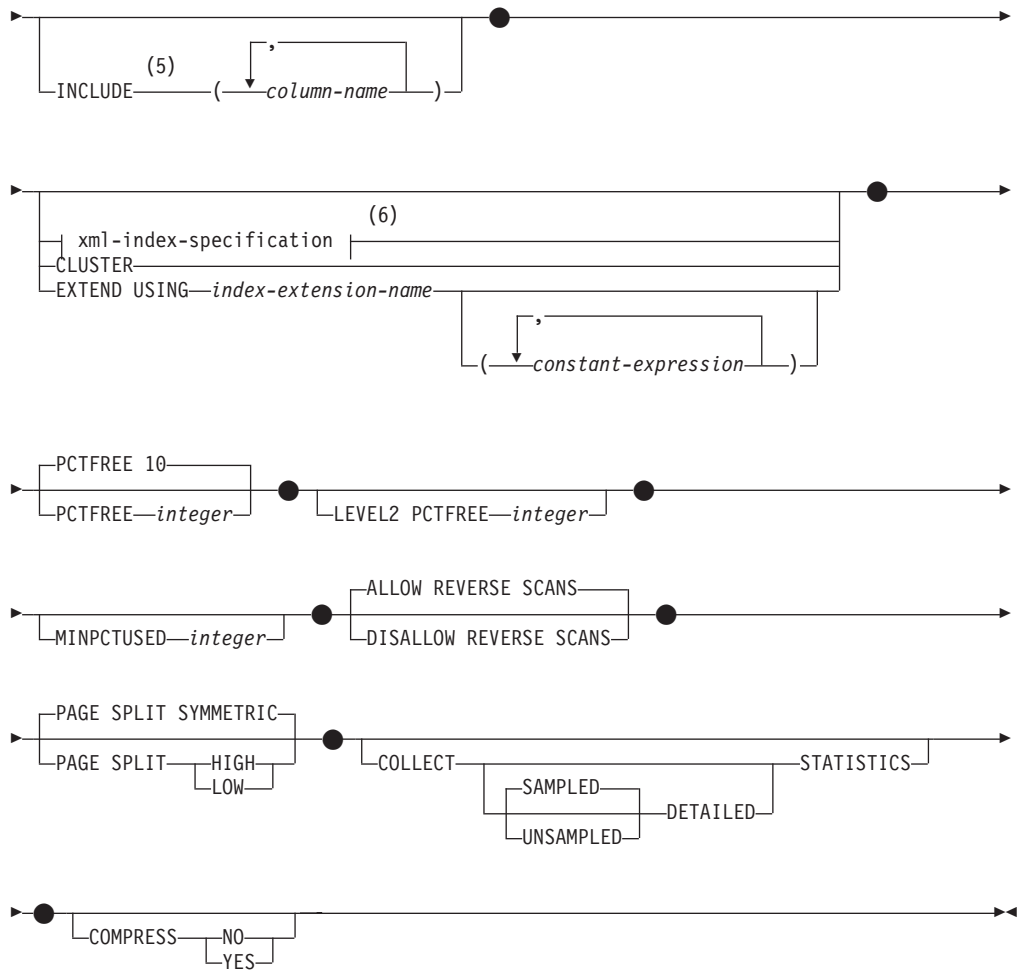

**Notes:**

- 1 In a federated system, *table-name* must identify a table in the federated database. It cannot identify a data source table.
- 2 If *nickname* is specified, the CREATE INDEX statement creates an index specification. In this case, INCLUDE, *xml-index-specification*, CLUSTER, EXTEND USING, PCTFREE, MINPCTUSED, DISALLOW REVERSE SCANS, ALLOW REVERSE SCANS, PAGE SPLIT, or COLLECT STATISTICS cannot be specified.
- 3 The BUSINESS\_TIME WITHOUT OVERLAPS clause can be specified only if UNIQUE is specified.
- 4 The IN *tablespace-name* clause can be specified only for a nonpartitioned index on a partitioned table.
- 5 The INCLUDE clause can be specified only if UNIQUE is specified.
- 6 If *xml-index-specification* is specified, *column-name* DESC, INCLUDE, or CLUSTER cannot be specified.

**xml-index-specification:**

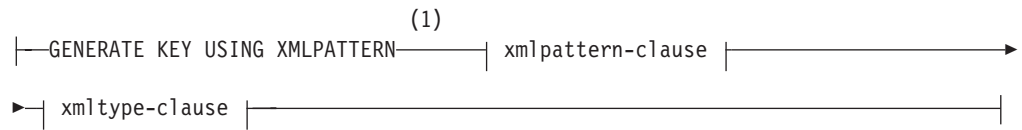

**Notes:**

1 The alternative syntax GENERATE KEYS USING XMLPATTERN can be used.

**xmlpattern-clause:**

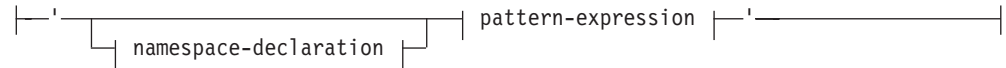

**namespace-declaration:**

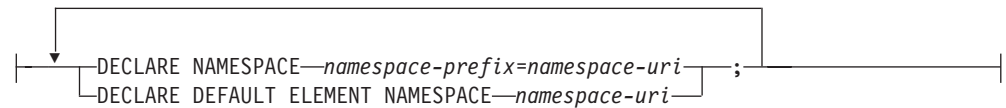

**pattern-expression:**

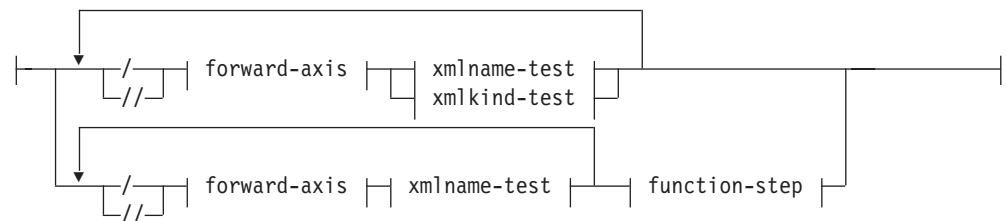

**forward-axis:**



**xmlname-test:**

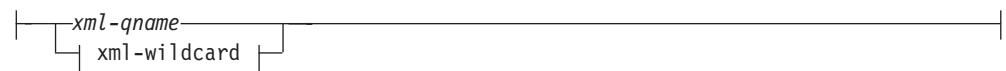

**xml-wildcard:**



### xmlkind-test:



### function-step:

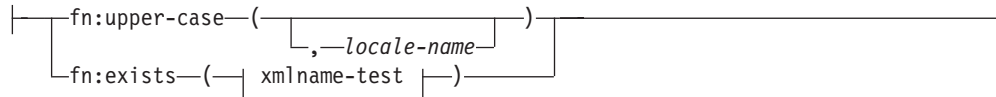

### xmltype-clause:

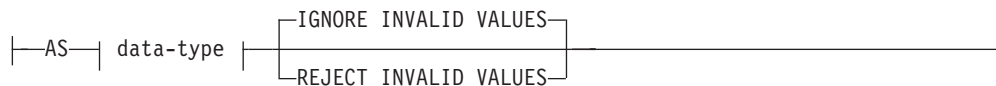

### data-type:



### sql-data-type:

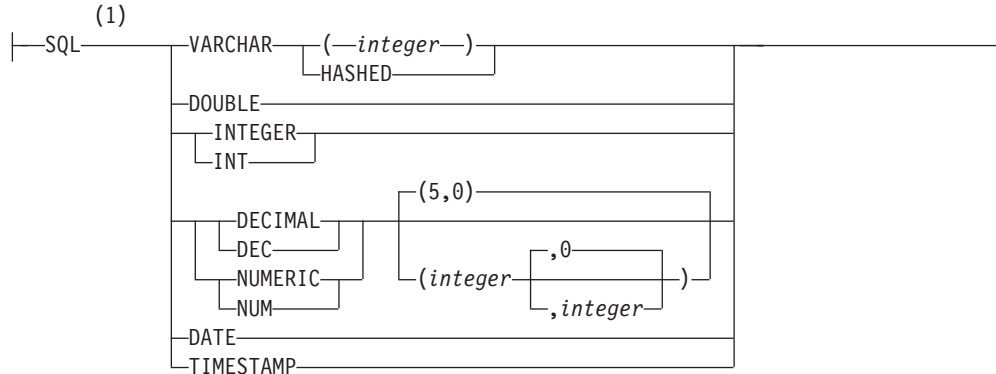

### Notes:

- 1 If you specify a function name, such as `fn:upper-case`, at the end of the XML pattern, the supported index data types might be a subset of the index data types shown here. You can check for valid index data types in the description for `xmlpattern-clause`.

## Description

### UNIQUE

If `ON table-name` is specified, `UNIQUE` prevents the table from containing two or more rows with the same value of the index key. The uniqueness is enforced at the end of the SQL statement that updates rows or inserts new rows.



The uniqueness is also checked during the execution of the CREATE INDEX statement. If the table already contains rows with duplicate key values, the index is not created.

If the index is on an XML column (the index is an index over XML data), the uniqueness applies to values with the specified *pattern-expression* for all rows of the table. Uniqueness is enforced on each value after the value has been converted to the specified *sql-data-type*. Because converting to the specified *sql-data-type* might result in a loss of precision or range, or different values might be hashed to the same key value, multiple values that appear to be unique in the XML document might result in duplicate key errors. The uniqueness of character strings depends on XQuery semantics where trailing blanks are significant. Therefore, values that would be duplicates in SQL but differ in trailing blanks are considered unique values in an index over XML data.

When UNIQUE is used, null values are treated as any other values. For example, if the key is a single column that may contain null values, that column may contain no more than one null value.

If the UNIQUE option is specified, and the table has a distribution key, the columns in the index key must be a superset of the distribution key. That is, the columns specified for a unique index key must include all the columns of the distribution key (SQLSTATE 42997).

If the UNIQUE option is specified and the table has a table partitioning key, the columns of the index key must be a superset of the table partitioning key. That is, the columns specified for the unique index key must include all the columns of the table partitioning key ( SQLSTATE 42990).

Primary or unique keys cannot be subsets of dimensions (SQLSTATE 429BE).

If ON *nickname* is specified, UNIQUE should be specified only if the data for the index key contains unique values for every row of the data source table. The uniqueness will not be checked.

For an index over XML data, UNIQUE can be included only if the context step of the *pattern-expression* specifies a single complete path and does not contain a descendant or descendant-or-self axis, "//", an *xml-wildcard*, *node()*, or *processing-instruction()* (SQLSTATE 429BS).

In a partitioned database environment, the following rules apply to a table with one or more XML columns:

- A distributed table cannot have a unique index over XML data.
- A unique index over XML data is supported only on a table that does not have a distribution key and that is on a single node multi-partition database.
- If a unique index over XML data exists on a table, the table cannot be altered to add a distribution key.

**INDEX** *index-name*

Names the index or index specification. The name, including the implicit or explicit qualifier, must not identify an index or index specification that is described in the catalog, or an existing index on a declared temporary table (SQLSTATE 42704). The qualifier must not be SYSIBM, SYSCAT, SYSFUN, or SYSSTAT (SQLSTATE 42939).

The implicit or explicit qualifier for indexes on declared global temporary tables must be SESSION (SQLSTATE 428EK).

**ON** *table-name* or *nickname*

The *table-name* identifies a table on which an index is to be created. The table

must be a base table (not a view), a created temporary table, a declared temporary table, a materialized query table that exists at the current server, or a declared temporary table. The name of a declared temporary table must be qualified with SESSION. The *table-name* must not identify a catalog table (SQLSTATE 42832). If UNIQUE is specified and *table-name* is a typed table, it must not be a subtable (SQLSTATE 429B3).

*nickname* is the nickname on which an index specification is to be created. The *nickname* references either a data source table whose index is described by the index specification, or a data source view that is based on such a table. The *nickname* must be listed in the catalog.

#### *column-name*

For an index, *column-name* identifies a column that is to be part of the index key. For an index specification, *column-name* is the name by which the federated server references a column of a data source table.

Each *column-name* must be an unqualified name that identifies a column of the table. The number of columns plus twice the number of identified periods cannot exceed 64 (SQLSTATE 54008). If *table-name* is a typed table, the number of columns cannot exceed 63 (SQLSTATE 54008). If *table-name* is a subtable, at least one *column-name* must be introduced in the subtable; that is, not inherited from a supertable (SQLSTATE 428DS). No *column-name* can be repeated (SQLSTATE 42711).

The sum of the stored lengths of the specified columns must not be greater than the index key length limit for the page size. For key length limits, see "SQL limits". If *table-name* is a typed table, the index key length limit is further reduced by 4 bytes. Note that this length limit can be reduced even more by system overhead, which varies according to the data type of the column and whether or not the column is nullable. For more information about overhead affecting this limit, see "Byte Counts" in "CREATE TABLE".

Note that this length can be reduced by system overhead, which varies according to the data type of the column and whether it is nullable. For more information on overhead affecting this limit, see "Byte Counts" in "CREATE TABLE".

No LOB column or distinct type column based on a LOB can be used as part of an index, even if the length attribute of the column is small enough to fit within the index key length limit for the page size (SQLSTATE 54008). A structured type column can only be specified if the EXTEND USING clause is also specified (SQLSTATE 42962). If the EXTEND USING clause is specified, only one column can be specified, and the type of the column must be a structured type or a distinct type that is not based on a LOB (SQLSTATE 42997).

If an index has only one column, and that column has the XML data type, and the GENERATE KEY USING XMLPATTERN clause is also specified, the index is an index over XML data. A column with the XML data type can be specified only if the GENERATE KEY USING XMLPATTERN clause is also specified (SQLSTATE 42962). If the GENERATE KEY USING XMLPATTERN clause is specified, only one column can be specified, and the type of the column must be XML.

#### **ASC**

Specifies that index entries are to be kept in ascending order of the column values; this is the default setting. ASC cannot be specified for indexes that are defined with EXTEND USING (SQLSTATE 42601).

**DESC**

Specifies that index entries are to be kept in descending order of the column values. DESC cannot be specified for indexes that are defined with EXTEND USING, or if the index is an index over XML data (SQLSTATE 42601).

**BUSINESS\_TIME WITHOUT OVERLAPS**

BUSINESS\_TIME WITHOUT OVERLAPS can only be specified for an index defined as UNIQUE (SQLSTATE 428HW) to indicate that for the rest of the specified keys, the values are unique with respect to any period of time. BUSINESS\_TIME WITHOUT OVERLAPS can only be specified as the last item in the list. When BUSINESS\_TIME WITHOUT OVERLAPS is specified, the end column and begin column of the period BUSINESS\_TIME are automatically added to the index key in ascending order and enforce that there are no overlaps in time. When BUSINESS\_TIME WITHOUT OVERLAPS is specified, the columns of the BUSINESS\_TIME period must not be specified as key columns, as columns in the partitioning key, or as columns in the distribution key (SQLSTATE 428HW).

**PARTITIONED**

Indicates that a partitioned index should be created. The *table-name* must identify a table defined with data partitions (SQLSTATE 42601).

If the table is partitioned and neither PARTITIONED nor NOT PARTITIONED is specified, the index is created as partitioned (with a few exceptions). A nonpartitioned index is created instead of partitioned index if any of the following situations apply:

- UNIQUE is specified and the index key does not include all the table partitioning key columns.
- A spatial index is created.
- The index is defined over XML data.

A partitioned index with a definition that duplicates the definition of a nonpartitioned index is not considered to be a duplicate index. For more details, see the “Rules” on page 179 section in this topic.

The PARTITIONED keyword cannot be specified for the following indexes:

- An index on a nonpartitioned table (SQLSTATE 42601)
- An index defined over XML data (SQLSTATE 42613)
- A unique index where the index key does not include all the table partitioning key columns (SQLSTATE 42990)
- A spatial index (SQLSTATE 42997)

A partitioned index cannot be created on a partitioned table that has detached dependent tables, for example, MQTs (SQLSTATE 55019).

The table space placement for an index partition of the partitioned index is determined by the following rules:

- If the table being indexed was created using the *partition-tablespace-options* INDEX IN clause of the CREATE TABLE statement, the index partition is created in the table space specified in that INDEX IN clause.
- If the CREATE TABLE statement for the table being indexed did not specify the *partition-tablespace-options* INDEX IN clause, the index partitioned index is created in the same table space as the corresponding data partition that it indexes.

The IN clause of the CREATE INDEX statement is not supported for partitioned indexes (SQLSTATE 42601). The *tablespace-clauses* INDEX IN clause

of the CREATE TABLE statement is ignored for partitioned indexes. If BUSINESS\_TIME WITHOUT OVERLAPS is specified for the index key, the partitioning key columns must not include the begin or end column of the BUSINESS\_TIME period (SQLSTATE 428HW).

#### **NOT PARTITIONED**

Indicates that a nonpartitioned index should be created that spans all of the data partitions defined for the table. The *table-name* must identify a table defined with data partitions (SQLSTATE 42601).

A nonpartitioned index with a definition that duplicates the definition of a partitioned index is not considered to be a duplicate index. For more details, see the “Rules” on page 179 section in this topic.

The table space placement for a the nonpartitioned index is determined by the following rules:

- If you specify the IN clause of the CREATE INDEX statement, the nonpartitioned index is placed in the table space specified in that IN clause.
- If you do not specify the IN clause of the CREATE INDEX statement, the following rules determine the table space placement of the nonpartitioned index:
  - If the table being indexed was created using the *tablespace-clauses* INDEX IN clause of the CREATE TABLE statement, the nonpartitioned index is placed in the table space specified in that INDEX IN clause.
  - If the table being indexed was created without using the *tablespace-clauses* INDEX IN clause of the CREATE TABLE statement, the nonpartitioned index is created in the table space of the first visible or attached data partition of the table. The first visible or attached data partition of the table is the first partition in the list of data partitions that are sorted on the basis of range specifications. Also, the authorization ID of the statement is not required to have the USE privilege on the default table space.

#### **IN *tablespace-name***

Specifies the table space in which the nonpartitioned index on a partitioned table is created. This clause cannot be specified for a partitioned index or an index on a nonpartitioned table (SQLSTATE 42601). The specification of a table space specifically for the index overrides a specification made using the INDEX IN clause when the table was created.

The table space specified by *tablespace-name* must be in the same database partition group as the data table spaces for the table and manage space in the same way as the other table spaces of the partitioned table (SQLSTATE 42838); it must be a table space on which the authorization ID of the statement holds the USE privilege.

If the IN clause is not specified, the index is created in the table space that was specified by the INDEX IN clause on the CREATE TABLE statement. If no INDEX IN clause was specified, the table space of the first visible or attached data partition of the table is used. This is the first partition in the list of data partitions that are sorted on the basis of range specifications. If the IN clause is not specified, the authorization ID of the statement is not required to have the USE privilege on the default table space.

#### **SPECIFICATION ONLY**

Indicates that this statement will be used to create an index specification that applies to the data source table referenced by *nickname*. SPECIFICATION

ONLY must be specified if *nickname* is specified (SQLSTATE 42601). It cannot be specified if *table-name* is specified (SQLSTATE 42601).

If the index specification applies to an index that is unique, DB2 does not verify that the column values in the remote table are unique. If the remote column values are not unique, queries against the nickname that include the index column might return incorrect data or errors.

This clause cannot be used when creating an index on a created temporary table or declared temporary table (SQLSTATE 42995).

## **INCLUDE**

This keyword introduces a clause that specifies additional columns to be appended to the set of index key columns. Any columns included with this clause are not used to enforce uniqueness. These included columns might improve the performance of some queries through index only access. The columns must be distinct from the columns used to enforce uniqueness (SQLSTATE 42711). UNIQUE must be specified when INCLUDE is specified (SQLSTATE 42613). The limits for the number of columns and sum of the length attributes apply to all of the columns in the unique key and in the index.

This clause cannot be used with created temporary tables or declared temporary tables (SQLSTATE 42995).

### *column-name*

Identifies a column that is included in the index but not part of the unique index key. The same rules apply as defined for columns of the unique index key. The keywords ASC or DESC may be specified after *column-name* but have no effect on the order.

INCLUDE cannot be specified for indexes that are defined with EXTEND USING, if *nickname* is specified, or if the index is defined on an XML column (SQLSTATE 42601).

### *xml-index-specification*

Specifies how index keys are generated from XML documents that are stored in an XML column. *xml-index-specification* cannot be specified if there is more than one index column, or if the column does not have the XML data type.

This clause only applies to XML columns (SQLSTATE 429BS).

## **GENERATE KEY USING XMLPATTERN** *xmlpattern-clause*

Specifies the parts of an XML document that are to be indexed. XML pattern values are the indexed values generated by the *xmlpattern-clause*. List data type nodes are not supported in the index. If a node is qualified by the *xmlpattern-clause* and an XML schema exists that specifies that the node is a list data type, then the list data type node cannot be indexed (SQLSTATE 23526 for CREATE INDEX statements, or SQLSTATE 23525 for INSERT and UPDATE statements).

### *xmlpattern-clause*

Contains a pattern expression that identifies the nodes that are to be indexed. It consists of an optional *namespace-declaration* and a required *pattern-expression*.

### *namespace-declaration*

If the pattern expression contains qualified names, a *namespace-declaration* must be specified to define namespace prefixes. A default namespace can be defined for unqualified names.

**DECLARE NAMESPACE** *namespace-prefix=namespace-uri*

Maps *namespace-prefix*, which is an NCName, to *namespace-uri*, which is a string literal. The *namespace-declaration* can contain multiple *namespace-prefix-to-namespace-uri* mappings. The *namespace-prefix* must be unique within the list of *namespace-declaration* (SQLSTATE 10503).

**DECLARE DEFAULT ELEMENT NAMESPACE** *namespace-uri*

Declares the default namespace URI for unqualified element names or types. If no default namespace is declared, unqualified names of elements and types are in no namespace. Only one default namespace can be declared (SQLSTATE 10502).

*pattern-expression*

Specifies the nodes in an XML document that are indexed. The *pattern-expression* can contain pattern-matching characters (\*). It is similar to a path expression in XQuery, but supports a subset of the XQuery language that is supported by DB2.

*/ (forward slash)*

Separates path expression steps.

*// (double forward slash)*

This is the abbreviated syntax for */descendant-or-self::node()/*. You cannot use *// (double forward slash)* if you also specify UNIQUE.

*forward-axis*

**child::**

Specifies children of the context node. This is the default, if no other forward axis is specified.

@ Specifies attributes of the context node. This is the abbreviated syntax for *attribute::*.

**attribute::**

Specifies attributes of the context node.

**descendant::**

Specifies the descendants of the context node. You cannot use *descendant::* if you also specify UNIQUE.

**self::**

Specifies just the context node itself.

**descendant-or-self::**

Specifies the context node and the descendants of the context node. You cannot use *descendant-or-self::* if you also specify UNIQUE.

*xmlname-test*

Specifies the node name for the step in the path using a qualified XML name (*xml-qname*) or a wildcard (*xml-wildcard*).

*xml-ncname*

An XML name as defined by XML 1.0. It cannot include a colon character.

#### *xml-qname*

Specifies a qualified XML name (also known as a QName) that can have two possible forms:

- *xml-namespace:xml-ncname*, where the *xml-namespace* is an *xml-ncname* that identifies an in-scope namespace
- *xml-ncname*, which indicates that the default namespace should be applied as the implicit *xml-namespace*

#### *xml-wildcard*

Specifies an *xml-qname* as a wildcard that can have three possible forms:

- *\** (a single asterisk character) indicates any *xml-qname*
- *xml-namespace:\** indicates any *xml-ncname* within the specified namespace
- *\*:xml-ncname* indicates a specific XML name in any in-scope namespace

You cannot use *xml-wildcard* in the context step of a pattern expression if you also specify UNIQUE.

#### *xmlkind-test*

Use these options to specify what types of nodes you pattern match. The following options are available to you:

##### **node()**

Matches any node. You cannot use *node()* if you also specify UNIQUE.

##### **text()**

Matches any text node.

##### **comment()**

Matches any comment node.

##### **processing-instruction()**

Matches any processing instruction node. You cannot use *processing-instruction()* if you also specify UNIQUE.

#### **function-step**

Use these function calls to specify indexes with special properties, such as case insensitivity. Only one function step is allowed per XMLPATTERN clause. Function steps can be applied only on elements or attributes. No *xmlkind-test* option can be placed immediately before the function step. The function cannot be used in the middle of the XMLPATTERN, and must appear only in the final step. Currently, only the *fn:upper-case* and *fn:exists* functions are supported.

Note that instead of specifying the prefix *fn:* for the function name, you can specify another valid namespace, or you can omit *fn:* entirely.

##### **fn:upper-case**

Force the index values to be stored in the uppercase form. The first parameter of *fn:upper-case* is mandatory, and must be a context item expression (' . '); the second parameter is optional, and is the locale. If *fn:upper-case* appears in the pattern, VARCHAR and VARCHAR HASHED are the only index types supported.

### fn:exists

Check for the existence of an element or attribute item in the XML document. If the item exists, this predicate returns true. The parameter of fn:exists is mandatory, and must be an element or attribute. If this function is used in the index path, the index type must be defined as VARCHAR(1).

### *xmltype-clause*

#### AS data-type

Specifies the data type to which indexed values are converted before they are stored. Values are converted to the index XML data type that corresponds to the specified index SQL data type.

Table 22. Corresponding index data types

Index XML data type	Index SQL data type
xs:string	VARCHAR( <i>integer</i> ), VARCHAR HASHED
xs:double	DOUBLE
xs:int	INTEGER
xs:decimal	DECIMAL
xs:date	DATE
xs:dateTime	TIMESTAMP

For VARCHAR(*integer*) and VARCHAR HASHED, the value is converted to an xs:string value using the XQuery function fn:string. The length attribute of VARCHAR(*integer*) is applied as a constraint to the resulting xs:string value. An index SQL data type of VARCHAR HASHED applies a hash algorithm to the resulting xs:string value to generate a hash code that is inserted into the index.

For indexes using the data types DOUBLE, DATE, INTEGER, DECIMAL, and TIMESTAMP, the value is converted to the index XML data type using the XQuery cast expression.

If the index is unique, the uniqueness of the value is enforced after the value is converted to the indexed type.

### *data-type*

The following data type is supported:

#### *sql-data-type*

Supported SQL data types are:

#### **VARCHAR(*integer*)**

If this form of VARCHAR is specified, DB2 uses *integer* as a constraint. If document nodes that are to be indexed have values that are longer than *integer*, the documents are not inserted into the table if the index already exists. If the index does not exist, the index is not created. *integer* is a value between 1 and a page size-dependent maximum. Table 23 shows the maximum value for each page size.

Table 23. Maximum length of document nodes by page size

Page size	Maximum length of document node (bytes)
4KB	817



Table 23. Maximum length of document nodes by page size (continued)

Page size	Maximum length of document node (bytes)
8KB	1841
16KB	3889
32KB	7985

XQuery semantics are used for string comparisons, where trailing blanks are significant. This differs from SQL semantics, where trailing blanks are insignificant during comparisons.

#### **VARCHAR HASHED**

Specify VARCHAR HASHED to handle indexing of arbitrary length character strings. The length of an indexed string has no limit. DB2 generates an eight-byte hash code over the entire string. Indexes that use these hashed character strings can be used only for equality lookups. XQuery semantics are used for string equality comparisons, where trailing blanks are significant. This differs from SQL semantics, where trailing blanks are insignificant during comparisons. The hash on the string preserves XQuery semantics for equality and not SQL semantics.

#### **DOUBLE**

Specifies that the data type DOUBLE is used for indexing numeric values. Unbounded decimal types and 64 bit integers may lose precision when they are stored as a DOUBLE value. The values for DOUBLE may include the special numeric values *NaN*, *INF*, *-INF*, *+0*, and *-0*, even though the SQL data type DOUBLE itself does not support these values.

#### **INTEGER**

Specifies that the data type INTEGER is used for indexing XML values. Note that the XML schema data type *xs:integer* allows a greater range of values than does the integer SQL data type. If an out-of-range value is encountered, an error is returned. If a value conforms to the lexical format of *xs:double* but does not conform to the lexical format of *xs:int*, such as 3.5, 3.0, or 3E1, an error is also returned.

#### **DECIMAL(*integer*, *integer*)**

Specifies that the data type DECIMAL is used for indexing XML values. The DECIMAL type takes two parameters, *precision* and *scale*. The first parameter, *precision*, is an integer constant with a value in the range of 1 to 31 that specifies the total number of digits. The second parameter, *scale*, is an integer constant that is greater than or equal to zero, and less than or equal to *precision*. The *scale* specifies the number of digits to the right of the decimal point.

Digits are not truncated from the end of a decimal number. An error is returned if the number of digits to the right of the decimal separator character is greater

than the scale. Also, an error is returned if the number of significant digits to the left of the decimal character (the whole part of the number) is greater than precision.

#### **DATE**

Specifies that the data type DATE is used for indexing XML values. Note that the XML schema data type for xs:date allows greater range of values than the DB2 pureXML xs:date data type that corresponds to the SQL data type. If an out-of-range value is encountered, an error is returned.

#### **TIMESTAMP**

Specifies that the data type TIMESTAMP is used for indexing XML values. Note that the XML schema data type for xs:dateTime allows greater range of values and fractional seconds precision than the DB2 pureXML xs:dateTime data type that corresponds to the SQL data type. If an out-of range value is encountered, an error is returned.

#### **IGNORE INVALID VALUES**

Specifies that XML pattern values that are invalid lexical forms for the target index XML data type are ignored and that the corresponding values in the stored XML documents are not indexed by the CREATE INDEX statement. By default, invalid values are ignored. During insert and update operations, the invalid XML pattern values are not indexed, but XML documents are still inserted into the table. No error or warning is raised, because specifying these data types is not a constraint on the XML pattern values (XQuery expressions that search for the specific XML index data type will not consider these values).

The rules for what XML pattern values can be ignored are determined by the specified SQL data type.

- If the SQL data type is VARCHAR(*integer*) or VARCHAR HASHED, XML pattern values are never ignored since any sequence of characters is valid.
- If the SQL data type is DOUBLE, DECIMAL, or INTEGER, any XML pattern value that does not conform to the lexical format of the XML data type xs:double is ignored. If the SQL data type is DECIMAL or INTEGER and the XML pattern value conforms to the lexical format of the XML data type xs:double but not to the lexical format of xs:decimal or xs:int, respectively, an error is returned. For example, if the SQL data type is INTEGER, the XML pattern values of 3.5, 3.0, and 3e0 conform to the lexical format of xs:double but return an error (SQLSTATE 23525) because they do not conform to the lexical format of xs:int. XML pattern values such as 'A123' or 'hello' are ignored for the same index.
- If the SQL data type is a datetime data type, any XML pattern value that does not conform to the lexical format of the corresponding XML data type (xs:date or xs:dateTime) is ignored.

If an XML pattern value does conform to the appropriate lexical format, an error is returned if the value is outside the value space

for the data type or exceeds the maximum length or precision and scale of the specified SQL data type. If the index does not exist, the index is not created (SQLSTATE 23526).

#### **REJECT INVALID VALUES**

All XML pattern values must be valid in the context of the lexical definition of the index XML data type. In addition the value must be in the range of the value space of the index XML data type. See the Related reference section, later, for links to details on the lexical definition and value space for each data type. For example, when you specify the REJECT INVALID VALUES clause, if you create an index of INTEGER type, XML pattern values such as 3.5, 3.0, 3e0, 'A123' and 'hello' will return an error (SQLSTATE 23525). XML data is not inserted or updated in the table if the index already exists (SQLSTATE 23525). If the index does not exist, the index is not created (SQLSTATE 23526).

#### **CLUSTER**

Specifies that the index is the clustering index of the table. The cluster factor of a clustering index is maintained or improved dynamically as data is inserted into the associated table, by attempting to insert new rows physically close to the rows for which the key values of this index are in the same range. Only one clustering index may exist for a table so CLUSTER may not be specified if it was used in the definition of any existing index on the table (SQLSTATE 55012). A clustering index may not be created on a table that is defined to use append mode (SQLSTATE 428D8).

CLUSTER is disallowed if *nickname* is specified, or if the index is an index over XML data (SQLSTATE 42601). This clause cannot be used with created temporary tables or declared temporary tables (SQLSTATE 42995) or range-clustered tables (SQLSTATE 429BG).

#### **EXTEND USING *index-extension-name***

Names the *index-extension* used to manage this index. If this clause is specified, then there must be only one *column-name* specified and that column must be a structured type or a distinct type (SQLSTATE 42997). The *index-extension-name* must name an index extension described in the catalog (SQLSTATE 42704). For a distinct type, the column must exactly match the type of the corresponding source key parameter in the index extension. For a structured type column, the type of the corresponding source key parameter must be the same type or a supertype of the column type (SQLSTATE 428E0).

This clause cannot be used with created temporary tables or declared temporary tables (SQLSTATE 42995).

This clause cannot be used in a DB2 pureScale® environment (SQLSTATE 56038).

#### ***constant-expression***

Identifies values for any required arguments for the index extension. Each expression must be a constant value with a data type that exactly matches the defined data type of the corresponding index extension parameters, including length or precision, and scale (SQLSTATE 428E0). This clause must not exceed 32 768 bytes in length in the database code page (SQLSTATE 22001).

#### **PCTFREE *integer***

Specifies what percentage of each index page to leave as free space when building the index. The first entry in a page is added without restriction. When additional entries are placed in an index page at least *integer* percent of free

space is left on each page. The value of *integer* can range from 0 to 99. If a value greater than 10 is specified, only 10 percent free space will be left in non-leaf pages.

If an explicit value for PCTFREE is not provided, and if **DB2\_INDEX\_PCTFREE\_DEFAULT** is not set, then PCTFREE will have a default value of 10.

PCTFREE is disallowed if *nickname* is specified (SQLSTATE 42601). This clause cannot be used with created temporary tables or declared temporary tables (SQLSTATE 42995).

#### **LEVEL2 PCTFREE** *integer*

Specifies what percentage of each index level 2 page to leave as free space when building the index. The value of *integer* can range from 0 to 99. If LEVEL2 PCTFREE is not set, a minimum of 10 or PCTFREE percent of free space is left on all non-leaf pages. If LEVEL2 PCTFREE is set, *integer* percent of free space is left on level 2 intermediate pages, and a minimum of 10 or *integer* percent of free space is left on level 3 and higher intermediate pages.

LEVEL2 PCTFREE is disallowed if *nickname* is specified (SQLSTATE 42601). This clause cannot be used with created temporary tables or declared temporary tables (SQLSTATE 42995).

#### **MINPCTUSED** *integer*

Indicates whether index leaf pages are merged online, and the threshold for the minimum percentage of space used on an index leaf page. If, after a key is removed from an index leaf page, the percentage of space used on the page is at or below *integer* percent, an attempt is made to merge the remaining keys on this page with those of a neighboring page. If there is sufficient space on one of these pages, the merge is performed and one of the pages is deleted. The value of *integer* can be from 0 to 99. A value of 50 or below is recommended for performance reasons. Specifying this option will have an impact on update and delete performance. Merging is only done during update and delete operations when an exclusive table lock is held. If an exclusive table lock does not exist, keys are marked as pseudo deleted during update and delete operations, and no merging is done. Consider using the CLEANUP ONLY ALL option of REORG INDEXES to merge leaf pages instead of using the MINPCTUSED option of CREATE INDEX.

MINPCTUSED is disallowed if *nickname* is specified (SQLSTATE 42601). This clause cannot be used with created temporary tables or declared temporary tables (SQLSTATE 42995).

#### **DISALLOW REVERSE SCANS**

Specifies that an index only supports forward scans or scanning of the index in the order that was defined at index creation time.

DISALLOW REVERSE SCANS cannot be specified together with *nickname* (SQLSTATE 42601).

#### **ALLOW REVERSE SCANS**

Specifies that an index can support both forward and reverse scans; that is, scanning of the index in the order that was defined at index creation time, and scanning in the opposite order.

ALLOW REVERSE SCANS cannot be specified together with *nickname* (SQLSTATE 42601).

#### **PAGE SPLIT**

Specifies an index split behavior. The default is SYMMETRIC.

**SYMMETRIC**

Specifies that pages are to be split roughly in the middle.

**HIGH**

Specifies an index page split behavior that uses the space on index pages efficiently when the values of the index keys being inserted follow a particular pattern. For a subset of index key values, the leftmost column or columns of the index must contain the same value, and the rightmost column or columns of the index must contain values that increase with each insertion.

**LOW**

Specifies an index page split behavior that uses the space on index pages efficiently when the values of the index keys being inserted follow a particular pattern. For a subset of index key values, the leftmost column or columns of the index must contain the same value, and the rightmost column or columns of the index must contain values that decrease with each insertion.

**COLLECT STATISTICS**

Specifies that basic index statistics are to be collected during index creation.

**SAMPLED**

Specifies that a sampling technique is to be used when processing index entries to collect extended index statistics. This option is used to balance performance considerations with the need for accuracy of the statistics. This option is the default when DETAILED is specified immediately following the keyword COLLECT.

**UNSAMPLED**

Specifies that sampling is not to be used when processing index entries to collect extended index statistics. Instead, each index entry is examined individually. This option can significantly increase CPU and memory consumption.

**DETAILED**

Specifies that extended index statistics (CLUSTERFACTOR and PAGE\_FETCH\_PAIRS) are also to be collected during index creation.

**COMPRESS**

Specifies whether index compression is enabled. By default, index compression will be enabled if data row compression is enabled; index compression will be disabled if data row compression is disabled. This option can be used to override the default behavior. COMPRESS is disallowed if *nickname* is specified (SQLSTATE 42601).

**YES**

Specifies that index compression is enabled. Insert and update operations on the index will be subject to compression.

**NO** Specifies that index compression is disabled.

**Rules**

- The CREATE INDEX statement fails (SQLSTATE 01550) when attempting to create an index that matches an existing index.

A number of factors are used to determine if two indexes match. These factors are combined in various different ways into the rules that determine if two indexes match. The following factors are used to determine if two indexes match:

1. The sets of index columns, including any INCLUDE columns, are the same in both indexes.
2. The ordering of index key columns, including any INCLUDE columns, is the same in both indexes.
3. The key columns of the new index are the same or a superset of the key columns in the existing index.
4. The ordering attributes of the columns are the same in both indexes.
5. The existing index is unique.
6. Both indexes are non-unique.

The following combinations of these factors form the rules that determine when two indexes are considered duplicates:

- 1 + 2 + 4 + 5
- 1 + 2 + 4 + 6
- 1 + 2 + 3 + 5

**Exceptions:**

- If one of the compared indexes is partitioned and the other of the compared indexes is nonpartitioned, the indexes are not considered duplicates if the indexes have different names, even if other matching index conditions are met.
- For indexes over XML data, the index descriptions are not considered duplicates if the index names are different, even if the indexed XML column, the XML patterns, and the data type, including its options, are identical.
- Unique indexes on system-maintained MQTs are not supported (SQLSTATE 42809).
- The COLLECT STATISTICS options are not supported if a nickname is specified (SQLSTATE 42601).

**Notes**

- Concurrent read/write access during index creation, and default index creation behavior differs for indexes on nonpartitioned tables, nonpartitioned indexes, partitioned indexes, and indexes in a DB2 pureScale environment:
  - For nonpartitioned indexes, concurrent read/write access to the table is permitted while an index is being created, except when the EXTEND USING clause is specified. Once the index has been built, changes that were made to the table during index creation time are forward-fitted to the new index. Write access to the table is then briefly blocked while index creation completes, after which the new index becomes available.
  - For partitioned indexes, concurrent read/write access to the table is permitted while an index is being created, except when the EXTEND USING clause is specified. Once the index partition has been built, changes that were made to the partition during creation time of that index partition are forward-fitted to the new index partition. Write access to the data partition is then blocked while index creation completes on the remaining data partitions. After the index partition for the last data partition is built and the transaction is committed, all data partitions are available for read and write.
  - In a DB2 pureScale environment, concurrent read access is the default behavior. Concurrent write access is not allowed during index creation.

To circumvent this default behavior, use the LOCK TABLE statement to explicitly lock the table before issuing a CREATE INDEX statement. (The table can be locked in either SHARE or EXCLUSIVE mode, depending on whether read access is to be allowed.)

- If the named table already contains data, CREATE INDEX creates the index entries for it. If the table does not yet contain data, CREATE INDEX creates a description of the index; the index entries are created when data is inserted into the table.
- b
- Once the index is created and data is loaded into the table, it is advisable to issue the RUNSTATS command. The RUNSTATS command updates statistics collected on the database tables, columns, and indexes. These statistics are used to determine the optimal access path to the tables. By issuing the RUNSTATS command, the database manager can determine the characteristics of the new index. If data has been loaded before the CREATE INDEX statement is issued, it is recommended that the COLLECT STATISTICS option on the CREATE INDEX statement be used as an alternative to the RUNSTATS command.
- Creating an index with a schema name that does not already exist will result in the implicit creation of that schema provided the authorization ID of the statement has IMPLICIT\_SCHEMA authority. The schema owner is SYSIBM. The CREATEIN privilege on the schema is granted to PUBLIC.
- The optimizer can recommend indexes before creating the actual index.
- If an index specification is being defined for a data source table that has an index, the name of the index specification does not have to match the name of the index.
- The optimizer uses index specifications to improve access to the data source tables that the specifications apply to.
- *Collecting index statistics:* The UNSAMPLED DETAILED option is available to change the way index statistics are collected. However, it should be used only in cases where it is clear that DETAILED does not yield accurate statistics.
- *Syntax alternatives:* The following syntax is tolerated and ignored:
  - CLOSE
  - DEFINE
  - FREEPAGE
  - GBPCACHE
  - PIECESIZE
  - TYPE 2
  - using-blockThe following syntax is accepted as the default behavior:
  - COPY NO
  - DEFER NO

## Examples

- *Example 1:* Create an index named UNIQUE\_NAM on the PROJECT table. The purpose of the index is to ensure that there are not two entries in the table with the same value for project name (PROJNAME). The index entries are to be in ascending order.

```
CREATE UNIQUE INDEX UNIQUE_NAM
ON PROJECT (PROJNAME)
```

- *Example 2:* Create an index named JOB\_BY\_DPT on the EMPLOYEE table. Arrange the index entries in ascending order by job title (JOB) within each department (WORKDEPT).

```
CREATE INDEX JOB_BY_DPT
ON EMPLOYEE (WORKDEPT, JOB)
```

- *Example 3:* The nickname EMPLOYEE references a data source table called CURRENT\_EMP. After this nickname was created, an index was defined on CURRENT\_EMP. The columns chosen for the index key were WORKDEPT and JOB. Create an index specification that describes this index. Through this specification, the optimizer will know that the index exists and what its key is. With this information, the optimizer can improve its strategy to access the table.

```
CREATE UNIQUE INDEX JOB_BY_DEPT
ON EMPLOYEE (WORKDEPT, JOB)
SPECIFICATION ONLY
```

- *Example 4:* Create an extended index type named SPATIAL\_INDEX on a structured type column location. The description in index extension GRID\_EXTENSION is used to maintain SPATIAL\_INDEX. The literal is given to GRID\_EXTENSION to create the index grid size.

```
CREATE INDEX SPATIAL_INDEX ON CUSTOMER (LOCATION)
EXTEND USING (GRID_EXTENSION (x'000100100010001000400010'))
```

- *Example 5:* Create an index named IDX1 on a table named TAB1, and collect basic index statistics on index IDX1.

```
CREATE INDEX IDX1 ON TAB1 (col1) COLLECT STATISTICS
```

- *Example 6:* Create an index named IDX2 on a table named TAB1, and collect detailed index statistics on index IDX2.

```
CREATE INDEX IDX2 ON TAB1 (col2) COLLECT DETAILED STATISTICS
```

- *Example 7:* Create an index named IDX3 on a table named TAB1, and collect detailed index statistics on index IDX3 using sampling.

```
CREATE INDEX IDX3 ON TAB1 (col3) COLLECT SAMPLED DETAILED STATISTICS
```

- *Example 8:* Create a unique index named A\_IDX on a partitioned table named MYNUMBERDATA in table space IDX\_TBSP.

```
CREATE UNIQUE INDEX A_IDX ON MYNUMBERDATA (A) IN IDX_TBSP
```

- *Example 9:* Create a non-unique index named B\_IDX on a partitioned table named MYNUMBERDATA in table space IDX\_TBSP.

```
CREATE INDEX B_IDX ON MYNUMBERDATA (B)
NOT PARTITIONED IN IDX_TBSP
```

- *Example 10:* Create an index over XML data on a table named COMPANYINFO, which contains an XML column named COMPANYDOCS. The XML column COMPANYDOCS contains a large number of XML documents similar to the one below:

```
<company name="Company1">
  <emp id="31201" salary="60000" gender="Female">
    <name>
      <first>Laura</first>
      <last>Brown</last>
    </name>
    <dept id="M25">
      Finance
    </dept>
  </emp>
</company>
```

Users of the COMPANYINFO table often need to retrieve employee information using the employee ID. An index like the following one can make that retrieval more efficient.



```
CREATE INDEX EMPINDEX ON COMPANYINFO(COMPANYDOCS)
GENERATE KEY USING XMLPATTERN '/company/emp/@id'
AS SQL DOUBLE
```

- *Example 11:* The following index is logically equivalent to the index created in the previous example, except that it uses unabbreviated syntax.

```
CREATE INDEX EMPINDEX ON COMPANYINFO(COMPANYDOCS)
GENERATE KEY USING XMLPATTERN '/child::company/child::emp/attribute::id'
AS SQL DOUBLE
```

- *Example 12:* Create an index on a column named DOC, indexing only the book title as a VARCHAR(100). Because the book title should be unique across all books, the index must be unique.

```
CREATE UNIQUE INDEX MYDOCSIDX ON MYDOCS(DOC)
GENERATE KEY USING XMLPATTERN '/book/title'
AS SQL VARCHAR(100)
```

- *Example 13:* Create an index on a column named DOC, indexing the chapter number as a DOUBLE. This example includes namespace declarations.

```
CREATE INDEX MYDOCSIDX ON MYDOCS(DOC)
GENERATE KEY USING XMLPATTERN
'declare namespace b="http://www.example.com/book/";
declare namespace c="http://acme.org/chapters";
/b:book/c:chapter/@number'
AS SQL DOUBLE
```

- *Example 14:* Create a unique index named IDXPROJEST on table PROJECT and include column PRSTAFF to allow index-only access of the estimated mean staffing information.

```
CREATE UNIQUE INDEX IDXPROJEST ON PROJECT (PROJNO) INCLUDE (PRSTAFF)
```

---

## Sample queries against indexes over XML data

Indexes over XML data need to be matched with the queries that aim to make use of them. The following examples show queries that can, or cannot, make use of indexes over XML data.

### Sample queries that can use an index over XML data

Queries with a wide variety of different predicates can exploit an index over XML data. Some examples of XQuery predicates matched with indexes they can use are shown in this section. Queries are followed by matching indexes.

Example 1. Issue a query for equality: Find the employee with ID 42366:

```
XQUERY for $i in db2-fn:xmlcolumn('COMPANY.COMPANYDOCS')/company/emp[@id='42366']
return $i
```

```
CREATE INDEX empindex on company(companydocs)
GENERATE KEY USING XMLPATTERN '/company/emp/@id' AS SQL VARCHAR(5)
```

Example 2. Query for a range: Find employees with a salary greater than 35000:

```
XQUERY
for $i in db2-fn:xmlcolumn('COMPANY.COMPANYDOCS')/company/emp[@salary > 35000]
return $i
```

```
CREATE INDEX empindex on company(companydocs)
GENERATE KEY USING XMLPATTERN '//@salary' AS SQL DECIMAL(10,2)
```

Example 3. Issue a query which includes a disjunction (OR): Find employees that are in the Finance department or in the Marketing department:

```

XQUERY
  for $i in
    db2-fn:xmlcolumn('COMPANY.COMPANYDOCS')/company/emp[dept/text()='Finance'
    or dept/text()='Marketing']
  return $i
CREATE INDEX empindex on company(companydocs)
  GENERATE KEY USING XMLPATTERN '/company/emp/dept/text()' AS SQL
  VARCHAR(30)

```

Example 4. Different queries can be satisfied by the same index:

Find the employee with the ID 31201:

```

XQUERY for $i in db2-fn:xmlcolumn('COMPANY.COMPANYDOCS')/company/emp[@id='31201']
  return $i

```

Find departments with the ID K55

```

XQUERY for $i in db2-fn:xmlcolumn('COMPANY.COMPANYDOCS')/company/emp/dept[@id='K55']
  return $i

```

```

CREATE INDEX empindex on company(companydocs)
  GENERATE KEY USING XMLPATTERN '//@id' AS SQL VARCHAR(25)

```

Example 5. Query predicates can contain paths: Find employees with last name *Murphy* who are in the Sales department:

```

XQUERY
  for $i in db2-fn:xmlcolumn('COMPANY.COMPANYDOCS')/company/emp[name/last='Murphy'
  and dept/text()='Sales']
  return $i

```

```

CREATE INDEX empindex on company(companydocs)
  GENERATE KEY USING XMLPATTERN '/company/emp/name/last' AS SQL
  VARCHAR(100)

```

```

CREATE INDEX deptindex on company(companydocs)
  GENERATE KEY USING XMLPATTERN '/company/emp/dept/text()' AS SQL
  VARCHAR(30)

```

Example 6. Exercise hierarchical containment during queries: A query can use indexes to perform ANDing at different levels in the document hierarchy. A query can also use the indexes to determine what children nodes belong to the same ancestor to do appropriate filtering.

Find companies with employees that have a salary equal to 60000 and find companies with female employees. In the sample XML fragments of the XML data indexing overview topic, both Company1 and Company2 would qualify.

```

XQUERY for $i in
  db2-fn:xmlcolumn('COMPANY.COMPANYDOCS')/company[emp/@salary=60000 and
  emp/@gender='Female']
  return $i

```

Find employees who have a salary equal to 60000 and who are female. Only Laura Brown from Company1 would qualify.

```

XQUERY for $i in
  db2-fn:xmlcolumn('COMPANY.COMPANYDOCS')/company/emp[@salary=60000
  and @gender='Female']
  return $i

```

```

CREATE INDEX empindex on company(companydocs)
  GENERATE KEY USING XMLPATTERN '/company/emp/@salary' AS DECIMAL(10,2)

```

```

CREATE INDEX genderindex on company(companydocs)
  GENERATE KEY USING XMLPATTERN '/company/emp/@gender' AS SQL
  VARCHAR(10)

```

Example 7. A query can use the descendant-or-self axis (//) and make use of indexes, provided that the query predicate is at least as restrictive as, or more restrictive than, the index pattern.

Find employees with department ID K55:

```
XQUERY
  for $i in
    db2-fn:xmlcolumn('COMPANY.COMPANYDOCS')/company//emp[.//dept//@id='K55' ]
  return $i
CREATE INDEX empindex on company(companydocs)
  GENERATE KEY USING XMLPATTERN '//emp//@id' AS SQL VARCHAR(25)
```

Example 8. For multidimensional clustering (MDC) tables, a query can use MDC block indexes and indexes over XML data. Assume an MDC table with an XML column is created and uses the WORKDEPT as a dimension.

```
CREATE TABLE employee (empno char(6), workdept char(3), doc xml)
  ORGANIZE BY (workdept)
```

Assume that there is an index over XML data on the column DOC as defined with the following CREATE INDEX statement:

```
CREATE INDEX hdate on employee(doc)
  GENERATE KEY USING XMLPATTERN '//hiredate'AS SQL DATE COLLECT STATISTICS
```

The following query can use the block index on WORKDEPT and the index over XML data (hdate) on DOC in its access plan:

```
SELECT COUNT (*) FROM y.employee y
  WHERE workdept='A00'
  AND XMLEXISTS('$p/employee[hiredate > "1964-01-01"]'
  PASSING y.doc as "p")
```

## Sample queries that cannot use an index over XML data

There are some conditions when a query cannot use an index over XML data. Some examples of XQuery predicates that cannot make use of their intended indexes as shown are listed in this section.

Example 1. The data type requested by the query must match the indexed data type, before the query can use the index. In this example, the query requests the employee ID as a string, but the ID is indexed as a number:

```
XQUERY for $i in db2-fn:xmlcolumn('COMPANY.COMPANYDOCS')/company/emp[@id='31664']
  return $i
CREATE INDEX empindex on company(companydocs)
  GENERATE KEY USING XMLPATTERN '/company/emp/@id' AS SQL DOUBLE
```

Example 2. The XML pattern expression used to create the index may be more restrictive than the query predicate. In this example, the query cannot use the index, because the query retrieves both department ID and employee IDs but the index contains only employee IDs:

```
XQUERY for $i in db2-fn:xmlcolumn('COMPANY.COMPANYDOCS')//@id
  return $i
CREATE INDEX empindex on company(companydocs)
  GENERATE KEY USING XMLPATTERN '/company/emp/@id' AS SQL VARCHAR(5)
```

The following query retrieves the employees who have the employee ID 31201 or the department ID K55. Since the ID may either be an employee ID or a department ID, but the index contains only department IDs, the index cannot be used as created.

```

XQUERY
  for $i in
    db2-fn:xmlcolumn('COMPANY.COMPANYDOCS')//emp[.//@id='31201' or .//@id='K55']
  return $i
CREATE INDEX empindex on company(companydocs)
  GENERATE KEY USING XMLPATTERN '//dept//@id' AS SQL VARCHAR(5)

```

## Restrictions on indexes over XML data

Indexing over XML data is subject to restrictions, including data type support restrictions, concurrency level restrictions, XML list elements restrictions, and index compression restrictions.

### Concurrency levels

Support for some concurrency levels is restricted during processing of XML columns and associated indexes. The following table specifies what concurrency levels are supported.

*Table 24. Supported concurrency levels for a nonpartitioned table with at least one XML column*

Command	Concurrency level	Supported
<b>REORG INDEXES ALL FOR TABLE</b>	Command clause: ALLOW [NO   READ   WRITE] ACCESS	Yes.
<b>REORG TABLE</b>	Command clause: ALLOW [READ   NO] ACCESS	Yes. An index over XML data might exist.
<b>REORG TABLE INPLACE</b> (at least one index over XML data exists on the table)	Command clause: ALLOW [READ   WRITE] ACCESS	No.
<b>REORG TABLE RECLAIM EXTENTS</b>	Command clause: ALLOW [NO   READ   WRITE] ACCESS	Yes.

*Table 25. Supported concurrency levels for a partitioned table with nonpartitioned indexes and at least one XML column*

Command	Concurrency level	Supported
<b>REORG INDEX</b> (on a nonpartitioned index over XML data)	Command clause: ALLOW [NO   READ   WRITE] ACCESS	Yes.
<b>REORG INDEXES ALL FOR TABLE CLEANUP RECLAIM EXTENTS</b>	Command clause: ALLOW [NO   READ   WRITE] ACCESS	Yes.
<b>REORG INDEXES ALL FOR TABLE REBUILD</b> <sup>1</sup>	Command clause: ALLOW [READ   WRITE] ACCESS	No.
<b>REORG TABLE</b>	Command clause: ALLOW NO ACCESS (for a partitioned table, the only supported access is ALLOW NO ACCESS)	Yes.
<b>REORG TABLE INPLACE</b>	Command clause: ALLOW [NO   READ   WRITE] ACCESS	No. For a partitioned table, the <b>INPLACE</b> parameter is not supported.
<b>REORG TABLE RECLAIM EXTENTS</b>	Command clause: ALLOW [NO   READ   WRITE] ACCESS	Yes.

**Note:**

1. The default behavior rebuilds the index. If you do not specify the **REBUILD** clause, the index is rebuilt.

Table 26. Supported concurrency levels for a partitioned table with partitioned indexes and XML columns

Command	Concurrency level	Supported
<b>REORG INDEXES ALL FOR TABLE</b>	Command clause: ALLOW NO ACCESS	Yes.
<b>REORG INDEXES ALL FOR TABLE CLEANUP RECLAIM EXTENTS</b>	Command clause: ALLOW [READ   WRITE] ACCESS	Yes.
<b>REORG INDEXES ALL FOR TABLE REBUILD ON DATA PARTITION<sup>1</sup></b>	Command clause: ALLOW [READ   WRITE] ACCESS	Yes.
<b>REORG INDEXES ALL FOR TABLE REBUILD<sup>1</sup></b>	Command clause: ALLOW [READ   WRITE] ACCESS	No.
<b>REORG TABLE</b>	Command clause: ALLOW NO ACCESS (for a data partitioned table, the only supported access is ALLOW NO ACCESS)	Yes.
<b>REORG TABLE INPLACE</b>	Command clause: ALLOW [NO   READ   WRITE] ACCESS	No. For a data partitioned table, the <b>INPLACE</b> parameter is not supported.
<b>REORG TABLE RECLAIM EXTENTS</b>	Command clause: ALLOW [NO   READ   WRITE] ACCESS	Yes.

**Note:**

1. The default behavior rebuilds the index. If you do not specify the **REBUILD** clause, the index is rebuilt.

See the **CREATE INDEX** statement and **REORG INDEX/TABLE** command for information about the clauses and options.

For multidimensional clustering (MDC) and insert time clustering (ITC) tables, online index reorganization (rebuild) with ALLOW WRITE ACCESS is not supported.

**XML list elements**

You cannot index list data type nodes. If a node is qualified by *xmlpattern-clause* and an XML schema exists that specifies that the node is a list data type, you cannot index the node. Issuing a **CREATE INDEX** statement on a list data type node returns an error (SQLSTATE 23526, SQLCODE -20306). Issuing **INSERT** and **UPDATE** statements also returns an error (SQLSTATE 23525, SQLCODE -20305).

**UNIQUE index over XML data**

In a partitioned database environment, the following rules apply to a table with one or more XML columns:

- A table with a distribution key cannot have a unique index over XML data.
- A unique index over XML data is supported only on a table without a distribution key in a single-partition database.
- If a unique index over XML data exists on a table, you cannot alter the table cannot to add a distribution key.

For a partitioned table, a unique partitioned index over XML data is not supported. If you try to create such index, you will receive error message SQL20303N (SQLSTATE=42990).

Creating indexes on XML columns is also subject to restrictions placed on the native XML data store overall.

---

## Common XML indexing issues

If you encounter issues when indexing XML data, one of the following problem scenarios may apply.

### Problem determination for SQL20305N and SQL20306N error messages

These error messages are issued when XML node values cannot be indexed. The SQL20305N message is issued by INSERT and UPDATE statements and by the import and load utilities. The SQL20306N message is issued by CREATE INDEX statements issued against populated base tables.

The messages will output a reason code for the error. Issue ? SQL20305 or ? SQL20306 from the Command Line Processor to look up the explanation and user response for the corresponding reason code. A generated XQuery statement is output to the **db2diag** log file to help you locate the failing XML node values.

If SQL20305N is issued by the load utility, the generated XQuery statements to locate the failing node values are not written to a **db2diag** log file. To generate these XQuery statements, the import utility must be run on the failing rows that were not loaded. See "Loading XML data" and "Resolving indexing errors when loading XML data" in the DB2 Information Center for additional information.

If SQL20305N is issued by an INSERT or UPDATE statement, see "Troubleshooting SQL20305N messages issued by INSERT or UPDATE statements." If SQL20306N is issued by a CREATE INDEX statement, then see "Troubleshooting SQL20306N message issued by CREATE INDEX statements on populated tables."

## Troubleshooting SQL20305N messages issued by INSERT or UPDATE statements

To determine the cause of SQL20305N error messages, refer to "Problem determination for SQL20305N and SQL20306N error messages" , then follow these steps:

### Procedure

1. Determine the index name and the index XML pattern clause
  - a. Obtain the index name (*index-name,index-schema*) from SYSCAT.INDEXES by issuing the following query using the *index-id* from the error message:

```
SELECT INDNAME,INDSCHEMA
FROM SYSCAT.INDEXES
WHERE IID = index-id AND
TABSCHEMA = 'schema' AND TABNAME = 'table-name'
```
  - b. Use *index-name* and *index-schema* to obtain the index data type and XML pattern from SYSCAT.INDEXES by issuing the following query:

```

SELECT DATATYPE, PATTERN
FROM SYSCAT.INDEXXMLPATTERNS
WHERE INDSHEMA = 'index-schema' AND
INDNAME = 'index-name'

```

2. To find the failing node values in the input document, search for the string SQL20305N in the **db2diag** log file and match the reason code number. Following the reason code, you can find a set of instructions and then a generated XQuery statement that you can use to locate the value in the document that is causing the error. For small node values the full value is used in the XQuery predicate. For node values that are too long to be output to the **db2diag** log file, the starting bytes of the value are used with the fn:starts-with function and the ending bytes of the value are used with the fn:ends-with function in the XQuery predicate.
3. Because the document was rejected and does not exist in the table, the XQuery statement cannot be run on it. To solve this problem, create a new table with the same columns as the original table and insert the failing document in the new table. Do not create any indexes on the new table.
4. Copy the generated XQuery statement from the **db2diag** log file and replace the table name in the XQuery with the newly created table name.
5. Execute the XQuery statement to retrieve the entire document and the fragment of the document containing the value that caused the failure. To provide context information of where the error occurred in the document, the XQuery statement will output the document fragment starting with the parent of the node value causing the failure.
6. Use the index XML pattern to identify the set of matching XML nodes to inspect. Because the generated XQuery statement uses wildcards for namespaces, it is possible (but not common) for multiple problem values to qualify that have different namespaces. If this occurs, you must use the namespace declaration in the index XML pattern to determine the correct set of matching XML nodes. If the complete value is not used in the predicate to filter the results, the index XML pattern must be used to verify the qualifying problem values returned by the XQuery statement.
7. Once you locate the failing value in the document, modify the input document to correct the problem and resubmit the INSERT or UPDATE statement.

### Example: INSERT statement error

In the following example, hello world is an invalid DOUBLE value, and the entire value is used in the generated XQuery predicate. Note that \*N is used as a placeholder in the error message where schema information is not applicable.

```

CREATE TABLE t1 (x XML);

CREATE INDEX ix1 ON t1(x)
GENERATE KEY USING XMLPATTERN '/root/x/text()'
AS SQL DOUBLE REJECT INVALID VALUES;

```

DB20000I The SQL command completed successfully.

```

INSERT INTO t1 VALUES (XMLPARSE (DOCUMENT
'The beginning of the documenthello world'
STRIP WHITESPACE));

```

DB21034E The command was processed as an SQL statement because it was not a valid Command Line Processor command. During SQL processing it returned:

**SQL20305N** An XML value cannot be inserted or updated because of an error

detected when inserting or updating the index identified by "IID = 23" on table "ADUA.T". Reason code = "5". For reason codes related to an XML schema the XML schema identifier = "\*N" and XML schema data type = "\*N".  
SQLSTATE=23525

The output in the **db2diag** log file is as follows (with minor formatting changes):

```
2007-03-06-12.02.08.116046-480 I4436A1141          LEVEL: Warning
PID      : 1544348                TID   : 1801          PROC  : db2sysc
INSTANCE: adua                   NODE  : 000           DB    : ADTEST
APPHDL   : 0-18                  APPID: *LOCAL.adua.070306200203
AUTHID   : ADUA
EDUID    : 1801                  EDUNAME: db2agent (ADTEST)
FUNCTION: DB2 UDB, Xml Storage and Index Manager,
         xmlsIkaProcessErrorMsg, probe:651
MESSAGE  : ZRC=0x80A50411=-2136669167=XMS_XML_IX_INSERT_UPDATE_ERROR
         "XML node value error during insert or update XML index"
DATA #1 : String, 36 bytes
SQL Code: SQL20305N ; Reason Code: 5
DATA #2 : String, 321 bytes
To locate the value in the document that caused the error, create
a new table with the same columns as the original table and insert
the failing document in the table. Do not create any indexes on
the new table. Replace the table name in the query below with the
newly created table name and execute the following XQuery.
DATA #3 : String, 187 bytes
xquery for $i in db2-fn:xmlcolumn("ADUA.T.X") [/*:root/*:x/text()='hello world']
return
<Result>
  <ProblemDocument> {$i} </ProblemDocument>
  <ProblemValue>{$i/*:root/*:x/text()/..} </ProblemValue>
</Result>;
```

To find the failing node value:

1. Create a new table with the same columns as the original table:

```
CREATE TABLE t2 LIKE t1;
```

2. Insert the failing document into the new table:

```
INSERT INTO t2 VALUES (XMLPARSE (DOCUMENT
'The beginning of the documenthello world'
STRIP WHITESPACE));
```

3. Copy the generated XQuery statement from the **db2diag** log file and replace the table name in the XQuery with the new table name:

```
xquery for $i in db2-fn:xmlcolumn("ADUA.T2.X") [/*:root/*:x/text()='hello world']
return
{$i}
{$i/*:root/*:x/text()/..}
;
```

4. Execute the XQuery statement against the new table. The result of the query statement is as follows (with minor formatting changes):

```
<Result>
  <ProblemDocument>
    <root>The beginning of the document<x>hello world</x></root>
  </ProblemDocument>
  <ProblemValue><x>hello world</x></ProblemValue>
</Result>
```

Correct the error:

The document can be changed so that the <x> element has a numeric value that will cast successfully to the DOUBLE data type:



```
INSERT INTO t1 VALUES (
  XMLPARSE (DOCUMENT
    '<root>The beginning of the document<x>123</x></root>'
  STRIP WHITESPACE))
```

## Troubleshooting SQL20306N messages issued by CREATE INDEX statements on populated tables

To determine the cause of SQL20306N error messages, refer to "Problem determination for SQL20305N and SQL20306N error messages" , then follow these steps:

### Procedure

1. To find the failing node values in the stored document, search for the string SQL20306N in the **db2diag** log file and match the reason code number. Following the reason code, you can find a set of instructions and then a generated XQuery statement that you can use to locate the value in the document that caused the error.
  - For small node values, the full value is used in the XQuery predicate.
  - For node values too long to be output to the **db2diag** log file, the starting bytes of the value are used with the fn:starts-with function and the ending bytes of the value are used with the fn:ends-with function in the XQuery predicate.
2. Execute the XQuery statement to retrieve the entire document and the fragment of the document containing the value that caused the failure. To provide context information of where the error occurred in the document, the XQuery statement will output the document fragment starting with the parent of the node value causing the failure.
3. Use the index XML pattern to identify the set of matching XML nodes to inspect. Because the generated XQuery statement uses wildcards for namespaces, it is possible (but not common) for multiple problem values to qualify that have different namespaces. If this occurs, you must use the namespace declaration in the index XML pattern to determine the correct set of matching XML nodes. If the complete value is not used in the predicate to filter the results, the index XML pattern must be used to verify the qualifying problem values returned by the XQuery statement.
4. Once you have located the failing value in the document, modify the CREATE INDEX XML pattern to correct the problem, or use the XQuery predicate to update or delete the document containing the failing value.

### Example: CREATE INDEX failure

In this example, the qualified text value in the stored document exceeds the VARCHAR(4) length constraint in the index XML pattern, so that the CREATE INDEX statement fails. For large values, the generated XQuery uses the fn:starts-with and fn:ends-with functions in the predicate. Note that \*N is used as a placeholder in the error message where schema information is not applicable.

```
INSERT INTO t VALUES (XMLPARSE (DOCUMENT '
  <x>This is the beginning of the document
  <y>test
    <z>rd12345678901234567890123412345678901234567890123
  45678901234567890123456789009876543211234567890098765
  43211234456778809876543211234567890455</z>
  </y>
  </x>' strip whitespace))
```

DB20000I The SQL command completed successfully.

```
CREATE INDEX i1 ON t(x)
  GENERATE KEY USING XMLPATTERN '/x/y//text()'
  AS SQL VARCHAR(4)
```

DB21034E The command was processed as an SQL statement because it was not a valid Command Line Processor command. During SQL processing it returned:

**SQL20306N** An index on an XML column cannot be created because of an error detected when inserting the XML values into the index. **Reason code = "1"**. For reason codes related to an XML schema the XML schema identifier = "\*N" and XML schema data type = "\*N". SQLSTATE=23526

The output in the **db2diag** log file is as follows (with minor formatting changes):

```
2007-03-06-12.08.48.437571-480 I10148A1082      LEVEL: Warning
PID       : 1544348          TID  : 1801      PROC : db2sysc
INSTANCE: adua             NODE  : 000      DB   : ADTEST
APPHDL   : 0-30            APPID: *LOCAL.adua.070306200844
AUTHID   : ADUA
EDUID    : 1801            EDUNAME: db2agent (ADTEST)
FUNCTION: DB2 UDB, Xml Storage and Index Manager,
          xmlsIkaProcessErrorMsg, probe:361
MESSAGE  : ZRC=0x80A50412=-2136669166=XMS_XML_CRIX_ERROR
          "XML node value error during create XML Index"
DATA #1 : String, 36 bytes
SQL Code: SQL20306N ; Reason Code: 1
DATA #2 : String, 72 bytes
To locate the value in the document that caused the error, execute
the following XQuery.
DATA #3 : String, 435 bytes
xquery for $doc in db2-fn:xmlcolumn("ADUA.T.X")[/:*:x/*:y/*:z/text()
[fn:starts-with(., "r1d12345678901234567890123412345678901234567890123")
and fn:ends-with(., "56789009876543211234456778809876543211234567890455")]]
return
<Result>
  <ProblemDocument> {$doc} </ProblemDocument>
  <ProblemValue> {$doc/*:x/*:y/*:z/text()/..} </ProblemValue>
</Result>;
```

The result of the query statement is as follows (with minor formatting changes):

```
<Result>
  <ProblemDocument>
    <x>This is the beginning of the document
      <y>test
        <z>r1d123456789012345678901234123456789012345678901234567890123
          45678901234567890123456789009876543211234567890098765
          43211234456778809876543211234567890455</z>
        </y>
      </x>
    </ProblemDocument>
  <ProblemValue>
    <z>r1d12345678901234567890123412345678901234567890123
      45678901234567890123456789009876543211234567890098765
      43211234456778809876543211234567890455</z>
    </ProblemValue>
</Result>
```

Correcting the error:

You can change the CREATE INDEX XML pattern to increase the maximum VARCHAR length:

```
CREATE INDEX i1 ON t(x)
  GENERATE KEY USING XMLPATTERN '/x/y//text()'
  AS SQL VARCHAR(200)
```

---

## Chapter 7. Updating XML data

To update data in an XML column, use the SQL UPDATE statement. Include a WHERE clause when you want to update specific rows. The entire column value will be replaced. The input to the XML column must be a well-formed XML document. The application data type can be an XML, character, or binary type.

When you update an XML column, you might also want to validate the input XML document against a registered XML schema. You can do that with the XMLVALIDATE function.

You can use XML column values to specify which rows are to be updated. To find values within XML documents, you need to use XQuery expressions. One way of specifying XQuery expressions is the XMLEXISTS predicate, which allows you to specify an XQuery expression and determine if the expression results in an empty sequence. When XMLEXISTS is specified in the WHERE clause, rows will be updated if the XQuery expression returns a non-empty sequence.

The following examples demonstrate how XML data can be updated in XML columns. The examples use table MYCUSTOMER, which is a copy of the sample CUSTOMER table. The examples assume that MYCUSTOMER already contains a row with a customer ID value of 1004. The XML data that updates existing column data is assumed to be stored in a file c7.xml, whose contents look like this:

```
<customerinfo Cid="1004">
  <name>Christine Haas</name>
  <addr country="Canada">
    <street>12 Topgrove</street>
    <city>Toronto</city>
    <prov-state>Ontario</prov-state>
    <pcode-zip>N9Y-8G9</pcode-zip>
  </addr>
  <phone type="work">905-555-5238</phone>
  <phone type="home">416-555-2934</phone>
</customerinfo>
```

**Example:** In a JDBC application, read XML data from file c7.xml as binary data, and use it to update the data in an XML column:

```
PreparedStatement updateStmt = null;
String sqls = null;
int cid = 1004;
sqls = "UPDATE MyCustomer SET Info=? WHERE Cid=?";
updateStmt = conn.prepareStatement(sqls);
updateStmt.setInt(1, cid);
File file = new File("c7.xml");
updateStmt.setBinaryStream(2, new FileInputStream(file), (int)file.length());
updateStmt.executeUpdate();
```

**Example:** In an embedded C application, update data in an XML column from a binary XML host variable:

```
EXEC SQL BEGIN DECLARE SECTION;
  sqlint64 cid;
  SQL TYPE IS XML AS BLOB (10K) xml_hostvar;
EXEC SQL END DECLARE SECTION;
...
cid=1004;
```

```

/* Read data from file c7.xml into xml_hostvar */
...
EXEC SQL UPDATE MyCustomer SET Info=:xml_hostvar WHERE Cid=:cid;

```

In these examples, the value of the Cid attribute within the <customerinfo> element happens to be stored in the CID relational column as well. Because of this, the WHERE clause in the UPDATE statements used the relational column CID to specify the rows to update. In the case where the values that determine which rows are chosen for update are found only within the XML documents themselves, the XMLEXISTS predicate can be used. For example, the UPDATE statement in the previous embedded C application example can be changed to use XMLEXISTS as follows:

```

EXEC SQL UPDATE MyCustomer SET Info=:xml_hostvar
      WHERE XMLEXISTS ('$doc/customerinfo[@Cid = $c]'
        passing INFO as "doc", cast(:cid as integer) as "c");

```

**Example:** The following example updates existing XML data from the MYCUSTOMER table. The SQL UPDATE statement operates on a row of the MYCUSTOMER table and replaces the document in the INFO column of the row with the logical snapshot of the document modified by the transform expression:

```

UPDATE MyCustomer
SET info = XMLQUERY(
  'transform
   copy $newinfo := $info
   modify do insert <status>Current</status>
   as last into $newinfo/customerinfo
   return $newinfo' passing info as "info")
WHERE cid = 1004

```

---

## Use of updating expressions in a transform expression

DB2 XQuery updating expressions must be used in the **modify** clause of a transform expression. The updating expressions operate on the copied nodes created by the **copy** clause of the transform expression.

The following expressions are updating expressions:

- A delete expression
- An insert expression
- A rename expression
- A replace expression
- A FLWOR expression that contains an updating expression in its **return** clause
- A conditional expression that contains an updating expression in its **then** or **else** clause
- Two or more updating expressions, separated by commas where all operands are either updating expressions or an empty sequence

DB2 XQuery returns an error for updating expressions that are not valid. For example, DB2 XQuery returns an error if one branch of a conditional expression contains an updating expression and the other branch contains a non-updating expression that is not the empty sequence.

A transform expression is not an updating expression, because it does not modify any existing nodes. A transform expression creates modified copies of existing nodes. The result of a transform expression can include nodes created by updating expressions in the **modify** clause of the transform expression and copies of previously existing nodes.

## Processing XQuery updating operations

In a transform expression, the **modify** clause can specify multiple updates. For example, the **modify** clause can contain two updating expressions, one expression that replaces an existing value, and the other expression that inserts a new element. When the **modify** clause contains multiple updating expressions, each updating expression is evaluated independently and results in a list of change operations associated with specific nodes that were created by the **copy** clause of the transform expression.

Within a **modify** clause, updating expressions cannot modify new nodes that are added by other updating expressions. For example, if an updating expression adds a new element node, another updating expression cannot change the node name of the newly created node.

All the change operations specified in the **modify** clause of the transform expression are collected and effectively applied in the following order:

1. The following updating operations are performed in a nondeterministic order:
  - Insert operations that do not use ordering keywords such as **before**, **after**, **as first**, or **as last**.
  - All rename operations.
  - Replace operations where the keywords **value of** are specified and the target node is an attribute, text, comment, or processing instruction node.
2. Insert operations that use ordering keywords such as **before**, **after**, **as first**, or **as last**.
3. Replace operations where the keywords **value of** are not specified.
4. Replace operations where the keywords **value of** are specified and the target node is an element node.
5. All delete operations.

The order in which change operations are applied ensures that a series of multiple changes will have a deterministic result. For an example of how the order of update operations guarantees that a series of multiple changes will have a deterministic result, see the last XQuery expression in “Examples” on page 196.

## Invalid XQuery updating operations

During processing of a transform expression, DB2 XQuery returns an error if any of the following conditions occur:

- Two or more rename operations are applied to the same node.
- Two or more replace operations that use the **value of** keywords are applied to the same node.
- Two or more replace operations that don't use the **value of** keywords are applied to the same node.
- The result of the transform expression is not a valid XDM instance.

An example of an invalid XDM instance is one that contains an element with two attributes where both attributes have the same name.

- The XDM instance contains inconsistent namespace bindings.

The following are examples of inconsistent namespace bindings:

- A namespace binding in the QName of an attribute node does not agree with the namespace bindings in its parent element node.

- The namespace bindings in two attribute nodes with the same parent do not agree with each other.

## Examples

In the following example, the **copy** clause of a transform expression binds the variable \$product to a copy of an element node, and the **modify** clause of the transform expression uses two updating expressions to change the copied node:

```
xquery
transform
copy $product := db2-fn:sqlquery(
  "select description from product where pid='100-100-01'")/product
modify(
  do replace value of $product/description/price with 349.95,
  do insert <status>Available</status> as last into $product )
return $product
```

The following example uses an XQuery transform expression within an SQL UPDATE statement to modify XML data in the CUSTOMER table. The SQL UPDATE statement operates on a row of the CUSTOMER table. The transform expression creates a copy of the XML document from the INFO column of the row, and adds a status element to the copy of the document. The UPDATE statement replaces the document in the INFO column of the row with the copy of the document modified by the transform expression:

```
UPDATE customer
SET info = xmlquery( 'transform
  copy $newinfo := $info
  modify do insert <status>Current</status> as last into $newinfo/customerinfo
  return $newinfo' passing info as "info")
WHERE cid = 1003
```

The following examples use the CUSTOMER table from the DB2 SAMPLE database. In the CUSTOMER table, the XML column INFO contains customer address and phone information.

In the following example, the SQL SELECT statement operates on a row of the CUSTOMER table. The **copy** clause of the transform expression creates a copy of the XML document from the column INFO. The delete expression deletes address information, and non-work phone numbers, from the copy of the document. The **return** uses the customer ID attribute and country attribute from the original document from the CUSTOMER table:

```
SELECT XMLQUERY( 'transform
  copy $mycust := $d
  modify
  do delete ( $mycust/customerinfo/addr,
    $mycust/customerinfo/phone[@type != "work"] )
  return
  <custinfo>
  <Cid>{data($d/customerinfo/@Cid)}</Cid>
  {$mycust/customerinfo/*}
  <country>{data($d/customerinfo/addr/@country)}</country>
  </custinfo>'
  passing INFO as "d")
FROM CUSTOMER
WHERE CID = 1003
```

When run against the SAMPLE database, the statement returns the following result:

```

<custinfo>
  <Cid>1003</Cid>
  <name>Robert Shoemaker</name>
  <phone type="work">905-555-7258</phone>
  <country>Canada</country>
</custinfo>

```

In the following example, the XQuery expression demonstrates how the order of update operations guarantees that a series of multiple changes will have a deterministic result. The insert expression adds a status element after a phone element, and the replace expression replaces the phone element with an email element:

```

xquery
let $email := <email>jnoodle@my-email.com</email>
let $status := <status>current</status>
return
  transform
  copy $mycust := db2-fn:sqlquery('select info from customer where cid = 1002')
  modify (
    do replace $mycust/customerinfo/phone with $email,
    do insert $status after $mycust/customerinfo/phone[@type = "work"] )
  return $mycust

```

In the **modify** clause, the replace expression is before the insert expression. However, when updating the copied node sequence `$mycust`, the insert update operation is performed before the replace update operation to ensure a deterministic result. When run against the SAMPLE database, the expression returns the following result:

```

<customerinfo Cid="1002">
  <name>Jim Noodle</name>
  <addr country="Canada">
    <street>25 EastCreek</street>
    <city>Markham</city>
    <prov-state>Ontario</prov-state>
    <pcode-zip>N9C 3T6</pcode-zip>
  </addr>
  <email>jnoodle@my-email.com</email>
  <status>current</status>
</customerinfo>

```

If the replace operation were performed first, the phone element would not be in the node sequence, and the operation to insert the status element after the phone element would have no meaning.

For information about the order of update operations, see “Processing XQuery updating operations” on page 195.

---

## Updating XML documents with information from other tables

You can use data from other database columns to update XML documents. If you have a table that contains updated customer information, for example, you can use SQL/XML statements and XQuery expressions to update the customer information in XML documents.

Use the following SQL statements to create a sample table that contains new customer phone numbers.

```

CREATE TABLE NewPhones (
  CID BIGINT NOT NULL PRIMARY KEY, PhoneNo VARCHAR(20), Type VARCHAR(10))~

```

```

INSERT INTO NewPhones (CID, PhoneNo, Type) VALUES (1001, '111-222-3333', 'cell' )~
INSERT INTO NewPhones (CID, PhoneNo, Type) VALUES (1002, '222-555-1111', 'home' )~
INSERT INTO NewPhones (CID, PhoneNo, Type) VALUES (1003, '333-444-2222', 'home' )~

```

Use the following SQL statement to update a customer phone number in the CUSTOMER table. The statement uses the XMLQUERY function and an XQuery expression consisting of a FLWOR expression and a transform expression that contains an insert expression.

```

UPDATE CUSTOMER SET INFO = XMLQUERY(
  'let $myphone := db2-fn:sqlquery(''SELECT XMLELEMENT(Name "phone",
    XMLATTRIBUTES( NewPhones.Type as "type" ), NewPhones.PhoneNo )
    FROM NewPhones WHERE CID = parameter(1)'', $mycid )
  return
    transform
    copy $mycust := $d
    modify
    do insert $myphone after $mycust/customerinfo/phone[last()]
    return
    $mycust'
  passing INFO as "d", 1002 as "mycid" )
WHERE CID = 1002~

```

The XMLQUERY function executes an XQuery expression that adds a phone element node to the customer information and returns the modified information to the UPDATE statement. In the **let** clause of the XQuery FLWOR expression, the db2-fn:sqlquery function executes an SQL fullselect statement. The fullselect uses the customer ID passed to the XQuery expression from XMLQUERY.

The fullselect statement must return an XML data type. To create an XML data type from the PHONENO and TYPE data returned from the SELECT statement, the XMLELEMENT and XMLATTRIBUTES functions create a phone element node based on the data supplied.

In the example, the fullselect executed by db2-fn:sqlquery in the **let** clause creates the following phone element node.

```
<phone type="home">222-555-1111</phone>
```

Run the following SQL select to see the customer information, now with both a work and a home phone number.

```
SELECT INFO FROM CUSTOMER WHERE CID = 1002~
```

---

## Deletion of XML data from tables

To delete rows that contain XML documents, use the DELETE SQL statement. Include a WHERE clause when you want to delete specific rows.

You can specify which rows are to be deleted based on values within XML columns. To find values within XML documents, you need to use XQuery expressions. One way of specifying XQuery expressions is the XMLEXISTS predicate, which allows you to specify an XQuery expression and determine if the expression results in an empty sequence. When XMLEXISTS is specified in the WHERE clause, rows will be deleted if the XQuery expression returns a non-empty sequence.

An XML column must either be NULL or contain a well-formed XML document. To delete an XML document from an XML column without deleting the row, use the UPDATE SQL statement with SET NULL, to set the column to NULL, if the column is defined as nullable. To delete objects such as attributes or elements from



an existing XML document, use the UPDATE SQL statement with XQuery updating expressions. XQuery updating expressions can be used to make changes to a copy of the existing XML document. The UPDATE statement then applies the changed copy returned by the XQuery updating expression to the XML column for the specified row.

The following examples demonstrate how XML data can be deleted from XML columns. The examples use table MyCustomer, which is a copy of the sample Customer table, and assume that MyCustomer has been populated with all of the Customer data.

**Example:** Delete the rows from table MyCustomer for which the Cid column value is 1002.

```
DELETE FROM MyCustomer WHERE Cid=1002
```

**Example:** Delete the rows from table MyCustomer for which the value of the city element is Markham. This statement deletes the row that has a customer ID of 1002.

```
DELETE FROM MyCustomer
WHERE XMLEXISTS ('$d//addr[city="Markham"]' passing INFO as "d")
```

**Example:** Delete the XML document in the row of MyCustomer for which the value of the city element is Markham, but leave the row. This statement should delete the XML data from the Info column for the row that has a customer ID of 1002.

```
UPDATE MyCustomer SET Info = NULL
WHERE XMLEXISTS ('$d//addr[city="Markham"]' passing INFO as "d")
```

**Example:** The following example deletes phone information from existing XML data from the MyCustomer table. The SQL UPDATE statement operates on a row of the MyCustomer table. The XQuery transform expression creates a copy of the XML document from the INFO column of the row, and uses the XQuery delete expression to remove the work phone number from the copy of the document. The UPDATE statement replaces the document in the INFO column of the row with the copy of the document modified by the transform expression:

```
UPDATE MyCustomer
SET info = XMLQUERY(
  'transform
  copy $newinfo := $info
  modify do delete ($newinfo/customerinfo/phone[@type="work"])
  return $newinfo' passing info as "info")
WHERE cid = 1004
```



---

## Chapter 8. XML schema repository

The XML schema repository (XSR) is a repository for all XML artifacts used to process XML instance documents stored in XML columns. The purpose of the XSR is to support tasks you perform that have a dependency on these XML artifacts.

XML instance documents might contain a reference to a Uniform Resource Identifier (URI) that points to an associated XML schema, DTD or other external entity. This URI is required to process the instance documents. The DB2 database system manages dependencies on such externally referenced XML artifacts with the XSR without requiring changes to the URI location reference.

Without this mechanism to store associated XML schemas, DTDs, or external entities, an external resource may not be accessible when needed by the database, or may be subject to change without also triggering the necessary changes to an already validated and annotated XML document stored within the database. The XSR also removes the additional overhead required to locate external documents, along with the possible performance impact.

Each database contains an XML schema repository that resides in the database catalog and comprises catalog tables, catalog views and some built-in stored procedures to enter data into these catalog tables.

---

### XSR objects

The XML schema repository (XSR) supports the creation of a copy of the information contained in an XML schema, DTD or external entity as an XSR object. This information is used to validate and process XML instance documents stored in XML columns.

New XSR objects must be explicitly added to the XSR before use through the registration process, which identifies the XML schema, DTD or external entity. XSR objects can be registered from Java applications, stored procedures, or the command line processor.

The most widely used XSR object is the XML schema. Each XML schema in the XSR can consist of one or more XML schema documents. Where an XML schema consists of multiple documents, the document used to begin the registration process is the primary XML schema document. Where an XML schema consists of only one document, that document is the primary XML schema document.

For a description of the syntax of XSR stored procedures and commands, see Appendix C, “XSR stored procedures and commands,” on page 475.

---

### XSR object registration

Before an XML schema, DTD, or external entity can be used to process XML documents, it must be registered with the XML schema repository (XSR). Registration with the XSR creates an XSR object.

In order to register most XML schemas, the application heap size configuration parameter (applheapsz) needs to be increased. To register very complex XML schemas on a Windows 32-bit operating system, the agent stack size configuration

parameter (`agent_stack_sz`) may also need to be increased. Please refer to the following related links on how to change either of these configuration parameters.

For XML schemas, XSR object registration involves the following steps:

1. Register the primary XML schema document in the XML schema repository.
2. Specify additional XML schema documents to be included with the XSR object. This step is required only if your XML schema consists of more than one schema document.
3. Complete the registration process with the XML schema repository.

For DTDs and external entities, XSR object registration with the XML schema repository is a single step process.

The XSR object registration steps can be performed from either of the following:

- Java applications
- Stored procedures
- Command line processor

Note that you cannot use CLP commands to register XML schemas from host applications, because the required file information cannot be passed through these commands. In order to register XML schemas from applications connecting to a DB2 database through a CLI/ODBC or JDBC driver, use the stored procedure method.

In the description of these methods, the following example of an XML schema made up of two XML schema documents is used: "PO.xsd" and "address.xsd", both stored locally in C:\TEMP. The user wants to register this schema under the SQL two-part name of "user1.POschema". The XML Schema has a properties file associated with it called `schemaProp.xml`. This properties file is also stored locally, in the same C:\TEMP directory. The two XML schema documents do not have properties associated with them. The user defines the URI by which this schema is externally known as "http://myPOschema/PO".

## Privileges

Any user with DBADM authority can register an XSR object. For all other users, the privileges are based on the SQL schema that is supplied during the registration process. If the SQL schema does not exist, then `IMPLICIT_SCHEMA` authority on the database is required to register the schema. If the SQL schema exists, then the user registering the schema needs `CREATEIN` privilege on the SQL schema.

For XML schemas, the user to initiate the XSR object registration process (through the `XSR_REGISTER` stored procedure, for example) must also be the user to specify additional XML schema documents (if applicable) and to complete the registration process.

The `USAGE` privilege for an XSR object is automatically granted to the creator of the XSR object.

## Registering XSR objects through stored procedures

When a database is created, the stored procedures used to register XML schemas are also created. To register XML schemas through the stored procedure method, invoke the `XSR_REGISTER`, `XSR_ADDSCHEMADOC` and `XSR_COMPLETE` stored procedures with the `CALL` statement.

An XML schema document is not checked for correctness when registering or adding documents. Document checks are performed only when you complete the XML schema registration.

Registering XML schemas:

1. Register the primary XML schema document by calling the SYSPROC.XSR\_REGISTER stored procedure:

```
CALL SYSPROC.XSR_REGISTER ('user1', 'POschema', 'http://myPOschema/PO',
                           :content_host_var, NULL)
```

2. Before completing the registration, add any additional XML schema documents to be included with the primary XML schema. Note that each additional schema document can be included only once. For our example, this step is not optional, since the XML schema consists of two XML schema documents, both of which must be registered. Use the XSR\_ADDSCHEMADOC stored procedure to add additional XML schema documents. In the following example, we add the schema constructs for addresses to the XSR object:

```
CALL SYSPROC.XSR_ADDSCHEMADOC ('user1', 'POschema', 'http://myPOschema/address',
                               :content_host_var, NULL)
```

3. Complete registration by calling the SYSPROC.XSR\_COMPLETE stored procedure. In the following example, the last parameter indicates that the XML schema will not be used for decomposition (a value of 1 would indicate that it will be used for decomposition):

```
CALL SYSPROC.XSR_COMPLETE ('user1', 'POschema', :schemaproperty_host_var, 0)
```

## Privileges

Any user with DBADM authority can register an XML schema. For all other users, the privileges are based on the SQL schema that is supplied during the registration process. If the SQL schema does not exist, then IMPLICIT\_SCHEMA authority on the database is required to register the schema. If the SQL schema exists, then the user registering the schema needs CREATEIN privilege on the SQL schema.

The USAGE privilege for an XSR object is automatically granted to the creator of the XSR object.

## Registering XSR objects through the command line processor

To register XML schemas through the command line processor, use the REGISTER XMLSCHEMA, ADD XMLSCHEMA DOCUMENT and COMPLETE XMLSCHEMA commands.

An XML schema document is not checked for correctness when registering or adding documents. Document checks are performed only when you complete schema registration.

Note that you cannot use CLP commands to register XML schemas from host applications, because the required file information cannot be passed through these commands. In order to register XML schemas from applications connecting to a DB2 database through a CLI/ODBC or JDBC driver, use the stored procedure method.

Registering XML schemas:

1. Register the primary XML schema document by issuing the REGISTER XMLSCHEMA command:

```
REGISTER XMLSCHEMA 'http://myPOschema/PO'
FROM 'file://c:/TEMP/PO.xsd'
AS user1.POschema
```

- Before completing the registration, you may optionally add additional XML schema documents to be included with the primary XML schema. Use the `ADD XMLSCHEMA DOCUMENT` command to add additional XML schema documents. Note that each additional schema document can be included only once. In the following example, we add the schema constructs for addresses to storage:

```
ADD XMLSCHEMA DOCUMENT TO user1.POschema
  ADD 'http://myPOschema/address'
  FROM 'file://c:/TEMP/address.xsd'
```

- Complete registration by issuing the `COMPLETE XMLSCHEMA` command:

```
COMPLETE XMLSCHEMA user1.POschema
WITH 'file://c:/TEMP/schemaProp.xml'
```

## Privileges

Any user with `DBADM` authority can register an XML schema. For all other users, the privileges are based on the SQL schema that is supplied during the registration process. If the SQL schema does not exist, then `IMPLICIT_SCHEMA` authority on the database is required to register the schema. If the SQL schema exists, then the user registering the schema needs `CREATEIN` privilege on the SQL schema.

The `USE` privilege for XSR objects is automatically granted to the creator of the XSR object.

## Java support for XML schema registration and removal

The IBM Data Server Driver for JDBC and SQLJ provides methods that let you write Java application programs to register and remove XML schemas and their components.

The methods are:

### **DB2Connection.registerDB2XMLSchema**

Registers an XML schema in DB2, using one or more XML schema documents. There are two forms of this method: one form for XML schema documents that are input from `InputStream` objects, and one form for XML schema documents that are in a `String`.

### **DB2Connection.deregisterDB2XMLObject**

Removes an XML schema definition from DB2.

### **DB2Connection.updateDB2XmlSchema**

Replaces the XML schema documents in a registered XML schema with the XML schema documents from another registered XML schema. Optionally drops the XML schema whose contents are copied. This method is available only for connections to DB2 Database for Linux, UNIX, and Windows.

Before you can invoke these methods, the stored procedures that support these methods must be installed on the DB2 database server.

*Example: Registration of an XML schema:* The following example demonstrates the use of `registerDB2XmlSchema` to register an XML schema in DB2 using a single XML schema document (`customer.xsd`) that is read from an input stream. The SQL schema name for the registered schema is `SYSXSR`. No additional properties are registered.

```

public static void registerSchema(
    Connection con,
    String schemaName)
    throws SQLException {
    // Define the registerDB2XmlSchema parameters
    String[] xmlSchemaNameQualifiers = new String[1];
    String[] xmlSchemaNames = new String[1];
    String[] xmlSchemaLocations = new String[1];
    InputStream[] xmlSchemaDocuments = new InputStream[1];
    int[] xmlSchemaDocumentsLengths = new int[1];
    java.io.InputStream[] xmlSchemaDocumentsProperties = new InputStream[1];
    int[] xmlSchemaDocumentsPropertiesLengths = new int[1];
    InputStream xmlSchemaProperties;
    int xmlSchemaPropertiesLength;
    //Set the parameter values
    xmlSchemaLocations[0] = "";
    FileInputStream fi = null;
    xmlSchemaNameQualifiers[0] = "SYSXSR";
    xmlSchemaNames[0] = schemaName;
    try {
        fi = new FileInputStream("customer.xsd");
        xmlSchemaDocuments[0] = new BufferedInputStream(fi);
    } catch (FileNotFoundException e) {
        e.printStackTrace();
    }
    try {
        xmlSchemaDocumentsLengths[0] = (int) fi.getChannel().size();
        System.out.println(xmlSchemaDocumentsLengths[0]);
    } catch (IOException e1) {
        e1.printStackTrace();
    }
    xmlSchemaDocumentsProperties[0] = null;
    xmlSchemaDocumentsPropertiesLengths[0] = 0;
    xmlSchemaProperties = null;
    xmlSchemaPropertiesLength = 0;
    DB2Connection ds = (DB2Connection) con;
    // Invoke registerDB2XmlSchema
    ds.registerDB2XmlSchema(
        xmlSchemaNameQualifiers,
        xmlSchemaNames,
        xmlSchemaLocations,
        xmlSchemaDocuments,
        xmlSchemaDocumentsLengths,
        xmlSchemaDocumentsProperties,
        xmlSchemaDocumentsPropertiesLengths,
        xmlSchemaProperties,
        xmlSchemaPropertiesLength,
        false);
}

```

*Example: Removal of an XML schema:* The following example demonstrates the use of `deregisterDB2XmlObject` to remove an XML schema from DB2. The SQL schema name for the registered schema is SYSXSR.

```

public static void deregisterSchema(
    Connection con,
    String schemaName)
    throws SQLException {
    // Define and assign values to the deregisterDB2XmlObject parameters
    String xmlSchemaNameQualifier = "SYSXSR";
    String xmlSchemaName = schemaName;
    DB2Connection ds = (DB2Connection) con;
    // Invoke deregisterDB2XmlObject
    ds.deregisterDB2XmlObject(
        xmlSchemaNameQualifier,
        xmlSchemaName);
}

```

*Example: Update of an XML schema:* The following example applies only to connections to DB2 Database for Linux, UNIX, and Windows. It demonstrates the use of `updateDB2XmlSchema` to update the contents of an XML schema with the contents of another XML schema. The schema that is copied is kept in the repository. The SQL schema name for both registered schemas is `SYSXSR`.

```
public static void updateSchema(  
    Connection con,  
    String schemaNameTarget,  
    String schemaNameSource)  
    throws SQLException {  
    // Define and assign values to the updateDB2XmlSchema parameters  
    String xmlSchemaNameQualifierTarget = "SYSXSR";  
    String xmlSchemaNameQualifierSource = "SYSXSR";  
    String xmlSchemaNameTarget = schemaNameTarget;  
    String xmlSchemaNameSource = schemaNameSource;  
    boolean dropSourceSchema = false;  
    DB2Connection ds = (DB2Connection) con;  
    // Invoke updateDB2XmlSchema  
    ds.updateDB2XmlSchema(  
        xmlSchemaNameQualifierTarget,  
        xmlSchemaNameTarget,  
        xmlSchemaNameQualifierSource,  
        xmlSchemaNameSource,  
        dropSourceSchema);  
}
```

---

## Altering registered XSR objects

Once registered in the XML schema repository, XSR objects can be altered to enable or disable decomposition, dropped, or associated with a comment. Additionally, usage privileges can be granted or revoked for registered XSR objects.

### About this task

The XML schema repository is used to manage dependencies of XML documents on XML schemas, DTDs or other external entities. Each of these XML schemas, DTDs or external entities first must be registered as a new XSR object in the XML schema repository.

## Evolving an XML schema

An XML schema that is registered in the XML schema repository (XSR) can be evolved into a new, compatible XML schema without the need for already stored XML instance documents to be validated again. Only the XML schema as registered in the XSR is updated; the stored XML instance documents, including their URI identifiers, remain unchanged.

### Before you begin

Before a schema can be evolved, the new XML schema must be compatible with the original one. If the two schemas are not compatible, the `XSR_UPDATE` stored procedure or the `UPDATE XMLSCHEMA` command will return an error and no schema evolution takes place. See *Compatibility requirements for evolving an XML schema*.

### About this task

To evolve an XML schema in the XSR:



## Procedure

1. Call the XSR\_REGISTER stored procedure or run the REGISTER XMLSCHEMA command to register the new XML schema in the XSR.
2. Finally, call the XSR\_UPDATE stored procedure or run the UPDATE XMLSCHEMA command to update the new XML schema in the XSR.

## What to do next

Successful schema evolution replaces the original XML schema. Once evolved, only the updated XML schema is available.

## Compatibility requirements for evolving an XML schema

The process of evolving an XML schema in the XML schema repository (XSR) requires that both the original XML schema and the new one used to update it are sufficiently alike.

In cases where the two XML schemas are not compatible, the update will fail and an error message is generated. The following ten compatibility criteria must be met for the update process to proceed. Examples are shown of schemas that would not meet the described requirement.

### Attribute content

Attributes declared or referenced inside of a complex type in the original XML schema must also be present in the new XML schema. Also, required attributes cannot be present in the new XML schema if they are not included in the original XML schema.

#### Example 1

Original XML schema:

```
<?xml version="1.0" encoding="UTF-8"?>
<xs:schema xmlns:xs="http://www.w3.org/2001/XMLSchema"
  elementFormDefault="qualified">
  <xs:element name="root">
    <xs:complexType>
      <xs:attribute name="a" type="xs:string"/>
      <xs:attribute name="b" use="optional" type="xs:string"/>
    </xs:complexType>
  </xs:element>
</xs:schema>
```

New XML schema:

```
<?xml version="1.0" encoding="UTF-8"?>
<xs:schema xmlns:xs="http://www.w3.org/2001/XMLSchema"
  elementFormDefault="qualified">
  <xs:element name="root">
    <xs:complexType>
      <xs:attribute name="a" type="xs:string"/>
    </xs:complexType>
  </xs:element>
</xs:schema>
```

#### Example 2

Original XML schema:

```
<?xml version="1.0" encoding="UTF-8"?>
<xs:schema xmlns:xs="http://www.w3.org/2001/XMLSchema"
  elementFormDefault="qualified">
  <xs:element name="root">
    <xs:complexType>
```

```

        <xs:attribute name="a" type="xs:string"/>
    </xs:complexType>
</xs:element>
</xs:schema>

```

New XML schema:

```

<?xml version="1.0" encoding="UTF-8"?>
<xs:schema xmlns:xs="http://www.w3.org/2001/XMLSchema"
  elementFormDefault="qualified">
  <xs:element name="root">
    <xs:complexType>
      <xs:attribute name="a" type="xs:string"/>
      <xs:attribute name="b" type="xs:string" use="required" />
    </xs:complexType>
  </xs:element>
</xs:schema>

```

## Element content

Elements declared or referenced inside of a complex type in the original XML schema must be present in the new XML schema. Required elements cannot be present in the new XML schema if they are not included in the original XML schema; only optional elements may be added.

### Example 1

Original XML schema:

```

<?xml version="1.0" encoding="UTF-8"?>
<xs:schema xmlns:xs="http://www.w3.org/2001/XMLSchema"
  elementFormDefault="qualified">
  <xs:element name="root">
    <xs:complexType>
      <xs:sequence>
        <xs:element name="a" type="xs:string"/>
        <xs:element name="b" minOccurs="0" type="xs:string"/>
      </xs:sequence>
    </xs:complexType>
  </xs:element>
</xs:schema>

```

New XML schema:

```

<?xml version="1.0" encoding="UTF-8"?>
<xs:schema xmlns:xs="http://www.w3.org/2001/XMLSchema"
  elementFormDefault="qualified">
  <xs:element name="root">
    <xs:complexType>
      <xs:sequence>
        <xs:element name="a" type="xs:string"/>
      </xs:sequence>
    </xs:complexType>
  </xs:element>
</xs:schema>

```

### Example 2

Original XML schema:

```

<?xml version="1.0" encoding="UTF-8"?>
<xs:schema xmlns:xs="http://www.w3.org/2001/XMLSchema"
  elementFormDefault="qualified">
  <xs:element name="root">
    <xs:complexType>
      <xs:sequence>
        <xs:element name="a" type="xs:string"/>
      </xs:sequence>
    </xs:complexType>
  </xs:element>
</xs:schema>

```

New XML schema:

```
<?xml version="1.0" encoding="UTF-8"?>
<xs:schema xmlns:xs="http://www.w3.org/2001/XMLSchema"
  elementFormDefault="qualified">
  <xs:element name="root">
    <xs:complexType>
      <xs:sequence>
        <xs:element name="a" type="xs:string"/>
        <xs:element name="b" type="xs:string"/>
      </xs:sequence>
    </xs:complexType>
  </xs:element>
</xs:schema>
```

### Example 3

Original XML schema:

```
<?xml version="1.0" encoding="UTF-8"?>
<xs:schema xmlns:xs="http://www.w3.org/2001/XMLSchema"
  elementFormDefault="qualified">
  <xs:element name="a" type="xs:string"/>
  <xs:element name="b" substitutionGroup="a"/>
  <xs:element name="root">
    <xs:complexType>
      <xs:sequence>
        <xs:element ref="a"/>
      </xs:sequence>
    </xs:complexType>
  </xs:element>
</xs:schema>
```

New XML schema:

```
<?xml version="1.0" encoding="UTF-8"?>
<xs:schema xmlns:xs="http://www.w3.org/2001/XMLSchema"
  elementFormDefault="qualified">
  <xs:element name="a" type="xs:string"/>
  <xs:element name="b" type="xs:string"/>
  <xs:element name="root">
    <xs:complexType>
      <xs:sequence>
        <xs:element ref="a"/>
      </xs:sequence>
    </xs:complexType>
  </xs:element>
</xs:schema>
```

### Facet conflict

The facet value for a simple type in the new XML schema must be compatible with the range of values for the simple type defined in the original XML schema.

### Example 1

Original XML schema:

```
<?xml version="1.0" encoding="UTF-8"?>
<xs:schema xmlns:xs="http://www.w3.org/2001/XMLSchema"
  elementFormDefault="qualified">
  <xs:element name="foo" >
    <xs:simpleType>
      <xs:restriction base="xs:decimal" />
    </xs:simpleType>
  </xs:element>
</xs:schema>
```

New XML schema:

```

<?xml version="1.0" encoding="UTF-8"?>
<xs:schema xmlns:xs="http://www.w3.org/2001/XMLSchema"
  elementFormDefault="qualified">
  <xs:element name="foo">
    <xs:simpleType>
      <xs:restriction base="xs:decimal">
        <xs:totalDigits value="7"/>
      </xs:restriction>
    </xs:simpleType>
  </xs:element>
</xs:schema>

```

## Example 2

Original XML schema:

```

<?xml version="1.0" encoding="UTF-8"?>
<xs:schema xmlns:xs="http://www.w3.org/2001/XMLSchema"
  elementFormDefault="qualified">
  <xs:element name="foo">
    <xs:simpleType>
      <xs:restriction base="xs:decimal">
        <xs:totalDigits value="7"/>
        <xs:fractionDigits value="3"/>
        <xs:maxInclusive value="300.00"/>
        <xs:minInclusive value="1.0"/>
      </xs:restriction>
    </xs:simpleType>
  </xs:element>
</xs:schema>

```

New XML schema:

```

<?xml version="1.0" encoding="UTF-8"?>
<xs:schema xmlns:xs="http://www.w3.org/2001/XMLSchema"
  elementFormDefault="qualified">
  <xs:element name="foo">
    <xs:simpleType>
      <xs:restriction base="xs:decimal">
        <xs:totalDigits value="5"/>
        <xs:fractionDigits value="2"/>
        <xs:pattern value="(0|1|2|3|4|5|6|7|8|9|\.)*/>
        <xs:maxInclusive value="100.00"/>
        <xs:minInclusive value="10.00"/>
      </xs:restriction>
    </xs:simpleType>
  </xs:element>
</xs:schema>

```

## Incompatible type

The type of an element or attribute in the new XML schema is not compatible if already inserted XML documents would fail validation against the new schema, or if the schema includes a simple type annotation that differs from that in the original XML schema.

### Example

Original XML schema:

```

<?xml version="1.0" encoding="UTF-8"?>
<xs:schema xmlns:xs="http://www.w3.org/2001/XMLSchema"
  elementFormDefault="qualified">
  <xs:element name="a" type="xs:string"/>
</xs:schema>

```

New XML schema:

```

<?xml version="1.0" encoding="UTF-8"?>
<xs:schema xmlns:xs="http://www.w3.org/2001/XMLSchema"
  elementFormDefault="qualified">
  <xs:element name="a" type="xs:integer"/>
</xs:schema>

```

### Mixed into not mixed content

If the content model of a complex type is declared as mixed in the original XML schema, it must not be declared as not mixed in the new XML schema.

#### Example

Original XML schema:

```
<?xml version="1.0" encoding="UTF-8"?>
<xs:schema xmlns:xs="http://www.w3.org/2001/XMLSchema"
  elementFormDefault="qualified">
  <xs:element name="root">
    <xs:complexType>
      <xs:complexContent mixed="true">
        <xs:restriction base="xs:anyType">
          <xs:attribute name="a" type="xs:string"/>
        </xs:restriction>
      </xs:complexContent>
    </xs:complexType>
  </xs:element>
</xs:schema>
```

New XML schema:

```
<?xml version="1.0" encoding="UTF-8"?>
<xs:schema xmlns:xs="http://www.w3.org/2001/XMLSchema"
  elementFormDefault="qualified">
  <xs:element name="root">
    <xs:complexType>
      <xs:complexContent mixed="false">
        <xs:restriction base="xs:anyType">
          <xs:attribute name="a" type="xs:string"/>
        </xs:restriction>
      </xs:complexContent>
    </xs:complexType>
  </xs:element>
</xs:schema>
```

### Nilable into not nilable

If the nilable attribute in an element declaration of the original XML schema is turned on, it must also be turned on in the new XML schema.

#### Example

Original XML schema:

```
<?xml version="1.0" encoding="UTF-8"?>
<xs:schema xmlns:xs="http://www.w3.org/2001/XMLSchema"
  elementFormDefault="qualified">
  <xs:element name="root">
    <xs:complexType>
      <xs:sequence>
        <xs:element name="a" nilable="true" type="xs:string"/>
      </xs:sequence>
    </xs:complexType>
  </xs:element>
</xs:schema>
```

New XML schema:

```
<?xml version="1.0" encoding="UTF-8"?>
<xs:schema xmlns:xs="http://www.w3.org/2001/XMLSchema"
  elementFormDefault="qualified">
  <xs:element name="root">
    <xs:complexType>
      <xs:sequence>
        <xs:element name="a" nilable="false" type="xs:string"/>
      </xs:sequence>
    </xs:complexType>
  </xs:element>
</xs:schema>
```

```

        </xs:sequence>
    </xs:complexType>
</xs:element>
</xs:schema>

```

### Removed element

Global elements declared in the original XML schema must also be present in the new XML schema, and must not be made abstract.

#### Example 1

Original XML schema:

```

<?xml version="1.0" encoding="UTF-8"?>
<xs:schema xmlns:xs="http://www.w3.org/2001/XMLSchema"
  elementFormDefault="qualified">
  <xs:element name="a" type="xs:string"/>
  <xs:element name="b" type="xs:string"/>
</xs:schema>

```

New XML schema:

```

<?xml version="1.0" encoding="UTF-8"?>
<xs:schema xmlns:xs="http://www.w3.org/2001/XMLSchema"
  elementFormDefault="qualified">
  <xs:element name="a" type="xs:string"/>
</xs:schema>

```

#### Example 2

Original XML schema:

```

<?xml version="1.0" encoding="UTF-8"?>
<xs:schema xmlns:xs="http://www.w3.org/2001/XMLSchema"
  elementFormDefault="qualified">
  <xs:element name="a" type="xs:string"/>
  <xs:element name="b" type="xs:string"/>
</xs:schema>

```

New XML schema:

```

<?xml version="1.0" encoding="UTF-8"?>
<xs:schema xmlns:xs="http://www.w3.org/2001/XMLSchema"
  elementFormDefault="qualified">
  <xs:element name="a" type="xs:string"/>
  <xs:element name="b" abstract="true" type="xs:string"/>
</xs:schema>

```

### Removed type

If the original XML schema contains a global type that is derived from another type, the global type must also be present in the new XML schema.

#### Example

Original XML schema:

```

<?xml version="1.0" encoding="UTF-8"?>
<xs:schema xmlns:xs="http://www.w3.org/2001/XMLSchema"
  elementFormDefault="qualified">
  <xs:element name="root" type="t1"/>
  <xs:complexType name="t1">
    <xs:complexContent>
      <xs:extension base="xs:anyType">
        <xs:attribute name="a" use="required"/>
      </xs:extension>
    </xs:complexContent>
  </xs:complexType>
  <xs:complexType name="t2">
    <xs:complexContent>
      <xs:extension base="t1">

```

```

        <xs:attribute name="b" use="required"/>
    </xs:extension>
</xs:complexContent>
</xs:complexType></xs:schema>

```

New XML schema:

```

<?xml version="1.0" encoding="UTF-8"?>
<xs:schema xmlns:xs="http://www.w3.org/2001/XMLSchema"
  elementFormDefault="qualified">
  <xs:element name="root" type="t1"/>
  <xs:complexType name="t1">
    <xs:complexContent>
      <xs:extension base="xs:anyType">
        <xs:attribute name="a" use="required"/>
      </xs:extension>
    </xs:complexContent>
  </xs:complexType>
</xs:schema>

```

### Simple to complex

A complex type that contains simple content in the original XML schema cannot be redefined to contain complex content in the updated XML schema.

#### Example

Original XML schema:

```

<?xml version="1.0" encoding="UTF-8"?>
<xs:schema xmlns:xs="http://www.w3.org/2001/XMLSchema"
  elementFormDefault="qualified">
  <xs:element name="root">
    <xs:complexType>
      <xs:simpleContent>
        <xs:extension base="xs:string">
          <xs:attribute name="a" type="xs:string"/>
        </xs:extension>
      </xs:simpleContent>
    </xs:complexType>
  </xs:element>
</xs:schema>

```

New XML schema:

```

<?xml version="1.0" encoding="UTF-8"?>
<xs:schema xmlns:xs="http://www.w3.org/2001/XMLSchema"
  elementFormDefault="qualified">
  <xs:element name="root">
    <xs:complexType>
      <xs:complexContent base="xs:anyType">
        <xs:extension base="xs:anyType">
          <xs:attribute name="a" type="xs:string"/>
        </xs:extension>
      </xs:complexContent>
    </xs:complexType>
  </xs:element>
</xs:schema>

```

### Simple content

Simple types defined in the original XML schema and in the new XML schema must share the same base types.

#### Example

Original XML schema:

```

<?xml version="1.0" encoding="UTF-8"?>
<xs:schema xmlns:xs="http://www.w3.org/2001/XMLSchema"
  elementFormDefault="qualified">
  <xs:element name="foo" >
    <xs:simpleType>

```

```

        <xs:restriction base="xs:decimal" />
    </xs:simpleType>
</xs:element>
</xs:schema>

```

New XML schema:

```

<?xml version="1.0" encoding="UTF-8"?>
<xs:schema xmlns:xs="http://www.w3.org/2001/XMLSchema"
  elementFormDefault="qualified">
  <xs:element name="foo" >
    <xs:simpleType>
      <xs:restriction base="xs:string" />
    </xs:simpleType>
  </xs:element>
</xs:schema>

```

## Scenario: Evolving an XML schema

The following scenario demonstrates the process of evolving an XML schema registered in the XML schema repository (XSR).

Jane, the manager of a small store, maintains a database in which all of the store products are listed in a number of XML documents. These XML product lists conform to the following schema:

```

<xsd:schema xmlns:xsd="http://www.w3.org/2001/XMLSchema">
  <xsd:complexType name="prodType">
    <xsd:sequence>
      <xsd:element name="name" type="xsd:string" />
      <xsd:element name="sku" type="xsd:string" />
      <xsd:element name="price" type="xsd:integer" />
    </xsd:sequence>
    <xsd:attribute name="color" type="xsd:string" />
    <xsd:attribute name="weight" type="xsd:integer" />
  </xsd:complexType>
  <xsd:element name="products">
    <xsd:complexType>
      <xsd:sequence>
        <xsd:element name="product" type="prodType" maxOccurs="unbounded" />
      </xsd:sequence>
    </xsd:complexType>
  </xsd:element>
</xsd:schema>

```

The XML schema was initially registered in the XSR using the commands:

```

REGISTER XMLSCHEMA 'http://product'
FROM 'file://c:/schemas/prod.xsd'
AS STORE.PROD
COMPLETE XMLSCHEMA STORE.PROD

```

After the XML schema was registered, the XML-formatted product lists were validated against it and inserted into the store database.

Jane decides that it would be better if the lists contained a description along with the name, stock keeping unit (SKU) and price of each product. Rather than create a new XML schema and have to re-validate all of the existing XML documents against it, Jane would prefer to update the original XML schema to accommodate the added product descriptions. A new "description" element needs to be added into the original XML schema:



```

<xsd:complexType name="prodType">
  <xsd:sequence>
    <xsd:element name="name" type="xsd:string" />
    <xsd:element name="sku" type="xsd:string" />
    <xsd:element name="price" type="xsd:integer" />
    <xsd:element name="description" type="xsd:string" minOccurs="0" />
  </xsd:sequence>
  <xsd:attribute name="color" type="xsd:string" />
  <xsd:attribute name="weight" type="xsd:integer" />
</xsd:complexType>

```

In the XML schema segment to insert, the "minOccurs" attribute is set to "0". This is important, for otherwise "description" would become a mandatory element as part of the content model, and all of the existing XML documents that were validated against the original schema and inserted into the database tables would no longer be in a valid state. To evolve an XML schema, the original and the new version of that schema must be compatible. For details, see *Compatibility requirements for evolving an XML schema*.

Before the update can proceed, the new XML schema needs to be registered in the XSR:

```

REGISTER XMLSCHEMA 'http://newproduct'
FROM 'file://c:/schemas/newprod.xsd'
AS STORE.NEWPROD
COMPLETE XMLSCHEMA STORE.NEWPROD

```

Jane now performs the update using the XSR\_UPDATE stored procedure:

```

CALL SYSPROC.XSR_UPDATE(
  'STORE',
  'PROD',
  'STORE',
  'NEWPROD',
  1)

```

The original XML schema is evolved. All of the external dependencies managed in the XSR for XML instance documents that were previously validated against the XML schema STORE.PROD are updated based on the contents of the XML schema STORE.NEWPROD. Because the *dropnewschema* parameter is set by passing a non-zero value, the new schema STORE.NEWPROD is dropped after the original schema is updated.

Any existing XML documents that have already been validated against the original XML schema are not validated again as a result of the update procedure. Instead, a check is performed during the update to confirm that the original and new XML schemas are compatible, thereby ensuring that any documents previously validated against the original XML schema will also be valid against the new one. In the previous example, setting the "minOccurs" attribute to "0" in the new "description" element is required for the two XML schemas to be compatible. Any XML documents that are inserted after the schema evolution will be validated against the newly updated version of STORE.PROD, and these documents can now contain "description" elements for each store product.

---

## Examples of extracting XML schema information

### Listing XML schemas registered with the XSR

The following examples show how XML schemas that have been fully registered with the XML schema repository can be queried for through SQL statements. Registration must have been completed before an XML schema is fully registered.

*Example 1:* List all registered XML schemas

This example returns the SQL schema and the SQL identifier of all XML schemas registered with the XSR.

```
SELECT OBJECTNAME, OBJECTSCHEMA
FROM SYSCAT.XSROBJECTS
WHERE OBJECTTYPE='S' AND STATUS='C'
```

*Example 2:* Return the target namespace and the schema location

This example returns the uniform resource identifiers (URIs) of the target namespaces and schema locations for all registered XML schemas (*targetNamespace* and *schemaLocation*).

```
SELECT TARGETNAMESPACE, SCHEMALOCATION
FROM SYSCAT.XSROBJECTS
WHERE OBJECTTYPE='S' AND STATUS='C'
```

*Example 3:* Return the object information document

This example returns the object information document for all registered schemas (*schemaInfo*). This XML document is generated during schema registration and describes each XML schema document that is part of an XML schema registered with the XSR.

```
SELECT OBJECTINFO
FROM SYSCAT.XSROBJECTS
WHERE OBJECTTYPE='S' AND STATUS='C'
```

### Retrieving all components of an XML schema registered with the XSR

The following examples show how all the component XML schema documents that make up a registered XML schema can be retrieved from the XML schema repository.

*Example 1:* Return the component XML schema documents of a registered XML schema, along with the target namespace and schema location (*targetNamespace* and *schemaLocation*):

```
SELECT COMPONENT, TARGETNAMESPACE, SCHEMALOCATION
FROM SYSCAT.XSROBJECTCOMPONENTS
WHERE OBJECTSCHEMA = ? AND OBJECTNAME = ?
```

The component XML schema documents are returned as BLOB values.

*Example 2:* Return the XML schema document of a registered XML schema with the object name of CUSTOMER. When run against the SAMPLE database, the statement returns the XML schema document that is used to validate the XML documents in the INFO column of the CUSTOMER table:

```
SELECT XMLPARSE(document COMPONENT) FROM SYSCAT.XSROBJECTCOMPONENTS
WHERE OBJECTNAME = 'CUSTOMER'
```

The XML schema document is returned as an XML value.

## Retrieving the XML schema of an XML document

The following example shows how the XML schema associated with an XML document can be retrieved from the XML schema repository.

*Example 1:* Retrieve the object ID of the XML schema of an XML document:

```
SELECT DOC, XMLXSROBJECTID(DOC)
FROM T
```

*Example 2:* Retrieve the object ID and the two-part SQL identifier of the XML schema of an XML document:

```
SELECT XMLXSROBJECTID(DOC),
       CAT.OBJECTSCHEMA, CAT.OBJECTNAME
FROM T, SYSCAT.XSROBJECTS AS CAT
WHERE XMLXSROBJECTID(DOC) = CAT.OBJECTID
```



---

## Chapter 9. XML data movement

Support for XML data movement is provided by the load, import and export utilities. Support for moving tables that contain XML columns without taking the tables offline is provided by the ADMIN\_MOVE\_TABLE stored procedure.

### Importing XML data

The import utility can be used to insert XML documents into a regular relational table. Only well-formed XML documents can be imported.

Use the XML FROM option of the IMPORT command to specify the location of the XML documents to import. The XMLVALIDATE option specifies how imported documents should be validated. You can select to have the imported XML data validated against a schema specified with the IMPORT command, against a schema identified by a schema location hint inside of the source XML document, or by the schema identified by the XML Data Specifier in the main data file. You can also use the XMLPARSE option to specify how whitespace is handled when the XML document is imported. The xmlchar and xmlgraphic file type modifiers allow you to specify the encoding characteristics for the imported XML data.

### Loading XML data

The load utility offers an efficient way to insert large volumes of XML data into a table. This utility also allows certain options unavailable with the import utility, such as the ability to load from a user-defined cursor.

Like the IMPORT command, with the LOAD command you can specify the location of the XML data to load, validation options for the XML data, and how whitespace is handled. As with IMPORT, you can use the xmlchar and xmlgraphic file type modifiers to specify the encoding characteristics for the loaded XML data.

### Exporting XML data

Data may be exported from tables that include one or more columns with an XML data type. Exported XML data is stored in files separate from the main data file containing the exported relational data. Information about each exported XML document is represented in the main exported data file by an XML data specifier (XDS). The XDS is a string that specifies the name of the system file in which the XML document is stored, the exact location and length of the XML document inside of this file, and the XML schema used to validate the XML document.

You can use the XMLFILE, XML TO, and XMLSAVESHEMA parameters of the EXPORT command to specify details about how exported XML documents are stored. The xmlinsefiles, xmlnodeclaration, xmlchar, and xmlgraphic file type modifiers allow you to specify further details about the storage location and the encoding of the exported XML data.

### Moving tables online

The ADMIN\_MOVE\_TABLE stored procedure moves the data in an active table into a new table object with the same name, while the data remains online and available for access. The table can include one or more columns with an XML data

type. Use an online table move instead of an offline table move if you value availability more than cost, space, move performance, and transaction overhead

You can call the procedure once or multiple times, one call for each operation performed by the procedure. Using multiple calls provides you with additional options, such as cancelling the move or controlling when the target table is taken offline to be updated.

---

## Important considerations for XML data movement

There are a number of restrictions, prerequisites, and reminders to consider when importing or exporting XML data. Review these considerations before importing or exporting XML data.

Keep the following consideration in mind when exporting or importing XML data:

- Exported XML data is always stored separately from the main data file containing exported relational data.
- By default, the export utility writes XML data in Unicode. Use the `xmlchar` file type modifier to have XML data written in the character code page, or use the `xmlgraphic` file type modifier to have XML data written in UTF-16 (the graphic code page) regardless of the application code page.
- XML data can be stored in non-Unicode databases, and the data inserted into an XML column is converted from the database codepage to UTF-8 before insertion. In order to avoid the possible introduction of substitution characters during XML parsing, character data to be inserted should consist only of code points that are part of the database codepage. Setting the `enable_xmlchar` configuration parameter to `no` blocks the insertion of character data types during XML parsing, restricting insertion to data types that do not undergo codepage conversion, such as BIT DATA, BLOB, or XML.
- When importing or loading XML data, the XML data is assumed to be in Unicode unless the XML document to import contains a declaration tag that includes an encoding attribute. You can use the `xmlchar` file type modifier to indicate that XML documents to import are encoded in the character code page, while the `xmlgraphic` file type modifier indicates that XML documents to import are encoded in UTF-16.
- The import and load utilities reject rows that contain documents that are not well-formed.
- If the `XMLVALIDATE` option is specified for the import utility or the load utility, documents that successfully validate against their matching schema are annotated with information about the schema used for validation as they are inserted into a table. Rows containing documents that fail to validate against their matching schema are rejected.
- If the `XMLVALIDATE` option is specified for an import or load utility and multiple XML schemas are used to validate XML documents, you might need to increase the catalog cache size configuration parameter `catalogcache_sz`. If increasing the value of `catalogcache_sz` is not feasible or possible, you can separate the single import or load command into multiple commands that use fewer schema documents.
- When you export XML data specifying an XQuery statement, you might export Query and XPath Data Model (XDM) instances that are not well-formed XML documents. Exported XML documents that are not well-formed cannot be imported directly into an XML column, because columns defined with the XML data type can contain only complete, well formed XML documents.

- The **CPU\_PARALLELISM** setting during a load is reduced to 1 if statistics are being collected.
- An XML load operation requires the use of shared sort memory to proceed. Enable **SHEAPTHRES\_SHR** or **INTRA\_PARALLEL**, or turn on the connection concentrator. By default, **SHEAPTHRES\_SHR** is set, so shared sort memory is available on the default configuration.
- You cannot specify the **SOURCEUSEREXIT** option or **SAVECOUNT** parameter of the LOAD command when loading a table containing an XML column.
- As with LOB files, XML files have to reside on the server side when using the LOAD command.
- When loading XML data to multiple database partitions in a partitioned database environment, the files containing the XML data must be accessible to all database partitions. For example, you can copy the files or create an NFS mount to make the files accessible.

---

## Query and XPath Data Model

XML data can be accessed in a database table either by use of the XQuery functions available in SQL, or by invoking XQuery directly. An instance of the Query and XPath Data Model (XDM) can be a well-formed XML document, a sequence of nodes, a sequence of atomic values, or any combination of nodes and atomic values.

Individual XDM instances can be written to one or more XML files by means of the EXPORT command.

---

## LOB and XML file behavior when importing and exporting

LOB and XML files share certain behaviors and compatibilities that can be used when importing and exporting data.

**Export** When exporting data, if one or more LOB paths are specified with the **LOBS TO** option, the export utility will cycle between the paths to write each successive LOB value to the appropriate LOB file. Similarly, if one or more XML paths are specified with the **XML TO** option, the export utility will cycle between the paths to write each successive XQuery and XPath Data Model (XDM) instance to the appropriate XML file. By default, LOB values and XDM instances are written to the same path to which the exported relational data is written. Unless the **LOBSINSEPFILLES** or **XMLINSEPFILLES** file type modifier is set, both LOB files and XML files can have multiple values concatenated to the same file.

The **LOBFILE** option provides a means to specify the base name of the LOB files generated by the export utility. Similarly, the **XMLFILE** option provides a means to specify the base name of the XML files generated by the export utility. The default LOB file base name is the name of the exported data file, with the extension **.lob**. The default XML file base name is the name of the exported data file, with the extension **.xml**. The full name of the exported LOB file or XML file therefore consists of the base name, followed by a number extension that is padded to three digits, and the extension **.lob** or **.xml**.

### Import

When importing data, a LOB Location Specifier (LLS) is compatible with an XML target column, and an XML Data Specifier (XDS) is compatible with a LOB target column. If the **LOBS FROM** option is not specified, the

LOB files to import are assumed to reside in the same path as the input relational data file. Similarly, if the XML FROM option is not specified, the XML files to import are assumed to reside in the same path as the input relational data file.

## Export examples

In the following example, all LOB values are written to the file `/mypath/tlexport.del.001.lob`, and all XDM instances are written to the file `/mypath/tlexport.del.001.xml`:

```
EXPORT TO /mypath/tlexport.del OF DEL MODIFIED BY LOBSINFILE
SELECT * FROM USER.T1
```

In the following example, the first LOB value is written to the file `/lob1/tlexport.del.001.lob`, the second is written to the file `/lob2/tlexport.del.002.lob`, the third is appended to `/lob1/tlexport.del.001.lob`, the fourth is appended to `/lob2/tlexport.del.002.lob`, and so on:

```
EXPORT TO /mypath/tlexport.del OF DEL LOBS TO /lob1,/lob2
MODIFIED BY LOBSINFILE SELECT * FROM USER.T1
```

In the following example, the first XDM instance is written to the file `/xml1/xmlbase.001.xml`, the second is written to the file `/xml2/xmlbase.002.xml`, the third is written to `/xml1/xmlbase.003.xml`, the fourth is written to `/xml2/xmlbase.004.xml`, and so on:

```
EXPORT TO /mypath/tlexport.del OF DEL XML TO /xml1,/xml2 XMLFILE xmlbase
MODIFIED BY XMLINSEPPFILES SELECT * FROM USER.T1
```

## Import examples

For a table "mytable" that contains a single XML column, and the following IMPORT command:

```
IMPORT FROM myfile.del of del LOBS FROM /lobpath XML FROM /xmlpath
MODIFIED BY LOBSINFILE XMLCHAR replace into mytable
```

If "myfile.del" contains the following data:

```
mylobfile.001.lob.123.456/
```

The import utility will try to import an XML document from the file `/lobpath/mylobfile.001.lob`, starting at file offset 123, with its length being 456 bytes.

The file "mylobfile.001.lob" is assumed to be in the LOB path, as opposed to the XML path, since the value is referred to by a LOB Location Specifier (LLS) instead of an XML Data Specifier (XDS).

The document is assumed to be encoded in the character codepage, since the XMLCHAR file type modifier is specified.

---

## XML data specifier

XML data moved with the export, import and load utilities must be stored in files separate from the main data file. The XML data is represented in the main data file with an XML data specifier (XDS).

The XDS is a string represented as an XML tag named "XDS", which has attributes that describe information about the actual XML data in the column; such



information includes the name of the file that contains the actual XML data, and the offset and length of the XML data within that file. The attributes of the XDS are described in the following list.

- FIL** The name of the file that contains the XML data. You cannot specify a named pipe. Importing or loading XML documents from a named pipe is not supported.
- OFF** The byte offset of the XML data in the file named by the FIL attribute, where the offset begins from 0.
- LEN** The length in bytes of the XML data in the file named by the FIL attribute.
- SCH** The fully qualified SQL identifier of the XML schema that is used to validate this XML document. The schema and name components of the SQL identifier are stored as the "OBJECTSCHEMA" and "OBJECTNAME" values, respectively, of the row in the SYSCAT.XSROBJECTS catalog table that corresponds to this XML schema.

The XDS is interpreted as a character field in the data file and is subject to the parsing behavior for character columns of the file format. For the delimited ASCII file format (DEL), for example, if the character delimiter is present in the XDS, it must be doubled. The special characters <, >, &, ', " within the attribute values must always be escaped. Case-sensitive object names must be placed between &quot; character entities.

## Examples

Consider a FIL attribute with the value abc&"def".del. To include this XDS in a delimited ASCII file, where the character delimiter is the " character, the " characters are doubled and special characters are escaped.

```
<XDS FIL=""abc&amp;&quot;def&quot;;.del"" />
```

The following example shows an XDS as it would appear in a delimited ASCII data file. XML data is stored in the file xmldocs.xml.001 beginning at byte offset 100 with a length of 300 bytes. Because this XDS is within an ASCII file delimited with double quotation marks, the double quotation marks within the XDS tag itself must be doubled.

```
"<XDS FIL = ""xmldocs.xml.001"" OFF=""100"" LEN=""300"" />"
```

The following example shows the fully qualified SQL identifier ANTHONY.purchaseOrderTest. The case-sensitive portion of the identifier must be placed between &quot; character entities in the XDS:

```
"<XDS FIL='/home/db2inst1/xmlload/a.xml' OFF='0' LEN='6758'  
SCH='ANTHONY.&quot;purchaseOrderTest&quot;';' />"
```

---

## Exporting XML data

When exporting XML data, the resulting QDM (XQuery Data Model) instances are written to a file or files separate from the main data file containing exported relational data. This is true even if neither the XMLFILE nor the XML TO option is specified.

By default, exported QDM instances are all concatenated to the same XML file. You can use the XMLINSEPFILES file type modifier to specify that each QDM instance be written to a separate file.

The XML data, however, is represented in the main data file with an XML data specifier (XDS). The XDS is a string represented as an XML tag named "XDS", which has attributes that describe information about the actual XML data in the column; such information includes the name of the file that contains the actual XML data, and the offset and length of the XML data within that file.

The destination paths and base names of the exported XML files can be specified with the XML TO and XMLFILE options. If the XML TO or XMLFILE option is specified, the format of the exported XML file names, stored in the FIL attribute of the XDS, is `xmlfilespec.xxx.xml`, where `xmlfilespec` is the value specified for the XMLFILE option, and `xxx` is a sequence number for xml files produced by the export utility. Otherwise, the format of the exported XML file names is: `exportfilename.xxx.xml`, where `exportfilename` is the name of the exported output file specified for the EXPORT command, and `xxx` is a sequence number for xml files produced by the export utility.

By default, exported XML files are written to the path of the exported data file. The default base name for exported XML files is the name of the exported data file, with an appending 3-digit sequence number, and the `.xml` extension.

## Examples

For the following examples, imagine a table `USER.T1` containing four columns and two rows:

```
C1 INTEGER
C2 XML
C3 VARCHAR(10)
C4 XML
```

Table 27. `USER.T1`

C1	C2	C3	C4
2	<?xml version="1.0" encoding="UTF-8" ?><note time="12:00:00"><to>You</to><from> Me</from><heading>note1</heading><body>Hello World!</body></note>	'char1'	<?xml version="1.0" encoding="UTF-8" ?><note time="13:00:00"><to>Him</to><from> Her</from><heading>note2</heading><body>Hello World!</body></note>
4	NULL	'char2'	?xml version="1.0" encoding="UTF-8" ?><note time="14:00:00"><to>Us</to><from> Them</from><heading>note3</heading><body>Hello World!</body></note>

## Example 1

The following command exports the contents of `USER.T1` in Delimited ASCII (DEL) format to the file `"/mypath/t1export.del"`. Because the XML TO and XMLFILE options are not specified, the XML documents contained in columns C2 and C4 are written to the same path as the main exported file `"/mypath"`. The base name for these files is `"t1export.del.xml"`. The XMLSAVESHEMA option indicates that XML schema information is saved during the export procedure.

```
EXPORT TO /mypath/t1export.del OF DEL XMLSAVESHEMA SELECT * FROM USER.T1
```

The exported file `"/mypath/t1export.del"` contains:

```
2,"<XDS FIL='t1export.del.001.xml' OFF='0' LEN='144' />","char1",
"<XDS FIL='t1export.del.001.xml' OFF='144' LEN='145' />"
4,,,"char2", "<XDS FIL='t1export.del.001.xml' OFF='289'
LEN='145' SCH='S1.SCHEMA_A' />"
```

The exported XML file `"/mypath/t1export.del.001.xml"` contains:

```
<?xml version="1.0" encoding="UTF-8" ?><note time="12:00:00"><to>You</to>
<from>Me</from><heading>note1</heading><body>Hello World!</body>
</note><?xml version="1.0" encoding="UTF-8" ?><note time="13:00:00"><to>Him
</to><from>Her</from><heading>note2</heading><body>Hello World!
</body></note><?xml version="1.0" encoding="UTF-8" ?><note time="14:00:00">
<to>Us</to><from>Them</from><heading>note3</heading><body>
Hello World!</body></note>
```

## Example 2

The following command exports the contents of USER.T1 in DEL format to the file `"t1export.del"`. XML documents contained in columns C2 and C4 are written to the path `"/home/user/xmlpath"`. The XML files are named with the base name `"xmldocs"`, with multiple exported XML documents written to the same XML file. The XMLSAVESchema option indicates that XML schema information is saved during the export procedure.

```
EXPORT TO /mypath/t1export.del OF DEL XML TO /home/user/xmlpath
XMLFILE xmldocs XMLSAVESchema SELECT * FROM USER.T1
```

The exported DEL file `"/home/user/t1export.del"` contains:

```
2,"<XDS FIL='xmldocs.001.xml' OFF='0' LEN='144' />","char1",
"<XDS FIL='xmldocs.001.xml' OFF='144' LEN='145' />"
4,,,"char2", "<XDS FIL='xmldocs.001.xml' OFF='289'
LEN='145' SCH='S1.SCHEMA_A' />"
```

The exported XML file `"/home/user/xmlpath/xmldocs.001.xml"` contains:

```
<?xml version="1.0" encoding="UTF-8" ?><note time="12:00:00"><to>You</to>
<from>Me</from><heading>note1</heading><body>Hello World!</body>
</note><?xml version="1.0" encoding="UTF-8" ?><note time="13:00:00">
<to>Him</to><from>Her</from><heading>note2</heading><body>
Hello World!</body></note><?xml version="1.0" encoding="UTF-8" ?>
<note time="14:00:00"><to>Us</to><from>Them</from><heading>
note3</heading><body>Hello World!</body></note>
```

## Example 3

The following command is similar to Example 2, except that each exported XML document is written to a separate XML file.

```
EXPORT TO /mypath/t1export.del OF DEL XML TO /home/user/xmlpath
XMLFILE xmldocs MODIFIED BY XMLINSEFILES XMLSAVESchema
SELECT * FROM USER.T1
```

The exported file `"/mypath/t1export.del"` contains:

```
2,"<XDS FIL='xmldocs.001.xml' />","char1", "<XDS FIL='xmldocs.002.xml' />"
4,,,"char2", "<XDS FIL='xmldocs.004.xml' SCH='S1.SCHEMA_A' />"
```

The exported XML file `"/home/user/xmlpath/xmldocs.001.xml"` contains:

```
<?xml version="1.0" encoding="UTF-8" ?><note time="12:00:00"><to>You</to>
<from>Me</from><heading>note1</heading><body>Hello World!</body>
</note>
```

The exported XML file `"/home/user/xmlpath/xmldocs.002.xml"` contains:

```
?xml version="1.0" encoding="UTF-8" ?>note time="13:00:00">to>Him/to>
from>Her/from>heading>note2/heading>body>Hello World!/body>
/note>
```

The exported XML file `"/home/user/xmlpath/xmldocs.004.xml"` contains:

```
<?xml version="1.0" encoding="UTF-8" ?><note time="14:00:00"><to>Us</to>
<from>Them</from><heading>note3</heading><body>Hello World!</body>
</note>
```

## Example 4

The following command writes the result of an XQuery to an XML file.

```
EXPORT TO /mypath/t1export.del OF DEL XML TO /home/user/xmlpath
XMLFILE xmldocs MODIFIED BY XMLNODEDECLARATION select
xmlquery( '$m/note/from/text()' passing by ref c4 as "m" returning sequence)
from USER.T1
```

The exported DEL file `"/mypath/t1export.del"` contains:

```
"<XDS FIL='xmldocs.001.xml' OFF='0' LEN='3' />"
"<XDS FIL='xmldocs.001.xml' OFF='3' LEN='4' />"
```

The exported XML file `"/home/user/xmlpath/xmldocs.001.xml"` contains:

```
HerThem
```

**Note:** The result of this particular XQuery does not produce well-formed XML documents. Therefore, the file exported in this example, could not be directly imported into an XML column.

---

## Importing XML data

The import utility can be used to import XML data into an XML table column using either the table name or a nickname for a DB2 Database for Linux, UNIX, and Windows source data object.

When importing data into an XML table column, you can use the XML FROM option to specify the paths of the input XML data file or files. For example, for an XML file `"/home/user/xmlpath/xmldocs.001.xml"` that had previously been exported, the following command could be used to import the data back into the table.

```
IMPORT FROM t1export.del OF DEL XML FROM /home/user/xmlpath INSERT INTO USER.T1
```

## Validating inserted documents against schemas

The XMLVALIDATE option allows XML documents to be validated against XML schemas as they are imported. In the following example, incoming XML documents are validated against schema information that was saved when the XML documents were exported:

```
IMPORT FROM t1export.del OF DEL XML FROM /home/user/xmlpath XMLVALIDATE
USING XDS INSERT INTO USER.T1
```

## Specifying parse options

You can use the XMLPARSE option to specify whether whitespace in the imported XML documents is preserved or stripped. In the following example, all imported

XML documents are validated against XML schema information that was saved when the XML documents were exported, and these documents are parsed with whitespace preserved.

```
IMPORT FROM t1export.del OF DEL XML FROM /home/user/xmlpath XMLPARSE PRESERVE
WHITESPACE XMLVALIDATE USING XDS INSERT INTO USER.T1
```

---

## Loading XML data

The load utility can be used for the efficient movement of large volumes of XML data into tables.

When loading data into an XML table column, you can use the XML FROM option to specify the paths of the input XML data file or files. For example, to load data from an XML file /home/user/xmlpath/xmlfile1.xml you could use the following command:

```
LOAD FROM data1.del OF DEL XML FROM /home/user/xmlpath INSERT INTO USER.T1
```

The delimited ASCII input file data1.del contains an XML data specifier (XDS) that describes the location of the XML data to load. For example, the following XDS describes an XML document at offset 123 bytes in file xmldata.ext that is 456 bytes in length:

```
<XDS FIL='xmldata.ext' OFF='123' LEN='456' />
```

Loading XML data using a declared cursor is supported. The following example declares a cursor and uses the cursor and the **LOAD** command to add data from the table CUSTOMERS into the table LEVEL1\_CUSTOMERS:

```
DECLARE cursor_income_level1 CURSOR FOR
  SELECT * FROM customers
  WHERE XMLEXISTS('$DOC/customer[income_level=1]');

LOAD FROM cursor_income_level1 OF CURSOR INSERT INTO level1_customers;
```

The ANYORDER file type modifier of the **LOAD** command is supported for loading XML data into an XML column.

During load, distribution statistics are not collected for columns of type XML.

### Loading XML data in a partitioned database environment

For tables that are distributed among database partitions, you can load XML data from XML data files into the tables in parallel. When loading XML data from files into tables, the XML data files must be read-accessible to all the database partitions where loading is taking place

### Validating inserted documents against schemas

The XMLVALIDATE option allows XML documents to be validated against XML schemas as they are loaded. In the following example, incoming XML documents are validated against the schema identified by the XDS in the delimited ASCII input file data2.del:

```
LOAD FROM data2.del OF DEL XML FROM /home/user/xmlpath XMLVALIDATE
USING XDS INSERT INTO USER.T2
```

In this case, the XDS contains an SCH attribute with the fully qualified SQL identifier of the XML schema to use for validation, "S1.SCHEMA\_A":

```
<XDS FIL='xmldata.ext' OFF='123' LEN='456' SCH='S1.SCHEMA_A' />
```

## Specifying parse options

You can use the XMLPARSE option to specify whether whitespace in the loaded XML documents is preserved or stripped. In the following example, all loaded XML documents are validated against the schema with SQL identifier "S2.SCHEMA\_A" and these documents are parsed with whitespace preserved:

```
LOAD FROM data2.del OF DEL XML FROM /home/user/xmlpath XMLPARSE PRESERVE  
WHITESPACE XMLVALIDATE USING SCHEMA S2.SCHEMA_A INSERT INTO USER.T1
```

## Resolving indexing errors when loading XML data

Load operations that fail due to indexing errors can be resolved using the **db2diag** log file and the import utility together to identify and correct problem values in the XML data.

### About this task

If a load operation returns the error message SQL20305N (sqlcode -20305), this indicates that one or more XML node values could not be indexed. The error message will output the reason code for the error. Enter ? SQL20305N in the command line processor to look up the explanation and user response for the corresponding reason code.

For indexing problems during insert operations, a generated XQuery statement is output to the **db2diag** log file to help locate the failing XML node values within the document. See "Common XML indexing issues" for details about how to use the XQuery statement to locate the failing XML node values.

For indexing problems during load operations, however, the generated XQuery statements are not output to the **db2diag** log file. To generate these XQuery statements the import utility must be run on the failing rows that were not loaded. Because the rejected rows do not exist in the table, the XQuery statements cannot be run on the failing documents. To solve this problem, a new table with the same definition must be created without any indexes. The failing rows can then be loaded into the new table, and the XQuery statements can then be run on the new table to locate the failing XML node values within the documents.

Perform the following steps to resolve the indexing errors:

### Procedure

1. Determine which rows were rejected during the load operation using the record numbers in the output information.
2. Create a .del file containing only the rejected rows.
3. Create a new table (for example, T2) with the same columns as the original table (T1). Do not create any indexes on the new table.
4. Load the rejected rows into the new table T2.
5. For each rejected row in the original table T1:
  - a. Import the rejected rows to T1 to get the SQL20305N message. The import will stop on the first error that it encounters.
  - b. Look in the **db2diag** log file and get the generated XQuery statement. To find the failing node values in the input document, search for the string 'SQL20305N' in the **db2diag** log file and match the reason code number. Following the reason code, you will find a set of instructions and then a generated XQuery statement that you can use to locate the problem value in the document that caused the error.

- c. Modify the XQuery statement to use the new table T2.
- d. Run the XQuery statement on T2 to locate the problem value in the document.
- e. Fix the problem value in the .xml file containing the document.
- f. Return to Step a and import the rejected rows to T1 again. The row that caused the import to stop should now be inserted successfully. If there is another rejected row in the .del file, the import utility will stop on the next error and output another SQL20305N message. Continue these steps until the import runs successfully.

## Example

In the following example, the index BirthdateIndex has been created on the *date* data type. The REJECT INVALID VALUES option is specified, so the XML pattern values for */Person/Confidential/Birthdate* must all be valid for the *date* data type. If any XML pattern value cannot be cast to this data type, an error is returned.

Using the following XML documents, five rows are supposed to be loaded but the first and the fourth rows will be rejected because the Birthdate values cannot be indexed. In the file *person1.xml*, the value *March 16, 2002* is not in the correct date format. In the file *person4.xml*, the value *20000-12-09* has an extra zero for the year, so it is a valid XML date value but it is outside of the range that DB2 allows for a year (0001 to 9999). Some of the sample output has been edited to make the example more concise.

The five XML files to load are as follows:

*person1.xml* (Birthdate value is not valid)

```
<?xml version="1.0"?>
<Person gender="Male">
  <Name>
    <Last>Cool</Last>
    <First>Joe</First>
  </Name>
  <Confidential>
    <Age unit="years">5</Age>
    <Birthdate>March 16, 2002</Birthdate>
    <SS>111-22-3333</SS>
  </Confidential>
  <Address>5224 Rose St. San Jose, CA 95123</Address>
</Person>
```

*person2.xml* (Birthdate value is valid)

```
<?xml version="1.0"?>
<Person gender="Male">
  <Name>
    <Last>Cool</Last>
    <First>Joe</First>
  </Name>
  <Confidential>
    <Age unit="years">5</Age>
    <Birthdate>2002-03-16</Birthdate>
    <SS>111-22-3333</SS>
  </Confidential>
  <Address>5224 Rose St. San Jose, CA 95123</Address>
</Person>
```

*person3.xml* (Birthdate value is valid)

```

<?xml version="1.0"?>
<Person gender="Female">
  <Name>
    <Last>McCarthy</Last>
    <First>Laura</First>
  </Name>
  <Confidential>
    <Age unit="years">6</Age>
    <Birthdate>2001-03-12</Birthdate>
    <SS>444-55-6666</SS>
  </Confidential>
  <Address>5960 Daffodil Lane, San Jose, CA 95120</Address>
</Person>

```

person4.xml (Birthdate value is not valid)

```

<?xml version="1.0"?>
<Person gender="Female">
  <Name>
    <Last>Wong</Last>
    <First>Teresa</First>
  </Name>
  <Confidential>
    <Age unit="years">7</Age>
    <Birthdate>20000-12-09</Birthdate>
    <SS>555-66-7777</SS>
  </Confidential>
  <Address>5960 Tulip Court, San Jose, CA 95120</Address>
</Person>

```

person5.xml (Birthdate value is valid)

```

<?xml version="1.0"?>
<Person gender="Male">
  <Name>
    <Last>Smith</Last>
    <First>Chris</First>
  </Name>
  <Confidential>
    <Age unit="years">10</Age>
    <Birthdate>1997-04-23</Birthdate>
    <SS>666-77-8888</SS>
  </Confidential>
  <Address>5960 Dahlia Street, San Jose, CA 95120</Address>
</Person>

```

The input file person.del contains:

```

1, <XDS FIL='person1.xml' />
2, <XDS FIL='person2.xml' />
3, <XDS FIL='person3.xml' />
4, <XDS FIL='person4.xml' />
5, <XDS FIL='person5.xml' />

```

The DDL and LOAD statements are as follows:

```

CREATE TABLE T1 (docID INT, XMLDoc XML);

CREATE INDEX BirthdateIndex ON T1(xmlDoc)
  GENERATE KEY USING XMLPATTERN '/Person/Confidential/Birthdate' AS SQL DATE
  REJECT INVALID VALUES;

LOAD FROM person.del OF DEL INSERT INTO T1

```

To resolve the indexing errors that would occur when you attempt to load the set of XML files listed previously, you would perform the following steps:



1. Determine which rows were rejected during the load operation using the record numbers in the output information. In the following output, record number 1 and record number 4 were rejected.

```
SQL20305N An XML value cannot be inserted or updated because of an error
detected when inserting or updating the index identified by "IID = 3" on table
"LEECM.T1". Reason code = "5". For reason codes related to an XML schema the
XML schema identifier = "*N" and XML schema data type = "*N". SQLSTATE=23525
```

```
SQL3185W The previous error occurred while processing data from row "F0-1" of
the input file.
```

```
SQL20305N An XML value cannot be inserted or updated because of an error
detected when inserting or updating the index identified by "IID = 3" on table
"LEECM.T1". Reason code = "4". For reason codes related to an XML schema the
XML schema identifier = "*N" and XML schema data type = "*N". SQLSTATE=23525
```

```
SQL3185W The previous error occurred while processing data from row "F0-4" of
the input file.
```

```
SQL3227W Record token "F0-1" refers to user record number "1".
```

```
SQL3227W Record token "F0-4" refers to user record number "4".
```

```
SQL3107W There is at least one warning message in the message file.
```

```
Number of rows read           = 5
Number of rows skipped        = 0
Number of rows loaded         = 3
Number of rows rejected       = 2
Number of rows deleted        = 0
Number of rows committed     = 5
```

2. Create a new file reject.del with the rejected rows.

```
1, <XDS FIL='person1.xml' />
4, <XDS FIL='person4.xml' />
```

3. Create a new table T2 with the same columns as the original table T1. Do not create any indexes on the new table.

```
CREATE TABLE T2 LIKE T1
```

4. Load the rejected rows into the new table T2.

```
LOAD FROM reject.del OF DEL INSERT INTO T2;
```

5. For rejected row 1 in the original table T1:

- a. Import the rejected rows to T1 to get the -20305 message

```
IMPORT FROM reject.del OF DEL INSERT INTO T1
SQL3109N The utility is beginning to load data from file "reject.del".
```

```
SQL3306N An SQL error "-20305" occurred while inserting a row into the
table.
```

```
SQL20305N An XML value cannot be inserted or updated because of an error
detected when inserting or updating the index identified by "IID = 3" on table
"LEECM.T1". Reason code = "5". For reason codes related to an XML
schema the XML schema identifier = "*N" and XML schema data type = "*N".
SQLSTATE=23525
```

```
SQL3110N The utility has completed processing. "1" rows were read from
the input file.
```

- b. Look in the **db2diag** log file and get the generated XQuery statement.

```
FUNCTION: DB2 UDB, Xml Storage and Index Manager, xmlsDumpXQuery, probe:608
DATA #1 : String, 36 bytes
SQL Code: SQL20305N ; Reason Code: 5
DATA #2 : String, 265 bytes
To locate the value in the document that caused the error, create a
```

```

table with one XML column and insert the failing document in the table.
Replace the table and column name in the query below with the created
table and column name and execute the following XQuery.
DATA #3 : String, 247 bytes
xquery for $i in db2-fn:xmlcolumn(
  "LEECM.T1.XMLDOC") [/*:Person/*:Confidential/*:Birthdate="March 16, 2002"]
return
<Result>
  <ProblemDocument> {$i} </ProblemDocument>
  <ProblemValue>{$i/*:Person/*:Confidential/*:Birthdate/..} </ProblemValue>
</Result>;

```

- c. Modify the XQuery statement to use the new table T2.

```

xquery for $i in db2-fn:xmlcolumn(
  "LEECM.T2.XMLDOC") [/*:Person/*:Confidential/*:Birthdate="March 16, 2002"]
return
<Result>
  <ProblemDocument> {$i} </ProblemDocument>
  <ProblemValue>{$i/*:Person/*:Confidential/*:Birthdate/..} </ProblemValue>
</Result>;

```

- d. Run the XQuery statement on table T2 to locate the problem value in the document.

```

<Result><ProblemDocument><Person gender="Male">
  <Name>
    <Last>Cool</Last>
    <First>Joe</First>
  </Name>
  <Confidential>
    <Age unit="years">5</Age>
    <Birthdate>March 16, 2002</Birthdate>
    <SS>111-22-3333</SS>
  </Confidential>
  <Address>5224 Rose St. San Jose, CA 95123</Address>
</Person></ProblemDocument><ProblemValue><Confidential>
  <Age unit="years">5</Age>
  <Birthdate>March 16, 2002</Birthdate>
  <SS>111-22-3333</SS>
</Confidential></ProblemValue></Result>

```

- e. Fix the problem value in the file person1.xml containing the document. March 16, 2002 is not in the correct date format so it is changed to 2002-03-16.

```

<?xml version="1.0"?>
<Person gender="Male">
  <Name>
    <Last>Cool</Last>
    <First>Joe</First>
  </Name>
  <Confidential>
    <Age unit="years">5</Age>
    <Birthdate>2002-03-16</Birthdate>
    <SS>111-22-3333</SS>
  </Confidential>
  <Address>5224 Rose St. San Jose, CA 95123</Address>
</Person>

```

- f. Go back to step a. to import the rejected rows to table T1 again.

6. (First repetition of Step 5)

- a. Import the rejected rows to table T1. The first row is now imported successfully because two rows were read from the import file. A new error occurs on the second row.

```

IMPORT FROM reject.del OF DEL INSERT INTO T1
SQL3109N The utility is beginning to load data from file "reject.del".

```

```

SQL3306N An SQL error "-20305" occurred while inserting a row into the

```

table.

```
SQL20305N An XML value cannot be inserted or updated because of an error
detected when inserting or updating the index identified by "IID = 3" on
table "LEECM.T1". Reason code = "4". For reason codes related to an XML
schema the XML schema identifier = "*N" and XML schema data type = "*N".
SQLSTATE=23525
```

```
SQL3110N The utility has completed processing. "2" rows were read from
the input file.
```

- b. Look in the **db2diag** log file and get the generated XQuery statement.

```
FUNCTION: DB2 UDB, Xml Storage and Index Manager, xmlsDumpXQuery, probe:608
DATA #1 : String, 36 bytes
SQL Code: SQL20305N ; Reason Code: 4
DATA #2 : String, 265 bytes
To locate the value in the document that caused the error, create a
table with one XML column and insert the failing document in the table.
Replace the table and column name in the query below with the created
table and column name and execute the following XQuery.
DATA #3 : String, 244 bytes
xquery for $i in db2-fn:xmlcolumn("LEECM.T1.XMLDOC")
  [/*:Person/*:Confidential/*:Birthdate="20000-12-09"]
return
<Result>
  <ProblemDocument> {$i} </ProblemDocument>
  <ProblemValue>{$i/*:Person/*:Confidential/*:Birthdate/..} </ProblemValue>
</Result>;
```

- c. Modify the XQuery statement to use table T2.

```
xquery for $i in db2-fn:xmlcolumn("LEECM.T2.XMLDOC")
  [/*:Person/*:Confidential/*:Birthdate="20000-12-09"]
return
<Result>
  <ProblemDocument> {$i} </ProblemDocument>
  <ProblemValue>{$i/*:Person/*:Confidential/*:Birthdate/..} </ProblemValue>
</Result>;
```

- d. Run the XQuery statement to locate the problem value in the document.

```
<Result><ProblemDocument><Person gender="Female">
  <Name>
    <Last>Wong</Last>
    <First>Teresa</First>
  </Name>
  <Confidential>
    <Age unit="years">7</Age>
    <Birthdate>20000-12-09</Birthdate>
    <SS>555-66-7777</SS>
  </Confidential>
  <Address>5960 Tulip Court, San Jose, CA 95120</Address>
</Person></ProblemDocument><ProblemValue><Confidential>
  <Age unit="years">7</Age>
  <Birthdate>20000-12-09</Birthdate>
  <SS>555-66-7777</SS>
</Confidential></ProblemValue></Result>
```

- e. Fix the problem value in the file `person4.xml` containing the document. The value `20000-12-09` has an extra zero for the year so it is outside of the range that DB2 allows for a year (0001 to 9999).. The value is changed to `2000-12-09`.

```
<?xml version="1.0"?>
<Person gender="Female">
  <Name>
    <Last>Wong</Last>
    <First>Teresa</First>
  </Name>
  <Confidential>
```

```
<Age unit="years">7</Age>
<Birthdate>2000-12-09</Birthdate>
<SS>555-66-7777</SS>
</Confidential>
<Address>5960 Tulip Court, San Jose, CA 95120</Address>
</Person>
```

f. Go back to step a to import the rejected rows to T1 again.

7. (Second repetition of Step 5)

a. Import the rejected rows to T1.

```
IMPORT FROM reject.del OF DEL INSERT INTO T1
SQL3109N The utility is beginning to load data from file "reject.del".

SQL3110N The utility has completed processing. "2" rows were read from
the input file.

SQL3221W ...Begin COMMIT WORK. Input Record Count = "2".

SQL3222W ...COMMIT of any database changes was successful.

SQL3149N "2" rows were processed from the input file. "2" rows were
successfully inserted into the table. "0" rows were rejected.

Number of rows read           = 2
Number of rows skipped        = 0
Number of rows inserted       = 2
Number of rows updated        = 0
Number of rows rejected       = 0
Number of rows committed     = 2
```

The problem is now resolved. All of the rows of person.del are successfully inserted into table T1.

---

## Chapter 10. Application programming language support

You can write applications to store XML data in DB2 databases tables, retrieve data from tables, or call stored procedures or user-defined functions with XML parameters.

You can use any of the following languages to write your applications:

- C or C++ (embedded SQL or CLI)
- COBOL
- Java (JDBC or SQLJ)
- C# and Visual Basic (IBM Data Server Provider for .NET)
- PHP
- Perl

An application program can retrieve an entire document or a fragment of a document from an XML column. However, you can store only an entire document in an XML column.

Stored procedures and user-defined functions can pass XML values in input or output parameters. XML data is materialized when passed to stored procedures as IN, OUT, or INOUT parameters. If you are using Java stored procedures, the heap size (**java\_heap\_sz** configuration parameter) might need to be increased based on the quantity and size of XML arguments, and the number of external stored procedures that are being executed concurrently. To call a stored procedure or user-defined function that has XML or XML AS CLOB parameters, execute a CALL statement with compatible data types.

When an application provides an XML value to a DB2 database server, the database server converts the data from the XML serialized string format to the XML hierarchical format, in Unicode UTF-8 encoding.

When an application retrieves data from XML columns, the DB2 database server converts the data from the XML hierarchical format to the XML serialized string format. In addition, the database server might need to convert the output data from UTF-8 to the application encoding.

When you retrieve XML data, you need to be aware of the effect of code page conversion on data loss. Data loss can occur when characters in the source code page cannot be represented in the target code page.

An application can retrieve an entire XML document or a sequence from an XML column.

When you fetch an entire XML document, you retrieve the document into an application variable.

When you retrieve an XML sequence, you have several choices:

- Execute an XQuery expression directly.  
To execute an XQuery expression in an application, you prepend the string 'XQUERY' to the XQuery expression, and dynamically execute the resulting string.

When you execute an XQuery expression directly, the DB2 database server returns the sequence that is the result of the XQuery statement as a result table. Each row in the result table is an item in the sequence.

- Within an SQL SELECT or single-row SELECT INTO operation, call the XMLQUERY or XMLTABLE built-in functions, passing an XQuery expression as an argument.

This technique can be used with static or dynamic SQL and any application programming language. XMLQUERY is a scalar function that returns the entire sequence in an application variable. XMLTABLE is a table function that returns each item in the sequence as a row of the result table. The columns in the result table are values from the retrieved sequence item.

## Parameter markers and host variables

Parameter markers or host variables cannot be specified anywhere in an XQuery expression, including within the SQL specified in an XQuery expression. For example, the XQuery function db2-fn:sqlquery allows you to specify an SQL fullselect with an XQuery expression to extract the detailed description for a product:

```
xquery
db2-fn:sqlquery("select description from product where pid='100-103-01'")
                /product/description/details/text()
```

You cannot specify a parameter marker or host variable in the XQuery expression, even within the fullselect. The following expression is incorrect and unsupported (it returns SQLSTATE 42610, sqlcode -418):

```
xquery
db2-fn:sqlquery("select description from product where pid=?")
                /product/description/details/text()
```

In order to pass application values to XQuery expressions, use the SQL/XML functions XMLQUERY and XMLTABLE. The PASSING clause of these functions allows you to use application values during the evaluation of the XQuery expression.

The following query shows how the previous incorrect query can be rewritten using SQL/XML to achieve an equivalent result:

```
SELECT XMLQUERY ('$descdoc/product/description/details/text()'
                 passing description as "descdoc")
FROM product
WHERE pid=?
```

---

## CLI

### XML data handling in CLI applications - Overview

CLI applications can retrieve and store XML data by using the SQL\_XML data type. This data type corresponds to the native XML data type of the DB2 database, which is used to define columns that store well-formed XML documents. You can bind the SQL\_XML type to the following C types: SQL\_C\_BINARY, SQL\_C\_CHAR, SQL\_C\_WCHAR, and SQL\_C\_DBCHAR. Use the default SQL\_C\_BINARY type, instead of character types, to avoid possible data loss or corruption, which could result from code page conversion when character types are used.

To store XML data in an XML column, bind a binary (SQL\_C\_BINARY) or character (SQL\_C\_CHAR, SQL\_C\_WCHAR, or SQL\_C\_DBCHAR) buffer that

contains the XML value to the SQL\_XML SQL type and execute the INSERT or UPDATE SQL statements. To retrieve XML data from the database, bind the result set to a binary (SQL\_C\_BINARY) or character (SQL\_C\_CHAR, SQL\_C\_WCHAR, or SQL\_C\_DBCHAR) type. You should use character types with caution because of encoding issues.

When an XML value is retrieved into an application data buffer, the DB2 server performs an implicit serialization on the XML value to convert it from its stored hierarchical form to the serialized string form. For character-typed buffers, the XML value is implicitly serialized to the application character code page that is associated with the character type.

By default, an XML declaration is included in the output serialized string. You can change this default behavior by setting the SQL\_ATTR\_XML\_DECLARATION statement or connection attribute, or by setting the XMLDeclaration CLI/ODBC configuration keyword in the db2cli.ini file.

You can issue and execute XQuery expressions and SQL/XML functions in CLI applications. SQL/XML functions are issued and executed like any other SQL statements. You must add a prefix to the XQuery expressions with the not case sensitive keyword **XQUERY**, or you must set the SQL\_ATTR\_XQUERY\_STATEMENT statement attribute for the statement handle that is associated with the XQuery expression.

**Note:** Starting with DB2 Version 9.7 Fix Pack 5, the SQL\_XML data type is supported for DB2 for i V7R1 servers or later releases.

## XML column inserts and updates in CLI applications

When you update or insert data into XML columns of a table, the input data must be in the serialized string format.

For XML data, when you use SQLBindParameter() to bind parameter markers to input data buffers, you can specify the data type of the input data buffer as SQL\_C\_BINARY, SQL\_C\_CHAR, SQL\_C\_DBCHAR or SQL\_C\_WCHAR.

When you bind a data buffer that contains XML data as SQL\_C\_BINARY, CLI processes the XML data as internally encoded data. This is the preferred method because it avoids additional resource usage and potential data loss of character conversion when character types are used.

**Important:** If the XML data is encoded in an encoding scheme and CCSID other than the application code page encoding scheme, you must include internal encoding in the data and bind the data as SQL\_C\_BINARY to avoid character conversion.

When you bind a data buffer that contains XML data as SQL\_C\_CHAR, SQL\_C\_DBCHAR or SQL\_C\_WCHAR, CLI processes the XML data as externally encoded data. CLI determines the encoding of the data as follows:

- If the C type is SQL\_C\_WCHAR, CLI assumes that the data is encoded as UCS-2.
- If the C type is SQL\_C\_CHAR or SQL\_C\_DBCHAR, CLI assumes that the data is encoded in the application code page encoding scheme.

If you want the database server to implicitly parse the data before storing it in an XML column, the parameter marker data type in `SQLBindParameter()` should be specified as `SQL_XML`.

Implicit parsing is recommended, because explicit parsing of a character type with `XMLPARSE` can introduce encoding issues.

The following example shows how to update XML data in an XML column using the recommended `SQL_C_BINARY` type.

```
char xmlBuffer[10240];
integer length;

// Assume a table named dept has been created with the following statement:
// CREATE TABLE dept (id CHAR(8), deptdoc XML)

// xmlBuffer contains an internally encoded XML document that is to replace
// the existing XML document
length = strlen (xmlBuffer);
SQLPrepare (hStmt, "UPDATE dept SET deptdoc = ? WHERE id = '001'", SQL_NTS);
SQLBindParameter (hStmt, 1, SQL_PARAM_INPUT, SQL_C_BINARY, SQL_XML, 0, 0,
                  xmlBuffer, 10240, &length);
SQLExecute (hStmt);
```

## XML data retrieval in CLI applications

When you select data from XML columns in a table, the output data is in the serialized string format.

For XML data, when you use `SQLBindCol()` to bind columns in a query result set to application variables, you can specify the data type of the application variables as `SQL_C_BINARY`, `SQL_C_CHAR`, `SQL_C_DBCHAR` or `SQL_C_WCHAR`. When retrieving a result set from an XML column, it is recommended that you bind your application variable to the `SQL_C_BINARY` type. Binding to character types can result in possible data loss resulting from code page conversion. Data loss can occur when characters in the source code page cannot be represented in the target code page. Binding your variable to the `SQL_C_BINARY` C type avoids these issues.

XML data is returned to the application as internally encoded data. CLI determines the encoding of the data as follows:

- If the C type is `SQL_C_BINARY`, CLI returns the data in the UTF-8 encoding scheme.
- If the C type is `SQL_C_CHAR` or `SQL_C_DBCHAR`, CLI returns the data in the application code page encoding scheme.
- If the C type is `SQL_C_WCHAR`, CLI returns the data in the UCS-2 encoding scheme.

The database server performs an implicit serialization of the data before returning it to the application. You can explicitly serialize the XML data to a specific data type by calling the `XMLSERIALIZE` function. Implicit serialization is recommended, however, because explicitly serializing to character types with `XMLSERIALIZE` can introduce encoding issues.

The following example shows how to retrieve XML data from an XML column into a binary application variable.

```
char xmlBuffer[10240];
// xmlBuffer is used to hold the retrieved XML document
integer length;
```



```

// Assume a table named dept has been created with the following statement:
// CREATE TABLE dept (id CHAR(8), deptdoc XML)

length = sizeof (xmlBuffer);
SQLExecute (hStmt, "SELECT deptdoc FROM dept WHERE id='001'", SQL_NTS);
SQLBindCol (hStmt, 1, SQL_C_BINARY, xmlBuffer, &length, NULL);
SQLFetch (hStmt);
SQLCloseCursor (hStmt);
// xmlBuffer now contains a valid XML document encoded in UTF-8

```

## Changing of default XML type handling in CLI applications

CLI supports CLI/ODBC configuration keywords that provide compatibility for applications that do not expect the default types returned when describing or specifying `SQL_C_DEFAULT` for XML columns and parameter markers. Older CLI and ODBC applications might not recognize or expect the default `SQL_XML` type when describing XML columns or parameters. Some CLI or ODBC applications might also expect a default type other than `SQL_C_BINARY` for XML columns and parameter markers. To provide compatibility for these types of applications, CLI supports the `MapXMLDescribe` and `MapXMLCDefault` keywords.

`MapXMLDescribe` specifies which SQL data type is returned when XML columns or parameter markers are described.

`MapXMLCDefault` specifies the C type that is used when `SQL_C_DEFAULT` is specified for XML columns and parameter markers in CLI functions.

---

## Embedded SQL

### Declaring XML host variables in embedded SQL applications

To exchange XML data between the database server and an embedded SQL application, you need to declare host variables in your application source code.

#### About this task

DB2 V9.1 introduces an XML data type that stores XML data in a structured set of nodes in a tree format. Columns with this XML data type are described as an `SQL_TYP_XML` column `SQLTYPE`, and applications can bind various language-specific data types for input to and output from these columns or parameters. XML columns can be accessed directly using SQL, the SQL/XML extensions, or XQuery. The XML data type applies to more than just columns. Functions can have XML value arguments and produce XML values as well. Similarly, stored procedures can take XML values as both input and output parameters. Finally, XQuery expressions produce XML values regardless of whether they access XML columns.

XML data is character in nature and has an encoding that specifies the character set used. The encoding of XML data can be determined externally, derived from the base application type containing the serialized string representation of the XML document. It can also be determined internally, which requires interpretation of the data. For Unicode encoded documents, a byte order mark (BOM), consisting of a Unicode character code at the beginning of a data stream is recommended. The BOM is used as a signature that defines the byte order and Unicode encoding form.

Existing character and binary types, which include CHAR, VARCHAR, CLOB, and BLOB may be used in addition to XML host variables for fetching and inserting data. However, they will not be subject to implicit XML parsing, as XML host variables would. Instead, an explicit XMLPARSE function with default white space stripping is injected and applied.

XML and XQuery restrictions on developing embedded SQL applications

To declare XML host variables in embedded SQL applications:

In the declaration section of the application, declare the XML host variables as LOB data types:

- SQL TYPE IS XML AS CLOB(n) <hostvar\_name>  
  
where <hostvar\_name> is a CLOB host variable that contains XML data encoded in the mixed code page of the application.
- SQL TYPE IS XML AS DBCLOB(n) <hostvar\_name>  
  
where <hostvar\_name> is a DBCLOB host variable that contains XML data encoded in the application graphic code page.
- SQL TYPE IS XML AS BLOB(n) <hostvar\_name>  
  
where <hostvar\_name> is a BLOB host variable that contains XML data internally encoded<sup>1</sup>.
- SQL TYPE IS XML AS CLOB\_FILE <hostvar\_name>  
  
where <hostvar\_name> is a CLOB file that contains XML data encoded in the application mixed code page.
- SQL TYPE IS XML AS DBCLOB\_FILE <hostvar\_name>  
  
where <hostvar\_name> is a DBCLOB file that contains XML data encoded in the application graphic code page.
- SQL TYPE IS XML AS BLOB\_FILE <hostvar\_name>  
  
where <hostvar\_name> is a BLOB file that contains XML data internally encoded<sup>1</sup>.

**Note:**

1. Refer to the algorithm for determining encoding with XML 1.0 specifications (<http://www.w3.org/TR/REC-xml/#sec-guessing-no-ext-info>).

## Example: Referencing XML host variables in embedded SQL applications

The following sample applications demonstrate how to reference XML host variables in C and COBOL.

## Example: Embedded SQL C application:

The following code example has been formatted for clarity:

```
EXEC SQL BEGIN DECLARE;
  SQL TYPE IS XML AS CLOB( 10K ) xmlBuf;
  SQL TYPE IS XML AS BLOB( 10K ) xmlblob;
  SQL TYPE IS CLOB( 10K ) clobBuf;
EXEC SQL END DECLARE SECTION;

// as XML AS CLOB
// The XML value written to xmlBuf will be prefixed by an XML declaration
// similar to: <?xml version = "1.0" encoding = "ISO-8859-1" ?>
// Note: The encoding name will depend upon the application codepage
EXEC SQL SELECT xmlCol INTO :xmlBuf
  FROM myTable
  WHERE id = '001';
EXEC SQL UPDATE myTable
  SET xmlCol = :xmlBuf
  WHERE id = '001';

// as XML AS BLOB
// The XML value written to xmlblob will be prefixed by an XML declaration
// similar to: <?xml version = "1.0" encoding = "UTF-8"?>
EXEC SQL SELECT xmlCol INTO :xmlblob
  FROM myTable
  WHERE id = '001';
EXEC SQL UPDATE myTable
  SET xmlCol = :xmlblob
  WHERE id = '001';

// as CLOB
// The output will be encoded in the application character codepage,
// but will not contain an XML declaration
EXEC SQL SELECT XMLSERIALIZE (xmlCol AS CLOB(10K)) INTO :clobBuf
  FROM myTable
  WHERE id = '001';
EXEC SQL UPDATE myTable
  SET xmlCol = XMLPARSE (:clobBuf PRESERVE WHITESPACE)
  WHERE id = '001';
```

## Example: Embedded SQL COBOL application:

The following code example has been formatted for clarity:

```
EXEC SQL BEGIN DECLARE SECTION END-EXEC.
  01 xmlBuf USAGE IS SQL TYPE IS XML as CLOB(5K).
  01 clobBuf USAGE IS SQL TYPE IS CLOB(5K).
  01 xmlblob  USAGE IS SQL TYPE IS BLOB(5K).
EXEC SQL END DECLARE SECTION END-EXEC.

* as XML
EXEC SQL SELECT xmlCol INTO :xmlBuf
  FROM myTable
  WHERE id = '001' END-EXEC.
EXEC SQL UPDATE myTable
  SET xmlCol = :xmlBuf
  WHERE id = '001' END-EXEC.

* as BLOB
EXEC SQL SELECT xmlCol INTO :xmlblob
  FROM myTable
  WHERE id = '001' END-EXEC.
EXEC SQL UPDATE myTable
  SET xmlCol = :xmlblob
  WHERE id = '001' END-EXEC.

* as CLOB
EXEC SQL SELECT XMLSERIALIZE(xmlCol AS CLOB(10K)) INTO :clobBuf
  FROM myTable
```

```

WHERE id= '001' END-EXEC.
EXEC SQL UPDATE myTable
SET xmlCol = XMLPARSE(:clobBuf) PRESERVE WHITESPACE
WHERE id = '001' END-EXEC.

```

## Executing XQuery expressions in embedded SQL applications

### Before you begin

You can store XML data in your tables and use embedded SQL applications to access the XML columns using XQuery expressions. To access XML data, use XML host variables instead of casting the data to character or binary data types. If you do not make use of XML host variables, the best alternative for accessing XML data is with FOR BIT DATA or BLOB data types to avoid code page conversion.

- Declare XML host variables within your embedded SQL applications.

### About this task

- An XML type must be used to retrieve XML values in a static SQL SELECT INTO statement.
- If a CHAR, VARCHAR, CLOB, or BLOB host variable is used for input where an XML value is expected, the value will be subject to an XMLPARSE function operation with default white space (STRIP) handling. Otherwise, an XML host variable is required.

To issue XQuery expressions in embedded SQL application directly, prepend the expression with the "XQUERY" keyword. For static SQL use the XMLQUERY function. When the XMLQUERY function is called, the XQuery expression is not prefixed by "XQUERY".

These examples return data from the XML documents in table CUSTOMER from the sample database.

#### Example 1: Executing XQuery expressions directly in C and C++ dynamic SQL by prepending the "XQUERY" keyword

In C and C++ applications, XQuery expressions can be issued in the following way:

```

EXEC SQL INCLUDE SQLCA;
EXEC SQL BEGIN DECLARE SECTION;
char stmt[16384];
SQL TYPE IS XML AS BLOB( 10K ) xmlblob;
EXEC SQL END DECLARE SECTION;

sprintf( stmt, "XQUERY (for $a in db2-fn:xmlcolumn("CUSTOMER.INFO")
/*:customerinfo[*:addr/*:city = "Toronto"]/@Cid return data($a))");

EXEC SQL PREPARE s1 FROM :stmt;
EXEC SQL DECLARE c1 CURSOR FOR s1;
EXEC SQL OPEN c1;

while( sqlca.sqlcode == SQL_RC_OK )
{
EXEC SQL FETCH c1 INTO :xmlblob;
/* Display results */
}

EXEC SQL CLOSE c1;
EXEC SQL COMMIT;

```

#### Example 2: Executing XQuery expressions in static SQL using the XMLQUERY function and XMLEXISTS predicate

SQL statements containing the XMLQUERY function can be prepared statically, as follows:

```

EXEC SQL INCLUDE SQLCA;
EXEC SQL BEGIN DECLARE SECTION;
  SQL TYPE IS XML AS BLOB( 10K ) xmlblob;
EXEC SQL END DECLARE SECTION;

EXEC SQL DECLARE c1 CURSOR FOR SELECT XMLQUERY(data($INFO/*:customerinfo/@Cid)')
FROM customer
WHERE XMLEXISTS('$INFO/*:customerinfo[*:addr/*:city = "Toronto"]');

EXEC SQL OPEN c1;

while( sqlca.sqlcode == SQL_RC_OK )
{
  EXEC SQL FETCH c1 INTO :xmlblob;
  /* Display results */
}

EXEC SQL CLOSE c1;
EXEC SQL COMMIT;

```

### Example 3: Executing XQuery expressions in COBOL embedded SQL applications

In COBOL applications, XQuery expressions can be issued in the following way:

```

EXEC SQL BEGIN DECLARE SECTION END-EXEC.
  01 stmt pic x(80).
  01 xmlBuff USAGE IS SQL TYPE IS XML AS BLOB (10K).
EXEC SQL END DECLARE SECTION END-EXEC.

MOVE "XQUERY (for $a in db2-fn:xmlcolumn("CUSTOMER.INFO")/*:customerinfo
      [*:addr/*:city = "Toronto"]/@Cid return data($a))" TO stmt.
EXEC SQL PREPARE s1 FROM :stmt END-EXEC.
EXEC SQL DECLARE c1 CURSOR FOR s1 END-EXEC.
EXEC SQL OPEN c1 USING :host-var END-EXEC.

*Call the FETCH and UPDATE loop.
Perform Fetch-Loop through End-Fetch-Loop
  until SQLCODE does not equal 0.

EXEC SQL CLOSE c1 END-EXEC.
EXEC SQL COMMIT END-EXEC.

Fetch-Loop Section.
  EXEC SQL FETCH c1 INTO :xmlBuff END-EXEC.
  if SQLCODE not equal 0
    go to End-Fetch-Loop.
* Display results
End-Fetch-Loop. exit.

```

## Recommendations for developing embedded SQL applications with XML and XQuery

The following recommendations and restrictions apply to using XML and XQuery within embedded SQL applications.

- Applications must access all XML data in the serialized string format.
  - You must represent all data, including numeric and date time data, in its serialized string format.
- Externalized XML data is limited to 2 GB.
- All cursors containing XML data are non-blocking (each fetch operation produces a database server request).
- Whenever character host variables contain serialized XML data, the application code page is assumed to be used as the encoding of the data and must match any internal encoding that exists in the data.
- You must specify a LOB data type as the base type for an XML host variable.
- The following recommendations and restrictions apply to static SQL:
  - Character and binary host variables cannot be used to retrieve XML values from a SELECT INTO operation.
  - Where an XML data type is expected for input, the use of CHAR, VARCHAR, CLOB, and BLOB host variables will be subject to an XMLPARSE operation with

default whitespace handling characteristics ('STRIP WHITESPACE'). Any other non-XML host variable type will be rejected.

- There is no support for static XQuery expressions; attempts to precompile an XQuery expression will fail with an error. You can only issue XQuery expressions through the XMLQUERY function.
- An XQuery expression can be dynamically issued by pre-pending the expression with the string "XQUERY".

## Identifying XML values in an SQLDA

To indicate that a base type holds XML data, the sqlname field of the SQLVAR must be updated as follows:

- sqlname.length must be 8
- The first two bytes of sqlname.data must be X'0000'
- The third and fourth bytes of sqlname.data must be X'0000'
- The fifth byte of sqlname.data must be X'01' (referred to as the XML subtype indicator only when the first two conditions are met)
- The remaining bytes must be X'000000'

If the XML subtype indicator is set in an SQLVAR whose SQLTYPE is non-LOB, an SQL0804 error (rc=115) will be returned at runtime.

**Note:** SQL\_TYP\_XML can only be returned from the DESCRIBE statement. This type cannot be used for any other requests. The application must modify the SQLDA to contain a valid character or binary type, and set the sqlname field appropriately to indicate that the data is XML.

---

## Java

### Binary XML format in Java applications

Starting with Version 4.9 or later releases, the IBM Data Server Driver for JDBC and SQLJ can send XML data to the data server or retrieve XML data from the data server as binary XML data (data that is in the Extensible Dynamic Binary XML DB2 Client/Server Binary XML Format) provided that the data server supports binary XML data.

The IBM Data Server Driver for JDBC and SQLJ provides the xmlFormat property in the DriverManager and DataSource interfaces to control whether the data transfer is in textual XML format or binary XML format. Setting xmlFormat to XML\_FORMAT\_BINARY enables binary XML format. If the data server supports binary XML format, XML\_FORMAT\_BINARY is the default format. Otherwise, XML\_FORMAT\_TEXTUAL is the default. The format of XML data is transparent to the application. Storage and retrieval of binary XML data requires version 4.9 or later of the IBM Data Server Driver for JDBC and SQLJ. If you are using binary XML data in SQLJ applications, you also need version 4.9 or later of the sqlj4.zip package.

The following example shows the statements to set data transmission to binary XML format using the DataSource interface:

```
import com.ibm.db2.jcc.DB2SimpleDataSource;
...
DB2SimpleDataSource ds = new DB2SimpleDataSource();
ds.setXmlFormat(DB2BaseDataSource.XML_FORMAT_BINARY);
```

To set data transmission to textual XML format, you can use a statement such as this:

```
ds.setXmlFormat(DB2BaseDataSource.XML_FORMAT_TEXTUAL);
```

There is no setXXX method defined in the Connection interface for the xmlFormat property. Therefore, to set the xmlFormat value using the Connection interface, you need to specify xmlFormat as a property when you execute the DriverManager.getConnection method as shown in the following example:

```
properties.put("xmlFormat", DB2BaseDataSource.XML_FORMAT_BINARY);
DriverManager.getConnection(url, properties);
```

The IBM Data Server Driver for JDBC and SQLJ presents binary XML data to the application only through XML object interfaces. The user does not see the data in the binary XML format.

When binary XML data is used, the XML data that is passed to the IBM Data Server Driver for JDBC and SQLJ cannot refer to external entities, internal entities, or internal DTDs. External DTDs are supported only if those DTDs were previously registered in the data source.

Binary XML format is most efficient for cases in which the input or output data is in a non-textual representation, such as SAX, StAX, or DOM. For example, these methods retrieve XML data in non-textual representations:

- getSource(SAXSource.class)
- getSource(StAXSource.class)
- getSource(DOMSource.class)

These methods update XML columns with data in non-textual representations:

- setResult(SAXResult.class)
- setResult(StAXResult.class)
- setResult(DOMResult.class)

The SAX representation is the most efficient way to retrieve data that is in the binary XML format because the data does not undergo extra conversions from binary format to textual format.

Suppose that you set xmlFormat to XML\_FORMAT\_BINARY (1). In the following JDBC example, the IBM Data Server Driver for JDBC and SQLJ retrieves data in the binary XML format, application uses the SAX parser to parse the retrieved data.

```
...
Statement stmt = conn.createStatement();
ResultSet rs = stmt.executeQuery("SELECT XMLCOL FROM XMLTABLE");
ContentHandler handler = new MyContentHandler();
while (rs.next()) {
    SQLXML sqlxml = rs.getSQLXML(1);
    SAXSource source = sqlxml.getSource(SAXSource.class);
    XMLReader reader = source.getXMLReader();
    reader.setContentHandler(handler);
    reader.parse(source.getInputSource());
}
...
```

The following SQLJ example performs the same actions.

```
#sql iterator SqlXmlIter(java.sql.SQLXML);
{
    ...
    SqlXmlIter SQLXMLiter = null;
```

```

java.sql.SQLXML outSqlXml = null;
ContentHandler handler = new MyContentHandler();
#sql [ctx] SQLXmlIter = {SELECT XMLCOL FROM XMLTABLE};
#sql {FETCH :SqlXmlIter INTO :outSqlXml};
while (!SQLXMLIter.endFetch()) {
    SAXSource source = outSqlXml.getSource(SAXSource.class);
    XMLReader reader = source.getXMLReader();
    reader.setContentHandler(handler);
    reader.parse(source.getInputSource());
    #sql {FETCH :SqlXmlIter INTO :outSqlXml};
}
...
}

```

## JDBC

### XML data in JDBC applications

In JDBC applications, you can store data in XML columns and retrieve data from XML columns.

In database tables, the XML built-in data type is used to store XML data in a column as a structured set of nodes in a tree format.

JDBC applications can send XML data to the data server or retrieve XML data from the data server in one of the following forms:

- As textual XML data
- As binary XML data, if the data server supports it

In JDBC applications, you can:

- Store an entire XML document in an XML column using setXXX methods.
- Retrieve an entire XML document from an XML column using getXXX methods.
- Retrieve a sequence from a document in an XML column by using the SQL XMLQUERY function to retrieve the sequence into a serialized sequence in the database, and then using getXXX methods to retrieve the data into an application variable.
- Retrieve a sequence from a document in an XML column by using an XQuery expression, prepended with the string 'XQUERY', to retrieve the elements of the sequence into a result table in the database, in which each row of the result table represents an item in the sequence. Then use getXXX methods to retrieve the data into application variables.
- Retrieve a sequence from a document in an XML column as a user-defined table by using the SQL XMLTABLE function to define the result table and retrieve it. Then use getXXX methods to retrieve the data from the result table into application variables.

JDBC 4.0 java.sql.SQLXML objects can be used to retrieve and update data in XML columns. Invocations of metadata methods, such as ResultSetMetaData.getColumnTypeName return the integer value java.sql.Types.SQLXML for an XML column type.

### XML column updates in JDBC applications

In a JDBC application, you can update or insert data into XML columns of a table at a DB2 data server using XML textual data. You can update or insert data into XML columns of a table using binary XML data (data that is in the Extensible Dynamic Binary XML DB2 Client/Server Binary XML Format), if the data server supports binary XML data.



The following table lists the methods and corresponding input data types that you can use to put data in XML columns.

Table 28. Methods and data types for updating XML columns

Method	Input data type
PreparedStatement.setAsciiStream	InputStream
PreparedStatement.setBinaryStream	InputStream
PreparedStatement.setBlob	Blob
PreparedStatement.setBytes	byte[]
PreparedStatement.setCharacterStream	Reader
PreparedStatement.setClob	Clob
PreparedStatement.setObject	byte[], Blob, Clob, SQLXML, DB2Xml (deprecated), InputStream, Reader, String
PreparedStatement.setSQLXML <sup>1</sup>	SQLXML
PreparedStatement.setString	String

**Note:**

1. This method requires JDBC 4.0 or later.

The encoding of XML data can be derived from the data itself, which is known as *internally encoded* data, or from external sources, which is known as *externally encoded* data. XML data that is sent to the database server as binary data is treated as internally encoded data. XML data that is sent to the data source as character data is treated as externally encoded data.

External encoding for Java applications is always Unicode encoding.

Externally encoded data can have internal encoding. That is, the data might be sent to the data source as character data, but the data contains encoding information. The data source handles incompatibilities between internal and external encoding as follows:

- If the data source is DB2 Database for Linux, UNIX, and Windows, the database source generates an error if the external and internal encoding are incompatible, unless the external and internal encoding are Unicode. If the external and internal encoding are Unicode, the database source ignores the internal encoding.
- If the database source is DB2 for z/OS<sup>®</sup>, the database source ignores the internal encoding.

Data in XML columns is stored in UTF-8 encoding. The database source handles conversion of the data from its internal or external encoding to UTF-8.

**Example:** The following example demonstrates inserting data from an SQLXML object into an XML column. The data is String data, so the database source treats the data as externally encoded.

```
public void insertSQLXML()
{
    Connection con = DriverManager.getConnection(url);
    SQLXML info = con.createSQLXML();
                                // Create an SQLXML object
    PreparedStatement insertStmt = null;
    String infoData =
        "<customerinfo xmlns=\""http://posample.org" " +
```

```

        "Cid="1000">...</customerinfo>";
info.setString(infoData);
        // Populate the SQLXML object
int cid = 1000;
try {
    sqls = "INSERT INTO CUSTOMER (CID, INFO) VALUES (?, ?)";
    insertStmt = con.prepareStatement(sqls);
    insertStmt.setInt(1, cid);
    insertStmt.setSQLXML(2, info);
        // Assign the SQLXML object value
        // to an input parameter
    if (insertStmt.executeUpdate() != 1) {
        System.out.println("insertSQLXML: No record inserted.");
    }
}
catch (IOException ioe) {
    ioe.printStackTrace();
}
catch (SQLException sqle) {
    System.out.println("insertSQLXML: SQL Exception: " +
        sqle.getMessage());
    System.out.println("insertSQLXML: SQL State: " +
        sqle.getSQLState());
    System.out.println("insertSQLXML: SQL Error Code: " +
        sqle.getErrorCode());
}
}
}

```

**Example:** The following example demonstrates inserting data from a file into an XML column. The data is inserted as binary data, so the database server honors the internal encoding.

```

public void insertBinStream(Connection conn)
{
    PreparedStatement insertStmt = null;
    String sqls = null;
    int cid = 0;
    Statement stmt=null;
    try {
        sqls = "INSERT INTO CUSTOMER (CID, INFO) VALUES (?, ?)";
        insertStmt = conn.prepareStatement(sqls);
        insertStmt.setInt(1, cid);
        File file = new File(fn);
        insertStmt.setBinaryStream(2,
            new FileInputStream(file), (int)file.length());
        if (insertStmt.executeUpdate() != 1) {
            System.out.println("insertBinStream: No record inserted.");
        }
    }
    catch (IOException ioe) {
        ioe.printStackTrace();
    }
    catch (SQLException sqle) {
        System.out.println("insertBinStream: SQL Exception: " +
            sqle.getMessage());
        System.out.println("insertBinStream: SQL State: " +
            sqle.getSQLState());
        System.out.println("insertBinStream: SQL Error Code: " +
            sqle.getErrorCode());
    }
}
}

```

**Example:** The following example demonstrates inserting binary XML data from a file into an XML column.

```

...
SQLXML info = conn.createSQLXML();
OutputStream os = info.setBinaryStream ();
FileInputStream fis = new FileInputStream("c7.xml");
int read;
while ((read = fis.read ()) != -1) {
    os.write (read);
}

PreparedStatement insertStmt = null;
String sqls = null;
int cid = 1015;
sqls = "INSERT INTO MyCustomer (Cid, Info) VALUES (?, ?)";
insertStmt = conn.prepareStatement(sqls);
insertStmt.setInt(1, cid);
insertStmt.setSQLXML(2, info);
insertStmt.executeUpdate();

```

### XML data retrieval in JDBC applications

In JDBC applications, you use `ResultSet.getXXX` or `ResultSet.getObject` methods to retrieve data from XML columns.

In a JDBC application, you can retrieve data from XML columns in a DB2 table as XML textual data. You can retrieve data from XML columns in a table as binary XML data (data that is in the Extensible Dynamic Binary XML DB2 Client/Server Binary XML Format), if the data server supports binary XML data.

You can use one of the following techniques to retrieve XML data:

- Use the `ResultSet.getSQLXML` method to retrieve the data. Then use a `SQLXML.getXXX` method to retrieve the data into a compatible output data type. This technique requires JDBC 4.0 or later.  
For example, you can retrieve data by using the `SQLXML.getBinaryStream` method or the `SQLXML.getSource` method.
- Use a `ResultSet.getXXX` method other than `ResultSet.getObject` to retrieve the data into a compatible data type.
- Use the `ResultSet.getObject` method to retrieve the data, and then cast it to the `DB2Xml` type and assign it to a `DB2Xml` object. Then use a `DB2Xml.getDB2XXX` or `DB2Xml.getDB2XmlXXX` method to retrieve the data into a compatible output data type.

You need to use this technique if you are not using a version of the IBM Data Server Driver for JDBC and SQLJ that supports JDBC 4.0.

The following table lists the `ResultSet` methods and corresponding output data types for retrieving XML data.

*Table 29. ResultSet methods and data types for retrieving XML data*

Method	Output data type
<code>ResultSet.getAsciiStream</code>	<code>InputStream</code>
<code>ResultSet.getBinaryStream</code>	<code>InputStream</code>
<code>ResultSet.getBytes</code>	<code>byte[]</code>
<code>ResultSet.getCharacterStream</code>	<code>Reader</code>
<code>ResultSet.getObject</code>	<code>Object</code>
<code>ResultSet.getSQLXML</code>	<code>SQLXML</code>
<code>ResultSet.getString</code>	<code>String</code>

The following table lists the methods that you can call to retrieve data from a `java.sql.SQLXML` or a `com.ibm.db2.jcc.DB2Xml` object, and the corresponding output data types and type of encoding in the XML declarations.

Table 30. *SQLXML and DB2Xml methods, data types, and added encoding specifications*

Method	Output data type	Type of XML internal encoding declaration added
<code>SQLXML.getBinaryStream</code>	<code>InputStream</code>	None
<code>SQLXML.getCharacterStream</code>	<code>Reader</code>	None
<code>SQLXML.getSource</code>	<code>Source</code> <sup>1</sup>	None
<code>SQLXML.getString</code>	<code>String</code>	None
<code>DB2Xml.getDB2AsciiStream</code>	<code>InputStream</code>	None
<code>DB2Xml.getDB2BinaryStream</code>	<code>InputStream</code>	None
<code>DB2Xml.getDB2Bytes</code>	<code>byte[]</code>	None
<code>DB2Xml.getDB2CharacterStream</code>	<code>Reader</code>	None
<code>DB2Xml.getDB2String</code>	<code>String</code>	None
<code>DB2Xml.getDB2XmlAsciiStream</code>	<code>InputStream</code>	US-ASCII
<code>DB2Xml.getDB2XmlBinaryStream</code>	<code>InputStream</code>	Specified by <code>getDB2XmlBinaryStream</code> <i>targetEncoding</i> parameter
<code>DB2Xml.getDB2XmlBytes</code>	<code>byte[]</code>	Specified by <code>DB2Xml.getDB2XmlBytes</code> <i>targetEncoding</i> parameter
<code>DB2Xml.getDB2XmlCharacterStream</code>	<code>Reader</code>	ISO-10646-UCS-2
<code>DB2Xml.getDB2XmlString</code>	<code>String</code>	ISO-10646-UCS-2

**Note:**

1. The class that is returned is specified by the invoker of `getSource`, but the class must extend `javax.xml.transform.Source`.

If the application executes the `XMLSERIALIZE` function on the data that is to be returned, after execution of the function, the data has the data type that is specified in the `XMLSERIALIZE` function, not the XML data type. Therefore, the driver handles the data as the specified type and ignores any internal encoding declarations.

**Example:** The following example demonstrates retrieving data from an XML column into an `SQLXML` object, and then using the `SQLXML.getString` method to retrieve the data into a string.

```
public void fetchToSQLXML(long cid, java.sql.Connection conn)
{
    System.out.println(">> fetchToSQLXML: Get XML data as an SQLXML object " +
        "using getSQLXML");
    PreparedStatement selectStmt = null;
    String sqls = null, stringDoc = null;
    ResultSet rs = null;

    try{
        sqls = "SELECT info FROM customer WHERE cid = " + cid;
        selectStmt = conn.prepareStatement(sqls);
        rs = selectStmt.executeQuery();

        // Get metadata
        // Column type for XML column is the integer java.sql.Types.OTHER
        ResultSetMetaData meta = rs.getMetaData();
        int colType = meta.getColumnType(1);
        System.out.println("fetchToSQLXML: Column type = " + colType);
    }
}
```

```

        while (rs.next()) {
            // Retrieve the XML data with getSQLXML.
            // Then write it to a string with
            // explicit internal ISO-10646-UCS-2 encoding.
            java.sql.SQLXML xml = rs.getSQLXML(1);
            System.out.println (xml.getString());
        }
        rs.close();
    }
    catch (SQLException sqle) {
        System.out.println("fetchToSQLXML: SQL Exception: " +
            sqle.getMessage());
        System.out.println("fetchToSQLXML: SQL State: " +
            sqle.getSQLState());
        System.out.println("fetchToSQLXML: SQL Error Code: " +
            sqle.getErrorCode());
    }
}

```

**Example:** The following example demonstrates retrieving data from an XML column into an SQLXML object, and then using the SQLXML.getBinaryStream method to retrieve the data as binary data into an InputStream.

```

String sql = "SELECT INFO FROM Customer WHERE Cid='1000'";
PreparedStatement pstmt = con.prepareStatement(sql);
ResultSet resultSet = pstmt.executeQuery();
// Get the result XML as a binary stream
SQLXML sqlxml = resultSet.getSQLXML(1);
InputStream binaryStream = sqlxml.getBinaryStream();

```

**Example:** The following example demonstrates retrieving data from an XML column into a String variable.

```

public void fetchToString(long cid, java.sql.Connection conn)
{
    System.out.println(">> fetchToString: Get XML data " +
        "using getString");
    PreparedStatement selectStmt = null;
    String sqls = null, stringDoc = null;
    ResultSet rs = null;

    try{
        sqls = "SELECT info FROM customer WHERE cid = " + cid;
        selectStmt = conn.prepareStatement(sqls);
        rs = selectStmt.executeQuery();

        // Get metadata
        // Column type for XML column is the integer java.sql.Types.OTHER
        ResultSetMetaData meta = rs.getMetaData();
        int colType = meta.getColumnType(1);
        System.out.println("fetchToString: Column type = " + colType);

        while (rs.next()) {
            stringDoc = rs.getString(1);
            System.out.println("Document contents:");
            System.out.println(stringDoc);
        }
    }
    catch (SQLException sqle) {
        System.out.println("fetchToString: SQL Exception: " +
            sqle.getMessage());
        System.out.println("fetchToString: SQL State: " +
            sqle.getSQLState());
        System.out.println("fetchToString: SQL Error Code: " +
            sqle.getErrorCode());
    }
}

```

**Example:** The following example demonstrates retrieving data from an XML column into a DB2Xml object, and then using the DB2Xml.getDB2XmlString method to retrieve the data into a string with an added XML declaration with an ISO-10646-UCS-2 encoding specification.

```
public void fetchToDB2Xml(long cid, java.sql.Connection conn)
{
    System.out.println(">> fetchToDB2Xml: Get XML data as a DB2XML object " +
        "using getObject");
    PreparedStatement selectStmt = null;
    String sqls = null, stringDoc = null;
    ResultSet rs = null;

    try{
        sqls = "SELECT info FROM customer WHERE cid = " + cid;
        selectStmt = conn.prepareStatement(sqls);
        rs = selectStmt.executeQuery();

        // Get metadata
        // Column type for XML column is the integer java.sql.Types.OTHER
        ResultSetMetaData meta = rs.getMetaData();
        int colType = meta.getColumnType(1);
        System.out.println("fetchToDB2Xml: Column type = " + colType);
        while (rs.next()) {
            // Retrieve the XML data with getObject, and cast the object
            // as a DB2Xml object. Then write it to a string with
            // explicit internal ISO-10646-UCS-2 encoding.
            com.ibm.db2.jcc.DB2Xml xml =
                (com.ibm.db2.jcc.DB2Xml) rs.getObject(1);
            System.out.println (xml.getDB2XmlString());
        }
        rs.close();
    }
    catch (SQLException sqle) {
        System.out.println("fetchToDB2Xml: SQL Exception: " +
            sqle.getMessage());
        System.out.println("fetchToDB2Xml: SQL State: " +
            sqle.getSQLState());
        System.out.println("fetchToDB2Xml: SQL Error Code: " +
            sqle.getErrorCode());
    }
}
```

## Invocation of routines with XML parameters in Java applications

Java applications can call stored procedures at DB2 Database for Linux, UNIX, and Windows or DB2 for z/OS data sources that have XML parameters.

For native SQL procedures, XML parameters in the stored procedure definition have the XML type. For external stored procedures and user-defined functions on DB2 Database for Linux, UNIX, and Windows data sources, XML parameters in the routine definition have the XML AS CLOB type. When you call a stored procedure or user-defined function that has XML parameters, you need to use a compatible data type in the invoking statement.

To call a routine with XML input parameters from a JDBC program, use parameters of the java.sql.SQLXML or com.ibm.db2.jcc.DB2Xml type. To register XML output parameters, register the parameters as the java.sql.Types.SQLXML or com.ibm.db2.jcc.DB2Types.XML type. (The com.ibm.db2.jcc.DB2Xml and com.ibm.db2.jcc.DB2Types.XML types are deprecated.)

**Example:** JDBC program that calls a stored procedure that takes three XML parameters: an IN parameter, an OUT parameter, and an INOUT parameter. This example requires JDBC 4.0 or later.

```

java.sql.SQLXML in_xml = xmlvar;
java.sql.SQLXML out_xml = null;
java.sql.SQLXML inout_xml = xmlvar;
                                     // Declare an input, output, and
                                     // INOUT XML parameter

Connection con;
CallableStatement cstmt;
ResultSet rs;
...
cstmt = con.prepareCall("CALL SP_xml(?,?,?)");
                                     // Create a CallableStatement object
cstmt.setObject (1, in_xml);         // Set input parameter
cstmt.setObject (3, inout_xml);     // Set inout parameter
cstmt.registerOutParameter (2, java.sql.Types.SQLXML);
                                     // Register out and input parameters
cstmt.registerOutParameter (3, java.sql.Types.SQLXML);
cstmt.executeUpdate();              // Call the stored procedure
out_xml = cstmt.getSQLXML(2);       // Get the OUT parameter value
inout_xml = cstmt.getSQLXML(3);     // Get the INOUT parameter value
System.out.println("Parameter values from SP_xml call: ");
System.out.println("Output parameter value ");
MyUtilities.printString(out_xml.getString());
                                     // Use the SQLXML.getString
                                     // method to convert the out_xml
                                     // value to a string for printing.
                                     // Call a user-defined method called
                                     // printString (not shown) to print
                                     // the value.
System.out.println("INOUT parameter value ");
MyUtilities.printString(inout_xml.getString());
                                     // Use the SQLXML.getString
                                     // method to convert the inout_xml
                                     // value to a string for printing.
                                     // Call a user-defined method called
                                     // printString (not shown) to print
                                     // the value.

```

To call a routine with XML parameters from an SQLJ program, use parameters of the `java.sql.SQLXML` or `com.ibm.db2.jcc.DB2Xml` type.

**Example:** SQLJ program that calls a stored procedure that takes three XML parameters: an IN parameter, an OUT parameter, and an INOUT parameter. This example requires JDBC 4.0 or later.

```

java.sql.SQLXML in_xml = xmlvar;
java.sql.SQLXML out_xml = null;
java.sql.SQLXML inout_xml = xmlvar;
                                     // Declare an input, output, and
                                     // INOUT XML parameter

...
#sql [myConnCtx] {CALL SP_xml(:IN in_xml,
                             :OUT out_xml,
                             :INOUT inout_xml)};
                                     // Call the stored procedure
System.out.println("Parameter values from SP_xml call: ");
System.out.println("Output parameter value ");
MyUtilities.printString(out_xml.getString());
                                     // Use the SQLXML.getString
                                     // method to convert the out_xml value
                                     // to a string for printing.
                                     // Call a user-defined method called
                                     // printString (not shown) to print
                                     // the value.
System.out.println("INOUT parameter value ");
MyUtilities.printString(inout_xml.getString());
                                     // Use the SQLXML.getString

```

```
// method to convert the inout_xml
// value to a string for printing.
// Call a user-defined method called
// printString (not shown) to print
// the value.
```

## SQLJ

### XML data in SQLJ applications

In SQLJ applications, you can store data in XML columns and retrieve data from XML columns.

In DB2 tables, the XML built-in data type is used to store XML data in a column as a structured set of nodes in a tree format.

SQLJ applications can send XML data to the data server or retrieve XML data from the data server in one of the following forms:

- As textual XML data
- As binary XML data (data that is in the Extensible Dynamic Binary XML DB2 Client/Server Binary XML Format), if the data server supports it

In SQLJ applications, you can:

- Store an entire XML document in an XML column using INSERT, UPDATE, or MERGE statements.
- Retrieve an entire XML document from an XML column using single-row SELECT statements or iterators.
- Retrieve a sequence from a document in an XML column by using the SQL XMLQUERY function to retrieve the sequence in the database, and then using single-row SELECT statements or iterators to retrieve the serialized XML string data into an application variable.
- Retrieve a sequence from a document in an XML column by using an XQuery expression, prepended with the string 'XQUERY', to retrieve the elements of the sequence into a result table in the database, in which each row of the result table represents an item in the sequence. Then use using single-row SELECT statements or iterators to retrieve the data into application variables.
- Retrieve a sequence from a document in an XML column as a user-defined table by using the SQL XMLTABLE function to define the result table and retrieve it. Then use using single-row SELECT statements or iterators to retrieve the data from the result table into application variables.
- You can update or retrieve XML data as textual XML data. Alternatively, for connections to a data server that supports binary XML data, you can update or retrieve XML data as binary XML data. You use the DataSource or Connection property xmlFormat to control whether the data format is textual XML or binary XML. The format of XML data is transparent to the application. Storage and retrieval of binary XML data on a DB2 for z/OS data server requires version 4.9 or later of the IBM Data Server Driver for JDBC and SQLJ. Storage and retrieval of binary XML data on a DB2 Database for Linux, UNIX, and Windows data server requires version 4.11 or later of the IBM Data Server Driver for JDBC and SQLJ.

JDBC 4.0 `java.sql.SQLXML` objects can be used to retrieve and update data in XML columns. Invocations of metadata methods, such as `ResultSetMetaData.getColumnType` return the integer value `java.sql.Types.SQLXML` for an XML column type.



## XML column updates in SQLJ applications

In an SQLJ application, you can update or insert data into XML columns of a table at a DB2 data server using XML textual data. You can update or insert data into XML columns of a table using binary XML data (data that is in the Extensible Dynamic Binary XML DB2 Client/Server Binary XML Format), if the data server supports binary XML data.

The host expression data types that you can use to update XML columns are:

- `java.sql.SQLXML` (requires an SDK for Java Version 6 or later, and the IBM Data Server Driver for JDBC and SQLJ version 4.0 or later)
- `com.ibm.db2.jcc.DB2Xml` (deprecated)
- `String`
- `byte`
- `Blob`
- `Clob`
- `sqlj.runtime.AsciiStream`
- `sqlj.runtime.BinaryStream`
- `sqlj.runtime.CharacterStream`

The encoding of XML data can be derived from the data itself, which is known as *internally encoded* data, or from external sources, which is known as *externally encoded* data. XML data that is sent to the database server as binary data is treated as internally encoded data. XML data that is sent to the data source as character data is treated as externally encoded data. The external encoding is the default encoding for the JVM.

External encoding for Java applications is always Unicode encoding.

Externally encoded data can have internal encoding. That is, the data might be sent to the data source as character data, but the data contains encoding information. The data source handles incompatibilities between internal and external encoding as follows:

- If the data source is DB2 Database for Linux, UNIX, and Windows, the data source generates an error if the external and internal encoding are incompatible, unless the external and internal encoding are Unicode. If the external and internal encoding are Unicode, the data source ignores the internal encoding.
- If the data source is DB2 for z/OS, the data source ignores internal encoding.

Data in XML columns is stored in UTF-8 encoding.

**Example:** Suppose that you use the following statement to insert data from `String` host expression `xmlString` into an XML column in a table. `xmlString` is a character type, so its external encoding is used, whether or not it has an internal encoding specification.

```
#sql [ctx] {INSERT INTO CUSTACC VALUES (1, :xmlString)};
```

**Example:** Suppose that you copy the data from `xmlString` into a byte array with CP500 encoding. The data contains an XML declaration with an encoding declaration for CP500. Then you insert the data from the `byte[]` host expression into an XML column in a table.

```
byte[] xmlBytes = xmlString.getBytes("CP500");  
#sql[ctx] {INSERT INTO CUSTACC VALUES (4, :xmlBytes)};
```

A byte string is considered to be internally encoded data. The data is converted from its internal encoding scheme to UTF-8, if necessary, and stored in its hierarchical format on the data source.

**Example:** Suppose that you copy the data from `xmlString` into a byte array with US-ASCII encoding. Then you construct an `sqlj.runtime.AsciiStream` host expression, and insert data from the `sqlj.runtime.AsciiStream` host expression into an XML column in a table on a data source.

```
byte[] b = xmlString.getBytes("US-ASCII");
java.io.ByteArrayInputStream xmlAsciiInputStream =
    new java.io.ByteArrayInputStream(b);
sqlj.runtime.AsciiStream sqljXmlAsciiStream =
    new sqlj.runtime.AsciiStream(xmlAsciiInputStream, b.length);
#sql[ctx] {INSERT INTO CUSTACC VALUES (4, :sqljXmlAsciiStream)};
```

`sqljXmlAsciiStream` is a stream type, so its internal encoding is used. The data is converted from its internal encoding to UTF-8 encoding and stored in its hierarchical form on the data source.

**Example: `sqlj.runtime.CharacterStream` host expression:** Suppose that you construct an `sqlj.runtime.CharacterStream` host expression, and insert data from the `sqlj.runtime.CharacterStream` host expression into an XML column in a table.

```
java.io.StringReader xmlReader =
    new java.io.StringReader(xmlString);
sqlj.runtime.CharacterStream sqljXmlCharacterStream =
    new sqlj.runtime.CharacterStream(xmlReader, xmlString.length());
#sql [ctx] {INSERT INTO CUSTACC VALUES (4, :sqljXmlCharacterStream)};
```

`sqljXmlCharacterStream` is a character type, so its external encoding is used, whether or not it has an internal encoding specification.

**Example:** Suppose that you retrieve a document from an XML column into a `java.sql.SQLXML` host expression, and insert the data into an XML column in a table.

```
java.sql.ResultSet rs = s.executeQuery ("SELECT * FROM CUSTACC");
rs.next();
java.sql.SQLXML xmlObject = (java.sql.SQLXML)rs.getObject(2);
#sql [ctx] {INSERT INTO CUSTACC VALUES (6, :xmlObject)};
```

After you retrieve the data it is still in UTF-8 encoding, so when you insert the data into another XML column, no conversion occurs.

**Example:** Suppose that you retrieve a document from an XML column into a `com.ibm.db2.jcc.DB2Xml` host expression, and insert the data into an XML column in a table.

```
java.sql.ResultSet rs = s.executeQuery ("SELECT * FROM CUSTACC");
rs.next();
com.ibm.db2.jcc.DB2Xml xmlObject = (com.ibm.db2.jcc.DB2Xml)rs.getObject(2);
#sql [ctx] {INSERT INTO CUSTACC VALUES (6, :xmlObject)};
```

After you retrieve the data it is still in UTF-8 encoding, so when you insert the data into another XML column, no conversion occurs.

## XML data retrieval in SQLJ applications

When you retrieve data from XML columns of a database table in an SQLJ application, the output data must be explicitly or implicitly serialized.

The host expression or iterator data types that you can use to retrieve data from XML columns are:

- `java.sql.SQLXML` (requires an SDK for Java Version 6 or later, and the IBM Data Server Driver for JDBC and SQLJ version 4.0 or later)
- `com.ibm.db2.jcc.DB2Xml` (deprecated)
- `String`
- `byte[]`
- `sqlj.runtime.AsciiStream`
- `sqlj.runtime.BinaryStream`
- `sqlj.runtime.CharacterStream`

If the application does not call the `XMLSERIALIZE` function before data retrieval, the data is converted from UTF-8 to the external application encoding for the character data types, or the internal encoding for the binary data types. No XML declaration is added. If the host expression is an object of the `java.sql.SQLXML` or `com.ibm.db2.jcc.DB2Xml` type, you need to call an additional method to retrieve the data from this object. The method that you call determines the encoding of the output data and whether an XML declaration with an encoding specification is added.

The following table lists the methods that you can call to retrieve data from a `java.sql.SQLXML` or a `com.ibm.db2.jcc.DB2Xml` object, and the corresponding output data types and type of encoding in the XML declarations.

*Table 31. SQLXML and DB2Xml methods, data types, and added encoding specifications*

Method	Output data type	Type of XML internal encoding declaration added
<code>SQLXML.getBinaryStream</code>	<code>InputStream</code>	None
<code>SQLXML.getCharacterStream</code>	<code>Reader</code>	None
<code>SQLXML.getSource</code>	<code>Source</code>	None
<code>SQLXML.getString</code>	<code>String</code>	None
<code>DB2Xml.getDB2AsciiStream</code>	<code>InputStream</code>	None
<code>DB2Xml.getDB2BinaryStream</code>	<code>InputStream</code>	None
<code>DB2Xml.getDB2Bytes</code>	<code>byte[]</code>	None
<code>DB2Xml.getDB2CharacterStream</code>	<code>Reader</code>	None
<code>DB2Xml.getDB2String</code>	<code>String</code>	None
<code>DB2Xml.getDB2XmlAsciiStream</code>	<code>InputStream</code>	US-ASCII
<code>DB2Xml.getDB2XmlBinaryStream</code>	<code>InputStream</code>	Specified by <code>getDB2XmlBinaryStream</code> <i>targetEncoding</i> parameter
<code>DB2Xml.getDB2XmlBytes</code>	<code>byte[]</code>	Specified by <code>DB2Xml.getDB2XmlBytes</code> <i>targetEncoding</i> parameter
<code>DB2Xml.getDB2XmlCharacterStream</code>	<code>Reader</code>	ISO-10646-UCS-2
<code>DB2Xml.getDB2XmlString</code>	<code>String</code>	ISO-10646-UCS-2

If the application executes the `XMLSERIALIZE` function on the data that is to be returned, after execution of the function, the data has the data type that is specified in the `XMLSERIALIZE` function, not the XML data type. Therefore, the driver handles the data as the specified type and ignores any internal encoding declarations.

**Example:** Suppose that you retrieve data from an XML column into a `String` host expression.

```
#sql iterator XmlStringIter (int, String);
#sql [ctx] siter = {SELECT c1, CADOC from CUSTACC};
#sql {FETCH :siter INTO :row, :outString};
```

The String type is a character type, so the data is converted from UTF-8 to the external encoding, which is the default JVM encoding, and returned without any XML declaration.

**Example:** Suppose that you retrieve data from an XML column into a byte[] host expression.

```
#sql iterator XmlByteArrayIter (int, byte[]);
XmlByteArrayIter biter = null;
#sql [ctx] biter = {SELECT c1, CADOC from CUSTACC};
#sql {FETCH :biter INTO :row, :outBytes};
```

The byte[] type is a binary type, so no data conversion from UTF-8 encoding occurs, and the data is returned without any XML declaration.

**Example:** Suppose that you retrieve a document from an XML column into a java.sql.SQLXML host expression, but you need the data in a binary stream.

```
#sql iterator SqlXmlIter (int, java.sql.SQLXML);
SqlXmlIter SQLXMLiter = null;
java.sql.SQLXML outSqlXml = null;
#sql [ctx] SqlXmlIter = {SELECT c1, CADOC from CUSTACC};
#sql {FETCH :SqlXmlIter INTO :row, :outSqlXml};
java.io.InputStream XmlStream = outSqlXml.getBinaryStream();
```

The FETCH statement retrieves the data into the SQLXML object in UTF-8 encoding. The SQLXML.getBinaryStream stores the data in a binary stream.

**Example:** Suppose that you retrieve a document from an XML column into a com.ibm.db2.jcc.DB2Xml host expression, but you need the data in a byte string with an XML declaration that includes an internal encoding specification for UTF-8.

```
#sql iterator DB2XmlIter (int, com.ibm.db2.jcc.DB2Xml);
DB2XmlIter db2xmliter = null;
com.ibm.db2.jcc.DB2Xml outDB2Xml = null;
#sql [ctx] db2xmliter = {SELECT c1, CADOC from CUSTACC};
#sql {FETCH :db2xmliter INTO :row, :outDB2Xml};
byte[] byteArray = outDB2XML.getDB2XmlBytes("UTF-8");
```

The FETCH statement retrieves the data into the DB2Xml object in UTF-8 encoding. The getDB2XmlBytes method with the UTF-8 argument adds an XML declaration with a UTF-8 encoding specification and stores the data in a byte array.

---

## PHP

### PHP application development for IBM data servers

PHP: Hypertext Preprocessor (PHP) is an interpreted programming language that is widely used for developing web applications. PHP has become a popular language for web development because it is easy to learn, focuses on practical solutions, and supports the most commonly required functionality in web applications.

PHP is a modular language that enables you to customize the available functionality through the use of extensions. These extensions can simplify tasks such as reading, writing, and manipulating XML, creating SOAP clients and

servers, and encrypting communications between server and browser. The most popular extensions for PHP, however, provide read and write access to databases so that you can easily create a dynamic database-driven website.

IBM provides the listed PHP extensions for accessing IBM data server databases:

#### **ibm\_db2**

A procedural application programming interface (API) that, in addition to the normal create, read, update, and write database operations, also offers extensive access to the database metadata. You can compile the `ibm_db2` extension with either PHP 4 or PHP 5. This extension is written, maintained, and supported by IBM.

#### **pdo\_ibm**

A driver for the PHP Data Objects (PDO) extension that offers access to IBM data server databases through the standard object-oriented database interface introduced in PHP 5.1.

These extensions are included as part of the IBM Data Server Driver Package (DS Driver) of Version 1.7.0. This version or a later version is supported to connect to IBM DB2 Version 9.7 for Linux, UNIX, and Windows. You can check the version of `ibm_db2` extension by issuing the `php --re ibm_db2` command.

The most recent versions of `ibm_db2` and `pdo_ibm` are also available from the PHP Extension Community Library (PECL) at <http://pecl.php.net/>.

PHP applications can access the listed IBM data server databases:

- IBM DB2 Version 9.1 for Linux, UNIX, and Windows, Fix Pack 2 and later
- IBM DB2 Universal Database™ (DB2 UDB) Version 8 for Linux, UNIX, and Windows, Fixpak 15 and later
- Remote connections to IBM DB2 for IBM i V5R3
- Remote connections to IBM DB2 for IBM i Version 5.4 and later
- Remote connections to IBM DB2 for z/OS, Version 8 and later

A third extension, Unified ODBC, has historically offered access to DB2 database systems. For new applications, however, you can use either `ibm_db2` and `pdo_ibm` because they offer significant performance and stability benefits over Unified ODBC. The `ibm_db2` extension API makes porting an application that was previously written for Unified ODBC almost as easy as globally changing the `odbc_` function name to `db2_` throughout the source code of your application.

## **XML data retrieval using PHP applications**

The `ibm_db2` API is a PHP extension for accessing IBM data server databases. The `ibm_db2` API supports connecting to DB2 databases and returning XML data from XML columns.

The `ibm_db2` API also supports using DB2 functions such as `XMLTABLE`, and executing XQuery expressions in SQL statements. In the SQL statements, use the `XMLQUERY` function to call XQuery expressions.

For more information about developing PHP applications with the `ibm_db2` API, see "Application development in PHP with `ibm_db2`" in *Developing Perl, PHP, Python, and Ruby on Rails Applications*.

## PHP downloads and related resources

Many resources are available to help you develop PHP applications for IBM data servers.

Table 32. PHP downloads and related resources

Downloads	
Complete PHP source code <sup>1</sup>	<a href="http://www.php.net/downloads.php">http://www.php.net/downloads.php</a>
ibm_db2 and pdo_ibm from the PHP Extension Community Library (PECL)	<a href="http://pecl.php.net/">http://pecl.php.net/</a>
IBM Data Server Driver Package (DS Driver)	<a href="http://www.ibm.com/software/data/support/data-server-clients/index.html">http://www.ibm.com/software/data/support/data-server-clients/index.html</a>
Zend Server	<a href="http://www.zend.com/en/products/server/downloads">http://www.zend.com/en/products/server/downloads</a>
<i>PHP Manual</i>	<a href="http://www.php.net/docs.php">http://www.php.net/docs.php</a>
ibm_db2 API documentation	<a href="http://www.php.net/ibm_db2">http://www.php.net/ibm_db2</a>
PDO API documentation	<a href="http://php.net/manual/en/book.pdo.php">http://php.net/manual/en/book.pdo.php</a>
PHP website	<a href="http://www.php.net/">http://www.php.net/</a>

1. Includes Windows binaries. Most Linux distributions come with PHP already precompiled.

---

## Perl

### pureXML and Perl

The DBD::DB2 driver supports DB2 pureXML. Support for pureXML allows more direct access to your data through the DBD::DB2 driver and helps to decrease application logic by providing more transparent communication between your application and database.

With pureXML support, you can directly insert XML documents into your DB2 database. Your application no longer needs to parse XML documents because the pureXML parser is automatically run when you insert XML data into the database. Having document parsing handled outside your application improves application performance and reduces maintenance efforts. Retrieval of XML stored data with the DBD::DB2 driver is easy as well; you can access the data using a BLOB or record.

For information about the DB2 Perl Database Interface and how to download the latest DBD::DB2 driver, see <http://www.ibm.com/software/data/db2/perl>.

### Example

The example is a Perl program that uses pureXML:

```
#!/usr/bin/perl
use DBI;
use strict ;

# Use DBD:DB2 module:
#   to create a simple DB2 table with an XML column
#   Add one row of data
#   retrieve the XML data as a record or a LOB (based on $datatype).

# NOTE: the DB2 SAMPLE database must already exist.
```

```

my $database='dbi:DB2:sample';
my $user='';
my $password='';

my $datatype = "record" ;
# $datatype = "LOB" ;

my $dbh = DBI->connect($database, $user, $password)
    or die "Can't connect to $database: $DBI::errstr";

# For LOB datatype, LongReadLen = 0 -- no data is retrieved on initial fetch
$dbh->{LongReadLen} = 0 if $datatype eq "LOB" ;

# SQL CREATE TABLE to create test table
my $stmt = "CREATE TABLE xmlTest (id INTEGER, data XML)";
my $sth = $dbh->prepare($stmt);
$sth->execute();

#insert one row of data into table
insertData() ;

# SQL SELECT statement returns home phone element from XML data
$stmt = qq(
SELECT XMLQUERY (
  \$d/*:customerinfo/*:phone[\@type = "home"] '
  passing data as "d")
FROM xmlTest
) ;

# prepare and execute SELECT statement
$sth = $dbh->prepare($stmt);
$sth->execute();

# Print data returned from select statement
if($datatype eq "LOB") {
    printLOB() ;
}
else {
    printRecord() ;
}

# Drop table
$stmt = "DROP TABLE xmlTest" ;
$sth = $dbh->prepare($stmt);
$sth->execute();

warn $DBI::errstr if $DBI::err;

$sth->finish;
$dbh->disconnect;

#####

sub printRecord {
    print "output data as as record\n" ;

    while( my @row = $sth->fetchrow )
    {
        print $row[0] . "\n";
    }

    warn $DBI::errstr if $DBI::err;
}

```

```

sub printLOB {
    print "output as Blob data\n" ;

    my $offset = 0;
    my $buff="";
    $sth->fetch();
    while( $buff = $sth->blob_read(1,$offset,1000000) ) {
        print $buff;
        $offset+=length($buff);
        $buff="";
    }
    warn $DBI::errstr if $DBI::err;
}

sub insertData {

    # insert a row of data
    my $xmlInfo = qq(\
<customerinfo xmlns="http://posample.org" Cid="1011">
    <name>Bill Jones</name>
    <addr country="Canada">
        <street>5 Redwood</street>
        <city>Toronto</city>
        <prov-state>Ontario</prov-state>
        <pcode-zip>M6W 1E9</pcode-zip>
    </addr>
    <phone type="work">416-555-9911</phone>
    <phone type="home">416-555-1212</phone>
</customerinfo>
\') ;

    my $catID = 1011 ;

    # SQL statement to insert data.
    my $Sql = qq(
        INSERT INTO xmlTest (id, data)
        VALUES($catID, $xmlInfo )
    );

    $sth = $dbh->prepare( $Sql )
        or die "Can't prepare statement: $DBI::errstr";

    my $rc = $sth->execute
        or die "Can't execute statement: $DBI::errstr";

    # check for problems
    warn $DBI::errstr if $DBI::err;
}

```

## Database connections in Perl

The DBD::DB2 driver provides support for standard database connection functions defined by the DBI API.

To enable Perl to load the DBI module, you must include the `use DBI;` line in your application:

The DBI module automatically loads the DBD::DB2 driver when you create a database handle using the **DBI->connect** statement with the listed syntax:

```
my $dbhandle = DBI->connect('dbi:DB2:dsn', $userID, $password);
```

where:



**\$dbhhandle**

represents the database handle returned by the connect statement

**dsn**

for local connections, represents a DB2 alias cataloged in your DB2 database directory

for remote connections, represents a complete connection string that includes the host name, port number, protocol, user ID, and password for connecting to the remote host

**\$userID**

represents the user ID used to connect to the database

**\$password**

represents the password for the user ID used to connect to the database

For more information about the DBI API, see <http://search.cpan.org/~timb/DBI/DBI.pm>

**Example**

*Example 1:* Connect to a database on the local host (client and server are on the same workstation)

```
use DBI;

$DATABASE = 'dbname';
$USERID = 'username';
$PASSWORD = 'password';

my $dbh = DBI->connect("dbi:DB2:$DATABASE", $USERID, $PASSWORD, {PrintError => 0})
or die "Couldn't connect to database: " . DBI->errstr;

$dbh->disconnect;
```

*Example 2:* Connect to a database on the remote host (client and server are on different workstations)

```
use DBI;

$DSN="DATABASE=sample; HOSTNAME=host; PORT=60000; PROTOCOL=TCPIP; UID=username;
PWD=password";

my $dbh = DBI->connect("dbi:DB2:$DSN", $USERID, $PASSWORD, {PrintError => 0})
or die "Couldn't connect to database: " . DBI->errstr;

$dbh->disconnect;
```

**Perl Restrictions**

Some restrictions apply to the support that is available for application development in Perl.

The Perl DBI module supports only dynamic SQL. When you must execute a statement multiple times, you can improve the performance of your Perl applications by issuing a **prepare** call to prepare the statement.

Perl does not support multiple-thread database access.

For current information on the restrictions of the version of the DBD::DB2 driver that you install on your workstation, see the CAVEATS file in the DBD::DB2 driver package.

---

## Routines

### SQL procedures

#### XML and XQuery support in SQL procedures

SQL procedures support parameters and variables of data type XML. They can be used in SQL statements in the same way as variables of any other data type. In addition, variables of data type XML can be passed as parameters to XQuery expressions in XMLEXISTS, XMLQUERY and XMLTABLE expressions.

The following example shows the declaration, use, and assignment of XML parameters and variables in an SQL procedure:

```
CREATE TABLE T1(C1 XML) %

CREATE PROCEDURE proc1(IN parm1 XML, IN parm2 VARCHAR(32000))
LANGUAGE SQL
BEGIN
    DECLARE var1 XML;

    /* check if the value of XML parameter parm1
       contains an item with a value less than 200 */
    IF(XMLEXISTS('$x/ITEM[value < 200]' passing by ref parm1 as "x"))THEN

        /* if it does, insert the value of parm1 into table T1 */
        INSERT INTO T1 VALUES(parm1);

    END IF;

    /* parse parameter parm2's value and assign it to a variable */
    SET var1 = XMLPARSE(document parm2 preserve whitespace);

    /* insert variable var1 into table T1
    INSERT INTO T1 VALUES(var1);

END %
```

In this example, there is a table T1 with an XML column. The SQL procedure accepts two parameters of data type XML named parm1 and parm2. Within the SQL procedure an XML variable is declared named var1.

The logic of the SQL procedure checks if the value of XML parameter parm1 contains an item with a value less than 200. If it does, the XML value is directly inserted into column C1 in table T1.

Then the value of parameter parm2 is parsed using the XMLPARSE function and assigned to XML variable var1. The XML variable value is then also inserted into column C1 in table T1.

The ability to implement control flow logic around XQuery operations makes it easy to develop complex algorithms that query and access XML data stored in a database.

## Cursors for XQuery expressions in SQL procedures

SQL Procedures support the definition of cursors on XQuery expressions. A cursor on an XQuery expression allows you to iterate over the elements of the XQuery sequence returned by the expression.

Unlike cursors defined on SQL statements, which can be defined either statically or dynamically, cursors on XQuery expressions can only be defined dynamically. To declare a cursor dynamically, it is necessary to declare a variable of type CHAR or VARCHAR to contain the XQuery expression that will define the cursor result set. The XQuery expression must be prepared before the cursor can be opened and the result set resolved.

An example of an SQL procedure that dynamically declares a cursor for an XQuery expression, opens the cursor, and fetches XML data is shown here:

```
CREATE PROCEDURE xmlProc(IN inCust XML, OUT resXML XML)
SPECIFIC xmlProc
LANGUAGE SQL
BEGIN
    DECLARE SQLSTATE CHAR(5);
    DECLARE stmt_text VARCHAR (1024);
    DECLARE customer XML;
    DECLARE cityXml XML;
    DECLARE city VARCHAR (100);
    DECLARE stmt STATEMENT;
    DECLARE cur1 CURSOR FOR stmt;

    -- Get the city of the input customer
    SET cityXml = XMLQUERY('$cust/customerinfo//city' passing inCust as "cust");
    SET city = XMLCAST(cityXml as VARCHAR(100));

    -- Iterate over all the customers from the city using an XQUERY cursor
    -- and collect the customer name values into the output XML value

    SET stmt_text = 'XQUERY for $cust
                    in db2-fn:xmlcolumn("CUSTOMER.INFO")
                    /*:customerinfo/*:addr[*:city= "' || city || '" ]
                    return <Customer>{$cust/../@Cid}{$cust/../*:name}</Customer>';

    -- Use the name of the city for the input customer data as a prefix
    SET resXML = cityXml;

    PREPARE stmt FROM stmt_text;
    OPEN cur1;

    FETCH cur1 INTO customer;
    WHILE (SQLSTATE = '00000') DO
        SET resXML = XMLCONCAT(resXML, customer);
        FETCH cur1 INTO customer;
    END WHILE;

    set resXML = XMLQUERY('<result> {$res} </result>'
                          passing resXML as "res");

END
```

This SQL procedure collects the IDs and names of customers defined in a table name CUSTOMER that are located in the same city as the customer for which XML data is provided as an input parameter.

This SQL procedure can be called by executing the CALL statement as follows:

```
CALL xmlProc(xmlparse(document '<customerinfo Cid="5002">
    <name>Jim Noodle</name>
    <addr country="Canada">
        <street>25 EastCreek</street>
        <city>Markham</city>
        <prov-state>Ontario</prov-state>
        <pcode-zip>N9C-3T6</pcode-zip>
    </addr>
    <phone type="work">905-566-7258</phone>
</customerinfo>' PRESERVE WHITESPACE),?)
```

If this SQL procedure is created and run against the SAMPLE database, it returns XML data for two customers.

As parameter markers are not supported for XML values, a workaround to this limitation is to construct a dynamic SQL statement out of concatenated statement fragments that include the value of one or more local variables.

For example:

```
DECLARE person_name VARCHAR(128);

SET person_name = "Joe";
SET stmt_text = 'XQUERY for $fname in db2-fn:sqlquery
("SELECT doc
 FROM T1
 WHERE DOCID=1")//fullname where $fname/first = ''' person_name || ''';
```

This example returns a result set in a variable assignment for an XQuery statement that contains an SQL fullselect. The result set contains the full names of persons with the first name Joe. Functionally, the SQL portion selects the XML documents from column doc in table T1 that have an ID of 1. The XQuery portion then selects the fullname values in the XML documents where the value first is Joe.

### Effect of commits and rollbacks on XML parameter and variable values in SQL procedures

Commits and rollbacks within SQL procedures affect the values of parameters and variables of data type XML. During the execution of SQL procedures, upon a commit or rollback operation, the values assigned to XML parameters and XML variables will no longer be available.

Attempts to reference an SQL variable or SQL parameter of data type XML after a commit or rollback operation will cause an error (SQL1354N, 560CE) to be raised.

To successfully reference XML parameters and variables after a commit or rollback operation occurs, new values must first be assigned to them.

Consider the availability of XML parameter and variable values when adding ROLLBACK and COMMIT statements to SQL procedures.

## SQL functions

### Parameters and variables of data type XML in SQL functions

DB2 database systems support the XML data type for inlined SQL functions that you create using the CREATE FUNCTION (SQL scalar, table, or row) statement or the CREATE FUNCTION (sourced or template) statement.

In an inlined user-defined function created with the CREATE FUNCTION (SQL scalar, table or row) statement, you can use XML variables in SQL statements in

the same way as variables of any other data type. For example, in a user-defined function you can pass variables of data type XML as parameters to XQuery expressions in an XMLEXISTS predicate or a function like XMLQUERY or XMLTABLE.

In a user-defined function created with the CREATE FUNCTION (sourced or template) statement where the source function is a user-defined SQL scalar function, you can use the XML data type as an input, output, or input/output parameter.

XML values are assigned by reference in a user-defined function.

Parameters and variables of data type XML are not supported in compiled SQL functions.

### Example

The following example function is an inline SQL scalar function that uses the XML data type as an input parameter and a variable. The function extracts the phone number element from an XML document using an XQuery expression and returns the phone number element:

```
CREATE FUNCTION phone_number ( dept_doc XML )
RETURNS XML
LANGUAGE SQL
NO EXTERNAL ACTION
BEGIN ATOMIC
DECLARE tmp_xml XML;
IF (XMLEXISTS('$test/department/phone' passing by ref dept_doc as "test"))
THEN
    SET tmp_xml = XMLQUERY('document
        {<phone_list>{$doc/department/phone}</phone_list>}'
        PASSING dept_doc as "doc");
ELSE
    SET tmp_xml = XMLPARSE(document '<phone_list><phone>N/A</phone></phone_list>');
END IF;
RETURN tmp_xml;
END
```

The following SELECT statement uses the PHONE\_NUMBER function to retrieve the phone number from an XML document in a table with employee information.

```
SELECT PHONE_NUMBER(info) FROM employees WHERE empid = 12356
```

The SELECT statement assumes the table is similar to a table created with the following CREATE TABLE statement and contains data similar to the information inserted with following INSERT statement:

```
CREATE TABLE employees (empid BIGINT, info XML )
INSERT INTO EMPLOYEES VALUES ( 12356, '
    <department id="marketing">
        <empid>12356</empid>
        <phone>555-123-4567</phone>
    </department> '
```

Using the previous table and information, The SELECT statement returns the following phone number information:

```
<phone_list><phone>555-123-4567</phone></phone_list>
```

## Inlined SQL functions and compiled SQL functions

There are two implementation types for SQL functions: inlined SQL functions and compiled SQL functions.

### Inlined SQL functions

Inlined SQL functions are SQL functions that are created using the `CREATE FUNCTION` statement with a body that is either a `RETURN` statement or an inline compound statement. Inline compound statements are defined with the `BEGIN ATOMIC` and `END` keywords.

Inlined SQL functions can contain SQL statements and inline SQL PL statements - a subset of SQL PL statements.

### Compiled SQL functions

Compiled SQL functions are SQL functions that are created using the `CREATE FUNCTION` statement with a body that is either a `RETURN` statement or a compiled compound statement. Compiled compound statements are defined with the `BEGIN` and `END` keywords.

When the `ATOMIC` clause is omitted, SQL functions are compiled and as such can include or reference more SQL PL features than inlined SQL functions. Compiled SQL functions can include the following features which are not supported in inlined SQL functions:

- SQL PL statements, including:
  - `CASE` statement
  - `REPEAT` statement
- Cursor processing
- Dynamic SQL
- Condition handlers

## External routines

### XML data type support in external routines

External procedures and functions written in the following programming languages support parameters and variables of data type XML:

- C
- C++
- COBOL
- Java
- .NET CLR languages

External OLE and OLEDB routines do not support parameters of data type XML.

XML data type values are represented in external routine code in the same way as CLOB data types.

When declaring external routine parameters of data type XML, the `CREATE PROCEDURE` and `CREATE FUNCTION` statements that will be used to create the routines in the database must specify that the XML data type is to be stored as a CLOB data type. The size of the CLOB value should be close to the size of the XML document represented by the XML parameter.

The following CREATE PROCEDURE statement shows a CREATE PROCEDURE statement for an external procedure implemented in the C programming language with an XML parameter named parm1:

```
CREATE PROCEDURE myproc(IN parm1 XML AS CLOB(2M), IN parm2 VARCHAR(32000))
LANGUAGE C
FENCED
PARAMETER STYLE SQL
EXTERNAL NAME 'mylib!myproc';
```

Similar considerations apply when creating external UDFs, as shown in the following example:

```
CREATE FUNCTION myfunc (IN parm1 XML AS CLOB(2M))
RETURNS SMALLINT
LANGUAGE C
PARAMETER STYLE SQL
DETERMINISTIC
NOT FENCED
NULL CALL
NO SQL
NO EXTERNAL ACTION
EXTERNAL NAME 'mylib1!myfunc'
```

XML data is materialized when passed to stored procedures as IN, OUT, or INOUT parameters. If you are using Java stored procedures, the heap size (**java\_heap\_sz** configuration parameter) might need to be increased based on the quantity and size of XML arguments, and the number of external stored procedures that are being executed concurrently.

Within external routine code, XML parameter and variable values are accessed, set, and modified in the same way as in database applications.

### Specification of a driver for Java routines

Java routine development and invocation requires that a JDBC or SQLJ driver be specified.

Java routines use the IBM Data Server Driver for JDBC and SQLJ Version 4.0.

IBM Data Server Driver for JDBC and SQLJ Version 4.0 db2jcc4.jar includes a number of JDBC Version 4.0 capabilities. The driver is supported in DB2 Version 9.5 and higher.

By default, DB2 database systems use the IBM Data Server Driver for JDBC and SQLJ. This driver is a prerequisite if Java routines contain:

- Parameters of data type XML
- Variables of data type XML
- References to XML data
- References to XML functions
- Any other native-XML feature

### Example: XML and XQuery support in Java (JDBC) procedure

Once the basics of Java procedures, programming in Java using the JDBC application programming interface (API), and XQuery are understood, you can start creating and using Java procedures that query XML data.

This example of a Java procedure illustrates:

- the CREATE PROCEDURE statement for a parameter style JAVA procedure

- the source code for a parameter style JAVA procedure
- input and output parameters of data type XML
- use of an XML input parameter in a query
- assignment of the result of an XQuery, an XML value, to an output parameter
- assignment of the result of an SQL statement, an XML value, to an output parameter

### Prerequisites

Before working with this Java procedure example you might want to read the following topics:

- Java routines
- Routines
- Building Java routine code

The following examples make use of a table named `xmlDataTable` defined and containing data as follows:

```
CREATE TABLE xmlDataTable
(
  num INTEGER,
  xdata XML
)@

INSERT INTO xmlDataTable VALUES
(1, XMLPARSE(DOCUMENT '<doc>
                    <type>car</type>
                    <make>Pontiac</make>
                    <model>Sunfire</model>
                    </doc>' PRESERVE WHITESPACE)),
(2, XMLPARSE(DOCUMENT '<doc>
                    <type>car</type>
                    <make>Mazda</make>
                    <model>Miata</model>
                    </doc>' PRESERVE WHITESPACE)),
(3, XMLPARSE(DOCUMENT '<doc>
                    <type>person</type>
                    <name>Mary</name>
                    <town>Vancouver</town>
                    <street>Waterside</street>
                    </doc>' PRESERVE WHITESPACE)),
(4, XMLPARSE(DOCUMENT '<doc>
                    <type>person</type>
                    <name>Mark</name>
                    <town>Edmonton</town>
                    <street>Oak</street>
                    </doc>' PRESERVE WHITESPACE)),
(5, XMLPARSE(DOCUMENT '<doc>
                    <type>animal</type>
                    <name>dog</name>
                    </doc>' PRESERVE WHITESPACE)),
(6, NULL),
(7, XMLPARSE(DOCUMENT '<doc>
                    <type>car</type>
                    <make>Ford</make>
                    <model>Taurus</model>
                    </doc>' PRESERVE WHITESPACE)),
(8, XMLPARSE(DOCUMENT '<doc>
                    <type>person</type>
                    <name>Kim</name>
                    <town>Toronto</town>
                    <street>Elm</street>
                    </doc>' PRESERVE WHITESPACE)),
(9, XMLPARSE(DOCUMENT '<doc>
                    <type>person</type>
```



```

                                <name>Bob</name>
                                <town>Toronto</town>
                                <street>Oak</street>
                                </doc>' PRESERVE WHITESPACE)),
(10, XMLPARSE(DOCUMENT '<doc>
                                <type>animal</type>
                                <name>bird</name>
                                </doc>' PRESERVE WHITESPACE)))@

```

### Procedure

Use the following example as references when making your own Java procedures:

- “The Java external code file”
- “Example 1: Parameter style JAVA procedure with XML parameters”

### The Java external code file

The example shows a Java procedure implementation. The example consists of two parts: the CREATE PROCEDURE statement and the external Java code implementation of the procedure from which the associated Java class can be built.

The Java source file that contains the procedure implementations of the following examples is named `stpclass.java` included in a JAR file named `myJAR`. The file has the following format:

```

using System;
import java.lang.*;
import java.io.*;
import java.sql.*;
import java.util.*;
import com.ibm.db2.jcc.DB2Xml;

public class stpclass
{
    ...
    // Java procedure implementations
    ...
}

```

The Java class file imports are indicated at the top of the file. The `com.ibm.db2.jcc.DB2Xml` import is required if any of the procedures in the file contain parameters or variables of type XML will be used.

It is important to note the name of the class file and JAR name that contains a given procedure implementation. These names are important, because the EXTERNAL clause of the CREATE PROCEDURE statement for each procedure must specify this information so that DB2 database systems can locate the class at run time.

### Example 1: Parameter style JAVA procedure with XML parameters

This example shows the following:

- CREATE PROCEDURE statement for a parameter style JAVA procedure
- Java code for a parameter style JAVA procedure with XML parameters

This procedure takes an input parameter, `inXML`, inserts a row including that value into a table, queries XML data using both an SQL statement and an XQuery expression, and sets two output parameters, `outXML1`, and `outXML2`.

```

CREATE PROCEDURE xmlProc1 ( IN inNUM INTEGER,
                           IN inXML XML as CLOB (1K),
                           OUT out1XML XML as CLOB (1K),

```

```

                                OUT out2XML XML as CLOB (1K)
                                )
DYNAMIC RESULT SETS 0
DETERMINISTIC
LANGUAGE JAVA
PARAMETER STYLE JAVA
MODIFIES SQL DATA
FENCED
THREADSAFE
DYNAMIC RESULT SETS 0
PROGRAM TYPE SUB
NO DBINFO
EXTERNAL NAME 'myJar:stpclass.xmlProc1'@
//*****
// Stored Procedure: XMLPROC1
//
// Purpose:  Inserts XML data into XML column; queries and returns XML data
//
// Parameters:
//
// IN:      inNum -- the sequence of XML data to be insert in xmldata table
//          inXML -- XML data to be inserted
// OUT:     out1XML -- XML data to be returned
//          out2XML -- XML data to be returned
//
//*****
public void xmlProc1(int inNum,
                    DB2Xml inXML ,
                    DB2Xml [] out1XML,
                    DB2Xml [] out2XML
                    )
throws Exception
{
    Connection con = DriverManager.getConnection("jdbc:default:connection");

    // Insert data including the XML parameter value into a table
    String query = "INSERT INTO xmlDataTable (num, inXML ) VALUES ( ?, ? )" ;
    String xmlString = inXML.getDB2String() ;

    stmt = con.prepareStatement(query);
    stmt.setInt(1, inNum);
    stmt.setString (2, xmlString );
    stmt.executeUpdate();
    stmt.close();

    // Query and retrieve a single XML value from a table using SQL
    query = "SELECT xdata from xmlDataTable WHERE num = ? " ;

    stmt = con.prepareStatement(query);
    stmt.setInt(1, inNum);
    ResultSet rs = stmt.executeQuery();

    if ( rs.next() )
    { out1Xml[0] = (DB2Xml) rs.getObject(1); }

    rs.close() ;
    stmt.close();

    // Query and retrieve a single XML value from a table using XQuery
    query = "XQUERY for $x in db2-fn:xmlcolumn(\"xmlDataTable.xdata\")/doc
            where $x/make = \'Mazda\'
            return <carInfo>{$x/make}{$x/model}</carInfo>";

    stmt = con.createStatement();

    rs = stmt.executeQuery( query );

```

```

        if ( rs.next() )
        { out2Xml[0] = (DB2Xml) rs.getObject(1) ; }

        rs.close();
        stmt.close();
        con.close();

        return ;
    }

```

### Example: XML and XQuery support in C# .NET CLR procedure

Once the basics of procedures, the essentials of .NET common language runtime routines, XQuery and XML are understood, you can start creating and using CLR procedures with XML features.

The following example demonstrates a C# .NET CLR procedure with parameters of type XML as well as how to update and query XML data.

#### Prerequisites

Before working with the CLR procedure example you might want to read the following concept topics:

- .NET common language runtime (CLR) routines
- Creating .NET CLR routines from DB2 Command Window
- Benefits of using routines

The following examples makes use of a table named `xmlDataTable` that is defined as follows:

```

CREATE TABLE xmlDataTable
(
    num INTEGER,
    xdata XML
)

INSERT INTO xmlDataTable VALUES
(1, XMLPARSE(DOCUMENT '<doc>
                    <type>car</type>
                    <make>Pontiac</make>
                    <model>Sunfire</model>
                    </doc>' PRESERVE WHITESPACE)),
(2, XMLPARSE(DOCUMENT '<doc>
                    <type>car</type>
                    <make>Mazda</make>
                    <model>Miata</model>
                    </doc>' PRESERVE WHITESPACE)),
(3, XMLPARSE(DOCUMENT '<doc>
                    <type>person</type>
                    <name>Mary</name>
                    <town>Vancouver</town>
                    <street>Waterside</street>
                    </doc>' PRESERVE WHITESPACE)),
(4, XMLPARSE(DOCUMENT '<doc>
                    <type>person</type>
                    <name>Mark</name>
                    <town>Edmonton</town>
                    <street>Oak</street>
                    </doc>' PRESERVE WHITESPACE)),
(5, XMLPARSE(DOCUMENT '<doc>
                    <type>animal</type>
                    <name>dog</name>
                    </doc>' PRESERVE WHITESPACE)),
(6, NULL),
(7, XMLPARSE(DOCUMENT '<doc>
                    <type>car</type>

```

```

                                <make>Ford</make>
                                <model>Taurus</model>
                                </doc>' PRESERVE WHITESPACE)),
(8, XMLPARSE(DOCUMENT '<doc>
                                <type>person</type>
                                <name>Kim</name>
                                <town>Toronto</town>
                                <street>Elm</street>
                                </doc>' PRESERVE WHITESPACE)),
(9, XMLPARSE(DOCUMENT '<doc>
                                <type>person</type>
                                <name>Bob</name>
                                <town>Toronto</town>
                                <street>Oak</street>
                                </doc>' PRESERVE WHITESPACE)),
(10, XMLPARSE(DOCUMENT '<doc>
                                <type>animal</type>
                                <name>bird</name>
                                </doc>' PRESERVE WHITESPACE))@

```

### Procedure

Use the following examples as references when making your own C# CLR procedures:

- “The C# external code file”
- “Example 1: C# parameter style GENERAL procedure with XML features” on page 275

### The C# external code file

The example consists of two parts: the CREATE PROCEDURE statement and the external C# code implementation of the procedure from which the associated assembly can be built.

The C# source file that contains the procedure implementations of the following examples is named `gwenProc.cs` and has the following format:

```

using System;
using System.IO;
using System.Data;
using IBM.Data.DB2;
using IBM.Data.DB2Types;

namespace bizLogic
{
    class empOps
    {
        ...
        // C# procedures
        ...
    }
}

```

The file inclusions are indicated at the top of the file. The `IBM.Data.DB2` inclusion is required if any of the procedures in the file contain SQL. The `IBM.Data.DB2Types` inclusion is required if any of the procedures in the file contains parameters or variables of type XML. There is a namespace declaration in this file and a class `empOps` that contains the procedures. The use of namespaces is optional. If a namespace is used, the namespace must appear in the assembly path name provided in the EXTERNAL clause of the CREATE PROCEDURE statement.

It is important to note the name of the file, the namespace, and the name of the class, that contains a given procedure implementation. These names are important, because the EXTERNAL clause of the CREATE PROCEDURE statement for each

procedure must specify this information so that DB2 database systems can locate the assembly and class of the CLR procedure.

### Example 1: C# parameter style GENERAL procedure with XML features

This example shows the following:

- CREATE PROCEDURE statement for a parameter style GENERAL procedure
- C# code for a parameter style GENERAL procedure with XML parameters

This procedure takes two parameters, an integer inNum and inXML. These values are inserted into the table xmlDataTable. Then an XML value is retrieved using XQuery. Another XML value is retrieved using SQL. The retrieved XML values are assigned to two output parameters, outXML1 and outXML2. No result sets are returned.

```

CREATE PROCEDURE xmlProc1 ( IN inNUM INTEGER,
                           IN inXML XML as CLOB (1K),
                           OUT inXML XML as CLOB (1K),
                           OUT inXML XML as CLOB (1K)
                           )

LANGUAGE CLR
PARAMETER STYLE GENERAL
DYNAMIC RESULT SETS 0
FENCED
THREADSAFE
DETERMINISTIC
NO DBINFO
MODIFIES SQL DATA
PROGRAM TYPE SUB
EXTERNAL NAME 'gwenProc.dll:bizLogic.empOps!xmlProc1' ;

//*****
// Stored Procedure: xmlProc1
//
// Purpose:  insert XML data into XML column
//
// Parameters:
//
// IN:      inNum -- the sequence of XML data to be insert in xmldata table
//          inXML -- XML data to be inserted
// OUT:     outXML1 -- XML data returned - value retrieved using XQuery
//          outXML2 -- XML data returned - value retrieved using SQL
//*****

public static void xmlProc1 (      int      inNum, DB2Xml inXML,
                               out DB2Xml outXML1, out DB2Xml outXML2 )
{
    // Create new command object from connection context
    DB2Parameter parm;
    DB2Command cmd;
    DB2DataReader reader = null;
    outXML1 = DB2Xml.Null;
    outXML2 = DB2Xml.Null;

    // Insert input XML parameter value into a table
    cmd = DB2Context.GetCommand();
    cmd.CommandText = "INSERT INTO "
        + "xmlDataTable( num , xdata ) "
        + "VALUES( ?, ?)";

    parm = cmd.Parameters.Add("@num", DB2Type.Integer );
    parm.Direction = ParameterDirection.Input;
    cmd.Parameters["@num"].Value = inNum;
    parm = cmd.Parameters.Add("@data", DB2Type.Xml);
    parm.Direction = ParameterDirection.Input;
    cmd.Parameters["@data"].Value = inXML ;
}

```

```

cmd.ExecuteNonQuery();
cmd.Close();

// Retrieve XML value using XQuery
// and assign value to an XML output parameter
cmd = DB2Context.GetCommand();
cmd.CommandText = "XQUERY for $x " +
                  "in db2-fn:xmlcolumn(\"xmlDataTable.xdata\")/doc "+
                  "where $x/make = 'Mazda' " +
                  "return <carInfo>{$x/make}{$x/model}</carInfo>";
reader = cmd.ExecuteReader();
reader.CacheData= true;

if (reader.Read())
{ outXML1 = reader.GetDB2Xml(0); }
else
{ outXML1 = DB2Xml.Null; }

reader.Close();
cmd.Close();

// Retrieve XML value using SQL
// and assign value to an XML output parameter value
cmd = DB2Context.GetCommand();
cmd.CommandText = "SELECT xdata "
                  + "FROM xmlDataTable "
                  + "WHERE num = ?";

parm = cmd.Parameters.Add("@num", DB2Type.Integer );
parm.Direction = ParameterDirection.Input;
cmd.Parameters["@num"].Value = inNum;
reader = cmd.ExecuteReader();
reader.CacheData= true;

if (reader.Read())
{ outXML2 = reader.GetDB2Xml(0); }
else
{ outXML = DB2Xml.Null; }

reader.Close() ;
cmd.Close();

return;
}

```

### Example: XML and XQuery support in C procedure

Once the basics of procedures, the essentials of C routines, XQuery and XML are understood, you can start creating and using C procedures with XML features.

The following example demonstrates a C procedure with parameters of type XML as well as how to update and query XML data.

#### Prerequisites

Before working with the C procedure example you might want to read the following concept topic:

- Benefits of using routines

The following examples makes use of a table named `xmlDataTable` that is defined as follows:

```

CREATE TABLE xmlDataTable
(
    num INTEGER,
    xdata XML
)

```

```

INSERT INTO xmlDataTable VALUES
(1, XMLPARSE(DOCUMENT '<doc>
                    <type>car</type>
                    <make>Pontiac</make>
                    <model>Sunfire</model>
                    </doc>' PRESERVE WHITESPACE)),
(2, XMLPARSE(DOCUMENT '<doc>
                    <type>car</type>
                    <make>Mazda</make>
                    <model>Miata</model>
                    </doc>' PRESERVE WHITESPACE)),
(3, XMLPARSE(DOCUMENT '<doc>
                    <type>person</type>
                    <name>Mary</name>
                    <town>Vancouver</town>
                    <street>Waterside</street>
                    </doc>' PRESERVE WHITESPACE)),
(4, XMLPARSE(DOCUMENT '<doc>
                    <type>person</type>
                    <name>Mark</name>
                    <town>Edmonton</town>
                    <street>Oak</street>
                    </doc>' PRESERVE WHITESPACE)),
(5, XMLPARSE(DOCUMENT '<doc>
                    <type>animal</type>
                    <name>dog</name>
                    </doc>' PRESERVE WHITESPACE)),
(6, NULL),
(7, XMLPARSE(DOCUMENT '<doc>
                    <type>car</type>
                    <make>Ford</make>
                    <model>Taurus</model>
                    </doc>' PRESERVE WHITESPACE)),
(8, XMLPARSE(DOCUMENT '<doc>
                    <type>person</type>
                    <name>Kim</name>
                    <town>Toronto</town>
                    <street>Elm</street>
                    </doc>' PRESERVE WHITESPACE)),
(9, XMLPARSE(DOCUMENT '<doc>
                    <type>person</type>
                    <name>Bob</name>
                    <town>Toronto</town>
                    <street>Oak</street>
                    </doc>' PRESERVE WHITESPACE)),
(10, XMLPARSE(DOCUMENT '<doc>
                    <type>animal</type>
                    <name>bird</name>
                    </doc>' PRESERVE WHITESPACE))

```

### Procedure

Use the following examples as references when making your own C procedures:

- “The C external code file”
- “Example 1: C parameter style SQL procedure with XML features” on page 278

### The C external code file

The example consists of two parts: the CREATE PROCEDURE statement and the external C code implementation of the procedure from which the associated assembly can be built.

The C source file that contains the procedure implementations of the following examples is named `gwenProc.SQC` and has the following format:

```
#include <stdio.h>
#include <string.h>
#include <stdlib.h>
#include <sqlca.h>
#include <sqlca.h>
#include <sqludf.h>
#include <sql.h>
#include <memory.h>

// C procedures
...
```

The file inclusions are indicated at the top of the file. There are no extra include files required for XML support in embedded SQL routines.

It is important to note the name of the file and the name of the function that corresponds to the procedure implementation. These names are important, because the `EXTERNAL` clause of the `CREATE PROCEDURE` statement for each procedure must specify this information so that the DB2 database manager can locate the library and entry point that corresponds to the C procedure.

### Example 1: C parameter style SQL procedure with XML features

This example shows the following:

- `CREATE PROCEDURE` statement for a parameter style SQL procedure
- C code for a parameter style SQL procedure with XML parameters

This procedure receives two input parameters. The first input parameter is named `inNum` and is of type `INTEGER`. The second input parameter is named `inXML` and is of type `XML`. The values of the input parameters are used to insert a row into the table `xmlDataTable`. Then an XML value is retrieved using an SQL statement. Another XML value is retrieved using an XQuery expression. The retrieved XML values are respectively assigned to two output parameters, `out1XML` and `out2XML`. No result sets are returned.

```
CREATE PROCEDURE xmlProc1 ( IN inNUM INTEGER,
                           IN inXML XML as CLOB (1K),
                           OUT inXML XML as CLOB (1K),
                           OUT inXML XML as CLOB (1K)
                           )

LANGUAGE C
PARAMETER STYLE SQL
DYNAMIC RESULT SETS 0
FENCED
THREADSAFE
DETERMINISTIC
NO DBINFO
MODIFIES SQL DATA
PROGRAM TYPE SUB
EXTERNAL NAME 'gwenProc!xmlProc1' ;

//*****
// Stored Procedure: xmlProc1
//
// Purpose:  insert XML data into XML column
//
// Parameters:
//
// IN:      inNum -- the sequence of XML data to be insert in xmldata table
//          inXML -- XML data to be inserted
```



```

// OUT:  out1XML -- XML data returned - value retrieved using XQuery
//       out2XML -- XML data returned - value retrieved using SQL
//*****
#ifdef __cplusplus
extern "C"
#endif
SQL_API_RC SQL_API_FN testSecA1(sqlint32* inNum,
                               SQLUDF_CLOB* inXML,
                               SQLUDF_CLOB* out1XML,
                               SQLUDF_CLOB* out2XML,
                               SQLUDF_NULLIND *inNum_ind,
                               SQLUDF_NULLIND *inXML_ind,
                               SQLUDF_NULLIND *out1XML_ind,
                               SQLUDF_NULLIND *out2XML_ind,
                               SQLUDF_TRAIL_ARGS)
{
    char *str;
    FILE *file;

    EXEC SQL INCLUDE SQLCA;

    EXEC SQL BEGIN DECLARE SECTION;
        sqlint32 hvNum1;
        SQL TYPE IS XML AS CLOB(200) hvXML1;
        SQL TYPE IS XML AS CLOB(200) hvXML2;
        SQL TYPE IS XML AS CLOB(200) hvXML3;
    EXEC SQL END DECLARE SECTION;

    /* Check null indicators for input parameters */
    if ((*inNum_ind < 0) || (*inXML_ind < 0)) {
        strcpy(sqludf_sqlstate, "38100");
        strcpy(sqludf_msgtext, "Received null input");
        return 0;
    }

    /* Copy input parameters to host variables */
    hvNum1 = *inNum;
    hvXML1.length = inXML->length;
    strncpy(hvXML1.data, inXML->data, inXML->length);

    /* Execute SQL statement */
    EXEC SQL
        INSERT INTO xmlDataTable (num, xdata) VALUES (:hvNum1, :hvXML1);

    /* Execute SQL statement */
    EXEC SQL
        SELECT xdata INTO :hvXML2
        FROM xmlDataTable
        WHERE num = :hvNum1;

    sprintf(stmt5, "SELECT XMLQUERY('for $x in $xmldata/doc
                                return <carInfo>{$x/model}</carInfo>'
                                passing by ref xmlDataTable.xdata
                                as \"xmldata\" returning sequence)
        FROM xmlDataTable WHERE num = ?");

    EXEC SQL PREPARE selstmt5 FROM :stmt5 ;
    EXEC SQL DECLARE c5 CURSOR FOR selstmt5;
    EXEC SQL OPEN c5 using :hvNum1;
    EXEC SQL FETCH c5 INTO :hvXML3;

    exit:

    /* Set output return code */
    *outReturnCode = sqlca.sqlcode;

```

```

*outReturnCode_ind = 0;
return 0;
}

```

## Performance of routines

The performance of routines is impacted by a variety of factors including the type and implementation of the routine, the number of SQL statements within the routine, the degree of complexity of the SQL in the routine, the number of parameters to the routine, the efficiency of the logic within the routine implementation, the error handling within the routines and more.

Because users often choose to implement routines to improve the performance of applications, it is important to get the most out of routine performance.

The following table outlines some of the general factors that impact routine performance and gives recommendations on how to improve routine performance by altering each factor. For further details on performance factors that impact specific routine types, refer to the performance and tuning topics for the specific routine type.

*Table 33. Performance considerations and routine performance recommendations*

Performance consideration	Performance recommendation
Routine type: procedure, function, method	<ul style="list-style-type: none"> <li>Procedures, functions, and methods serve different purposes and are referenced in different places. Their functional differences make it difficult to compare their performance directly.</li> <li>In general procedures can sometimes be rewritten as functions (particularly if they return a scalar value and only query data) and enjoy slight performance improvements, however these benefits are generally a result of simplifying the SQL required to implement the SQL logic.</li> <li>User-defined functions with complex initializations can make use of scratchpads to store any values required in the first invocation so that they can be used in subsequent invocations.</li> </ul>
Routine implementation: built-in or user-defined	<ul style="list-style-type: none"> <li>For equivalent logic, built-in routines perform the best, followed by built-in routines, because they enjoy a closer relationship with the database engine than do user-defined routines.</li> <li>User-defined routines can perform very well if they are well coded and follow best practices.</li> </ul>

Table 33. Performance considerations and routine performance recommendations (continued)

Performance consideration	Performance recommendation
Routine implementation: SQL or external routine implementation	<ul style="list-style-type: none"> <li>• SQL routines are more efficient than external routines because they are executed directly by the DB2 database server.</li> <li>• SQL procedures generally perform better than logically equivalent external procedures.</li> <li>• For simple logic, SQL function performance will be comparable to that of an equivalent external function.</li> <li>• For complex logic, such as math algorithms and string manipulation functions that require little SQL, it is better to use an external routine in a low level programming language such as C because there is less dependence on SQL support.</li> <li>• See Comparison of routine implementations for a comparison of the features, including performance, of the supported external routine programming language options.</li> </ul>
External routine implementation programming language	<ul style="list-style-type: none"> <li>• See: Comparison of external routine APIs and programming languages for a comparison of the performance features that you should consider when selecting an external routine implementation.</li> <li>• Java (JDBC and SQLJ APIs) <ul style="list-style-type: none"> <li>– Java routines with very large memory requirements are best created with the FENCED NOT THREADSAFE clause specified. Java routines with average memory requirements can be specified with the FENCED THREADSAFE clause.</li> <li>– For fenced threadsafe Java routine invocations, DB2 database systems attempt to choose a threaded Java fenced mode process with a Java heap that is large enough to run the routine. Failure to isolate large heap consumers in their own process can result in out-of-Java-heap errors in multi-threaded Java <b>db2fmp</b> processes. FENCED THREADSAFE routines, in contrast, perform better because they can share a small number of JVMs.</li> </ul> </li> <li>• C and C++ <ul style="list-style-type: none"> <li>– In general C and C++ routines perform better than other external routine implementations and as well as SQL routines.</li> <li>– To perform their best C and C++ routines should be compiled in 32-bit format if they will be deployed to a 32-bit DB2 instance and in 64-bit format if they will be deployed to a 64-bit DB2 instance.</li> </ul> </li> <li>• COBOL <ul style="list-style-type: none"> <li>– In general COBOL performance is good, but COBOL is not a recommended routine implementation.</li> </ul> </li> </ul>

Table 33. Performance considerations and routine performance recommendations (continued)

Performance consideration	Performance recommendation
Number of SQL statements within the routine	<ul style="list-style-type: none"> <li>• Routines should contain more than one SQL statement, otherwise the overhead of routine invocation is not performance cost effective.</li> <li>• Logic that must make several database queries, process intermediate results, and ultimately return a subset of the data that was worked with is the best logic for routine encapsulation. Complex data mining, and large updates requiring lookups of related data are examples of this type of logic. Heavy SQL processing is done on the database server and only the smaller data result set is passed back to the caller.</li> </ul>
Complexity of SQL statements within the routine	<ul style="list-style-type: none"> <li>• It makes good sense to include very complex queries within your routines so that you capitalize on the greater memory and performance capabilities of the database server.</li> <li>• Do not worry about the SQL statements being overly complex.</li> </ul>
Static or dynamic SQL execution within routines	<ul style="list-style-type: none"> <li>• In general static SQL performs better than dynamic SQL. In routines there are no additional differences when you use static or dynamic SQL.</li> </ul>
Number of parameters to routines	<ul style="list-style-type: none"> <li>• Minimizing the number of parameters to routines can improve routine performance as this minimizes the number of buffers to be passed between the routine and routine invoker.</li> </ul>
Data types of routine parameters	<ul style="list-style-type: none"> <li>• You can improve the performance of routines by using VARCHAR parameters instead of CHAR parameters in the routine definition. Using VARCHAR data types instead of CHAR data types prevents DB2 database systems from padding parameters with spaces before passing the parameter and decreases the amount of time required to transmit the parameter across a network.  For example, if your client application passes the string "A SHORT STRING" to a routine that expects a CHAR(200) parameter, the DB2 database system has to pad the parameter with 186 spaces, null-terminate the string, then send the entire 200 character string and null-terminator across the network to the routine.  In comparison, passing the same string, "A SHORT STRING", to a routine that expects a VARCHAR(200) parameter results in the DB2 database system simply passing the 14 character string and a null terminator across the network.</li> </ul>
Initialization of parameters to routines	<ul style="list-style-type: none"> <li>• It is a good idea to always initialize input parameters to routines, particularly if the input routine parameter values are null. For null value routine parameters, a shorter or empty buffer can be passed to the routine instead of a full sized buffer, which can improve performance.</li> </ul>

Table 33. Performance considerations and routine performance recommendations (continued)

Performance consideration	Performance recommendation
Number of local variables in routines	<ul style="list-style-type: none"> <li>• Minimizing the number of local variables declared within a routine can improve performance by minimizing the number of SQL statements executed within the routine.</li> <li>• In general aim to use as few variables as possible. Re-use variables if this will not be semantically confusing.</li> </ul>
Initialization of local variables in routines	<ul style="list-style-type: none"> <li>• If possible, it is a good practice to initialize multiple local variables within a single SQL statement as this saves on the total SQL execution time for the routine.</li> </ul>
Number of result sets returned by procedures	<ul style="list-style-type: none"> <li>• If you can reduce the number of result sets returned by a routine you can improve routine performance.</li> </ul>
Size of result sets returned by routines	<ul style="list-style-type: none"> <li>• Make sure that for each result set returned by a routine, the query defining the result filters the columns returned and the number of rows returned as much as possible. Returning unnecessary columns or rows of data is not efficient and can result in sub-optimal routine performance.</li> </ul>
Efficiency of logic within routines	<ul style="list-style-type: none"> <li>• As with any application, the performance of a routine can be limited by a poorly implemented algorithm. Aim to be as efficient as possible when programming routines and apply generally recommended coding best practices as much as possible.</li> <li>• Analyze your SQL and wherever possible reduce your query to its simplest form. This can often be done by using CASE expressions instead of CASE statements or by collapsing multiple SQL statements into a single statement that uses a CASE expression as a switch.</li> </ul>

Table 33. Performance considerations and routine performance recommendations (continued)

Performance consideration	Performance recommendation
Run-time mode of routine (FENCED or NOT FENCED clause specification)	<p><b>NOT FENCED clause usage:</b></p> <ul style="list-style-type: none"> <li>• In general, creating your routine with the NOT FENCED clause, which makes it runs in the same process as the DB2 database manager, is preferable over creating it with the FENCED clause, which makes it run in a special DB2 database process outside of the engine's address space.</li> <li>• While you can expect improved routine performance when running routines as not fenced, user code in unfenced routines can accidentally or maliciously corrupt the database or damage the database control structures. You should only use the NOT FENCED clause when you need to maximize performance benefits, and if you deem the routine to be secure. (For information on assessing and mitigating the risks of registering C/C++ routines as NOT FENCED, refer to Security of routines. If the routine is not safe enough to run in the database manager's process, use the FENCED clause when creating the routine. To limit the creation and running of potentially unsafe code, the DB2 database system requires that a user have a special privilege, CREATE_NOT_FENCED_ROUTINE in order to create NOT FENCED routines.</li> <li>• If an abnormal termination occurs while you are running a NOT FENCED routine, the database manager will attempt an appropriate recovery if the routine is registered as NO SQL. However, for routines not defined as NO SQL, the database manager will fail.</li> <li>• NOT FENCED routines must be precompiled with the WCHARTYPE NOCONVERT option if the routine uses GRAPHIC or DBCLOB data.</li> </ul>

Table 33. Performance considerations and routine performance recommendations (continued)

Performance consideration	Performance recommendation
Run-time mode of routine (FENCED or NOT FENCED clause specification)	<p><b>FENCED THREADSAFE clause usage</b></p> <ul style="list-style-type: none"> <li>• Routines created with the FENCED THREADSAFE clause run in the same process as other routines. More specifically, non-Java routines share one process, while Java routines share another process, separate from routines written in other languages. This separation protects Java routines from the potentially more error prone routines written in other languages. Also, the process for Java routines contains a JVM, which incurs a high memory cost and is not used by other routine types. Multiple invocations of FENCED THREADSAFE routines share resources, and therefore incur less system overhead than FENCED NOT THREADSAFE routines, which each run in their own dedicated process.</li> <li>• If you feel your routine is safe enough to run in the same process as other routines, use the THREADSAFE clause when registering it. As with NOT FENCED routines, information on assessing and mitigating the risks of registering C/C++ routines as FENCED THREADSAFE is in the topic, "Security considerations for routines".</li> <li>• If a FENCED THREADSAFE routine abnormally ends, only the thread running this routine is terminated. Other routines in the process continue running. However, the failure that caused this thread to abnormally end can adversely affect other routine threads in the process, causing them to trap, hang, or have damaged data. After one thread abends, the process is no longer used for new routine invocations. Once all the active users complete their jobs in this process, it is terminated.</li> <li>• When you register Java routines, they are deemed THREADSAFE unless you indicate otherwise. All other LANGUAGE types are NOT THREADSAFE by default. Routines using LANGUAGE OLE and OLE DB cannot be specified as THREADSAFE.</li> <li>• NOT FENCED routines must be THREADSAFE. It is not possible to register a routine as NOT FENCED NOT THREADSAFE (SQLCODE -104).</li> <li>• Users on UNIX can see their Java and C THREADSAFE processes by looking for <b>db2fmp</b> (Java) or <b>db2fmp</b> (C).</li> </ul>

Table 33. Performance considerations and routine performance recommendations (continued)

Performance consideration	Performance recommendation
Run-time mode of routine (FENCED or NOT FENCED clause specification)	<p><b>FENCED NOT THREADSAFE mode</b></p> <ul style="list-style-type: none"> <li>FENCED NOT THREADSAFE routines each run in their own dedicated process. If you are running numerous routines, this can have a detrimental effect on database system performance. If the routine is not safe enough to run in the same process as other routines, use the NOT THREADSAFE clause when registering the routine.</li> <li>On UNIX, NOT THREADSAFE processes appear as db2fmp (<i>pid</i>) (where <i>pid</i> is the process id of the agent using the fenced mode process) or as db2fmp (idle) for a pooled NOT THREADSAFE <b>db2fmp</b>.</li> </ul>
Level of SQL access in routine: NO SQL, CONTAINS SQL, READS SQL DATA, MODIFIES SQL DATA	<ul style="list-style-type: none"> <li>Routines that are created with a lower level of SQL access clause will perform better than routines created with a higher level of SQL access clause. Therefore you should declare your routines with the most restrictive level of SQL access clause. For example, if your routine only reads SQL data, do not create it with the MODIFIES SQL DATA clause, but rather create it with the more restrictive READS SQL DATA clause.</li> </ul>
Determinism of routine (DETERMINISTIC or NOT DETERMINISTIC clause specification)	<ul style="list-style-type: none"> <li>Declaring a routine with the DETERMINISTIC or NOT DETERMINISTIC clause has no impact on routine performance.</li> </ul>
Number and complexity of external actions made by routine (EXTERNAL ACTION clause specification)	<ul style="list-style-type: none"> <li>Depending on the number of external actions and the complexity of external actions performed by an external routine, routine performance can be hindered. Factors that contribute to this are network traffic, access to files for writing or reading, the time required to execute the external action, and the risk associated with hangs in external action code or behaviors.</li> </ul>
Routine invocation when input parameters are null (CALLED ON NULL INPUT clause specification)	<ul style="list-style-type: none"> <li>If receiving null input parameter values results in no logic being executed and an immediate return by the routine, you can modify your routine so that it is not fully invoked when null input parameter values are detected. To create a routine that ends invocation early if routine input parameters are received, create the routine and specify the CALLED ON NULL INPUT clause.</li> </ul>
Procedure parameters of type XML	<ul style="list-style-type: none"> <li>The passing of parameters of data type XML is significantly less efficient in external procedures implemented in either the C or JAVA programming language than in SQL procedures. When passing one or more parameters of data type XML, consider using SQL procedures instead of external procedures.</li> <li>XML data is materialized when passed to stored procedures as IN, OUT, or INOUT parameters. If you are using Java stored procedures, the heap size (<b>java_heap_sz</b> configuration parameter) might need to be increased based on the quantity and size of XML arguments, and the number of external stored procedures that are being executed concurrently.</li> </ul>



Once routines are created and deployed, it might be harder to determine what environmental and routine specific factors are impacting routine performance, and hence it is important to design routines with performance in mind.

---

## Sample applications

### pureXML Samples

The pureXML feature enables well-formed XML documents to be stored in their hierarchical format within columns of a table. XML columns are defined with the new XML data type. Because the pureXML feature is fully integrated into the DB2 database system, the stored XML data can be accessed and managed by leveraging DB2 functionality. This functionality includes administration support, application development support and efficient search and retrieval of XML via support for XQuery, SQL or a combination of SQL/XML functions.

There are various samples provided to demonstrate the XML support; these are broadly categorized as:

#### Administration samples

These samples demonstrate the following features:

- XML schema support : Schema registration and validation of XML documents
- XML data indexing support : Indexes on different node types of XML value
- Utility support for XML : Import , export, runstats, db2look, and db2batch support for the XML data type

#### Application Development samples

These samples demonstrate the following features:

- XML insert, update, and delete : Inserting XML values in XML typed columns, updating and deleting existing values
- XML parsing, validation, and serialization support : Implicit and explicit parsing of compatible data types, validating an XML document, serializing XML data
- Hybrid use of SQL and XQuery : Using SQL/XML functions like XMLTABLE, XMLQUERY and the XMLEXISTS predicate
- XML data type support in SQL and external procedures: Passing XML data to SQL and external procedures by including parameters of data type XML
- Annotated XML schema decomposition support : Decomposing an XML document based on annotated XML schemas
- XML publishing functions : Using functions to construct XML values

#### XQuery samples

These samples demonstrate the use of axes, FLWOR expressions, and queries written with XQuery and SQL/XML.

These samples can be found in the following location:

- On Windows: %DB2PATH%\sql11ib\samples\xml (where %DB2PATH% is a variable that determines where DB2 database server is installed)
- On UNIX: \$HOME/sql11ib/samples/xml (where \$HOME is the home directory of the instance owner)

## pureXML - Administration samples

These samples demonstrate pureXML support for various administration features, including: XML schema support, Utility support, XML data indexing support.

These samples are available in various programming languages and can be found in the language specific sub-directories in the following location:

- On Windows: %DB2PATH%\sql11ib\samples\xml (where %DB2PATH% is a variable that determines where DB2 database server is installed)
- On UNIX: \$HOME/sql11ib/samples/xml (where \$HOME is the home directory of the instance owner)

*Table 34. XML schema support - Samples for schema registration, validation and compatible schema evolution*

Samples By Language	Sample program name	Program description
CLI	xsupdate.c	Update a registered XML schema ensuring that the original and the new schemas are compatible.
C	xmlschema.sqc	Register the XML schema to the database and use the registered schema to validate and insert an XML document.
CLP	xmlschema.db2	Register the XML schema to the database and use the registered schema to validate and insert an XML document.
	xsupdate.db2	Update a registered XML schema ensuring that the original and the new schemas are compatible.
JDBC	XmlSchema.java	Register the XML schema to the database and use the registered schema to validate and insert an XML document.
	XsUpdate.java	Update a registered XML schema ensuring that the original and the new schemas are compatible.
SQLJ	XmlSchema.sqlj	Register the XML schema to the database and use the registered schema to validate and insert an XML document.

Table 35. Utility support: Samples for Import, export, runstats, db2look, reorg and db2batch support for XML data type

Samples By Language	Sample program name	Program description
C	xmlrunstats.sqc	Perform RUNSTATS on a table containing XML type columns.
	lobstoxml.sqc	Move LOB data into an XML column using IMPORT and EXPORT commands.
	impexpxml.sqc	Import and Export XML documents.
	xmlload.sqc	Load XML documents into DB2 tables using the various LOAD command options.
CLP	xmlrunstats.db2	Perform RUNSTATS on a table containing XML type columns.
	xmlolic.db2	Reorganizes the indexes defined on a table and how to reorganize nonpartitioned indexes on a range-partitioned table.
	xmldb2batch.db2	db2batch support for XML datatype.
	xmldb2look.db2	db2look support for XML datatype.
	lobstoxml.db2	Move LOB data into an XML column using IMPORT and EXPORT commands.
	impexpxml.db2	Import and Export XML documents.
	xmlload.db2	Load XML documents into DB2 tables using the various LOAD command options.
JDBC	XmlRunstats.java	Perform RUNSTATS on a table containing XML type columns.

Table 36. XML data indexing support: Samples for indices over XML data

Samples By Language	Sample program name	Program description
C	xmlindex.sqc	Create an index and use it in an XQuery query.
	xmlconst.sqc	Create an index with UNIQUE and VARCHAR length constraints using XML patterns.
CLI	xmlindex.c	Create an index and use it in an XQuery query.
	xmlconst.c	Create an index with UNIQUE and VARCHAR length constraints using XML patterns.
CLP	xmlindex.db2	Create an index and use it in an XQuery query.
	xmlconst.db2	Create an index with UNIQUE and VARCHAR length constraints using XML patterns.

Table 36. XML data indexing support: Samples for indices over XML data (continued)

Samples By Language	Sample program name	Program description
JDBC	XmlIndex.java	Create an index and use it in an XQuery query.
	XmlConst.java	Create an index with UNIQUE and VARCHAR length constraints using XML patterns.
SQLJ	XmlIndex.sqlj	Create an index and use it in an XQuery query.
	XmlConst.sqlj	Create an index with UNIQUE and VARCHAR length constraints using XML patterns.

## pureXML - Application Development samples

These samples demonstrate XML support for application development features such as insert, update, and delete, XML parsing, validation, and serialization, hybrid use of SQL/XML, XML data type support in SQL and external stored procedures, XML decomposition, SQL/XML publishing functions.

These samples are available in various programming languages and can be found in the language specific sub-directories in the following location:

- On Windows: %DB2PATH%\sql11ib\samples\xml (where %DB2PATH% is a variable that determines where DB2 database server is installed)
- On UNIX: \$HOME/sql11ib/samples/xml (where \$HOME is the home directory of the instance owner)

Table 37. pureXML - Application development samples

Samples by language	Sample program name	Program description
CLI	xmlinsert.c	Insert an XML document into a column of XML datatype.
	xmlupdel.c	Update and delete XML documents in the tables.
	xmlread.c	Read XML data stored in tables.
	reltoxml.doc.c	Create an XML document directly from data stored in relational tables using various SQL/XML publishing functions.
	xmltotable.c	Insert the data from an XML document into relational tables using SQL/XML functions like XMLTABLE, XMLQUERY and the XMLEXISTS predicate.
	simple_xmlproc.c	Simple stored procedure with XML type parameters.
	simple_xmlproc_client.c	Client program to call the routine in simple_xmlproc.c.
	simple_xmlproc_create.db2	CLP script to register the stored procedure in simple_xmlproc.c
	simple_xmlproc_drop.db2	CLP script to drop the stored procedure in simple_xmlproc.c

Table 37. pureXML - Application development samples (continued)

Samples by language	Sample program name	Program description
C	xmlinsert.sqc	Insert an XML document into a column of XML datatype.
	xmludfs.sqc	Pass the XML data type as an input parameter, declare XML data type local variables, and return values when using scalar functions, sourced functions, SQL-bodied UDFs and table UDFs.
	xmludfs.c	Pass the XML data type as an input parameter, declare XML data type local variables, and return values when using scalar functions, sourced functions, SQL-bodied UDFs and table UDFs.
	xmlupdel.sqc	Update and delete XML documents in the tables.
	xmlread.sqc	Read XML data stored in tables.
	reltoxmltype.sqc	Create an XML object from data stored in relational tables using various SQL/XML publishing functions.
	xmldecomposition.sqc	Decompose data stored in an XML file and insert the data into tables. Specify the order of insertion to be used during XML document shredding.
	recxmldecomp.sqc	Register a recursive XML schema to the XSR and enable it for decomposition.
	simple_xmlproc.sqc	Simple stored procedure with XML type parameters.
	simple_xmlproc_client.db2	CLP script to call the routine in simple_xmlproc.sqc
	simple_xmlproc_create.db2	CLP script to register the stored procedure in simple_xmlproc.sqc
	simple_xmlproc_drop.db2	CLP script to drop the stored procedure in simple_xmlproc.sqc
	xmltrig.sqc	Use the trigger processing capability for enforced automatic validation of incoming XML documents.
	xmlintegrate.sqc	Use the XMLROW and XMLGROUP functions for mapping relational data to XML. Demonstrate XMLQuery default passing mechanism and the default column specification for XMLTABLE.

Table 37. pureXML - Application development samples (continued)

Samples by language	Sample program name	Program description
	xmlcheckconstraint.sqc	Create tables with check constraints on an XML column using IS VALIDATED and IS NOT VALIDATED predicates and specify one or more schemas using the ACCORDING TO XMLSCHEMA clause.
	xmlxslt.sqc	Use the XSLTRANSFORM function to convert XML documents residing in the database into HTML, plain text, or other forms of XML using style sheets.
CLP	xmlinsert.db2	Insert an XML document into a column of XML datatype.
	xrpart.db2	Use of XML in range partitioned tables and support for local and global indexes.
	xmlpartition.db2	Use of XML in partitioned database environment, MDC and range partitioned tables.
	xmlmdc.db2	Moves data from MDC to non-MDC tables and use of block indexes, global indexes, and faster insertion and deletion.
	xmludfs.db2	Pass the XML data type as an input parameter, and return values when using scalar functions, sourced functions, SQL-bodied UDFs and table UDFs.
	xmldbafn.db2	Use of inline DBA functions to determine the estimated inline length for XML documents.
	xmlolic.db2	Reorganizes the indexes defined on a table and how to reorganize nonpartitioned indexes on a range-partitioned table.
	xmlindgtt.db2	Use of declared global temporary tables with the XML data type.
	xmlupdel.db2	Update and delete XML documents in the tables.
	reltoxml.doc.db2	Create an XML document directly from data stored in relational tables using various SQL/XML publishing functions.
	reltoxml.type.db2	Create an XML object from data stored in relational tables using various SQL/XML publishing functions.

Table 37. pureXML - Application development samples (continued)

Samples by language	Sample program name	Program description
	xmldecomposition.db2	Decompose data stored in an XML file and insert the data into tables. Specify the order of insertion to be used during XML document shredding.
	recxmldecomp.db2	Register a recursive XML schema to the XSR and enable it for decomposition.
	simple_xmlproc.db2	Simple stored procedure with XML type parameters
	xmltotable.db2	Insert the data from an XML document into relational tables using SQL/XML functions like XMLTABLE, XMLQUERY and the XMLEXISTS predicate.
	xmltrig.db2	Use the trigger processing capability for enforced automatic validation of incoming XML documents.
	xmlintegrate.db2	Use the XMLROW and XMLGROUP functions for mapping relational data to XML. Demonstrate XMLQuery default passing mechanism and the default column specification for XMLTABLE..
	xmlcheckconstraint.db2	Create tables with check constraints on an XML column using IS VALIDATED and IS NOT VALIDATED predicates and specify one or more schemas using the ACCORDING TO XMLSCHEMA clause.
	xmlxslt.db2	Use the XSLTRANSFORM function to convert XML documents residing in the database into HTML, plain text, or other forms of XML using style sheets.
JDBC	XmlInsert.java	Insert an XML document into a column of XML datatype.
	XmlMdc.java	Moves data from MDC to non-MDC tables and use of block indexes, global indexes, and faster insertion and deletion.
	XmlUdfs.java	Pass the XML data type as an input parameter, and return values when using scalar functions, sourced functions, SQL-bodied UDFs and table UDFs.
	XmlUpDel.java	Update and delete XML documents in the tables.

Table 37. pureXML - Application development samples (continued)

Samples by language	Sample program name	Program description
	XmlRead.java	Read XML data stored in tables.
	RelToXmlDoc.java	Create an XML document directly from data stored in relational tables using SQL/XML publishing functions.
	RelToXmlType.java	Create an XML object from data stored in relational tables using various SQL/XML publishing functions.
	XmlDecomposition.java	Decompose data stored in an XML file and insert the data into tables. Specify the order of insertion to be used during XML document shredding.
	RecXmlDecomp.java	Register a recursive XML schema to the XSR and enable it for decomposition.
	Simple_XmlProc.java	Simple stored procedure with XML type parameters.
	Simple_XmlProc_Client.java	Client program to call the routine in Simple_XmlProc.java.
	Simple_XmlProc_Create.db2	CLP script to register the stored procedure in Simple_XmlProc.java
	Simple_XmlProc_Drop.db2	CLP script to drop the stored procedure in Simple_XmlProc.java
	XmlToTable.java	Insert the data from an XML document into relational tables using SQL/XML functions like XMLTABLE, XMLQUERY and the XMLEXISTS predicate.
	XmlTrig.java	Use the trigger processing capability for enforced automatic validation of incoming XML documents.
	XmlCheckConstraint.java	Create tables with check constraints on an XML column using IS VALIDATED and IS NOT VALIDATED predicates and specify one or more schemas using the ACCORDING TO XMLSCHEMA clause.
SQLJ	XmlInsert.sqlj	Insert an XML document into a column of XML datatype.
	XmlUpDel.sqlj	Update and delete XML documents in the tables.
	XmlRead.sqlj	Read XML data stored in tables.



Table 37. pureXML - Application development samples (continued)

Samples by language	Sample program name	Program description
	RelToXmlDoc.sqlj	Create an XML document directly from data stored in relational tables using SQL/XML publishing functions.
	RelToXmlType.sqlj	Create an XML object from data stored in relational tables using SQL/XML publishing functions.
	XmlToTable.sqlj	Insert the data from an XML document into relational tables using SQL/XML functions like XMLTABLE, XMLQUERY and the XMLEXISTS predicate.
	XmlIntegrate.sqlj	Use the XMLROW and XMLGROUP functions for mapping relational data to XML. Demonstrate XMLQuery default passing mechanism and the default column specification for XMLTABLE..
	XmlXslt.sqlj	Use the XSLTRANSFORM function to convert XML documents residing in the database into HTML, plain text, or other forms of XML using style sheets.
PHP	XmlFlwor_DB2.php	Use the XQuery FLWOR expression.
	XmlIndex_DB2.php	Create an index and use it in an XQuery.
	XmlInsert_DB2.php	Insert an XML document into a column of XML data type.
	XmlRead_DB2.php	Read XML data stored in tables.
	XmlRelToXmlDOC_DB2.php	Create XML document directly from data stored in relational tables using SQL/XML publishing functions.
	XmlRelToXmlType_DB2.php	Create an XML document from relational and XML data using SQL/XML publishing functions.
	XmlRunstats_DB2.php	Perform RUNSTATS on a table containing XML type columns..
	XmlSchema_DB2.php	Register the XML schema to the database and use the registered schema to validate and insert XML documents.
	XmlSQLXQuery_DB2.php	Use SQL/XML queries.
	XmlUniqueIndexes_DB2.php	Create an index with UNIQUE and VARCHAR length constraints.
	XmlUpAndDe1_DB2.php	Update and delete XML documents in the tables.

Table 37. pureXML - Application development samples (continued)

Samples by language	Sample program name	Program description
	XmlToTable_DB2.php	Insert the data from an XML document into relational tables using SQL/XML.
	XmlXPath_DB2.php	Run simple XPath queries.
	XmlXQuery_DB2.php	Execute nested XQuery FLWOR expressions.

---

## Chapter 11. XML performance

The following topics include performance tuning considerations that you can follow when working with the pureXML feature.

**Related information:**

 15 best practices for pureXML performance in DB2

---

### The pureXML feature and data organization schemes

Using the pureXML feature with data organization schemes such as database partitioning environments, table partitioning, and multidimensional clustering, can significantly improve query performance and reduce the overhead of data maintenance operations such as reorganization, insertion, and deletion.

There are three clauses of the CREATE TABLE statement that include an algorithm to indicate how the data should be organized:

- DISTRIBUTE BY to spread data evenly across database partitions in a partitioned database environment (database partitioning).
- PARTITION BY to specify the table partitioning scheme for a table (table partitioning).
- ORGANIZE BY to specify a dimension for each column or group of columns used to cluster the table data (multidimensional clustering).

See "Restrictions on the pureXML feature" and "Restrictions on indexes over XML" for information about restrictions when using the pureXML feature.

#### Partitioned database environments

When using tables in a partitioned database environment, tables containing XML columns can be stored in a multi-partition database on multiple machines. The XML data can be managed using the DB2 pureXML feature.

When the XML data is distributed across database partitions, multiple processors on multiple machines can process requests for information. Data retrieval and update requests are decomposed automatically into sub-requests, and executed in parallel among the applicable database partitions.

#### Partitioned tables

A partitioned table can contain one or more columns with the XML data type and one or more indexes over XML data. The user-created indexes over XML data can be partitioned or nonpartitioned. A partitioned index reduces the overhead of data maintenance operations in environments when you use the ATTACH PARTITION and DETACH PARTITION clauses of the ALTER TABLE statement for the roll-in and rollout of table data.

#### Multidimensional clustering tables

A multidimensional clustering (MDC) table can contain one or more columns with an XML data type, and one or more indexes over XML data on an XML column can be created. An index over XML data can be used with an MDC block index to

improve query performance. Also, index ANDing can be performed using an MDC block index with an index over XML data.

---

## Example using XQuery transform in a partitioned database environment

The XQuery transform expression is supported in a partitioned database environment and can be used in scenarios that use extract, transform, and load (ETL) operations.

For example, when XML data is extracted from the result of a join between two source tables, ORDERS and PRODUCT, transformed into a wanted format, and inserted as XML data into a target table SALES, an XQuery transform expression can be used. However, a transform expression performs best if the input to the expression references only a single table rather than a join of several source tables.

When using an XQuery transform expression with multiple tables, writing a single statement in which the transform expression is applied directly to the join result generally yields acceptable performance if the join result is small relative to the size of the source tables. However, if the number of rows produced by the join is comparable to or larger than the number of rows in the source tables, you should consider splitting the join and the transform expression into two statements.

The following example demonstrates a general technique for splitting a single statement that uses a join and an XQuery transform operation into two statements. The two statements ensure that the transform operation can be parallelized in a partitioned database environment. The technique uses the following steps:

1. Create a new intermediate table in the same partition group having the same distribution key as the target table. The intermediate table can be a declared global temporary table.
2. Extract the data from the multiple source tables and insert it into the intermediate table.
3. Transform the XML data from the intermediate table and insert the transformed data into the target table.

Both steps 2 and 3 can take advantage of the parallel processing available in a partitioned database environment to be scalable. A nested transform expression should be avoided in Step 3.

### Tables and data used in the example

The example uses the source tables ORDERS and PRODUCTS, the target table SALES, and a declared global temporary table TEMPSALES. The example retrieves data from the ORDER table, joins the data with pricing information from the PRODUCTS table, formats the resulting data, and inserts the formatted data into the SALES table.

The ORDERS table contains the daily orders, with order ID (OID) and order information in an XML column (ORDERDETAIL). Each XML document contains a customer ID (Cid) and the products ordered. The information for each product ordered includes the product ID, quantity, and delivery requirements. The following CREATE statement creates the example ORDERS table:

```
CREATE TABLE ORDERS(OID BIGINT, ORDERDETAIL XML)DISTRIBUTE BY HASH (OID);
```

The following INSERT statement inserts a sample order into the ORDERS table:

```

INSERT into ORDERS
values (5003, '<order>
    <cid>1001</cid>
    <product>
        <pid>2344</pid><qty>10</qty>
        <delivery>Overnight</delivery>
    </product>
    <product>
        <pid>537</pid><qty>3</qty>
        <delivery>Ground</delivery>
    </product>
</order>');

```

The PRODUCTS table contains product information, product ID (PID) product price (PRICE), and details about the product in an XML column (PRODDetail). The following CREATE statement creates the example PRODUCTS table:

```
CREATE TABLE PRODUCTS(PID BIGINT, PRICE FLOAT, PRODDetail XML);
```

The following INSERT statements inserts product data into the PRODUCTS table:

```

INSERT into PRODUCTS
values(2344, 4.99, '<product>
    <name>10 D-Cell batteries</name>
    <desc>D Cell battery, 10-pack</desc>
</product>')

```

```

INSERT into PRODUCTS
values(537, 8.99, '<product>
    <name>Ice Scraper, small</name>
    <desc>Basic ice scraper, 4 inches wide</desc>
</product>');

```

The SALES table contains an order ID (OID), a customer ID (CID), product ID information (PID), the total amount of the order (ITEMTOTAL), and details about each order stored in an XML column (SALEDETAIL). Each row in the SALES table contains information about an individual product ordered. The SALES table is distributed on the order ID (OID) column. The following CREATE statement creates the example SALES table:

```
CREATE TABLE SALES(OID BIGINT, CID BIGINT, PID BIGINT, ITEMTOTAL FLOAT,
    SALEDETAIL XML) DISTRIBUTE BY HASH (OID);
```

## A table join and XQuery transform expression in a single statement

The following INSERT statement joins ORDER and PRODUCT data, applies a transform expression to the resulting XML documents, and inserts the updated documents into the SALES table:

```

INSERT into SALES
select T.OID, T.CID, T.PID, T.ITEMTOTAL,
    XMLQUERY('
    copy $new := $temp
    modify (do delete ($new/info/cid,
    $new/info/product/pid,
    $new/info/product/qty),
    do insert <orderdate>{fn:current-date()}</orderdate>
    as first into $new/info)
    return $new' passing T.SALEDETAIL as "temp")
from(
SELECT O.OID, OX.CID, OX.PID, P.PRICE * OX.QTY, OX.SALEDETAIL
FROM PRODUCTS P,
    ORDERS O,
    XMLTABLE('for $i in $details/order/product
    return document{<info> {$details/order/cid} {$i} </info>')

```

```

        passing O.ORDERDETAIL as "details"
columns
  CID bigint path './info/cid',
  PID bigint path './info/product/pid',
  QTY int    path './info/product/qty',
  SALESDETAIL xml path './') as OX
WHERE P.PID = OX.PID) as T(OID, CID, PID, ITEMTOTAL, SALESDETAIL);

```

The next section demonstrates how the table join and the XQuery transform performed in the previous statement can be performed in two separate statements.

## A table join and XQuery transform expression in separate statements

If the result of the join in the second half of the statement in “A table join and XQuery transform expression in a single statement” on page 299 is significant compared to the size of the ORDER and PRODUCT tables, splitting the statement into two statements improves performance. When splitting the single statement into two, the first statement inserts the results of the join between the ORDER and PRODUCT tables into a temporary table. The second statement applies the transform to the XML documents in the temporary table and inserts the updated documents into the SALES table.

The temporary table is like the SALES table and stores intermediate query results. The declared global temporary table TEMPSALES is used to process the daily orders. In order for the DB2 optimizer to properly optimize the queries used to update the temporary table and the SALES table, the temporary table TEMPSALES and the target table SALES must have the same distribution keys and belong to the same partition group. The following DECLARE statement creates the temporary table TEMPSALES:

```

DECLARE GLOBAL TEMPORARY TABLE SESSION.TEMPSALES LIKE SALES
DISTRIBUTE BY HASH (OID);

```

The following SELECT statement contains a join between the PRODUCTS and ORDERS tables. The statement calculates the values for the ITEMTOTAL column using information from the PRODUCTS and ORDERS tables, and constructs XML documents that are inserted into the TEMPSALES table. The join is the same as the one in the INSERT statement in “A table join and XQuery transform expression in a single statement” on page 299.

```

INSERT INTO SESSION.TEMPSALES
SELECT O.OID, OX.CID, OX.PID, P.PRICE * OX.QTY, OX.SALESDETAIL
FROM PRODUCTS P,
     ORDERS O,
     XMLTABLE('for $i in $details/order/product
              return document{<info> {$details/order/cid} {$i} </info>}'
              passing O.ORDERDETAIL as "details"
columns
  CID bigint path './info/cid',
  PID bigint path './info/product/pid',
  QTY int    path './info/product/qty',
  SALESDETAIL xml path './') as OX
WHERE P.PID = OX.PID;

```

The previous SELECT statement used by the INSERT statement does not contain an XQuery transform expression.

The temporary table contains the relational information needed for the SALES table. In the XML documents in the temporary table, the product information needs to be removed and an order date needs to be added.

The following INSERT statement selects the daily sales information from the temporary table and inserts the information into the table SALES. The INSERT statement contains a SELECT statement that uses the same XQuery transform expression as in the INSERT statement in “A table join and XQuery transform expression in a single statement” on page 299. The expression modifies each XML document from the temporary table before inserting the document into the SALES table. Because the TEMPSALES and SALES tables are located in the same partition group and share a common distribution key, the insert can be parallelized.

```
INSERT into SALES
select T.OID, T.CID, T.PID, T.ITEMTOTAL,
XMLQUERY('
  copy $new := $temp
  modify (do delete ($new/info/cid,
    $new/info/product/pid,
    $new/info/product/qty),
  do insert <orderdate>{fn:current-date()}</orderdate>
  as first into $new/info)
  return $new' passing T.SALESDETAIL as "temp")
from SESSION.TEMPSALES T;
```

---

## Using declared temporary tables with XML data

Declared global temporary tables can be useful when implementing solutions that require the creation of non-persistent tables. For example, an application can create a declared temporary table to process intermediate results. When the application session ends, the temporary table is dropped.

A declared global temporary table exists only for the session during which it was declared. The table cannot be shared with other sessions. When the session ends, the rows of the table are deleted, and the description of the temporary table is dropped. Declared temporary tables do not have catalog contention issues because there is no catalog entry for declared temporary tables.

Declared global temporary table can contain XML columns and XML data can be queried and updated. Declared global temporary tables can also be used in a partitioned database environment. When the temporary table contains a column specified as a partitioning key, work performed on the XML data in the temporary table can be distributed among the database partitions.

### Examples

The following examples assume that a table with company employees contains XML data. The employee data is like the following employee information:

```
<company name="MyFirstComany">
  <emp id="31201" salary="60000" gender="Female">
    <name>
      <first>Laura</first>
      <last>Brown</last>
    </name>
    <dept id="M25">Finance</dept>
  </emp>
</company>
```

The following CREATE statement creates an employee table and with an XML column.

```
CREATE TABLE COMPANYINFO (ID INT, DOC XML)
```

The following two statements create a global temporary table that can be used with the employee table. Both statements create a temporary table with the same column names and descriptions as the COMPANYINFO table. The first statement creates a temporary table using column definitions. The second statement creates a temporary table using the LIKE clause. The columns of the table have the same name and description as the columns of the specified table. The ON COMMIT DELETE ROWS clause specifies all rows of the table are deleted if no WITH HOLD cursor is open on the table when a COMMIT operation is performed.

```
DECLARE GLOBAL TEMPORARY TABLE INSTMPTB (ID INT, DOC XML)
    ON COMMIT DELETE ROWS in USR_TBSP

DECLARE GLOBAL TEMPORARY TABLE INSTMPTB LIKE COMPANYINFO
    ON COMMIT DELETE ROWS in USR_TBSP
```

The following DECLARE statement creates a temporary table with base table row storage of XML documents. If the XML document is smaller than the inline length specified, it is stored in the base table.

```
DECLARE GLOBAL TEMPORARY TABLE TEMPTB (ID INT, DOC XML INLINE LENGTH 3000)
    ON COMMIT PRESERVE ROWS NOT LOGGED
```

If you are inserting large amounts of data into a global temporary table and performing queries over the data, you can create indexes over the XML data to improve performance. For example, the following CREATE INDEX statements create two indexes over XML data. The first index is over the employee ID in the XML documents. The second index is over the employee's family name.

```
CREATE INDEX SESSION.TEMP_IDX ON SESSION.INSTMPTB (DOC)
    GENERATE KEY USING XMLPATTERN '/company/emp/@id'
    AS SQL INTEGER

CREATE UNIQUE INDEX SESSION.TEMP_IDX2 ON SESSION.INSTMPTB (DOC)
    GENERATE KEY USING XMLPATTERN '/company/name/last'
    AS SQL VARCHAR(100)
```

You can create a declared global temporary table in a partitioned database environment to take advantage of database partitioning. The following DECLARE statement creates a temporary table using DOCID as the distribution key. After you add XML data to the temporary table, queries and other operations on the XML data can take advantage of the partitioned database environment.

```
DECLARE GLOBAL TEMPORARY TABLE INSTMPTB (ID INT, DOC XML)
    ON COMMIT DELETE ROWS
    IN USR_TBSP
    DISTRIBUTE BY HASH (ID)
```

The following XQuery expression uses the global temporary table and the COMPANYINFO table. The temporary table contains a subset of documents from the COMPANYINFO table. The XQuery expression returns the employee information from the COMPANYINFO table of employees in the temporary table who are in the finance department.

```
XQUERY
  for $i in db2-fn:xmlcolumn("SESSION.INSTMPTB.DOC")/company/emp
  for $j in db2-fn:xmlcolumn("COMPANYINFO.DOC ")[/company/emp/@id = $i/@id ]
  where $i/dept = "Finance"
  return $j ;
```

The following INSERT statement inserts data from the temporary table into the COMPANYINFO table.

```
INSERT INTO COMPANYINFO FROM
  (SELECT ID, DOC FROM SESSION.INSTMPTB)
```



## Usage notes

The following items apply when using a declared global temporary table:

- Data row compression is enabled for a declared temporary table. When the database manager determines that there is a performance gain, table row data including XML documents stored inline in the base table object is compressed. However, data compression of the XML storage object of a declared temporary table is not supported.
- In a partitioned database environment, use the DISTRIBUTE BY clause to create a declared temporary table with partitioning key. If you create a declared temporary table using the LIKE clause and the source table has a partitioning key, the temporary table does not have a partitioning key.
- Index compression is enabled for indexes that are created on declared temporary tables including user-created indexes over XML data.
- User-created indexes over XML data have the same restrictions as indexes created for non-temporary tables. For example, in a partitioned database environment, unique XML indexes over XML data are not supported.

---

## Using optimization guidelines with XML data and XQuery expressions

DB2 optimization guidelines used in optimization profiles support XML data. You can create profiles that use guidelines to control the method of moving XML data in a partitioned database environment, the order of joins on XML data types, and the use of user-defined indexes over XML data

You can specify following types of optimizations in an optimization guideline for queries that access XML data or that use indexes over XML data:

- Control how XML data is moved between partitions in a partitioned database environment using the DPFXMLMOVEMENT general request element.
- Control the join order for joins on XML data types in plan optimization guidelines by setting the attribute FIRST to TRUE in access request elements or by using join request elements.
- Control usage of indexes over XML data with access request elements:
  - Specify using a single XML index scan to access a table with the XISCAN access request element.
  - Specify using multiple XANDORed XML index scans to access a table with the XANDOR access request element.
  - Specify using multiple relational and XML index scans using the IXAND access request element with the TYPE attribute value set to XMLINDEX.
  - Specify having the DB2 optimizer perform a cost-based analysis and choose some XML index access to access a table using the ACCESS access request element and setting the attribute TYPE to XMLINDEX. For example, the optimizer can use an XML index access such as an XML index scan, XANDOR, or index ANDing with at least one XML index.
  - Specify using all the applicable relational indexes and indexes over XML data to access the specified table, regardless of cost, using the ACCESS access request element and setting the attributes TYPE to XMLINDEX and ALLINDEXES to TRUE.
  - Specify using all applicable relational indexes and indexes over XML data in an IXAND plan to access the specified table, regardless of cost, using the IXAND access request element and setting the attributes TYPE to XMLINDEX and ALLINDEXES to TRUE.

## Examples of optimization guidelines with XML data

Example optimization profiles contain general request, access method, and join order guidelines to control how optimization is performed on queries that access XML data.

### A guideline to move XML documents as references

In the following optimization profile, the DPFXMLMOVEMENT general request element in the guideline specifies that references to XML documents are moved through the TQ operator in the access plan.

```
<?xml version="1.0" encoding="UTF-8"?>
<OPTPROFILE VERSION="9.7.0.0">
<STMTPROFILE ID="Security Tables">
  <STMTKEY SCHEMA="ST">
    SELECT *
    FROM security
    WHERE XMLEXISTS('$SDOC/Security/SecurityInfo
      /StockInfo[Industry= "OfficeSupplies"'])
  </STMTKEY>
  <OPTGUIDELINES>
    <DPFXMLMOVEMENT VALUE="REFERENCE"/>
  </OPTGUIDELINES>
</STMTPROFILE>
</OPTPROFILE>
```

### A guideline to use a specific index over XML data

In the following optimization profile, the XISCAN access element in the guideline specifies that the table SECURITY should be accessed using the index SEC\_INDUSTRY. If the XISCAN element did not specify an index name with the INDEX attribute, the optimizer accesses the table SECURITY using the index over XML data with the least cost.

```
<?xml version="1.0" encoding="UTF-8"?>
<OPTPROFILE VERSION="9.7.0.0">
<STMTPROFILE ID="Security Tables">
  <STMTKEY SCHEMA="ST">
    SELECT *
    FROM security
    WHERE XMLEXISTS('$SDOC/Security/SecurityInfo
      /StockInfo[Industry= "OfficeSupplies"'])
  </STMTKEY>
  <OPTGUIDELINES>
    <XISCAN TABLE='SECURITY' INDEX='SEC_INDUSTRY'/>
  </OPTGUIDELINES>
</STMTPROFILE>
</OPTPROFILE>
```

### A guideline to use indexes over XML data with XANDOR access

In the guideline in the following optimization profile, the XANDOR element specifies that the table SECURITY should be accessed using an XANDOR plan of all applicable indexes over XML data. Relational indexes are not used because a relational index cannot be used by an XANDOR plan.

```
<?xml version="1.0" encoding="UTF-8"?>
<OPTPROFILE VERSION="9.7.0.0">
<STMTPROFILE ID="Security Tables by Date">
  <STMTKEY SCHEMA="STBD">
    SELECT *
    FROM security
    WHERE trans_date = CURRENT DATE
```

```

        AND XMLEXISTS('$SDOC/Security/SecurityInfo
          /StockInfo[Industry= "Software"'])
        AND XMLEXISTS('$SDOC/Security/Symbol[.="IBM"'])
</STMTKEY>
<OPTGUIDELINES>
  <XANDOR TABLE='SECURITY' />
</OPTGUIDELINES>
</STMTPROFILE>
</OPTPROFILE>

```

## A guideline to use specified multiple indexes over XML data with IXAND

In the following optimization profile, the IXAND element in the optimization guideline specifies that the table SECURITY should be accessed using two indexes over XML data, SEC\_INDUSTRY and SEC\_SYMBOL. The optimizer generates an IXAND plan with the two indexes as legs of the IXAND plan in the listed order.

```

<?xml version="1.0" encoding="UTF-8"?>
<OPTPROFILE VERSION="9.7.0.0">
<STMTPROFILE ID="Security Tables by Date">
  <STMTKEY SCHEMA="STBD">
    SELECT *
    FROM security
    WHERE trans_date = CURRENT DATE
      AND XMLEXISTS('$SDOC/Security/SecurityInfo
        /StockInfo[Industry= "Software"'])
      AND XMLEXISTS('$SDOC/Security/Symbol[.="IBM"'])
  </STMTKEY>
  <OPTGUIDELINES>
    <IXAND TABLE='SECURITY' TYPE='XMLINDEX'>
      <INDEX IXNAME='SEC_INDUSTRY' />
      <INDEX IXNAME='SEC_SYMBOL' />
    </IXAND>
  </OPTGUIDELINES>
</STMTPROFILE>
</OPTPROFILE>

```

## A guideline to use all indexes over XML data with IXAND

In the following optimization profile, the IXAND element in the optimization guideline specifies that the table SECURITY should be accessed using all applicable relational indexes and indexes over XML data. Assuming there is a relational index on TRANS\_DATE and indexes over XML data on SEC\_INDUSTRY and SEC\_SYMBOL, all three indexes are ANDed together in an order chosen by the optimizer.

```

<?xml version="1.0" encoding="UTF-8"?>
<OPTPROFILE VERSION="9.7.0.0">
<STMTPROFILE ID="Security Tables by Date">
  <STMTKEY SCHEMA="STBD">
    SELECT *
    FROM security
    WHERE trans_date = CURRENT DATE
      AND XMLEXISTS('$SDOC/Security/SecurityInfo
        /StockInfo[Industry= "Software"'])
      AND XMLEXISTS('$SDOC/Security/Symbol[.="IBM"'])
  </STMTKEY>
  <OPTGUIDELINES>
    <IXAND TABLE='SECURITY' TYPE='XMLINDEX' ALLINDEXES='TRUE' />
  </OPTGUIDELINES>
</STMTPROFILE>
</OPTPROFILE>

```

## A guideline to use a specific leading index over XML data with IXAND

In the following optimization profile, the IXAND element in the optimization guideline specifies that the table SECURITY should be accessed using an IXAND plan and the index over XML data SEC\_INDUSTRY must be the first index in the IXAND. The optimizer picks additional indexes for the IXAND plan in a cost-based fashion. If a relational index is available on the column TRANS\_DATE and an index over XML data is available on the path SYMBOL, one or both of these indexes appear as additional legs of the IXAND plan if deemed beneficial by the optimizer.

```
<?xml version="1.0" encoding="UTF-8"?>
<OPTPROFILE VERSION="9.7.0.0">
<STMTPROFILE ID="Security Tables by Date">
  <STMTKEY SCHEMA="STBD">
    SELECT *
    FROM security
    WHERE trans_date = CURRENT DATE
      AND XMLEXISTS('$SDOC/Security/SecurityInfo
        /StockInfo[Industry= "Software" ]')
      AND XMLEXISTS('$SDOC/Security/Symbol[.="IBM" ]')
  </STMTKEY>
<OPTGUIDELINES>
  <IXAND TABLE='SECURITY' TYPE='XMLINDEX' INDEX='SEC_INDUSTRY' />
</OPTGUIDELINES>
</STMTPROFILE>
</OPTPROFILE>
```

## A guideline to use some XML index access

In the following optimization profile, the guideline specifies only that some index over XML data be used to access the table SECURITY. The optimizer uses a XISCAN, IXAND, XANDOR, or IXOR plan using a cost-based analysis.

```
<?xml version="1.0" encoding="UTF-8"?>
<OPTPROFILE VERSION="9.7.0.0">
<STMTPROFILE ID="Security Tables">
  <STMTKEY SCHEMA="ST">
    SELECT *
    FROM security
    WHERE XMLEXISTS('$SDOC/Security/SecurityInfo
      /StockInfo[Industry= "OfficeSupplies" ]')
  </STMTKEY>
<OPTGUIDELINES>
  <ACCESS TABLE='SECURITY' TYPE='XMLINDEX' />
</OPTGUIDELINES>
</STMTPROFILE>
</OPTPROFILE>
```

## A guideline to use all applicable indexes over XML data access

In the following optimization profile, the guideline specifies that all applicable indexes on the SECURITY table are used. The choice of the method is left to the optimizer. Assuming two indexes over XML data, SEC\_INDUSTRY and SEC\_SYMBOL have been created that match the two predicates in XMLEXISTS. The optimizer has the choice to either use an XANDOR or IXAND plan. The optimizer chooses between the two access plans using a cost-based analysis.

```
<?xml version="1.0" encoding="UTF-8"?>
<OPTPROFILE VERSION="9.7.0.0">
<STMTPROFILE ID="Security Tables 2">
  <STMTKEY SCHEMA="ST2">
    SELECT *
```

```

FROM security
WHERE XMLEXISTS('$SDOC/Security/SecurityInfo
                /StockInfo[Industry= "Software"]')
AND XMLEXISTS('$SDOC/Security/Symbol[.="IBM"']')
</STMTKEY>
<OPTGUIDELINES>
  <ACCESS TABLE='SECURITY' TYPE='XMLINDEX' ALLINDEXES='TRUE' />
</OPTGUIDELINES>
</STMTPROFILE>
</OPTPROFILE>

```

## A guideline specifying index over XML data access using a specific index

In the following optimization profile, the guideline specifies that the table SECURITY is accessed using at least the SEC\_INDUSTRY index. The optimizer picks one of the following access plans using a cost-based analysis:

1. An XISCAN plan using SEC\_INDUSTRY index.
2. An IXAND plan with the given index as the first leg of the IXAND plan. The optimizer might use more indexes in the IXAND plan based on a cost-based analysis. In the example, if a relational index is available on the column TRANS\_DATE, that index appears as an additional leg of the IXAND plan if it was deemed beneficial by the optimizer.
3. A XANDOR plan with the given index and other applicable indexes over XML data.

```

<?xml version="1.0" encoding="UTF-8"?>
<OPTPROFILE VERSION="9.7.0.0">
<STMTPROFILE ID="Security Tables by Date">
  <STMTKEY SCHEMA="STBD">
    SELECT *
    FROM security
    WHERE trans_date = CURRENT DATE
    AND XMLEXISTS('$SDOC/Security/SecurityInfo
                  /StockInfo[Industry= "Software"]')
    AND XMLEXISTS('$SDOC/Security/Symbol[.="IBM"']')
  </STMTKEY>
  <OPTGUIDELINES>
    <ACCESS TABLE='SECURITY' TYPE='XMLINDEX' INDEX='SEC_INDUSTRY' />
  </OPTGUIDELINES>
</STMTPROFILE>
</OPTPROFILE>

```

The following optimization guideline specifies using one of the following access plans using a cost-based analysis:

- Use an IXAND plan with the SEC\_INDUSTRY and SEC\_SYMBOL indexes in the specified order.
- Use XANDOR plan with all applicable XML indexes.

```

<OPTGUIDELINES>
  <ACCESS TABLE='SECURITY' TYPE='XMLINDEX'>
    <INDEX IXNAME='SEC_INDUSTRY' />
    <INDEX IXNAME='SEC_SYMBOL' />
  </ACCESS>
</OPTGUIDELINES>

```

## A guideline controlling join order and specifying index over XML data access

In the following optimization profile, the optimization guidelines contain two elements. The first guideline element specifies that the table CUSTACC must

appear as the outermost table when the tables in the FROM clause are joined and some index over XML data access must be used to access the table CUSTACC. The second guideline element specifies that the table ORDER should be accessed using a XANDOR plan. The optimizer uses all applicable indexes over XML data in the XANDOR plan. The order of indexes is chosen by the optimizer.

```
<?xml version="1.0" encoding="UTF-8"?>
<OPTPROFILE VERSION="9.7.0.0">
<STMTPROFILE ID="Order and Security Tables">
  <STMTKEY SCHEMA="OST">
    SELECT ordqty, orddate, ordid, security, lasttrade
    FROM order, security, custacc,
    XMLTABLE('$ODOC/FIXML/Order'
      COLUMNS ordid VARCHAR(10) PATH '@ID',
      orddate date PATH '@TrdDt',
      ordqty float PATH 'OrdQty/@Qty') AS T1,
    XMLTABLE('$SDOC/Security'
      COLUMNS security varchar(50) PATH 'Name',
      lasttrade float PATH 'Price/LastTrade') AS T2
    WHERE XMLEXISTS('
      $SDOC/Security[Symbol/fn:string(.)
      = $ODOC/FIXML/Order/Instrmt/@Sym/fn:string(.)'])
    and XMLEXISTS(
      '$ODOC/FIXML/Order[@Acct/fn:string(.)
      = $CADOC/Customer/Accounts/Account/@id/fn:string(.)'])
    and XMLEXISTS('$CADOC/Customer[@id = 1011]')
    ORDER BY ordqty desc
  </STMTKEY>
  <OPTGUIDELINES>
    <ACCESS TABLE='CUSTACC' TYPE='XMLINDEX' FIRST='TRUE' />
    <XANDOR TABLE='ORDER' />
  </OPTGUIDELINES>
</STMTPROFILE>
</OPTPROFILE>
```

## Guidelines for an XQuery expression

The following optimization profile contains an XQuery expression that returns stock information of companies that deal in Software from the table SECURITY1. The guideline specifies that the table should be accessed using the single XML index XI1.

```
<?xml version="1.0" encoding="UTF-8"?>
<OPTPROFILE VERSION="9.7.0.0">
<STMTPROFILE ID="Security Tables by Industry">
  <STMTKEY SCHEMA="STBD">
    xquery
    for $sinfo1 in db2-fn:xmlcolumn("SECURITY1.SDOC")/Security/SecurityInfo
      /StockInfo[Industry="Software"]
    return $sinfo1
  </STMTKEY>
  <OPTGUIDELINES>
    <XISCAN TABLE='SECURITY1' INDEX='XI1' />
  </OPTGUIDELINES>
</STMTPROFILE>
</OPTPROFILE>
```

The following optimization profile contains an XQuery expression that returns stock information of a company that deals in Software as well as Electronics.

The guideline specifies that table SECURITY2 should be the outer table in the join and the index over XML data XI2 should be used to access the SECURITY2 table.

The guideline also specifies that the table SECURITY1 should be the inner table of the join and the index over XML data XI1 should be used to access the SECURITY1 table.

```
<?xml version="1.0" encoding="UTF-8"?>
<OPTPROFILE VERSION="9.7.0.0">
<STMTPROFILE ID="Security Tables by Industry">
  <STMTKEY SCHEMA="STBD">
    <![CDATA[ xquery
      for $sinfo1 in db2-fn:xmlcolumn("SECURITY1.SDOC")/Security
        /SecurityInfo/StockInfo[Industry="Software"]
      for $sinfo2 in db2-fn:xmlcolumn("SECURITY2.SDOC")/Security
        /SecurityInfo/StockInfo[Industry="Electronics"]
      where $sinfo1 = $sinfo2
      return <stock> {$sinfo1} </stock> ]]>
  </STMTKEY>
<OPTGUIDELINES>
  <JOIN>
    <ACCESS TABLE='SECURITY2' TYPE='XMLINDEX' INDEX='XI2' />
    <ACCESS TABLE='SECURITY1' TYPE='XMLINDEX' INDEX='XI1' />
  </JOIN>
</OPTGUIDELINES>
</STMTPROFILE>
</OPTPROFILE>
```

A CDATA section starting, with <![CDATA[ and ending with ]>, encloses the statement key in the STMTKEY element because the statement key contains the special XML characters < and >. The profile parser ignores the XML tags in the CDATA section, but the optimizer still uses the entire statement key to match a statement profile to a corresponding statement in an application.

---

## Preference of DMS table spaces for pureXML data store performance

For performance-sensitive applications, particularly those involving extensive INSERT activity, it is strongly recommended that you use database managed space (DMS) table spaces.

If you encounter query performance degradation with pureXML data store and are using system managed space (SMS), you should consider switching to DMS.

The use of DMS functionality also allows you to take advantage of autonomic capabilities in DB2.





---

## Chapter 12. XML data encoding

The encoding of XML data can be derived from the data itself, which is known as *internally encoded* data, or from external sources, which is known as *externally encoded* data.

The application data type that you use to exchange the XML data between the application and the XML column determines how the encoding is derived.

- XML data that is in character or graphic application data types is considered to be externally encoded. Like character and graphic data, XML data that is in these data types is considered to be encoded in the application code page.
- XML data that is in a binary application data type or binary data that is in a character data type is considered to be internally encoded.

Externally coded XML data might contain internal encoding, such as when an XML document in a character data type contains an encoding declaration. When you send externally encoded data to a DB2 database, the database manager checks for internal encoding.

If the external encoding and the internal encoding are not Unicode encoding, the effective CCSID that is associated with the internal encoding must match the external encoding. Otherwise, an error occurs. If the external encoding and the internal encoding are Unicode encoding, and the encoding schemes do not match, the DB2 database server ignores the internal encoding.

---

### Internally encoded XML data

XML data in a binary application data type has internal encoding. With internal encoding, the content of the data determines the encoding. The DB2 database system derives the internal encoding from the document content according to the XML standard.

Internal encoding is derived from three components:

#### Unicode Byte Order Mark (BOM)

A byte sequence that consists of a Unicode character code at the beginning of XML data. The BOM indicates the byte order of the following text. The DB2 database manager recognizes a BOM only for XML data. For XML data that is stored in a non-XML column, the database manager treats a BOM value like any other character or binary value.

#### XML declaration

A processing instruction at the beginning of an XML document. The declaration provides specific details about the remainder of the XML.

#### Encoding declaration

An optional part of the XML declaration that specifies the encoding for the characters in the document.

The DB2 database manager uses the following procedure to determine the encoding:

1. If the data contains a Unicode BOM, the BOM determines the encoding. The following table lists the BOM types and the resultant data encoding:

Table 38. Byte order marks and resultant document encoding

BOM type	BOM value	Encoding
UTF-8	X'EFBBBF'	UTF-8
UTF-16 Big Endian	X'FEFF'	UTF-16
UTF-16 Little Endian	X'FFFE'	UTF-16
UTF-32 Big Endian	X'000FEFF'	UTF-32
UTF-32 Little Endian	X'FFFE0000'	UTF-32

2. If the data contains an XML declaration, the encoding depends on whether there is an encoding declaration:
  - If there is an encoding declaration, the encoding is the value of the encoding attribute. For example, the encoding is EUC-JP for XML data with the following XML declaration:
 

```
<?xml version="1.0" encoding="EUC-JP"?>
```
  - If there is an encoding declaration and a BOM, the encoding declaration must match the encoding from the BOM. Otherwise, an error occurs.
  - If there is no encoding declaration and no BOM, the database manager determines the encoding from the encoding of the XML declaration:
    - If the XML declaration is in single-byte ASCII characters, the encoding of the document is UTF-8.
    - If the XML declaration is in double-byte ASCII characters, the encoding of the document is UTF-16.
3. If there is no XML declaration and no BOM, the encoding of the document is UTF-8.

---

## Encoding considerations when storing or passing XML data

XML data must be encoded properly to be stored in a DB2 table. Encoding must be considered when the data is retrieved from the table and used with DB2 stored procedures or user-defined functions, or when used with external Java applications.

### Encoding considerations for input of XML data to a database

The internal and external encoding must be considered when storing XML data in a DB2 table.

The following rules need to be observed:

- If the internal and external encoding are not Unicode encoding, for externally encoded XML data (data that is sent to the database server using character data types), any internally encoded declaration *must* match the external encoding. Otherwise, an error occurs, and the database manager rejects the document.  
If the external encoding and the internal encoding are Unicode encoding, and the encoding schemes do not match, the DB2 database server ignores the internal encoding.
- For internally encoded XML data (data that is sent to the database server using binary data types), the application *must* ensure that the data contains accurate encoding information.

## Encoding considerations for retrieval of XML data from a database

When you retrieve XML data from a DB2 table, you need to avoid data loss and truncation. Data loss can occur when characters in the source data cannot be represented in the encoding of the target data. Truncation can occur when conversion to the target data type results in expansion of the data.

Data loss is less of a problem for Java and .NET applications than for other types of applications because Java and .NET string data types use Unicode UTF-16 or UCS-2 encoding. Truncation is possible because expansion can occur when UTF-8 characters are converted to UTF-16 or UCS-2 encoding.

## Encoding considerations for passing XML data in routine parameters

In a DB2 database system, several XML data types are available for parameters in a stored procedure or user-defined function definition.

The following XML data types are available:

**XML** For SQL procedures.

### **XML AS CLOB**

For external SQL procedures and external user-defined functions.

Data in XML AS CLOB parameters is subject to character conversion, if the application encoding is not UTF-8. You should avoid the overhead of character conversion in an external user-defined function or stored procedure. Any application character or graphic data type can be used for the parameters in the calling application, but the source data should not contain an encoding declaration. Additional code page conversion might occur, which can make the encoding information inaccurate. If the data is further parsed in the application, data corruption can result.

## Encoding considerations for XML data in JDBC, SQLJ, and .NET applications

Typically, there are fewer XML encoding considerations for Java applications than for CLI or embedded SQL applications. Although the encoding considerations for internally encoded XML data are the same for all applications, the situation is simplified for externally encoded data in Java applications because the application code page is always Unicode.

### **General recommendations for input of XML data in Java applications**

- If the input data is in a file, read the data in as a binary stream (`setBinaryStream`) so that the database manager processes it as internally encoded data.
- If the input data is in a Java application variable, your choice of application variable type determines whether the DB2 database manager uses any internal encoding. If you input the data as a character type (for example, `setString`), the database manager converts the data from UTF-16 (the application code page) to UTF-8 before storing it.

## General recommendations for output of XML data in Java applications

- If you output XML data to a file as non-binary data, you should add XML internal encoding to the output data.

The encoding for the file system might not be Unicode, so string data can undergo conversion when it is stored in the file. If you write data to a file as binary data, conversion does not occur.

For Java applications, the database server does not add an explicit declaration for an implicit XML serialize operation. If you cast the output data as the `com.ibm.db2.jcc.DB2Xml` type, and invoke one of the `getDB2Xmlxxx` methods, the JDBC driver adds an encoding declaration, as shown in the following table.

<code>getDB2Xmlxxx</code>	Encoding in declaration
<code>getDB2XmlString</code>	ISO-10646-UCS-2
<code>getDB2XmlBytes(String targetEncoding)</code>	Encoding specified by <i>targetEncoding</i>
<code>getDB2XmlAsciiStream</code>	US-ASCII
<code>getDB2XmlCharacterStream</code>	ISO-10646-UCS-2
<code>getDB2XmlBinaryStream(String targetEncoding)</code>	Encoding specified by <i>targetEncoding</i>

For an explicit XMLSERIALIZE function with INCLUDING XMLDECLARATION, the database server adds encoding, and the JDBC driver does not modify it. The explicit encoding that the database server adds is UTF-8 encoding. Depending on how the value is retrieved by the application, the actual encoding of the data might not match the explicit internal encoding.

- If the application sends the output data to an XML parser, you should retrieve the data in a binary application variable, with UTF-8, UCS-2, or UTF-16 encoding.

---

## Effects of XML encoding and serialization on data conversion

The method of specifying the encoding of XML data, either internally or externally, and the method of XML serialization affects the conversion of XML data when passing the data between a database and an application.

### Encoding scenarios for input of internally encoded XML data to a database

Examples demonstrate how internal encoding affects data conversion and truncation during input of XML data to an XML column.

In general, use of a binary application data type minimizes code page conversion problems during input to a database.

#### Scenario 1

Encoding source	Value
Data encoding	UTF-8 Unicode input data, with or without a UTF-8 BOM or XML encoding declaration
Application data type	Binary
Application code page	Not applicable

*Example input statements:*

```
INSERT INTO T1 (XMLCOL) VALUES (?)
INSERT INTO T1 (XMLCOL) VALUES
  (XMLPARSE(DOCUMENT CAST(? AS BLOB) PRESERVE WHITESPACE))
```

*Character conversion:* None.

*Data loss:* None.

*Truncation:* None.

## Scenario 2

Encoding source	Value
Data encoding	UTF-16 Unicode input data containing a UTF-16 BOM or XML encoding declaration
Application data type	Binary
Application code page	Not applicable

*Example input statements:*

```
INSERT INTO T1 (XMLCOL) VALUES (?)
INSERT INTO T1 (XMLCOL) VALUES
  (XMLPARSE(DOCUMENT CAST(? AS BLOB) PRESERVE WHITESPACE))
```

*Character conversion:* the DB2 database server converts the data from UTF-16 to UTF-8 when it performs the XML parse for storage in the XML column.

*Data loss:* None.

*Truncation:* None.

## Scenario 3

Encoding source	Value
Data encoding	ISO-8859-1 input data containing an XML encoding declaration
Application data type	Binary
Application code page	Not applicable

*Example input statements:*

```
INSERT INTO T1 (XMLCOL) VALUES (?)
INSERT INTO T1 (XMLCOL) VALUES
  (XMLPARSE(DOCUMENT CAST(? AS BLOB) PRESERVE WHITESPACE))
```

*Character conversion:* The DB2 database system converts the data from CCSID 819 to UTF-8 when it performs the XML parse for storage in the XML column.

*Data loss:* None.

*Truncation:* None.

## Scenario 4

Encoding source	Value
Data encoding	Shift_JIS input data containing an XML encoding declaration
Application data type	Binary
Application code page	Not applicable

*Example input statements:*

```
INSERT INTO T1 (XMLCOL) VALUES (?)
INSERT INTO T1 (XMLCOL) VALUES
  (XMLPARSE(DOCUMENT CAST(? AS BLOB) PRESERVE WHITESPACE))
```

*Character conversion:* The DB2 database system converts the data from CCSID 943 to UTF-8 when it performs the XML parse for storage in the XML column.

*Data loss:* None.

*Truncation:* None.

## Encoding scenarios for input of externally encoded XML data to a database

Examples demonstrate how external encoding affects data conversion and truncation during input of XML data to an XML column.

In general, when you use a character application data type, there is not a problem with code page conversion during input to a database.

Only scenario 1 and scenario 2 apply to Java and .NET applications, because the application code page for Java and .NET applications is always Unicode.

### Scenario 1

Encoding source	Value
Data encoding	UTF-8 Unicode input data, with or without an appropriate encoding declaration or BOM
Application data type	Character
Application code page	1208 (UTF-8)

*Example input statements:*

```
INSERT INTO T1 (XMLCOL) VALUES (?)
INSERT INTO T1 (XMLCOL) VALUES
  (XMLPARSE(DOCUMENT CAST(? AS CLOB) PRESERVE WHITESPACE))
```

*Character conversion:* None.

*Data loss:* None.

*Truncation:* None.

## Scenario 2

Encoding source	Value
Data encoding	UTF-16 Unicode input data, with or without an appropriate encoding declaration or BOM
Application data type	Graphic
Application code page	Any SBCS code page or CCSID 1208

*Example input statements:*

```
INSERT INTO T1 (XMLCOL) VALUES (?)
INSERT INTO T1 (XMLCOL) VALUES
  (XMLPARSE(DOCUMENT CAST(? AS DBCLOB) PRESERVE WHITESPACE))
```

*Character conversion:* The DB2 database system converts the data from UTF-16 to UTF-8 when it performs the XML parse for storage in the XML column.

*Data loss:* None.

*Truncation:* Truncation can occur during conversion from UTF-16 to UTF-8, due to expansion.

## Scenario 3

Encoding source	Value
Data encoding	ISO-8859-1 input data, with or without an appropriate encoding declaration
Application data type	Character
Application code page	819

*Example input statements:*

```
INSERT INTO T1 (XMLCOL) VALUES (?)
INSERT INTO T1 (XMLCOL) VALUES
  (XMLPARSE(DOCUMENT CAST(? AS CLOB) PRESERVE WHITESPACE))
```

*Character conversion:* The DB2 database system converts the data from CCSID 819 to UTF-8 when it performs the XML parse for storage in the XML column.

*Data loss:* None.

*Truncation:* None.

## Scenario 4

Encoding source	Value
Data encoding	Shift_JIS input data, with or without an appropriate encoding declaration
Application data type	Graphic

Encoding source	Value
Application code page	943

*Example input statements:*

```
INSERT INTO T1 VALUES (?)
INSERT INTO T1 VALUES
  (XMLPARSE(DOCUMENT CAST(? AS DBCLOB)))
```

*Character conversion:* The DB2 database system converts the data from CCSID 943 to UTF-8 when it performs the XML parse for storage in the XML column.

*Data loss:* None.

*Truncation:* None.

## Encoding scenarios for retrieval of XML data with implicit serialization

Examples demonstrate how the target encoding and application code page affect data conversion, truncation, and internal encoding during XML data retrieval with implicit serialization.

Only scenario 1 and scenario 2 apply to Java and .NET applications, because the application code page for Java applications is always Unicode. In general, code page conversion is not a problem for Java and .NET applications.

### Scenario 1

Encoding source	Value
Target data encoding	UTF-8 Unicode
Target application data type	Binary
Application code page	Not applicable

*Example output statements:*

```
SELECT XMLCOL FROM T1
```

*Character conversion:* None.

*Data loss:* None.

*Truncation:* None.

*Internal encoding in the serialized data:* For applications other than Java or .NET applications, the data is prefixed by the following XML declaration:

```
<?xml version="1.0" encoding="UTF-8" ?>
```



For Java applications, no encoding declaration is added, unless you cast the data as the `com.ibm.db2.jcc.DB2Xml` type, and use a `getDB2Xmlxxx` method to retrieve the data. The declaration that is added depends on the `getDB2Xmlxxx` that you use.

For .NET applications, no encoding declaration is added or removed.

## Scenario 2

Encoding source	Value
Target data encoding	UTF-16 Unicode
Target application data type	Graphic
Application code page	Any SBCS code page or CCSID 1208

*Example output statements:*

```
SELECT XMLCOL FROM T1
```

*Character conversion:* Data is converted from UTF-8 to UTF-16.

*Data loss:* None.

*Truncation:* Truncation can occur during conversion from UTF-8 to UTF-16, due to expansion.

*Internal encoding in the serialized data:* For applications other than Java or .NET applications, the data is prefixed by a UTF-16 Byte Order Mark (BOM) and the following XML declaration:

```
<?xml version="1.0" encoding="UTF-16" ?>
```

For Java applications, no encoding declaration is added, unless you cast the data as the `com.ibm.db2.jcc.DB2Xml` type, and use a `getDB2Xmlxxx` method to retrieve the data. The declaration that is added depends on the `getDB2Xmlxxx` that you use.

For .NET applications, no encoding declaration is added or removed.

## Scenario 3

Encoding source	Value
Target data encoding	ISO-8859-1 data
Target application data type	Character
Application code page	819

*Example output statements:*

```
SELECT XMLCOL FROM T1
```

*Character conversion:* Data is converted from UTF-8 to CCSID 819.

*Data loss:* Possible data loss. Some UTF-8 characters cannot be represented in CCSID 819. The DB2 database system generates an error.

*Truncation:* None.

*Internal encoding in the serialized data:* The data is prefixed by the following XML declaration:

```
<?xml version="1.0" encoding="ISO-8859-1" ?>
```

## Scenario 4

Encoding source	Value
Target data encoding	Windows-31J data (superset of Shift_JIS)
Target application data type	Graphic
Application code page	943

*Example output statements:*

```
SELECT XMLCOL FROM T1
```

*Character conversion:* Data is converted from UTF-8 to CCSID 943.

*Data loss:* Possible data loss. Some UTF-8 characters cannot be represented in CCSID 943. The DB2 database system generates an error.

*Truncation:* Truncation can occur during conversion from UTF-8 to CCSID 943 due to expansion.

*Internal encoding in the serialized data:* The data is prefixed by the following XML declaration:

```
<?xml version="1.0" encoding="Windows-31J" ?>
```

## Encoding scenarios for retrieval of XML data with explicit XMLSERIALIZE

Examples demonstrate how the target encoding and application code page affect data conversion, truncation, and internal encoding during XML data retrieval with an explicit XMLSERIALIZE invocation.

Only scenario 1 and scenario 2 apply to Java and .NET applications, because the application code page for Java applications is always Unicode.

### Scenario 1

Encoding source	Value
Target data encoding	UTF-8 Unicode
Target application data type	Binary

Encoding source	Value
Application code page	Not applicable

*Example output statements:*

```
SELECT XMLSERIALIZE(XMLCOL AS BLOB(1M) INCLUDING XMLDECLARATION) FROM T1
```

*Character conversion:* None.

*Data loss:* None.

*Truncation:* None.

*Internal encoding in the serialized data:* The data is prefixed by the following XML declaration:

```
<?xml version="1.0" encoding="UTF-8" ?>
```

## Scenario 2

Encoding source	Value
Target data encoding	UTF-16 Unicode
Target application data type	Graphic
Application code page	Any SBCS code page or CCSID 1208

*Example output statements:*

```
SELECT XMLSERIALIZE(XMLCOL AS CLOB(1M) EXCLUDING XMLDECLARATION) FROM T1
```

*Character conversion:* Data is converted from UTF-8 to UTF-16.

*Data loss:* None.

*Truncation:* Truncation can occur during conversion from UTF-8 to UTF-16, due to expansion.

*Internal encoding in the serialized data:* None, because EXCLUDING XMLDECLARATION is specified. If INCLUDING XMLDECLARATION is specified, the internal encoding indicates UTF-8 instead of UTF-16. This can result in XML data that cannot be parsed by application processes that rely on the encoding name.

## Scenario 3

Encoding source	Value
Target data encoding	ISO-8859-1 data
Target application data type	Character

Encoding source	Value
Application code	819
page	

*Example output statements:*

```
SELECT XMLSERIALIZE(XMLCOL AS CLOB(1M) EXCLUDING XMLDECLARATION) FROM T1
```

*Character conversion:* Data is converted from UTF-8 to CCSID 819.

*Data loss:* Possible data loss. Some UTF-8 characters cannot be represented in CCSID 819. If a character cannot be represented in CCSID 819, the DB2 database manager inserts a substitution character in the output and issues a warning.

*Truncation:* None.

*Internal encoding in the serialized data:* None, because EXCLUDING XMLDECLARATION is specified. If INCLUDING XMLDECLARATION is specified, the database manager adds internal encoding for UTF-8 instead of ISO-8859-1. This can result in XML data that cannot be parsed by application processes that rely on the encoding name.

## Scenario 4

Encoding source	Value
Target data encoding	Windows-31J data (superset of Shift_JIS)
Target application data type	Graphic
Application code	943
page	

*Example output statements:*

```
SELECT XMLSERIALIZE(XMLCOL AS CLOB(1M) EXCLUDING XMLDECLARATION) FROM T1
```

*Character conversion:* Data is converted from UTF-8 to CCSID 943.

*Data loss:* Possible data loss. Some UTF-8 characters cannot be represented in CCSID 943. If a character cannot be represented in CCSID 943, the database manager inserts a substitution character in the output and issues a warning.

*Truncation:* Truncation can occur during conversion from UTF-8 to CCSID 943 due to expansion.

*Internal encoding in the serialized data:* None, because EXCLUDING XMLDECLARATION is specified. If INCLUDING XMLDECLARATION is specified, the internal encoding indicates UTF-8 instead of Windows-31J. This can result in XML data that cannot be parsed by application processes that rely on the encoding name.

---

## Mapping internally encoded XML data and CCSIDs

The DB2 database manager determines the CCSID based on the XML internal encoding when converting data from XML data to another data type, and determines the XML internal encoding name based on the CCSID when converting data to the XML data type.

### Mappings of encoding names to effective CCSIDs for stored XML data

If data that you store in an XML column is in a binary application variable, or is an internally encoded XML type, the DB2 database manager examines the data to determine the encoding. If the data has an encoding declaration, the database manager maps the encoding name to a CCSID.

Table 39 lists these mappings. If an encoding name is not in Table 39, the database manager returns an error.

The normalized encoding name in the first column of Table 39 is the result of converting the encoding name to uppercase, and stripping out all hyphens, plus signs, underscores, colons, periods, and spaces. For example, ISO88591 is the normalized encoding name for ISO 8859-1, ISO-8859-1, and iso-8859-1.

*Table 39. Encoding names and effective CCSIDs*

Normalized encoding name	CCSID
437	437
646	367
813	813
819	819
850	850
852	852
855	855
857	857
862	862
863	863
866	866
869	869
885913	901
885915	923
88591	819
88592	912
88595	915
88597	813
88598	62210
88599	920
904	904
912	912
915	915

Table 39. Encoding names and effective CCSIDs (continued)

Normalized encoding name	CCSID
916	916
920	920
923	923
ANSI1251	1251
ANSIX341968	367
ANSIX341986	367
ARABIC	1089
ASCII7	367
ASCII	367
ASMO708	1089
BIG5	950
CCSID00858	858
CCSID00924	924
CCSID01140	1140
CCSID01141	1141
CCSID01142	1142
CCSID01143	1143
CCSID01144	1144
CCSID01145	1145
CCSID01146	1146
CCSID01147	1147
CCSID01148	1148
CCSID01149	1149
CP00858	858
CP00924	924
CP01140	1140
CP01141	1141
CP01142	1142
CP01143	1143
CP01144	1144
CP01145	1145
CP01146	1146
CP01147	1147
CP01148	1148
CP01149	1149
CP037	37
CP1026	1026
CP1140	1140
CP1141	1141
CP1142	1142

Table 39. Encoding names and effective CCSIDs (continued)

Normalized encoding name	CCSID
CP1143	1143
CP1144	1144
CP1145	1145
CP1146	1146
CP1147	1147
CP1148	1148
CP1149	1149
CP1250	1250
CP1251	1251
CP1252	1252
CP1253	1253
CP1254	1254
CP1255	1255
CP1256	1256
CP1257	1257
CP1258	1258
CP1363	1363
CP1383	1383
CP1386	1386
CP273	273
CP277	277
CP278	278
CP280	280
CP284	284
CP285	285
CP297	297
CP33722	954
CP33722C	954
CP367	367
CP420	420
CP423	423
CP424	424
CP437	437
CP500	500
CP5346	5346
CP5347	5347
CP5348	5348
CP5349	5349
CP5350	5350
CP5353	5353

Table 39. Encoding names and effective CCSIDs (continued)

Normalized encoding name	CCSID
CP813	813
CP819	819
CP838	838
CP850	850
CP852	852
CP855	855
CP857	857
CP858	858
CP862	862
CP863	863
CP864	864
CP866	866
CP869	869
CP870	870
CP871	871
CP874	874
CP904	904
CP912	912
CP915	915
CP916	916
CP920	920
CP921	921
CP922	922
CP923	923
CP936	1386
CP943	943
CP943C	943
CP949	970
CP950	950
CP964	964
CP970	970
CPGR	869
CSASCII	367
CSBIG5	950
CSEBCDICAFR	500
CSEBCDICDKNO	277
CSEBCDICES	284
CSEBCICFISE	278
CSEBCICFR	297
CSEBCICIT	280



Table 39. Encoding names and effective CCSIDs (continued)

Normalized encoding name	CCSID
CSEBCDICPT	37
CSEBCDICUK	285
CSEBCDICUS	37
CSEUCKR	970
CSEUCPKDFMTJAPANESE	954
CSGB2312	1383
CSHPROMAN8	1051
CSIBM037	37
CSIBM1026	1026
CSIBM273	273
CSIBM277	277
CSIBM278	278
CSIBM280	280
CSIBM284	284
CSIBM285	285
CSIBM297	297
CSIBM420	420
CSIBM423	423
CSIBM424	424
CSIBM500	500
CSIBM855	855
CSIBM857	857
CSIBM863	863
CSIBM864	864
CSIBM866	866
CSIBM869	869
CSIBM870	870
CSIBM871	871
CSIBM904	904
CSIBMEBCDICATDE	273
CSIBMTHAI	838
CSISO128T101G2	920
CSISO146SERBIAN	915
CSISO147MACEDONIAN	915
CSISO2INTLREFVERSION	367
CSISO646BASIC1983	367
CSISO88596I	1089
CSISO88598I	916
CSISOLATIN0	923
CSISOLATIN1	819

Table 39. Encoding names and effective CCSIDs (continued)

Normalized encoding name	CCSID
CSISOLATIN2	912
CSISOLATIN5	920
CSISOLATIN9	923
CSISOLATINARABIC	1089
CSISOLATINCYRILLIC	915
CSISOLATINGREEK	813
CSISOLATINHEBREW	62210
CSKOI8R	878
CSKSC56011987	970
CSMACINTOSH	1275
CSMICROSOFTPUBLISHING	1004
CSPC850MULTILINGUAL	850
CSPC862LATINHEBREW	862
CSPC8CODEPAGE437	437
CSPCP852	852
CSSHIFTJIS	943
CSUCS4	1236
CSUNICODE11	1204
CSUNICODE	1204
CSUNICODEASCII	1204
CSUNICODELATIN1	1204
CSVISCI	1129
CSWINDOWS31J	943
CYRILLIC	915
DEFAULT	367
EBCDICATDE	273
EBCDICCAFR	500
EBCDICCPAR1	420
EBCDICCPBE	500
EBCDICCPCA	37
EBCDICCPCH	500
EBCDICCPDK	277
EBCDICCPES	284
EBCDICCPFI	278
EBCDICPPFR	297
EBCDICCPGB	285
EBCDICCPGR	423
EBCDICPPHE	424
EBCDICPPIS	871
EBCDICPPIT	280

Table 39. Encoding names and effective CCSIDs (continued)

Normalized encoding name	CCSID
EBCDICPNL	37
EBCDICPNO	277
EBCDICPROECE	870
EBCDICPSE	278
EBCDICPUS	37
EBCDICPWT	37
EBCDICPYU	870
EBCDICDE273EURO	1141
EBCDICDK277EURO	1142
EBCDICDKNO	277
EBCDICES284EURO	1145
EBCDICES	284
EBCICFI278EURO	1143
EBCICFISE	278
EBCICFR297EURO	1147
EBCICFR	297
EBCICGB285EURO	1146
EBCICINTERNATIONAL500EURO	1148
EBCICIS871EURO	1149
EBCICIT280EURO	1144
EBCICIT	280
EBCICLATIN9EURO	924
EBCICNO277EURO	1142
EBCICPT	37
EBCICSE278EURO	1143
EBCICUK	285
EBCICUS37EURO	1140
EBCICUS	37
ECMA114	1089
ECMA118	813
ELOT928	813
EUCCN	1383
EUCJP	954
EUCKR	970
EUCTW	964
EXTENDEDUNIXCODEPACKEDFORMATFORJAPANESE	954
GB18030	1392
GB2312	1383
GBK	1386
GREEK8	813

Table 39. Encoding names and effective CCSIDs (continued)

Normalized encoding name	CCSID
GREEK	813
HEBREW	62210
HPROMAN8	1051
IBM00858	858
IBM00924	924
IBM01140	1140
IBM01141	1141
IBM01142	1142
IBM01143	1143
IBM01144	1144
IBM01145	1145
IBM01146	1146
IBM01147	1147
IBM01148	1148
IBM01149	1149
IBM01153	1153
IBM01155	1155
IBM01160	1160
IBM037	37
IBM1026	1026
IBM1043	1043
IBM1047	1047
IBM1252	1252
IBM273	273
IBM277	277
IBM278	278
IBM280	280
IBM284	284
IBM285	285
IBM297	297
IBM367	367
IBM420	420
IBM423	423
IBM424	424
IBM437	437
IBM500	500
IBM808	808
IBM813	813
IBM819	819
IBM850	850

Table 39. Encoding names and effective CCSIDs (continued)

Normalized encoding name	CCSID
IBM852	852
IBM855	855
IBM857	857
IBM862	862
IBM863	863
IBM864	864
IBM866	866
IBM867	867
IBM869	869
IBM870	870
IBM871	871
IBM872	872
IBM902	902
IBM904	904
IBM912	912
IBM915	915
IBM916	916
IBM920	920
IBM921	921
IBM922	922
IBM923	923
IBMTHAI	838
IRV	367
ISO10646	1204
ISO10646UCS2	1200
ISO10646UCS4	1232
ISO10646UCSBASIC	1204
ISO10646UNICODELATIN1	1204
ISO646BASIC1983	367
ISO646IRV1983	367
ISO646IRV1991	367
ISO646US	367
ISO885911987	819
ISO885913	901
ISO885915	923
ISO885915FDIS	923
ISO88591	819
ISO885921987	912
ISO88592	912
ISO885951988	915

Table 39. Encoding names and effective CCSIDs (continued)

Normalized encoding name	CCSID
ISO88595	915
ISO885961987	1089
ISO88596	1089
ISO88596I	1089
ISO885971987	813
ISO88597	813
ISO885981988	62210
ISO88598	62210
ISO88598I	916
ISO885991989	920
ISO88599	920
ISOIR100	819
ISOIR101	912
ISOIR126	813
ISOIR127	1089
ISOIR128	920
ISOIR138	62210
ISOIR144	915
ISOIR146	915
ISOIR147	915
ISOIR148	920
ISOIR149	970
ISOIR2	367
ISOIR6	367
JUSIB1003MAC	915
JUSIB1003SERB	915
KOI8	878
KOI8R	878
KOI8U	1168
KOREAN	970
KSC56011987	970
KSC56011989	970
KSC5601	970
L1	819
L2	912
L5	920
L9	923
LATIN0	923
LATIN1	819
LATIN2	912

Table 39. Encoding names and effective CCSIDs (continued)

Normalized encoding name	CCSID
LATIN5	920
LATIN9	923
MAC	1275
MACEDONIAN	915
MACINTOSH	1275
MICROSOFTPUBLISHING	1004
MS1386	1386
MS932	943
MS936	1386
MS949	970
MSKANJI	943
PCMULTILINGUAL850EURO	858
R8	1051
REF	367
ROMAN8	1051
SERBIAN	915
SHIFTJIS	943
SJIS	943
SUNEUGREEK	813
T101G2	920
TIS20	874
TIS620	874
UNICODE11	1204
UNICODE11UTF8	1208
UNICODEBIGUNMARKED	1200
UNICODELITTLEUNMARKED	1202
US	367
USASCII	367
UTF16	1204
UTF16BE	1200
UTF16LE	1202
UTF32	1236
UTF32BE	1232
UTF32LE	1234
UTF8	1208
VISCII	1129
WINDOWS1250	1250
WINDOWS1251	1251
WINDOWS1252	1252
WINDOWS1253	1253

Table 39. Encoding names and effective CCSIDs (continued)

Normalized encoding name	CCSID
WINDOWS1254	1254
WINDOWS1255	1255
WINDOWS1256	1256
WINDOWS1257	1257
WINDOWS1258	1258
WINDOWS28598	62210
WINDOWS31J	943
WINDOWS936	1386
XEUCTW	964
XMSWIN936	1386
XUTF16BE	1200
XUTF16LE	1202
XWINDOWS949	970

## Mappings of CCSIDs to encoding names for serialized XML output data

As part of an implicit or explicit XMLSERIALIZE operation, the DB2 database manager might add an encoding declaration at the beginning of serialized XML output data.

That declaration has the following form:

```
<?xml version="1.0" encoding="encoding-name"?>
```

In general, the character set identifier in the encoding declaration describes the encoding of the characters in the output string. For example, when XML data is serialized to the CCSID that corresponds to the target application data type, the encoding declaration describes the target application variable CCSID. An exception is the case where the application performs an explicit XMLSERIALIZE function with INCLUDING XMLDECLARATION. When you specify INCLUDING XMLDECLARATION, the database manager generates an encoding declaration for UTF-8. If the target data type is a CLOB or DBCLOB type, additional code page conversion might occur, which can make the encoding information inaccurate. If the data is further parsed in the application, data corruption can result.

Where possible, the DB2 database manager chooses the IANA registry name for the CCSID, as prescribed by the XML standard.

Table 40. CCSIDs and corresponding encoding names

CCSID	Encoding name
37	IBM037
273	IBM273
277	IBM277
278	IBM278
280	IBM280
284	IBM284



Table 40. CCSIDs and corresponding encoding names (continued)

CCSID	Encoding name
285	IBM285
297	IBM297
367	US-ASCII
420	IBM420
423	IBM423
424	IBM424
437	IBM437
500	IBM500
808	IBM808
813	ISO-8859-7
819	ISO-8859-1
838	IBM-Thai
850	IBM850
852	IBM852
855	IBM855
857	IBM857
858	IBM00858
862	IBM862
863	IBM863
864	IBM864
866	IBM866
867	IBM867
869	IBM869
870	IBM870
871	IBM871
872	IBM872
874	TIS-620
878	KOI8-R
901	ISO-8859-13
902	IBM902
904	IBM904
912	ISO-8859-2
915	ISO-8859-5
916	ISO-8859-8-I
920	ISO-8859-9
921	IBM921
922	IBM922
923	ISO-8859-15
924	IBM00924
932	Shift_JIS

Table 40. CCSIDs and corresponding encoding names (continued)

CCSID	Encoding name
943	Windows-31J
949	EUC-KR
950	Big5
954	EUC-JP
964	EUC-TW
970	EUC-KR
1004	Microsoft-Publish
1026	IBM1026
1043	IBM1043
1047	IBM1047
1051	hp-roman8
1089	ISO-8859-6
1129	VISCII
1140	IBM01140
1141	IBM01141
1142	IBM01142
1143	IBM01143
1144	IBM01144
1145	IBM01145
1146	IBM01146
1147	IBM01147
1148	IBM01148
1149	IBM01149
1153	IBM01153
1155	IBM01155
1160	IBM-Thai
1161	TIS-620
1162	TIS-620
1163	VISCII
1168	KOI8-U
1200	UTF-16BE
1202	UTF-16LE
1204	UTF-16
1208	UTF-8
1232	UTF-32BE
1234	UTF-32LE
1236	UTF-32
1250	windows-1250
1251	windows-1251
1252	windows-1252

Table 40. CCSIDs and corresponding encoding names (continued)

CCSID	Encoding name
1253	windows-1253
1254	windows-1254
1255	windows-1255
1256	windows-1256
1257	windows-1257
1258	windows-1258
1275	MACINTOSH
1363	KSC_5601
1370	Big5
1381	GB2312
1383	GB2312
1386	GBK
1392	GB18030
4909	ISO-8859-7
5039	Shift_JIS
5346	windows-1250
5347	windows-1251
5348	windows-1252
5349	windows-1253
5350	windows-1254
5351	windows-1255
5352	windows-1256
5353	windows-1257
5354	windows-1258
5488	GB18030
8612	IBM420
8616	IBM424
9005	ISO-8859-7
12712	IBM424
13488	UTF-16BE
13490	UTF-16LE
16840	IBM420
17248	IBM864
17584	UTF-16BE
17586	UTF-16LE
62209	IBM862
62210	ISO-8859-8
62211	IBM424
62213	IBM862
62215	ISO-8859-8

Table 40. CCSIDs and corresponding encoding names (continued)

<b>CCSID</b>	<b>Encoding name</b>
62218	IBM864
62221	IBM862
62222	ISO-8859-8
62223	windows-1255
62224	IBM420
62225	IBM864
62227	ISO-8859-6
62228	windows-1256
62229	IBM424
62231	IBM862
62232	ISO-8859-8
62233	IBM420
62234	IBM420
62235	IBM424
62237	windows-1255
62238	ISO-8859-8-I
62239	windows-1255
62240	IBM424
62242	IBM862
62243	ISO-8859-8-I
62244	windows-1255
62245	IBM424
62250	IBM420

---

## Chapter 13. Annotated XML schema decomposition

Annotated XML schema decomposition (or "shredding") is the process of storing content from an XML document in columns of relational tables. Decomposition operates based on annotations specified in an XML schema. After an XML document is decomposed, the inserted data has the SQL data type of the column that it is inserted into.

An XML schema consists of one or more XML schema documents. In annotated XML schema decomposition, or schema-based decomposition, you control decomposition by annotating a document's XML schema with decomposition annotations. These annotations specify details such as the name of the target table and column the XML data is to be stored in, the default SQL schema for when a target table's SQL schema is not identified, the order in which XML data should be inserted into target tables, as well as any transformation of the content before it is stored. Refer to the summary of decomposition annotations for further examples of what can be specified through these annotations.

The annotated schema documents must be stored in and registered with the XML schema repository (XSR). The schema must then be enabled for decomposition.

After the successful registration of the annotated schema, decomposition of a single XML document can be performed either by calling one of the decomposition stored procedures or by executing the `DECOMPOSE XML DOCUMENT` command. To decompose multiple XML documents stored in a column, use `XDB_DECOMP_XML_FROM_QUERY` stored procedure or the `DECOMPOSE XML DOCUMENTS` command

Note that schema-based decomposition can be disabled or made inoperative. Refer to the topic on decomposition disablement for more information.

---

### Advantage of annotated XML schema decomposition

Annotated XML schema decomposition can be a solution for storing XML documents that conform to an XML schema, but where the XML schema does not readily match the definitions of the tables into which you are storing the documents.

In cases where the XML schema does not clearly match the table structure, you might need to adjust either the XML schema or the relational schema, or both, in order for the documents to fit the table structure. Changes to the XML or relational schema, however, might not always be possible or could be prohibitively expensive, especially if existing applications expect the relational schema to have a particular structure.

Annotated XML schema decomposition addresses this problem by enabling you to decompose documents that are based on new or existing XML schemas, into new or existing tables. This is possible because of the various features available in annotated XML schema decomposition. These features, which are expressed as annotations added to the XML schema documents, offer flexibility in mapping an XML schema structure to a relational table structure.

---

## Decomposing XML documents with annotated XML schemas

When you want to store pieces of an XML document in columns of one or more tables, you can use annotated XML schema decomposition. This type of decomposition breaks an XML document down for storage in tables, based on the annotations specified in a registered annotated XML schema.

### About this task

To decompose XML documents using annotated XML schemas:

### Procedure

1. If you are using a database created from earlier versions of DB2 database products, run the BIND command using the list file `xdb.lst`, which is found in the `sql11ib/bnd` directory.
2. Annotate the schema documents with XML decomposition annotations.
3. Register the schema documents and enable the schema for decomposition.
4. If any of the registered schema documents that belongs to the XML schema have changed, then all documents for this XML schema must be registered again and the XML schema must be enabled for decomposition.
5. Depending on the location of the XML document to be decomposed, use one of the methods indicated, providing the XSR object name for the XML schema:
  - For a single XML document is on the file system, use one of the following methods:
    - Call one of the XDBDECOMPXML stored procedures that is just large enough for the size of the document being decomposed.<sup>3</sup>
    - Issue the DECOMPOSE XML DOCUMENT command.
  - For one or more documents are stored in a binary or XML column, use one of the following methods:
    - Issue the DECOMPOSE XML DOCUMENTS command.
    - Call the XDB\_DECOMP\_XML\_FROM\_QUERY stored procedure.

### Results

## Registering and enabling XML schemas for decomposition

Once an annotated schema has been successfully registered and enabled for decomposition, you can use it to decompose XML documents.

### Before you begin

- Ensure that at least one element or attribute declaration in the XML schema is annotated with an XML decomposition annotation. This annotated element or attribute must be a descendant of, or itself be, a global element of complex type.
- Ensure all tables and columns referenced in the set of annotated schema documents that compose the XML schema exist in the database. A dependency is created between each table referenced in the schema and the XSR object that corresponds to this schema.
- Ensure that the `app1heapsz` configuration parameter is set to at least 1024.

---

3. If you are using scripts or applications to decompose several documents of which the size is unknown, consider using the DECOMPOSE XML DOCUMENT command to decompose, rather than the XDBDECOMPXML stored procedure, as the command automatically calls the stored procedure appropriate for the size of the document.

## Procedure

Choose one of the following methods to register and enable XML schemas for decomposition:<sup>4</sup>

- Stored procedures:
  1. Call the XSR\_REGISTER stored procedure, passing in the primary schema document.
  2. If the XML schema consists of more than one schema document, call the XSR\_ADDSCHEMADOC stored procedure for each of the schema documents that have not yet been registered.
  3. Call the XSR\_COMPLETE stored procedure with the **isusedfordecomposition** parameter set to 1.
- Command line:
  - If the XML schema consists of only one schema document, issue the **REGISTER XML SCHEMA** command with the **COMPLETE** and **ENABLE DECOMPOSITION** options.
  - If the XML schema consists of more than one schema document:
    1. For each schema document except the last, issue the **REGISTER XML SCHEMA** command.
    2. For the last schema document that has not yet been registered, issue the **REGISTER XML SCHEMA** command with the **COMPLETE** and **ENABLE DECOMPOSITION** options.
- JDBC interface:
  1. Call the DB2Connection.registerDB2XMLSchema method and set the **isUsedForDecomposition** boolean parameter to true to enable decomposition.<sup>5</sup>

## What to do next

When an XML schema is enabled for decomposition, a dependency is created between each table referenced in the schema and the XSR object that corresponds to this schema. This dependency prevents any table referenced in the schema from being renamed. The XSR object for the XML schema must be disabled for decomposition in order for a referenced table to be renamed. The tables referenced by XSR objects can be found in the SYSCAT.XSROBJECTDEP catalog view.

## Multiple XML document decomposition examples

The DECOMPOSE XML DOCUMENTS command uses a single XML schema to decompose a set of XML document stored in a binary or XML column. The data from the XML documents is stored in columns of relational tables based on annotations specified in the schema.

### Examples

The following example assumes the relational table ABC.SALESTAB contains two columns SALESDOC and DOCID. The column SALESDOC contains XML documents, and DOCID contains the document identifier for the XML documents are stored in SALESDOC. All the documents correspond to an XML schema registered as ABC.SALES in the XML schema repository (XSR), and the schema has

---

4. If the XML schema was previously registered using any of these methods, but not enabled for decomposition, you can enable the schema for decomposition by issuing the ALTER XSROBJECT SQL statement with the ENABLE DECOMPOSITION option.

5. This method exists in two forms: one form for XML schema documents that are input from an InputStream object, and one form for XML schema documents that are in a String.

been annotated with decomposition information and enabled for decomposition. Invoke the following DECOMPOSE XML DOCUMENTS command to decompose all the documents stored in ABC.SALESTAB.SALESDOC using the schema ABC.SALES:

```
DECOMPOSE XML DOCUMENTS IN 'SELECT DOCID, SALESDOC FROM ABC.SALESTAB'  
  XMLSCHEMA ABC.SALES  
  MESSAGES /home/myid/errors/errorreport.xml
```

Alternatively, use the XDB\_DECOMP\_XML\_FROM\_QUERY stored procedure to decompose the XML documents. The following stored procedure performs the same decomposition as the previous command.

```
XDB_DECOMP_XML_FROM_QUERY ('ABC', 'SALES', 'SELECT DOCID, SALESDOC FROM SALESTAB',  
  0, 0, 0, NULL, NULL, 1, numInput, numDecomposed,  
  errorreportBuf);
```

The following command decomposes the customer information in INFO from the CUSTOMER table where the CUSTID is greater than 1003 using the schema CUST\_SHRED. The example assumes the schema CUST\_SHRED is registered in the XSR.

```
DECOMPOSE XML DOCUMENTS IN 'SELECT CUSTID, INFO FROM CUSTOMER WHERE CUSTID > 1003'  
  XMLSCHEMA CUST_SHRED  
  MESSAGES /home/myid/errors/errorreport.xml
```

## Annotated XML schema decomposition and recursive XML documents

XML schemas containing recursion can be registered in the XML schema repository (XSR) and enabled for decomposition, with the restriction that the recursive relationships themselves cannot be decomposed as scalar values into a target table. By using appropriate schema annotations, the recursive sections can be stored and later retrieved as serialized markup.

### Types of recursion

An XML schema is said to be recursive when the definition of types in it allow for elements of the same name and type to appear in their own definition. Recursion may be explicit or implicit.

#### Explicit recursion

Explicit recursion occurs when an element is defined in terms of itself. This is shown in the following example, where the element <root> is explicitly referred to in its own definition using the ref element declaration attribute:

```
<xs:element name="root">  
  <xs:complexType>  
    <xs:sequence>  
      <xs:element name="a" type="xs:string"/>  
      <xs:element name="b">  
        <xs:complexType>  
          <xs:sequence>  
            <xs:element name="c" type="xs:string"/>  
            <xs:element ref="root" minOccurs="0"/>  
          </xs:sequence>  
        </xs:complexType>  
      </xs:element>  
    </xs:sequence>  
  </xs:complexType>  
</xs:element>
```

With explicit recursion, a recursive branch is delimited as follows:



- The start of a recursive branch is a declaration of element Y whose ancestors do not consist of another element declaration of Y. The start of a recursive branch can have multiple branches of descendants; for a particular descendant branch, if the branch has another element declaration of Y, the branch is considered a recursive branch.
- The end of a recursive branch is the highest level element declaration of Y that is a descendant of the start of the branch. Note that the end of branch is specifically an element reference

The node that is a start of a recursive branch can serve as the starting node for multiple recursive branches. In the following example there are two explicitly recursive branches:

1. <root> (\*), <b>, <root> (\*\*)
2. <root> (\*), <b>, <root> (\*\*\*)

```
<xs:element name="root"> <!-- * -->
  <xs:complexType>
    <xs:sequence>
      <xs:element name="a" type="xs:string"/>
      <xs:element name="b">
        <xs:complexType>
          <xs:sequence>
            <xs:element name="c" type="xs:string"/>
            <xs:element ref="root" minOccurs="1"/> <!-- ** -->
            <xs:element ref="root" minOccurs="1"/> <!-- *** -->
          </xs:sequence>
        </xs:complexType>
      </xs:element>
    </xs:sequence>
  </xs:complexType>
</xs:element>
```

A recursive branch delineates how its member elements are decomposed. In the instance document, the occurrence of element Y that corresponds to the start of the recursive branch, and its descendants, up to the occurrence of Y that corresponds to the end of that branch, can be decomposed as scalar values. The occurrence of Y in the instance document corresponding to the end of the recursive branch, marks the recursive region. The recursive region begins with the starting element tag of this occurrence of Y, and ends with the end element tag of the occurrence. All elements and attributes in the instance document that are in this recursive region can be decomposed as markup or as string values, depending on the value specified for the db2-xdb:contentHandling decomposition annotation.

### Implicit recursion

Implicit recursion occurs when an element with a complex type definition contains another element, also defined as a complex type, where the latter has as its type attribute the name of a complex type definition of which it is a part. This is shown in the following example, where the element <beginRecursion> refers to the type "rootType" and the element <beginRecursion> is itself part of the type "rootType" being defined:

```
<xs:element name="root" type="rootType"/>
<xs:complexType name="rootType">
  <xs:sequence>
    <xs:element name="a" type="xs:string"/>
    <xs:element name="b">
      <xs:complexType>
        <xs:sequence>
          <xs:element name="c" type="xs:string"/>
          <xs:element name="beginRecursion" type="rootType" minOccurs="0"/>
        </xs:sequence>
      </xs:complexType>
    </xs:element>
  </xs:sequence>
</xs:complexType>
```

```

        </xs:complexType>
    </xs:element>
</xs:sequence>
</xs:complexType>

```

With implicit recursion, a recursive branch is delimited as follows:

- The start of a recursive branch is a declaration of element Y of complexType type CT whose ancestors do not consist of another element declaration of type CT. The start of a recursive branch can have multiple branches of descendants; for a particular descendant branch, if the branch has another element declaration of Z of type CT, the branch is considered a recursive branch.
- The end of a recursive branch is the highest level element declaration of type CT that is a descendant of the start of the branch.

The node that is a start of a recursive branch can serve as the starting node for multiple recursive branches. In the following example there are two implicitly recursive branches:

1. <root>, <b>, <beginRecursion>

2. <root>, <b>, <anotherRecursion>

```

<xs:element name="root" type="rootType"/>
<xs:complexType name="rootType">
  <xs:sequence>
    <xs:element name="a" type="xs:string"/>
    <xs:element name="b">
      <xs:complexType>
        <xs:sequence>
          <xs:element name="c" type="xs:string"/>
          <xs:element name="beginRecursion" type="rootType" minOccurs="2"/>
          <xs:element name="anotherRecursion" type="rootType" minOccurs="0"/>
        </xs:sequence>
      </xs:complexType>
    </xs:element>
  </xs:sequence>
</xs:complexType>

```

There is a slight difference in how this second, implicit type of recursion is decomposed, as compared to explicit recursion. In the instance document, the occurrence of element Y that corresponds to the start of the recursive branch, and its descendants, up to the occurrence of Z that corresponds to the end of that branch, can be decomposed as scalar values. This occurrence of Z in the instance document marks the recursive region. The recursive region begins *after* the starting element tag of Z, and ends immediately *before* the end element tag of Z. All element descendants of this occurrence of Z lie in this recursive region. However, the attributes of this occurrence are outside the recursive region and can therefore be decomposed as scalar values.

## Decomposition behavior for recursive branches

For both types of recursion, the recursive branch delineates non-recursive and recursive regions in the corresponding part of the instance document. Only the non-recursive regions of an XML instance document can be decomposed as scalar values into a target database table. This restriction includes any non-recursive regions within one branch that are part of a recursive region of an enclosing branch. That is, if recursive branch RB2 is completely encompassed by recursive branch RB1, then for some instances of RB2 in the instance XML document, its non-recursive region can fall inside the recursive region of an instance of RB1. In this case, this non-recursive region cannot be decomposed as scalar values; instead

it is part of the markup which is the decomposition result for RB1. For any instance of RB2, only the non-recursive region of the instance that is not inside any other recursive region can be decomposed as scalar values.

For example, the following XML schema contains two recursive branches:

1. RB1 (<root> (identified with \*), <b>, <root> (identified with \*\*))
2. RB2 (<d>, <d>)

```
<xs:element name="d">
  <xs:complexType>
    <xs:sequence>
      <xs:element ref="d"/>
    </xs:sequence>
    <xs:attribute name="id" type="xs:int"/>
  </xs:complexType>
</xs:element>
<xs:element name="root"> <!-- * -->
  <xs:complexType>
    <xs:sequence>
      <xs:element name="a" type="xs:string"/>
      <xs:element ref="d"/>
      <xs:element name="b">
        <xs:complexType>
          <xs:sequence>
            <xs:element name="c" type="xs:string"/>
            <xs:element ref="root" minOccurs="1"/> <!-- ** -->
          </xs:sequence>
        </xs:complexType>
      </xs:element>
    </xs:sequence>
  </xs:complexType>
</xs:element>
```

The recursive regions of an associated instance document are highlighted in the following example. There are two instances of RB2 (<d>, <d>) in the instance document, but only the non-recursive region of the first instance of RB2 (<d> identified by #) can be decomposed as scalar values. That is, the attribute id="1" can be decomposed. The non-recursive region of the second instance of RB2 is completely within the second highlighted area, which is a recursive region of the instance of RB1. Therefore, the attribute id="2" cannot be decomposed.

```
<root>
  <a>a str1</a>
  <d id="1"> <d id="11"> </d> </d>
  <b>
    <c>c str1</c>
    <root>
      <a>a str1</a>
      <d id="2"> <d id="22"> </d> </d>
      <b>
        <c>c str1</c>
      </b>
    </root>
  </b>
</root>
```

### Example: Using the db2-xdb:contentHandling decomposition annotation with both types of recursion

This example demonstrates decomposition behavior for both the explicit and implicit type of recursion, and the results of setting different values for the db2-xdb:contentHandling annotation. In the following two XML instance documents the recursive regions are highlighted.

In Document 1, recursion begins when the <root> element appears below itself:

```
<root>
  <a>a str1</a>
  <b>
    <c>c str1</c>
    <root>
      <a>a str11</a>
      <b>
        <c>c str11</c>
      </b>
    </root>
  </b>
</root>
```

In Document 2, recursion begins for elements below the element <beginRecursion>:

```
<root>
  <a>a str2</a>
  <b>
    <c>c str2</c>
    <beginRecursion>
      <a>a str22</a>
      <b>
        <c>c str22</c>
      </b>
    </beginRecursion>
  </b>
</root>
```

In an instance document, all elements or attributes and their contents that appear between the beginning of recursion and end of recursion cannot be decomposed as scalar values into table-column pairs. However a serialized markup version of the items between the beginning of recursion and end of recursion can be obtained by annotating an element (of complexType) in the recursive branch with the db2-xdb:contentHandling attribute set to "serializeSubtree". A text serialization of all the character data in this part can also be obtained by setting db2-xdb:contentHandling to "stringValue". In general, the content or markup of the recursive path can be obtained by setting the db2-xdb:contentHandling attribute appropriately at any complexType element of the recursive branch or on an element that is an ancestor of the elements in the recursive branch.

For instance, annotating element <b> in the following XML schema:

```
<xs:element name="root">
  <xs:complexType>
    <xs:sequence>
      <xs:element name="a" type="xs:string"/>
      <xs:element name="b"
        db2-xdb:rowSet="TABLEx"
        db2-xdb:column="COLx"
        db2-xdb:contentHandling="serializeSubtree">
        <xs:complexType>
          <xs:sequence>
            <xs:element name="c" type="xs:string"/>
            <xs:element ref="root" minOccurs="0"/>
          </xs:sequence>
        </xs:complexType>
      </xs:element>
    </xs:sequence>
  </xs:complexType>
</xs:element>
```

results in this XML fragment being inserted into a row of TABLEx, COLx when Document 1 is decomposed:

```
<b>
  <c>c str1</c>
  <root>
    <a>a str1</a>
    <b>
      <c>c str1</c>
    </b>
  </root>
</b>
```

Similarly, annotating element "beginRecursion" in the following XML schema:

```
<xs:element name="root" type="rootType"/>
<xs:complexType name="rootType">
  <xs:sequence>
    <xs:element name="a" type="xs:string"/>
    <xs:element name="b">
      <xs:complexType>
        <xs:sequence>
          <xs:element name="c" type="xs:string"/>
          <xs:element name="beginRecursion"
            type="rootType" minOccurs="0"
            db2-xdb:rowSet="TABLEx"
            db2-xdb:column="COLx"
            db2-xdb:contentHandling="serializeSubtree"/>
        </xs:sequence>
      </xs:complexType>
    </xs:element>
  </xs:sequence>
</xs:complexType>
```

results in this XML fragment being inserted into a row of TABLEx, COLx when Document 2 is decomposed:

```
<beginRecursion>
  <a>a str22</a>
  <b>
    <c>c str22</c>
  </b>
</beginRecursion>
```

---

## Disabling of annotated XML schema decomposition

Annotated XML schema decomposition can be made inoperative by DB2 under certain conditions or explicitly disabled by a user.

### Conditions that make decomposition inoperative

Schema-based decomposition is automatically made inoperative if any of the following conditions are satisfied, for annotated schemas that have been previously registered and enabled for decomposition. (Note that an XML schema that is made inoperative for decomposition can still be used for validation performed outside of the context of decomposition, such as with the XMLVALIDATE SQL/XML function.) The corrective action needed to re-enable decomposition is listed for each condition.

Table 41. Conditions that make decomposition inoperative and corresponding corrective action

Condition	Action to re-enable decomposition
Table referenced in annotation is dropped	Remove the reference to the dropped table from the schema document, re-register the entire annotated schema, and enable the schema for decomposition
Column referenced in annotation has its data type changed to a type that is compatible with the XML schema type	Re-enable the schema for decomposition by executing the ALTER XSROBJECT SQL statement with the ENABLE DECOMPOSITION option
Column referenced in annotation has its data type changed to a type that is incompatible with the XML schema type	Adjust the annotations as required, re-register the entire annotated schema, and enable the schema for decomposition
Document that belongs to the annotated schema changes	Re-register all of the documents that form that schema and enable the schema for decomposition

For more information, refer to the task documentation on registering annotated schemas and enabling decomposition.

## Explicit disabling

You can explicitly disable schema-based decomposition by executing either of the following SQL statements, specifying the XSR object that corresponds to the annotated schema you want to disable:

- ALTER XSROBJECT with the DISABLE DECOMPOSITION option

**Note:** An XML schema that is disabled for decomposition can still be used for validation.

- DROP with the XSROBJECT option

**Note:** Which option to choose depends on what the XML schema is needed for. If the schema is needed for validation, then it should be disabled for decomposition, rather than dropped. If the schema is used only for decomposition, and you do not expect to use it again for decomposition, then you can drop the XSR object.

---

## xdbDecompXML procedures for annotated schema decomposition

Annotated XML schema decomposition can be invoked by calling one of ten built-in procedures, which decompose a single XML document.

Annotated XML schema decomposition procedures:

- xdbDecompXML
- xdbDecompXML10MB
- xdbDecompXML25MB
- xdbDecompXML50MB
- xdbDecompXML75MB
- xdbDecompXML100MB
- xdbDecompXML500MB
- xdbDecompXML1GB
- xdbDecompXML1\_5GB

- xdbDecompXML2GB

These procedures differ only in the size of the *xmldoc* argument, which specifies the size of the input document to be decomposed. Call the procedure that is just large enough for the size of the document you want to decompose, to minimize system memory usage. For example, to decompose a document 1MB in size, use the xdbDecompXML procedure.

The syntax for xdbDecompXML is presented in the following section; refer to the description of the *xmldoc* argument for specifications of the *xmldoc* argument for the xdbDecompXML10MB, xdbDecompXML25MB, xdbDecompXML50MB, xdbDecompXML75MB, xdbDecompXML100MB, xdbDecompXML500MB, xdbDecompXML1GB, xdbDecompXML1\_5GB and xdbDecompXML2GB procedures.

## Syntax

```
►► xdbDecompXML (—rschema—, —xmlschemaname—, —xmldoc—, —documentid—, —validation—, —reserved—, —reserved—, —reserved—)
```

The schema of the procedure is SYSPROC.

## Authorization

The authorization ID belonging to the statement that calls this procedure must have one of the following privileges or authorizations:

- All of the following privileges:
  - INSERT privilege on all target tables referenced in the annotated schema
  - SELECT, INSERT, UPDATE, or DELETE privilege, as applicable, on any table referenced by the db2-xdb:expression or db2-xdb:condition annotation
- CONTROL privilege on all target tables referenced in the set of annotated schema documents
- DATAACCESS authority

If the value of *validation* is 1, the authorization ID belonging to the statement that calls this procedure must have USAGE privilege on the XML schema.

## Procedure parameters

### *rschema*

An input argument of type VARCHAR(128) that specifies the SQL schema part of the two-part XSR object name registered with the XML schema repository. If this value is NULL, then the SQL schema part is assumed to be the current value of the CURRENT SCHEMA special register.

### *xmlschemaname*

An input argument of type VARCHAR(128) that specifies the schema name of the two-part XSR object name registered with the XML schema repository. This value cannot be NULL.

### *xmldoc*

An input argument of type BLOB(1M) that specifies the buffer containing the XML document to be decomposed.

**Note:**

- For the `xdbDecompXML10MB` procedure, this argument is of type `BLOB(10M)`.
- For the `xdbDecompXML25MB` procedure, this argument is of type `BLOB(25M)`.
- For the `xdbDecompXML50MB` procedure, this argument is of type `BLOB(50M)`.
- For the `xdbDecompXML75MB` procedure, this argument is of type `BLOB(75M)`.
- For the `xdbDecompXML100MB` procedure, this argument is of type `BLOB(100M)`.
- For the `xdbDecompXML500MB` procedure, this argument is of type `BLOB(500M)`.
- For the `xdbDecompXML1GB` procedure, this argument is of type `BLOB(1G)`.
- For the `xdbDecompXML1_5GB` procedure, this argument is of type `BLOB(1.5G)`.
- For the `xdbDecompXML2GB` procedure, this argument is of type `BLOB(2G)`.

*documentid*

An input argument of type `VARCHAR(1024)` that specifies the identifier for the input XML document to be decomposed. The value provided in this argument will be substituted for any use of `$DECOMP_DOCUMENTID` specified in the `db2-xdb:expression` or `db2-xdb:condition` annotations in the corresponding XML schema.

*validation*

An input argument of type `INTEGER` that indicates whether validation will be performed on the document before it is decomposed. The possible values are:

- 0** Validation is not performed on the input document before it is decomposed.
- 1** Validation is performed on the input document against DTDs or XML schema documents previously registered with the XML schema repository. The input XML document is decomposed only if the validation is successful.

*reserved*

The *reserved* arguments are input arguments reserved for future use. The values passed for these arguments must be `NULL`.

## Output

There is no explicit output argument for this procedure. Check the `sqlcode` field of the `SQLCA` structure for any errors that might have occurred during decomposition. The possible `sqlcode` values following the completion of decomposition are:

- 0** Document was successfully decomposed.

**positive integer**

Document was successfully decomposed, but with warning conditions. The warnings are logged in the **db2diag** log files, located in the first occurrence data capture (FODC) storage directory.

**negative integer**

Document could not be decomposed. The `sqlcode` indicates the reason for the failure. Check the **db2diag** log files for details of the failure.



## Usage notes

The procedures execute with the read stability isolation level.

The procedures run atomically; if a procedure fails during execution, all operations performed by the procedure are rolled back. To commit the changes made by the procedure, the caller must execute the COMMIT SQL statement, as the procedure itself does not execute COMMIT.

If you are using scripts or applications to decompose several documents of which the size is unknown, consider using the **DECOMPOSE XML DOCUMENT** command to decompose, rather than an xdbDecompXML procedure, as the command automatically calls the appropriate procedure for the size of the document.

## Example

The annotated XML schema, which indicates the table and column that the XML values will decompose into, has been registered with the XML schema repository as ABC.TEST. To decompose the XML document into a relational table, call the appropriate procedure as follows:

```
CALL xdbDecompXML ('ABC', 'TEST', BLOB('<Element1>Hello world</Element1>'),  
                 'DOCID', 0 , NULL, NULL, NULL)
```

---

## DECOMPOSE XML DOCUMENT

Invokes a stored procedure to decompose a single XML document using a registered and decomposition-enabled XML schema.

### Authorization

One of the following groups of privileges or authorities is required:

- One of the following authorizations:
  - CONTROL privilege on all target tables referenced in the set of annotated schema documents
  - DATAACCESS authority
- All of the following privileges:
  - INSERT privileges on the target table, as required for the operation specified in the action file
  - SELECT, INSERT, UPDATE, or DELETE privilege, as applicable, on any table referenced by the db2-xdb:expression or db2-xdb:condition annotation

If the **VALIDATE** option is specified, USAGE privilege on the XML schema is also required.

### Required connection

Database

### Command syntax

```
►►—DECOMPOSE XML DOCUMENT—xml-document-name—XMLSCHEMA—xml-schema-name—►►
```

VALIDATE

## Command parameters

**DECOMPOSE XML DOCUMENT** *xml-document-name*

*xml-document-name* is the file path and file name of the input XML document to be decomposed.

**XMLSCHEMA** *xml-schema-name*

*xml-schema-name* is the name of an existing XML schema registered with the XML schema repository to be used for document decomposition.

*xml-schema-name* is a qualified SQL identifier consisting of an optional SQL schema name followed by a period and the XML schema name. If the SQL schema name is not specified, it is assumed to be the value of the DB2 special register CURRENT SCHEMA.

**VALIDATE**

This parameter indicates that the input XML document is to be validated first, then decomposed only if the document is valid. If **VALIDATE** is not specified, the input XML document will not be validated before decomposition.

## Examples

The following example specifies that the XML document `./gb/document1.xml` is to be validated and decomposed with the registered XML schema `DB2INST1.GENBANKSCHEMA`.

```
DECOMPOSE XML DOCUMENT ./gb/document1.xml
XMLSCHEMA DB2INST1.GENBANKSCHEMA
VALIDATE
```

The following example specifies that the XML document `./gb/document2.xml` is to be decomposed without validation with the registered XML schema `DB2INST2."GENBANK SCHEMA1"`, on the assumption that the value of the DB2 special register `CURRENT SCHEMA` is set to `DB2INST2`.

```
DECOMPOSE XML DOCUMENT ./gb/document2.xml
XMLSCHEMA "GENBANK SCHEMA1"
```

---

## XDB\_DECOMP\_XML\_FROM\_QUERY stored procedure for annotated schema decomposition

The stored procedure decomposes one or more XML documents from a binary or XML column. The data from the XML documents is stored in columns of relational tables based on annotations specified in an XML schema.

### Syntax

```
► XDB_DECOMP_XML_FROM_QUERY (—rschema—, —xmlschema—, —query—, —————►
► —validation—, —commit_count—, —allow_access—, —reserved—, —reserved2—, —————►
► —continue_on_error—, —total_docs—, —num_docs_decomposed—, —————►
```

The schema of the stored procedure is SYSPROC.

The procedure executes with the read stability isolation level.

## Authorization

One of the following authorizations or privileges is required:

- All of the following privileges:
  - INSERT privilege on all target tables referenced in the annotated schema
  - SELECT privilege on the table, alias, or view containing the column holding the input documents
  - SELECT, INSERT, UPDATE, or DELETE privilege, as applicable, on any table referenced by the db2-xdb:expression or db2-xdb:condition annotation
- CONTROL privilege on all tables referenced in the set of annotated schema documents and on the table, alias, or view containing the column holding the input documents
- DATAACCESS authority

If the value of *validation* is 1, USAGE privilege on the XML schema is also required.

## Procedure parameters

### *rschema*

An input argument of type VARCHAR(128) that specifies the SQL schema part of the two-part XML schema repository (XSR) object name registered with the XML schema repository. The value can be NULL. If the value is NULL, the SQL schema part is assumed to be the current value of the CURRENT SCHEMA special register.

### *xmlschema*

An input argument of type VARCHAR(128) that specifies the name of the two-part XSR object name registered with the XSR. This value cannot be NULL.

### *query*

An input argument of type CLOB(1MB). This value cannot be NULL. The *query* conforms to the rules of an SQL SELECT statement, and must return a result set containing 2 columns. The first column is the document identifier. Each document identifier uniquely identifies an XML document to be decomposed. The column must be of character type or be castable to character type. The second column contains the XML documents to be decomposed. The supported types for the document column are XML, BLOB, VARCHAR FOR BIT DATA, and LONG VARCHAR FOR BIT DATA. The column containing the XML documents must resolve to a column of an underlying base table, the column cannot be a generated column.

For example, the DOCID column in the following SELECT statement contains the unique identifiers for the XML documents stored in SALESDOC column.

```
SELECT DOCID, SALESDOC FROM SALESTAB
```

### *validation*

An input argument of type INTEGER that indicates whether validation will be performed on the documents before they are decomposed. The possible values are:

- 0 Validation is not performed on the input documents before they are decomposed.

If a 0 value is passed and validation is not performed, it is the user's responsibility to validate the documents before calling the stored procedure. For example, the user can use XMLVALIDATE when inserting the XML documents into the column, or use an XML processor before inserting the documents. If an input XML document is not valid and 0 is specified for this parameter, the decomposition results are undefined.

- 1 Validation is performed on the input documents against DTDs or XML schema documents previously registered with the XML schema repository. The input XML documents are decomposed only if the validation is successful.

### *commit\_count*

An input argument of type INTEGER. The possible values are:

- 0 No COMMIT is ever performed by the stored procedure.

#### ***n*, a positive integer**

After every *n* successful document decompositions, a COMMIT is performed.

### *allow\_access*

An input argument of type INTEGER. The possible values are:

- 0 The stored procedure will acquire an exclusive lock (X) on all tables with mappings in the XML schema. Not all tables will necessarily participate during decomposition of each document, but all target tables will be locked to lower the possibility of deadlock during a long unit of work.
- 1 When acquiring locks, the stored procedure will wait and possibly timeout.

### *reserved*

The *reserved* argument is an input argument reserved for future use. The value passed for this argument must be NULL.

### *reserved2*

The *reserved2* argument is an input argument reserved for future use. The value passed for this argument must be NULL.

### *continue\_on\_error*

An input argument of type INTEGER. The possible values are:

- 0 The stored procedure stops on the first document that cannot be successfully decomposed. If an error occurs during the decomposition of a document, changes to the database made during the decomposition of the document are undone.
- 1 The stored procedure does not stop on document-specific errors and attempts to decompose all documents specified by *query*. If an error occurs during the decomposition of a document, changes to the database made during the decomposition of the document are undone, and the stored procedure attempts to decompose the next document. Information about any document that is not successfully decomposed is written to *result\_report*.

The stored procedure does not continue on fatal errors and non-document specific errors regardless of the value of *continue\_on\_error*.

#### *total\_docs*

An output argument of type INTEGER that specifies the total number of input documents that the XDB\_DECOMP\_XML\_FROM\_QUERY stored procedure attempted to decompose.

#### *num\_docs\_decomposed*

An output argument of type INTEGER that specifies the number of documents that were successfully decomposed.

#### *result\_report*

An output argument of type BLOB(100MB). A buffer containing a UTF-8 XML document that lists the name of each input file that was not successfully decomposed, along with a diagnostic message. This report is generated only when there is at least one XML document that could not be successfully decomposed.

The format of the XML document in *result\_report* is as follows:

```
<?xml version='1.0'?>
<xdb:errorReport xmlns:xdb="http://www.ibm.com/xmlns/prod/db2/xdb1">
  <xdb:document>
    <xdb:documentId>sssss</xdb:documentId>
    <xdb:errorMsg>qqqqq</xdb:errorMsg>
  </xdb:document>
  <xdb:document>
    .
    .
    .
  </xdb:document>
  .
  .
  .
</xdb:errorReport>
```

The documentId value *sssss* is the value from the first column specified by *query*. The value identifies the XML document that was not successfully decomposed. The errorMsg value *qqqqq* is the error encountered during the attempt to decompose the document.

## Output

The SQLCA structure indicates the return status of the procedure after attempting to decompose the XML documents. The procedure can return one of the following SQLCODE values:

**0** All documents specified by *query* were successfully decomposed.

#### **16278**

The decomposition of one or more documents failed. The number of successful documents is given as the *num\_docs\_decomposed* output parameter to the stored procedure. Individual error messages for each failed document are recorded in *result\_report*. Further diagnostic details on each failure are logged in a **db2diag** log file.

#### **negative integer**

No documents were decomposed. The SQLCODE indicates the reason for the failure. Check the **db2diag** log file for details of the failure.

## Note

The stored procedure is declared with these characteristics:

DYNAMIC RESULT SETS 0  
NOT DETERMINISTIC  
UNFENCED  
THREADSAFE  
MODIFIES SQL DATA  
PARAMETERSTYLE SQL  
CALLED ON NULL INPUT  
NEW SAVEPOINT LEVEL  
DBINFO

## Example

The following example assumes the table ABC.SALESTAB contains two columns SALESDOC and DOCID. The column SALESDOC contains XML documents, and the column DOCID contains the unique identifier for the XML documents in SALESDOC. All the XML documents correspond to an XML schema registered as ABC.SALES, and the schema has been annotated with decomposition information and enabled for decomposition. The following example calls the stored procedure to decompose the documents stored in SALESDOC using the schema ABC.SALES:

```
XDB_DECOMP_XML_FROM_QUERY ('ABC', 'SALES',  
    'SELECT DOCID, SALESDOC FROM ABC.SALESTAB', 0, 0, 0,  
    NULL, NULL, 1, numInput, numDecomposed, errorreportBuf);
```

---

## XML decomposition annotations

Annotated XML schema decomposition relies on annotations added to XML schema documents. These decomposition annotations function as mappings between the elements or attributes of the XML document to their target tables and columns in the database. Decomposition processing refers to these annotations to determine how to decompose an XML document.

The XML decomposition annotations belong to the `http://www.ibm.com/xmlns/prod/db2/xdb1` namespace and are identified by the "db2-xdb" prefix throughout the documentation. You can select your own prefix; however, if you do, you must bind your prefix to the following namespace: `http://www.ibm.com/xmlns/prod/db2/xdb1`. The decomposition process recognizes only annotations that are under this namespace at the time the XML schema is enabled for decomposition.

The decomposition annotations are recognized by the decomposition process only if they are added to element and attribute declarations, or as global annotations, in the schema document. They are either specified as attributes or as part of an `<xs:annotation>` child element of the element or attribute declaration. Annotations added to complex types, references, or other XML schema constructs are ignored.

Although these annotations exist in the XML schema documents, they do not affect the original structure of the schema document, nor do they participate in the validation of XML documents. They are referred to only by the XML decomposition process.

Two annotations that are core features of the decomposition process are: `db2-xdb:rowSet` and `db2-xdb:column`. These annotations specify the decomposed value's target table and column, respectively. These two annotations must be specified in order for the decomposition process to successfully complete. Other annotations are optional, but can be used for further control of how the decomposition process operates.

## XML decomposition annotations - Specification and scope

Annotations for decomposition can be specified as either element or attribute declarations in an XML schema document.

Annotations can be specified as either:

- a simple attribute on an element or attribute declaration, or
- a structured (complex) child element of an element or attribute declaration, which consists of simple elements and attributes

### Annotations as attributes

Annotations specified as simple attributes on element or attribute declarations apply only to that element or attribute on which it is specified.

For example, the `db2-xdb:rowSet` and `db2-xdb:column` decomposition annotations can be specified as attributes. These annotations would be specified as follows:

```
<xs:element name="isbn" type="xs:string"
            db2-xdb:rowSet="TEXTBOOKS" db2-xdb:column="ISBN"/>
```

The `db2-xdb:rowSet` and `db2-xdb:column` annotations apply only to this element named `isbn`.

### Annotations as structured child elements

Annotations specified as structured children elements of an element or attribute declaration must be specified in the schema document within the `<xs:annotation><xs:appinfo></xs:appinfo></xs:annotation>` hierarchy defined by XML Schema.

For example, the `db2-xdb:rowSet` and `db2-xdb:column` annotations can be specified as children elements (they are children of the `<db2-xdb:rowSetMapping>` annotation) as follows:

```
<xs:element name="isbn" type="xs:string">
  <xs:annotation>
    <xs:appinfo>
      <db2-xdb:rowSetMapping>
        <db2-xdb:rowSet>TEXTBOOKS</db2-xdb:rowSet>
        <db2-xdb:column>ISBN</db2-xdb:column>
      </db2-xdb:rowSetMapping>
    </xs:appinfo>
  </xs:annotation>
</xs:element>
```

Specifying the `db2-xdb:rowSet` and `db2-xdb:column` annotations as children elements is equivalent to specifying these annotations as attributes (which was shown previously). While more verbose than the method of specifying annotations as attributes, specifying annotations as children elements is required when you need to specify more than one `<db2-xdb:rowSetMapping>` for an element or attribute; that is, when you need to specify multiple mappings on the same element or attribute declaration.

### Global annotations

When an annotation is specified as a child of the `<xs:schema>` element, it is a global annotation that applies to all of the XML schema documents that make up the XML schema.

For example, the `<db2-xdb:defaultSQLSchema>` annotation indicates the default SQL schema for all unqualified tables referenced in the XML schema. `<db2-xdb:defaultSQLSchema>` must be specified as a child element of `<xs:schema>`:

```
<xs:schema>
  <xs:annotation>
    <xs:appinfo>
      <db2-xdb:defaultSQLSchema>admin</db2-xdb:defaultSQLSchema>
    </xs:appinfo>
  </xs:annotation>
  ...
</xs:schema>
```

This declaration specifies that all unqualified tables across all schema documents that form this XML schema will have the SQL schema of "admin".

Refer to the documentation for a specific annotation to determine how a particular annotation can be specified.

## XML decomposition annotations - Summary

DB2 supports a set of annotations used by the annotated XML schema decomposition process to map elements and attributes from an XML document to target database tables. The following summary of some of the XML decomposition annotations is grouped by the tasks and actions you use the annotations to perform.

For more information about a specific annotation, refer to the detailed documentation about it.

*Table 42. Specifying the SQL schema*

Action	XML decomposition annotation
Specify the default SQL schema for all tables that do not specify their SQL schema	db2-xdb:defaultSQLSchema
Specify an SQL schema different from the default for a specific table	db2-xdb:table (<db2-xdb:SQLSchema> child element)

*Table 43. Mapping XML elements or attributes to target base tables*

Action	XML decomposition annotation
Map a single element or attribute to single column and table pair	db2-xdb:rowSet with db2-xdb:column as attribute annotations or db2-xdb:rowSetMapping
Map a single element or attribute to one or more distinct column and table pairs	db2-xdb:rowSetMapping
Map multiple elements or attributes to single column and table pair	db2-xdb:table
Specify ordering dependencies between target tables	db2-xdb:rowSetOperationOrder, db2-xdb:rowSet, db2-xdb:order

*Table 44. Specifying the XML data to be decomposed*

Action	XML decomposition annotation
Specify the type of content to be inserted for an element of complex type (text, string, or markup)	db2-xdb:contentHandling



Table 44. Specifying the XML data to be decomposed (continued)

Action	XML decomposition annotation
Specify any content transformation to be applied before insertion	db2-xdb:normalization, db2-xdb:expression, db2-xdb:truncate
Filter the data to be decomposed based on the item's content or the context in which it appears	db2-xdb:condition db2-xdb:locationPath

## db2-xdb:defaultSQLSchema decomposition annotation

The db2-xdb:defaultSQLSchema annotation specifies the default SQL schema for all table names referenced in the XML schema that are not explicitly qualified using the db2-xdb:table annotation.

<db2-xdb:defaultSQLSchema> belongs to the set of decomposition annotations that can be added to an XML schema document to describe the mappings between elements and attributes of XML documents to DB2 base tables. The decomposition process uses the annotated XML schema to determine how elements and attributes of an XML document should be decomposed into DB2 tables.

### Annotation type

Child element of <xs:appinfo> that is a child of a global <xs:annotation> element.

### How to specify

db2-xdb:defaultSQLSchema is specified in the following way (where *value* represents a valid value for the annotation):

```
<xs:schema>
  <xs:annotation>
    <xs:appinfo>
      <db2-xdb:defaultSQLSchema>value</db2-xdb:defaultSQLSchema>
    </xs:appinfo>
  </xs:annotation>
  ...
</xs:schema>
```

### Namespace

http://www.ibm.com/xmlns/prod/db2/xdB1

### Valid values

Either an ordinary or delimited SQL schema name. Ordinary, or undelimited, SQL schema names are case-insensitive. To specify a delimited SQL schema, use quotation marks that are normally used to delimit SQL identifiers. SQL schema names that contain the special characters '<' and '&' must be escaped in the XML schema document.

### Details

All tables referenced in annotated schemas must be qualified with their SQL schema. Tables can be qualified in two ways, either by explicitly specifying the <db2-xdb:SQLSchema> child element of the <db2-xdb:table> annotation or by using the <db2-xdb:defaultSQLSchema> global annotation. For any unqualified

table name, the value specified in `<db2-xdb:defaultSQLSchema>` is used as its SQL schema name. If multiple schema documents in an annotated schema specify this annotation, all values must be the same.

## Example

The following example shows how the ordinary, or undelimited, SQL identifier `admin` is defined as the SQL schema for all unqualified tables in the annotated schema:

```
<xs:schema xmlns:xs="http://www.w3.org/2001/XMLSchema"
           xmlns:db2-xdb="http://www.ibm.com/xmlns/prod/db2/xdb1">
  <xs:annotation>
    <xs:appinfo>
      <db2-xdb:defaultSQLSchema>admin</db2-xdb:defaultSQLSchema>
    </xs:appinfo>
  </xs:annotation>
  ...
</xs:schema>
```

The following example shows how the delimited SQL identifier `admin schema` is defined as the SQL schema for all unqualified tables in the annotated schema. Note that `admin schema` must be delimited with quotation marks:

```
<xs:schema xmlns:xs="http://www.w3.org/2001/XMLSchema"
           xmlns:db2-xdb="http://www.ibm.com/xmlns/prod/db2/xdb1">
  <xs:annotation>
    <xs:appinfo>
      <db2-xdb:defaultSQLSchema>"admin schema"</db2-xdb:defaultSQLSchema>
    </xs:appinfo>
  </xs:annotation>
  ...
</xs:schema>
```

## db2-xdb:rowSet decomposition annotation

The `db2-xdb:rowSet` annotation specifies an XML element or attribute mapping to a target base table.

`db2-xdb:rowSet` belongs to the set of decomposition annotations that can be added to an XML schema document to describe the mappings between elements and attributes of XML documents to DB2 base tables. The decomposition process uses the annotated XML schema to determine how elements and attributes of an XML document should be decomposed into DB2 tables.

### Annotation type

Attribute of `<xs:element>` or `<xs:attribute>`, or child element of `<db2-xdb:rowSetMapping>` or `<db2-xdb:order>`

### How to specify

`db2-xdb:rowSet` is specified in any of the following ways (where *value* represents a valid value for the annotation):

- `<xs:element db2-xdb:rowSet="value" />`
- `<xs:attribute db2-xdb:rowSet="value" />`
- `<db2-xdb:rowSetMapping>`  
  `<db2-xdb:rowSet>value</db2-xdb:rowSet>`  
  ...  
  `</db2-xdb:rowSetMapping>`

- `<db2-xdb:order>`  
`<db2-xdb:rowSet>value</db2-xdb:rowSet>`  
`...`  
`</db2-xdb:order>`

## Namespace

<http://www.ibm.com/xmlns/prod/db2/xdb1>

## Valid values

Any identifier that adheres to the rules for SQL identifiers. Refer to the identifiers documentation for more information.

## Details

The `db2-xdb:rowSet` annotation maps an XML element or attribute to a target base table. This annotation can either identify a table name directly, or identify a `rowSet` name in more complex mappings, where the `rowSet` is then associated with a table name through the `db2-xdb:table` annotation. In simple mappings, this annotation specifies the name of the table the value is to be decomposed into. In more complex mappings, where multiple `rowSets` (each with a distinct name) map to the same table, then this annotation names the `rowSet`, rather than the table name.

The target base table into which this XML element's or attribute's value will be decomposed is determined by the presence of other annotations in the set of schema documents that form the annotated schema:

- If the value of `db2-xdb:rowSet` does not match any of the `<db2-xdb:rowSet>` children elements of the `<db2-xdb:table>` global annotation, then the name of the target table is the value specified by this annotation, qualified by an SQL schema defined by the `<db2-xdb:defaultSQLSchema>` global annotation. This usage of `db2-xdb:rowSet` is for the case in which, for a particular table, there is only one set of elements or attributes that maps to the table.
- If the value of `db2-xdb:rowSet` matches a `<db2-xdb:rowSet>` child element of the `<db2-xdb:table>` global annotation, then the name of the target table is the table named in the `<db2-xdb:name>` child of `<db2-xdb:table>`. This usage of `db2-xdb:rowSet` is for the more complex case in which, for a particular table, there are multiple (possibly overlapping) sets of elements or attributes that map to that table.

**Important:** Ensure that the table that this annotation refers to exists in the database when the XML schema is registered with the XML schema repository. (The columns specified in the `db2-xdb:column` annotations must also exist when registering the XML schema.) If the table does not exist, then an error is returned when the XML schema is enabled for decomposition. If `<db2-xdb:table>` specifies an object other than a table, then an error is returned as well.

When the `db2-xdb:rowSet` annotation is used, either the `db2-xdb:column` annotation or the `db2-xdb:condition` annotation must be specified. The combination of `db2-xdb:rowSet` and `db2-xdb:column` describe the table and column to which this element or attribute will be decomposed into. The combination of `db2-xdb:rowSet` and `db2-xdb:condition` specifies the condition that must be true for any rows of that `rowSet` to be inserted into the table (referred to either directly, or indirectly through the `<db2-xdb:table>` annotation).

## Example

The two ways of using `db2-xdb:rowSet` listed previously, are demonstrated next.

## Single set of elements or attributes mapped to a table

Assume for the following section of an annotated schema that the `BOOKCONTENTS` table belongs to the SQL schema specified by `<db2-xdb:defaultSQLSchema>`, and that there is no global `<db2-xdb:table>` element present which has a `<db2-xdb:rowSet>` child element that matches "BOOKCONTENTS".

```
<xs:element name="book">
  <xs:complexType>
    <xs:sequence>
      <xs:element name="authorID" type="xs:integer" />
      <xs:element name="chapter" type="chapterType" maxOccurs="unbounded" />
    </xs:sequence>
    <xs:attribute name="isbn" type="xs:string"
      db2-xdb:rowSet="BOOKCONTENTS" db2-xdb:column="ISBN" />
    <xs:attribute name="title" type="xs:string" />
  </xs:complexType>
</xs:element>

<xs:complexType name="chapterType">
  <xs:sequence>
    <xs:element name="paragraph" type="paragraphType" maxOccurs="unbounded"
      db2-xdb:rowSet="BOOKCONTENTS" db2-xdb:column="CHPTCONTENT" />
  </xs:sequence>
  <xs:attribute name="number" type="xs:integer"
    db2-xdb:rowSet="BOOKCONTENTS" db2-xdb:column="CHPTNUM" />
  <xs:attribute name="title" type="xs:string"
    db2-xdb:rowSet="BOOKCONTENTS" db2-xdb:column="CHPTTITLE" />
</xs:complexType>

<xs:simpleType name="paragraphType">
  <xs:restriction base="xs:string"/>
</xs:simpleType>
```

Consider the following element from an XML document:

```
<book isbn="1-11-111111-1" title="My First XML Book">
  <authorID>22</authorID>
  <!-- this book does not have a preface -->
  <chapter number="1" title="Introduction to XML">
    <paragraph>XML is fun...</paragraph>
    ...
  </chapter>
  <chapter number="2" title="XML and Databases">
    <paragraph>XML can be used with...</paragraph>
  </chapter>
  ...
  <chapter number="10" title="Further Reading">
    <paragraph>Recommended tutorials...</paragraph>
  </chapter>
  ...
</book>
```

The `BOOKCONTENTS` table is then populated as follows:

Table 45. *BOOKCONTENTS*

ISBN	CHPTNUM	CHPTTITLE	CHPTCONTENT
1-11-111111-1	1	Introduction to XML	XML is fun...
1-11-111111-1	2	XML and Databases	XML can be used with...

Table 45. BOOKCONTENTS (continued)

ISBN	CHPTNUM	CHPTTITLE	CHPTCONTENT
...	...	...	...
1-11-111111-1	10	Further Reading	Recommended tutorials...

## Multiple sets of elements or attributes mapped to the same table

For the case where there exists a <db2-xdb:rowSet> child element of the <db2-xdb:table> global annotation that matches the value specified in the db2-xdb:rowSet annotation, the element or attribute is mapped to a table through the <db2-xdb:table> annotation. Assume for the following section of an annotated schema that the ALLBOOKS table belongs to the SQL schema specified by <db2-xdb:defaultSQLSchema>.

```
<!-- global annotation -->
<xs:annotation>
  <xs:appinfo>
    <db2-xdb:table>
      <db2-xdb:name>ALLBOOKS</db2-xdb:name>
      <db2-xdb:rowSet>book</db2-xdb:rowSet>
      <db2-xdb:rowSet>textbook</db2-xdb:rowSet>
    </db2-xdb:table>
  </xs:appinfo>
</xs:annotation>

<xs:element name="book">
  <xs:complexType>
    <xs:sequence>
      <xs:element name="authorID" type="xs:integer"
        db2-xdb:rowSet="book" db2-xdb:column="AUTHORID" />
      <xs:element name="chapter" type="chapterType" maxOccurs="unbounded" />
    </xs:sequence>
    <xs:attribute name="isbn" type="xs:string"
      db2-xdb:rowSet="book" db2-xdb:column="ISBN" />
    <xs:attribute name="title" type="xs:string"
      db2-xdb:rowSet="book" db2-xdb:column="TITLE" />
  </xs:complexType>
</xs:element>
<xs:element name="textbook">
  <xs:complexType>
    <xs:sequence>
      <xs:element name="isbn" type="xs:string"
        db2-xdb:rowSet="textbook" db2-xdb:column="ISBN" />
      <xs:element name="title" type="xs:string"
        db2-xdb:rowSet="textbook" db2-xdb:column="TITLE" />
      <xs:element name="primaryauthorID" type="xs:integer"
        db2-xdb:rowSet="textbook" db2-xdb:column="AUTHORID" />
      <xs:element name="coauthorID" type="xs:integer"
        minOccurs="0" maxOccurs="unbounded" />
      <xs:element name="subject" type="xs:string" />
      <xs:element name="edition" type="xs:integer" />
      <xs:element name="chapter" type="chapterType" maxOccurs="unbounded" />
    </xs:sequence>
  </xs:complexType>
</xs:element>

<xs:complexType name="chapterType">
  <xs:sequence>
    <xs:element name="paragraph" type="paragraphType" maxOccurs="unbounded" />
  </xs:sequence>
  <xs:attribute name="number" type="xs:integer" />
  <xs:attribute name="title" type="xs:string" />
</xs:complexType>
```

```

</xs:complexType>

<xs:simpleType name="paragraphType">
  <xs:restriction base="xs:string"/>
</xs:simpleType>

```

Consider the following elements from an XML document:

```

<book isbn="1-11-11111-1" title="My First XML Book">
  <authorID>22</authorID>
  <!-- this book does not have a preface -->
  <chapter number="1" title="Introduction to XML">
    <paragraph>XML is fun...</paragraph>
  </chapter>
  <chapter number="2" title="XML and Databases">
    <paragraph>XML can be used with...</paragraph>
  </chapter>
  <chapter number="10" title="Further Reading">
    <paragraph>Recommended tutorials...</paragraph>
  </chapter>
</book>

<textbook>
  <isbn>0-11-011111-0</isbn>
  <title>Programming with XML</title>
  <primaryauthorID>435</primaryauthorID>
  <subject>Programming</subject>
  <edition>4</edition>
  <chapter number="1" title="Programming Basics">
    <paragraph>Before you being programming...</paragraph>
  </chapter>
  <chapter number="2" title="Writing a Program">
    <paragraph>Now that you have learned the basics...</paragraph>
  </chapter>
  ...
  <chapter number="10" title="Advanced techniques">
    <paragraph>You can apply advanced techniques...</paragraph>
  </chapter>
</textbook>

```

In this example, there are two sets of elements or attributes that map to the table ALLBOOKS:

- /book/@isbn, /book/@authorID, /book/title
- /textbook/isbn, /textbook/primaryauthorID, /textbook/title

The sets are distinguished by associating different rowSet names to each.

Table 46. ALLBOOKS

ISBN	TITLE	AUTHORID
1-11-11111-1	My First XML Book	22
0-11-011111-0	Programming with XML	435

## db2-xdb:table decomposition annotation

The <db2-xdb:table> annotation maps multiple XML elements or attributes to the same target column; or enables you to specify a target table that has an SQL schema different from the default SQL schema specified by <db2-xdb:defaultSQLSchema>.

<db2-xdb:table> belongs to the set of decomposition annotations that can be added to an XML schema document to describe the mappings between elements and attributes of XML documents to DB2 base tables. The decomposition process uses

the annotated XML schema to determine how elements and attributes of an XML document should be decomposed into DB2 tables.

## Annotation type

Global child element of <xs:appinfo> (which is a child element of <xs:annotation>)

## Namespace

<http://www.ibm.com/xmlns/prod/db2/xdb1>

## Valid structure

The following are supported children elements of <db2-xdb:table>, listed in the order in which they must appear if they are specified:

### <db2-xdb:SQLSchema>

(Optional) The SQL schema of the table.

### <db2-xdb:name>

The name of the base table. This table name, when qualified with the value of either the preceding <db2-xdb:SQLSchema> annotation or the <db2-xdb:defaultSQLSchema> annotation, must be unique among all <db2-xdb:table> annotations across the set of XML schema documents that form the annotated schema.

### <db2-xdb:rowSet>

All elements and attributes that specify the same value for <db2-xdb:rowSet> form a row. Because more than one <db2-xdb:rowSet> element can be specified for the same value of <db2-xdb:name>, more than one set of mappings can be associated with a single table. The combination of the <db2-xdb:rowSet> value with the columns specified in the <db2-xdb:column> annotation allows more than one set of elements or attributes from a single XML document to be mapped to columns of the same table.

At least one <db2-xdb:rowSet> element must be specified, and each <db2-xdb:rowSet> element must be unique among all <db2-xdb:table> annotations across the set of XML schema documents that form the annotated schema, for the annotation to be valid.

Whitespace within the character content of the children elements of <db2-xdb:table> is significant and not normalized. Content of these elements must follow the spelling rules for SQL identifiers. Undelimited values are case-insensitive; for delimited values, quotation marks are used as the delimiter. SQL identifiers that contain the special characters '<' and '&', must be escaped.

## Details

The <db2-xdb:table> annotation must be used in either of the following cases:

- when multiple ancestry lines are mapped to the same column of a table (mappings involving single location paths, meaning that there is only one set of column mappings for the table, do not need to use this annotation; the <db2-xdb:rowSet> annotation can be used instead)
- when the table that is to hold the decomposed data is not of the same SQL schema as is defined by the <db2-xdb:defaultSQLSchema> annotation.

Only base tables can be specified; other types of tables, such as typed, summary, temporary, or materialized query tables, are not supported for this mapping. Nicknames can be specified for DB2 Database for Linux, UNIX, and Windows data source objects only. Views and table aliases are not currently permitted for this annotation.

## Example

The following example shows how the `<db2-xdb:table>` annotation can be used to group related elements and attributes together to form a row, when multiple location paths are being mapped to the same column. Consider first the following elements from an XML document (modified slightly from examples used for other annotations).

```
<root>
  ...
  <book isbn="1-11-111111-1" title="My First XML Book">
    <authorID>22</authorID>
    <email>author22@anyemail.com</email>
    <!-- this book does not have a preface -->
    <chapter number="1" title="Introduction to XML">
      <paragraph>XML is fun...</paragraph>
      ...
    </chapter>
    <chapter number="2" title="XML and Databases">
      <paragraph>XML can be used with...</paragraph>
    </chapter>
    ...
    <chapter number="10" title="Further Reading">
      <paragraph>Recommended tutorials...</paragraph>
    </chapter>
  </book>
  ...
  <author ID="0800" email="author800@email.com">
    <firstname>Alexander</firstname>
    <lastname>Smith</lastname>
    <activeStatus>0</activeStatus>
  </author>
  ...
</root>
```

Assume that the purpose of this decomposition mapping is to insert rows that consist of author IDs and their corresponding email addresses into the same table, AUTHORSCONTACT. Notice that author IDs and email addresses appear in both the `<book>` element and the `<author>` element. Thus, more than one location path will need to be mapped to the same columns of the same table. The `<db2-xdb:table>` annotation, therefore, must be used. A section from the annotated schema is presented next, showing how `<db2-xdb:table>` is used to associate multiple paths to the same table.

```
<!-- global annotation -->
<xs:annotation>
  <xs:appinfo>
    <db2-xdb:defaultSQLSchema>adminSchema</db2-xdb:defaultSQLSchema>
    <db2-xdb:table>
      <db2-xdb:SQLSchema>user1</db2-xdb:SQLSchema>
      <db2-xdb:name>AUTHORSCONTACT</db2-xdb:name>
      <db2-xdb:rowSet>bookRowSet</db2-xdb:rowSet>
      <db2-xdb:rowSet>authorRowSet</db2-xdb:rowSet>
    </db2-xdb:table>
  </xs:appinfo>
</xs:annotation>

<xs:element name="book">
```



```

<xs:complexType>
  <xs:sequence>
    <xs:element name="authorID" type="xs:integer"
      db2-xdb:rowSet="bookRowSet" db2-xdb:column="AUTHID" />
    <xs:element name="email" type="xs:string"
      db2-xdb:rowSet="bookRowSet" db2-xdb:column="EMAILADDR" />
    <xs:element name="chapter" type="chapterType" maxOccurs="unbounded" />
  </xs:sequence>
  <xs:attribute name="isbn" type="xs:string" />
  <xs:attribute name="title" type="xs:string" />
</xs:complexType>
</xs:element>

<xs:element name="author">
  <xs:complexType>
    <xs:sequence>
      <xs:element name="firstname" type="xs:string" />
      <xs:element name="lastname" type="xs:string" />
      <xs:element name="activeStatus" type="xs:boolean" />
    </xs:sequence>
    <xs:attribute name="ID" type="xs:integer"
      db2-xdb:rowSet="authorRowSet" db2-xdb:column="AUTHID" />
    <xs:attribute name="email" type="xs:string"
      db2-xdb:rowSet="authorRowSet" db2-xdb:column="EMAILADDR" />
  </xs:complexType>
</xs:element>

```

The `<db2-xdb:table>` annotation identifies the name of the target table for a mapping with the `db2-xdb:name` child element. In this example, `AUTHORSCONTACT` is the target table. To ensure that the ID and email addresses from the `<book>` element are kept separate from those of the `<author>` element (that is, each row contains logically related values), the `<db2-xdb:rowSet>` element is used to associate related items. Even though in this example, the `<book>` and `<author>` elements are separate entities, there can be cases where the entities to be mapped are not separate and require a logical separation, which can be achieved through the use of rowSets.

Note that the `AUTHORSCONTACT` table exists in an SQL schema different from the default SQL schema, and the `<db2-xdb:SQLSchema>` element is used to specify this. The resulting `AUTHORSCONTACT` table is shown in Table 1:

Table 47. *AUTHORSCONTACT*

AUTHID	EMAILADDR
22	author22@anyemail.com
0800	author800@email.com

This example illustrates how the logical grouping of values through rowSets ensure that unrelated values are not unintentionally mapped to the same table and column pair. In this example, `/root/book/authorID` and `/root/author/@ID` are mapped to the same table and column pair. Similarly, `/root/book/email` and `/root/author/@email` are mapped to the same table and column pair. Consider the case if rowSets were not available. If, for example, the `/root/book/email` element was not present in an instance of the `<author>` element and rowSets could not be used, then it would not be possible to determine if the email from the `<author>` element should be associated with `/root/book/authorID` or `/root/author/@ID` or both. Thus the rowSets associated with a single table in the `<db2-xdb:table>` annotation helps logically distinguish among different sets of rows.

## db2-xdb:column decomposition annotation

The db2-xdb:column annotation specifies a column name of the table to which an XML element or attribute has been mapped.

db2-xdb:column belongs to the set of decomposition annotations that can be added to an XML schema document to describe the mappings between elements and attributes of XML documents to DB2 base tables. The decomposition process uses the annotated XML schema to determine how elements and attributes of an XML document should be decomposed into DB2 tables.

### Annotation type

Attribute of <xs:element> or <xs:attribute>, or child element of <db2-xdb:rowSetMapping>

### How to specify

db2-xdb:column is specified in any of the following ways (where *value* represents a valid value for the annotation):

- <xs:element db2-xdb:rowSet="*value*" db2-xdb:column="*value*" />
- <xs:attribute db2-xdb:rowSet="*value*" db2-xdb:column="*value*" />
- 

```
<db2-xdb:rowSetMapping>
  <db2-xdb:rowSet>value</db2-xdb:rowSet>
  <db2-xdb:column>value</db2-xdb:column>
  ...
</db2-xdb:rowSetMapping>
```

### Namespace

<http://www.ibm.com/xmlns/prod/db2/xdb1>

### Valid values

Any base table column name that adheres to the following:

- Undelimited column names are case-insensitive. For delimited column names, escape the delimiter with &quot;. For example, to specify a two word column name, "col one", db2-xdb:column would be set as follows:  
db2-xdb:column="&quot;col one&quot;";

(Note that these conditions are requirements specific to this annotation.)

- Only columns of the following data types can be specified in this annotation: all data types supported by the CREATE TABLE SQL statement, except user-defined structured types.

### Details

The db2-xdb:column annotation, specified as an attribute in the declaration of an XML element or attribute, or as a child element of <db2-xdb:rowSetMapping>, maps an XML element or attribute to the column name of a target table. When this annotation is used, the db2-xdb:rowSet annotation must be specified as well. Together they describe the table and column that will hold the decomposed value for this element or attribute.

## Example

The following example shows how content from the <book> element can be inserted into columns of a table called BOOKCONTENTS, using the db2-xdb:column annotation. A section of the annotated schema is presented first.

```
<xs:element name="book">
  <xs:complexType>
    <xs:sequence>
      <xs:element name="authorID" type="xs:integer" />
      <xs:element name="chapter" type="chapterType" maxOccurs="unbounded" />
    </xs:sequence>
    <xs:attribute name="isbn" type="xs:string"
      db2-xdb:rowSet="BOOKCONTENTS" db2-xdb:column="ISBN" />
    <xs:attribute name="title" type="xs:string" />
  </xs:complexType>
</xs:element>

<xs:complexType name="chapterType">
  <xs:sequence>
    <xs:element name="paragraph" type="paragraphType" maxOccurs="unbounded"
      db2-xdb:rowSet="BOOKCONTENTS"
      db2-xdb:column="CHPTCONTENT" />
  </xs:sequence>
  <xs:attribute name="number" type="xs:integer"
    db2-xdb:rowSet="BOOKCONTENTS"
    db2-xdb:column="CHPTNUM" />
  <xs:attribute name="title" type="xs:string"
    db2-xdb:rowSet="BOOKCONTENTS"
    db2-xdb:column="CHPTTITLE" />
</xs:complexType>

<xs:simpleType name="paragraphType">
  <xs:restriction base="xs:string"/>
</xs:simpleType>
```

The <book> element that is being mapped is presented next, followed by the resulting BOOKCONTENTS table after the decomposition has completed. .

```
<book isbn="1-11-111111-1" title="My First XML Book">
  <authorID>22</authorID>
  <!-- this book does not have a preface -->
  <chapter number="1" title="Introduction to XML">
    <paragraph>XML is fun...</paragraph>
    ...
  </chapter>
  <chapter number="2" title="XML and Databases">
    <paragraph>XML can be used with...</paragraph>
  </chapter>
  ...
  <chapter number="10" title="Further Reading">
    <paragraph>Recommended tutorials...</paragraph>
  </chapter>
</book>
```

Table 48. BOOKCONTENTS

ISBN	CHPTNUM	CHPTTITLE	CHPTCONTENT
1-11-111111-1	1	Introduction to XML	XML is fun...
1-11-111111-1	2	XML and Databases	XML can be used with...
...	...	...	...
1-11-111111-1	10	Further Reading	Recommended tutorials...

## db2-xdb:locationPath decomposition annotation

The db2-xdb:locationPath annotation maps an XML element or attribute globally declared or as part of a reusable group, to different table and column pairs, depending on the ancestry of the element or attribute. Reusable groups are globally declared named complex types, named model groups, and named attribute groups.

db2-xdb:locationPath belongs to the set of decomposition annotations that can be added to an XML schema document to describe the mappings between elements and attributes of XML documents to DB2 base tables. The decomposition process uses the annotated XML schema to determine how elements and attributes of an XML document should be decomposed into DB2 tables.

### Annotation type

Attribute of <xs:element> or <xs:attribute>, or attribute of <db2-xdb:rowSetMapping>

### How to specify

db2-xdb:locationPath is specified in any of the following ways (where *value* represents a valid value for the annotation):

- <xs:element db2-xdb:locationPath="value" />
- <xs:attribute db2-xdb:locationPath="value" />
- ```
<db2-xdb:rowSetMapping db2-xdb:locationPath="value">  
  <db2-xdb:rowSet>value</db2-xdb:rowSet>  
  ...  
</db2-xdb:rowSetMapping>
```

### Namespace

<http://www.ibm.com/xmlns/prod/db2/xdb1>

### Valid values

The value of db2-xdb:locationPath must have the following syntax:

```
location path := '/' (locationstep '/')* lastlocationstep  
locationstep := (prefix:)? name  
lastlocationstep := locationstep | '@' (prefix:)? name
```

where name is an element or attribute name, and prefix is a namespace prefix.

### Notes:

- All namespace prefixes used in the location path must have been associated with a namespace in the schema document that contains the annotation specifying this location path.
- A namespace prefix binding can be created by adding a namespace declaration to the <xs:schema> element of the schema document.
- If prefix is empty, then name is assumed to be in no namespace. If a default namespace is declared in the schema document, and a name in locationstep belongs to that namespace, a namespace prefix must be declared for the default namespace and used to qualify the name; in db2-xdb:locationPath, an empty prefix does not refer to the default namespace.

## Details

The `db2-xdb:locationPath` annotation is used to describe the mappings for elements or attributes that are either declared globally or as part of either a:

- named model group
- named attribute group
- global complex type declaration
- global element or attribute of simple or complex type

For element or attribute declarations that cannot be reused (local declarations that are not part of named complex type definitions or named model or attribute groups), the `db2-xdb:locationPath` annotation has no effect.

`db2-xdb:locationPath` should be used when global element or attribute declarations are used as references from various ancestry lines. (for example: `<xs:element ref="abc">`). Because annotations cannot be specified directly on references, they must instead be specified on the corresponding global element or attribute declaration. Because the corresponding element or attribute declaration is global, the element or attribute can be referenced from many different contexts within the XML schema. In general, `db2-xdb:locationPath` should be used to distinguish the mappings in these different contexts. For named complex types, model groups, and attribute groups, the element and attribute declarations should be annotated for each context in which they are mapped for decomposition. The `db2-xdb:locationPath` annotation should be used to specify the target rowSet and column pair for each `locationPath`. The same `db2-xdb:locationPath` value can be used for different rowSet and column pairs.

## Example

The following example shows how the same attribute can be mapped to different tables depending on the context in which this attribute appears. A section of the annotated schema is presented first.

```
<!-- global attribute -->
<xs:attribute name="title" type="xs:string"
  db2-xdb:rowSet="BOOKS"
  db2-xdb:column="TITLE"
  db2-xdb:locationPath="/books/book/@title">
  <xs:annotation>
    <xs:appinfo>
      <db2-xdb:rowSetMapping db2-xdb:locationPath="/books/book/chapter/@title">
        <db2-xdb:rowSet>BOOKCONTENTS</db2-xdb:rowSet>
        <db2-xdb:column>CHPTITLE</db2-xdb:column>
      </db2-xdb:rowSetMapping>
    </xs:appinfo>
  </xs:annotation>
</xs:attribute>

<xs:element name="books">
  <xs:complexType>
    <xs:sequence>
      <xs:element name="book">
        <xs:complexType>
          <xs:sequence>
            <xs:element name="authorID" type="xs:integer" />
            <xs:element name="chapter" type="chapterType" maxOccurs="unbounded" />
          </xs:sequence>
          <xs:attribute name="isbn" type="xs:string" />
          <xs:attribute ref="title" />
        </xs:complexType>
      </xs:element>
    </xs:sequence>
  </xs:complexType>
</xs:element>
```

```

        </xs:element>
    </xs:sequence>
</xs:complexType>
</xs:element>

<xs:complexType name="chapterType">
    <xs:sequence>
        <xs:element name="paragraph" type="paragraphType" maxOccurs="unbounded" />
    </xs:sequence>
    <xs:attribute name="number" type="xs:integer" />
    <xs:attribute ref="title" />
</xs:complexType>

<xs:simpleType name="paragraphType">
    <xs:restriction base="xs:string"/>
</xs:simpleType>

```

Note that there is only one attribute declaration named "title", but there are two references to this attribute in different contexts. One reference is from the <book> element, and the other is from the <chapter> element. The value of the "title" attribute needs to be decomposed into different tables depending on the context. This annotated schema specifies that a "title" value is decomposed into the BOOKS table if it is a book title and into the BOOKCONTENTS table if it is a chapter title.

The <books> element that is being mapped is presented next, followed by the resulting BOOKS table after the decomposition has completed.

```

<books>
  <book isbn="1-11-111111-1" title="My First XML Book">
    <authorID>22</authorID>
    <!-- this book does not have a preface -->
    <chapter number="1" title="Introduction to XML">
      <paragraph>XML is fun...</paragraph>
      ...
    </chapter>
    <chapter number="2" title="XML and Databases">
      <paragraph>XML can be used with...</paragraph>
    </chapter>
    ...
    <chapter number="10" title="Further Reading">
      <paragraph>Recommended tutorials...</paragraph>
    </chapter>
  </book>
  ...
</books>

```

Table 49. BOOKS

| ISBN | TITLE             | CONTENT |
|------|-------------------|---------|
| NULL | My First XML Book | NULL    |

Table 50. BOOKCONTENTS

| ISBN | CHPTNUM | CHPTTITLE           | CHPTCONTENT |
|------|---------|---------------------|-------------|
| NULL | NULL    | Introduction to XML | NULL        |
| NULL | NULL    | XML and Databases   | NULL        |
| ...  | ...     | ...                 | ...         |
| NULL | NULL    | Further Reading     | NULL        |

## db2-xdb:expression decomposition annotation

The db2-xdb:expression annotation specifies a customized expression, the result of which is inserted into the table this element is mapped to.

db2-xdb:expression belongs to the set of decomposition annotations that can be added to an XML schema document to describe the mappings between elements and attributes of XML documents to DB2 base tables. The decomposition process uses the annotated XML schema to determine how elements and attributes of an XML document should be decomposed into DB2 tables.

### Annotation type

Attribute of <xs:element> or <xs:attribute>, or optional child element of <db2-xdb:rowSetMapping>, effective only on annotations that include a column mapping

### How to specify

db2-xdb:expression is specified in any of the following ways (where *value* represents a valid value for the annotation):

- <xs:element db2-xdb:expression="*value*" db2-xdb:column="*value*" />
- <xs:attribute db2-xdb:expression="*value*" db2-xdb:column="*value*" />
- 

```
<db2-xdb:rowSetMapping>
  <db2-xdb:rowSet>value</db2-xdb:rowSet>
  <db2-xdb:column>value</db2-xdb:column>
  <db2-xdb:expression>value</db2-xdb:expression>
  ...
</db2-xdb:rowSetMapping>
```

### Namespace

<http://www.ibm.com/xmlns/prod/db2/xdb1>

### Valid values

The value of db2-xdb:expression must have the following syntax, which constitutes a subset of SQL expressions:

```
expression := function (arglist) | constant | $DECOMP_CONTENT | $DECOMP_ELEMENTID |
             $DECOMP_DOCUMENTID | (scalar-fullselect) | expression operator expression |
             (expression) | special-register | CAST (expression AS data-type) |
             XMLCAST (expression AS data-type) | XML-function
```

```
operator := + | - | * | / | CONCAT
```

```
arglist := expression | arglist, expression
```

### Details

The db2-xdb:expression annotation enables you to specify a customized expression, which is applied to the content of the XML element or attribute being annotated when \$DECOMP\_CONTENT is used. The result of evaluating this expression is then inserted into the column specified during decomposition.

This annotation is also useful in cases where you want to insert constant values (such as the name of an element), or generated values that do not appear in the document.

`db2-xdb:expression` must be specified using valid SQL expressions, and the type of the evaluated expression must be statically determinable and compatible with the type of the target column that the value is to be inserted into. The following subset of SQL expressions are supported; any other SQL expressions not described in the following list, are unsupported and have an undefined behavior in the context of this annotation.

**function (arglist)**

A built-in or user-defined scalar SQL function. The arguments of a scalar function are individual scalar values. A scalar function returns a single value (possibly null). Refer to the documentation on functions for more information.

**constant**

A value, sometimes called a literal, that is a string constant or a numeric constant. Refer to the documentation on constants for more information.

**\$DECOMP\_CONTENT**

The value of the mapped XML element or attribute from the document, constructed according to the setting of the `db2-xdb:contentHandling` annotation. Refer to the decomposition keywords documentation for more information.

**\$DECOMP\_ELEMENTID**

A system-generated integer identifier that uniquely identifies within the XML document, the element or attribute this annotation describes. Refer to the decomposition keywords documentation for more information.

**\$DECOMP\_DOCUMENTID**

The string value specified in the *documentid* input parameter of the `xdbDecompXML` stored procedure, which identifies the XML document being decomposed. Refer to the decomposition keywords documentation for more information.

**(scalar-fullselect)**

A fullselect, enclosed in parentheses, that returns a single row consisting of a single column value. If the fullselect does not return a row, the result of the expression is the NULL value.

**expression operator expression**

The result of two supported expression operands, as defined previously in the supported values listing. Refer to the documentation on expressions for details on expression operations.

**(expression)**

An expression enclosed in parentheses that conforms to the list of supported expressions defined previously.

**special-register**

The name of a supported special register. This setting evaluates to the value of the special register for the current server. Refer to the documentation for special registers for a complete listing of supported special registers.

**CAST (expression AS data-type)**

The expression cast to the specified SQL data type, if the expression is not NULL. If the expression is NULL, the result is a null value of the SQL data



type specified. When inserting a NULL value into a column, the expression must cast NULL into a compatible column type (for example: CAST (NULL AS INTEGER), for an integer column).

### XMLCAST (expression AS data-type)

The expression cast to the specified data type, if the expression is not NULL. The expression or the target data type must be the XML type. If the expression is NULL, the target type must be XML, and the result is a null XML value.

### XML-function

Any supported SQL/XML function.

## Example

The following example shows how the db2-xdb:expression annotation can be used to apply a value from the XML document to a user-defined function. The result returned from the UDF is then inserted into the database, rather than the value from the document itself. A section of the annotated schema is presented first.

```
<xs:element name="author">
  <xs:complexType>
    <xs:sequence>
      <xs:element name="firstname" type="xs:string" />
      <xs:element name="lastname" type="xs:string" />
      <xs:element name="activeStatus" type="xs:boolean" />
      <xs:attribute name="ID" type="xs:integer"
        db2-xdb:rowSet="AUTHORS" db2-xdb:column="NUMBOOKS"
        db2-xdb:expression="AuthNumBooks (INTEGER ($DECOMP_CONTENT))" />
    </xs:sequence>
  </xs:complexType>
</xs:element>
```

Assume that there is a user-defined function called AuthNumBooks that takes an integer parameter, which represents the author's ID, and returns the total number of books that author has in the system.

The <author> element that is being mapped is presented next.

```
<author ID="22">
  <firstname>Ann</firstname>
  <lastname>Brown</lastname>
  <activeStatus>1</activeStatus>
</author>
```

\$DECOMP\_CONTENT is replaced with the value "22" from the instance of the ID attribute. Because \$DECOMP\_CONTENT is always substituted with a character type, and because the AuthNumBooks UDF takes an integer parameter, the db2-xdb:expression annotation must cast \$DECOMP\_CONTENT to an integer. Assume that the UDF returns the integer 8 for this author whose ID is 22; 8 is then inserted into the NUMBOOKS column of the AUTHORS table, as shown next.

Table 51. AUTHORS

AUTHID	FIRSTNAME	SURNAME	ACTIVE	NUMBOOKS
NULL	NULL	NULL	NULL	8

## db2-xdb:condition decomposition annotation

The db2-xdb:condition annotation specifies a condition that determines if a row will be inserted into a table. A row that satisfies the condition might be inserted (depending on other conditions for the rowSet, if any); a row that does not satisfy the condition will not be inserted.

db2-xdb:condition belongs to the set of decomposition annotations that can be added to an XML schema document to describe the mappings between elements and attributes of XML documents to DB2 base tables. The decomposition process uses the annotated XML schema to determine how elements and attributes of an XML document should be decomposed into DB2 tables.

### Annotation type

Attribute of <xs:element> or <xs:attribute>, or optional child element of <db2-xdb:rowSetMapping>. Condition is applied regardless of whether the annotation to which it belongs contains a column mapping.

### How to specify

db2-xdb:condition is specified in any of the following ways (where *value* represents a valid value for the annotation):

- <xs:element db2-xdb:condition="*value*" />
- <xs:attribute db2-xdb:condition="*value*" />
- <db2-xdb:rowSetMapping>  
  <db2-xdb:rowSet>*value*</db2-xdb:rowSet>  
  <db2-xdb:condition>*value*</db2-xdb:condition>  
  ...  
</db2-xdb:rowSetMapping>

### Namespace

<http://www.ibm.com/xmlns/prod/db2/xdb1>

### Valid values

SQL predicates of the following types: basic, quantified, BETWEEN, EXISTS, IN, IS VALIDATED, LIKE, NULL, and XMLEXISTS. The predicates must also consist of expressions that are supported by the db2-xdb:expression annotation, column names or both.

### Details

The db2-xdb:condition annotation enables you to specify conditions under which values are inserted into the database during decomposition. This annotation filters rows by applying user-specified conditions. The rows that satisfy the specified conditions are inserted into the database; rows that do not meet the conditions are not inserted during decomposition.

If the db2-xdb:condition annotation is specified on multiple element or attribute declarations of the same rowSet, then the row will be inserted only when the logical AND of all conditions evaluate to true.

## Column names in db2-xdb:condition

Because db2-xdb:condition consists of SQL predicates, column names can be specified in this annotation. If a db2-xdb:condition annotation involving a rowSet contains an unqualified column name, there must exist a mapping to that column among all of the mappings involving that rowSet. Other column names, when used in predicates containing SELECT statements, must be qualified. If db2-xdb:condition specifies an unqualified column name, but the element or attribute for which db2-xdb:condition is specified does not have a column mapping specified, then when the condition is evaluated, the value that is evaluated is the content of the element or attribute that maps to the referenced column name.

Consider the following example:

```
<xs:element name="a" type="xs:string"
  db2-xdb:rowSet="rowSetA" db2-xdb:condition="columnX='abc'" />
<xs:element name="b" type="xs:string"
  db2-xdb:rowSet="rowSetB" db2-xdb:column="columnX" />
```

Notice that <a> does not have a column mapping specified, but the condition references the column "columnX". When the condition is evaluated, "columnX" in the condition will be replaced with the value from <b>, because <b> has specified a column mapping for "columnX", while <a> does not have a column mapping. If the XML document contained:

```
<a>abc</a>
<b>def</b>
```

then the condition would evaluate to false in this case, because the value from <b>, "def", is evaluated in the condition.

If \$DECOMP\_CONTENT (a decomposition keyword that specifies the value of the mapped element or attribute as character data), instead of the column name, is used in the db2-xdb:condition attached to the element <a> declaration, then the condition is evaluated using the value of <a>, rather than <b>.

```
<xs:element name="a" type="xs:string"
  db2-xdb:rowSet="rowSetA" db2-xdb:condition="$DECOMP_CONTENT='abc'" />
<xs:element name="b" type="xs:string"
  db2-xdb:rowSet="rowSetB" db2-xdb:column="columnX" />
```

If the XML document contained:

```
<a>abc</a>
<b>def</b>
```

then the condition would evaluate to true in this case, because the value from <a>, "abc", is used in the evaluation.

This conditional processing, using column names and \$DECOMP\_CONTENT, can be useful in cases where you want to decompose only a value based on the value of another element or attribute that will not be inserted into the database.

## Conditions specified on mapped elements or attributes absent from the document

If a condition is specified on an element or attribute, but that element or attribute does not appear in the XML document, then the condition is still applied. For example, consider the following element mapping from an annotated schema document:

```
<xs:element name="intElem" type="xs:integer"
  db2-xdb:rowSet="rowSetA" db2-xdb:column="colInt"
  db2-xdb:condition="colInt > 100" default="0" />
```

If the `<intElem>` element does not appear in the XML document, the condition `"colInt > 100"` is still evaluated. Because `<intElem>` does not appear, a default value of 0 is used in the condition evaluation for `"colInt"`. The condition is then evaluated as: `0 > 100`, which evaluates to false. The corresponding row is therefore not inserted during decomposition.

## Example

Consider the following `<author>` element from an XML document:

```
<author ID="0800">
  <firstname>Alexander</firstname>
  <lastname>Smith</lastname>
  <activeStatus>1</activeStatus>
</author>
```

Depending on the conditions specified by `db2-xdb:condition`, the values from this `<author>` element might or might not be inserted into the target tables during decomposition. Two cases are presented next.

## All conditions satisfied

The following section from the annotated schema that corresponds to the `<author>` element discussed in the previous example, specifies that this element should only be decomposed if the author's ID falls between 1 and 999, the `<firstname>` and `<lastname>` elements are not NULL, and the value of the `<activeStatus>` element equals 1:

```
<xs:element name="author">
  <xs:complexType>
    <xs:sequence>
      <xs:element name="firstname" type="xs:string"
        db2-xdb:rowSet="AUTHORS" db2-xdb:column="GIVENNAME"
        db2-xdb:condition="$DECOMP_CONTENT IS NOT NULL" />
      <xs:element name="lastname" type="xs:string"
        db2-xdb:rowSet="AUTHORS" db2-xdb:column="SURNAME"
        db2-xdb:condition="$DECOMP_CONTENT IS NOT NULL" />
      <xs:element name="activeStatus" type="xs:integer"
        db2-xdb:rowSet="AUTHORS" db2-xdb:column="statusCode"
        db2-xdb:condition="$DECOMP_CONTENT=1" />
      <xs:attribute name="ID" type="xs:integer"
        db2-xdb:rowSet="AUTHORS" db2-xdb:column="AUTHID"
        db2-xdb:condition="$DECOMP_CONTENT BETWEEN 1 and 999" />
    </xs:sequence>
  </xs:complexType>
</xs:element>
```

Because all of the conditions specified by `db2-xdb:condition` are satisfied by the values in the `<author>` element example shown previously, the `AUTHORS` table is populated with the data from the `<author>` element.

Table 52. *AUTHORS*

AUTHID	GIVENNAME	SURNAME	STATUSCODE	NUMBOOKS
0800	Alexander	Smith	1	NULL

## One condition fails

The following annotated schema specifies that the <author> element should only be decomposed if the author's ID falls between 1 and 100, and the <firstname> and <lastname> elements are not NULL:

```
<xs:element name="author">
  <xs:complexType>
    <xs:sequence>
      <xs:element name="firstname" type="xs:string"
        db2-xdb:rowSet="AUTHORS" db2-xdb:column="GIVENNAME"
        db2-xdb:condition="$DECOMP_CONTENT IS NOT NULL"/>
      <xs:element name="lastname" type="xs:string"
        db2-xdb:rowSet="AUTHORS" db2-xdb:column="SURNAME"
        db2-xdb:condition="$DECOMP_CONTENT IS NOT NULL"/>
      <xs:element name="activeStatus" type="xs:integer" />
      <xs:attribute name="ID" type="xs:integer"
        db2-xdb:rowSet="AUTHORS" db2-xdb:column="AUTHID"
        db2-xdb:condition="$DECOMP_CONTENT BETWEEN 1 and 100" />
    </xs:sequence>
  </xs:complexType>
</xs:element>
```

Although the <firstname> and <lastname> elements of the example <author> element meet the conditions specified, the value of the ID attribute does not, and so the entire row is not inserted during decomposition. This is because the logical AND of all three conditions specified on the AUTHORS table is evaluated. In this case, one of the conditions is false, and so the logical AND evaluates to false, and therefore, no rows are inserted.

## db2-xdb:contentHandling decomposition annotation

The db2-xdb:contentHandling annotation specifies the type of content that will be decomposed into a table for an element of complex type or simple type.

db2-xdb:contentHandling belongs to the set of decomposition annotations that can be added to an XML schema document to describe the mappings between elements and attributes of XML documents to DB2 base tables. The decomposition process uses the annotated XML schema to determine how elements and attributes of an XML document should be decomposed into DB2 tables.

### Annotation type

Attribute of <xs:element>, or attribute of <db2-xdb:rowSetMapping>, that applies to complex type or simple type element declarations

### How to specify

db2-xdb:contentHandling is specified in any of the following ways (where *value* represents a valid value for the annotation):

- <xs:element db2-xdb:contentHandling="*value*" />
- <db2-xdb:rowSetMapping db2-xdb:contentHandling="*value*">  
 <db2-xdb:rowSet>*value*</db2-xdb:rowSet>  
 ...  
</db2-xdb:rowSetMapping>

### Namespace

<http://www.ibm.com/xmlns/prod/db2/xdB1>

## Valid values

One of the following case-sensitive tokens:

- text
- stringValue
- serializeSubtree

## Details

The `db2-xdb:contentHandling` annotation, specified as an attribute in the declaration of an XML element, indicates what value is to be inserted into the tables and columns specified by `db2-xdb:rowSet` and `db2-xdb:column`, respectively, during decomposition. The three valid values for `db2-xdb:contentHandling` are:

### text

- What is inserted: the concatenation of character data (including character content of CDATA sections) within this element.
- What is excluded: this element's comments and processing instructions, CDATA section delimiters ("`<![CDATA[" "]]>`"), as well as this element's descendants (including tags and content).

### stringValue

- What is inserted: the concatenation of this element's character data (including character content of CDATA sections) with the character data in this element's descendants, in document order.
- What is excluded: comments, processing instructions, CDATA section delimiters ("`<![CDATA[" "]]>`"), and the start and end tags of this element's descendants.

### serializeSubtree

- What is inserted: the markup of everything between this element's start and end tags, including this element's start and end tags. This includes comments, processing instructions, and CDATA section delimiters ("`<![CDATA[" "]]>`").
- What is excluded: nothing.
- 

**Notes:** The serialized string that is inserted might not be identical to the corresponding section in the XML document because of factors such as: default values specified in the XML schema, expansion of entities, order of attributes, whitespace normalization of attributes, and processing of CDATA sections.

Because the serialized string that results from this setting is an XML entity, there are code page issues that should be considered. If the target column is of character or graphic types, the XML fragment is inserted in the database's code page. When such an entity is passed by an application to an XML processor, the application must explicitly inform the processor of the entity's encoding, because the processor would not automatically detect encodings other than UTF-8. If the target column is of type BLOB, however, then the XML entity is inserted in UTF-8 encoding. In this case, the XML entity can be passed to the XML processor without needing to specify an encoding.

If an XML element declaration that is annotated for decomposition is of complex type and contains complex content, but does not have `db2-xdb:contentHandling` specified, then the default behavior follows the "serializeSubtree" setting. For all other cases of annotated element declarations, the default behavior if `db2-xdb:contentHandling` is not specified follows the "stringValue" setting.

If an element is declared to be of complex type and has an element-only or empty content model (that is, the "mixed" attribute of the element declaration is not set to true or 1), then `db2-xdb:contentHandling` cannot be set to "text".

Specifying the `db2-xdb:contentHandling` annotation on an element does not affect the decomposition of any of the element's descendants.

The setting of `db2-xdb:contentHandling` affects the value that is substituted for `$DECOMP_CONTENT` in either of the `db2-xdb:expression` or `db2-xdb:condition` annotations. The substituted value is first processed according to the `db2-xdb:contentHandling` setting, before it is passed for evaluation.

Note that if validation has been performed, either prior to decomposition or during, the content being processed by `db2-xdb:contentHandling` will already have its entities resolved.

## Example

The following example illustrates how the different settings of the `db2-xdb:contentHandling` annotation can be used to yield different results in the target table. The annotated schema is presented first, showing how the `<paragraph>` element is annotated with `db2-xdb:contentHandling`. (The annotated schema is presented only once, with `db2-xdb:contentHandling` set to "text". Subsequent examples in this section assume the same annotated schema, which differ only by the value `db2-xdb:contentHandling` is set to.)

```
<xs:schema>
  <xs:element name="books">
    <xs:complexType>
      <xs:sequence>
        <xs:element name="book">
          <xs:complexType>
            <xs:sequence>
              <xs:element name="authorID" type="xs:integer" />
              <xs:element name="chapter" type="chapterType" maxOccurs="unbounded" />
            </xs:sequence>
            <xs:attribute name="isbn" type="xs:string"
              db2-xdb:rowSet="BOOKCONTENTS" db2-xdb:column="ISBN" />
            <xs:attribute name="title" type="xs:string" />
          </xs:complexType>
        </xs:element>
      </xs:sequence>
    </xs:complexType>
  </xs:element>

  <xs:complexType name="chapterType">
    <xs:sequence>
      <xs:element name="paragraph" type="paragraphType" maxOccurs="unbounded"
        db2-xdb:rowSet="BOOKCONTENTS" db2-xdb:column="CHPTCONTENT"
        db2-xdb:contentHandling="text" />
    </xs:sequence>
    <xs:attribute name="number" type="xs:integer"
      db2-xdb:rowSet="BOOKCONTENTS" db2-xdb:column="CHPTNUM" />
    <xs:attribute name="title" type="xs:string"
      db2-xdb:rowSet="BOOKCONTENTS" db2-xdb:column="CHPTTITLE" />
  </xs:complexType>
```

```

<xs:complexType name="paragraphType" mixed="1">
  <xs:choice>
    <xs:element name="b" type="xs:string" minOccurs="0" maxOccurs="unbounded" />
  </xs:choice>
</xs:complexType>
</xs:schema>

```

The <books> element that is being mapped is presented next.

```

<books>
  <book isbn="1-11-111111-1" title="My First XML Book">
    <authorID>22</authorID>
    <chapter number="1" title="Introduction to XML">
      <paragraph>XML is <b>lots of</b> fun...</paragraph>
    </chapter>
    <chapter number="2" title="XML and Databases">
      <paragraph><!-- Start of chapter -->XML can be used with...</paragraph>
      <paragraph><?processInstr example?>
        Escape characters such as <![CDATA[ <, >, and & ]]>...</paragraph>
    </chapter>
    ...
    <chapter number="10" title="Further Reading">
      <paragraph>Recommended tutorials...</paragraph>
    </chapter>
  </book>
  ...
</books>

```

The next three tables show the result of decomposing the same XML element with differing values for db2-xdb:contentHandling.

**Note:** The following tables contain quotation marks around the values in the CHPTTITLE and CHPTCONTENT columns. These quotation marks do not exist in the columns, but are presented here only to show the boundaries and whitespaces of the inserted strings.

### db2-xdb:contentHandling="text"

Table 53. BOOKCONTENTS

ISBN	CHPTNUM	CHPTTITLE	CHPTCONTENT
1-11-111111-1	1	"Introduction to XML"	"XML is fun..."
1-11-111111-1	2	"XML and Databases"	"XML can be used with..."
1-11-111111-1	2	"XML and Databases"	" Escape characters such as <, >, and & ..."
...	...	...	...
1-11-111111-1	10	"Further Reading"	"Recommended tutorials..."

Observe how the content of the <b> element of the first paragraph of chapter 1 is not inserted when the "text" setting is used. This is because the "text" setting excludes any content from descendants. Notice also that the comment and processing instruction from the first paragraph of chapter 2 are excluded when the "text" setting is used. Whitespace from the concatenation of character data from the <paragraph> elements is preserved.



## db2-xdb:contentHandling="stringValue"

Table 54. BOOKCONTENTS

ISBN	CHPTNUM	CHPTTITLE	CHPTCONTENT
1-11-111111-1	1	"Introduction to XML"	"XML is lots of fun..."
1-11-111111-1	2	"XML and Databases"	"XML can be used with..."
1-11-111111-1	2	"XML and Databases"	" Escape characters such as <, >, and & ..."
...	...	...	...
1-11-111111-1	10	"Further Reading"	"Recommended tutorials..."

The difference between this table and the previous table is found in the CHPTCONTENT column of the first row. Notice how the string "lots of", which comes from the <b> descendant of the <paragraph> element, has been inserted. When db2-xdb:contentHandling was set to "text", this string was excluded, because the "text" setting excludes the content of descendants. The "stringValue" setting, however, includes content from descendants. Like the "text" setting, comments and processing instructions are not inserted, and whitespace is preserved.

## db2-xdb:contentHandling="serializeSubtree"

Table 55. BOOKCONTENTS

ISBN	CHPTNUM	CHPTTITLE	CHPTCONTENT
1-11-111111-1	1	"Introduction to XML"	"<paragraph>XML is <b>lots of</b> fun...</paragraph>"
1-11-111111-1	2	"XML and Databases"	"<paragraph><!-- Start of chapter -->XML can be used with...</paragraph>"
1-11-111111-1	2	"XML and Databases"	"<paragraph><?processInstr example?> Escape characters such as <![CDATA[ <, >, and & ]]>...</paragraph>"
...	...	...	...
1-11-111111-1	10	"Further Reading"	"<paragraph>Recommended tutorials...</paragraph>"

The difference between this table and the previous two tables is that all markup from the descendants of <paragraph> elements are inserted (including the <paragraph> start and end tags). This includes the <b> start and end tags in the CHPTCONTENT column of the first row, as well as the comment and processing instruction in the second and third rows, respectively. As in the previous two examples, whitespace from the XML document has been preserved.

## db2-xdb:normalization decomposition annotation

The db2-xdb:normalization annotation specifies the normalization of whitespace in the XML data to be inserted or to be substituted for \$DECOMP\_CONTENT (when used with db2-xdb:expression).

db2-xdb:normalization belongs to the set of decomposition annotations that can be added to an XML schema document to describe the mappings between elements and attributes of XML documents to DB2 base tables. The decomposition process uses the annotated XML schema to determine how elements and attributes of an XML document should be decomposed into DB2 tables.

### Annotation type

Attribute of <xs:element> or <xs:attribute>, or attribute of <db2-xdb:rowSetMapping>

### How to specify

db2-xdb:normalization is specified in any of the following ways (where *value* represents a valid value for the annotation):

- <xs:element db2-xdb:normalization="*value*" />
- <xs:attribute db2-xdb:normalization="*value*" />
- <db2-xdb:rowSetMapping db2-xdb:normalization="*value*">  
  <db2-xdb:rowSet>*value*</db2-xdb:rowSet>  
  ...  
</db2-xdb:rowSetMapping>

### Namespace

<http://www.ibm.com/xmlns/prod/db2/xdb1>

### Valid values

One of the following case-sensitive tokens:

- canonical
- original (default)
- whitespaceStrip

**Note:** The db2-xdb:normalization attribute is valid only for mappings between certain XML schema types and SQL character types. Refer to the Details section for the list of supported XML schema types that can be normalized for SQL character columns.

### Details

When inserting XML values into character type target columns (CHAR, VARCHAR, LONG VARCHAR, CLOB, DBCLOB, GRAPHIC, VARGRAPHIC, LONG VARGRAPHIC), it might be necessary to normalize the data being inserted. Different types of normalization can be specified with the db2-xdb:normalization annotation; the valid values, which are case-sensitive settings are:

#### canonical

The XML value is converted to its canonical form, according to its XML

schema type, before being inserted into the target column or substituted for occurrences of \$DECOMP\_CONTENT in the same mapping as this db2-xdb:normalization annotation.

### **original**

The original character data, following any processing by an XML parser, of the element content or attribute value (depending on whether this mapping is for an XML element or XML attribute) is inserted into the target column or substituted for occurrences of \$DECOMP\_CONTENT in the same mapping as this db2-xdb:normalization annotation. If the db2-xdb:normalization attribute is not specified for a mapping where this annotation is relevant, then the decomposition process normalizes data according to the "original" setting.

### **whitespaceStrip**

The XML value has all leading and trailing whitespace removed, and consecutive whitespace is collapsed into a single whitespace character, before being inserted into the target column or substituted for occurrences of \$DECOMP\_CONTENT in the same mapping as this db2-xdb:normalization annotation.

db2-xdb:normalization is applicable when an element or attribute of (or derived from) one of these atomic XML schema types is mapped to a column of character type (CHAR, VARCHAR, LONG VARCHAR, CLOB, DBCLOB, GRAPHIC, VARGRAPHIC, and LONG VARGRAPHIC).

- byte, unsigned byte
- integer, positiveInteger, negativeInteger, nonPositiveInteger, nonNegativeInteger
- int, unsignedInt
- long, unsignedLong
- short, unsignedShort
- decimal
- float
- double
- boolean
- time
- date
- dateTime

db2-xdb:normalization will be ignored if specified on any other types. Note that these are XML schema types for which the W3C recommendation, XML Schema Part 2: Datatypes Second Edition, has a canonical representation.

Because the db2-xdb:normalization annotation is valid only for certain XML schema to SQL character type mappings, when the annotation is specified for unsupported mappings, it is ignored.

## **Example**

The following example shows how whitespace normalization can be controlled with the db2-xdb:normalization annotation. The annotated schema is presented first.

```
<xs:element name="author">
  <xs:complexType>
    <xs:sequence>
      <xs:element name="firstname" type="xs:string"

```

```

        db2-xdb:rowSet="AUTHORS" db2-xdb:column="FIRSTNAME" />
<xs:element name="lastname" type="xs:string"
        db2-xdb:rowSet="AUTHORS" db2-xdb:column="SURNAME"
        db2-xdb:normalization="whitespaceStrip" />
<xs:element name="activeStatus" type="xs:boolean"
        db2-xdb:rowSet="AUTHORS" db2-xdb:column="ACTIVE"
        db2-xdb:normalization="canonical" />
<xs:attribute name="ID" type="xs:integer"
        db2-xdb:rowSet="AUTHORS" db2-xdb:column="AUTHID"
        db2-xdb:normalization="whitespaceStrip" />
</xs:sequence>
</xs:complexType>
</xs:element>

```

The <author> element that is being mapped is presented next (in the following example, notable whitespaces are represented by the '\_' underscore character for the purpose of demonstration), followed by the resulting AUTHORS table after the decomposition has completed.

```

<author ID="__22">
  <firstname>Ann</firstname>
  <lastname>__Brown_</lastname>
  <activeStatus>1</activeStatus>
</author>

```

Table 56. AUTHORS

AUTHID	FIRSTNAME	SURNAME	ACTIVE	NUMBOOKS
22	Ann	__Brown_	true	NULL

The "whitespaceStrip" setting causes the leading whitespace from the "ID" attribute to be removed before the value is inserted into the target table. Notice, however, that the leading and trailing whitespace from the <lastname> element is not stripped, even though the "whitespaceStrip" setting was specified. This is because the <lastname> element has an XML schema type of string, which is not an applicable type for db2-xdb:normalization. The <activeStatus> child element of <author> is defined as a boolean type, and the canonical representation of boolean types is either the literal "true" or "false". The "canonical" setting for the <activeStatus> element results in the canonical form of "1", which is "true", being inserted into the ACTIVE column of the AUTHORS table.

If in the XML schema presented previously, the "ID" attribute had been annotated with db2-xdb:normalization="original" instead, then the original value from the document, "\_\_22" (where the underscore character represents whitespace), would have been inserted into the AUTHID column.

## db2-xdb:order decomposition annotation

The db2-xdb:order annotation specifies the insertion order of rows among different tables.

db2-xdb:order belongs to the set of decomposition annotations that can be added to an XML schema document to describe the mappings between elements and attributes of XML documents to DB2 base tables. The decomposition process uses the annotated XML schema to determine how elements and attributes of an XML document should be decomposed into DB2 tables.

### Annotation type

Child element of <db2-xdb:rowSetOperationOrder>

## How to specify

`db2-xdb:order` is specified in the following way (where *value* represents a valid value for the annotation):

```
<xs:schema>
  <xs:annotation>
    <xs:appinfo>
      <db2-xdb:rowSetOperationOrder>
        <db2-xdb:order>
          <db2-xdb:rowSet>value</db2-xdb:rowSet>
          ...
        </db2-xdb:order>
      </db2-xdb:rowSetOperationOrder>
    </xs:appinfo>
  </xs:annotation>
  ...
</xs:schema>
```

## Namespace

<http://www.ibm.com/xmlns/prod/db2/xdb1>

## Valid structure

The following are supported children elements of `<db2-xdb:order>`:

### **db2-xdb:rowSet**

Specifies an XML element or attribute mapping to a target base table.

## Details

The `db2-xdb:order` annotation is used to define the order of insertion of the rows belonging to a given rowSet, relative to the rows belonging to another rowSet. This enables XML data to be inserted into target tables in a way consistent with any referential integrity constraints defined on the tables as part of the relational schema.

All rows of a given rowSet RS1 are inserted before any rows belonging to another rowSet RS2 if RS1 is listed before RS2 within `db2-xdb:order`. Multiple instances of this element can be specified in order to define multiple insert order hierarchies. For rowSets that do not appear in any element, their rows may be inserted in any order, relative to the rows of any other rowSet.. Also, the content of each `<db2-xdb:rowSet>` element must be either an explicitly defined rowSet or the name of an existing table for which no explicit rowSet declaration was made.

Multiple rowSet insertion hierarchies can be defined, though a rowSet can appear in only one instance of the `<db2-xdb:order>` element, and it can appear only once within that element.

For delimited SQL identifiers specified in the children elements, the quotation marks delimiter must be included in the character content and need not be escaped. The `'&'` and `'<'` characters used in SQL identifiers, however, must be escaped.

## Example

The following example demonstrates the use of the `db2-xdb:order` annotation.

```

<xs:schema>
  <xs:annotation>
    <xs:appinfo>
      <db2-xdb:rowSetOperationOrder>

        <db2-xdb:order>
          <db2-xdb:rowSet>CUSTOMER</db2-xdb:rowSet>
          <db2-xdb:rowSet>PURCHASE_ORDER</db2-xdb:rowSet>
        </db2-xdb:order>

        <db2-xdb:order>
          <db2-xdb:rowSet>ITEMS_MASTER</db2-xdb:rowSet>
          <db2-xdb:rowSet>PO_ITEMS</db2-xdb:rowSet>
        </db2-xdb:order>

      </db2-xdb:rowSetOperationOrder>
    </xs:appinfo>
  </xs:annotation>
</xs:schema>

```

Two disjoint hierarchies for order of insertion are specified in this example. The first hierarchy specifies that all content for the CUSTOMER rowSet or table is inserted prior to any content collected for PURCHASE\_ORDER, and the second hierarchy specifies that all content for the ITEMS\_MASTER rowSet or table will be inserted before any content is inserted into PO\_ITEMS. Note that the order between the two hierarchies is undefined. For example, any content for the PURCHASE\_ORDER rowSet or table may be inserted before or after any content is inserted into ITEMS\_MASTER.

## Restrictions

Specifying the order for rowSet insertions is subject to the following restrictions:

- On 32-bit systems, decomposition of large documents with insertion order requirements can cause the system to run out of memory.
- On 64-bit systems, an out of memory condition might occur if the administrator has restricted the virtual memory space allowed for a process. Specifying a sufficiently large or unlimited virtual memory setting for processes can help prevent out of memory conditions, but this might adversely affect the overall performance of the system.

## db2-xdb:truncate decomposition annotation

The db2-xdb:truncate annotation specifies whether truncation is permitted when an XML value is inserted into a character target column.

db2-xdb:truncate belongs to the set of decomposition annotations that can be added to an XML schema document to describe the mappings between elements and attributes of XML documents to DB2 base tables. The decomposition process uses the annotated XML schema to determine how elements and attributes of an XML document should be decomposed into DB2 tables.

### Annotation type

Attribute of <xs:element> or <xs:attribute>, or attribute of <db2-xdb:rowSetMapping>

## How to specify

db2-xdb:truncate is specified in any of the following ways (where *value* represents a valid value for the annotation):

- `<xs:element db2-xdb:truncate="value" />`
- `<xs:attribute db2-xdb:truncate="value" />`
- `<db2-xdb:rowSetMapping db2-xdb:truncate="value">`  
    `<db2-xdb:rowSet>value</db2-xdb:rowSet>`  
    `...`  
    `</db2-xdb:rowSetMapping>`

## Namespace

<http://www.ibm.com/xmlns/prod/db2/xdb1>

## Valid values

One of the following tokens:

- 0 (equivalent to false; default)
- 1 (equivalent to true)
- false (case-sensitive; default)
- true (case-sensitive)

## Details

An XML value being inserted into a target character column might be larger than the column size; in this case, the value must be truncated for a successful decomposition. The db2-xdb:truncate attribute indicates whether or not truncation will be permitted when the value is too large for the target column. If this attribute is set to "false" or "0", to indicate that truncation is not permitted, and the XML value being inserted is too large for the target column, an error occurs during decomposition of the XML document and the value is not inserted. The "true" or "1" settings indicate that data truncation is allowed during insertion.

db2-xdb:truncate is applicable only when the target column is either:

- of a character type, or
- of DATE, TIME, or TIMESTAMP type, and the XML value is of type xs:date, xs:time, or xs:dateTime, respectively.

If the db2-xdb:expression annotation is specified on the same element or attribute declaration as db2-xdb:truncate, then the value of db2-xdb:truncate is ignored, as the expression can perform truncation if it is defined as such.

When decomposing into SQL datetime columns, XML values that specify a timezone and have an XML schema type of date, time, or timestamp, db2-xdb:truncate must be set to "true" or "1". This is because the structure of SQL datetime types does not provide for timezone specification.

## Example

The following example shows how truncation can be applied to an `<author>` element. A section of the annotated schema is presented first.

```
<xs:element name="author">
  <xs:complexType>
    <xs:sequence>
```

```

<xs:element name="firstname" type="xs:string"
            db2-xdb:rowSet="AUTHORS" db2-xdb:column="FIRSTNAME"
            db2-xdb:truncate="true" />
<xs:element name="lastname" type="xs:string" />
<xs:element name="activeStatus" type="xs:boolean" />
<xs:element name="activated" type="xs:date"
            db2-xdb:truncate="true" />
<xs:attribute name="ID" type="xs:integer" />
<xs:sequence>
</xs:complexType>
</xs:element>

```

The <author> element that is being mapped is presented next.

```

<author ID="0800">
  <firstname>Alexander</firstname>
  <lastname>Smith</lastname>
  <activeStatus>0</activeStatus>
  <activated>2001-10-31Z</activated>
</author>

```

Assume that the FIRSTNAME column was defined as a CHAR SQL type of size 7, and that the ACTIVE DATE column was defined as a DATE SQL type. The AUTHORS table that results after the decomposition has completed is presented next.

Table 57. AUTHORS

AUTHID	FIRSTNAME	SURNAME	ACTIVE	ACTIVEDATE	NUMBOOKS
NULL	Alexand	NULL	NULL	2001-10-31	NULL

Because the <firstname> value "Alexander" is larger than the SQL column size, truncation is necessary in order to insert the value. Notice also that because the <activated> element contained a timezone in the XML document, db2-xdb:truncate was set to "true" to ensure the date was successfully inserted during decomposition.

Because truncation is required in order to insert the value from the <firstname> element or the <activated> element, if db2-xdb:truncate was not specified, then the default value of db2-xdb:truncate is assumed (truncation not permitted), and an error would have been generated to indicate that a row has not been inserted.

## db2-xdb:rowSetMapping decomposition annotation

The <db2-xdb:rowSetMapping> annotation maps a single XML element or attribute to one or more column and table pairs.

<db2-xdb:rowSetMapping> belongs to the set of decomposition annotations that can be added to an XML schema document to describe the mappings between elements and attributes of XML documents to DB2 base tables. The decomposition process uses the annotated XML schema to determine how elements and attributes of an XML document should be decomposed into DB2 tables.

### Annotation type

Child element of <xs:appinfo> (which is a child element of <xs:annotation>) that is a child element of <xs:element> or <xs:attribute>



## How to specify

`db2-xdb:rowSetMapping` is specified in any of the following ways (where *value* represents a valid value for the annotation):

- `<xs:element>`

```
<xs:annotation>
  <xs:appinfo>
    <db2-xdb:rowSetMapping>
      <db2-xdb:rowSet>value</db2-xdb:rowSet>
      ...
    </db2-xdb:rowSetMapping>
  </xs:appinfo>
</xs:annotation>
...
</xs:element>
```
- `<xs:attribute>`

```
<xs:annotation>
  <xs:appinfo>
    <db2-xdb:rowSetMapping>
      <db2-xdb:rowSet>value</db2-xdb:rowSet>
      ...
    </db2-xdb:rowSetMapping>
  </xs:appinfo>
</xs:annotation>
...
</xs:attribute>
```

## Namespace

<http://www.ibm.com/xmlns/prod/db2/xdb1>

## Valid structure

The following are supported attributes of `<db2-xdb:rowSetMapping>`:

### **db2-xdb:contentHandling**

Enables specification of the type of content that will be decomposed into a table for an element that is of complex type.

### **db2-xdb:locationPath**

Enables mapping of an XML element or attribute declared as part of a reusable group, to different table and column pairs, depending on the ancestry of the element or attribute.

### **db2-xdb:normalization**

Enables specification of the normalization behavior for the content of the XML element or attribute mapped to a character target column, before the content is inserted.

### **db2-xdb:truncate**

Enables specification of whether truncation is permitted when an XML value is inserted into a character target column.

These attributes of `<db2-xdb:rowSetMapping>` are also available as attributes of XML element or attribute declarations; the same behaviors and requirements apply to these whether they are attributes of `<db2-xdb:rowSetMapping>` or of `<xs:element>` or `<xs:attribute>`. Refer to the individual corresponding documentation of these annotations for details.

The following are supported children elements of `<db2-xdb:rowSetMapping>`, listed in the order in which they must appear if they are specified:

**<db2-xdb:rowSet>**

Maps an XML element or attribute to a target base table.

**<db2-xdb:column>**

(Optional) Maps an XML element or attribute to a base table column. This element is required if db2-xdb:expression is present in the db2-xdb:rowSetMapping annotation.

<db2-xdb:column> can be optional in cases where a value is not intended to be inserted into the table, but is used only for conditional processing. For example, if an element is to be decomposed based on the value of another element, then the other element does not require a column mapping, as its value is not being inserted.

**<db2-xdb:expression>**

(Optional) Specifies a customized expression, the result of which is inserted into the table named by the db2-xdb:rowSet attribute.

If db2-xdb:expression specifies \$DECOMP\_CONTENT and db2-xdb:normalization is specified in the same mapping, then the \$DECOMP\_CONTENT value for db2-xdb:expression will be normalized before it is passed to the expression for evaluation, if applicable.

**<db2-xdb:condition>**

(Optional) Specifies a condition for evaluation.

Note that these children elements of <db2-xdb:rowSetMapping> have the same semantics and syntax as their corresponding attribute annotations, except that quotation marks do not need to be escaped.

For further details, refer to the corresponding documentation of the attribute versions of these annotations.

## Details

<db2-xdb:rowSetMapping> can be used to map an XML element or attribute to a single target table and column, to multiple target columns of the same table, or to multiple tables and columns. There are two equivalent methods for mapping to a single table and column: the combination of the db2-xdb:rowSet and db2-xdb:column annotations (which are attributes of the element or attribute being mapped), or specifying <db2-xdb:rowSetMapping> (which is a child element of the element or attribute being mapped). Both methods yield the same results and differ only in their notation.

All whitespace in the character content of the child elements of <db2-xdb:rowSetMapping> is significant; no whitespace normalization is performed. For delimited SQL identifiers specified in the children elements, the quotation marks delimiter must be included in the character content and not escaped. The '&' and '<' characters used in SQL identifiers, however, must be escaped.

## Example

The following example shows how a single attribute, named "isbn", can be mapped to more than one table with the <db2-xdb:rowSetMapping> annotation. A section of the annotated schema is presented first. It shows how the isbn value is mapped to both the BOOKS and BOOKCONTENTS tables.

```

<xs:element name="book">
  <xs:complexType>
    <xs:sequence>
      <xs:element name="authorID" type="xs:integer"/>
      <xs:element name="chapter" type="chapterType" maxOccurs="unbounded" />
    </xs:sequence>
    <xs:attribute name="isbn" type="xs:string">
      <xs:annotation>
        <xs:appinfo>
          <db2-xdb:rowSetMapping>
            <db2-xdb:rowSet>BOOKS</db2-xdb:rowSet>
            <db2-xdb:column>ISBN</db2-xdb:column>
          </db2-xdb:rowSetMapping>
          <db2-xdb:rowSetMapping>
            <db2-xdb:rowSet>BOOKCONTENTS</db2-xdb:rowSet>
            <db2-xdb:column>ISBN</db2-xdb:column>
          </db2-xdb:rowSetMapping>
        </xs:appinfo>
      </xs:annotation>
    </xs:attribute>
    <xs:attribute name="title" type="xs:string" />
  </xs:complexType>
</xs:element>

```

The <book> element that is being mapped is presented next, followed by the resulting BOOKS and BOOKCONTENTS tables after the decomposition has completed.

```

<book isbn="1-11-111111-1" title="My First XML Book">
  <authorID>22</authorID>
  <!-- this book does not have a preface -->
  <chapter number="1" title="Introduction to XML">
    <paragraph>XML is fun...</paragraph>
    ...
  </chapter>
  ...
</book>

```

Table 58. BOOKS

ISBN	TITLE	CONTENT
1-11-111111-1	NULL	NULL

Table 59. BOOKCONTENTS

ISBN	CHPTNUM	CHPTTITLE	CHPTCONTENT
1-11-111111-1	NULL	NULL	NULL

### Alternative mapping using combination of <db2-xdb:rowSetMapping> and db2-xdb:rowSet and db2-xdb:column

The following section of an annotated schema is equivalent to the XML schema fragment presented previously, as it yields the same decomposition results. The difference between the two schemas is that this schema replaces one mapping with the db2-xdb:rowSet and db2-xdb:column combination, instead of using only the <db2-xdb:rowSetMapping> annotation.

```

<xs:element name="book">
  <xs:complexType>
    <xs:sequence>
      <xs:element name="authorID" type="xs:integer"/>
      <xs:element name="chapter" type="chapterType" maxOccurs="unbounded" />
    </xs:sequence>

```

```

<xs:attribute name="isbn" type="xs:string"
              db2-xdb:rowSet="BOOKS" db2-xdb:column="ISBN" >
  <xs:annotation>
    <xs:appinfo>
      <db2-xdb:rowSetMapping>
        <db2-xdb:rowSet>BOOKCONTENTS</db2-xdb:rowSet>
        <db2-xdb:column>ISBN</db2-xdb:column>
      </db2-xdb:rowSetMapping>
    </xs:appinfo>
  </xs:annotation>
</xs:attribute>
<xs:attribute name="title" type="xs:string" />
</xs:complexType>
</xs:element>

```

## db2-xdb:rowSetOperationOrder decomposition annotation

The db2-xdb:rowSetOperationOrder annotation is a parent for one or more db2-xdb:order elements. See the section for db2-xdb:order for details on usage in defining order of insertion of rows among different tables.

db2-xdb:rowSetOperationOrder belongs to the set of decomposition annotations that can be added to an XML schema document to describe the mappings between elements and attributes of XML documents to DB2 base tables. The decomposition process uses the annotated XML schema to determine how elements and attributes of an XML document should be decomposed into DB2 tables.

### Annotation type

Child element of <xs:appinfo> that is a child of a global <xs:annotation> element.

### How to specify

db2-xdb:rowSetOperationOrder is specified in the following way (where *value* represents a valid value for the annotation):

```

<xs:schema>
  <xs:annotation>
    <xs:appinfo>
      <db2-xdb:rowSetOperationOrder>
        <db2-xdb:order>
          <db2-xdb:rowSet>value</db2-xdb:rowSet>
          ...
        </db2-xdb:order>
      </db2-xdb:rowSetOperationOrder>
    </xs:appinfo>
  </xs:annotation>
  ...
</xs:schema>

```

### Namespace

<http://www.ibm.com/xmlns/prod/db2/xdb1>

### Valid structure

The following are supported children elements of <db2-xdb:rowSetOperationOrder>:

**db2-xdb:order**

## Details

<db2-xdb:rowSetOperationOrder> groups together <db2-xdb:order> elements. Multiple instances of the child <db2-xdb:order> element can be present, allowing the definition of multiple insertion hierarchies.

By allowing you to control the order in which contents of XML documents are inserted, the db2-xdb:rowSetOperationOrder and db2-xdb:order annotations together provide a way to ensure that the XML schema decomposition process respects any referential integrity constraints on target tables, as well as any other application requirements that rows of a table be inserted before rows of another table.

The db2-xdb:rowSetOperationOrder annotation can appear only once in an XML schema.

## Example

See the section for the db2-xdb:order annotation for examples of specifying the order of rowSet insertion.

## Keywords for annotated XML schema decomposition

Annotated XML schema decomposition offers decomposition keywords for use in the db2-xdb:condition and db2-xdb:expression annotations.

### \$DECOMP\_CONTENT

The value of the mapped XML element or attribute from the document, constructed according to the setting of the db2-xdb:contentHandling annotation. The value replaced for \$DECOMP\_CONTENT in the expression should always be considered a character type. Refer to the limits and restrictions documentation for the maximum string length of and maximum number of \$DECOMP\_CONTENT instances supported. If db2-xdb:expression specifies \$DECOMP\_CONTENT and db2-xdb:normalization is specified in the same mapping, then the \$DECOMP\_CONTENT value for db2-xdb:expression will be normalized before it is passed to the expression for evaluation, if applicable.

\$DECOMP\_CONTENT can be used to process the value of the mapped element or attribute, using customized expressions, rather than directly inserting that value.

### \$DECOMP\_DOCUMENTID

The string value specified in the *documentid* input parameter of the xdbDecompXML stored procedure, which identifies the XML document being decomposed. When the document is decomposed, the input value provided to the xdbDecompXML stored procedure is used as the value substituted for \$DECOMP\_DOCUMENTID.

Applications can pass into xdbDecompXML, uniquely generated document IDs. These IDs can then be directly inserted into the database. The IDs can also be passed into expressions that generate unique identifiers for elements or attributes. \$DECOMP\_DOCUMENTID can be used, therefore, to insert unique identifiers that are not present in the XML document.

### \$DECOMP\_ELEMENTID

A system-generated integer identifier that uniquely identifies within the XML document, the element or attribute this annotation describes. This value will remain unchanged between decomposition operations for the

same XML document, as long as the document does not change in any of the following ways: element addition, element deletion, or a change in an element's position in document order. If the document is modified in these ways and decomposed again, elements might not have the same identifier as they did following the previous decomposition.

\$DECOMP\_ELEMENTID specified on an attribute is defined to be the value of the \$DECOMP\_ELEMENTID for the element to which this attribute belongs.

The value generated by \$DECOMP\_ELEMENTID can also be used to indicate the order of elements in the original document. This can be useful in cases where the XML document needs to be re-composed from relational tables.

---

## How decomposition results are formed in annotated XML schema decomposition

While typical decomposition processes decompose only XML element or attribute content, annotated XML schema decomposition supports the insertion of values that do not necessarily exist in the XML document.

Decomposed content can be any of the following:

- the value of an attribute in the XML document
- the value of an element in the XML document, where the exact content depends on the setting of the <db2-xdb:contentHandling> annotation:
  - text - character data from this element only (not its descendants)
  - stringValue - character data from this element and its descendants
  - serializedSubtree - markup of all content between this element's start and end tags

Refer to the <db2-xdb:contentHandling> documentation for more information.

- a value based on the content of a mapped attribute or element in the XML document
- a generated value that is independent of any values in the XML document

The latter two values are possible through the db2-xdb:expression annotation. This annotation allows you to specify an expression, the result of which is inserted during decomposition.

The value from an XML document can be applied to an expression to generate a result, thereby transforming the data before it is inserted into the target column. An expression can also generate a value that is based on the mapped element or attribute (such as the element's name). db2-xdb:expression also allows constants to be specified, where the constant might or might not be related to the mapped value from the XML document. db2-xdb:expression enables you to combine any of these techniques to generate a value for insertion.

Note that the expression is invoked as many times as the element or attribute with which it is associated, is encountered in the XML document.

## Effect of validation on XML decomposition results

Annotated XML schema decomposition does not require input documents to be validated, but validation before or during decomposition is recommended, because it has several benefits.

You can perform validation before decomposition (using the XMLVALIDATE SQL/XML function), or during decomposition as part of the call to the xdbDecompXML stored procedure or the DECOMPOSE XML DOCUMENT command. Validating the XML documents being decomposed ensures that:

- values are decomposed into tables only when the entire document is valid according to the specified XML schema (this ensures that only valid values are stored in the database)
- default values defined for an element or attribute are inserted into the database (when validation is performed using one of the xdbDecompXML decomposition stored procedures and when the element or attribute does not appear in the XML document)
- all entities in the XML document will be resolved, for validation performed during decomposition (if an entity in the XML document has not been registered prior to decomposition, an error will be returned)
- non-default whitespace normalization occurs, as specified in the schema (when validation is performed using one of the xdbDecompXML decomposition stored procedures)

Validating the input documents against the registered XML schema is recommended, because the decomposition process assumes that input documents are valid according to the corresponding annotated schema. If the validation is not performed and the input documents are invalid, decomposition can insert different rows for the same input document (compared to when validation is performed, for reasons such as entity resolution or default attribute additions), or the decomposition might yield unexpected results. The results of and the side effects on existing data from decomposing an invalid document are undefined.

Note that errors in the schema, such as non-deterministic content models, or incorrect type derivations can cause the decomposition process to fail when validation is performed during decomposition. Verify that your annotated schema is correct and re-register the schema before attempting the decomposition again.

## **Treatment of CDATA sections in annotated XML schema decomposition**

The contents of CDATA sections are inserted into the database for elements that are annotated for decomposition. The CDATA section delimiters ("`<![CDATA["` and "`]]>`") can also be inserted. The CDATA contents are subject to line-ending normalization by the XML parser.

Without the attribute `db2-xdb:contentHandling`, the contents of CDATA sections are inserted into the database for elements that are annotated for decomposition. The CDATA section delimiters are not inserted.

If the XML element declaration in the XML schema is annotated with the attribute `db2-xdb:contentHandling="serializeSubtree"`, the CDATA section, including the CDATA delimiters, are inserted when decomposing a non-parsed XML document.

### **Difference in decomposition results between non-parsed XML and parsed XML**

There are differences when decomposing a CDATA section when the corresponding element declaration is annotated with the attribute `db2-xdb:contentHandling="serializeSubtree"`. The result depends on whether the

input XML document is non-parsed XML or parsed XML. For example, an XML document is stored as non-parsed XML in a CLOB column and as parsed XML in an XML column.

The decomposition result preserves the boundaries and the original contents of any CDATA sections in the element if the input XML document comes from a non-XML type column. If the input document come from a XML type column, the CDATA sections are not preserved in the decomposition results. For example, consider an XML document containing the following fragment:

```
<a> before cdata <![CDATA[ in cdata & <>]]> after cdata</a>
```

Decomposition produces the following result for the column mapped to element a, when db2-xdb:contentHandling="serializeSubtree" is specified in the mapping for element a if the document is stored in a CLOB column:

```
<a>before cdata <![CDATA[ in cdata & <>]]> after cdata</a>
```

If the XML document is stored in an XML type column, the decomposition result for that XML fragment is:

```
<a> before cdata in cdata & < &gt; < &gt; after cdata</a>
```

The non-preservation of the original CDATA section occurs whenever decomposition gets its input document from a XML type column. Although the non-preservation of the original CDATA section is not a correctness issue because the alternate is logically equivalent to the original, it might be different than the expected output.

## NULL values and empty strings in annotated XML schema decomposition

Annotated XML schema decomposition inserts NULL values or empty strings under certain conditions.

### XML elements

The following table shows when an empty string or a NULL value is inserted into the database for elements in the XML document.

Table 60. NULL handling for mapped elements

Condition	Empty string	NULL value
Element missing from document		X
Element satisfies all of the following conditions: <ul style="list-style-type: none"> <li>• is present in the document</li> <li>• contains the xsi:nil="true" or xsi:nil="1" attribute in the start tag</li> </ul>		X



Table 60. NULL handling for mapped elements (continued)

Condition	Empty string	NULL value
Element satisfies all of the following conditions: <ul style="list-style-type: none"> <li>• is present and empty in the document</li> <li>• does not contain the <code>xsi:nil="true"</code> or <code>xsi:nil="1"</code> attribute in the start tag</li> <li>• is derived from or declared to be of list type, union type, complex type with mixed content, or the following atomic built-in types: <code>xsd:string</code>, <code>xsd:normalizedString</code>, <code>xsd:token</code>, <code>xsd:hexBinary</code>, <code>xsd:base64Binary</code>, <code>xsd:anyURI</code>, <code>xsd:anySimpleType</code>; any other types will result in an error.</li> </ul>	X	
<b>Note:</b> <ol style="list-style-type: none"> <li>1. If a mapping involves the <code>db2-xdb:condition</code> or <code>db2-xdb:expression</code> annotations, then the empty string or NULL value (as shown in this table) is passed as the argument for expression evaluation.</li> <li>2. If a target column is of type CHAR or GRAPHIC, an empty string is inserted as a string of blank characters.</li> </ol>		

## XML attributes

The following table shows when an empty string or a NULL value is inserted into the database when XML attributes annotated for decomposition contain NULL values in the document or are missing.

Table 61. NULL handling for mapped attributes

Condition	Empty string	NULL value
Attribute missing from document (either because no validation was performed, or there was no default value provided by validation)		X
Attribute satisfies all of the following conditions: <ul style="list-style-type: none"> <li>• is present and empty in the document</li> <li>• is derived from or declared to be of list type, union type, or the following atomic built-in types: <code>xsd:string</code>, <code>xsd:normalizedString</code>, <code>xsd:token</code>, <code>xsd:hexBinary</code>, <code>xsd:base64Binary</code>, <code>xsd:anyURI</code>, <code>xsd:anySimpleType</code>; any other types will result in an error.</li> </ul>	X	
<b>Note:</b> If a mapping involves the <code>db2-xdb:condition</code> or <code>db2-xdb:expression</code> annotations, then the empty string or NULL value (as shown in this table) is passed as the argument for expression evaluation.		

---

## Checklist for annotated XML schema decomposition

Annotated XML schema decomposition can become complex. To make the task more manageable, you should take several things into consideration.

Annotated XML schema decomposition requires you to map possibly multiple XML elements and attributes to multiple columns and tables in the database. This mapping can also involve transforming the XML data before inserting it, or applying conditions for insertion.

The following are items to consider when annotating your XML schema, along with pointers to related documentation:

- Understand what decomposition annotations are available to you.
- Ensure, during mapping, that the type of the column is compatible with the XML schema type of the element or attribute it is being mapped to.
- Structure your XML schema to minimize demands made on system memory resources.
- Ensure complex types derived by restriction or extension are properly annotated.
- Confirm that no decomposition limits and restrictions are violated.
- Ensure that the tables and columns referenced in the annotation exist at the time the schema is registered with the XSR.

## Annotations of derived complex types for annotated XML schema decomposition

When annotating complex types derived by restriction or extension for decomposition, you need to apply additional mappings.

### Derived by restriction

Complex types that are derived by restriction require that the common elements and attributes from the base type be repeated in the definition of the derived type. Decomposition annotations that are present in the base type, therefore, must also be included in the derived type.

### Derived by extension

In the definition of complex types derived by extension, only the elements and attributes that are in addition to the base type are specified. If the decomposition mappings for the derived type differ from the mappings of the base type, then decomposition annotations must be added to the base type to clearly differentiate the mappings of the base from the derived types.

The following example shows how a type derived by extension, `outOfPrintBookType`, can be mapped to a different table than its base type, `bookType`. Notice how the `db2-xdb:locationPath` annotation is specified in the `bookType` base type to clearly differentiate which mappings apply to the base type, and which apply to the derived type. The `<lastPublished>` and `<publisher>` elements of the derived type `outOfPrintType` do not require the `db2-xdb:locationPath` annotation in this example, as these elements are involved only in a single mapping.

```
<xs:schema xmlns:xs="http://www.w3.org/2001/XMLSchema"
  xmlns:db2-xdb="http://www.ibm.com/xmlns/prod/db2-xdb1">
  <xs:annotation>
    <xs:appinfo>
      <db2-xdb:table>
        <db2-xdb:name>BOOKS</db2-xdb:name>
        <db2-xdb:rowSet>inPrintRowSet</db2-xdb:rowSet>
      </db2-xdb:table>
      <db2-xdb:table>
        <db2-xdb:name>OUTOFPRI</db2-xdb:name>
```

```

        <db2-xdb:rowSet>outOfPrintRowSet</db2-xdb:rowSet>
    </db2-xdb:table>
</xs:appinfo>
</xs:annotation>
<xs:element name="books">
    <xs:complexType>
        <xs:choice>
            <xs:element name="book" type="bookType"
                minOccurs="0" maxOccurs="unbounded"/>
            <xs:element name="outOfPrintBook" type="outOfPrintBookType"
                minOccurs="0" maxOccurs="unbounded"/>
        </xs:choice>
    </xs:complexType>
</xs:element>
<xs:complexType name="bookType">
    <xs:sequence>
        <xs:element name="authorID" type="xs:integer"/>
        <xs:element name="chapter" type="chapterType" maxOccurs="unbounded"/>
    </xs:sequence>
    <xs:attribute name="title" type="xs:string"
        db2-xdb:locationPath="/books/book/@title"
        db2-xdb:rowSet="inPrintRowSet" db2-xdb:column="TITLE">
        <xs:annotation>
            <xs:appinfo>
                <db2-xdb:rowSetMapping db2-xdb:locationPath="/books/outOfPrintBook/@title">
                    <db2-xdb:rowSet>outOfPrintRowSet</db2-xdb:rowSet>
                    <db2-xdb:column>TITLE</db2-xdb:column>
                </db2-xdb:rowSetMapping>
            </xs:appinfo>
        </xs:annotation>
    </xs:attribute>
    <xs:attribute name="isbn" type="xs:string"
        db2-xdb:locationPath="/books/book/@isbn"
        db2-xdb:rowSet="inPrintRowSet" db2-xdb:column="ISBN">
        <xs:annotation>
            <xs:appinfo>
                <db2-xdb:rowSetMapping db2-xdb:locationPath="/books/outOfPrintBook/@isbn">
                    <db2-xdb:rowSet>outOfPrintRowSet</db2-xdb:rowSet>
                    <db2-xdb:column>ISBN</db2-xdb:column>
                </db2-xdb:rowSetMapping>
            </xs:appinfo>
        </xs:annotation>
    </xs:attribute>
</xs:complexType>
<xs:complexType name="outOfPrintBookType">
    <xs:complexContent>
        <xs:extension base="bookType">
            <xs:sequence>
                <xs:element name="lastPublished" type="xs:date"
                    db2-xdb:rowSet="outOfPrintRowSet" db2-xdb:column="LASTPUBDATE"/>
                <xs:element name="publisher" type="xs:string"
                    db2-xdb:rowSet="outOfPrintRowSet" db2-xdb:column="PUBLISHER"/>
            </xs:sequence>
        </xs:extension>
    </xs:complexContent>
</xs:complexType>
<xs:simpleType name="paragraphType">
    <xs:restriction base="xs:string"/>
</xs:simpleType>
<xs:complexType name="chapterType">
    <xs:sequence>
        <xs:element name="paragraph" type="paragraphType" maxOccurs="unbounded"
            db2-xdb:locationPath="/books/book/chapter/paragraph"
            db2-xdb:rowSet="inPrintRowSet" db2-xdb:column="CONTENT">
            <xs:annotation>
                <xs:appinfo>
                    <db2-xdb:rowSetMapping

```

```

        db2-xdb:locationPath="/books/outOfPrintBook/chapter/paragraph">
        <db2-xdb:rowSet>outOfPrintBook</db2-xdb:rowSet>
        <db2-xdb:column>CONTENT</db2-xdb:column>
    </db2-xdb:rowSetMapping>
</xs:appinfo>
</xs:annotation>
</xs:element>
</xs:sequence>
<xs:attribute name="number" type="xs:integer"/>
<xs:attribute name="title" type="xs:string"/>
</xs:complexType>
</xs:schema>

```

The annotations indicate that values from the <book> element will be decomposed into the BOOKS table, while values from the <outOfPrintBook> element will be decomposed into the OUTOFPRINT table.

Consider the following element from an XML document:

```

<books>
  <book isbn="1-11-111111-1" title="My First XML Book">
    <authorID>22</authorID>
    <chapter number="1" title="Introduction to XML">
      <paragraph>XML is fun...</paragraph>
    </chapter>
    <chapter number="2" title="XML and Databases">
      <paragraph>XML can be used with...</paragraph>
    </chapter>
  </book>
  <outOfPrintBook isbn="7-77-777777-7" title="Early XML Book">
    <authorID>41</authorID>
    <chapter number="1" title="Introductory XML">
      <paragraph>Early XML...</paragraph>
    </chapter>
    <chapter number="2" title="What is XML">
      <paragraph>XML is an emerging technology...</paragraph>
    </chapter>
    <lastPublished>2000-01-31</lastPublished>
    <publisher>Early Publishers Group</publisher>
  </outOfPrintBook>
</books>

```

The following tables result from decomposing the document that this element belongs to, using the preceding annotated schema:

Table 62. BOOKS

ISBN	TITLE	CONTENT
1-11-111111-1	My First XML Book	XML is fun...
1-11-111111-1	My First XML Book	XML can be used with...

Table 63. OUTOFPRINT

ISBN	TITLE	CONTENT	LASTPUBDATE	PUBLISHER
7-77-777777-7	Early XML Book	Early XML...	2000-01-31	Early Publishers Group
7-77-777777-7	Early XML Book	XML is an emerging technology...	2000-01-31	Early Publishers Group

## XML schema structuring recommendations for decomposition

You can minimize the demands made on your system's memory resources from annotated schema decomposition by adjusting the order of elements in your annotated XML schema.

For very large documents, following this recommendation might make a difference in whether the document can be decomposed without having to increase the amount of available memory for the DB2 database server. For sibling elements that are annotated for decomposition, elements of simple types should be placed before the sibling elements of complex type in the annotated schema. Similarly, sibling elements that have the `maxOccurs` attribute set to 1 should be placed before siblings that have `maxOccurs > 1`.

The memory consumption required by annotated schema decomposition is affected by the structure of the XML schema because each item that forms a row must be held in memory until all of the items that form the row are processed. These schema structuring recommendations organize the items of a row in such a way as to minimize the number of items that must be kept in memory.

The following example shows the recommended XML schema structuring for mapped sibling elements contrasted with the less optimal structuring. Notice how `<complexElem>`, which is of complex type, is placed before `<status>`, which is of simple type, in the less optimal example. Placing `<complexElem>` after the `<id>` and `<status>` elements improves decomposition runtime efficiency.

```
<xs:schema xmlns:xs="http://www.w3.org/2001/XMLSchema"
           xmlns:db2-xdb="http://www.ibm.com/xmlns/prod/db2-xdb1">
  <!-- Recommended structuring with simple types placed before
        the recurring element <wrapper>, which is of complex type -->
  <xs:complexType name="typeA">
    <xs:sequence>
      <xs:element name="id" type="xs:integer"
                  db2-xdb:rowSet="relA" db2-xdb:column="ID" />
      <xs:element name="status" type="xs:string"
                  db2-xdb:rowSet="relA" db2-xdb:column="status" />
      <xs:element name="wrapper" type="typeX" maxOccurs="unbounded"/>
    </xs:sequence>
  </xs:complexType>

  <!-- Less optimal structuring with recurring complex type element
        appearing before the simple type element -->
  <!--
  <xs:complexType name="typeA">
    <xs:sequence>
      <xs:element name="id" type="xs:integer"
                  db2-xdb:rowSet="relA" db2-xdb:column="ID" />
      <xs:element name="wrapper" type="typeX" maxOccurs="unbounded"/>
      <xs:element name="status" type="xs:string"
                  db2-xdb:rowSet="relA" db2-xdb:column="status" />
    </xs:sequence>
  </xs:complexType> -->

  <xs:complexType name="typeX">
    <xs:sequence>
      <xs:element name="elem1" type="xs:string"
                  db2-xdb:rowSet="relA" db2-xdb:column="elem1" />
      <xs:element name="elem2" type="xs:long"
                  db2-xdb:rowSet="relA" db2-xdb:column="elem2" />
    </xs:sequence>
  </xs:complexType>
```

```
<xs:element name="A" type="typeA" />
</xs:schema>
```

Note that `<id>`, `<status>`, `<elem1>`, and `<elem2>` are mapped to the same `rowSet`, that is, together they form a row. Memory associated with a row is released when a row is complete. In the less optimal case presented previously, none of the rows associated with the `rowSet` `relA` can be considered complete until the `<status>` element is reached in the document. The `<wrapper>` element must be processed first, however, as it occurs before the `<status>` element. This means that all instances of `<wrapper>` must be buffered in memory until the `<status>` element is reached (or the end of `<A>` is reached, if `<status>` is absent from the document).

The impact of this structure becomes significant if there are a high number of instances of an element. For example, if there were 10 000 instances of the `<wrapper>` element, then all 10 000 instances would have to be held in memory until the `rowSet` was complete. In the optimal case presented previously, however, memory associated with the rows of `rowSet` `relA`, can be released when `<elem2>` is reached.

---

## Examples of mappings in annotated XML schema decomposition

Annotated XML schema decomposition relies on mappings to determine how to decompose an XML document into tables. Mappings are expressed as annotations added to the XML schema document. These mappings describe how you want an XML document to be decomposed into tables. The following examples show some common mapping scenarios.

Common mapping scenarios:

### rowSets in annotated XML schema decomposition

`db2-xdb:rowSet` identifies the target table into which a value is decomposed. This annotation can be set either to a table name or a `rowSet` name.

A `rowSet` is specified with the `db2-xdb:rowSet` annotation, which is added to the XML schema document as either an attribute of an element or attribute declaration, or a child of the `<db2-xdb:rowSetMapping>` annotation.

The set of mappings, across all schema documents that form the XML schema, which has the same `db2-xdb:rowSet` value for an instance of an element or attribute, defines a row.

For example, consider the following XML document:

```
<publications>
  <textbook title="Programming with XML">
    <isbn>0-11-011111-0</isbn>
    <author>Mary Brown</author>
    <author>Alex Page</author>
    <publicationDate>2002</publicationDate>
    <university>University of London</university>
  </textbook>
  <childrensbook title="Children's Fables">
    <isbn>5-55-555555-5</isbn>
    <author>Bob Carter</author>
```

```

    <author>Melaine Snowe</author>
    <publicationDate>1999</publicationDate>
  </childrensbook>
</publications>

```

To decompose this document such that each book's isbn and title (whether it is a textbook or children's book) is inserted into the same table (named ALLPUBLICATIONS), multiple rowSets must be defined: a rowSet to group values related to textbooks, and another to group values related to children's books.

rowSets, in this case, ensure that only values that are semantically related are grouped together to form a row. That is, the use of rowSets will group the isbn value for a textbook with its title, and the isbn value for a children's book with its title. This ensures that a row does not contain the isbn value from a textbook, while having the title from a children's book.

Without rowSets, it is impossible to determine which values should be grouped together to form a row that is still semantically correct.

The application of rowSets in an XML schema document is presented next. The two rowSets, textbk\_rowSet and childrens\_rowSet, are specified on the isbn element declaration of the <textbook> and <childrensbook> elements respectively. These rowsets are then associated with the ALLPUBLICATIONS table through the <db2-xdb:table> annotation.

Note that using the rowSet annotation not as a table identifier, but as a rowSet identifier allows you to easily change table names referenced in the XML schema. This is because, when the value of db2-xdb:rowSet represents an identifier rather than a table name, you need to use the <db2-xdb:table><db2-xdb:name></db2-xdb:name></db2-xdb:table> annotation to actually specify the table name. With this method, you need to update the table name in only one place, if required.

```

<xs:schema xmlns:xs="http://www.w3.org/2001/XMLSchema"
  xmlns:db2-xdb="http://www.ibm.com/xmlns/prod/db2-xdb1"
  elementFormDefault="qualified" attributeFormDefault="unqualified">
  <xs:annotation>
    <xs:appinfo>
      <db2-xdb:defaultSQLSchema>admin</db2-xdb:defaultSQLSchema>
      <db2-xdb:table>
        <db2-xdb:name>ALLPUBLICATIONS</db2-xdb:name>
        <db2-xdb:rowSet>textbk_rowSet</db2-xdb:rowSet>
        <db2-xdb:rowSet>childrens_rowSet</db2-xdb:rowSet>
      </db2-xdb:table>
    </xs:appinfo>
  </xs:annotation>
  <xs:element name="publications">
    <xs:complexType>
      <xs:sequence>
        <xs:element name="textbook" maxOccurs="unbounded">
          <xs:complexType>
            <xs:sequence>
              <xs:element name="isbn" type="xs:string"
                db2-xdb:rowSet="textbk_rowSet" db2-xdb:column="PUBS_ISBN"/>
              <xs:element name="author" type="xs:string" maxOccurs="unbounded"/>
              <xs:element name="publicationDate" type="xs:gYear"/>
              <xs:element name="university" type="xs:string"
                maxOccurs="unbounded"/>
            </xs:sequence>
            <xs:attribute name="title" type="xs:string" use="required"
              db2-xdb:rowSet="textbk_rowSet" db2-xdb:column="PUBS_TITLE"/>
          </xs:complexType>
        </xs:element>

```

```

<xs:element name="childrensbook" maxOccurs="unbounded">
  <xs:complexType>
    <xs:sequence>
      <xs:element name="isbn" type="xs:string"
        db2-xdb:rowSet="childrens_rowSet" db2-xdb:column="PUBS_ISBN"/>
      <xs:element name="author" type="xs:string" maxOccurs="unbounded"/>
      <xs:element name="publicationDate" type="xs:gYear"/>
    </xs:sequence>
    <xs:attribute name="title" type="xs:string" use="required"
      db2-xdb:rowSet="childrens_rowSet" db2-xdb:column="PUBS_TITLE"/>
  </xs:complexType>
</xs:element>
</xs:sequence>
</xs:complexType>
</xs:element>
</xs:schema>

```

The table that results from decomposing using this annotated XML schema is shown next.

Table 64. ALLPUBLICATIONS

ISBN	PUBS_TITLE
0-11-011111-0	Programming with XML
5-55-555555-5	Children's Fables

While the example presented previously shows a simple case of decomposing using rowSets, rowSets can be used in more complex mappings to group together multiple items from different parts of an XML schema to form rows on the same table and column pair.

## Conditional transformations

rowSets allow you to apply different transformations to the values being decomposed, depending on the values themselves.

For example, consider the following two instances of an element named "temperature":

```

<temperature unit="Celsius">49</temperature>
<temperature unit="Fahrenheit">49</temperature>

```

If the values of these elements are to be inserted into the same table, and you want the table to contain consistent values (all Celsius values, for example), then you need to convert the values that have the attribute unit="Fahrenheit" to Celsius before inserting. You can do this by mapping all elements with the attribute unit="Celsius" to one rowSet and all elements with the attribute unit="Fahrenheit" to another rowSet. The rowSet for Fahrenheit values can then have a conversion formula applied before insertion.

Notice that the mapping on the attribute declaration of "unit" does not contain any db2-xdb:column specification. This means that value of the item will only be used for condition evaluation and not for storage into the table specified by the db2-xdb:rowSet specification.

The following XML schema document could be used to insert the Celsius and converted Fahrenheit values into the same table:



```

....
<!-- Global annotation -->
<db2-xdb:table>
  <db2-xdb:name>TEMPERATURE_DATA</db2-xdb:name>
  <db2-xdb:rowSet>temp_celsius</db2-xdb:rowSet>
  <db2-xdb:rowSet>temp_fahrenheit</db2-xdb:rowSet>
</db2-xdb:table>
...
<xs:element name="temperature">
  <xs:annotation>
    <xs:appinfo>
      <db2-xdb:rowSetMapping>
        <db2-xdb:rowSet>temp_celsius</db2-xdb:rowSet>
        <db2-xdb:column>col1</db2-xdb:column>
      </db2-xdb:rowSetMapping>
      <db2-xdb:rowSetMapping>
        <db2-xdb:rowSet>temp_fahrenheit</db2-xdb:rowSet>
        <db2-xdb:column>col1</db2-xdb:column>
        <db2-xdb:expression>
          myudf_convertToCelsius($DECOMP_CONTENT)
        </db2-xdb:expression>
      </db2-xdb:rowSetMapping>
    </xs:appinfo>
  </xs:annotation>
  <xs:complexType>
    <xs:simpleContent>
      <xs:extension base="xs:int">
        <xs:attribute name="unit" type="xs:string">
          <xs:annotation>
            <xs:appinfo>
              <db2-xdb:rowSetMapping>
                <db2-xdb:rowSet>temp_celsius</db2-xdb:rowSet>
                <db2-xdb:condition>
                  $DECOMP_CONTENT = 'Celsius'
                </db2-xdb:condition>
              </db2-xdb:rowSetMapping>
              <db2-xdb:rowSetMapping>
                <db2-xdb:rowSet>temp_fahrenheit</db2-xdb:rowSet>
                <db2-xdb:condition>
                  $DECOMP_CONTENT = 'fahrenheit'
                </db2-xdb:condition>
              </db2-xdb:rowSetMapping>
            </xs:appinfo>
          </xs:annotation>
        </xs:attribute>
      </xs:extension>
    </xs:simpleContent>
  </xs:complexType>
</xs:element>

```

## Decomposition annotation example: Mapping to an XML column

In annotated XML schema decomposition, you can map an XML fragment to a column defined using the XML data type.

Consider the following XML document:

```

<publications>
  <textbook title="Programming with XML">
    <isbn>0-11-011111-0</isbn>
    <author>Mary Brown</author>
    <author>Alex Page</author>
  </textbook>
</publications>

```

```

    <publicationDate>2002</publicationDate>
    <university>University of London</university>
  </textbook>
</publications>

```

If you wanted to store the <textbook> XML element and book title as follows, you would add annotations to the declarations of the <textbook> element and title attribute in the corresponding XML schema document. The annotations should specify the DETAILS and TITLE columns, where the DETAILS column has been defined with the XML type, as well as the TEXTBOOKS table.

Table 65. TEXTBOOKS

TITLE	DETAILS
Programming with XML	<pre> &lt;textbook title="Programming with XML"&gt;   &lt;isbn&gt;0-11-011111-0&lt;/isbn&gt;   &lt;author&gt;Mary Brown&lt;/author&gt;   &lt;author&gt;Alex Page&lt;/author&gt;   &lt;publicationDate&gt;2002&lt;/publicationDate&gt;   &lt;university&gt;University of London&lt;/university&gt; &lt;/textbook&gt; </pre>

Depending on the annotation, an annotation can be specified in the schema document as an attribute or an element. Some annotations can be specified as either. Refer to the documentation for each specific annotation to determine how a particular annotation can be specified.

Specify the target table and column using either db2-xdb:rowSet and db2-xdb:column as attributes of <xs:element> or <xs:attribute> or the <db2-xdb:rowSet> and <db2-xdb:column> children elements of <db2-xdb:rowSetMapping>. Specifying these mappings as elements or attributes are equivalent.

The following fragment of the XML schema document shows how two mappings are added to the <textbook> element and title attribute by specifying annotations as attributes.

```

<xs:element name="publications">
  <xs:complexType>
    <xs:sequence>
      <xs:element name="textbook" maxOccurs="unbounded"
        db2-xdb:rowSet="TEXTBOOKS" db2-xdb:column="DETAILS">
        <xs:complexType>
          <xs:sequence>
            <xs:element name="isbn" type="xs:string"/>
            <xs:element name="author" type="xs:string" maxOccurs="unbounded"/>
            <xs:element name="publicationDate" type="xs:gYear"/>
            <xs:element name="university" type="xs:string" maxOccurs="unbounded"/>
          </xs:sequence>
          <xs:attribute name="title" type="xs:string" use="required"
            db2-xdb:rowSet="TEXTBOOKS" db2-xdb:column="TITLE"/>
        </xs:complexType>
      </xs:element>
    </xs:sequence>
  </xs:complexType>
</xs:element>

```

The db2-xdb:rowSet annotations specify the name of the target table, and the db2-xdb:column annotations specify the name of the target column. Because the <textbook> element is of complex type and contains complex content, and the db2-xdb:contentHandling annotation was not specified, by default, all markup

within the element (including its start and end tags) is inserted into the XML column according to the `serializeSubtree` setting of `db2-xdb:contentHandling`. Whitespace within the XML document is preserved. Refer to the `db2-xdb:contentHandling` documentation for more detail.

## Decomposition annotation example: A value mapped to a single table that yields a single row

Mapping a value from an XML document to a single table and column pair is a simple form of mapping in annotated XML schema decomposition. This example shows the simpler case of a one to one relationship between values in a `rowSet`.

The result of this mapping depends on the relationship between items mapped to the same `rowSet`. If the values that are mapped together in a single `rowSet` have a one to one relationship, as determined by the value of the `maxOccurs` attribute of the element or the containing model group declaration, a single row will be formed for each instance of the mapped item in the XML document. If the values in a single `rowSet` have a one to many relationship, where one value appears only once in the document for multiple instances of another item, as indicated by the value of the `maxOccurs` attribute, then multiple rows will result when the XML document is decomposed.

Consider the following XML document:

```
<publications>
  <textbook title="Programming with XML">
    <isbn>0-11-011111-0</isbn>
    <author>Mary Brown</author>
    <author>Alex Page</author>
    <publicationDate>2002</publicationDate>
    <university>University of London</university>
  </textbook>
</publications>
```

If you wanted the values of the `<isbn>` and `<publicationDate>` elements, as well as the title attribute, to be decomposed into the `TEXTBOOKS` table as follows, you need to add annotations to the declarations for these elements and attributes in the corresponding XML schema document. The annotations would specify the table and column names that each item is mapped to.

Table 66. *TEXTBOOKS*

ISBN	TITLE	DATE
0-11-011111-0	Programming with XML	2002

Depending on the annotation, an annotation can be specified in the schema document as an attribute or an element. Some annotations can be specified as either. Refer to the documentation for each specific annotation to determine how a particular annotation can be specified.

For the case of mapping a value to single table and column pair, you need to specify the table and column on the value being mapped. This is done using either `db2-xdb:rowSet` and `db2-xdb:column` as attributes of `<xs:element>` or `<xs:attribute>` or the `<db2-xdb:rowSet>` and `<db2-xdb:column>` children elements of `<db2-xdb:rowSetMapping>`. Specifying these mappings as elements or attributes are equivalent.

The following example shows how to map elements and attributes from the <textbook> element to the TEXTBOOKS table by specifying annotations as attributes.

```
<xs:element name="publications">
  <xs:complexType>
    <xs:sequence>
      <xs:element name="textbook" maxOccurs="unbounded">
        <xs:complexType>
          <xs:sequence>
            <xs:element name="isbn" type="xs:string"
              db2-xdb:rowSet="TEXTBOOKS" db2-xdb:column="ISBN"/>
            <xs:element name="author" type="xs:string" maxOccurs="unbounded"/>
            <xs:element name="publicationDate" type="xs:gYear"
              db2-xdb:rowSet="TEXTBOOKS" db2-xdb:column="DATE"/>
            <xs:element name="university" type="xs:string" maxOccurs="unbounded"/>
          </xs:sequence>
          <xs:attribute name="title" type="xs:string" use="required"
            db2-xdb:rowSet="TEXTBOOKS" db2-xdb:column="TITLE"/>
        </xs:complexType>
      </xs:element>
    </xs:sequence>
  </xs:complexType>
</xs:element>
```

The maxOccurs XML Schema attribute has a default value of 1, and so each of the items mapped to the TEXTBOOKS rowSet has a one to one relationship with each other. Because of this one to one relationship, a single row is formed for each instance of the <textbook> element.

## Decomposition annotation example: A value mapped to a single table that yields multiple rows

Mapping a value from an XML document to a single table and column pair is a simple form of mapping in annotated XML schema decomposition. This example shows the more complex case of a one to many relationship between values in a rowSet.

The result of this mapping depends on the relationship between items mapped to the same rowSet. If the values that are mapped together in a single rowSet have a one to one relationship, as determined by the value of the maxOccurs attribute of the element or the containing model group declaration, a single row will be formed for each instance of the mapped item in the XML document. If the values in a single rowSet have a one to many relationship, where one value appears only once in the document for multiple instances of another item, as indicated by the value of the maxOccurs attribute, then multiple rows will result when the XML document is decomposed.

Consider the following XML document:

```
<textbook title="Programming with XML">
  <isbn>0-11-011111-0</isbn>
  <author>Mary Brown</author>
  <author>Alex Page</author>
  <publicationDate>2002</publicationDate>
  <university>University of London</university>
</textbook>
```

If you wanted to store the ISBN and authors for a textbook as follows, you would add annotations to the declarations of the <isbn> and <author> elements in the corresponding XML schema document. The annotations should specify the ISBN and AUTHNAME columns, as well as the TEXTBOOK\_AUTH table.

Table 67. TEXTBOOKS\_AUTH

ISBN	AUTHNAME
0-11-011111-0	Mary Brown
0-11-011111-0	Alex Page

Depending on the annotation, an annotation can be specified in the schema document as an attribute or an element. Some annotations can be specified as either. Refer to the documentation for each specific annotation to determine how a particular annotation can be specified.

For the case of mapping a value to single table and column pair, you need to specify the table and column on the value being mapped. This is done using either `db2-xdb:rowSet` and `db2-xdb:column` as attributes of `<xs:element>` or `<xs:attribute>`, or the `<db2-xdb:rowSet>` and `<db2-xdb:column>` children elements of `<db2-xdb:rowSetMapping>`.

Specifying these mappings as elements or attributes is equivalent. The mappings are specified as elements in the XML schema document presented next.

```
<xs:element name="textbook" maxOccurs="unbounded">
  <xs:complexType>
    <xs:sequence>
      <xs:element name="isbn" type="xs:string">
        <xs:annotation>
          <xs:appinfo>
            <db2-xdb:rowSetMapping>
              <db2-xdb:rowSet>TEXTBOOKS_AUTH</db2-xdb:rowSet>
              <db2-xdb:column>ISBN</db2-xdb:column>
            </db2-xdb:rowSetMapping>
          </xs:appinfo>
        </xs:annotation>
      </xs:element>
      <xs:element name="author" type="xs:string" maxOccurs="unbounded">
        <xs:annotation>
          <xs:appinfo>
            <db2-xdb:rowSetMapping>
              <db2-xdb:rowSet>TEXTBOOKS_AUTH</db2-xdb:rowSet>
              <db2-xdb:column>AUTHNAME</db2-xdb:column>
            </db2-xdb:rowSetMapping>
          </xs:appinfo>
        </xs:annotation>
      </xs:element>
      <xs:element name="publicationDate" type="xs:gYear"/>
      <xs:element name="university" type="xs:string" maxOccurs="unbounded"/>
    </xs:sequence>
    <xs:attribute name="title" type="xs:string" use="required"/>
  </xs:complexType>
</xs:element>
```

Notice how the `<isbn>` element is mapped only once to the ISBN column, yet it appears in two rows in the table. This happens automatically during the decomposition process because there are multiple authors per ISBN value. The value of `<isbn>` is duplicated in each row for every author.

This behavior occurs because a one to many relationship is detected between the `<isbn>` and `<author>` elements, as the `maxOccurs` attribute for `<author>` is greater than 1.

Note that a one to many relationship can involve more than two items, and include sets of items. The one to many relationship can also be deeply nested, where an item already involved in a one to many relationship can participate in another one to many relationship.

## Decomposition annotation example: A value mapped to multiple tables

A single value from an XML document can be mapped to multiple tables. This example shows how to annotate an XML schema document to map a single value to two tables.

Consider the following XML document.

```
<textbook title="Programming with XML">
  <isbn>0-11-011111-0</isbn>
  <author>Mary Brown</author>
  <author>Alex Page</author>
  <publicationDate>2002</publicationDate>
  <university>University of London</university>
</textbook>
```

To map a textbook's ISBN to the following two tables, you need to create two mappings on the `<isbn>` element. This can be done by adding multiple `<db2-xdb:rowSetMapping>` elements to the `<isbn>` element declaration in the XML schema document.

Table 68. TEXTBOOKS

ISBN	TITLE
0-11-011111-0	Programming with XML

Table 69. SCHOOLPUBS

ISBN	SCHOOL
0-11-011111-0	University of London

The following fragment of the XML schema document shows how two mappings are added to the `<isbn>` element declaration to specify the mappings to two tables. The value of the title attribute and `<university>` element also included in the mappings.

```
<xs:element name="textbook" maxOccurs="unbounded">
  <xs:complexType>
    <xs:sequence>
      <xs:element name="isbn" type="xs:string">
        <xs:annotation>
          <xs:appinfo>
            <db2-xdb:rowSetMapping>
              <db2-xdb:rowSet>TEXTBOOKS</db2-xdb:rowSet>
              <db2-xdb:column>ISBN</db2-xdb:column>
            </db2-xdb:rowSetMapping>
            <db2-xdb:rowSetMapping>
              <db2-xdb:rowSet>SCHOOLPUBS</db2-xdb:rowSet>
              <db2-xdb:column>ISBN</db2-xdb:column>
            </db2-xdb:rowSetMapping>
          </xs:appinfo>
        </xs:annotation>
      </xs:element>
      <xs:element name="author" type="xs:string" maxOccurs="unbounded"/>
      <xs:element name="publicationDate" type="xs:gYear"/>
      <xs:element name="university" type="xs:string" maxOccurs="unbounded">
```

```

        <xs:annotation>
          <xs:appinfo>
            <db2-xdb:rowSetMapping>
              <db2-xdb:rowSet>SCHOOLPUBS</db2-xdb:rowSet>
              <db2-xdb:column>SCHOOL</db2-xdb:column>
            </db2-xdb:rowSetMapping>
          </xs:appinfo>
        </xs:annotation>
      </xs:element>
    </xs:sequence>
    <xs:attribute name="title" type="xs:string" use="required">
      <xs:annotation>
        <xs:appinfo>
          <db2-xdb:rowSetMapping>
            <db2-xdb:rowSet>TEXTBOOKS</db2-xdb:rowSet>
            <db2-xdb:column>TITLE</db2-xdb:column>
          </db2-xdb:rowSetMapping>
        </xs:appinfo>
      </xs:annotation>
    </xs:attribute>
  </xs:complexType>
</xs:element>

```

## Complex types that appear multiple times

If a complex type is referred to in multiple places in an XML schema, you can map it to different tables and columns depending on its location in the schema, using the `db2-xdb:locationPath` annotation.

In this case, the complex type element or attribute declaration needs to be annotated with multiple `<db2-xdb:rowSetMapping>` annotations (one for each mapping) where each mapping is distinguished by the `db2-xdb:locationPath` attribute.

## Decomposition annotation example: Grouping multiple values mapped to a single table

In annotated XML schema decomposition, you can map multiple values from unrelated elements to the same table, while preserving the relationship between logically-related values. This is possible by declaring multiple `rowSets`, which are used to group related items to form a row, as shown in this example.

For example, consider the following XML document:

```

<publications>
  <textbook title="Programming with XML">
    <isbn>0-11-011111-0</isbn>
    <author>Mary Brown</author>
    <author>Alex Page</author>
    <publicationDate>2002</publicationDate>
    <university>University of London</university>
  </textbook>
  <childrensbook title="Children's Fables">
    <isbn>5-55-555555-5</isbn>
    <author>Bob Carter</author>
    <author>Melaine Snowe</author>
    <publicationDate>1999</publicationDate>
  </childrensbook>
</publications>

```

To generate the following table after decomposition, you need to ensure that values relating to a textbook are not grouped in the same row as values associated with a children's book. Use multiple rowSets to group related values and yield logically meaningful rows.

Table 70. ALLPUBLICATIONS

PUBS_ISBN	PUBS_TITLE
0-11-011111-0	Programming with XML
5-55-555555-5	Children's Fables

In a simple mapping scenario, where you are mapping a single value to a single table and column pair, you could just specify the table and column you want to map the value to.

This example shows a more complex case, however, where multiple values are mapped to the same table and must be logically grouped. If you were to simply map each ISBN and title to the PUBS\_ISBN and PUBS\_TITLE columns, without the use of rowSets, the decomposition process would not be able to determine which ISBN value belonged with which title value. By using rowSets, you can group logically related values to form a meaningful row.

The following XML schema document shows how two rowSets are defined to distinguish values of the <textbook> element from values of the <childrensbook> element.

```
<xs:schema xmlns:xs="http://www.w3.org/2001/XMLSchema"
  xmlns:db2-xdb="http://www.ibm.com/xmlns/prod/db2-xdb1"
  elementFormDefault="qualified" attributeFormDefault="unqualified">
  <xs:annotation>
    <xs:appinfo>
      <db2-xdb:table>
        <db2-xdb:name>ALLPUBLICATIONS</db2-xdb:name>
        <db2-xdb:rowSet>textbk_rowSet</db2-xdb:rowSet>
        <db2-xdb:rowSet>childrens_rowSet</db2-xdb:rowSet>
      </db2-xdb:table>
    </xs:appinfo>
  </xs:annotation>
  <xs:element name="publications">
    <xs:complexType>
      <xs:sequence>
        <xs:element name="textbook" maxOccurs="unbounded">
          <xs:complexType>
            <xs:sequence>
              <xs:element name="isbn" type="xs:string"
                db2-xdb:rowSet="textbk_rowSet" db2-xdb:column="PUBS_ISBN"/>
              <xs:element name="author" type="xs:string" maxOccurs="unbounded"/>
              <xs:element name="publicationDate" type="xs:gYear"/>
              <xs:element name="university" type="xs:string" maxOccurs="unbounded"/>
            </xs:sequence>
            <xs:attribute name="title" type="xs:string" use="required"
              db2-xdb:rowSet="textbk_rowSet" db2-xdb:column="PUBS_TITLE"/>
          </xs:complexType>
        </xs:element>
        <xs:element name="childrensbook" maxOccurs="unbounded">
          <xs:complexType>
            <xs:sequence>
              <xs:element name="isbn" type="xs:string"
                db2-xdb:rowSet="childrens_rowSet" db2-xdb:column="PUBS_ISBN"/>
              <xs:element name="author" type="xs:string" maxOccurs="unbounded"/>
              <xs:element name="publicationDate" type="xs:gYear"/>
            </xs:sequence>
          </xs:complexType>
        </xs:element>
      </xs:sequence>
    </xs:complexType>
  </xs:element>
</xs:schema>
```



```

        <xs:attribute name="title" type="xs:string" use="required"
            db2-xdb:rowSet="childrens_rowSet" db2-xdb:column="PUBS_TITLE"/>
    </xs:complexType>
</xs:element>
</xs:sequence>
</xs:complexType>
</xs:element>
</xs:schema>

```

Notice how the db2-xdb:rowSet mappings in each of the element and attribute declarations do not specify the name of a table, but rather the name of a rowSet. The rowSets are associated with the ALLPUBLICATIONS table in the <db2-xdb:table> annotation, which must be specified as a child of <xs:schema>.

By specifying multiple rowSets that map to the same table, you can ensure that logically related values form a row in the table.

## Decomposition annotation example: Multiple values from different contexts mapped to a single table

In annotated XML schema decomposition, you can map multiple values to the same table and column, such that a single column can contain values that have come from different parts of a document. This is possible by declaring multiple rowSets, as shown in this example.

For example, consider the following XML document:

```

<publications>
  <textbook title="Principles of Mathematics">
    <isbn>1-11-111111-1</isbn>
    <author>Alice Braun</author>
    <publisher>Math Pubs</publisher>
    <publicationDate>2002</publicationDate>
    <university>University of London</university>
  </textbook>
</publications>

```

You can map both the author and the publisher to the same table that contains contacts for a particular book.

Table 71. BOOKCONTACTS

ISBN	CONTACT
1-11-111111-1	Alice Braun
1-11-111111-1	Math Pubs

The values in the CONTACT column of the resulting table come from different parts of the XML document: one row might contain an author's name (from the <author> element, while another row contains a publisher's name (from the <publisher> element).

The following XML schema document shows how multiple rowSets can be used to generate this table.

```

<xs:schema xmlns:xs="http://www.w3.org/2001/XMLSchema"
    xmlns:db2-xdb="http://www.ibm.com/xmlns/prod/db2/xdb1"
    elementFormDefault="qualified" attributeFormDefault="unqualified">
  <xs:annotation>
    <xs:appinfo>
      <db2-xdb:table>
        <db2-xdb:name>BOOKCONTACTS</db2-xdb:name>

```

```

        <db2-xdb:rowSet>author_rowSet</db2-xdb:rowSet>
        <db2-xdb:rowSet>publisher_rowSet</db2-xdb:rowSet>
    </db2-xdb:table>
</xs:appinfo>
</xs:annotation>
<xs:element name="publications">
    <xs:complexType>
        <xs:sequence>
            <xs:element name="textbook" maxOccurs="unbounded">
                <xs:complexType>
                    <xs:sequence>
                        <xs:element name="isbn" type="xs:string">
                            <xs:annotation>
                                <xs:appinfo>
                                    <db2-xdb:rowSetMapping>
  <db2-xdb:rowSet>author_rowSet</db2-xdb:rowSet>
  <db2-xdb:column>ISBN</db2-xdb:column>
                                    </db2-xdb:rowSetMapping>
                                    <db2-xdb:rowSetMapping>
  <db2-xdb:rowSet>publisher_rowSet</db2-xdb:rowSet>
  <db2-xdb:column>ISBN</db2-xdb:column>
                                    </db2-xdb:rowSetMapping>
                                </xs:appinfo>
                            </xs:annotation>
                        </xs:element>
                    </xs:sequence>
                </xs:complexType>
            </xs:element>
            <xs:element name="author" type="xs:string" maxOccurs="unbounded">
                <xs:annotation>
                    <xs:appinfo>
                        <db2-xdb:rowSetMapping>
                            <db2-xdb:rowSet>author_rowSet</db2-xdb:rowSet>
                            <db2-xdb:column>CONTACT</db2-xdb:column>
                        </db2-xdb:rowSetMapping>
                    </xs:appinfo>
                </xs:annotation>
            </xs:element>
            <xs:element name="publisher" type="xs:string">
                <xs:annotation>
                    <xs:appinfo>
                        <db2-xdb:rowSetMapping>
                            <db2-xdb:rowSet>publisher_rowSet</db2-xdb:rowSet>
                            <db2-xdb:column>CONTACT</db2-xdb:column>
                        </db2-xdb:rowSetMapping>
                    </xs:appinfo>
                </xs:annotation>
            </xs:element>
            <xs:element name="publicationDate" type="xs:gYear"/>
            <xs:element name="university" type="xs:string"
                maxOccurs="unbounded"/>
        </xs:sequence>
        <xs:attribute name="title" type="xs:string" use="required"/>
    </xs:complexType>
</xs:element>
</xs:sequence>
</xs:complexType>
</xs:element>
</xs:schema>

```

Notice how the db2-xdb:rowSet mappings in each of the element declarations do not specify the name of a table, but rather the name of a rowSet. The rowSets are associated with the BOOKCONTACTS table in the <db2-xdb:table> annotation, which must be specified as a child of <xs:schema>.



- \* The db2-xdb:normalization annotation is used to determine the format of the string that is inserted into the database.
- Data types are not compatible for annotated XML schema decomposition.
- 0 Data types are compatible.
- 0a Compatible, and where -0 is in the value space of the XML type, -0 is stored as 0 in the database.
- 1 Compatible if the string is in an acceptable lexical form for the target SQL type and can be converted to a numeric value in the range of the SQL type. Loss of significant digits can occur.
- 2 Compatible if the string is of a valid date format: *yyyy-mm-dd*, *mm/dd/yyyy*, or *dd.mm.yyyy*.
- 3 Compatible if the string is of a valid time format: *hh.mm.ss*, *hh:mm AM* or *PM*, or *hh:mm:ss*.
- 4 Compatible if the string is of a valid timestamp format: *yyyy-mm-dd-hh.mm.ss.nnnnnn* or *yyyy-mm-dd hh.mm.ss.nnnnnn*.
- 5 Compatible if the length of the XML input string, in bytes, is less than or equal to the length of the target column in bytes. If the input string is longer than the target column, then the string is compatible only if db2-xdb:truncate is set to "true" or "1" for this column mapping. String length is computed after normalization, where the input string is normalized according to the whitespace facet of the XML schema type.
- 5a Compatible according to the conditions described in 5. Additionally, the input string must be composed of double-byte characters.
- 5b Compatible according to the conditions described in 5. Additionally, the value that is inserted into the target column is the string of concatenated list items, each separated by a single space (in accordance with the "collapse" whitespace facet for lists).
- 5c Compatible according to the conditions described in 5a. Additionally, the value that is inserted into the target column is the string of concatenated list items, each separated by a single space (in accordance with the "collapse" whitespace facet for lists).
- 5d Compatible if the length of the XML input string, in bytes, is less than or equal to the length of the target column in bytes. If the input string is longer than the target column, then the string is compatible only if db2-xdb:truncate is set to "true" or "1" for this column mapping. The value that is inserted into the target column in either case is the character content of the element or attribute.
- 5e Compatible according to the conditions described in 5d. Additionally, The input string must be composed of double-byte characters.
- 6 Compatible if the length of the XML input string, in bytes, is less than or equal to the length of the target column in bytes. If the input string is longer than the target column, then the string is compatible only if db2-xdb:truncate is set to "true" or "1" for this column mapping. String length is computed after normalization, where the input string is normalized according to the whitespace facet of the XML schema type. If the length of the input XML string is less than the defined length of the target column, then the string is right-padded with blanks when inserted.

- 6a Compatible according to the conditions described in 6. Additionally, the input string must be composed of double-byte characters.
- 6b Compatible according to the conditions described in 6. Additionally, the value that is inserted into the target column is the string of concatenated list items, each separated by a single space (in accordance with the "collapse" whitespace facet for lists).
- 6c Compatible according to the conditions described in 6a. Additionally, the value that is inserted into the target column is the string of concatenated list items, each separated by a single space (in accordance with the "collapse" whitespace facet for lists).
- 6d Compatible if the length of the XML input string, in bytes, is less than or equal to the length of the target column in bytes. If the input string is longer than the target column, then the string is compatible only if db2-xdb:truncate is set to "true" or "1" for this column mapping. The value that is inserted into the target column in either case is the character content of the element or attribute. If the length of the input XML string is less than the defined length of the target column, then the string is right-padded with blanks when inserted.
- 6e Compatible according to the conditions described in 6d. Additionally, The input string must be composed of double-byte characters.
- 7 Compatible if the length of the XML input string, in bytes, is less than or equal to the length of the target column in bytes. If the input string is longer than the target column, then the string is compatible only if db2-xdb:truncate is set to "true" or "1" for this column mapping. String length is computed after normalization, where the input string is normalized according to the whitespace facet of the XML schema type.
- 7a Compatible according to the conditions described in 7. Additionally, if the length of the input XML string is less than the defined length of the target column, then the string is right-padded with blanks when inserted.
- 7b Compatible according to the conditions described in 7. Additionally, the value that is inserted into the target column is the string of concatenated list items, each separated by a single space (in accordance with the "collapse" whitespace facet for lists).
- 7c Compatible according to the conditions described in 7b. Additionally, if the length of the input XML string is less than the defined length of the target column, then the string is right-padded with blanks when inserted.
- 7d Compatible if the length of the XML input string, in bytes, is less than or equal to the length of the target column in bytes. If the input string is longer than the target column, then the string is compatible only if db2-xdb:truncate is set to "true" or "1" for this column mapping. The value that is inserted into the target column in either case is the character content of the element or attribute.
- 7e Compatible according to the conditions described in 7d. Additionally, if the length of the input XML string is less than the defined length of the target column, then the string is right-padded with blanks when inserted.
- 8 Compatible if the length of the XML input string, in bytes, is less than or equal to the length of the target column in bytes. If the input string is longer than the target column, then the string is compatible only if db2-xdb:truncate is set to "true" or "1" for this column mapping. The encoded (original) string is inserted.

- 8a Compatible according to the conditions described in 8. Additionally, if the length of the input XML string is less than the defined length of the target column, then the string is right-padded with blanks when inserted.
- 8b Compatible if the length of the XML input string, in bytes, is less than or equal to the length of the target column in bytes. If the input string is longer than the target column, then the string is compatible only if `db2-xdb:truncate` is set to "true" or "1" for this column mapping. The value that is inserted into the target column is the decoded string.
- 8c Compatible according to the conditions described in 8b. Additionally, if the length of the input XML string is less than the defined length of the target column, then the string is right-padded with blanks when inserted.
- 9 Compatible if the length of the XML input string, computed after processing according to the `db2-xdb:normalization` setting, is less than or equal to the length of the target column. Also compatible if `db2-xdb:truncate` is set to "true" or "1" for this column mapping.
- 9a Compatible according to the conditions described in 9. Additionally, if the length of the input XML string is less than the defined length of the target column, then the string is right-padded with blanks when inserted.
- 10 Compatible if the XML type is in the range of the SQL type. Where -0 is in the value space of the XML type, -0 is stored as 0 in the database.
- 11 Compatible if the XML value is in the range of the SQL type. Loss of significant digits can occur. Where -0 is in the value space of the XML type, -0 is stored as 0 in the database.
- 12 Compatible, and the value inserted is '0' (for false) or '1' (for true).
- 13 Compatible if the length of the XML input string, computed after processing according to the `db2-xdb:normalization` setting, is less than or equal to the length of the target column. Also compatible if `db2-xdb:truncate` is set to "true" or "1" for this column mapping.
- 13a Compatible according to the conditions described in 13. Additionally, if the length of the input XML string is less than the defined length of the target column, then the string is right-padded with blanks when inserted.
- 14 For XML values that contain subseconds, compatible only if the decomposition annotation specifies `db2-xdb:truncate` as "true" or "1". For XML values with time zone indicators, compatible if `db2-xdb:truncate` is set to "true" or "1"; values are inserted without the time zone.
- 15 Compatible if the year is composed of four digits and is not preceded by the '-' sign. Compatible if the XML value does not have a time zone indicator. If the XML value has a time zone indicator, then the values are compatible if `db2-xdb:truncate` is set to "true" or "1".
- 16 Compatible if the value is in the range of the SQL type and is not "INF", "-INF" or "NaN". Where -0 is in the value space of the XML type, -0 is stored as 0 in the database. Loss of significant digits can occur.
- 17 Compatible if the value is not "INF", "-INF" or "NaN". Where -0 is in the value space of the XML type, -0 is stored as 0 in the database.
- 18 Compatible if the string length of the URI, in bytes, is less than or equal to the length of the target column in bytes. If the input string is longer than the target column, then the string is compatible only if `db2-xdb:truncate` is set to "true" or "1" for this column mapping. Note that the URI itself, not the resource the URI points to, is inserted.

- 18a Compatible according to the conditions described in 18. Additionally, if the length of the input XML string is less than the defined length of the target column, then the string is right-padded with blanks when inserted.
- 19 Compatible if the year is composed of four digits and is not preceded by the '-' sign. For XML values with time zone indicators, compatible if db2-xdb:truncate is set to "true" or "1". (Values are inserted without the time zone in this case.) If subseconds are specified with more than six digits, compatible if db2-xdb:truncate is set to "true" or "1".
- 20 Compatible if the year is composed of four digits and is not preceded by the '-' sign. For XML values with time zone indicators, compatible if db2-xdb:truncate is set to "true" or "1". (Date values are inserted without the time zone in this case.)
- 21 The fractional part of the number is truncated. Compatible if the whole part is in the range of the SQL type. Where -0 is in the value space of the XML type, -0 is stored as 0 in the database.
- 22 The fractional part of the number is truncated. Compatible if the whole part is in the range of the SQL type, and the value is not "INF", "-INF" or "NaN". Where -0 is in the value space of the XML type, -0 is stored as 0 in the database.

---

## Limits and restrictions for annotated XML schema decomposition

Certain limits and restrictions apply to annotated XML schema decomposition.

### Limits

*Table 73. Limits for annotated XML schema decomposition*

Condition	Limit value
Maximum size of document to be decomposed	2 GB
Maximum number of tables referred to in a single annotated XML schema	100
Maximum number of \$DECOMP_CONTENT or \$DECOMP_ELEMENTID instances in an db2-xdb:expression annotation	10
Maximum number of steps in db2-xdb:locationPath	100
Maximum number of namespaces explicitly listed in the "namespace" attribute of <xs:any> or <xs:anyAttribute> (if the list contains the special values ##targetNamespace or ##local, then these also count towards the limit)	25
Maximum string length of the value of db2-xdb:name (table name), db2-xdb:column, db2-xdb:defaultSQLSchema, or db2-xdb:SQLSchema	Same as the limit for the corresponding DB2 object
Maximum string length of the value of db2-xdb:rowSet	Same as the limit for db2-xdb:name

Table 73. Limits for annotated XML schema decomposition (continued)

Condition	Limit value
Maximum string length for value of \$DECOMP_CONTENT	4096 bytes

## Restrictions

- Annotated XML schema decomposition does not support the following:
  - decomposition of element of attribute wildcards: elements or attributes in the XML document that correspond to the `<xs:any>` or `<xs:anyAttribute>` declaration in the XML schema are not decomposed.

If, however, these elements or attributes are children of elements that are decomposed with `db2-xdb:contentHandling` set to `"serializeSubtree"` or `"stringValue"`, then the contents of the wildcard elements or attributes will be decomposed as part of the serialized subtree or string value. These wildcard element or attributes must satisfy the namespace constraints specified in the corresponding `<xs:any>` or `<xs:anyAttribute>` declaration, however, in order to be part of the serialization.

- substitution groups: an error is generated if a member of a substitution group appears in the XML document where the group head appears in the XML schema, for cases when the substitution group members are used not only as the root element of the document.

As a workaround, the element declarations of the substitution group's head and members can instead be changed to a named model group of type `xs:choice`. For example, these substitution group declarations

```
<xs:element name="head" type="BaseType" />
<xs:element name="member1" type="derived1FromBaseType" substitutionGroup="head"/>
<xs:element name="member2" type="derived2FromBaseType" substitutionGroup="head"/>
<xs:element name="member3" type="derived3FromBaseType" substitutionGroup="head"/>
```

can be changed to an equivalent named model group:

```
<xs:group name="mysubstitutiongrp">
  <xs:choice>
    <xs:element name="head" type="BaseType"/>
    <xs:element name="member1" type="derived1FromBaseType"/>
    <xs:element name="member2" type="derived2FromBaseType"/>
    <xs:element name="member3" type="derived3FromBaseType"/>
  </xs:choice>
</xs:group>
```

Occurrences of the `<head>` element can then be replaced with the newly defined named model group in the XML document.

- runtime substitution using `xsi:type`: an element is decomposed according to the mappings in the schema type associated with the element name in the schema. Specifying a different type for an element in the document through the use of `xsi:type` results in an error being returned during decomposition.

Ensure that the type of an element specified with `xsi:type` in the XML document matches the type specified for that element in the context. If the content of the element or its descendants does not need to be decomposed individually, then the type of the element can be changed to `xs:anyType` in the XML schema. With this change, the XML documents do not need to be modified.

- recursive elements: XML schemas containing recursion can be registered in the XML schema repository (XSR) and enabled for decomposition. However, the recursive sections of an associated XML instance document cannot be



decomposed as scalar values into a target table. By using appropriate schema annotations, the recursive sections can be stored and later retrieved as serialized markup.

- updates to or deletion of existing rows in target tables: decomposition only supports the insertion of new rows. (You can still update or delete rows outside of the XML decomposition process.)
- attributes of simple type derived from NOTATION: decomposition inserts only the notation name.
- attributes of type ENTITY: decomposition inserts only the entity name.
- multiple mappings to the same rowSet and column with db2-xdb:expression and db2-xdb:condition: where multiple items can be legally mapped to the same rowSet and column, according to mapping rules, the mappings must not contain the db2-xdb:expression or db2-xdb:condition annotations.
- In a partitioned database environment, annotated XML schema decomposition is supported only on the database partition that contains the database catalog tables (the IBMCATGROUP database partition).

---

## Troubleshooting considerations for annotated XML schema decomposition

If you find that decomposition is not yielding expected results, several issues should be considered.

### General considerations

- Check that the XSR object that corresponds to your XML schema appears as enabled in the DECOMPOSITION column of the SYSCAT.XSROBJECTS catalog view. If the XSR object is not enabled, consider taking the corrective actions described in the disablement documentation.
- Ensure that the limits and restrictions for XML decomposition are not violated.
- Ensure that the XML document is valid according to its XML schema. Validation is not a requirement for decomposition, however, if you expect certain behavior, such as character entity expansion, then perform decomposition with validation.

### XML schema issues

- Ensure that XML schema does not contain errors such as non-deterministic content models, as these types of errors can cause decomposition to fail when validation is performed, or undefined decomposition results if validation is not performed.
- Ensure that the non-global annotations have been declared only on element or attribute declarations and not on complex types, element/attribute references, model groups or any other xml schema construct. Also check that the annotations are declared in their supported format: as attributes, elements, or global annotations. (Refer to the documentation on each annotation for details of how to specify an annotation.)
- Ensure that complex types derived by extension or restriction are annotated properly.

### Specific errors

Adjusting database configuration parameters can resolve the following errors:

- SQL0954C received when the annotated XML schema contains a large number of rowSets: increase the application heap size using the `applheapsz` configuration parameter
- SQL0954C received when the annotated XML schema contains complex or many expressions in each rowSet: increase the application heap size using the `applheapsz` configuration parameter
- SQL0964C received when decomposition results in a large number of rows: increase the number of primary or secondary log files available using the `logprimary` and `logsecond` configuration parameters. You can also increase the size of the primary and secondary log files with the `logfilesiz` configuration parameter.

## Locking and concurrency

If you are experiencing lock escalation or deadlock when decomposing documents, adjust concurrency control through your application. If an application makes multiple concurrent invocations of any of the `xdbDecompXML` stored procedures, where many of the same tables are involved in the multiple decomposition operations, then the application needs to manage the concurrent access to these tables to prevent lock escalation and deadlock.

One way to adjust concurrency control is to explicitly lock all tables involved in the decomposition before invoking the `xdbDecompXML` stored procedure. Then execute the `COMMIT` or `ROLLBACK` statements as appropriate after the stored procedure has returned. Because the decomposition of large documents can result in a large number of rows being inserted, and because each row is locked by default during an insert operation, an application that is inserting many rows can hold many row locks, leading to lock escalation. By obtaining table locks instead, you can avoid the overhead of obtaining row locks and of lock escalation.

If the reduced concurrency associated with obtaining table locks is not appropriate for your application, you can increase either or both of the `maxlocks` and `locklist` database configuration parameters, which decreases the likelihood of lock escalation.

Set the `locktimeout` database configuration parameter to prevent an application from waiting indefinitely to obtain a lock.

## Mapping verification in catalog view

If you are still experiencing problems with decomposition after verifying the conditions listed previously, check that the `MAPPINGDESCRIPTION` column of the `SYSCAT.XDBMAPSHREDTREES` catalog view matches the mappings you intended. The `MAPPINGDESCRIPTION` column contains details on how each item in a rowSet was mapped, including:

- target column name
- target column type
- item's XML schema type
- values specified for `db2-xdb:contentHandling`, `db2-xdb:normalization`, `db2-xdb:truncate`, `db2-xdb:expression`, and `db2-xdb:condition`

Note that the columns of `SYSCAT.XDBMAPSHREDTREES` other than `MAPPINGDESCRIPTION` are intended for DB2 customer support.

---

## Schema for XML decomposition annotations

Annotated XML schema decomposition supports a set of decomposition annotations that enable you to specify how XML documents are to be decomposed and inserted into database tables. This topic shows the XML schema for the annotated schema as defined by XML decomposition.

```
<xs:schema xmlns:xs="http://www.w3.org/2001/XMLSchema"
  xmlns="http://www.ibm.com/xmlns/prod/db2/xdB1"
  targetNamespace="http://www.ibm.com/xmlns/prod/db2/xdB1"
  elementFormDefault="qualified" >
  <xs:element name="defaultSQLSchema" type="xs:string"/>
  <xs:attribute name="rowSet" type="xs:string"/>
  <xs:attribute name="column" type="xs:string"/>
  <xs:attribute name="locationPath" type="xs:string"/>
  <xs:attribute name="truncate" type="xs:boolean"/>
  <xs:attribute name="contentHandling">
    <xs:simpleType>
      <xs:restriction base="xs:string">
        <xs:enumeration value="text"/>
        <xs:enumeration value="serializeSubtree"/>
        <xs:enumeration value="stringValue"/>
      </xs:restriction>
    </xs:simpleType>
  </xs:attribute>
  <xs:attribute name="normalization" >
    <xs:simpleType>
      <xs:restriction base="xs:string">
        <xs:enumeration value="original"/>
        <xs:enumeration value="whitespaceStrip"/>
        <xs:enumeration value="canonical"/>
      </xs:restriction>
    </xs:simpleType>
  </xs:attribute>
  <xs:attribute name="expression" type="xs:string"/>
  <xs:attribute name="condition" type="xs:string"/>
  <xs:element name="table">
    <xs:complexType>
      <xs:sequence>
        <xs:element name="SQLSchema" type="xs:string" minOccurs="0"/>
        <xs:element name="name" type="xs:string"/>
        <xs:element name="rowSet" type="xs:string"
          maxOccurs="unbounded" form="qualified"/>
      </xs:sequence>
    </xs:complexType>
  </xs:element>
  <xs:element name="rowSetMapping">
    <xs:complexType>
      <xs:sequence>
        <xs:element name="rowSet" type="xs:string" />
        <xs:element name="column" type="xs:string" minOccurs="0"/>
        <xs:element name="expression" type="xs:string" minOccurs="0" />
        <xs:element name="condition" type="xs:string" minOccurs="0"/>
      </xs:sequence>
      <xs:attribute ref="truncate" />
      <xs:attribute ref="locationPath" />
      <xs:attribute ref="normalization" />
      <xs:attribute ref="contentHandling" />
    </xs:complexType>
  </xs:element>
  <xs:element name="rowSetOperationOrder">
    <xs:complexType>
      <xs:choice minOccurs="1" maxOccurs="1">
        <xs:element name="order" type="orderType" minOccurs="1"
          maxOccurs="unbounded" />
      </xs:choice>
    </xs:complexType>
  </xs:element>
```

```
</xs:element>
<xs:complexType name='orderType'>
  <xs:sequence>
    <xs:element name='rowSet' type='xsd:string' minOccurs='2'
      maxOccurs='unbounded' />
  </xs:sequence>
</xs:complexType>
</xs:schema>
```

---

## Chapter 14. Restrictions on pureXML

---

### Restrictions on the pureXML feature

The pureXML feature is subject to certain restrictions including restrictions on XML column definitions, restrictions when attaching a table to a partitioned table, and restrictions in a partitioned database environment.

#### Restrictions on XML column definitions

XML columns are subject to the following restrictions:

- When creating an index on an XML column, the `GENERATE KEY USING XMLPATTERN` clause must be used, and the index cannot be part of a composite index. Multiple indexes can be created on an XML column.
- XML columns can be referenced in `CHECK` constraints only in conjunction with a `VALIDATED` predicate.
- XML columns cannot have a default value specified by the `WITH DEFAULT` clause; if the column is nullable, the default for the column is `NULL`.
- XML columns cannot be used in a range-clustered table (RCT).
- XML columns cannot be included as columns of keys, including primary, foreign, and unique keys, dimension keys (in the `ORGANIZE BY` clause) of multidimensional clustering (MDC) tables, sequence keys of range-clustered tables, table-partitioning keys of partitioned tables, and distribution keys of a table in a partitioned database environment.
- A partitioned table with XML columns must have at least one non-XML column with a data type that is supported for use as a table-partitioning key column.
- XML columns cannot be included in typed tables and typed views.
- XML columns cannot be referenced in generated columns.
- XML columns cannot be specified in the select-list of scrollable cursors.
- XML columns cause cursor blocking to be disabled when retrieving XML data.
- When dropping XML columns using the `ALTER TABLE` statement, you must drop all of the XML columns in the table in a single `ALTER TABLE` statement.
- For DB2 V9.7 Fix Pack 1 and later releases, distribution statistics can be collected on indexes over XML data defined on an XML column. The following restrictions apply to the collection of distribution statistics on an XML column:
  - Distribution statistics are collected for each index over XML data specified on the XML column. The data type specified for the index must be `VARCHAR`, `DOUBLE`, `INTEGER`, `DECIMAL`, `TIMESTAMP`, or `DATE`. Distribution statistics are not collected for indexes over XML data of type `VARCHAR HASHED`.
  - Distribution statistics for each index over XML data uses a maximum of 250 quantiles as the default. The default can be changed by specifying a value with the `NUM_QUANTILES` parameter in the `ON COLUMNS` or the `DEFAULT` clause when issuing the `RUNSTATS` command. The `num_quantiles` database configuration parameter is ignored while collecting XML distribution statistics.
  - XML distribution statistics are not created when loading data with the `STATISTICS` option.

- XML distribution statistics are not collected for partitioned indexes over XML data defined on a partitioned table.

## Restriction on triggers

In a trigger body of a BEFORE or AFTER trigger, transition variables that reference columns of type XML in affected rows can be used only for validation with the XMLVALIDATE function, to set XML column values to NULL, or to leave XML columns values unchanged.

## Restrictions when attaching partitions to partitioned tables

When using ALTER ATTACH to attach a partition to a partitioned table with XML columns, the INLINE LENGTH of each XML column on the table to attach (the source table) must match with the INLINE LENGTH of the corresponding XML columns on the table attaching to (the target table).

If a table contains XML columns that use the Version 9.5 or earlier XML record format, attaching the table to a partitioned table that contains XML columns that use the Version 9.7 or later record format is not supported. Before attaching the table, you must update the XML record format of the table to match the record format of the target partitioned table. Either of the following two methods updates the XML record format of a table:

- Perform an online table move on table using the ADMIN\_MOVE\_TABLE procedure.
- Perform the following steps:
  1. Use the **EXPORT** command to create a copy of the table data.
  2. Use the TRUNCATE statement to delete all the rows from the table and release the storage allocated to the table.
  3. Use the **LOAD** command to add the data into the table.

After the XML record format of the table has been updated, attach the table to the target partitioned table.

## Restrictions in a partitioned database environment

When using the pureXML feature in a partitioned database environment, the following rules apply:

- An XML column cannot be used as the distribution key. As a result, the following restrictions apply:
  - A table with only XML columns cannot be distributed.
  - A table with a distribution key cannot have primary key, unique constraint, or unique index defined on an XML column.
  - A table with a distribution key with XML columns must have at least one non-XML column with a data type that is supported for use as distribution key.
- If you are loading XML data from XML data files into partitioned tables in parallel, then the XML data files must be read-accessible to all the partitions where loading in parallel is taking place.
- When using a CURSOR file type with the **LOAD** command to load XML data into a multipartition database, the PARTITION\_ONLY and LOAD\_ONLY modes are not supported.

- When using the **REDISTRIBUTE DATABASE PARTITION GROUP** command with the **NOT ROLLFORWARD RECOVERABLE** option, the redistribute operation uses the **INDEXING MODE DEFERRED** option for tables that contain XML columns. If a table does not contain an XML column, the redistribute operation uses the indexing mode specified when issuing the command.
- Tables that contains XML columns that use the Version 9.5 or earlier XML record format cannot be redistributed. Use the **ADMIN\_MOVE\_TABLE** stored procedure to migrate the table to the new format.

## Restriction on data row compression

The **COMPRESS YES** option of the **ALTER TABLE** or **CREATE TABLE** statement enables data row compression for a table. Compression of data in the XML storage object of a table is not supported if the table contains XML columns that use the Version 9.5 or earlier XML record format. If you enable such a table for data row compression, only the table row data in the table object is compressed.

If a table is enabled for data row compression but the XML storage object of the table cannot be compressed during an insert, load, or reorg operation, a message is written to a **db2diag** log file.

To make the data in the XML storage object of the table eligible for compression, use the **ADMIN\_MOVE\_TABLE** stored procedure to migrate the table and then enable data row compression for the migrated table.

## Additional restrictions

**Using serialized XML data:** Although there is no architectural limit on the size of an XML value stored in the database, serialized XML data that is exchanged with the database is effectively limited to 2 GB.

**Using the RUNSTATS command:** If an **ALLOW READ ACCESS** load operation with XML data is completed and leaves a table in set integrity pending state, it is possible to issue a **RUNSTATS** command against this table. In this scenario, the **RUNSTATS** operation cannot see the invisible XML index keys from the previous load operation and returns an error. The workaround is to run the **SET INTEGRITY** statement before the **RUNSTATS** command.

**Using the LOAD command:** When using the **LOAD** command to load XML data, using the **FOR EXCEPTION** clause to specify a load exception table is not supported in the following cases:

- When using label-based access control (LBAC).
- When loading data into a partitioned table.

**Creating indexes on XML columns:** Additional restrictions exist for creating indexes on XML columns and for transforming with XSLT style sheets.

**Using maxOccurs attribute values greater than 5000:** In DB2 Version 9.7 Fix Pack 1 and later, if an XML schema that is registered in the DB2 XSR uses the **maxOccurs** attribute where the value is greater than 5000, the **maxOccurs** attribute value is treated as if you specified "unbounded". Because document elements that have a **maxOccurs** attribute value that is greater than 5000 are processed as if you specified "unbounded", an XML document might pass validation when you use the **XMLVALIDATE** function even if the number of occurrences of an element exceeds

the maximum according to the XML schema that you used to validate the document. For additional information and a suggested workaround, review the XMLVALIDATE function information.

**Using the RESTORE DATABASE command:** You cannot use the **TRANSPORT** option to transport table spaces and SQL schemas if any tables within the schema contains an XML column.



---

## Appendix A. Encoding mappings

---

### Mappings of encoding names to effective CCSIDs for stored XML data

If data that you store in an XML column is in a binary application variable, or is an internally encoded XML type, the DB2 database manager examines the data to determine the encoding. If the data has an encoding declaration, the database manager maps the encoding name to a CCSID.

Table 39 on page 323 lists these mappings. If an encoding name is not in Table 39 on page 323, the database manager returns an error.

The normalized encoding name in the first column of Table 39 on page 323 is the result of converting the encoding name to uppercase, and stripping out all hyphens, plus signs, underscores, colons, periods, and spaces. For example, ISO88591 is the normalized encoding name for ISO 8859-1, ISO-8859-1, and iso-8859-1.

*Table 74. Encoding names and effective CCSIDs*

Normalized encoding name	CCSID
437	437
646	367
813	813
819	819
850	850
852	852
855	855
857	857
862	862
863	863
866	866
869	869
885913	901
885915	923
88591	819
88592	912
88595	915
88597	813
88598	62210
88599	920
904	904
912	912
915	915
916	916

Table 74. Encoding names and effective CCSIDs (continued)

Normalized encoding name	CCSID
920	920
923	923
ANSI1251	1251
ANSIX341968	367
ANSIX341986	367
ARABIC	1089
ASCII7	367
ASCII	367
ASMO708	1089
BIG5	950
CCSID00858	858
CCSID00924	924
CCSID01140	1140
CCSID01141	1141
CCSID01142	1142
CCSID01143	1143
CCSID01144	1144
CCSID01145	1145
CCSID01146	1146
CCSID01147	1147
CCSID01148	1148
CCSID01149	1149
CP00858	858
CP00924	924
CP01140	1140
CP01141	1141
CP01142	1142
CP01143	1143
CP01144	1144
CP01145	1145
CP01146	1146
CP01147	1147
CP01148	1148
CP01149	1149
CP037	37
CP1026	1026
CP1140	1140
CP1141	1141
CP1142	1142
CP1143	1143

Table 74. Encoding names and effective CCSIDs (continued)

Normalized encoding name	CCSID
CP1144	1144
CP1145	1145
CP1146	1146
CP1147	1147
CP1148	1148
CP1149	1149
CP1250	1250
CP1251	1251
CP1252	1252
CP1253	1253
CP1254	1254
CP1255	1255
CP1256	1256
CP1257	1257
CP1258	1258
CP1363	1363
CP1383	1383
CP1386	1386
CP273	273
CP277	277
CP278	278
CP280	280
CP284	284
CP285	285
CP297	297
CP33722	954
CP33722C	954
CP367	367
CP420	420
CP423	423
CP424	424
CP437	437
CP500	500
CP5346	5346
CP5347	5347
CP5348	5348
CP5349	5349
CP5350	5350
CP5353	5353
CP813	813

Table 74. Encoding names and effective CCSIDs (continued)

Normalized encoding name	CCSID
CP819	819
CP838	838
CP850	850
CP852	852
CP855	855
CP857	857
CP858	858
CP862	862
CP863	863
CP864	864
CP866	866
CP869	869
CP870	870
CP871	871
CP874	874
CP904	904
CP912	912
CP915	915
CP916	916
CP920	920
CP921	921
CP922	922
CP923	923
CP936	1386
CP943	943
CP943C	943
CP949	970
CP950	950
CP964	964
CP970	970
CPGR	869
CSASCII	367
CSBIG5	950
CSEBCDICAFR	500
CSEBCDICDKNO	277
CSEBCDICES	284
CSEBCDICFISE	278
CSEBCDICFR	297
CSEBCDICIT	280
CSEBCDICPT	37

Table 74. Encoding names and effective CCSIDs (continued)

Normalized encoding name	CCSID
CSEBCDICUK	285
CSEBCDICUS	37
CSEUCKR	970
CSEUCPKDFMTJAPANESE	954
CSGB2312	1383
CSHPROMAN8	1051
CSIBM037	37
CSIBM1026	1026
CSIBM273	273
CSIBM277	277
CSIBM278	278
CSIBM280	280
CSIBM284	284
CSIBM285	285
CSIBM297	297
CSIBM420	420
CSIBM423	423
CSIBM424	424
CSIBM500	500
CSIBM855	855
CSIBM857	857
CSIBM863	863
CSIBM864	864
CSIBM866	866
CSIBM869	869
CSIBM870	870
CSIBM871	871
CSIBM904	904
CSIBMEBCDICATDE	273
CSIBMTHAI	838
CSISO128T101G2	920
CSISO146SERBIAN	915
CSISO147MACEDONIAN	915
CSISO2INTLREFVERSION	367
CSISO646BASIC1983	367
CSISO88596I	1089
CSISO88598I	916
CSISOLATIN0	923
CSISOLATIN1	819
CSISOLATIN2	912

Table 74. Encoding names and effective CCSIDs (continued)

Normalized encoding name	CCSID
CSISOLATIN5	920
CSISOLATIN9	923
CSISOLATINARABIC	1089
CSISOLATINCYRILLIC	915
CSISOLATINGREEK	813
CSISOLATINHEBREW	62210
CSKOI8R	878
CSKSC56011987	970
CSMACINTOSH	1275
CSMICROSOFTPUBLISHING	1004
CSPC850MULTILINGUAL	850
CSPC862LATINHEBREW	862
CSPC8CODEPAGE437	437
CSPCP852	852
CSSHIFTJIS	943
CSUCS4	1236
CSUNICODE11	1204
CSUNICODE	1204
CSUNICODEASCII	1204
CSUNICODELATIN1	1204
CSVISCII	1129
CSWINDOWS31J	943
CYRILLIC	915
DEFAULT	367
EBCDICATDE	273
EBCDICCAFR	500
EBCDICCPAR1	420
EBCDICCPBE	500
EBCDICCPCA	37
EBCDICCPCH	500
EBCDICCPDK	277
EBCDICCPES	284
EBCDICCPFI	278
EBCDICPPFR	297
EBCDICCPGB	285
EBCDICCPGR	423
EBCDICPPHE	424
EBCDICPPIS	871
EBCDICPPIT	280
EBCDICPNL	37

Table 74. Encoding names and effective CCSIDs (continued)

Normalized encoding name	CCSID
EBCDICPNO	277
EBCDICPROECE	870
EBCDICPSE	278
EBCDICPUS	37
EBCDICPWT	37
EBCDICPYU	870
EBCDICDE273EURO	1141
EBCDICDK277EURO	1142
EBCDICDKNO	277
EBCDICES284EURO	1145
EBCDICES	284
EBCDICFI278EURO	1143
EBCDICFISE	278
EBCDICFR297EURO	1147
EBCDICFR	297
EBCDICGB285EURO	1146
EBCDICINTERNATIONAL500EURO	1148
EBCDICIS871EURO	1149
EBCDIT280EURO	1144
EBCDIT	280
EBCDICLATIN9EURO	924
EBCDICNO277EURO	1142
EBCDICPT	37
EBCDICSE278EURO	1143
EBCDICUK	285
EBCDICUS37EURO	1140
EBCDICUS	37
ECMA114	1089
ECMA118	813
ELOT928	813
EUCCN	1383
EUCJP	954
EUCKR	970
EUCTW	964
EXTENDEDUNIXCODEPACKEDFORMATFORJAPANESE	954
GB18030	1392
GB2312	1383
GBK	1386
GREEK8	813
GREEK	813

Table 74. Encoding names and effective CCSIDs (continued)

Normalized encoding name	CCSID
HEBREW	62210
HPROMAN8	1051
IBM00858	858
IBM00924	924
IBM01140	1140
IBM01141	1141
IBM01142	1142
IBM01143	1143
IBM01144	1144
IBM01145	1145
IBM01146	1146
IBM01147	1147
IBM01148	1148
IBM01149	1149
IBM01153	1153
IBM01155	1155
IBM01160	1160
IBM037	37
IBM1026	1026
IBM1043	1043
IBM1047	1047
IBM1252	1252
IBM273	273
IBM277	277
IBM278	278
IBM280	280
IBM284	284
IBM285	285
IBM297	297
IBM367	367
IBM420	420
IBM423	423
IBM424	424
IBM437	437
IBM500	500
IBM808	808
IBM813	813
IBM819	819
IBM850	850
IBM852	852



Table 74. Encoding names and effective CCSIDs (continued)

Normalized encoding name	CCSID
IBM855	855
IBM857	857
IBM862	862
IBM863	863
IBM864	864
IBM866	866
IBM867	867
IBM869	869
IBM870	870
IBM871	871
IBM872	872
IBM902	902
IBM904	904
IBM912	912
IBM915	915
IBM916	916
IBM920	920
IBM921	921
IBM922	922
IBM923	923
IBMTHAI	838
IRV	367
ISO10646	1204
ISO10646UCS2	1200
ISO10646UCS4	1232
ISO10646UCSBASIC	1204
ISO10646UNICODELATIN1	1204
ISO646BASIC1983	367
ISO646IRV1983	367
ISO646IRV1991	367
ISO646US	367
ISO885911987	819
ISO885913	901
ISO885915	923
ISO885915FDIS	923
ISO88591	819
ISO885921987	912
ISO88592	912
ISO885951988	915
ISO88595	915

Table 74. Encoding names and effective CCSIDs (continued)

Normalized encoding name	CCSID
ISO885961987	1089
ISO88596	1089
ISO88596I	1089
ISO885971987	813
ISO88597	813
ISO885981988	62210
ISO88598	62210
ISO88598I	916
ISO885991989	920
ISO88599	920
ISOIR100	819
ISOIR101	912
ISOIR126	813
ISOIR127	1089
ISOIR128	920
ISOIR138	62210
ISOIR144	915
ISOIR146	915
ISOIR147	915
ISOIR148	920
ISOIR149	970
ISOIR2	367
ISOIR6	367
JUSIB1003MAC	915
JUSIB1003SERB	915
KOI8	878
KOI8R	878
KOI8U	1168
KOREAN	970
KSC56011987	970
KSC56011989	970
KSC5601	970
L1	819
L2	912
L5	920
L9	923
LATIN0	923
LATIN1	819
LATIN2	912
LATIN5	920

Table 74. Encoding names and effective CCSIDs (continued)

Normalized encoding name	CCSID
LATIN9	923
MAC	1275
MACEDONIAN	915
MACINTOSH	1275
MICROSOFTPUBLISHING	1004
MS1386	1386
MS932	943
MS936	1386
MS949	970
MSKANJI	943
PCMULTILINGUAL850EURO	858
R8	1051
REF	367
ROMAN8	1051
SERBIAN	915
SHIFTJIS	943
SJIS	943
SUNEUGREEK	813
T101G2	920
TIS20	874
TIS620	874
UNICODE11	1204
UNICODE11UTF8	1208
UNICODEBIGUNMARKED	1200
UNICODELITTLEUNMARKED	1202
US	367
USASCII	367
UTF16	1204
UTF16BE	1200
UTF16LE	1202
UTF32	1236
UTF32BE	1232
UTF32LE	1234
UTF8	1208
VISCII	1129
WINDOWS1250	1250
WINDOWS1251	1251
WINDOWS1252	1252
WINDOWS1253	1253
WINDOWS1254	1254

Table 74. Encoding names and effective CCSIDs (continued)

Normalized encoding name	CCSID
WINDOWS1255	1255
WINDOWS1256	1256
WINDOWS1257	1257
WINDOWS1258	1258
WINDOWS28598	62210
WINDOWS31J	943
WINDOWS936	1386
XEUCTW	964
XMSWIN936	1386
XUTF16BE	1200
XUTF16LE	1202
XWINDOWS949	970

## Mappings of CCSIDs to encoding names for serialized XML output data

As part of an implicit or explicit XMLSERIALIZE operation, the DB2 database manager might add an encoding declaration at the beginning of serialized XML output data.

That declaration has the following form:

```
<?xml version="1.0" encoding="encoding-name"?>
```

In general, the character set identifier in the encoding declaration describes the encoding of the characters in the output string. For example, when XML data is serialized to the CCSID that corresponds to the target application data type, the encoding declaration describes the target application variable CCSID. An exception is the case where the application performs an explicit XMLSERIALIZE function with INCLUDING XMLDECLARATION. When you specify INCLUDING XMLDECLARATION, the database manager generates an encoding declaration for UTF-8. If the target data type is a CLOB or DBCLOB type, additional code page conversion might occur, which can make the encoding information inaccurate. If the data is further parsed in the application, data corruption can result.

Where possible, the DB2 database manager chooses the IANA registry name for the CCSID, as prescribed by the XML standard.

Table 75. CCSIDs and corresponding encoding names

CCSID	Encoding name
37	IBM037
273	IBM273
277	IBM277
278	IBM278
280	IBM280
284	IBM284

Table 75. CCSIDs and corresponding encoding names (continued)

CCSID	Encoding name
285	IBM285
297	IBM297
367	US-ASCII
420	IBM420
423	IBM423
424	IBM424
437	IBM437
500	IBM500
808	IBM808
813	ISO-8859-7
819	ISO-8859-1
838	IBM-Thai
850	IBM850
852	IBM852
855	IBM855
857	IBM857
858	IBM00858
862	IBM862
863	IBM863
864	IBM864
866	IBM866
867	IBM867
869	IBM869
870	IBM870
871	IBM871
872	IBM872
874	TIS-620
878	KOI8-R
901	ISO-8859-13
902	IBM902
904	IBM904
912	ISO-8859-2
915	ISO-8859-5
916	ISO-8859-8-I
920	ISO-8859-9
921	IBM921
922	IBM922
923	ISO-8859-15
924	IBM00924
932	Shift_JIS

Table 75. CCSIDs and corresponding encoding names (continued)

CCSID	Encoding name
943	Windows-31J
949	EUC-KR
950	Big5
954	EUC-JP
964	EUC-TW
970	EUC-KR
1004	Microsoft-Publish
1026	IBM1026
1043	IBM1043
1047	IBM1047
1051	hp-roman8
1089	ISO-8859-6
1129	VISCII
1140	IBM01140
1141	IBM01141
1142	IBM01142
1143	IBM01143
1144	IBM01144
1145	IBM01145
1146	IBM01146
1147	IBM01147
1148	IBM01148
1149	IBM01149
1153	IBM01153
1155	IBM01155
1160	IBM-Thai
1161	TIS-620
1162	TIS-620
1163	VISCII
1168	KOI8-U
1200	UTF-16BE
1202	UTF-16LE
1204	UTF-16
1208	UTF-8
1232	UTF-32BE
1234	UTF-32LE
1236	UTF-32
1250	windows-1250
1251	windows-1251
1252	windows-1252

Table 75. CCSIDs and corresponding encoding names (continued)

CCSID	Encoding name
1253	windows-1253
1254	windows-1254
1255	windows-1255
1256	windows-1256
1257	windows-1257
1258	windows-1258
1275	MACINTOSH
1363	KSC_5601
1370	Big5
1381	GB2312
1383	GB2312
1386	GBK
1392	GB18030
4909	ISO-8859-7
5039	Shift_JIS
5346	windows-1250
5347	windows-1251
5348	windows-1252
5349	windows-1253
5350	windows-1254
5351	windows-1255
5352	windows-1256
5353	windows-1257
5354	windows-1258
5488	GB18030
8612	IBM420
8616	IBM424
9005	ISO-8859-7
12712	IBM424
13488	UTF-16BE
13490	UTF-16LE
16840	IBM420
17248	IBM864
17584	UTF-16BE
17586	UTF-16LE
62209	IBM862
62210	ISO-8859-8
62211	IBM424
62213	IBM862
62215	ISO-8859-8

Table 75. CCSIDs and corresponding encoding names (continued)

<b>CCSID</b>	<b>Encoding name</b>
62218	IBM864
62221	IBM862
62222	ISO-8859-8
62223	windows-1255
62224	IBM420
62225	IBM864
62227	ISO-8859-6
62228	windows-1256
62229	IBM424
62231	IBM862
62232	ISO-8859-8
62233	IBM420
62234	IBM420
62235	IBM424
62237	windows-1255
62238	ISO-8859-8-I
62239	windows-1255
62240	IBM424
62242	IBM862
62243	ISO-8859-8-I
62244	windows-1255
62245	IBM424
62250	IBM420



---

## Appendix B. SQL/XML publishing functions

The following sections describe the syntax for the DB2 SQL/XML publishing functions.

For information about using the functions, see “SQL/XML publishing functions for constructing XML values” on page 118.

---

### XMLAGG

The XMLAGG function returns an XML sequence containing an item for each non-null value in a set of XML values.

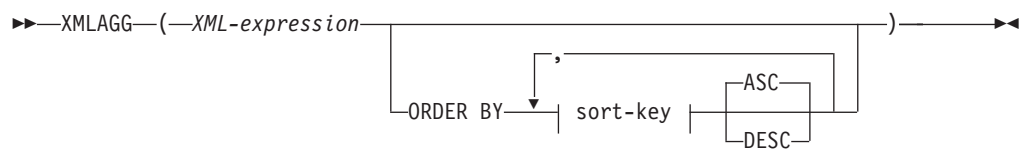

The schema is SYSIBM. The function name cannot be specified as a qualified name.

*XML-expression*

Specifies an expression of data type XML.

#### ORDER BY

Specifies the order of the rows from the same grouping set that are processed in the aggregation. If the ORDER BY clause is omitted, or if the ORDER BY clause cannot distinguish the order of the column data, the rows in the same grouping set are arbitrarily ordered.

*sort-key*

The sort key can be a column name or a *sort-key-expression*. Note that if the sort key is a constant, it does not refer to the position of the output column (as in the ordinary ORDER BY clause), but it is simply a constant, which implies no sort key.

The data type of the result is XML.

The function is applied to the set of values derived from the argument values by the elimination of null values.

If the *XML-expression* argument can be null, the result can be null. If the set of values is empty, the result is the null value. Otherwise, the result is an XML sequence containing an item for each value in the set.

If a SELECT clause includes an ARRAY\_AGG function, then all invocations of ARRAY\_AGG, LISTAGG, XMLAGG, and XMLGROUP functions in the same SELECT clause must specify the same order or not specify an order (SQLSTATE 428GZ).

#### Notes

- **Support in OLAP expressions:** XMLAGG cannot be used as a column function of an OLAP aggregation function (SQLSTATE 42601).

## Example

Construct a department element for each department, containing a list of employees sorted by last name.

```
SELECT XMLSERIALIZE(  
  CONTENT XMLELEMENT(  
    NAME "Department", XMLATTRIBUTES(  
      E.WORKDEPT AS "name"  
    ),  
    XMLAGG(  
      XMLELEMENT(  
        NAME "emp", E.LASTNAME  
      )  
    ORDER BY E.LASTNAME  
  )  
  )  
  AS CLOB(110)  
)  
AS "dept_list"  
FROM EMPLOYEE E  
WHERE E.WORKDEPT IN ('C01','E21')  
GROUP BY WORKDEPT
```

This query produces the following result:

```
dept_list  
-----  
<Department name="C01">  
  <emp>KWAN</emp>  
  <emp>NICHOLLS</emp>  
  <emp>QUINTANA</emp>  
</Department>  
<Department name="E21">  
  <emp>GOUNOT</emp>  
  <emp>LEE</emp>  
  <emp>MEHTA</emp>  
  <emp>SPENSER</emp>  
</Department>
```

**Note:** XMLAGG does not insert blank spaces or new line characters in the output. All example output has been formatted to enhance readability.

---

## XMLATTRIBUTES

The XMLATTRIBUTES function constructs XML attributes from the arguments.

►► XMLATTRIBUTES ◄◄

► ( ◄ attribute-value-expression AS attribute-name ◄ ) ◄◄

The schema is SYSIBM. The function name cannot be specified as a qualified name.

This function can only be used as an argument of the XMLELEMENT function. The result is an XML sequence containing an XQuery attribute node for each non-null input value.

### *attribute-value-expression*

An expression whose result is the attribute value. The data type of *attribute-value-expression* cannot be a structured type (SQLSTATE 42884). The expression can be any SQL expression. If the expression is not a simple column reference, an attribute name must be specified.

### *attribute-name*

Specifies an attribute name. The name is an SQL identifier that must be in the form of an XML qualified name, or QName (SQLSTATE 42634). See the W3C XML namespace specifications for more details on valid names. The attribute name cannot be `xmlns` or prefixed with `xmlns:`. A namespace is declared using the function `XMLNAMESPACES`. Duplicate attribute names, whether implicit or explicit, are not allowed (SQLSTATE 42713).

If *attribute-name* is not specified, *attribute-value-expression* must be a column name (SQLSTATE 42703). The attribute name is created from the column name using the fully escaped mapping from a column name to an XML attribute name.

The data type of the result is XML. If the result of *attribute-value-expression* can be null, the result can be null; if the result of every *attribute-value-expression* is null, the result is the null value.

## Examples

**Note:** `XMLATTRIBUTES` does not insert blank spaces or new line characters in the output. All example output has been formatted to enhance readability.

- *Example 1:* Produce an element with attributes.

```
SELECT E.EMPNO, XMLELEMENT(
  NAME "Emp",
  XMLATTRIBUTES(
    E.EMPNO, E.FIRSTNAME || ' ' || E.LASTNAME AS "name"
  )
)
AS "Result"
FROM EMPLOYEE E WHERE E.EDLEVEL = 12
```

This query produces the following result:

```
EMPNO Result
000290 <Emp EMPNO="000290" name="JOHN PARKER"></Emp>
000310 <Emp EMPNO="000310" name="MAUDE SETRIGHT"></Emp>
200310 <Emp EMPNO="200310" name="MICHELLE SPRINGER"></Emp>
```

- *Example 2:* Produce an element with a namespace declaration that is not used in any QName. The prefix is used in an attribute value.

```
VALUES XMLELEMENT(
  NAME "size",
  XMLNAMESPACES(
    'http://www.w3.org/2001/XMLSchema-instance' AS "xsi",
    'http://www.w3.org/2001/XMLSchema' AS "xsd"
  ),
  XMLATTRIBUTES(
    'xsd:string' AS "xsi:type"
  ), '1'
)
```

This query produces the following result:

```
<size xmlns:xsi="http://www.w3.org/2001/XMLSchema-instance"
xmlns:xsd="http://www.w3.org/2001/XMLSchema"
xsi:type="xsd:string">1</size>
```

---

## XMLCOMMENT

The XMLCOMMENT function returns an XML value with a single XQuery comment node with the input argument as the content.

►►XMLCOMMENT(—*string-expression*—)◄◄

The schema is SYSIBM. The function name cannot be specified as a qualified name.

### *string-expression*

An expression whose value has a character string type: CHAR, VARCHAR or CLOB. The result of the *string-expression* is parsed to check for conformance to the requirements for an XML comment, as specified in the XML 1.0 rule. The result of the *string-expression* must conform to the following regular expression:

((Char - '-' ) | ('-' (Char - '-')))\*

where Char is defined as any Unicode character excluding surrogate blocks X'FFFE' and X'FFFF'. Basically, the XML comment cannot contain two adjacent hyphens, and cannot end with a hyphen (SQLSTATE 2200S).

The data type of the result is XML. If the result of *string-expression* can be null, the result can be null; if the input value is null, the result is the null value.

---

## XMLCONCAT

The XMLCONCAT function returns a sequence containing the concatenation of a variable number of XML input arguments.

►►XMLCONCAT(—*XML-expression*—, —*XML-expression*—)◄◄

The schema is SYSIBM. The function name cannot be specified as a qualified name.

### *XML-expression*

Specifies an expression of data type XML.

The data type of the result is XML. The result is an XML sequence containing the concatenation of the non-null input XML values. Null values in the input are ignored. If the result of any *XML-expression* can be null, the result can be null; if the result of every input value is null, the result is the null value.

### Example

**Note:** XMLCONCAT does not insert blank spaces or new line characters in the output. All example output has been formatted to enhance readability.

Construct a department element for departments A00 and B01, containing a list of employees sorted by first name. Include an introductory comment immediately preceding the department element.

```
SELECT XMLCONCAT(  
  XMLCOMMENT(  
    'Confirm these employees are on track for their product schedule'  
  ),  
  XMLELEMENT(  
    'DEPARTMENT'  
  )
```

```

        NAME "Department",
        XMLATTRIBUTES(
            E.WORKDEPT AS "name"
        ),
        XMLAGG(
            XMLELEMENT(
                NAME "emp", E.FIRSTNME
            )
        )
        ORDER BY E.FIRSTNME
    )
)
)
FROM EMPLOYEE E
WHERE E.WORKDEPT IN ('A00', 'B01')
GROUP BY E.WORKDEPT

```

This query produces the following result:

```

<!--Confirm these employees are on track for their product schedule-->
<Department name="A00">
<emp>CHRISTINE</emp>
<emp>DIAN</emp>
<emp>GREG</emp>
<emp>SEAN</emp>
<emp>VINCENZO</emp>
</Department>
<!--Confirm these employees are on track for their product schedule-->
<Department name="B01">
<emp>MICHAEL</emp>
</Department>

```

---

## XMLDOCUMENT

The XMLDOCUMENT function returns an XML value with a single XQuery document node with zero or more children nodes.

►► XMLDOCUMENT (—XML-expression—) ◀◀

The schema is SYSIBM. The function name cannot be specified as a qualified name.

### *XML-expression*

An expression that returns an XML value. A sequence item in the XML value must not be an attribute node (SQLSTATE 10507).

The data type of the result is XML. If the result of *XML-expression* can be null, the result can be null; if the input value is null, the result is the null value.

The children of the resulting document node are constructed as described in the following steps. The input expression is a sequence of nodes or atomic values, which is referred to in these steps as the content sequence.

1. If the content sequence contains a document node, the document node is replaced in the content sequence by the children of the document node.
2. Each adjacent sequence of one or more atomic values in the content sequence are replaced with a text node containing the result of casting each atomic value to a string with a single blank character inserted between adjacent values.
3. For each node in the content sequence, a new deep copy of the node is constructed. A deep copy of a node is a copy of the whole subtree rooted at that node, including the node itself and its descendants. Each copied node has a new node identity.

- The nodes in the content sequence become the children of the new document node.

The XMLDOCUMENT function effectively executes the XQuery computed document constructor. The result of

```
XMLQUERY('document {$E}' PASSING BY REF XML-expression AS "E")
```

is equivalent to

```
XMLDOCUMENT( XML-expression )
```

with the exception of the case where *XML-expression* is null and XMLQUERY returns the empty sequence compared to XMLDOCUMENT which returns the null value.

## Example

Insert a constructed document into an XML column.

```
INSERT INTO T1 VALUES(
  123, (
    SELECT XMLDOCUMENT(
      XMLELEMENT(
        NAME "Emp", E.FIRSTNAME || ' ' || E.LASTNAME, XMLCOMMENT(
          'This is just a simple example'
        )
      )
    )
  )
  FROM EMPLOYEE E
  WHERE E.EMPNO = '000120'
)
```

---

## XMLEMENT

The XMLEMENT function returns an XML value that is an XQuery element node.

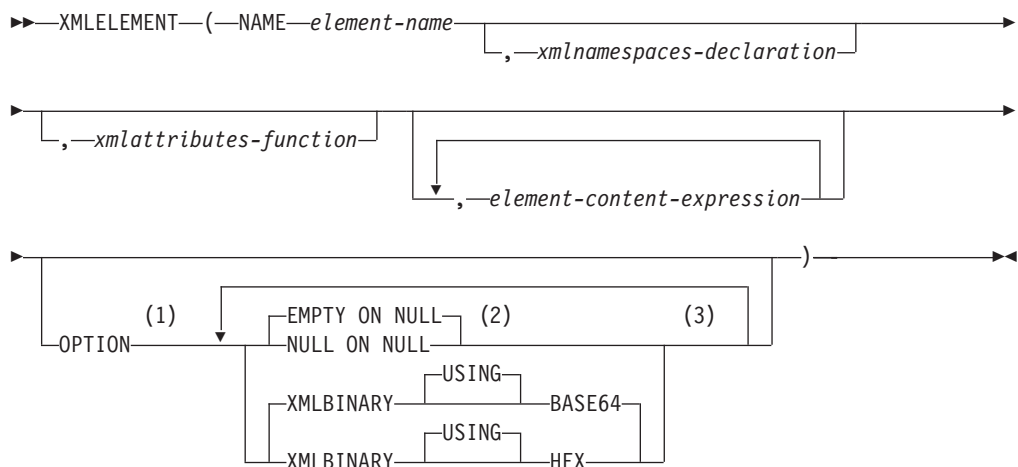

### Notes:

- The *OPTION* clause can only be specified if at least one *xmlattributes-function* or *element-content-expression* is specified.

- 2 NULL ON NULL or EMPTY ON NULL can only be specified if at least one *element-content-expression* is specified.
- 3 The same clause must not be specified more than once.

The schema is SYSIBM. The function name cannot be specified as a qualified name.

**NAME** *element-name*

Specifies the name of an XML element. The name is an SQL identifier that must be in the form of an XML qualified name, or QName (SQLSTATE 42634). See the W3C XML namespace specifications for more details on valid names. If the name is qualified, the namespace prefix must be declared within the scope (SQLSTATE 42635).

*xmlnamespaces-declaration*

Specifies the XML namespace declarations that are the result of the XMLNAMESPACES declaration. The namespaces that are declared are in the scope of the XMLELEMENT function. The namespaces apply to any nested XML functions within the XMLELEMENT function, regardless of whether or not they appear inside another subselect.

If *xmlnamespaces-declaration* is not specified, namespace declarations are not associated with the constructed element.

*xmlattributes-function*

Specifies the XML attributes for the element. The attributes are the result of the XMLATTRIBUTES function.

*element-content-expression*

The content of the generated XML element node is specified by an expression or a list of expressions. The data type of *element-content-expression* cannot be a structured type (SQLSTATE 42884). The expression can be any SQL expression.

If *element-content-expression* is not specified, an empty string is used as the content for the element and OPTION NULL ON NULL or EMPTY ON NULL must not be specified.

**OPTION**

Specifies additional options for constructing the XML element. If no OPTION clause is specified, the default is EMPTY ON NULL XMLBINARY USING BASE64. This clause has no impact on nested XMLELEMENT invocations specified in *element-content-expression*.

**EMPTY ON NULL or NULL ON NULL**

Specifies whether a null value or an empty element is to be returned if the values of each *element-content-expression* is a null value. This option only affects null handling of element contents, not attribute values. The default is EMPTY ON NULL.

**EMPTY ON NULL**

If the value of each *element-content-expression* is null, an empty element is returned.

**NULL ON NULL**

If the value of each *element-content-expression* is null, a null value is returned.

**XMLBINARY USING BASE64 or XMLBINARY USING HEX**

Specifies the assumed encoding of binary input data, character string data with the FOR BIT DATA attribute, or a distinct type that is based on one of these types. The encoding applies to element content or attribute values. The default is XMLBINARY USING BASE64.

#### XMLBINARY USING BASE64

Specifies that the assumed encoding is base64 characters, as defined for XML schema type `xs:base64Binary` encoding. The base64 encoding uses a 65-character subset of US-ASCII (10 digits, 26 lowercase characters, 26 uppercase characters, '+', and '/') to represent every six bits of the binary or bit data with one printable character in the subset. These characters are selected so that they are universally representable. Using this method, the size of the encoded data is 33 percent larger than the original binary or bit data.

#### XMLBINARY USING HEX

Specifies that the assumed encoding is hexadecimal characters, as defined for XML schema type `xs:hexBinary` encoding. The hexadecimal encoding represents each byte (8 bits) with two hexadecimal characters. Using this method, the encoded data is twice the size of the original binary or bit data.

This function takes an element name, an optional collection of namespace declarations, an optional collection of attributes, and zero or more arguments that make up the content of the XML element. The result is an XML sequence containing an XML element node or the null value.

The data type of the result is XML. If any of the *element-content-expression* arguments can be null, the result can be null; if all the *element-content-expression* argument values are null and the NULL ON NULL option is in effect, the result is the null value.

#### Notes

- When constructing elements that will be copied as content of another element that defines default namespaces, default namespaces should be explicitly undeclared in the copied element to avoid possible errors that could result from inheriting the default namespace from the new parent element. Predefined namespace prefixes ('`xs`', '`xsi`', '`xml`', and '`sqlxml`') must also be declared explicitly when they are used.
- **Constructing an element node:** The resulting element node is constructed as follows:
  1. The *xmlnamespaces-declaration* adds a set of in-scope namespaces for the constructed element. Each in-scope namespace associates a namespace prefix (or the default namespace) with a namespace URI. The in-scope namespaces define the set of namespace prefixes that are available for interpreting QNames within the scope of the element.
  2. If the *xmlattributes-function* is specified, it is evaluated and the result is a sequence of attribute nodes.
  3. Each *element-content-expression* is evaluated and the result is converted into a sequence of nodes as follows:
    - If the result type is not XML, it is converted to an XML text node whose content is the result of *element-content-expression* mapped to XML according to the rules of mapping SQL data values to XML data values (see the table that describes supported casts from non-XML values to XML values in “Casting between data types”).
    - If the result type is XML, then in general the result is a sequence of items. Some of the items in that sequence might be document nodes. Each document node in the sequence is replaced by the sequence of its top-level children. Then for each node in the resulting sequence, a new deep copy of the node is constructed, including its children and attributes. Each



copied node has a new node identity. Copied element and attribute nodes preserve their type annotation. For each adjacent sequence of one or more atomic values returned in the sequence, a new text node is constructed, containing the result of casting each atomic value to a string, with a single blank character inserted between adjacent values. Adjacent text nodes in the content sequence are merged into a single text node by concatenating their contents, with no intervening blanks. After concatenation, any text node whose content is a zero-length string is deleted from the content sequence.

4. The result sequence of XML attributes and the resulting sequences of all *element-content-expression* specifications are concatenated into one sequence which is called the content sequence. Any sequence of adjacent text nodes in the content sequence is merged into a single text node. If all the *element-content-expression* arguments are empty strings, or an *element-content-expression* argument is not specified, an empty element is returned.
  5. The content sequence must not contain an attribute node following a node that is not an attribute node (SQLSTATE 10507). Attribute nodes occurring in the content sequence become attributes of the new element node. Two or more of these attribute nodes must not have the same name (SQLSTATE 10503). A namespace declaration is created corresponding to any namespace used in the names of the attribute nodes if the namespace URI is not in the in-scope namespaces of the constructed element.
  6. Element, text, comment, and processing instruction nodes in the content sequence become the children of the constructed element node.
  7. The constructed element node is given a type annotation of `xs:anyType`, and each of its attributes is given a type annotation of `xdt:untypedAtomic`. The node name of the constructed element node is `element-name` specified after the NAME keyword.
- **Rules for using namespaces within XMLLEMENT:** Consider the following rules about scoping of namespaces:
    - The namespaces declared in the XMLNAMESPACES declaration are the in-scope namespaces of the element node constructed by the XMLLEMENT function. If the element node is serialized, then each of its in-scope namespaces will be serialized as a namespace attribute unless it is an in-scope namespace of the parent of the element node and the parent element is serialized too.
    - If an XMLQUERY or XMLEXISTS is in an *element-content-expression*, then the namespaces becomes the statically known namespaces of the XQuery expression of the XMLQUERY or XMLEXISTS. Statically known namespaces are used to resolve the QNames in the XQuery expression. If the XQuery prolog declares a namespace with the same prefix, within the scope of the XQuery expression, the namespace declared in the prolog will override the namespaces declared in the XMLNAMESPACES declaration.
    - If an attribute of the constructed element comes from an *element-content-expression*, its namespace might not already be declared as an in-scope namespace of the constructed element, in this case, a new namespace is created for it. If this would result in a conflict, which means that the prefix of the attribute name is already bound to a different URI by a in-scope namespace, DB2 generates a prefix that does not cause such a conflict and the prefix used in the attribute name is changed to the new prefix, and a namespace is created for this new prefix. The generated new prefix follows the following pattern: "db2ns-xx", where "x" is a character chosen from the set [A-Z,a-z,0-9]. For example:

```

VALUES XMLELEMENT(
  NAME "c", XMLQUERY(
    'declare namespace ipo="www.ipo.com"; $m/ipo:a/@ipo:b'
    PASSING XMLPARSE(
      DOCUMENT '<tst:a xmlns:tst="www.ipo.com" tst:b="2"/>'
    ) AS "m"
  )
)

```

returns:

```
<c xmlns:tst="www.ipo.com" tst:b="2"/>
```

A second example:

```

VALUES XMLELEMENT(
  NAME "tst:c", XMLNAMESPACES(
    'www.tst.com' AS "tst"
  ),
  XMLQUERY(
    'declare namespace ipo="www.ipo.com"; $m/ipo:a/@ipo:b'
    PASSING XMLPARSE(
      DOCUMENT '<tst:a xmlns:tst="www.ipo.com" tst:b="2"/>'
    ) AS "m"
  )
)

```

returns:

```
<tst:c xmlns:tst="www.tst.com" xmlns:db2ns-a1="www.ipo.com"
db2ns-a1:b="2"/>
```

## Examples

**Note:** XMLELEMENT does not insert blank spaces or new line characters in the output. All example output has been formatted to enhance readability.

- *Example 1:* Construct an element with the NULL ON NULL option.

```

SELECT E.FIRSTNME, E.LASTNAME, XMLELEMENT(
  NAME "Emp", XMLELEMENT(
    NAME "firstname", E.FIRSTNME
  ),
  XMLELEMENT(
    NAME "lastname", E.LASTNAME
  )
  OPTION NULL ON NULL
)
AS "Result"
FROM EMPLOYEE E
WHERE E.EDLEVEL = 12

```

This query produces the following result:

FIRSTNME	LASTNAME	Emp
JOHN	PARKER	<Emp><firstname>JOHN</firstname> <lastname>PARKER</lastname></Emp>
MAUDE	SETRIGHT	<Emp><firstname>MAUDE</firstname> <lastname>SETRIGHT</lastname></Emp>
MICHELLE	SPRINGER	<Emp><firstname>MICHELLE</firstname> <lastname>SPRINGER</lastname></Emp>

- *Example 2:* Produce an element with a list of elements nested as child elements.

```

SELECT XMLELEMENT(
  NAME "Department", XMLATTRIBUTES(
    E.WORKDEPT AS "name"
  ),
  XMLAGG(

```

```

        XMLELEMENT(
            NAME "emp", E.FIRSTNME
        )
        ORDER BY E.FIRSTNME
    )
)
AS "dept_list"
FROM EMPLOYEE E
WHERE E.WORKDEPT IN ('A00', 'B01')
GROUP BY WORKDEPT

```

This query produces the following result:

```

dept_list
<Department name="A00">
<emp>CHRISTINE</emp>
<emp>SEAN</emp>
<emp>VINCENZO</emp>
</Department>
<Department name="B01">
<emp>MICHAEL</emp>
</Department>

```

- *Example 3:* Creating nested XML elements specifying a default XML element namespace and using a subselect.

```

SELECT XMLELEMENT(
    NAME "root",
    XMLNAMESPACES(DEFAULT 'http://mytest.uri'),
    XMLATTRIBUTES(cid),
    (SELECT
        XMLAGG(
            XMLELEMENT(
                NAME "poid", poid
            )
        )
    FROM purchaseorder
    WHERE purchaseorder.custid = customer.cid
    )
)
FROM customer
WHERE cid = '1002'

```

The statement returns the following XML document with the default element namespace declared in the root element:

```

<root xmlns="http://mytest.uri" CID="1002">
  <poid>5000</poid>
  <poid>5003</poid>
  <poid>5006</poid>
</root>

```

- *Example 4:* Using a common table expression with XML namespaces.

When an XML element is constructed with a common table expression and the element is used elsewhere in the same SQL statement, any namespace declarations should be specified as part of the element construction. The following statement specifies the default XML namespace in both the common table expression that uses the PURCHASEORDER table to create the poid elements and the SELECT statement that uses the CUSTOMER table to create the root element.

```

WITH tempid(id, elem) AS
  (SELECT custid, XMLELEMENT(NAME "poid",
    XMLNAMESPACES(DEFAULT 'http://mytest.uri'),
    poid)
  FROM purchaseorder )
SELECT XMLELEMENT(NAME "root",
  XMLNAMESPACES(DEFAULT 'http://mytest.uri'),

```

```

        XMLATTRIBUTES(cid),
        (SELECT XMLAGG(elem)
         FROM tempid
         WHERE tempid.id = customer.cid )
    )
FROM customer
WHERE cid = '1002'

```

The statement returns the following XML document with a default element namespace declared in the root element.

```

<root xmlns="http://mytest.uri" CID="1002">
  <poid>5000</poid>
  <poid>5003</poid>
  <poid>5006</poid>
</root>

```

In the following statement, the default element namespace is declared only in the SELECT statement that uses the CUSTOMER table to create the root element:

```

WITH tempid(id, elem) AS
  (SELECT custid, XMLELEMENT(NAME "poid", poid)
   FROM purchaseorder )
SELECT XMLELEMENT(NAME "root",
  XMLNAMESPACES(DEFAULT 'http://mytest.uri'),
  XMLATTRIBUTES(cid),
  (SELECT XMLAGG(elem)
   FROM tempid
   WHERE tempid.id = customer.cid )
)
FROM customer
WHERE cid = '1002'

```

The statement returns the following XML document with the default element namespace declared in the root element. Because the poid elements are created in the common table expression without a default element namespace declaration, the default element namespace for the poid elements is not defined. In the XML document, the default element namespace for the poid elements is set to an empty string "" because the default element namespace for the poid elements is not defined, and the poid elements do not belong to the default element namespace of the root element xmlns="http://mytest.uri".

```

<root xmlns="http://mytest.uri" CID="1002">
  <poid xmlns="">5000</poid>
  <poid xmlns="">5003</poid>
  <poid xmlns="">5006</poid>
</root>

```

---

## XMLFOREST

The XMLFOREST function returns an XML value that is a sequence of XQuery element nodes.

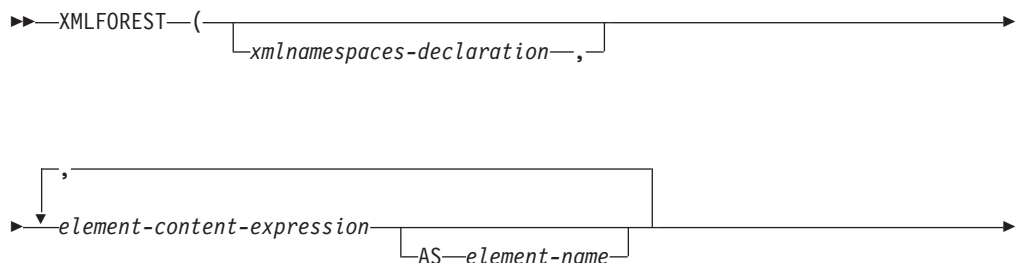

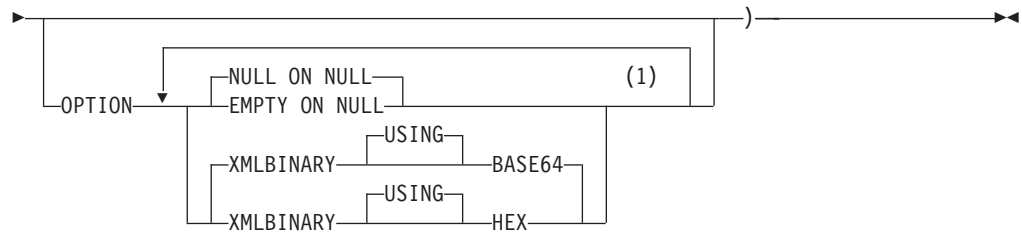

**Notes:**

- 1 The same clause must not be specified more than once.

The schema is SYSIBM. The function name cannot be specified as a qualified name.

*xmlnamespaces-declaration*

Specifies the XML namespace declarations that are the result of the XMLNAMESPACES declaration. The namespaces that are declared are in the scope of the XMLFOREST function. The namespaces apply to any nested XML functions within the XMLFOREST function, regardless of whether or not they appear inside another subselect.

If *xmlnamespaces-declaration* is not specified, namespace declarations are not associated with the constructed elements.

*element-content-expression*

The content of the generated XML element node is specified by an expression. The data type of *element-content-expression* cannot be a structured type (SQLSTATE 42884). The expression can be any SQL expression. If the expression is not a simple column reference, an element name must be specified.

**AS** *element-name*

Specifies the XML element name as an SQL identifier. The element name must be of the form of an XML qualified name, or QName (SQLSTATE 42634). See the W3C XML namespace specifications for more details on valid names. If the name is qualified, the namespace prefix must be declared within the scope (SQLSTATE 42635). If *element-name* is not specified, *element-content-expression* must be a column name (SQLSTATE 42703). The element name is created from the column name using the fully escaped mapping from a column name to an QName.

**OPTION**

Specifies additional options for constructing the XML element. If no OPTION clause is specified, the default is NULL ON NULL XMLBINARY USING BASE64. This clause has no impact on nested XMLELEMENT invocations specified in *element-content-expression*.

**EMPTY ON NULL or NULL ON NULL**

Specifies whether a null value or an empty element is to be returned if the values of each *element-content-expression* is a null value. This option only affects null handling of element contents, not attribute values. The default is NULL ON NULL.

**EMPTY ON NULL**

If the value of each *element-content-expression* is null, an empty element is returned.

#### NULL ON NULL

If the value of each *element-content-expression* is null, a null value is returned.

#### XMLBINARY USING BASE64 or XMLBINARY USING HEX

Specifies the assumed encoding of binary input data, character string data with the FOR BIT DATA attribute, or a distinct type that is based on one of these types. The encoding applies to element content or attribute values. The default is XMLBINARY USING BASE64.

#### XMLBINARY USING BASE64

Specifies that the assumed encoding is base64 characters, as defined for XML schema type `xs:base64Binary` encoding. The base64 encoding uses a 65-character subset of US-ASCII (10 digits, 26 lowercase characters, 26 uppercase characters, '+', and '/') to represent every six bits of the binary or bit data with one printable character in the subset. These characters are selected so that they are universally representable. Using this method, the size of the encoded data is 33 percent larger than the original binary or bit data.

#### XMLBINARY USING HEX

Specifies that the assumed encoding is hexadecimal characters, as defined for XML schema type `xs:hexBinary` encoding. The hexadecimal encoding represents each byte (8 bits) with two hexadecimal characters. Using this method, the encoded data is twice the size of the original binary or bit data.

This function takes an optional set of namespace declarations and one or more arguments that make up the name and element content for one or more element nodes. The result is an XML sequence containing a sequence of XQuery element nodes or the null value.

The data type of the result is XML. If any of the *element-content-expression* arguments can be null, the result can be null; if all the *element-content-expression* argument values are null and the NULL ON NULL option is in effect, the result is the null value.

The XMLFOREST function can be expressed by using XMLCONCAT and XMLELEMENT. For example, the following two expressions are semantically equivalent.

```
XMLFOREST(xmlnamespaces-declaration, arg1 AS name1, arg2 AS name2 ...)  
XMLCONCAT(  
  XMLELEMENT(  
    NAME name1, xmlnamespaces-declaration, arg1  
  ),  
  XMLELEMENT(  
    NAME name2, xmlnamespaces-declaration, arg2  
  )  
  ...  
)
```

#### Notes

- When constructing elements that will be copied as content of another element that defines default namespaces, default namespaces should be explicitly undeclared in the copied element to avoid possible errors that could result from inheriting the default namespace from the new parent element. Predefined namespace prefixes ('`xs`', '`xsi`', '`xml`', and '`sqlxml`') must also be declared explicitly when they are used.

## Example

**Note:** XMLFOREST does not insert blank spaces or new line characters in the output. All example output has been formatted to enhance readability. Construct a forest of elements with a default namespace.

```
SELECT EMPNO,  
       XMLFOREST(  
         XMLNAMESPACES(  
           DEFAULT 'http://hr.org', 'http://fed.gov' AS "d"  
         ),  
         LASTNAME, JOB AS "d:job"  
       )  
AS "Result"  
FROM EMPLOYEE  
WHERE EDLEVEL = 12
```

This query produces the following result:

```
EMPNO Result  
000290 <LASTNAME xmlns="http://hr.org" xmlns:d="http://fed.gov">PARKER  
      </LASTNAME>  
      <d:job xmlns="http://hr.org" xmlns:d="http://fed.gov">OPERATOR</d:job>  
  
000310 <LASTNAME xmlns="http://hr.org" xmlns:d="http://fed.gov">SETRIGHT  
      </LASTNAME>  
      <d:job xmlns="http://hr.org" xmlns:d="http://fed.gov">OPERATOR</d:job>  
  
200310 <LASTNAME xmlns="http://hr.org" xmlns:d="http://fed.gov">SPRINGER  
      </LASTNAME>  
      <d:job xmlns="http://hr.org" xmlns:d="http://fed.gov">OPERATOR</d:job>
```

---

## XMLGROUP

The XMLGROUP function returns an XML value with a single XQuery document node containing one top-level element node. This is an aggregate expression that will return a single-rooted XML document from a group of rows where each row is mapped to a row subelement.

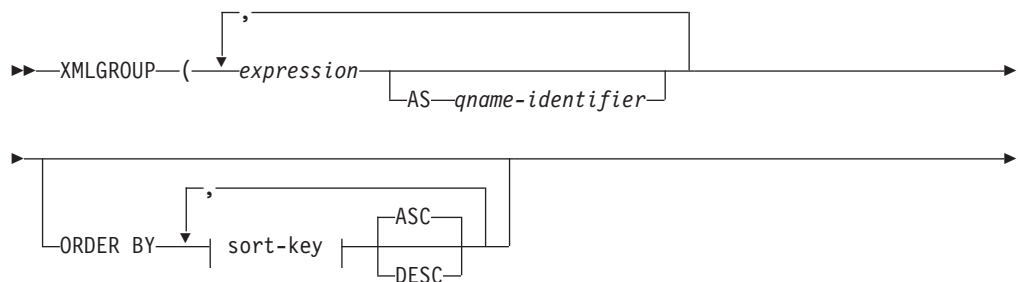

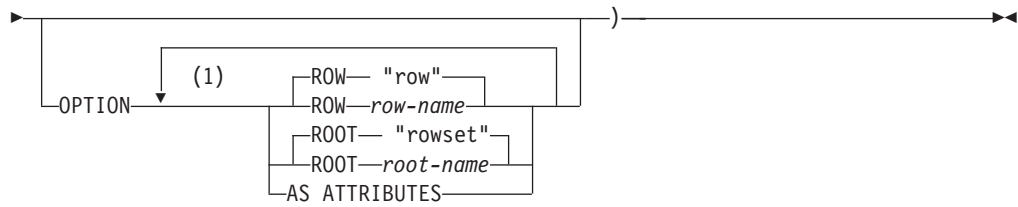

**Notes:**

- 1 The same clause must not be specified more than once.

The schema is SYSIBM. The function name cannot be specified as a qualified name.

*expression*

The content of each generated XML element node (or the value of each generated attribute) is specified by an expression. The data type of *expression* cannot be a structured type (SQLSTATE 42884). The expression can be any SQL expression. If the expression is not a simple column reference, a *qname-identifier* must be specified.

**AS** *qname-identifier*

Specifies the XML element name or attribute name as an SQL identifier. The *qname-identifier* must be of the form of an XML qualified name, or QName (SQLSTATE 42634). See the W3C XML namespace specifications for more details on valid names. If the name is qualified, the namespace prefix must be declared within the scope (SQLSTATE 42635). If *qname-identifier* is not specified, *expression* must be a column name (SQLSTATE 42703). The element name or attribute name is created from the column name using the fully escaped mapping from a column name to an QName.

**OPTION**

Specifies additional options for constructing the XML value. If no OPTION clause is specified, the default behavior applies.

**ROW** *row-name*

Specifies the name of the element to which each row is mapped. If this option is not specified, the default element name is "row".

**ROOT** *root-name*

Specifies the name of the root element node. If this option is not specified, the default root element name is "rowset"

**AS ATTRIBUTES**

Specifies that each expression is mapped to an attribute value with column name or *qname-identifier* serving as the attribute name.

**ORDER BY**

Specifies the order of the rows from the same grouping set that are processed in the aggregation. If the ORDER BY clause is omitted, or if the ORDER BY clause cannot distinguish the order of the column data, the rows in the same grouping set are arbitrarily ordered.

**sort-key**

The sort key can be a column name or a *sort-key-expression*. Note that if the sort key is a constant, it does not refer to the position of the output column (as in the ordinary ORDER BY clause), but it is simply a constant, which implies no sort key.



## Rules

- If a SELECT clause includes an ARRAY\_AGG function, then all invocations of ARRAY\_AGG, LISTAGG, XMLAGG, and XMLGROUP functions in the same SELECT clause must specify the same order or not specify an order (SQLSTATE 428GZ).

## Notes

The default behavior defines a simple mapping between a result set and an XML value. Some additional notes about function behavior apply:

- By default, each row is transformed into an XML element named "row" and each column is transformed into a nested element with the column name serving as the element name.
- The null handling behavior is NULL ON NULL. A null value in a column maps to the absence of the subelement. If all column values are null, no row element will be generated.
- The binary encoding scheme for BLOB and FOR BIT DATA data types is base64Binary encoding.
- By default, the elements corresponding to the rows in a group are children of a root element named "rowset".
- The order of the row subelements in the root element will be the same as the order in which the rows are returned in the query result set.
- A document node will be added implicitly to the root element to make the XML result a well-formed single-rooted XML document

## Examples

The provided examples are based on the following table, T1, with integer columns C1 and C2 that contain numeric data stored in a relational format.

C1	C2
1	2
-	2
1	-
-	-

4 record(s) selected.

- *Example 1:* The following example shows an XMLGroup query and output fragment with default behavior, using a single top-level element to represent the table:

```
SELECT XMLGROUP(C1, C2)FROM T1
```

```
<rowset>
  <row>
    <C1>1</C1>
    <C2>2</C2>
  </row>
  <row>
    <C2>2</C2>
  </row>
  <row>
    <C1>1</C1>
  </row>
</rowset>
```

1 record(s) selected.

- *Example 2:* The following example shows an XMLGroup query and output fragment with attribute centric mapping. Instead of appearing as nested elements as in the previous example, relational data is mapped to element attributes:

```
SELECT XMLGROUP(C1, C2 OPTION AS ATTRIBUTES) FROM T1
```

```
<rowset>
  <row C1="1" C2="2"/>
  <row C2="2"/>
  <row C1="1"/>
</rowset>
```

1 record(s) selected.

- *Example 3:* The following example shows an XMLGroup query and output fragment with the default <rowset> root element replaced by <document> and the default <row> element replaced by <entry>. Columns C1 and C2 are returned as <column1> and <column2> elements, and the return set is ordered by column C1:

```
SELECT XMLGROUP(
  C1 AS "column1", C2 AS "column2"
  ORDER BY C1 OPTION ROW "entry" ROOT "document")
FROM T1
```

```
<document>
  <entry>
    <column1>1</column1>
    <column2>2</column2>
  </entry>
  <entry>
    <column1>1</column1>
  </entry>
  <entry>
    <column2>2</column2>
  </entry>
</document>
```

---

## XMLNAMESPACES

The XMLNAMESPACES declaration constructs namespace declarations from the arguments.

### xmlnamespaces-declaration:

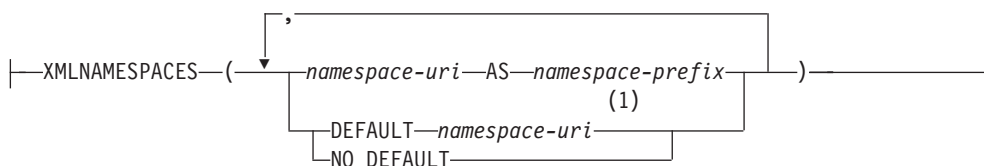

### Notes:

- 1 DEFAULT or NO DEFAULT can only be specified once in arguments of XMLNAMESPACES.

The schema is SYSIBM. The declaration name cannot be specified as a qualified name.

This declaration can only be used as an argument for specific functions such as XMLELEMENT, XMLFOREST and XMLTABLE. The result is one or more XML namespace declarations containing in-scope namespaces for each non-null input value.

*namespace-uri*

Specifies the namespace universal resource identifier (URI) as an SQL character string constant. This character string constant must not be empty if it is used with a *namespace-prefix* (SQLSTATE 42815).

*namespace-prefix*

Specifies a namespace prefix. The prefix is an SQL identifier that must be in the form of an XML NCName (SQLSTATE 42634). See the W3C XML namespace specifications for more details on valid names. The prefix cannot be xml or xmlns and the prefix must be unique within the list of namespace declarations (SQLSTATE 42635).

**DEFAULT** *namespace-uri*

Specifies the default namespace to use within the scope of this namespace declaration. The *namespace-uri* applies for unqualified names in the scope unless overridden in a nested scope by another DEFAULT declaration or a NO DEFAULT declaration.

**NO DEFAULT**

Specifies that no default namespace is to be used within the scope of this namespace declaration. There is no default namespace in the scope unless overridden in a nested scope by a DEFAULT declaration.

The data type of the result is XML. The result is an XML namespace declaration for each specified namespace. The result cannot be null.

## Examples

**Note:** XMLNAMESPACES does not insert blank spaces or new line characters in the output. All example output has been formatted to enhance readability.

- *Example 1:* Produce an XML element named adm:employee and an XML attribute adm:department, both associated with a namespace whose prefix is adm.

```
SELECT EMPNO, XMLELEMENT(  
  NAME "adm:employee", XMLNAMESPACES(  
    'http://www.adm.com' AS "adm"  
  ),  
  XMLATTRIBUTES(  
    WORKDEPT AS "adm:department"  
  ),  
  LASTNAME  
)  
FROM EMPLOYEE  
WHERE JOB = 'ANALYST'
```

This query produces the following result:

```
000130 <adm:employee xmlns:adm="http://www.adm.com" adm:department="C01">  
  QUINTANA</adm:employee>  
000140 <adm:employee xmlns:adm="http://www.adm.com" adm:department="C01">  
  NICHOLLS</adm:employee>  
200140 <adm:employee xmlns:adm="http://www.adm.com" adm:department="C01">  
  NATZ</adm:employee>
```

- *Example 2:* Produce an XML element named 'employee', which is associated with a default namespace, and a sub-element named 'job', which does not use a default namespace, but whose sub-element named 'department' does use a default namespace.

```

SELECT EMP.EMPNO, XMLELEMENT(
  NAME "employee", XMLNAMESPACES(
    DEFAULT 'http://hr.org'
  ),
  EMP.LASTNAME, XMLELEMENT(
    NAME "job", XMLNAMESPACES(
      NO DEFAULT
    ),
    EMP.JOB, XMLELEMENT(
      NAME "department", XMLNAMESPACES(
        DEFAULT 'http://adm.org'
      ),
      EMP.WORKDEPT
    )
  )
)
FROM EMPLOYEE EMP
WHERE EMP.EDLEVEL = 12

```

This query produces the following result:

```

000290 <employee xmlns="http://hr.org">PARKER<job xmlns="">OPERATOR
<department xmlns="http://adm.org">E11</department></job></employee>
000310 <employee xmlns="http://hr.org">SETRIGHT<job xmlns="">OPERATOR
<department xmlns="http://adm.org">E11</department></job></employee>
200310 <employee xmlns="http://hr.org">SPRINGER<job xmlns="">OPERATOR
<department xmlns="http://adm.org">E11</department></job></employee>

```

---

## XMLPI

The XMLPI function returns an XML value with a single XQuery processing instruction node.

```

▶▶ XMLPI ( ( —NAME— pi-name , —string-expression— ) )

```

The schema is SYSIBM. The function name cannot be specified as a qualified name.

### NAME *pi-name*

Specifies the name of a processing instruction. The name is an SQL identifier that must be in the form of an XML NCName (SQLSTATE 42634). See the W3C XML namespace specifications for more details on valid names. The name cannot be the word 'xml' in any case combination (SQLSTATE 42634).

### *string-expression*

An expression that returns a value that is a character string. The resulting string is converted to UTF-8 and must conform to the content of an XML processing instruction as specified in XML 1.0 rules (SQLSTATE 2200T):

- The string must not contain the substring '?>' since this substring terminates a processing instruction
- Each character of the string can be any Unicode character excluding the surrogate blocks, X'FFFE' and X'FFFF'.

The resulting string becomes the content of the constructed processing instruction node.

The data type of the result is XML. If the result of *string-expression* can be null, the result can be null; if the result of *string-expression* is null, the result is the null value. If *string-expression* is an empty string or is not specified, an empty processing instruction node is returned.

## Examples

- *Example 1:* Generate an XML processing instruction node.

```
SELECT XMLPI(
  NAME "Instruction", 'Push the red button'
)
FROM SYSIBM.SYSDUMMY1
```

This query produces the following result:

```
<?Instruction Push the red button?>
```

- *Example 2:* Generate an empty XML processing instruction node.

```
SELECT XMLPI(
  NAME "Warning"
)
FROM SYSIBM.SYSDUMMY1
```

This query produces the following result:

```
<?Warning ?>
```

---

## XMLROW

The XMLROW function returns an XML value with a single XQuery document node containing one top-level element node.

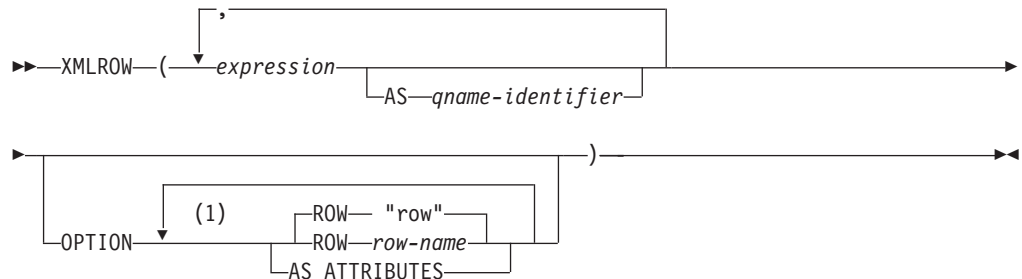

### Notes:

- 1 The same clause must not be specified more than once.

The schema is SYSIBM. The function name cannot be specified as a qualified name.

#### *expression*

The content of each generated XML element node is specified by an expression. The data type of the expression cannot be a structured type (SQLSTATE 42884). The expression can be any SQL expression. If the expression is not a simple column reference, an element name must be specified.

#### AS *qname-identifier*

Specifies the XML element name or attribute name as an SQL identifier. The *qname-identifier* must be of the form of an XML qualified name, or QName (SQLSTATE 42634). See the W3C XML namespace specifications for more details on valid names. If the name is qualified, the namespace prefix must be

declared within the scope (SQLSTATE 42635). If *qname-identifier* is not specified, *expression* must be a column name (SQLSTATE 42703). The element name or attribute name is created from the column name using the fully escaped mapping from a column name to an QName.

#### OPTION

Specifies additional options for constructing the XML value. If no OPTION clause is specified, the default behavior applies.

#### AS ATTRIBUTES

Specifies that each expression is mapped to an attribute value with column name or *qname-identifier* serving as the attribute name.

#### ROW *row-name*

Specifies the name of the element to which each row is mapped. If this option is not specified, the default element name is "row".

### Notes

By default, each row in the result set is mapped to an XML value as follows:

- Each row is transformed into an XML element named "row" and each column is transformed into a nested element with the column name as the element name.
- The null handling behavior is NULL ON NULL. A null value in a column maps to the absence of the subelement. If all column values are null, a null value is returned by the function.
- The binary encoding scheme for BLOB and FOR BIT DATA data types is base64Binary encoding.
- A document node will be added implicitly to the row element to make the XML result a well-formed single-rooted XML document.

### Examples

Assume the following table T1 with columns C1 and C2 that contain numeric data stored in a relational format:

C1	C2
1	2
-	2
1	-
-	-

4 record(s) selected.

- *Example 1:* The following example shows an XMLRow query and output fragment with default behavior, using a sequence of row elements to represent the table:

```
SELECT XMLROW(C1, C2) FROM T1
<row><C1>1</C1><C2>2</C2></row>
<row><C2>2</C2></row>
<row><C1>1</C1></row>
```

4 record(s) selected.

- *Example 2:* The following example shows an XMLRow query and output fragment with attribute centric mapping. Instead of appearing as nested elements as in the previous example, relational data is mapped to element attributes:

```
SELECT XMLROW(C1, C2 OPTION AS ATTRIBUTES) FROM T1
```

```

<row C1="1" C2="2"/>
<row C2="2"/>
<row C1="1"/>

```

4 record(s) selected.

- *Example 3:* The following example shows an XMLRow query and output fragment with the default <row> element replaced by <entry>. Columns C1 and C2 are returned as <column1> and <column2> elements, and the total of C1 and C2 is returned inside a <total> element:

```

SELECT XMLROW(
  C1 AS "column1", C2 AS "column2",
  C1+C2 AS "total" OPTION ROW "entry")
FROM T1
<entry><column1>1</column1><column2>2</column2><total>3</total></entry>
<entry><column2>2</column2></entry>
<entry><column1>1</column1></entry>

```

4 record(s) selected.

---

## XMLTEXT

The XMLTEXT function returns an XML value with a single XQuery text node having the input argument as the content.

►► XMLTEXT (—*string-expression*—) ◀◀

The schema is SYSIBM. The function name cannot be specified as a qualified name.

*string-expression*

An expression whose value has a character string type: CHAR, VARCHAR or CLOB.

The data type of the result is XML. If the result of *string-expression* can be null, the result can be null; if the input value is null, the result is the null value. If the result of *string-expression* is an empty string, the result value is an empty text node.

### Examples

- *Example 1:* Create a simple XMLTEXT query.

```

VALUES(
  XMLTEXT(
    'The stock symbol for Johnson&Johnson is JNJ.'
  )
)

```

This query produces the following serialized result:

```

1
-----
The stock symbol for Johnson&Johnson is JNJ.

```

Note that the '&' sign is mapped to '&amp;' when a text node is serialized.

- *Example 2:* Use XMLTEXT with XMLAGG to construct mixed content. Suppose that the content of table T is as follows:

```

seqno  plaintext                                     emphtext
-----
1      This query shows how to construct

```

```

mixed content
2   using XMLAGG and XMLTEXT. Without
XMLTEXT
3   XMLAGG will not have text nodes to group with other nodes,
mixed content
    therefore, cannot generate

```

```

SELECT
XMLELEMENT(
  NAME "para", XMLAGG(
    XMLCONCAT(
      XMLTEXT(
        PLAINTEXT
      ),
      XMLELEMENT(
        NAME "emphasis", EMPHTEXT
      )
    )
  )
ORDER BY SEQNO
), '.'
) AS "result"
FROM T

```

This query produces the following result:

result

```

-----
<para>This query shows how to construct <emphasis>mixed content</emphasis>
using XMLAGG and XMLTEXT. Without <emphasis>XMLTEXT</emphasis>
, XMLAGG
will not have text nodes to group with other nodes, therefore, cannot
generate
<emphasis>mixed content</emphasis>.</para>

```

---

## XSLTRANSFORM

Use XSLTRANSFORM to convert XML data into other formats, including the conversion of XML documents that conform to one XML schema into documents that conform to another schema.

```

▶▶—XSLTRANSFORM—▶▶
▶—(—xml-document—USING—xsl-sheet—
    [WITH—xsl-parameters] [AS CLOB(2G)]
    [AS—data-type] )—▶▶

```

**data-type:**



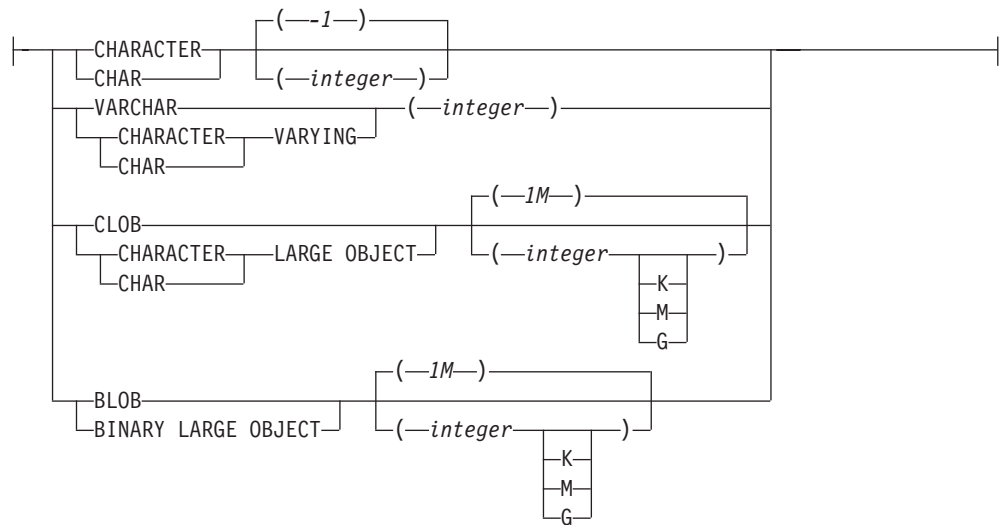

The schema is SYSIBM. This function cannot be specified as a qualified name.

The XSLTRANSFORM function transforms an XML document into a different data format. The data can be transformed into any form possible for the XSLT processor, including but not limited to XML, HTML, or plain text.

All paths used by XSLTRANSFORM are internal to the database system. This command cannot currently be used directly with files or stylesheets residing in an external file system.

*xml-document*

An expression that returns a well-formed XML document with a data type of XML, CHAR, VARCHAR, CLOB, or BLOB. This is the document that is transformed using the XSL style sheet specified in *xsl-stylesheet*.

The XML document must at minimum be single-rooted and well-formed.

*xsl-stylesheet*

An expression that returns a well-formed XML document with a data type of XML, CHAR, VARCHAR, CLOB, or BLOB. The document is an XSL style sheet that conforms to the W3C XSLT Version 1.0 Recommendation. Style sheets incorporating XQUERY statements or the `xsl:include` declaration are not supported. This stylesheet is applied to transform the value specified in *xml-document*.

*xsl-parameters*

An expression that returns a well-formed XML document or null with a data type of XML, CHAR, VARCHAR, CLOB, or BLOB. This is a document that provides parameter values to the XSL stylesheet specified in *xsl-stylesheet*. The value of the parameter can be specified as an attribute, or as a text node.

The syntax of the parameter document is as follows:

```
<params xmlns="http://www.ibm.com/XSLTransformParameters">
<param name="..." value="..."/>
<param name="...">enter value here</param>
...
</params>
```

The stylesheet document must have `xsl:param` element(s) in it with name attribute values that match the ones specified in the parameter document.

### AS data-type

Specifies the result data type. The implicit or explicit length attribute of the specified result data type must be sufficient to contain the transformed output (SQLSTATE 22001). The default result data type is CLOB(2G).

If either the *xml-document* argument or the *xsl-stylesheet* argument is null, the result will be null.

Code page conversion might occur when storing any of the previously mentioned documents in a CHAR, VARCHAR, or CLOB column, which might result in a character loss.

## Example

This example illustrates how to use XSLT as a formatting engine. To get set up, first insert the following two example documents into the database.

### INSERT INTO XML\_TAB VALUES

```
(1,
    '<?xml version="1.0"?>
<students xmlns:xsi="http://www.w3.org/2001/XMLSchema-instance"
  xsi:noNamespaceSchemaLocation = "/home/steffen/xsd/xslt.xsd">
<student studentID="1" firstName="Steffen" lastName="Siegmund"
  age="23" university="Rostock"/>
</students>',
    '<?xml version="1.0" encoding="UTF-8"?>
<xsl:stylesheet version="1.0"
  xmlns:xsl="http://www.w3.org/1999/XSL/Transform">
<xsl:param name="headline"/>
<xsl:param name="showUniversity"/>
<xsl:template match="students">
  <html>
    <head/>
    <body>
      <h1><xsl:value-of select="$headline"/></h1>
      <table border="1">
        <thead>
          <tr>
            <td width="80">StudentID</td>
            <td width="200">First Name</td>
            <td width="200">Last Name</td>
            <td width="50">Age</td>
            <xsl:choose>
              <xsl:when test="$showUniversity = 'true'">
                <td width="200">University</td>
              </xsl:when>
            </xsl:choose>
          </tr>
        </thead>
        <xsl:apply-templates/>
      </table>
    </body>
  </html>
</xsl:template>
<xsl:template match="student">
  <tr>
    <td><xsl:value-of select="@studentID"/></td>
    <td><xsl:value-of select="@firstName"/></td>
    <td><xsl:value-of select="@lastName"/></td>
    <td><xsl:value-of select="@age"/></td>
    <xsl:choose>
      <xsl:when test="$showUniversity = 'true'">
        <td><xsl:value-of select="@university"/></td>
      </xsl:when>
    </xsl:choose>
  </tr>
</xsl:template>
```

```

        </tr>
      </xsl:template>
</xsl:stylesheet>'
);

```

Next, call the XSLTRANSFORM function to convert the XML data into HTML and display it.

```
SELECT XSLTRANSFORM (XML_DOC USING XSL_DOC AS CLOB(1M)) FROM XML_TAB;
```

The result is this document:

```

<html>
<head>
<META http-equiv="Content-Type" content="text/html; charset=UTF-8">
</head>
<body>
<h1></h1>
<table border="1">
<thead>
<tr>
<td width="80">StudentID</td>
<td width="200">First Name</td>
<td width="200">Last Name</td>
<td width="50">Age</td>
</tr>
</thead>
<tbody>
<tr>
<td>1</td>
<td>Steffen</td><td>Siegmond</td>
<td>23</td>
</tr>
</tbody>
</table>
</body>
</html>

```

In this example, the output is HTML and the parameters influence only what HTML is produced and what data is brought over to it. As such it illustrates the use of XSLT as a formatting engine for end-user output.

## Usage note

There are many methods you can use to transform XML documents including the XSLTRANSFORM function, an XQuery update expression, and XSLT processing by an external application server. For documents stored in a DB2 XML column, many transformations can be performed more efficiently by using an XQuery update expression rather than with XSLT because XSLT always requires parsing of the XML documents that are being transformed. If you decide to transform XML documents with XSLT, you should make careful decisions about whether to transform the document in the database or in an application server.



---

## Appendix C. XSR stored procedures and commands

The following sections describe the syntax for the DB2 XSR stored procedures and commands.

For information about using the stored procedures and commands, see “XSR objects” on page 201.

---

### XSR stored procedures

#### XSR\_REGISTER

The XSR\_REGISTER procedure is the first procedure to be called as part of the XML schema registration process, which registers XML schemas with the XML schema repository (XSR).

```
►► XSR_REGISTER (—rschema—, —name—, —schemalocation—, —content—, —docproperty—)
```

The schema is SYSPROC.

#### Authorization

The authorization ID of the caller of the procedure must have at least one of the following authorities:

- DBADM authority.
- IMPLICIT\_SCHEMA database authority if the SQL schema does not exist.
- CREATEIN privilege if the SQL schema exists.

#### *rschema*

An input and output argument of type VARCHAR (128) that specifies the SQL schema for the XML schema. The SQL schema is one part of the SQL identifier used to identify this XML schema in the XSR. (The other part of the SQL identifier is supplied by the name argument.) This argument can have a null value, which indicates that the default SQL schema, as defined in the CURRENT\_SCHEMA special register, is used. Rules for valid characters and delimiters that apply to any SQL identifier also apply to this argument. Relational schemas that begin with the string 'SYS' must not be used for this value. XSR objects will not experience name collisions with database objects that exist outside of the XSR, because XSR objects occur in a different namespace than objects outside of the XML schema repository.

#### *name*

An input and output argument of type VARCHAR (128) that specifies the name of the XML schema. The complete SQL identifier for the XML schema is *rschema.name* and should be unique among all objects in the XSR. This argument accepts a null value. When a null value is provided for this argument, a unique value is generated and stored within the XSR. Rules for valid characters and delimiters that apply to any SQL identifier also apply to this argument.

### *schemalocation*

An input argument of type VARCHAR (1000), which can have a null value, that indicates the schema location of the primary XML schema document. This argument is the external name of the XML schema, that is, the primary document can be identified in the XML instance documents with the xsi:schemaLocation attribute.

### *content*

An input parameter of type BLOB (30M) that contains the content of the primary XML schema document. This argument cannot have a null value; an XML schema document must be supplied.

### *docproperty*

An input parameter of type BLOB (5M) that indicates the properties for the primary XML schema document. This parameter can have a null value; otherwise, the value is an XML document.

## Examples

- *Example 1:* The following example shows how to call the XSR\_REGISTER procedure from the command line:

```
CALL SYSPROC.XSR_REGISTER(
  'user1',
  'POschema',
  'http://myPOschema/PO.xsd',
  :content_host_var,
  :docproperty_host_var)
```

- *Example 2:* The following example shows how to call the XSR\_REGISTER procedure from a Java application program:

```
stmt = con.prepareStatement("CALL SYSPROC.XSR_REGISTER (?, ?, ?, ?, ?)");
String xsrObjectName = "myschema1";
String xmlSchemaLocation = "po.xsd";
stmt.setNull(1, java.sql.Types.VARCHAR);
stmt.setString(2, xsrObjectName);
stmt.setString(3, xmlSchemaLocation);
stmt.setBinaryStream(4, buffer, (int)length);
stmt.setNull(5, java.sql.Types.BLOB);
stmt.registerOutParameter(1, java.sql.Types.VARCHAR);
stmt.registerOutParameter(2, java.sql.Types.VARCHAR);
stmt.execute();
```

## XSR\_ADDSCHEMADOC

Each XML schema in the XML schema repository (XSR) can consist of one or more XML schema documents. Where an XML schema consists of multiple documents, the XSR\_ADDSCHEMADOC procedure is used to add every XML schema other than the primary XML schema document.

```
►► XSR_ADDSCHEMADOC(—rschema—, —name—, —schemalocation—, —content—, —
►—docproperty—)
```

The schema is SYSPROC.

## Authorization

The authorization ID of the caller of the procedure must be the owner of the XSR object as recorded in the catalog view SYSCAT.XSROBJECTS.

### *rschema*

An input argument of type VARCHAR (128) that specifies the SQL schema for the XML schema. The SQL schema is one part of the SQL identifier used to identify this XML schema in the XSR, which is to be moved to the complete state. (The other part of the SQL identifier is supplied by the name argument.) This argument can have a null value, which indicates that the default SQL schema, as defined in the CURRENT SCHEMA special register, is used. Rules for valid characters and delimiters that apply to any SQL identifier also apply to this argument. XSR objects will not experience name collisions with database objects that exist outside of the XSR, because XSR objects occur in a different namespace than objects outside of the XML schema repository.

### *name*

An input argument of type VARCHAR (128) that specifies the name of the XML schema. The complete SQL identifier for the XML schema is *rschema.name*. The XML schema name must already exist as a result of calling the XSR\_REGISTER procedure, and XML schema registration cannot yet be completed. This argument cannot have a null value. Rules for valid characters and delimiters that apply to any SQL identifier also apply to this argument.

### *schemalocation*

An input argument of type VARCHAR (1000), which can have a null value, that indicates the schema location of the primary XML schema document to which the XML schema document is being added. This argument is the external name of the XML schema, that is, the primary document can be identified in the XML instance documents with the xsi:schemaLocation attribute.

### *content*

An input parameter of type BLOB (30M) that contains the content of the XML schema document being added. This argument cannot have a null value; an XML schema document must be supplied.

### *docproperty*

An input parameter of type BLOB (5M) that indicates the properties for the XML schema document being added. This parameter can have a null value; otherwise, the value is an XML document.

## Example

```
CALL SYSPROC.XSR_ADDSCHEMADOC(  
  'user1',  
  'POschema',  
  'http://myPOschema/address.xsd',  
  :content_host_var,  
  0)
```

## XSR\_COMPLETE

The XSR\_COMPLETE procedure is the final procedure to be called as part of the XML schema registration process, which registers XML schemas with the XML schema repository (XSR). An XML schema is not available for validation until the schema registration completes through a call to this procedure.

```
►►XSR_COMPLETE(—rschema—,—name—,—schemaproperties—,——————►  
►—usedfordecomposition—)—————►◄
```

The schema is SYSPROC.

## Authorization:

The authorization ID of the caller of the procedure must be the owner of the XSR object as recorded in the catalog view SYSCAT.XSROBJECTS.

### *rschema*

An input argument of type VARCHAR (128) that specifies the SQL schema for the XML schema. The SQL schema is one part of the SQL identifier used to identify this XML schema in the XSR, which is to be moved to the complete state. (The other part of the SQL identifier is supplied by the name argument.) This argument can have a null value, which indicates that the default SQL schema, as defined in the CURRENT SCHEMA special register, is used. Rules for valid characters and delimiters that apply to any SQL identifier also apply to this argument. XSR objects will not experience name collisions with database objects that exist outside of the XSR, because XSR objects occur in a different namespace than objects outside of the XML schema repository.

### *name*

An input argument of type VARCHAR (128) that specifies the name of the XML schema. The complete SQL identifier for the XML schema, for which a completion check is to be performed, is *rschema.name*. The XML schema name must already exist as a result of calling the XSR\_REGISTER procedure, and XML schema registration cannot yet be completed. This argument cannot have a null value. Rules for valid characters and delimiters that apply to any SQL identifier also apply to this argument.

### *schemaproperties*

An input argument of type BLOB (5M) that specifies properties, if any, associated with the XML schema. The value for this argument is either the null value, if there are no associated properties, or an XML document representing the properties for the XML schema.

### *isusedfordecomposition*

An input parameter of type integer that indicates if an XML schema is to be used for decomposition. If an XML schema is to be used for decomposition, this value should be set to 1; otherwise, it should be set to zero.

## Example

```
CALL SYSPROC.XSR_COMPLETE(  
  'user1',  
  'POschema',  
  :schemaproperty_host_var,  
  0)
```

## XSR\_DTD

The XSR\_DTD procedure registers a document type declaration (DTD) with the XML schema repository (XSR).

```
►► XSR_DTD (—rschema—, —name—, —systemid—, —publicid—, —content—) ◄◄
```

The schema is SYSPROC.

## Authorization

The authorization ID of the caller of the procedure must have at least one of the following:

- DBADM authority.



- IMPLICIT\_SCHEMA database authority if the SQL schema does not exist.
- CREATEIN privilege if the SQL schema exists.

*rschema*

An input and output argument of type VARCHAR (128) that specifies the SQL schema for the DTD. The SQL schema is one part of the SQL identifier used to identify this DTD in the XSR. (The other part of the SQL identifier is supplied by the *name* argument.) This argument can have a null value, which indicates that the default SQL schema, as defined in the CURRENT\_SCHEMA special register, is used. Rules for valid characters and delimiters that apply to any SQL identifier also apply to this argument. Relational schemas that begin with the string 'SYS' must not be used for this value. XSR objects will not experience name collisions with database objects that exist outside of the XSR, because XSR objects occur in a different namespace than objects outside of the XML schema repository.

*name*

An input and output argument of type VARCHAR (128) that specifies the name of the DTD. The complete SQL identifier for the DTD is *rschema.name* and should be unique among all objects in the XSR. This argument accepts a null value. When a null value is provided for this argument, a unique value is generated and stored within the XSR. Rules for valid characters and delimiters that apply to any SQL identifier also apply to this argument.

*systemid*

An input parameter of type VARCHAR (1000) that specifies the system identifier of the DTD. The system ID of the DTD should match the uniform resource identifier of the DTD in the DOCTYPE declaration of the XML instance document or in an ENTITY declaration (as prefixed by the SYSTEM keyword, if used). This argument cannot have a null value. The system ID can be specified together with a public ID.

*publicid*

An input parameter of type VARCHAR (1000) that specifies the public identifier of the DTD. The public ID of a DTD should match the uniform resource identifier of the DTD in the DOCTYPE declaration of the XML instance document or in an ENTITY declaration (as prefixed by the PUBLIC keyword, if used). This argument accepts a null value and should be used only if also specified in the DOCTYPE declaration of the XML instance document or in an ENTITY declaration.

*content*

An input parameter of type BLOB (30M) that contains the content of the DTD document. This argument cannot have a null value.

## Example

Register the DTD identified by the system ID *http://www.test.com/person.dtd* and public ID *http://www.test.com/person*:

```
CALL SYSPROC.XSR_DTD ( 'MYDEPT' ,
  'PERSONDTD' ,
  'http://www.test.com/person.dtd' ,
  'http://www.test.com/person' ,
  :content_host_variable
)
```

## XSR\_EXTENTITY

The XSR\_EXTENTITY procedure registers an external entity with the XML schema repository (XSR).

```
► XSR_EXTENTITY(—rschema—,—name—,—systemid—,—publicid—,—  
► content—)
```

The schema is SYSPROC.

### Authorization

The authorization ID of the caller of the procedure must have at least one of the following:

- DBADM authority.
- IMPLICIT\_SCHEMA database authority if the SQL schema does not exist.
- CREATEIN privilege if the SQL schema exists.

#### *rschema*

An input and output argument of type VARCHAR (128) that specifies the SQL schema for the external entity. The SQL schema is one part of the SQL identifier used to identify this external entity in the XSR. (The other part of the SQL identifier is supplied by the *name* argument.) This argument can have a null value, which indicates that the default SQL schema, as defined in the CURRENT SCHEMA special register, is used. Rules for valid characters and delimiters that apply to any SQL identifier also apply to this argument. Relational schemas that begin with the string 'SYS' must not be used for this value. XSR objects will not experience name collisions with database objects that exist outside of the XSR, because XSR objects occur in a different namespace than objects outside of the XML schema repository.

#### *name*

An input and output argument of type VARCHAR (128) that specifies the name of the external entity. The complete SQL identifier for the external entity is *rschema.name* and should be unique among all objects in the XSR. This argument accepts a null value. When a null value is provided for this argument, a unique value is generated and stored within the XSR. Rules for valid characters and delimiters that apply to any SQL identifier also apply to this argument.

#### *systemid*

An input parameter of type VARCHAR (1000) that specifies the system identifier of the external entity. The system ID of the external entity should match the uniform resource identifier of the external entity in the ENTITY declaration (as prefixed by the SYSTEM keyword, if used). This argument cannot have a null value. The system ID can be specified together with a public ID.

#### *publicid*

An input parameter of type VARCHAR (1000) that specifies the public identifier of the external entity. The public ID of a external entity should match the uniform resource identifier of the external entity in the ENTITY declaration (as prefixed by the PUBLIC keyword, if used). This argument accepts a null value and should be used only if also specified in the DOCTYPE declaration of the XML instance document or in an ENTITY declaration.

*content*

An input parameter of type BLOB (30M) that contains the content of the external entity document. This argument cannot have a null value.

## Example

Register the external entities identified by the system identifiers *http://www.test.com/food/chocolate.txt* and *http://www.test.com/food/cookie.txt*:

```
CALL SYSPROC.XSR_EXTENTITY ( 'FOOD' ,
                             'CHOCOLATE' ,
                             'http://www.test.com/food/chocolate.txt' ,
                             NULL ,
                             :content_of_chocolate.txt_as_a_host_variable
                           )

CALL SYSPROC.XSR_EXTENTITY ( 'FOOD' ,
                             'COOKIE' ,
                             'http://www.test.com/food/cookie.txt' ,
                             NULL ,
                             :content_of_cookie.txt_as_a_host_variable
                           )
```

## XSR\_UPDATE

The XSR\_UPDATE procedure is used to evolve an existing XML schema in the XML schema repository (XSR). This enables you to modify or extend an existing XML schema so that it can be used to validate both already existing and newly inserted XML documents.

```
►►—XSR_UPDATE—(—rschema1—,—name1—,—rschema2—,—name2—,——————►
►—dropnewschema—)—————►
```

The schema is SYSPROC.

The original XML schema and the new XML schema specified as arguments to XSR\_UPDATE must both be registered and completed in the XSR before the procedure is called. These XML schemas must also be compatible. For details about the compatibility requirements see *Compatibility requirements for evolving an XML schema*.

## Authorization

The privileges held by the authorization ID of the caller of the procedure must include at least one of the following:

- DBADM authority.
- SELECT privilege on the catalog views SYSCAT.XSROBJECTS and SYSCAT.XSROBJECTCOMPONENTS and one of the following sets of privileges:
  - OWNER of the XML schema specified by the SQL schema *rschema1* and the object name *name1*
  - ALTERIN privilege on the SQL schema specified by the *rschema1* argument and, if the *dropnewschema* argument is not equal to zero, DROPIN privilege on the SQL schema specified by the *rschema2* argument.

*rschema1*

An input argument of type VARCHAR (128) that specifies the SQL schema for

the original XML schema to be updated. The SQL schema is one part of the SQL identifier used to identify this XML schema in the XSR. (The other part of the SQL identifier is supplied by the *name1* argument.) This argument cannot have a null value. Rules for valid characters and delimiters that apply to any SQL identifier also apply to this argument.

*name1*

An input argument of type VARCHAR (128) that specifies the name of the original XML schema to be updated. The complete SQL identifier for the XML schema is *rschema1.name1* . This XML schema must already be registered and completed in the XSR. This argument cannot have a null value. Rules for valid characters and delimiters that apply to any SQL identifier also apply to this argument.

*rschema2*

An input argument of type VARCHAR (128) that specifies the SQL schema for the new XML schema that will be used to update the original XML schema. The SQL schema is one part of the SQL identifier used to identify this XML schema in the XSR. (The other part of the SQL identifier is supplied by the *name2* argument.) This argument cannot have a null value. Rules for valid characters and delimiters that apply to any SQL identifier also apply to this argument.

*name2*

An input argument of type VARCHAR (128) that specifies the name of the new XML schema that will be used to update the original XML schema. The complete SQL identifier for the XML schema is *rschema2.name2*. This XML schema must already be registered and completed in the XSR. This argument cannot have a null value. Rules for valid characters and delimiters that apply to any SQL identifier also apply to this argument.

*dropnewschema*

An input parameter of type integer that indicates whether the new XML schema should be dropped after it is used to update the original XML schema. Setting this parameter to any nonzero value will cause the new XML schema to be dropped. This argument cannot have a null value.

### Example

```
CALL SYSPROC.XSR_UPDATE(  
  'STORE',  
  'PROD',  
  'STORE',  
  'NEWPROD',  
  1)
```

The contents of the XML schema STORE.PROD is updated with the contents of STORE.NEWPROD, and the XML schema STORE.NEWPROD is dropped.

---

## XSR commands

### REGISTER XMLSCHEMA

Registers an XML schema with the XML schema repository (XSR).

#### Authorization

One of the following authorities:

- DBADM

- IMPLICIT\_SCHEMA database authority if the SQL schema does not exist
- CREATEIN privilege if the SQL schema exists

## Required connection

Database

## Command syntax

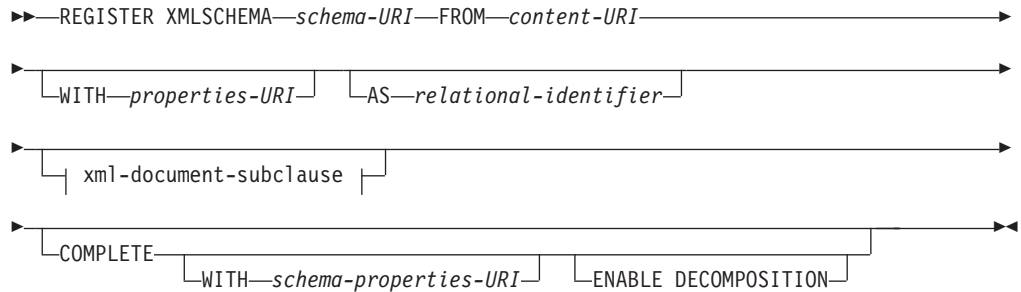

### xml-document-subclause:

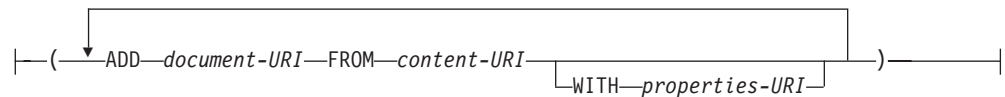

## Command parameters

### *schema-URI*

Specifies the URI, as referenced by XML instance documents, of the XML schema being registered.

### FROM *content-URI*

Specifies the URI where the XML schema document is located. Only a local file specified by a file scheme URI is supported.

### WITH *properties-URI*

Specifies the URI of a properties document for the XML schema. Only a local file specified by a file scheme URI is supported.

### AS *relational-identifier*

Specifies a name that can be used to refer to the XML schema being registered. The relational name can be specified as a two-part SQL identifier, consisting of the SQL schema and the XML schema name, having the following format: SQLschema.name. The default relational schema, as defined in the CURRENT\_SCHEMA special register, is used if no schema is specified. If no name is provided, a unique value is generated.

### COMPLETE

Indicates that there are no more XML schema documents to be added. If specified, the schema is validated and marked as usable if no errors are found.

### WITH *schema-properties-URI*

Specifies the URI of a properties document for the XML schema. Only a local file specified by a file scheme URI is supported.

**ENABLE DECOMPOSITION**

Specifies that this schema is to be used for decomposing XML documents.

**ADD *document-URI***

Specifies the URI of an XML schema document to be added to this schema, as the document would be referenced from another XML document.

**FROM *content-URI***

Specifies the URI where the XML schema document is located. Only a local file specified by a file scheme URI is supported.

**WITH *properties-URI***

Specifies the URI of a properties document for the XML schema. Only a local file specified by a file scheme URI is supported.

**Examples**

```
REGISTER XMLSCHEMA 'http://myPOschema/PO.xsd'
FROM 'file:///c:/TEMP/PO.xsd'
WITH 'file:///c:/TEMP/schemaProp.xml'
AS user1.POschema
```

**Usage notes**

- Before an XML schema document can be referenced and be available for validation and annotation, it must first be registered with the XSR. This command performs the first step of the XML schema registration process, by registering the primary XML schema document. The final step of the XML schema registration process requires that the **COMPLETE XMLSCHEMA** command run successfully for the XML schema. Alternatively, if there are no other XML schema documents to be included, issue the **REGISTER XMLSCHEMA** command with the **COMPLETE** keyword to complete registration in one step.
- When registering an XML schema in the database, a larger application heap (**app1heapsz**) may be required depending on the size of the XML schema. The recommended size is 1024 but larger schemas will require additional memory.

**ADD XMLSCHEMA DOCUMENT**

Adds one or more XML schema documents to an existing but incomplete XML schema before completing registration.

**Authorization**

The following authority is required:

- The user ID must be the owner of the XSR object as recorded in the catalog view SYSCAT.XSROBJECTS.

**Required connection**

Database

**Command syntax**

►►—ADD XMLSCHEMA DOCUMENT—TO—*relational-identifier*—►►

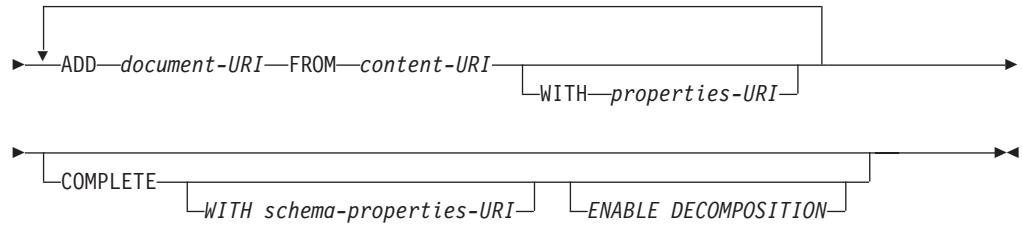

## Description

### TO *relational-identifier*

Specifies the relational name of a registered but incomplete XML schema to which additional schema documents are added.

### ADD *document-URI*

Specifies the uniform resource identifier (URI) of an XML schema document to be added to this schema, as the document would be referenced from another XML document.

### FROM *content-URI*

Specifies the URI where the XML schema document is located. Only a file scheme URI is supported.

### WITH *properties-URI*

Specifies the URI of a properties document for the XML schema. Only a file scheme URI is supported.

### COMPLETE

Indicates that there are no more XML schema documents to be added. If specified, the schema is validated and marked as usable if no errors are found.

### WITH *schema-properties-URI*

Specifies the URI of a properties document for the XML schema. Only a file scheme URI is supported.

### ENABLE DECOMPOSITION

Specifies that this schema is to be used for decomposing XML documents.

## Example

```

ADD XMLSCHEMA DOCUMENT TO JOHNDOE.PRODSHEMA
  ADD 'http://myPOschema/address.xsd'
  FROM 'file:///c:/TEMP/address.xsd'

```

## COMPLETE XMLSCHEMA

Completes the process of registering an XML schema in the XML schema repository (XSR).

### Authorization

- The user ID must be the owner of the XSR object as recorded in the catalog view SYSCAT.XSROBJECTS.

### Required connection

Database





## Command syntax

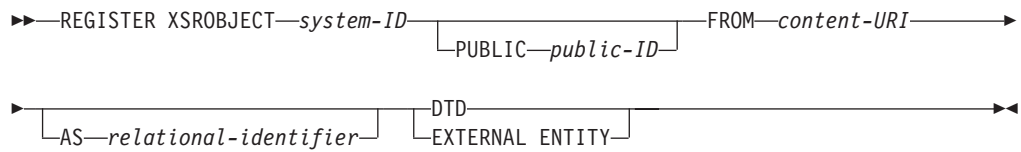

## Command parameters

### *system-ID*

Specifies the system ID that is specified in the XML object declaration.

### **PUBLIC** *public-ID*

Specifies an optional PUBLIC ID in the XML object declaration.

### **FROM** *content-URI*

Specifies the URI where the content of an XML schema document is located. Only a local file specified by a file scheme URI is supported.

### **AS** *relational-identifier*

Specifies a name that can be used to refer to the XML object being registered. The relational name can be specified as a two-part SQL identifier consisting of the relational schema and name separated by a period, for example "JOHNDOE.EMPLOYEEEDTD". If no relational schema is specified, the default relational schema defined in the special register CURRENT SCHEMA is used. If no name is specified, one is generated automatically.

**DTD** Specifies that the object being registered is a Data Type Definition document (DTD).

### **EXTERNAL ENTITY**

Specifies that the object being registered is an external entity.

## Examples

1. Given this sample XML document which references an external entity:

```
<?xml version="1.0" standalone="no" ?>
<!DOCTYPE copyright [
  <!ELEMENT copyright (#PCDATA)>
]>
<copyright>c</copyright>
```

Before this document can be successfully inserted into an XML column, the external entity needs to be registered. The following command registers an entity where the entity content is stored locally in C:\TEMP:

```
REGISTER XSROBJECT 'http://www.xmlwriter.net/copyright.xml'
FROM 'c:\temp\copyright.xml' EXTERNAL ENTITY
```

2. Given this XML document fragment which references a DTD:

```
<!--inform the XML processor
that an external DTD is referenced-->
<?xml version="1.0" standalone="no" ?>

<!--define the location of the
external DTD using a relative URL address-->
<!DOCTYPE document SYSTEM "http://www.xmlwriter.net/subjects.dtd">

<document>
```

```

<title>Subjects available in Mechanical Engineering.</title>
<subjectID>2.303</subjectID>
  <subjectname>Fluid Mechanics</subjectname>
...

```

Before this document can be successfully inserted into an XML column, the DTD needs to be registered. The following command registers a DTD where the DTD definition is stored locally in C:\TEMP and the relational identifier to be associated with the DTD is "TEST.SUBJECTS":

```

REGISTER XSROBJECT 'http://www.xmlwriter.net/subjects.dtd'
FROM 'file:///c:/temp/subjects.dtd' AS TEST.SUBJECTS DTD

```

- Given this sample XML document which references a public external entity:

```

<?xml version="1.0" standalone="no" ?>
<!DOCTYPE copyright [
  <!ELEMENT copyright (#PCDATA)>
]
<copyright>c</copyright>

```

Before this document can be successfully inserted into an XML column, the public external entity needs to be registered. The following command registers an entity where the entity content is stored locally in C:\TEMP:

```

REGISTER XSROBJECT 'http://www.w3.org/xmlspec/copyright.xml'
PUBLIC '-//W3C//TEXT copyright//EN' FROM 'file:///c:/temp/copyright.xml'
EXTERNAL ENTITY

```

## UPDATE XMLSCHEMA

Updates one XML schema with another in the XML schema repository (XSR).

### Authorization

One of the following authorities:

- DBADM
- SELECT privilege on the catalog views SYSCAT.XSROBJECTS and SYSCAT.XSROBJECTCOMPONENTS and one of the following sets of privileges:
  - ALTERIN privilege on the XML schema to be updated and DROPIN privilege on the new XML schema, if the **DROP NEW SCHEMA** option is specified.
  - OWNER of the XML schema specified by *xmlschema1*.

### Required connection

Database

### Command syntax

```

➤ UPDATE XMLSCHEMA xmlschema1 WITH xmlschema2 [DROP NEW SCHEMA] ➤

```

### Command parameters

**UPDATE XMLSCHEMA** *xmlschema1*

Specifies the SQL identifier for the original XML schema to be updated.

**WITH** *xmlschema2*

Specifies the SQL identifier for the new XML schema that will be used to update the original XML schema.

## DROP NEW SCHEMA

Indicates that the new XML schema should be dropped after it is used to update the original XML schema.

### Example

```
UPDATE XMLSCHEMA JOHNDOE.OLDPROD  
WITH JOHNDOE.NEWPROD  
DROP NEW SCHEMA
```

The contents of the XML schema JOHNDOE.OLDPROD is updated with the contents of JOHNDOE.NEWPROD, and the XML schema JOHNDOE.NEWPROD is dropped.

### Usage notes

- The original and new XML schema must be compatible. For details about the compatibility requirements, see “Compatibility requirements for evolving an XML schema”.
- Before an XML schema can be updated, both the original and the new schema must be registered in the XML schema repository (XSR).



---

## Appendix D. Overview of the DB2 technical information

DB2 technical information is available in multiple formats that can be accessed in multiple ways.

DB2 technical information is available through the following tools and methods:

- DB2 Information Center
  - Topics (Task, concept and reference topics)
  - Sample programs
  - Tutorials
- DB2 books
  - PDF files (downloadable)
  - PDF files (from the DB2 PDF DVD)
  - printed books
- Command-line help
  - Command help
  - Message help

**Note:** The DB2 Information Center topics are updated more frequently than either the PDF or the hardcopy books. To get the most current information, install the documentation updates as they become available, or refer to the DB2 Information Center at [ibm.com](http://ibm.com).

You can access additional DB2 technical information such as technotes, white papers, and IBM Redbooks® publications online at [ibm.com](http://www.ibm.com). Access the DB2 Information Management software library site at <http://www.ibm.com/software/data/sw-library/>.

### Documentation feedback

We value your feedback on the DB2 documentation. If you have suggestions for how to improve the DB2 documentation, send an email to [db2docs@ca.ibm.com](mailto:db2docs@ca.ibm.com). The DB2 documentation team reads all of your feedback, but cannot respond to you directly. Provide specific examples wherever possible so that we can better understand your concerns. If you are providing feedback on a specific topic or help file, include the topic title and URL.

Do not use this email address to contact DB2 Customer Support. If you have a DB2 technical issue that the documentation does not resolve, contact your local IBM service center for assistance.

---

## DB2 technical library in hardcopy or PDF format

The following tables describe the DB2 library available from the IBM Publications Center at [www.ibm.com/e-business/linkweb/publications/servlet/pbi.wss](http://www.ibm.com/e-business/linkweb/publications/servlet/pbi.wss). English and translated DB2 Version 10.1 manuals in PDF format can be downloaded from [www.ibm.com/support/docview.wss?rs=71&uid=swg2700947](http://www.ibm.com/support/docview.wss?rs=71&uid=swg2700947).

Although the tables identify books available in print, the books might not be available in your country or region.

The form number increases each time a manual is updated. Ensure that you are reading the most recent version of the manuals, as listed below.

**Note:** The *DB2 Information Center* is updated more frequently than either the PDF or the hard-copy books.

*Table 76. DB2 technical information*

<b>Name</b>	<b>Form Number</b>	<b>Available in print</b>	<b>Last updated</b>
<i>Administrative API Reference</i>	SC27-3864-00	Yes	April, 2012
<i>Administrative Routines and Views</i>	SC27-3865-00	No	April, 2012
<i>Call Level Interface Guide and Reference Volume 1</i>	SC27-3866-00	Yes	April, 2012
<i>Call Level Interface Guide and Reference Volume 2</i>	SC27-3867-00	Yes	April, 2012
<i>Command Reference</i>	SC27-3868-00	Yes	April, 2012
<i>Database Administration Concepts and Configuration Reference</i>	SC27-3871-00	Yes	April, 2012
<i>Data Movement Utilities Guide and Reference</i>	SC27-3869-00	Yes	April, 2012
<i>Database Monitoring Guide and Reference</i>	SC27-3887-00	Yes	April, 2012
<i>Data Recovery and High Availability Guide and Reference</i>	SC27-3870-00	Yes	April, 2012
<i>Database Security Guide</i>	SC27-3872-00	Yes	April, 2012
<i>DB2 Workload Management Guide and Reference</i>	SC27-3891-00	Yes	April, 2012
<i>Developing ADO.NET and OLE DB Applications</i>	SC27-3873-00	Yes	April, 2012
<i>Developing Embedded SQL Applications</i>	SC27-3874-00	Yes	April, 2012
<i>Developing Java Applications</i>	SC27-3875-00	Yes	April, 2012
<i>Developing Perl, PHP, Python, and Ruby on Rails Applications</i>	SC27-3876-00	No	April, 2012
<i>Developing User-defined Routines (SQL and External)</i>	SC27-3877-00	Yes	April, 2012
<i>Getting Started with Database Application Development</i>	GI13-2046-00	Yes	April, 2012

*Table 76. DB2 technical information (continued)*

<b>Name</b>	<b>Form Number</b>	<b>Available in print</b>	<b>Last updated</b>
<i>Getting Started with DB2 Installation and Administration on Linux and Windows</i>	GI13-2047-00	Yes	April, 2012
<i>Globalization Guide</i>	SC27-3878-00	Yes	April, 2012
<i>Installing DB2 Servers</i>	GC27-3884-00	Yes	April, 2012
<i>Installing IBM Data Server Clients</i>	GC27-3883-00	No	April, 2012
<i>Message Reference Volume 1</i>	SC27-3879-00	No	April, 2012
<i>Message Reference Volume 2</i>	SC27-3880-00	No	April, 2012
<i>Net Search Extender Administration and User's Guide</i>	SC27-3895-00	No	April, 2012
<i>Partitioning and Clustering Guide</i>	SC27-3882-00	Yes	April, 2012
<i>pureXML Guide</i>	SC27-3892-00	Yes	April, 2012
<i>Spatial Extender User's Guide and Reference</i>	SC27-3894-00	No	April, 2012
<i>SQL Procedural Languages: Application Enablement and Support</i>	SC27-3896-00	Yes	April, 2012
<i>SQL Reference Volume 1</i>	SC27-3885-00	Yes	April, 2012
<i>SQL Reference Volume 2</i>	SC27-3886-00	Yes	April, 2012
<i>Text Search Guide</i>	SC27-3888-00	Yes	April, 2012
<i>Troubleshooting and Tuning Database Performance</i>	SC27-3889-00	Yes	April, 2012
<i>Upgrading to DB2 Version 10.1</i>	SC27-3881-00	Yes	April, 2012
<i>What's New for DB2 Version 10.1</i>	SC27-3890-00	Yes	April, 2012
<i>XQuery Reference</i>	SC27-3893-00	No	April, 2012

*Table 77. DB2 Connect-specific technical information*

<b>Name</b>	<b>Form Number</b>	<b>Available in print</b>	<b>Last updated</b>
<i>DB2 Connect Installing and Configuring DB2 Connect Personal Edition</i>	SC27-3861-00	Yes	April, 2012
<i>DB2 Connect Installing and Configuring DB2 Connect Servers</i>	SC27-3862-00	Yes	April, 2012
<i>DB2 Connect User's Guide</i>	SC27-3863-00	Yes	April, 2012

---

## Displaying SQL state help from the command line processor

DB2 products return an SQLSTATE value for conditions that can be the result of an SQL statement. SQLSTATE help explains the meanings of SQL states and SQL state class codes.

### Procedure

To start SQL state help, open the command line processor and enter:

```
? sqlstate or ? class code
```

where *sqlstate* represents a valid five-digit SQL state and *class code* represents the first two digits of the SQL state.

For example, ? 08003 displays help for the 08003 SQL state, and ? 08 displays help for the 08 class code.

---

## Accessing different versions of the DB2 Information Center

Documentation for other versions of DB2 products is found in separate information centers on [ibm.com](http://ibm.com)<sup>®</sup>.

### About this task

For DB2 Version 10.1 topics, the *DB2 Information Center* URL is <http://publib.boulder.ibm.com/infocenter/db2luw/v10r1>.

For DB2 Version 9.8 topics, the *DB2 Information Center* URL is <http://publib.boulder.ibm.com/infocenter/db2luw/v9r8/>.

For DB2 Version 9.7 topics, the *DB2 Information Center* URL is <http://publib.boulder.ibm.com/infocenter/db2luw/v9r7/>.

For DB2 Version 9.5 topics, the *DB2 Information Center* URL is <http://publib.boulder.ibm.com/infocenter/db2luw/v9r5/>.

For DB2 Version 9.1 topics, the *DB2 Information Center* URL is <http://publib.boulder.ibm.com/infocenter/db2luw/v9/>.

For DB2 Version 8 topics, go to the *DB2 Information Center* URL at: <http://publib.boulder.ibm.com/infocenter/db2luw/v8/>.

---

## Updating the DB2 Information Center installed on your computer or intranet server

A locally installed DB2 Information Center must be updated periodically.

### Before you begin

A DB2 Version 10.1 Information Center must already be installed. For details, see the “Installing the DB2 Information Center using the DB2 Setup wizard” topic in *Installing DB2 Servers*. All prerequisites and restrictions that applied to installing the Information Center also apply to updating the Information Center.



## About this task

An existing DB2 Information Center can be updated automatically or manually:

- Automatic updates update existing Information Center features and languages. One benefit of automatic updates is that the Information Center is unavailable for a shorter time compared to during a manual update. In addition, automatic updates can be set to run as part of other batch jobs that run periodically.
- Manual updates can be used to update existing Information Center features and languages. Automatic updates reduce the downtime during the update process, however you must use the manual process when you want to add features or languages. For example, a local Information Center was originally installed with both English and French languages, and now you want to also install the German language; a manual update will install German, as well as, update the existing Information Center features and languages. However, a manual update requires you to manually stop, update, and restart the Information Center. The Information Center is unavailable during the entire update process. In the automatic update process the Information Center incurs an outage to restart the Information Center after the update only.

This topic details the process for automatic updates. For manual update instructions, see the “Manually updating the DB2 Information Center installed on your computer or intranet server” topic.

## Procedure

To automatically update the DB2 Information Center installed on your computer or intranet server:

1. On Linux operating systems,
  - a. Navigate to the path where the Information Center is installed. By default, the DB2 Information Center is installed in the `/opt/ibm/db2ic/V10.1` directory.
  - b. Navigate from the installation directory to the `doc/bin` directory.
  - c. Run the `update-ic` script:

```
update-ic
```
2. On Windows operating systems,
  - a. Open a command window.
  - b. Navigate to the path where the Information Center is installed. By default, the DB2 Information Center is installed in the `<Program Files>\IBM\DB2 Information Center\Version 10.1` directory, where `<Program Files>` represents the location of the Program Files directory.
  - c. Navigate from the installation directory to the `doc\bin` directory.
  - d. Run the `update-ic.bat` file:

```
update-ic.bat
```

## Results

The DB2 Information Center restarts automatically. If updates were available, the Information Center displays the new and updated topics. If Information Center updates were not available, a message is added to the log. The log file is located in `doc\eclipse\configuration` directory. The log file name is a randomly generated number. For example, `1239053440785.log`.

---

## Manually updating the DB2 Information Center installed on your computer or intranet server

If you have installed the DB2 Information Center locally, you can obtain and install documentation updates from IBM.

### About this task

Updating your locally installed *DB2 Information Center* manually requires that you:

1. Stop the *DB2 Information Center* on your computer, and restart the Information Center in stand-alone mode. Running the Information Center in stand-alone mode prevents other users on your network from accessing the Information Center, and allows you to apply updates. The Workstation version of the DB2 Information Center always runs in stand-alone mode. .
2. Use the Update feature to see what updates are available. If there are updates that you must install, you can use the Update feature to obtain and install them

**Note:** If your environment requires installing the *DB2 Information Center* updates on a machine that is not connected to the internet, mirror the update site to a local file system by using a machine that is connected to the internet and has the *DB2 Information Center* installed. If many users on your network will be installing the documentation updates, you can reduce the time required for individuals to perform the updates by also mirroring the update site locally and creating a proxy for the update site.

If update packages are available, use the Update feature to get the packages. However, the Update feature is only available in stand-alone mode.

3. Stop the stand-alone Information Center, and restart the *DB2 Information Center* on your computer.

**Note:** On Windows 2008, Windows Vista (and higher), the commands listed later in this section must be run as an administrator. To open a command prompt or graphical tool with full administrator privileges, right-click the shortcut and then select **Run as administrator**.

### Procedure

To update the *DB2 Information Center* installed on your computer or intranet server:

1. Stop the *DB2 Information Center*.
  - On Windows, click **Start > Control Panel > Administrative Tools > Services**. Then right-click **DB2 Information Center** service and select **Stop**.
  - On Linux, enter the following command:  

```
/etc/init.d/db2icdv10 stop
```
2. Start the Information Center in stand-alone mode.
  - On Windows:
    - a. Open a command window.
    - b. Navigate to the path where the Information Center is installed. By default, the *DB2 Information Center* is installed in the *Program\_Files\IBM\DB2 Information Center\Version 10.1* directory, where *Program\_Files* represents the location of the Program Files directory.
    - c. Navigate from the installation directory to the `doc\bin` directory.
    - d. Run the `help_start.bat` file:

```
help_start.bat
```

- On Linux:
  - a. Navigate to the path where the Information Center is installed. By default, the *DB2 Information Center* is installed in the `/opt/ibm/db2ic/V10.1` directory.
  - b. Navigate from the installation directory to the `doc/bin` directory.
  - c. Run the `help_start` script:

```
help_start
```

The systems default Web browser opens to display the stand-alone Information Center.

3. Click the **Update** button (🔧). (JavaScript must be enabled in your browser.) On the right panel of the Information Center, click **Find Updates**. A list of updates for existing documentation displays.
4. To initiate the installation process, check that the selections you want to install, then click **Install Updates**.
5. After the installation process has completed, click **Finish**.
6. Stop the stand-alone Information Center:
  - On Windows, navigate to the `doc\bin` directory within the installation directory, and run the `help_end.bat` file:

```
help_end.bat
```

**Note:** The `help_end` batch file contains the commands required to safely stop the processes that were started with the `help_start` batch file. Do not use `Ctrl-C` or any other method to stop `help_start.bat`.
  - On Linux, navigate to the `doc/bin` directory within the installation directory, and run the `help_end` script:

```
help_end
```

**Note:** The `help_end` script contains the commands required to safely stop the processes that were started with the `help_start` script. Do not use any other method to stop the `help_start` script.
7. Restart the *DB2 Information Center*.
  - On Windows, click **Start > Control Panel > Administrative Tools > Services**. Then right-click **DB2 Information Center** service and select **Start**.
  - On Linux, enter the following command:

```
/etc/init.d/db2icdv10 start
```

## Results

The updated *DB2 Information Center* displays the new and updated topics.

---

## DB2 tutorials

The DB2 tutorials help you learn about various aspects of DB2 database products. Lessons provide step-by-step instructions.

### Before you begin

You can view the XHTML version of the tutorial from the Information Center at <http://publib.boulder.ibm.com/infocenter/db2luw/v10r1/>.

Some lessons use sample data or code. See the tutorial for a description of any prerequisites for its specific tasks.

## DB2 tutorials

To view the tutorial, click the title.

### “pureXML” in *pureXML Guide*

Set up a DB2 database to store XML data and to perform basic operations with the native XML data store.

---

## DB2 troubleshooting information

A wide variety of troubleshooting and problem determination information is available to assist you in using DB2 database products.

### DB2 documentation

Troubleshooting information can be found in the *Troubleshooting and Tuning Database Performance* or the Database fundamentals section of the *DB2 Information Center*, which contains:

- Information about how to isolate and identify problems with DB2 diagnostic tools and utilities.
- Solutions to some of the most common problem.
- Advice to help solve other problems you might encounter with your DB2 database products.

### IBM Support Portal

See the IBM Support Portal if you are experiencing problems and want help finding possible causes and solutions. The Technical Support site has links to the latest DB2 publications, TechNotes, Authorized Program Analysis Reports (APARs or bug fixes), fix packs, and other resources. You can search through this knowledge base to find possible solutions to your problems.

Access the IBM Support Portal at [http://www.ibm.com/support/entry/portal/Overview/Software/Information\\_Management/DB2\\_for\\_Linux,\\_UNIX\\_and\\_Windows](http://www.ibm.com/support/entry/portal/Overview/Software/Information_Management/DB2_for_Linux,_UNIX_and_Windows)

---

## Terms and conditions

Permissions for the use of these publications are granted subject to the following terms and conditions.

**Applicability:** These terms and conditions are in addition to any terms of use for the IBM website.

**Personal use:** You may reproduce these publications for your personal, noncommercial use provided that all proprietary notices are preserved. You may not distribute, display or make derivative work of these publications, or any portion thereof, without the express consent of IBM.

**Commercial use:** You may reproduce, distribute and display these publications solely within your enterprise provided that all proprietary notices are preserved. You may not make derivative works of these publications, or reproduce, distribute or display these publications or any portion thereof outside your enterprise, without the express consent of IBM.

**Rights:** Except as expressly granted in this permission, no other permissions, licenses or rights are granted, either express or implied, to the publications or any information, data, software or other intellectual property contained therein.

IBM reserves the right to withdraw the permissions granted herein whenever, in its discretion, the use of the publications is detrimental to its interest or, as determined by IBM, the above instructions are not being properly followed.

You may not download, export or re-export this information except in full compliance with all applicable laws and regulations, including all United States export laws and regulations.

IBM MAKES NO GUARANTEE ABOUT THE CONTENT OF THESE PUBLICATIONS. THE PUBLICATIONS ARE PROVIDED "AS-IS" AND WITHOUT WARRANTY OF ANY KIND, EITHER EXPRESSED OR IMPLIED, INCLUDING BUT NOT LIMITED TO IMPLIED WARRANTIES OF MERCHANTABILITY, NON-INFRINGEMENT, AND FITNESS FOR A PARTICULAR PURPOSE.

**IBM Trademarks:** IBM, the IBM logo, and ibm.com are trademarks or registered trademarks of International Business Machines Corp., registered in many jurisdictions worldwide. Other product and service names might be trademarks of IBM or other companies. A current list of IBM trademarks is available on the Web at [www.ibm.com/legal/copytrade.shtml](http://www.ibm.com/legal/copytrade.shtml)



---

## Appendix E. Notices

This information was developed for products and services offered in the U.S.A. Information about non-IBM products is based on information available at the time of first publication of this document and is subject to change.

IBM may not offer the products, services, or features discussed in this document in other countries. Consult your local IBM representative for information about the products and services currently available in your area. Any reference to an IBM product, program, or service is not intended to state or imply that only that IBM product, program, or service may be used. Any functionally equivalent product, program, or service that does not infringe any IBM intellectual property right may be used instead. However, it is the user's responsibility to evaluate and verify the operation of any non-IBM product, program, or service.

IBM may have patents or pending patent applications covering subject matter described in this document. The furnishing of this document does not grant you any license to these patents. You can send license inquiries, in writing, to:

IBM Director of Licensing  
IBM Corporation  
North Castle Drive  
Armonk, NY 10504-1785  
U.S.A.

For license inquiries regarding double-byte character set (DBCS) information, contact the IBM Intellectual Property Department in your country or send inquiries, in writing, to:

Intellectual Property Licensing  
Legal and Intellectual Property Law  
IBM Japan, Ltd.  
1623-14, Shimotsuruma, Yamato-shi  
Kanagawa 242-8502 Japan

**The following paragraph does not apply to the United Kingdom or any other country/region where such provisions are inconsistent with local law:**

INTERNATIONAL BUSINESS MACHINES CORPORATION PROVIDES THIS PUBLICATION "AS IS" WITHOUT WARRANTY OF ANY KIND, EITHER EXPRESS OR IMPLIED, INCLUDING, BUT NOT LIMITED TO, THE IMPLIED WARRANTIES OF NON-INFRINGEMENT, MERCHANTABILITY, OR FITNESS FOR A PARTICULAR PURPOSE. Some states do not allow disclaimer of express or implied warranties in certain transactions; therefore, this statement may not apply to you.

This information could include technical inaccuracies or typographical errors. Changes are periodically made to the information herein; these changes will be incorporated in new editions of the publication. IBM may make improvements, changes, or both in the product(s) and/or the program(s) described in this publication at any time without notice.

Any references in this information to websites not owned by IBM are provided for convenience only and do not in any manner serve as an endorsement of those

websites. The materials at those websites are not part of the materials for this IBM product and use of those websites is at your own risk.

IBM may use or distribute any of the information you supply in any way it believes appropriate without incurring any obligation to you.

Licensees of this program who wish to have information about it for the purpose of enabling: (i) the exchange of information between independently created programs and other programs (including this one) and (ii) the mutual use of the information that has been exchanged, should contact:

IBM Canada Limited  
U59/3600  
3600 Steeles Avenue East  
Markham, Ontario L3R 9Z7  
CANADA

Such information may be available, subject to appropriate terms and conditions, including, in some cases, payment of a fee.

The licensed program described in this document and all licensed material available for it are provided by IBM under terms of the IBM Customer Agreement, IBM International Program License Agreement, or any equivalent agreement between us.

Any performance data contained herein was determined in a controlled environment. Therefore, the results obtained in other operating environments may vary significantly. Some measurements may have been made on development-level systems, and there is no guarantee that these measurements will be the same on generally available systems. Furthermore, some measurements may have been estimated through extrapolation. Actual results may vary. Users of this document should verify the applicable data for their specific environment.

Information concerning non-IBM products was obtained from the suppliers of those products, their published announcements, or other publicly available sources. IBM has not tested those products and cannot confirm the accuracy of performance, compatibility, or any other claims related to non-IBM products. Questions on the capabilities of non-IBM products should be addressed to the suppliers of those products.

All statements regarding IBM's future direction or intent are subject to change or withdrawal without notice, and represent goals and objectives only.

This information may contain examples of data and reports used in daily business operations. To illustrate them as completely as possible, the examples include the names of individuals, companies, brands, and products. All of these names are fictitious, and any similarity to the names and addresses used by an actual business enterprise is entirely coincidental.

#### COPYRIGHT LICENSE:

This information contains sample application programs in source language, which illustrate programming techniques on various operating platforms. You may copy, modify, and distribute these sample programs in any form without payment to IBM, for the purposes of developing, using, marketing or distributing application programs conforming to the application programming interface for the operating



platform for which the sample programs are written. These examples have not been thoroughly tested under all conditions. IBM, therefore, cannot guarantee or imply reliability, serviceability, or function of these programs. The sample programs are provided "AS IS", without warranty of any kind. IBM shall not be liable for any damages arising out of your use of the sample programs.

Each copy or any portion of these sample programs or any derivative work must include a copyright notice as follows:

© (*your company name*) (*year*). Portions of this code are derived from IBM Corp. Sample Programs. © Copyright IBM Corp. *\_enter the year or years\_*. All rights reserved.

## Trademarks

IBM, the IBM logo, and [ibm.com](http://ibm.com) are trademarks or registered trademarks of International Business Machines Corp., registered in many jurisdictions worldwide. Other product and service names might be trademarks of IBM or other companies. A current list of IBM trademarks is available on the web at "Copyright and trademark information" at [www.ibm.com/legal/copytrade.shtml](http://www.ibm.com/legal/copytrade.shtml).

The following terms are trademarks or registered trademarks of other companies

- Linux is a registered trademark of Linus Torvalds in the United States, other countries, or both.
- Java and all Java-based trademarks and logos are trademarks or registered trademarks of Oracle, its affiliates, or both.
- UNIX is a registered trademark of The Open Group in the United States and other countries.
- Intel, Intel logo, Intel Inside, Intel Inside logo, Celeron, Intel SpeedStep, Itanium, and Pentium are trademarks or registered trademarks of Intel Corporation or its subsidiaries in the United States and other countries.
- Microsoft, Windows, Windows NT, and the Windows logo are trademarks of Microsoft Corporation in the United States, other countries, or both.

Other company, product, or service names may be trademarks or service marks of others.



---

# Index

## Special characters

- .NET
  - common language runtime (CLR) routines
    - example 273

## A

- about this book i
- ADD XMLSCHEMA DOCUMENT command 484
- annotated XML schema decomposition
  - advantage 339
  - annotations
    - db2-xdb:column 368
    - db2-xdb:condition 376
    - db2-xdb:contentHandling 379
    - db2-xdb:defaultSQLSchema 359
    - db2-xdb:expression 373
    - db2-xdb:locationPath 370
    - db2-xdb:normalization 384
    - db2-xdb:order 386
    - db2-xdb:rowSet 360
    - db2-xdb:rowSetMapping 390
    - db2-xdb:rowSetOperationOrder 394
    - db2-xdb:table 364
    - db2-xdb:truncate 388
    - overview 356
    - schema 425
    - specification 357
    - summary 358
    - tips 400
  - CDATA sections 397
  - data type compatibility
    - summary 417
  - decomposing documents
    - registering schemas 340
  - derived complex types 400
  - disabling 347
  - empty strings 398
  - examples
    - list 404
    - multiple 341
    - multiple values mapped to single table 413, 415
    - value mapped to multiple tables 412
    - value mapped to single table 409, 410
  - keywords 395
  - NULL values 398
  - overview 339
  - procedure 340
  - recursive documents 342
  - restrictions 421
  - results 396
  - rowSets 404
  - schemas
    - enabling 340
    - registering 340
    - structuring 403
  - troubleshooting 423
  - validation 397
  - XDB\_DECOMP\_XML\_FROM\_QUERY procedure 352
  - xdbDecompXML procedures 348

- archiving
  - XML 38
- atomic values 11
- attribute nodes 14
- auxiliary storage objects
  - XML data specifier 222

## B

- binary XML format
  - Java applications 244
- BOM (byte order mark)
  - Unicode 311
- byte order mark (BOM)
  - Unicode 311

## C

- C language
  - procedures
    - XML example 276
    - XQuery example 276
- C# .NET
  - XML example 273
- call level interface (CLI)
  - applications
    - XML data 236
  - SQL/XML functions 236
  - XML data
    - changing default type 239
    - handling 236
    - inserts 237
    - retrieval 238
    - updates 237
  - XQuery expressions 236
- casting
  - details 77
  - XML values
    - XMLQUERY example 76
- CDATA sections
  - annotated XML schema decomposition 397
- check constraints
  - XML support 46
- CLI/ODBC keywords
  - MapXMLCDefault 239
  - MapXMLDescribe 239
- columns
  - index keys 163
- combining updating expressions 194
- command line processor (CLP)
  - registering XSR objects 203
  - XML support 16
- commands
  - DECOMPOSE XML DOCUMENT 351
  - UPDATE XMLSCHEMA 488
- comment nodes 15
- common language runtime (CLR)
  - routines
    - XML support 273
    - XQuery support 273

- compatibility
  - data types 417
- compiled SQL functions 268
- COMPLETE XMLSCHEMA command 485
- connect method (Perl DBI) 262
- constructing XML
  - constant values 119
  - examples list 119
  - functions 118
  - multiple tables 121
  - single tables 120
  - special character handling 123
  - table rows 121
  - XQuery 122
- context step 150
- CREATE INDEX statement
  - details 163
  - index over XML data examples 183
- cursor data types
  - casting 77
- cursors
  - XQuery 265

## D

- data model
  - XQuery and XPath 10
- Data Studio
  - XML support 16
- data types
  - XML
    - compatibility for decomposition 417
    - overview 3
  - XQuery
    - casting 77
- database partitions
  - pureXML performance 297
  - XML performance 297
- database-managed space (DMS)
  - pureXML data store performance 309
  - XML performance 309
- DB2 Information Center
  - updating 494, 496
  - versions 494
- DB2 XQuery functions
  - xmlcolumn 66
- DB2 XQuery, overview 65
- DB2 XQuery, updating XML data 194
- db2-fn:sqlquery function 106
- DB2::DB2 driver
  - pureXML support 260
- DDL
  - statements
    - altering XSR objects 206
- debugging
  - XML decomposition 423
- declarations
  - XMLNAMESPACES 464
- declared temporary tables
  - XML data
    - details 301
- DECOMP\_CONTENT keyword 395
- DECOMP\_DOCUMENTID keyword 395
- DECOMP\_ELEMENTID keyword 395
- DECOMPOSE XML DOCUMENT command 351
- deregisterDB2XMLObject method 204
- disconnect method (Perl DBI) 262

- document function
  - XSLT 134
- document nodes
  - description 13
- document order 15
- documentation
  - overview 491
  - PDF files 491
  - printed 491
  - terms and conditions of use 498

## E

- element nodes 13
- element relationships in XML 92
- embedded SQL applications
  - XML values 244
- empty strings
  - annotated XML schema decomposition 398
- encryption
  - XMLGROUP function 461
  - XMLROW function 467
- ErrorLog XML schema 57, 59
- errors from XQuery updates 194
- examples
  - deregisterDB2XMLObject 204
  - registerDB2XMLSchema 204
  - XML decomposition
    - grouping multiple values mapped to single table 413
    - list 404
    - mapping to XML column 407
    - multiple values from different contexts mapped to single table 415
    - value mapped to multiple tables 412
    - value mapped to single table 409, 410
- EXPLAIN statement
  - XML support 16
- explicit XML parsing 41
- exporting
  - data
    - XML 223
- expressions
  - errors when updating XML data 194
  - updating XML data 194

## F

- full-text search of XML data 116
- function expression step 150
- functions
  - aggregate
    - XMLAGG 447
  - column
    - XMLAGG 447
  - scalar
    - XMLATTRIBUTES 448
    - XMLCOMMENT 450
    - XMLCONCAT 450
    - XMLDOCUMENT 451
    - XMLELEMENT 452
    - XMLFOREST 458
    - XMLGROUP 461
    - XMLNAMESPACES 464
    - XMLPI 466
    - XMLQUERY 85
    - XMLROW 467

functions (*continued*)  
  scalar (*continued*)  
    XMLTEXT 469  
    XSLTRANSFORM 470  
  table  
    XMLTABLE 95

## H

help  
  SQL statements 494  
hierarchy, nodes 15

## I

IBM Data Server Driver for JDBC and SQLJ  
  XML support 254  
ibm\_db2 API  
  details 258  
identity of nodes 16  
ignorable whitespace  
  XML validation 50  
implicit XML parsing 41  
IMPORT command  
  re-creating indexes over XML data 162  
importing  
  XML data 226  
index over XML data  
  best practices overview 109  
  casting rules for join predicates 114  
  CREATE INDEX statement 163  
    examples 183  
  data types  
    conversion 153  
    conversion summary tables 157  
    literals 113  
    XQuery pattern expressions 152  
  database objects associated with 160, 161  
  enforcing unique entries 159  
  indeterminate query evaluation 116  
  invalid index objects 162  
  logical 160  
  optimization guidelines 303, 304  
  overview 139  
  partitioned tables 297  
  physical 160  
  queries 110  
  re-creating 162  
  restrictions 186  
  restrictiveness 110  
  text() nodes 112  
  troubleshooting  
    common issues 188  
    CREATE INDEX failure 156  
    document rejection 156  
    invalid XML values 154  
    SQL20305N 188  
    SQL20306N 191  
  UNIQUE keyword semantics 159  
  XML namespaces 150  
  XMLEXISTS predicate usage 100  
  XQuery pattern expressions 140  
indexes  
  casting rules for join predicates 114  
  keys  
    XQuery pattern expressions over XML data 140

indexes (*continued*)  
  XML  
    case-insensitive searches 143  
    context step 150  
    fn:exists 145  
    fn:starts-with 148  
    function expression step 150  
    functional 143, 145, 148  
  XML data  
    errors during loading 228  
    XMLEXISTS predicate usage 100  
inlined SQL functions 268  
inserting data  
  XML  
    details 40, 237  
    overview 39  
internal XML encoding  
  .NET 313  
  input of XML 312  
  JDBC 313  
  scenarios 314  
  SQLJ 313  
items in sequences 10

## J

Java  
  routines  
    drivers 269  
JDBC  
  routines  
    examples (XML and XQuery support) 269  
XML  
  data encoding 313  
  example 269

## L

large objects (LOBs)  
  exporting 221  
  importing 221  
load utility  
  XML data 228  
loading  
  XML data 227

## M

methods  
  Perl  
    connect 262  
    disconnect 262  
moving data  
  XML 220

## N

namespaces  
  changing by using XSLT 131  
Net Search Extender  
  full-text searches  
    XML data 116  
nodes  
  attribute 14

- nodes (*continued*)
  - comment
    - description 15
  - document
    - description 13
  - duplicate 16
  - element 13
  - hierarchy 15
  - identity 16
  - overview 11, 13
  - processing instruction
    - description 15
  - properties 13
  - string values 16
  - text
    - description 14
  - typed values 16
- notices 501
- NULL
  - SQL value
    - decomposition 398

## O

- objects
  - associated with XML columns 161
- optimization guidelines
  - XML data and XQuery 303, 304

## P

- parsing
  - explicit
    - CLI applications 237
    - XML 41
  - implicit
    - CLI applications 237
    - XML 41
- partitioned tables
  - pureXML performance 297
  - XML performance 297
- pdo\_ibm
  - details 258
- performance
  - routines
    - recommendations 280
    - XML 297, 312
- Perl
  - connecting to a database 262
  - methods
    - connect 262
    - disconnect 262
  - pureXML support 260
  - restrictions 263
- PHP
  - application development 258
  - documentation 260
  - downloads 260
  - extensions for IBM data servers 258
  - retrieving XML data 259
- predicates
  - XMLEXISTS 102
- problem determination
  - information available 498
  - tutorials 498
  - XML decomposition 423

- procedures
  - commit effects on XML parameters and variables 266
  - rollback effects on XML parameters and variables 266
  - XML
    - parameters 264
    - variables 264
  - XSR\_ADDSCHEMADOC 476
  - XSR\_COMPLETE 477
  - XSR\_DTD 478
  - XSR\_EXTENTITY 480
  - XSR\_REGISTER 475
  - XSR\_UPDATE 481
- processing instruction nodes
  - description 15
- programming languages
  - XML 235
- publishing XML values
  - examples
    - constant values 119
    - multiple tables 121
    - single table 120
    - summary 119
    - table rows 121
    - XQuery 122
  - SQL/XML functions
    - special character handling 123
    - summary 118
- pureXML
  - DB2::DB2 driver 260
  - overview 1

## Q

- queries
  - index over XML data 116
  - performance
    - impact of system-managed space 309
  - structure 65
- query languages
  - XML data 68
- querying XML data
  - methods
    - comparison 69
    - overview 65
  - SQL
    - overview 68
    - passing column names 105
    - passing constants 104
    - passing parameter markers 104
    - XMLEXISTS predicate 99
    - XMLQUERY function 73
    - XMLTABLE function 87

## R

- reference types
  - casting 77
- REGISTER XMLSCHEMA command 482
- REGISTER XSROBJECT command 486
- registerDB2XMLSchema method 204
- registration
  - XML schemas for decomposition 340
- REORG INDEX command
  - re-creation of indexes over XML data 162
- REORG TABLE command
  - re-creation of indexes over XML data 162

- result sets
  - XML 107
- retrieving data
  - XML
    - CLI applications 238
    - encoding considerations 313
    - encoding scenarios 318, 320
    - overview 65
- routines
  - C/C++
    - XML data type support 268
  - COBOL
    - XML data type support 268
  - common language runtime
    - XML data type support 268
  - external
    - XML data type support 268
  - invoking
    - XML parameters in Java applications 252
  - Java
    - XML data type support 268
  - performance 280
  - XML support 313
- rows
  - index keys with UNIQUE clause 163
  - indexes 163
- rowSets in decomposition 404

## S

- schemas
  - repository 201
- sequences
  - description 10
- serialization
  - CCSID to encoding name mappings 334, 442
  - data conversion 314
  - differences in XML document 136
  - explicit
    - CLI applications 238
    - overview 124
  - implicit
    - CLI applications 236, 238
    - overview 124
- shredding XML documents
  - examples 341
  - overview 339
  - procedure 340
- specifying drivers 269
- SQL
  - fullselect
    - parameter passing 106
    - using with XQuery 106
- SQL functions
  - compiled 268
  - inlined 268
  - XML data type used for parameters and variables 266
- SQL statements
  - CREATE INDEX 163
  - help
    - displaying 494
  - passing parameters to XQuery expressions 104
- SQL/XML
  - functions
    - XMLQUERY overview 73
    - XMLTABLE overview 87

- SQLJ
  - XML data 313
- static SQL
  - unsupported in Perl 263
- storage
  - pureXML 1
  - requirements
    - XML documents 37
  - XML data specifier 222
- stored procedure diagnostics function
  - XSR\_GET\_PARSING\_DIAGNOSTICS stored procedure 53, 55
- stored procedures
  - registering XSR objects 203
- storing XML data
  - encoding
    - considerations 312
    - name to CCSID mappings 323, 431
    - non-Unicode 60
    - overview 311
  - inserting
    - columns 40
    - overview 39
  - overview 1
  - updating 193
- string values of nodes 16

## T

- table partitions
  - pureXML performance 297
  - XML performance 297
- tables
  - creating
    - XML columns 39
  - indexes 163
- terms and conditions
  - publications 498
- text nodes
  - description 14
- text searches
  - full-text searches of XML data 116
- transform expressions
  - partitioned database environments 298
- triggers
  - XML support 48
- troubleshooting
  - indexes over XML data
    - common issues 188
    - CREATE INDEX failure 156
    - document rejection 156
    - invalid XML values 154
    - SQL20305N 188
    - SQL20306N 191
  - online information 498
  - tutorials 498
  - XML decomposition 423
- tutorials
  - list 497
  - problem determination 498
  - pureXML 497
    - creating DB2 database and table 22
    - creating indexes over XML data 22
    - deleting XML documents 25
    - inserting XML documents 23
    - overview 21
    - querying XML data 27

- tutorials (*continued*)
  - pureXML (*continued*)
    - transforming with XSLT 32
    - updating XML documents 24
    - validating XML documents 30
  - troubleshooting 498
- type 2 indexes 163
- typed values of nodes 16

## U

- UDTs
  - casting 77
- UPDATE XMLSCHEMA command 488
- updates
  - DB2 Information Center 494, 496
  - XML columns 193
  - XML documents 197
- updating expressions 194
  - combining 194
- updating XML data using XQuery 194

## V

- validation
  - XML data
    - decomposition 397
    - details 50
- values, atomic 11
- Visual Explain
  - XML support 16

## W

- whitespace
  - XML parsing 41
  - XMLVALIDATE processing 50

## X

- XDB\_DECOMP\_XML\_FROM\_QUERY procedure 352
- xdbDecompXML procedures 348
- XDM, see XQuery and XPath data model 10
- XML
  - administration samples 288
  - application development
    - overview 235
    - samples 290
  - archival data types 38
  - articles 19
  - C/C++ applications
    - executing XQuery expressions 242
  - case-insensitive searches 143
  - check constraints 46
  - COBOL applications 242
  - constructing
    - examples (constant values) 119
    - examples (multiple tables) 121
    - examples (single table) 120
    - examples (summary) 119
    - examples (table rows) 121
    - examples (XQuery) 122
    - special character handling 123
    - SQL/XML publishing functions 118
  - CREATE INDEX statement 163

- XML (*continued*)
  - data integrity 46
  - declarations
    - embedded SQL applications 239
    - overview 311
  - developerWorks articles 19
  - event publishing support 18
  - federation support 18
  - full-text search 116
  - functional indexes 143, 145, 148
  - IBM Data Server Driver for JDBC and SQLJ 254
  - indexes using fn:exists 145
  - input methods 4
  - namespaces 72
  - native XML data store 1
  - nested 94
  - output methods 4
  - overview 1
  - parameters
    - commits 266
    - invoking routines from Java programs 252
    - procedures 264
    - rollbacks 266
  - parsing
    - CLI applications 237
    - details 41
    - resolving errors 55
    - XSR\_GET\_PARSING\_DIAGNOSTICS stored procedure 53
  - performance
    - overview 297, 312
  - programming language support 235
  - publishing examples
    - constant values 119
    - multiple tables 121
    - single table 120
    - summary 119
    - table rows 121
    - XQuery 122
  - publishing functions
    - special character handling 123
    - summary 118
  - queries using fn:starts-with 148
  - relational model comparison 8
  - replication support 18
  - restrictions 427
  - samples
    - administration 288
    - application development 290
    - summary 287
  - serialization
    - CLI applications 236, 238
    - details 124
  - SQL/XML functions
    - publishing 118
    - XMLQUERY overview 73
    - XMLTABLE overview 87
  - storage
    - base table row storage 36
    - document differences 136
    - encoding name to CCSID mappings 323, 431
    - XML storage object 35
  - table creation 39
  - tools 16
  - transforming
    - XSLTRANSFORM 125, 128, 130, 136
  - triggers 48



- XML (*continued*)
  - tutorial
    - creating DB2 database and table 22
    - creating indexes over XML data 22
    - deleting XML documents 25
    - inserting XML documents 23
    - overview 21
    - querying XML data 27
    - transforming with XSLT 32
    - updating XML documents 24
    - validating XML documents 30
  - validation 50
  - variables in procedures 264
  - XML schema repository (XSR) 201
  - XMLQUERY function 243
  - XQuery expressions 242, 243
  - XSR objects
    - overview 201
- XML columns
  - adding 40
  - check constraints 46
  - data retrieval to pre-Version 9.1 clients 117
  - defining 39
  - federated systems 18
  - inserting into 39, 40
  - remote data sources 18
  - updating 193
  - XML data type 3
- XML data
  - binary format 244
  - CLI applications
    - inserting 237
    - overview 236
    - retrieval 238
    - updating 237
  - CREATE INDEX statement 163
  - creating tables 39
  - declared temporary tables 301
  - deleting 198
  - encoding
    - CCSIDs to encoding names 334, 442
    - names to CCSID mappings 323, 431
    - non-Unicode 60
    - overview 311
  - exporting 223
  - importing 226
  - indeterminate query evaluation 116
  - indexing 139
  - inserting
    - details 40
    - overview 39
  - internal encoding and CCSID mappings 323
  - Java applications 246
  - loading 227
  - model 8
  - movement 219, 220
  - optimization guidelines 303, 304
  - partitioned database environments 298
  - Query and XPath Data Model 221
  - querying
    - constant and parameter marker passing 104
    - methods 69
    - overview 65, 68
    - passing column names 105
    - XMLEXISTS predicate 99
    - XMLQUERY function 73, 74, 75
    - XMLTABLE function 87, 89, 90
- XML data (*continued*)
  - querying in DB2 database 68
  - storing in database
    - base table row 36
    - objects 35
    - overview 35
  - updating
    - overview 193
    - tables in Java applications 247, 255
    - with information from other tables 197
- XML data retrieval
  - C applications 240
  - CLI applications 238
  - COBOL applications 240
  - document differences 136
  - down-level clients 117
  - Java applications 249, 257
  - overview 65
  - PHP applications 259
  - XMLEXISTS predicate 99
  - XMLQUERY function 73
  - XMLTABLE function 87
- XML data store 1
- XML data type
  - CLI applications 236
  - event publishing 18
  - exporting 221
  - external routines 268
  - host variables in embedded SQL applications 239
  - identifying in SQLDA 244
  - importing 221
  - indexing 139
  - replication 18
  - SQL functions 266
- XML decomposition
  - advantage 339
  - annotations
    - db2-xdb:column 368
    - db2-xdb:condition 376
    - db2-xdb:contentHandling 379
    - db2-xdb:defaultSQLSchema 359
    - db2-xdb:expression 373
    - db2-xdb:locationPath 370
    - db2-xdb:normalization 384
    - db2-xdb:order 386
    - db2-xdb:rowSet 360
    - db2-xdb:rowSetMapping 390
    - db2-xdb:rowSetOperationOrder 394
    - db2-xdb:table 364
    - db2-xdb:truncate 388
    - overview 356
    - schema 425
    - scope 357
    - specifying 357
    - summary 358
  - CDATA sections 397
  - checklist 400
  - data type compatibility
    - SQL types 417
  - derived complex types 400
  - disabling 347
  - empty strings 398
  - enabling schemas 340
  - examples
    - DECOMPOSE XML DOCUMENTS command 341
    - grouping multiple values mapped to single table 413
    - list 404

- XML decomposition (*continued*)
  - examples (*continued*)
    - mapping to XML column 407
    - multiple values from different contexts mapped to single table 415
    - value mapped to multiple tables 412
    - value mapped to single table yielding multiple rows 410
    - value mapped to single table yielding single row 409
  - keywords 395
  - limits 421
  - NULL values 398
  - overview 339
  - procedure 340
  - recursive documents 342
  - registering schemas 340
  - restrictions 421
  - results 396
  - rowSets 404
  - schemas
    - enabling 340
    - recursive 342
    - registering 340
    - structuring 403
  - troubleshooting 423
  - validation effect 397
  - XDB\_DECOMP\_XML\_FROM\_QUERY procedure 352
  - xdbDecompXML procedures 348
- XML documents
  - adding to database
    - columns 40
    - overview 39
  - archival data types 38
  - decomposing 340
  - differences after storage and retrieval 136
  - element relationships in XML 92
  - inserting 39
  - namespaces 72
  - recursive processing 94
  - storage
    - base table row storage 36
    - overview 35
    - requirements 37
    - XML storage object 35
  - updating 197
  - XML namespaces 70
  - XML schema retrieval 217
- XML encoding
  - .NET applications 313
  - effect on data conversion 314
  - input of XML data 312
  - internal 311
  - JDBC applications 313
  - non-Unicode 60
  - overview 239, 311
  - passing XML data in routine parameters 313
  - retrieval of XML data 313
  - scenarios
    - input of externally encoded data 316
    - input of internally encoded data 314
    - retrieval with explicit serialization 320
    - retrieval with implicit serialization 318
  - SQLJ applications 313
- XML schema repository (XSR)
  - ADD XMLSCHEMA DOCUMENT command 484
  - COMPLETE XMLSCHEMA command 485
  - decomposition 340
- XML schema repository (XSR) (*continued*)
  - objects
    - altering 206
    - overview 201
    - registering through command line processor 203
    - registering through stored procedures 203
  - overview 201
  - REGISTER XMLSCHEMA command 482
  - REGISTER XSROBJECT command 486
  - schema retrieval 217
  - Uniform Resource Identifier (URI) location reference 201
  - UPDATE XMLSCHEMA command 488
  - validation 50
- XML schemas
  - component retrieval 216
  - enabling for decomposition 340
  - evolving
    - compatibility requirements 207
    - example 214
    - procedure 206
    - scenario 214
  - indexes over XML data 158
  - listing registered 216
  - registering 204
  - registering for decomposition 340
  - removing 204
  - repository
    - registration 201
  - retrieval 217
  - structuring for decomposition 403
  - validation 50
- XML validation
  - resolving errors 55
  - XSR\_GET\_PARSING\_DIAGNOSTICS stored procedure 53
- XMLAGG aggregate function
  - details 447
  - publishing XML 118
- XMLATTRIBUTES scalar function
  - details 448
  - publishing XML 118
- xmlcolumn function 66
- XMLCOMMENT scalar function
  - details 450
  - publishing XML 118
- XMLCONCAT scalar function 450
- XMLDOCUMENT scalar function
  - details 451
  - publishing XML 118
- XMLELEMENT scalar function
  - details 452
  - publishing XML 118
- XMLEXISTS function 68
- XMLEXISTS predicate
  - details 102
  - querying with
    - overview 99
    - passing column names 105
    - passing constants 104
    - passing parameter markers 104
  - type casting 104
- XMLFOREST scalar function
  - details 458
  - publishing XML 118
- xmlFormat property
  - binary XML format 244
- XMLGROUP aggregate function
  - publishing XML 118

- XMLGROUP scalar function 461
- XMLNAMESPACES declaration
  - details 464
  - publishing XML 118
- XMLPARSE scalar function
  - parsing overview 41
- XMLPI scalar function
  - details 466
  - publishing XML 118
- XMLQUERY function 68
- XMLQUERY scalar function
  - details 85
  - overview 73
  - querying with
    - passing column names 105
    - passing constants 104
    - passing parameter markers 104
  - results
    - casting to non-XML types 76
    - empty sequences 75
    - non-empty sequences 74
- XMLROW scalar function
  - details 467
  - publishing XML 118
- XMLSERIALIZE scalar function
  - serialization overview 124
- XMLTABLE function 68
- XMLTABLE table function
  - details 95
  - example
    - inserting values returned from 89
    - processing hierarchical data 94
    - processing multiple trees 92
    - returning one row for each occurrence of item 90
  - overview 87
  - querying with 105
- XMLTEXT scalar function
  - details 469
  - publishing XML 118
- XMLVALIDATE scalar function
  - validation overview 50
- XPath
  - recursive processing 94
- XQuery
  - combining updating expressions 194
  - invoking from SQL 68
  - optimization guidelines 303, 304
  - overview 65
  - updating expressions 194
  - XML result sets
    - managing 107
- XQuery and XPath data model 10
- XQuery expressions
  - passing parameters to SQL statements 104
- XQuery statements
  - calling from SQL 265
  - comparison to SQL statements 69
  - declaring host variables in embedded SQL
    - applications 239
  - invoking from SQL
    - XMLEXISTS predicate 99
    - XMLQUERY function 73
    - XMLTABLE function 87
  - pattern expressions used for index keys 140
  - Query and XPath Data Model 221
  - results 107
  - specifying in CLP 16
- XQuery updates
  - errors 194
- XSLT
  - document function 134
- XSLT transforms
  - example 128, 130, 131
  - overview 125
  - parameter passing 128
  - restrictions 136
- XSLTRANSFORM scalar function
  - details 470
  - publishing XML 118
- XSR
  - objects
    - registering 201
- XSR\_ADDSCHEMADOC procedure 476
- XSR\_COMPLETE procedure 477
- XSR\_DTD procedure 478
- XSR\_EXTENTITY procedure 480
- XSR\_GET\_PARSING\_DIAGNOSTICS stored procedure
  - details 53
  - output parameter XML schema 57, 59
  - resolving XML parsing and validation errors 55
- XSR\_REGISTER procedure 475
- XSR\_UPDATE procedure 481







Printed in USA

SC27-3892-00



Spine information:

IBM DB2 10.1 for Linux, UNIX, and Windows

pureXML Guide

