

IBM DB2 10.1  
for Linux, UNIX, and Windows

*Developing Java Applications*





IBM DB2 10.1  
for Linux, UNIX, and Windows

*Developing Java Applications*



**Note**

Before using this information and the product it supports, read the general information under Appendix B, "Notices," on page 593.

**Edition Notice**

This document contains proprietary information of IBM. It is provided under a license agreement and is protected by copyright law. The information contained in this publication does not include any product warranties, and any statements provided in this manual should not be interpreted as such.

You can order IBM publications online or through your local IBM representative.

- To order publications online, go to the IBM Publications Center at <http://www.ibm.com/shop/publications/order>
- To find your local IBM representative, go to the IBM Directory of Worldwide Contacts at <http://www.ibm.com/planetwide/>

To order DB2 publications from DB2 Marketing and Sales in the United States or Canada, call 1-800-IBM-4YOU (426-4968).

When you send information to IBM, you grant IBM a nonexclusive right to use or distribute the information in any way it believes appropriate without incurring any obligation to you.

© Copyright IBM Corporation 2006, 2012.

US Government Users Restricted Rights – Use, duplication or disclosure restricted by GSA ADP Schedule Contract with IBM Corp.

# Contents

## About this book . . . . . vii

Who should use this book . . . . . vii

## Chapter 1. Java application development for IBM data servers . . . . . 1

Supported drivers for JDBC and SQLJ . . . . . 2

JDBC driver and database version compatibility . . . . . 3

DB2 for Linux, UNIX, and Windows and IBM

Data Server Driver for JDBC and SQLJ levels . . . . . 4

## Chapter 2. Installing the IBM Data Server Driver for JDBC and SQLJ. . . . . 7

DB2Binder utility . . . . . 11

DB2LobTableCreator utility . . . . . 18

Customization of IBM Data Server Driver for JDBC and SQLJ configuration properties. . . . . 19

Special setup for accessing DB2 for z/OS servers from Java programs . . . . . 20

DB2T4XAIndoubtUtil for distributed transactions with DB2 UDB for OS/390 and z/OS Version 7 servers . . . . . 21

## Chapter 3. JDBC application programming . . . . . 25

Example of a simple JDBC application . . . . . 25

How JDBC applications connect to a data source . . . . . 27

Connecting to a data source using the DriverManager interface with the IBM Data Server Driver for JDBC and SQLJ . . . . . 29

Connecting to a data source using the DataSource interface . . . . . 33

How to determine which type of IBM Data Server Driver for JDBC and SQLJ connectivity to use . . . . . 35

JDBC connection objects . . . . . 36

Creating and deploying DataSource objects. . . . . 36

Java packages for JDBC support . . . . . 37

Learning about a data source using DatabaseMetaData methods . . . . . 38

DatabaseMetaData methods for identifying the type of data source . . . . . 39

DatabaseMetaData extensions for obtaining information about modules . . . . . 40

Variables in JDBC applications . . . . . 42

JDBC interfaces for executing SQL. . . . . 42

Creating and modifying database objects using the Statement.executeUpdate method. . . . . 43

Updating data in tables using the PreparedStatement.executeUpdate method . . . . . 44

JDBC executeUpdate methods against a DB2 for z/OS server . . . . . 46

Making batch updates in JDBC applications . . . . . 46

Learning about parameters in a PreparedStatement using ParameterMetaData methods . . . . . 50

Data retrieval in JDBC applications . . . . . 51

Calling stored procedures in JDBC applications . . . . . 64

LOBs in JDBC applications with the IBM Data Server Driver for JDBC and SQLJ . . . . . 79

ROWIDs in JDBC with the IBM Data Server Driver for JDBC and SQLJ . . . . . 85

Update and retrieval of timestamps with time zone information in JDBC applications . . . . . 86

Distinct types in JDBC applications . . . . . 95

Invocation of stored procedures with ARRAY parameters in JDBC applications . . . . . 95

Savepoints in JDBC applications . . . . . 96

Retrieval of automatically generated keys in JDBC applications . . . . . 97

Using named parameter markers in JDBC applications . . . . . 101

Providing extended client information to the data source with IBM Data Server Driver for JDBC and SQLJ-only methods. . . . . 105

Providing extended client information to the data source with client info properties . . . . . 107

Extended parameter information with the IBM Data Server Driver for JDBC and SQLJ . . . . . 110

Using DB2PreparedStatement methods or constants to provide extended parameter information . . . . . 111

Using DB2ResultSet methods or DB2PreparedStatement constants to provide extended parameter information . . . . . 112

Optimistic locking in JDBC applications . . . . . 114

Compound SQL in Java applications. . . . . 116

XML data in JDBC applications . . . . . 117

XML column updates in JDBC applications . . . . . 117

XML data retrieval in JDBC applications . . . . . 120

Invocation of routines with XML parameters in Java applications . . . . . 123

Java support for XML schema registration and removal . . . . . 125

Transaction control in JDBC applications . . . . . 127

IBM Data Server Driver for JDBC and SQLJ isolation levels . . . . . 127

Committing or rolling back JDBC transactions . . . . . 127

Default JDBC autocommit modes. . . . . 128

Exceptions and warnings under the IBM Data Server Driver for JDBC and SQLJ. . . . . 128

Handling an SQLException under the IBM Data Server Driver for JDBC and SQLJ. . . . . 131

Handling an SQLWarning under the IBM Data Server Driver for JDBC and SQLJ. . . . . 134

Retrieving information from a BatchUpdateException . . . . . 135

Disconnecting from data sources in JDBC applications . . . . . 137

<b>Chapter 4. SQLJ application programming</b>	<b>139</b>
Example of a simple SQLJ application	139
Connecting to a data source using SQLJ	141
SQLJ connection technique 1: JDBC DriverManager interface	141
SQLJ connection technique 2: JDBC DriverManager interface	143
SQLJ connection technique 3: JDBC DataSource interface	144
SQLJ connection technique 4: JDBC DataSource interface	146
SQLJ connection technique 5: Use a previously created connection context	147
SQLJ connection technique 6: Use the default connection	147
Java packages for SQLJ support	148
Variables in SQLJ applications	148
Indicator variables in SQLJ applications	150
Comments in an SQLJ application	154
SQL statement execution in SQLJ applications	154
Creating and modifying database objects in an SQLJ application	154
Performing positioned UPDATE and DELETE operations in an SQLJ application	155
Data retrieval in SQLJ applications	164
Calling stored procedures in SQLJ applications	174
LOBs in SQLJ applications with the IBM Data Server Driver for JDBC and SQLJ	179
SQLJ and JDBC in the same application	181
Controlling the execution of SQL statements in SQLJ	184
ROWIDs in SQLJ with the IBM Data Server Driver for JDBC and SQLJ	185
TIMESTAMP WITH TIME ZONE values in SQLJ applications	186
Distinct types in SQLJ applications	187
Invocation of stored procedures with ARRAY parameters in SQLJ applications	188
Savepoints in SQLJ applications	189
XML data in SQLJ applications	190
XML column updates in SQLJ applications	191
XML data retrieval in SQLJ applications	193
XMLCAST in SQLJ applications	194
SQLJ utilization of SDK for Java Version 5 function	195
Transaction control in SQLJ applications	197
Setting the isolation level for an SQLJ transaction	197
Committing or rolling back SQLJ transactions	198
Handling SQL errors and warnings in SQLJ applications	198
Handling SQL errors in an SQLJ application	198
Handling SQL warnings in an SQLJ application	199
Closing the connection to a data source in an SQLJ application	200
<b>Chapter 5. Security under the IBM Data Server Driver for JDBC and SQLJ</b>	<b>201</b>

User ID and password security under the IBM Data Server Driver for JDBC and SQLJ	203
User ID-only security under the IBM Data Server Driver for JDBC and SQLJ	205
Encrypted password, user ID, or user ID and password security under the IBM Data Server Driver for JDBC and SQLJ	206
Kerberos security under the IBM Data Server Driver for JDBC and SQLJ	208
IBM Data Server Driver for JDBC and SQLJ security plugin support	212
Use of alternative security mechanisms with the IBM Data Server Driver for JDBC and SQLJ	213
IBM Data Server Driver for JDBC and SQLJ trusted context support	215
IBM Data Server Driver for JDBC and SQLJ support for SSL	217
Configuring connections under the IBM Data Server Driver for JDBC and SQLJ to use SSL	218
Configuring the Java Runtime Environment to use SSL	218
Security for preparing SQLJ applications with the IBM Data Server Driver for JDBC and SQLJ	221

<b>Chapter 6. Building Java database applications</b>	<b>223</b>
Building JDBC applets	223
Building JDBC applications	223
Building JDBC routines	224
Building SQLJ applets	225
Building SQLJ applications	226
Java applet considerations	226
SQLJ application and applet options for UNIX	227
SQLJ application and applet options for Windows	228
Building SQL routines	228
SQLJ routine options for UNIX	229
SQLJ routine options for Windows	229

<b>Chapter 7. Problem diagnosis with the IBM Data Server Driver for JDBC and SQLJ</b>	<b>231</b>
DB2jcc - IBM Data Server Driver for JDBC and SQLJ diagnostic utility	233
Examples of using configuration properties to start a JDBC trace	235
Example of a trace program under the IBM Data Server Driver for JDBC and SQLJ	237
Techniques for monitoring IBM Data Server Driver for JDBC and SQLJ Sysplex support	240

<b>Chapter 8. System monitoring for the IBM Data Server Driver for JDBC and SQLJ</b>	<b>243</b>
IBM Data Server Driver for JDBC and SQLJ remote trace controller	245
Enabling the remote trace controller	245
Accessing the remote trace controller	246

## Chapter 9. Java client support for high availability on IBM data servers . 251

Java client support for high availability for connections to DB2 Database for Linux, UNIX, and Windows servers . . . . .	252
Configuration of DB2 Database for Linux, UNIX, and Windows automatic client reroute support for Java clients . . . . .	253
Example of enabling DB2 Database for Linux, UNIX, and Windows automatic client reroute support in Java applications . . . . .	255
Configuration of DB2 Database for Linux, UNIX, and Windows workload balancing support for Java clients . . . . .	256
Example of enabling DB2 Database for Linux, UNIX, and Windows workload balancing support in Java applications . . . . .	258
Operation of automatic client reroute for connections to DB2 Database for Linux, UNIX, and Windows from Java clients . . . . .	259
Operation of alternate group support . . . . .	263
Operation of workload balancing for connections to DB2 Database for Linux, UNIX, and Windows . . . . .	266
Application programming requirements for high availability for connections to DB2 Database for Linux, UNIX, and Windows servers . . . . .	267
Client affinities for DB2 Database for Linux, UNIX, and Windows . . . . .	268
Java client support for high availability for connections to IBM Informix servers. . . . .	271
Configuration of IBM Informix high-availability support for Java clients . . . . .	272
Example of enabling IBM Informix high availability support in Java applications . . . . .	275
Operation of automatic client reroute for connections to IBM Informix from Java clients . . . . .	276
Operation of workload balancing for connections to IBM Informix from Java clients . . . . .	280
Application programming requirements for high availability for connections from Java clients to IBM Informix servers. . . . .	281
Client affinities for connections to IBM Informix from Java clients . . . . .	282
Java client direct connect support for high availability for connections to DB2 for z/OS servers . . . . .	285
Configuration of Sysplex workload balancing and automatic client reroute for Java clients . . . . .	287
Example of enabling DB2 for z/OS Sysplex workload balancing and automatic client reroute in Java applications . . . . .	289
Operation of Sysplex workload balancing for connections from Java clients to DB2 for z/OS servers . . . . .	292
Operation of automatic client reroute for connections from Java clients to DB2 for z/OS . . . . .	293
Operation of alternate group support . . . . .	294
Application programming requirements for high availability for connections from Java clients to DB2 for z/OS servers. . . . .	296

## Chapter 10. Java 2 Platform, Enterprise Edition . . . . . 299

Application components of Java 2 Platform, Enterprise Edition support . . . . .	299
Java 2 Platform, Enterprise Edition containers . . . . .	300
Java 2 Platform, Enterprise Edition Server . . . . .	300
Java 2 Platform, Enterprise Edition database requirements . . . . .	300
Java Naming and Directory Interface (JNDI) . . . . .	301
Java transaction management . . . . .	301
Example of a distributed transaction that uses JTA methods . . . . .	302
Setting the transaction timeout value for an XAResource instance . . . . .	306
Enterprise Java Beans. . . . .	306

## Chapter 11. JDBC and SQLJ connection pooling support . . . . . 309

## Chapter 12. IBM Data Server Driver for JDBC and SQLJ statement caching . . 311

## Chapter 13. JDBC and SQLJ reference information . . . . . 313

Data types that map to database data types in Java applications . . . . .	313
Date, time, and timestamp values that can cause problems in JDBC and SQLJ applications . . . . .	320
Data loss for timestamp data in JDBC and SQLJ applications . . . . .	323
Retrieval of special values from DECFLOAT columns in Java applications . . . . .	324
Properties for the IBM Data Server Driver for JDBC and SQLJ. . . . .	326
Common IBM Data Server Driver for JDBC and SQLJ properties for all supported database products . . . . .	326
Common IBM Data Server Driver for JDBC and SQLJ properties for DB2 servers . . . . .	348
Common IBM Data Server Driver for JDBC and SQLJ properties for DB2 for z/OS and IBM Informix . . . . .	360
Common IBM Data Server Driver for JDBC and SQLJ properties for IBM Informix and DB2 Database for Linux, UNIX, and Windows . . . . .	361
IBM Data Server Driver for JDBC and SQLJ properties for DB2 Database for Linux, UNIX, and Windows . . . . .	362
IBM Data Server Driver for JDBC and SQLJ properties for DB2 for z/OS . . . . .	364
IBM Data Server Driver for JDBC and SQLJ properties for IBM Informix . . . . .	368
IBM Data Server Driver for JDBC and SQLJ configuration properties . . . . .	374
Driver support for JDBC APIs . . . . .	392
IBM Data Server Driver for JDBC and SQLJ support for SQL escape syntax . . . . .	417
SQLJ statement reference information . . . . .	418
SQLJ clause . . . . .	418



SQLJ host-expression . . . . .	418	DB2ResultSetMetaData interface . . . . .	525
SQLJ implements-clause . . . . .	419	DB2RowID interface . . . . .	526
SQLJ with-clause . . . . .	420	DB2SimpleDataSource class . . . . .	527
SQLJ connection-declaration-clause . . . . .	422	DB2Sqlca class . . . . .	527
SQLJ iterator-declaration-clause . . . . .	422	DB2Statement interface . . . . .	528
SQLJ executable-clause . . . . .	424	DB2SystemMonitor interface . . . . .	531
SQLJ context-clause . . . . .	424	DB2TraceManager class . . . . .	534
SQLJ statement-clause . . . . .	424	DB2TraceManagerMxBean interface . . . . .	537
SQLJ SET-TRANSACTION-clause . . . . .	427	DB2Struct interface . . . . .	540
SQLJ assignment-clause . . . . .	428	DB2Types class . . . . .	541
SQLJ iterator-conversion-clause . . . . .	428	DB2XADataSource class . . . . .	541
Interfaces and classes in the sqlj.runtime package	429	DB2Xml interface . . . . .	543
sqlj.runtime.ConnectionContext interface . . . . .	430	DBTimestamp class . . . . .	545
sqlj.runtime.ForUpdate interface . . . . .	434	JDBC differences between versions of the IBM Data Server Driver for JDBC and SQLJ. . . . .	547
sqlj.runtime.NamedIterator interface . . . . .	435	Examples of ResultSetMetaData.getColumnNames and ResultSetMetaData.getColumnLabels values . . . . .	552
sqlj.runtime.PositionedIterator interface . . . . .	435	SDK for Java differences that affect the IBM Data Server Driver for JDBC and SQLJ. . . . .	554
sqlj.runtime.ResultSetIterator interface . . . . .	436	Error codes issued by the IBM Data Server Driver for JDBC and SQLJ . . . . .	555
sqlj.runtime.Scrollable interface . . . . .	438	SQLSTATES issued by the IBM Data Server Driver for JDBC and SQLJ . . . . .	562
sqlj.runtime.AsciiStream class . . . . .	441	How to find IBM Data Server Driver for JDBC and SQLJ version and environment information . . . . .	563
sqlj.runtime.BinaryStream class . . . . .	441	Commands for SQLJ program preparation. . . . .	564
sqlj.runtime.CharacterStream class . . . . .	442	sqlj - SQLJ translator . . . . .	564
sqlj.runtime.ExecutionContext class . . . . .	443	db2sqljcustomize - SQLJ profile customizer . . . . .	567
sqlj.runtime.SQLNullException class . . . . .	451	db2sqljbind - SQLJ profile binder. . . . .	580
sqlj.runtime.StreamWrapper class . . . . .	451	db2sqljprint - SQLJ profile printer . . . . .	586
sqlj.runtime.UnicodeStream class . . . . .	453	<b>Appendix A. Overview of the DB2 technical information . . . . .</b>	<b>589</b>
IBM Data Server Driver for JDBC and SQLJ extensions to JDBC . . . . .	453	Displaying SQL state help from the command line processor . . . . .	589
DBBatchUpdateException interface . . . . .	455	Accessing different versions of the DB2 Information Center . . . . .	590
DB2Administrator class . . . . .	456	DB2 tutorials . . . . .	590
DB2BaseDataSource class . . . . .	456	DB2 troubleshooting information . . . . .	591
DB2CallableStatement interface . . . . .	464	Terms and Conditions . . . . .	591
DB2CataloguedDatabase class . . . . .	471	<b>Appendix B. Notices . . . . .</b>	<b>593</b>
DB2ClientRerouteServerList class . . . . .	472	<b>Index . . . . .</b>	<b>597</b>
DB2Connection interface . . . . .	473		
DB2ConnectionPoolDataSource class . . . . .	492		
DB2DatabaseMetaData interface . . . . .	494		
DB2Diagnosable interface . . . . .	502		
DB2Driver class . . . . .	503		
DB2ExceptionFormatter class . . . . .	504		
DB2FileReference class . . . . .	504		
DB2JCCPlugin class . . . . .	505		
DB2ParameterMetaData interface . . . . .	506		
DB2PooledConnection class . . . . .	506		
DB2PoolMonitor class . . . . .	509		
DB2PreparedStatement interface . . . . .	512		
DB2ResultSet interface . . . . .	524		



---

## About this book

This book describes DB2<sup>®</sup> for Linux, UNIX, and Windows support for Java. This support lets you access relational databases from Java application programs.

---

## Who should use this book

This book is for the following users:

- DB2 for Linux, UNIX, and Windows application developers who are familiar with Structured Query Language (SQL) and who know the Java programming language.
- DB2 for Linux, UNIX, and Windows system programmers who are installing JDBC and SQLJ support.



---

## Chapter 1. Java application development for IBM data servers

The DB2 and IBM® Informix® database systems provide driver support for client applications and applets that are written in Java.

You can access data in DB2 and IBM Informix database systems using JDBC, SQL, or pureQuery.

### JDBC

JDBC is an application programming interface (API) that Java applications use to access relational databases. IBM data server support for JDBC lets you write Java applications that access local DB2 or IBM Informix data or remote relational data on a server that supports DRDA®.

### SQLJ

SQLJ provides support for embedded static SQL in Java applications. SQLJ was initially developed by IBM, Oracle, and Tandem to complement the dynamic SQL JDBC model with a static SQL model.

For connections to DB2, in general, Java applications use JDBC for dynamic SQL and SQLJ for static SQL.

For connections to IBM Informix, SQL statements in JDBC or SQLJ applications run dynamically.

Because SQLJ can inter-operate with JDBC, an application program can use JDBC and SQLJ within the same unit of work.

### pureQuery

pureQuery is a high-performance data access platform that makes it easier to develop, optimize, secure, and manage data access. It consists of:

- Application programming interfaces that are built for ease of use and for simplifying the use of best practices
- Development tools, which are delivered in IBM InfoSphere® Optim™ Development Studio, for Java and SQL development
- A runtime, which is delivered in IBM InfoSphere Optim pureQuery Runtime, for optimizing and securing database access and simplifying management tasks

With pureQuery, you can write Java applications that treat relational data as objects, whether that data is in databases or JDBC DataSource objects. Your applications can also treat objects that are stored in in-memory Java collections as though those objects are relational data. To query or update your relational data or Java objects, you use SQL.

For more information on pureQuery, see the Integrated Data Management Information Center.

---

## Supported drivers for JDBC and SQLJ

The DB2 product includes support for two types of JDBC driver architecture.

According to the JDBC specification, there are four types of JDBC driver architectures:

### Type 1

Drivers that implement the JDBC API as a mapping to another data access API, such as Open Database Connectivity (ODBC). Drivers of this type are generally dependent on a native library, which limits their portability. The DB2 database system does not provide a type 1 driver.

### Type 2

Drivers that are written partly in the Java programming language and partly in native code. The drivers use a native client library specific to the data source to which they connect. Because of the native code, their portability is limited.

### Type 3

Drivers that use a pure Java client and communicate with a data server using a data-server-independent protocol. The data server then communicates the client's requests to the data source. The DB2 database system does not provide a type 3 driver.

### Type 4

Drivers that are pure Java and implement the network protocol for a specific data source. The client connects directly to the data source.

DB2 Database for Linux, UNIX, and Windows supports the following driver:

Driver name	Packaged as	Driver type
IBM Data Server Driver for JDBC and SQLJ	<ul style="list-style-type: none"><li>• db2jcc.jar and sqlj.zip for JDBC 3.0 support</li><li>• db2jcc4.jar and sqlj4.zip for support of some JDBC 4.0 or later functions</li></ul>	Type 2 and Type 4

## IBM Data Server Driver for JDBC and SQLJ (type 2 and type 4)

The IBM Data Server Driver for JDBC and SQLJ is a single driver that includes JDBC type 2 and JDBC type 4 behavior. When an application loads the IBM Data Server Driver for JDBC and SQLJ, a single driver instance is loaded for type 2 and type 4 implementations. The application can make type 2 and type 4 connections using this single driver instance. The type 2 and type 4 connections can be made concurrently. IBM Data Server Driver for JDBC and SQLJ type 2 driver behavior is referred to as *IBM Data Server Driver for JDBC and SQLJ type 2 connectivity*. IBM Data Server Driver for JDBC and SQLJ type 4 driver behavior is referred to as *IBM Data Server Driver for JDBC and SQLJ type 4 connectivity*.

Two versions of the IBM Data Server Driver for JDBC and SQLJ are available. IBM Data Server Driver for JDBC and SQLJ version 3.5x is JDBC 3.0-compliant. IBM Data Server Driver for JDBC and SQLJ version 4.x is compliant with JDBC 4.0 or later.

The IBM Data Server Driver for JDBC and SQLJ supports these JDBC and SQLJ functions:

- Version 3.5x supports all of the methods that are described in the JDBC 3.0 specifications.
- Version 4.x supports all of the methods that are described in the JDBC 4.0 or later specifications.
- SQLJ application programming interfaces, as defined by the SQLJ standards, for simplified data access from Java applications.
- Connections that are enabled for connection pooling. WebSphere® Application Server or another application server does the connection pooling.
- Connections to a data server from Java user-defined functions and stored procedures use IBM Data Server Driver for JDBC and SQLJ type 2 connectivity only. Applications that call user-defined functions or stored procedures can use IBM Data Server Driver for JDBC and SQLJ type 2 connectivity or IBM Data Server Driver for JDBC and SQLJ type 4 connectivity to connect to a data server. The IBM Data Server Driver for JDBC and SQLJ is the default driver for Java routines.
- Support for distributed transaction management. This support implements the Java 2 Platform, Enterprise Edition (J2EE) Java Transaction Service (JTS) and Java Transaction API (JTA) specifications, which conform to the X/Open standard for distributed transactions (*Distributed Transaction Processing: The XA Specification*, available from <http://www.opengroup.org>).

## JDBC driver and database version compatibility

The compatibility of a particular version of the IBM Data Server Driver for JDBC and SQLJ with a database version depends on the type of driver connectivity that you are using and the type of data source to which you are connecting.

### Compatibility for IBM Data Server Driver for JDBC and SQLJ type 4 connectivity

The IBM Data Server Driver for JDBC and SQLJ is always downward compatible with DB2 databases at the previous release level. For example, IBM Data Server Driver for JDBC and SQLJ type 4 connectivity from the IBM Data Server Driver for JDBC and SQLJ version 3.61, which is shipped with DB2 Database for Linux, UNIX, and Windows Version 9.7 Fix Pack 3, to a DB2 Database for Linux, UNIX, and Windows Version 8 database is supported.

The IBM Data Server Driver for JDBC and SQLJ is upward compatible with the next version of a DB2 database if the applications under which the driver runs use no new features. For example, IBM Data Server Driver for JDBC and SQLJ type 4 connectivity from the IBM Data Server Driver for JDBC and SQLJ version 2.x, which is shipped with DB2 for z/OS® Version 8, to a DB2 for z/OS Version 9.1 database is supported, if the applications under which the driver runs contain no DB2 for z/OS Version 9.1 features.

IBM Data Server Driver for JDBC and SQLJ type 4 connectivity to IBM Informix is supported only for IBM Informix Version 11 and later.

### Compatibility for IBM Data Server Driver for JDBC and SQLJ type 2 connectivity

In general, IBM Data Server Driver for JDBC and SQLJ type 2 connectivity is intended for connections to the local database system, using the driver version that is shipped with that database version. For example, version 3.6x of the IBM Data Server Driver for JDBC and SQLJ is shipped with DB2 Database for Linux, UNIX, and Windows Version 9.5 and Version 9.7, and DB2 for z/OS Version 8 and later.

However, for IBM Data Server Driver for JDBC and SQLJ type 2 connectivity to a local DB2 Database for Linux, UNIX, and Windows database, the database version can be one version earlier or one version later than the DB2 Database for Linux, UNIX, and Windows version with which the driver was shipped. For IBM Data Server Driver for JDBC and SQLJ type 2 connectivity to a local DB2 for z/OS subsystem, the subsystem version can be one version later than the DB2 for z/OS version with which the driver was shipped.

If the database version to which your applications are connecting is later than the database version with which the driver was shipped, the applications cannot use features of the later database version.

## DB2 for Linux, UNIX, and Windows and IBM Data Server Driver for JDBC and SQLJ levels

Each version of DB2 for Linux, UNIX, and Windows is shipped with a JDBC 3 version and a JDBC 4 version of the IBM Data Server Driver for JDBC and SQLJ.

The following table lists the DB2 for Linux, UNIX, and Windows versions and corresponding IBM Data Server Driver for JDBC and SQLJ versions. You can use this information to determine the level of DB2 for Linux, UNIX, and Windows or DB2 Connect™ that is associated with the IBM Data Server Driver for JDBC and SQLJ instance under which a client program is running.

*Table 1. DB2 Database for Linux, UNIX, and Windows fix pack levels and versions of the IBM Data Server Driver for JDBC and SQLJ*

DB2 version and fix pack level	IBM Data Server Driver for JDBC and SQLJ version <sup>1</sup>
DB2 Version 10.1	3.63.xx, 4.13.xx
DB2 Version 9.7 Fix Pack 5	3.63.xx, 4.13.xx
DB2 Version 9.7 Fix Pack 4	3.62.xx, 4.12.xx
DB2 Version 9.7 Fix Pack 2	3.59.xx, 4.9.xx
DB2 Version 9.7 Fix Pack 1	3.58.xx, 4.8.xx
DB2 Version 9.7	3.57.xx, 4.7.xx
DB2 Version 9.5 Fix Pack 7	3.61.xx, 4.8.xx
DB2 Version 9.5 Fix Pack 6	3.58.xx, 4.8.xx
DB2 Version 9.5 Fix Pack 5	3.57.xx, 4.7.xx
DB2 Version 9.5 Fix Pack 3 and Fix Pack 4	3.53.xx, 4.3.xx
DB2 Version 9.5 Fix Pack 2	3.52.xx, 4.2.xx
DB2 Version 9.5 Fix Pack 1	3.51.xx, 4.1.xx
DB2 Version 9.5	3.50.xx, 4.0.xx
DB2 Version 9.1 Fix Pack 5 and later	3.7.xx
DB2 Version 9.1 Fix Pack 4	3.6.xx
DB2 Version 9.1 Fix Pack 3	3.4.xx
DB2 Version 9.1 Fix Pack 2	3.3.xx
DB2 Version 9.1 Fix Pack 1	3.2.xx
DB2 Version 9.1	3.1.xx

*Table 1. DB2 Database for Linux, UNIX, and Windows fix pack levels and versions of the IBM Data Server Driver for JDBC and SQLJ (continued)*

DB2 version and fix pack level	IBM Data Server Driver for JDBC and SQLJ version <sup>1</sup>
<b>Note:</b>	
1. All driver versions are of the form <i>n.m.xx</i> . <i>n.m</i> stays the same within a GA level or a fix pack level. <i>xx</i> changes when a new version of the IBM Data Server Driver for JDBC and SQLJ is introduced through an APAR fix.	

You can find more detailed information about IBM Data Server Driver for JDBC and SQLJ and DB2 Database for Linux, UNIX, and Windows versions at the following URL:

<http://www.ibm.com/support/docview.wss?&uid=swg21363866>





---

## Chapter 2. Installing the IBM Data Server Driver for JDBC and SQLJ

After you install the IBM Data Server Driver for JDBC and SQLJ, you can prepare and run JDBC or SQLJ applications.

### Before you begin

Before you install the IBM Data Server Driver for JDBC and SQLJ, you need the following software.

- An SDK for Java, 1.4.2 or later.

For all DB2 products except the IBM Data Server Runtime Client and the IBM Data Server Driver Package, the DB2 Database for Linux, UNIX, and Windows installation process automatically installs the SDK for Java, Version 5.

If you want to use JDBC 4.0 functions, you need to install an SDK for Java, 6 or later.

If you want to use JDBC 4.1 functions, you need to install an SDK for Java, 7 or later.

If you plan to run JDBC or SQLJ applications on your system, but not to prepare them, you need a Java run-time environment only.

**Important:** Support for the SDK for Java 1.4.2 is deprecated for Java routines, and might be discontinued in a future release.

- JVM native threads support

Any JVMs that run Java applications that access DB2 databases must include native threads support. You can specify native threads as the default thread support for some JVMs by setting the `THREADS_FLAG` environment variable to "native". Refer to the documentation for your Java environment for instructions on making native threads the default on your system.

- Unicode support for System i<sup>®</sup> servers

If any SQLJ or JDBC programs will use IBM Data Server Driver for JDBC and SQLJ type 4 connectivity to connect to a DB2 for i server, the System i operating system must support the Unicode UTF-8 encoding scheme. The following table lists the System i PTFs that you need for Unicode UTF-8 support:

*Table 2. System i PTFs for Unicode UTF-8 support*

System i version	PTF numbers
V5R3 or later	None (support is included)

- Java support for HP-UX clients and servers

*HP-UX servers:* The IBM Data Server Driver for JDBC and SQLJ does not support databases that are in the HP-UX default character set, Roman8. Therefore, when you create a database on an HP-UX server that you plan to access with the IBM Data Server Driver for JDBC and SQLJ, you need to create the database with a different character set.

*HP-UX clients and servers:* The Java environment on an HP-UX system requires special setup to run stored procedures under the IBM Data Server Driver for JDBC and SQLJ.

## About this task

**Restriction:** If you install the IBM Data Server Driver for JDBC and SQLJ on a Windows 64-bit operating system, you cannot use IBM Data Server Driver for JDBC and SQLJ type 2 connectivity to connect to a DB2 Database for Linux, UNIX, and Windows instance from a 32-bit Java application.

Follow these steps to install the IBM Data Server Driver for JDBC and SQLJ.

## Procedure

1. During the DB2 Database for Linux, UNIX, and Windows installation process, select Java support on UNIX or Linux, or JDBC support on Windows. These selections are defaults. If you have already installed DB2 Database for Linux, UNIX, and Windows without JDBC support, you can run the installation process in Custom mode to add JDBC support.

Selection of Java support or JDBC support causes the installation process to perform the following actions:

- a. Installs the IBM Data Server Driver for JDBC and SQLJ class files.

The files are placed in the `sqllib\java` directory for Windows systems, or the `sqllib/java` directory for UNIX or Linux systems.

The files names are:

### **db2jcc.jar or db2jcc4.jar**

Include `db2jcc.jar` in the CLASSPATH if you plan to use the version of the IBM Data Server Driver for JDBC and SQLJ that includes only **JDBC 3.0 or earlier functions**.

Include `db2jcc4.jar` in the CLASSPATH if you plan to use the version of the IBM Data Server Driver for JDBC and SQLJ that includes **JDBC 4.0 or later functions, and JDBC 3.0 or earlier functions**.

### **sqlj.zip or sqlj4.zip**

Include `sqlj.zip` in the CLASSPATH if you plan to prepare SQLJ applications that include only **JDBC 3.0 or earlier functions**.

Include `sqlj4.zip` in the CLASSPATH if you plan to prepare SQLJ applications that include **JDBC 4.0 or later functions, and JDBC 3.0 or earlier functions**.

- b. Modifies the CLASSPATH to include the IBM Data Server Driver for JDBC and SQLJ class files.

**Important:** This step is performed automatically only for the `db2jcc.jar` and `sqlj.zip` file. If you are using the `db2jcc4.jar` file or the `sqlj4.zip` file, you must modify the CLASSPATH manually. Change `db2jcc.jar` to `db2jcc4.jar` or `sqlj.zip` to `sqlj4.zip` in the CLASSPATH.

You also need to make this change in every DB2 command line window that you open.

**Important:** Include `db2jcc.jar` or `db2jcc4.jar` in the CLASSPATH. Do not include both files.

**Important:** Include `sqlj.zip` or `sqlj4.zip` in the CLASSPATH. Do not include both files. Do not include `db2jcc.jar` with `sqlj4.zip`, or `db2jcc4.jar` with `sqlj.zip`.

- c. If IBM Data Server Driver for JDBC and SQLJ client license files exist, the installation process installs them and modifies the CLASSPATH to include them.

The files are placed in the sqllib\java directory for Windows systems, or the sqllib/java directory for UNIX or Linux systems. The file names are:

Table 3. IBM Data Server Driver for JDBC and SQLJ license files

License file	Server to which license file permits a connection	Product that includes license file
db2jcc_license_cisuz.jar	DB2 for z/OS DB2 for i	All DB2 Connect products

Client license files are not required for connections to DB2 Database for Linux, UNIX, and Windows, Cloudscape, or IBM Informix databases from the IBM Data Server Driver for JDBC and SQLJ version 3.50 or later. Client license files are not required for direct connections to DB2 for z/OS if DB2 Connect Unlimited Edition for System z<sup>®</sup> server license activation is performed.

**Recommendation:** If you connect to DB2 for z/OS data servers directly, rather than through a DB2 Connect gateway, and you use DB2 Connect Unlimited Edition for System z 9.7 Fix Pack 3 or later, you should activate the server license key for DB2 Connect Unlimited Edition for System z. You need to activate the license key on each DB2 for z/OS subsystem or data sharing group to which you will connect. See the DB2 Connect information for details on server license activation.

- d. Installs IBM Data Server Driver for JDBC and SQLJ native libraries for support of IBM Data Server Driver for JDBC and SQLJ type 2 connectivity. The files are placed in the sqllib\bin directory for Windows systems, or the sqllib/lib directory for UNIX or Linux systems.

The file names are:

**libdb2jct2.so**

For AIX<sup>®</sup>, HP-UX on IPF, Linux, and Solaris

**db2jct2.dll**

For Windows

As an alternative to installing the IBM Data Server Driver for JDBC and SQLJ class files during installation, you can download the class files, and follow the steps above to configure the driver. You cannot download the IBM Data Server Driver for JDBC and SQLJ type 2 connectivity native libraries. To download the IBM Data Server Driver for JDBC and SQLJ class files, follow these steps:

- - Go to <http://www.ibm.com/software/data/support/data-server-clients/download.html>.
  - Under Downloads and fixes, select View IBM Data Server Client Packages...
  - In the Refine my fix list window, select Show me more options.
  - On the Fix Central page, select Information Management in the Product Group field, IBM Data Server Client Packages in the Product field, the latest version in the Installed Version field, and All in the Platform field.
  - On the Identify fixes page, type "Data Server Driver for JDBC" in the Text field.

- On the Select fixes page, select the latest version of the IBM Data Server Driver for JDBC and SQLJ.
- On the Download options page, select the options that are appropriate for you.

- Extract the zip file into an empty directory.

The zip file contains the following files:

- **db2jcc.jar**
- **db2jcc4.jar**
- **sqlj.zip**
- **sqlj4.zip**

- Copy the files to the locations that are specified in step 1a on page 8 above.

After you have downloaded the IBM Data Server Driver for JDBC and SQLJ class files, you need to follow the entire procedure that is described in this topic to install the driver.

2. Customize the driver-wide configuration properties, if any of the defaults are inappropriate.
3. Configure TCP/IP.

Servers must be configured for TCP/IP communication in the following cases:

- JDBC or SQLJ applications that use IBM Data Server Driver for JDBC and SQLJ type 4 connectivity.
- JDBC or SQLJ applications that use IBM Data Server Driver for JDBC and SQLJ type 2 connectivity, and specify *server* and *port* in the connection URL.

Ensure that the TCP/IP listener is running. To activate the TCP/IP listener:

- a. Set the environment variable DB2COMM to TCPIP:

```
db2set DB2COMM=TCPIP
```

- b. Update the database manager configuration file with the TCP/IP service name as specified in the services file:

```
db2 update dbm cfg using SVCENAME TCP/IP-service-name
```

The port number used for applets and SQLJ programs needs to be the same as the TCP/IP SVCENAME number used in the database manager configuration file.

- c. Execute the db2stop and db2start commands for the service name setting to take effect.

4. On DB2 Database for Linux, UNIX, and Windows servers on which you plan to run Java stored procedures or user-defined functions, update the database manager configuration to include the path where the SDK for Java is located.

You can do this by entering commands similar to these on the server command line:

- For database systems on UNIX or Linux:

```
db2 update dbm cfg using JDK_PATH /home/db2inst/jdk15
```

*/home/db2inst/jdk15* is the path where the SDK for Java is installed.

- For database systems on Windows:

```
db2 update dbm cfg using JDK_PATH c:\Program Files\jdk15
```

*c:\Program Files\jdk15* is the path where the SDK for Java is installed.

To verify the correct value for the JDK\_PATH field in the DB2 database manager configuration, enter the following command on the database server:

```
db2 get dbm cfg
```

You might want to redirect the output to a file for easier viewing. The `JDK_PATH` field appears near the beginning of the output.

5. If you plan to call SQL procedures that are on DB2 Database for Linux, UNIX, and Windows servers from Java programs, and the date and time format that is associated with the territory code of the database servers is **not** the USA format, take the following actions:
  - a. Set the `DB2_SQLROUTINE_PREPOPTS` registry variable on the database servers to indicate that the default datetime format is ISO:

```
db2set DB2_SQLROUTINE_PREPOPTS="DATETIME ISO"
```
  - b. Redefine any existing SQL procedures that you plan to call from Java programs.

These steps are necessary to ensure that the calling application receives date and time values correctly.

6. If you plan to access DB2 for z/OS database servers with your Java applications, follow the instructions in "Special setup for accessing DB2 for z/OS servers from Java programs" in *Developing Java Applications*.

---

## DB2Binder utility

The DB2Binder utility binds the DB2 packages that are used at the data server by the IBM Data Server Driver for JDBC and SQLJ, and grants EXECUTE authority on the packages to PUBLIC. Optionally, the DB2Binder utility can rebind DB2 packages that are not part of the IBM Data Server Driver for JDBC and SQLJ.

### DB2Binder syntax

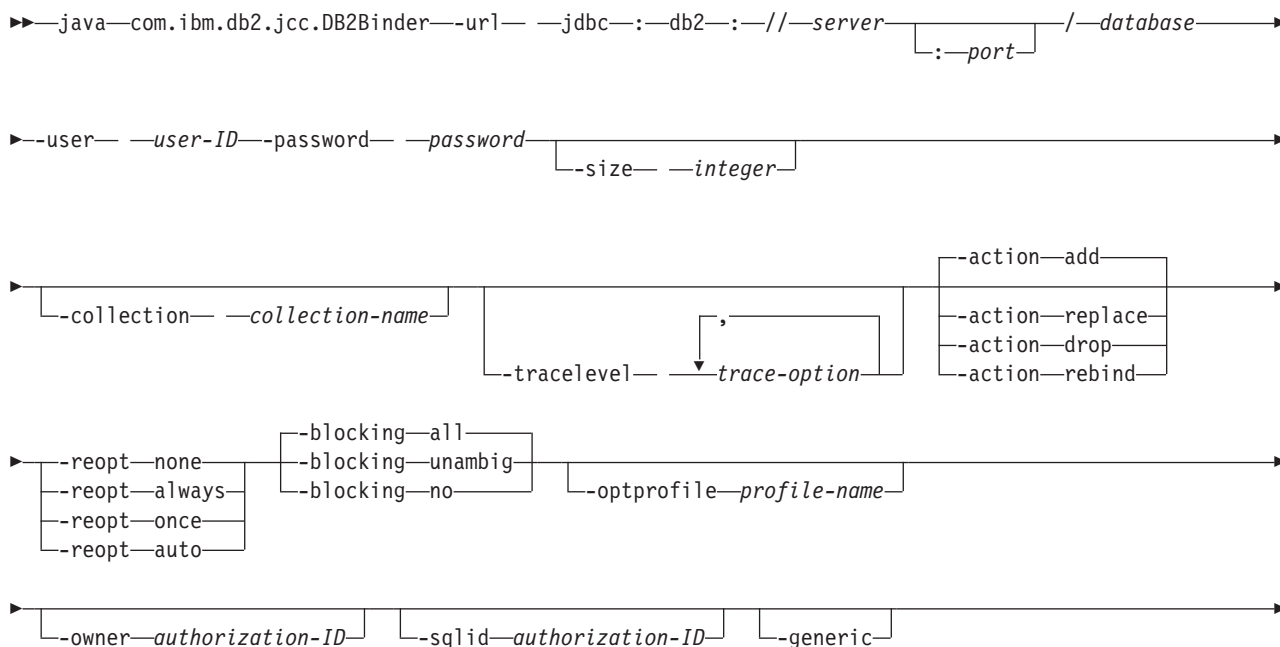

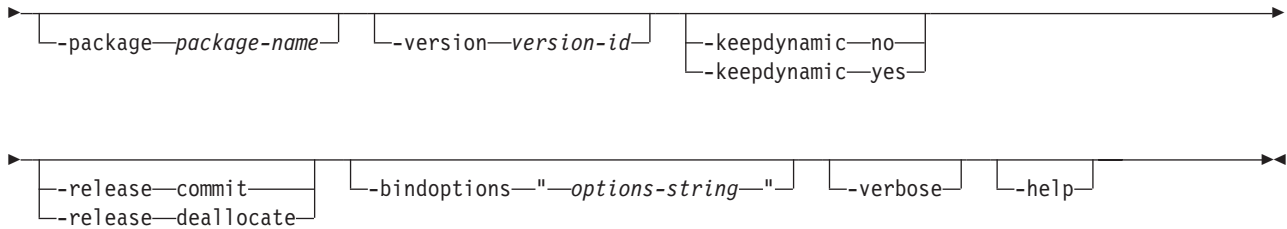

## DB2Binder option descriptions

### **-url**

Specifies the data source at which the IBM Data Server Driver for JDBC and SQLJ packages are to be bound. The variable parts of the `-url` value are:

#### **server**

The domain name or IP address of the operating system on which the data server resides.

#### **port**

The TCP/IP server port number that is assigned to the data server. The default is 446.

#### **database**

The location name for the data server, as defined in the SYSIBM.LOCATIONS catalog table.

### **-user**

Specifies the user ID under which the packages are to be bound. This user must have BIND authority on the packages.

### **-action**

Specifies the action to perform on the packages.

**add** Indicates that a package can be created only if it does not already exist. Add is the default.

#### **replace**

Indicates that a package can be created even if a package with the same name already exists. The new package replaces the old package.

#### **rebind**

Indicates that the existing package should be rebound. This option does not apply to IBM Data Server Driver for JDBC and SQLJ packages. If `-action rebind` is specified, `-generic` must also be specified.

#### **drop**

Indicates that packages should be dropped:

- For IBM Data Server Driver for JDBC and SQLJ packages, `-action drop` indicates that some or all IBM Data Server Driver for JDBC and SQLJ packages should be dropped. The number of packages depends on the `-size` parameter.
- For user packages, `-action drop` indicates that the specified package should be dropped.

`-action drop` applies only if the target data server is DB2 for z/OS.

### **-size**

Controls the number of Statement, PreparedStatement, or CallableStatement objects that can be open concurrently, or the number of IBM Data Server Driver for JDBC and SQLJ packages that are dropped.



The meaning of the `-size` parameter depends on the `-action` parameter:

- If the value of `-action` is `add` or `replace`, the value of `-size` is an integer that is used to calculate the number of DB2 packages that the IBM Data Server Driver for JDBC and SQLJ binds. If the value of `-size` is *integer*, the total number of packages is:

```
number-of-isolation-levels*  
number-of-holdability-values*  
integer+  
number-of-packages-for-static-SQL  
= 4*2*integer+1
```

The default `-size` value for `-action add` or `-action replace` is 3.

In most cases, the default of 3 is adequate. If your applications throw `SQLExceptions` with `-805 SQLCODEs`, check that the applications close all unused resources. If they do, increase the `-size` value.

If the value of `-action` is `replace`, and the value of `-size` results in fewer packages than already exist, no packages are dropped.

- If the value of `-action` is `drop`, the value of `-size` is the number of packages that are dropped. If `-size` is not specified, all IBM Data Server Driver for JDBC and SQLJ packages are dropped.
- If the value of `-action` is `rebind`, `-size` is ignored.

#### **-collection**

Specifies the collection ID for IBM Data Server Driver for JDBC and SQLJ or user packages. The default is `NULLID`. `DB2Binder` translates this value to uppercase.

You can create multiple instances of the IBM Data Server Driver for JDBC and SQLJ packages on a single data server by running `com.ibm.db2.jcc.DB2Binder` multiple times, and specifying a different value for `-collection` each time. At run time, you select a copy of the IBM Data Server Driver for JDBC and SQLJ by setting the `currentPackageSet` property to a value that matches a `-collection` value.

#### **-tracelevel**

Specifies what to trace while `DB2Binder` runs.

#### **-reopt**

Specifies whether data servers determine access paths at run time. This option is not sent to the data server if it is not specified. In that case, the data server determines the reoptimization behavior.

`-reopt` applies to connections to DB2 for z/OS Version 8 or later, or DB2 Database for Linux, UNIX, and Windows Version 9.1 or later.

**none** Specifies that access paths are not determined at run time.

#### **always**

Specifies that access paths are determined each time a statement is run.

**once** Specifies that DB2 determines and caches the access path for a dynamic statement only once at run time. DB2 uses this access path until the prepared statement is invalidated, or until the statement is removed from the dynamic statement cache and needs to be prepared again.

**auto** Specifies that access paths are automatically determined by the data server. `auto` is valid only for connections to DB2 for z/OS data servers.

**-blocking**

Specifies the type of row blocking for cursors.

**ALL** For cursors that are specified with the FOR READ ONLY clause or are not specified as FOR UPDATE, blocking occurs.

**UNAMBIG**

For cursors that are specified with the FOR READ ONLY clause, blocking occurs.

Cursors that are not declared with the FOR READ ONLY or FOR UPDATE clause which are not *ambiguous* and are *read-only* will be blocked. *Ambiguous* cursors will not be blocked.

**NO** Blocking does not occur for any cursor.

For the definition of a read-only cursor and an ambiguous cursor, refer to "DECLARE CURSOR".

**-optprofile**

Specifies an optimization profile that is used for optimization of data change statements in the packages. This profile is an XML file that must exist on the target server. If -optprofile is not specified, and the CURRENT OPTIMIZATION PROFILE special register is set, the value of CURRENT OPTIMIZATION PROFILE is used. If -optprofile is not specified, and CURRENT OPTIMIZATION PROFILE is not set, no optimization profile is used.

-optprofile is valid only for connections to DB2 Database for Linux, UNIX, and Windows data servers.

**-owner**

Specifies the authorization ID of the owner of the packages. The default value is set by the data server.

-owner applies only to IBM Data Server Driver for JDBC and SQLJ packages.

**-sqlid**

Specifies a value to which the CURRENT SQLID special register is set before DB2Binder executes GRANT operations on the IBM Data Server Driver for JDBC and SQLJ packages. If the primary authorization ID does not have a sufficient level of authority to grant privileges on the packages, and the primary authorization ID has an associated secondary authorization ID that has those privileges, set -sqlid to the secondary authorization ID.

-sqlid is valid only for connections to DB2 for z/OS data servers.

**-generic**

Specifies that DB2Binder rebinds a user package instead of the IBM Data Server Driver for JDBC and SQLJ packages. If -generic is specified, -action rebind and -package must also be specified.

**-package**

Specifies the name of the package that is to be rebound. This option applies only to user packages. If -package is specified, -action rebind and -generic must also be specified.

**-version**

Specifies the version ID of the package that is to be rebound. If -version is specified, -action rebind, -package, and -generic must also be specified.

**-keepdynamic**

Specifies whether the data server keeps already prepared dynamic SQL

statements in the dynamic statement cache after commit points, so that those prepared statements can be reused. `-keepdynamic` applies only to connections to DB2 for z/OS. Possible values are:

- no** The data server does not keep already prepared dynamic SQL statements in the dynamic statement cache after commit points.
- yes** The data server keeps already prepared dynamic SQL statements in the dynamic statement cache after commit points.

There is no default value for `-keepdynamic`. If you do not send a value to the data server, the setting at the data server determines whether dynamic statement caching is in effect. Dynamic statement caching occurs only if the EDM dynamic statement cache is enabled on the data server. The `CACHEDYN` subsystem parameter must be set to `YES` to enable the dynamic statement cache.

#### **-release**

Specifies when to release data server resources that a program uses. `-release` applies only to connections to DB2 for z/OS. Possible values are:

##### **deallocate**

Specifies that resources are released when a program terminates. `-release deallocate` is the default for DB2 for z/OS Version 10 and later.

##### **commit**

Specifies that resources are released at commit points. `-release commit` is the default for DB2 for z/OS Version 9 and earlier.

#### **-bindoptions**

Specifies a string that is enclosed in quotation marks. The contents of that string are one or more parameter and value pairs that represent options for rebinding a user package. All items in the string are delimited with spaces:  
*"parm1 value1 parm2 value2 ... parmn valuen"*

`-bindoptions` does not apply to IBM Data Server Driver for JDBC and SQLJ packages.

Possible parameters and values are:

##### **bindObjectExistenceRequired**

Specifies whether the data server issues an error and does not rebind the package, if all objects or needed privileges do not exist at rebind time. Possible values are:

- true** This option corresponds to the `SQLERROR(NOPACKAGE)` bind option.
- false** This option corresponds to the `SQLERROR(CONTINUE)` bind option.

##### **degreeIOParallelism**

Specifies whether to attempt to run static queries using parallel processing to maximize performance. Possible values are:

- 1** No parallel processing.  
This option corresponds to the `DEGREE(1)` bind option.
- 1** Allow parallel processing.  
This option corresponds to the `DEGREE(ANY)` bind option.

### **packageAuthorizationRules**

Determines the values that apply at run time for the following dynamic SQL attributes:

- The authorization ID that is used to check authorization
- The qualifier that is used for unqualified objects
- The source for application programming options that the data server uses to parse and semantically verify dynamic SQL statements
- Whether dynamic SQL statements can include GRANT, REVOKE, ALTER, CREATE, DROP, and RENAME statements

Possible values are:

- 0** Use run behavior. This is the default.  
This option corresponds to the DYNAMICRULES(RUN) bind option.
- 1** Use bind behavior.  
This option corresponds to the DYNAMICRULES(BIND) bind option.
- 2** When the package is run as or runs under a stored procedure or user-defined function package, the data server processes dynamic SQL statements using invoke behavior. Otherwise, the data server processes dynamic SQL statements using run behavior.  
This option corresponds to the DYNAMICRULES(INVOKERUN) bind option.
- 3** When the package is run as or runs under a stored procedure or user-defined function package, the data server processes dynamic SQL statements using invoke behavior. Otherwise, the data server processes dynamic SQL statements using bind behavior.  
This option corresponds to the DYNAMICRULES(INVOKEBIND) bind option.
- 4** When the package is run as or runs under a stored procedure or user-defined function package, the data server processes dynamic SQL statements using define behavior. Otherwise, the data server processes dynamic SQL statements using run behavior.  
This option corresponds to the DYNAMICRULES(DEFINERUN) bind option.
- 5** When the package is run as or runs under a stored procedure or user-defined function package, the data server processes dynamic SQL statements using define behavior. Otherwise, the data server processes dynamic SQL statements using bind behavior.  
This option corresponds to the DYNAMICRULES(DEFINEBIND) bind option.

### **packageOwnerIdentifier**

Specifies the authorization ID of the owner of the packages.

**isolationLevel**

Specifies how far to isolate an application from the effects of other running applications. Possible values are:

- 1 Uncommitted read  
This option corresponds to the ISOLATION(UR) bind option.
- 2 Cursor stability  
This option corresponds to the ISOLATION(CS) bind option.
- 3 Read stability  
This option corresponds to the ISOLATION(RS) bind option.
- 4 Repeatable read  
This option corresponds to the ISOLATION(RR) bind option.

**releasePackageResourcesAtCommit**

Specifies when to release resources that a program uses at each commit point. Possible values are:

- true** This option corresponds to the RELEASE(COMMIT) bind option.
- false** This option corresponds to the RELEASE(DEALLOCATE) bind option.

If `-bindoptions` is specified, `-generic` must also be specified.

**-verbose**

Specifies that the DB2Binder utility displays detailed information about the bind process.

**-help**

Specifies that the DB2Binder utility describes each of the options that it supports. If any other options are specified with `-help`, they are ignored.

**DB2Binder return codes when the target operating system is not Windows**

If the target data source for DB2Binder is not on the Windows operating system, DB2Binder returns one of the following return codes.

*Table 4. DB2Binder return codes when the target operating system is not Windows*

Return code	Meaning
0	Successful execution.
1	An error occurred during DB2Binder execution.

**DB2Binder return codes when the target operating system is Windows**

If the target data source for DB2Binder is on the Windows operating system, DB2Binder returns one of the following return codes.

Table 5. DB2Binder return codes when the target operating system is Windows

Return code	Meaning
0	Successful execution.
-100	No bind options were specified.
-101	-url value was not specified.
-102	-user value was not specified.
-103	-password value was not specified.
-200	No valid bind options were specified.
-114	The -package option was not specified, but the -generic option was specified.
-201	-url value is invalid.
-204	-action value is invalid.
-205	-blocking value is invalid.
-206	-collection value is invalid.
-207	-dbprotocol value is invalid.
-208	-keepdynamic value is invalid.
-210	-reopt value is invalid.
-211	-size value is invalid.
-212	-tracelevel value is invalid.
-307	-dbprotocol value is not supported by the target data server.
-308	-keepdynamic value is not supported by the target data server.
-310	-reopt value is not supported by the target data server.
-313	-optprofile value is not supported by the target data server.
-401	The Binder class was not found.
-402	Connection to the data server failed.
-403	DatabaseMetaData retrieval for the data server failed.
-501	No more packages are available in the cluster.
-502	An existing package is not valid.
-503	The bind process returned an error.
-999	An error occurred during processing of an undocumented bind option.

## DB2LobTableCreator utility

The DB2LobTableCreator utility creates tables on a DB2 for z/OS database server. Those tables are required by JDBC or SQLJ applications that use LOB locators to access data in DBCLOB or CLOB columns.

### DB2LobTableCreator syntax

```

▶▶—java—com.ibm.db2.jcc.DB2LobTableCreator—-url—jdbc:db2://server—[:port]—/—database—▶▶
▶—-user—user-ID—-password—password—[_help]—▶▶

```

## DB2LobTableCreator option descriptions

### **-url**

Specifies the data source at which DB2LobTableCreator is to run. The variable parts of the `-url` value are:

#### **jdbc:db2:**

Indicates that the connection is to a server in the DB2 family.

#### **server**

The domain name or IP address of the database server.

#### **port**

The TCP/IP server port number that is assigned to the database server. This is an integer between 0 and 65535. The default is 446.

#### **database**

A name for the database server.

*database* is the DB2 location name that is defined during installation. All characters in this value must be uppercase characters. You can determine the location name by executing the following SQL statement on the server:

```
SELECT CURRENT SERVER FROM SYSIBM.SYSDUMMY1;
```

### **-user**

Specifies the user ID under which DB2LobTableCreator is to run. This user must have authority to create tables in the DSNATPDB database.

### **-password**

Specifies the password for the user ID.

### **-help**

Specifies that the DB2LobTableCreator utility describes each of the options that it supports. If any other options are specified with `-help`, they are ignored.

---

## Customization of IBM Data Server Driver for JDBC and SQLJ configuration properties

The IBM Data Server Driver for JDBC and SQLJ configuration properties let you set property values that have driver-wide scope. Those settings apply across applications and DataSource instances. You can change the settings without having to change application source code or DataSource characteristics.

Each IBM Data Server Driver for JDBC and SQLJ configuration property setting is of this form:

*property=value*

You can set configuration properties in the following ways:

- Set the configuration properties as Java system properties. Configuration property values that are set as Java system properties override configuration property values that are set in any other ways.  
For stand-alone Java applications, you can set the configuration properties as Java system properties by specifying `-Dproperty=value` for each configuration property when you execute the java command.
- Set the configuration properties in a resource whose name you specify in the `db2.jcc.propertiesFile` Java system property. For example, you can specify an absolute path name for the `db2.jcc.propertiesFile` value.



For stand-alone Java applications, you can set the configuration properties by specifying the `-Ddb2.jcc.propertiesFile=path` option when you execute the java command.

- Set the configuration properties in a resource named `DB2JccConfiguration.properties`. A standard Java resource search is used to find `DB2JccConfiguration.properties`. The IBM Data Server Driver for JDBC and SQLJ searches for this resource only if you have not set the `db2.jcc.propertiesFile` Java system property.

`DB2JccConfiguration.properties` can be a stand-alone file, or it can be included in a JAR file.

If the `DB2JccConfiguration.properties` file is in the ISO 8859-1 (Latin-1) encoding scheme, or is in the Latin-1 encoding scheme with some Unicode-encoded (`\u` characters), you do not need to do character conversion before the IBM Data Server Driver for JDBC and SQLJ can use the file. If the `DB2JccConfiguration.properties` file is in some other encoding scheme, you need to use the Java `native2ascii` converter to convert the contents to Latin-1 or Unicode-encoded characters.

If `DB2JccConfiguration.properties` is a stand-alone file, the path for `DB2JccConfiguration.properties` must be in the CLASSPATH concatenation.

If `DB2JccConfiguration.properties` is in a JAR file, the JAR file must be in the CLASSPATH concatenation.

---

## Special setup for accessing DB2 for z/OS servers from Java programs

If you plan to write JDBC or SQLJ applications that access DB2 for z/OS database servers, your IBM Data Server Driver for JDBC and SQLJ installation process requires additional steps.

### About this task

Follow these steps to allow connectivity to DB2 for z/OS servers:

### Procedure

1. If you plan to connect to any DB2 for z/OS Version 7 or Version 8 database servers, install these PTFs on those database servers.

Table 6. PTFs for DB2 for z/OS stored procedures

DB2 for z/OS	PTF or APAR numbers
Version 7	UQ72083, UQ93889, UK21848
Version 8	UQ93890, UK21849
Version 9	PK44166

2. Run the `com.ibm.db2.jcc.DB2Binder` utility to bind the DB2 packages that are used at the server by the IBM Data Server Driver for JDBC and SQLJ.
3. On DB2 for z/OS database servers, customize and run job `DSNTIJMS`. `DSNTIJMS` is located in data set `prefix.SDSNSAMP`. It performs the following functions:
  - Creates the following stored procedures to support `DatabaseMetaData` methods, tracing, and error message formatting.
    - `SQLCOLPRIVILEGES`
    - `SQLCOLUMNS`
    - `SQLFOREIGNKEYS`
    - `SQLFUNCTIONS`

- SQLFUNCTIONCOLUMNS
  - SQLGETTYPEINFO
  - SQLPRIMARYKEYS
  - SQLPROCEDURECOLS
  - SQLPROCEDURES
  - SQLPSEUDOCOLUMNS (DB2 for z/OS Version 10 or later)
  - SQLSPECIALCOLUMNS
  - SQLSTATISTICS
  - SQLTABLEPRIVILEGES
  - SQLTABLES
  - SQLUDTS
  - SQLCAMESSAGE
- Creates the following tables to support efficient storing of data in CLOB or DBCLOB columns and the use of LOB locators for CLOB or DBCLOB retrieval:
    - SYSIBM.SYSDUMMYU
    - SYSIBM.SYSDUMMYA
    - SYSIBM.SYSDUMMYE

An alternative way to create those tables is to run the `com.ibm.db2.jcc.DB2LobTableCreator` utility on the client, against each of the DB2 for z/OS servers.

4. Enable Unicode support for OS/390® and z/OS servers.

If any SQLJ or JDBC programs will use IBM Data Server Driver for JDBC and SQLJ type 4 connectivity to connect to a DB2 for z/OS Version 7 server, the OS/390 or z/OS operating system must support the Unicode UTF-8 encoding scheme. This support requires OS/390 Version 2 Release 9 with APAR OW44581, or a later release of OS/390 or z/OS, plus the OS/390 R8/R9/R10 Support for Unicode. Information APARs II13048 and II13049 contain additional information.

5. If you plan to use IBM Data Server Driver for JDBC and SQLJ type 4 connectivity to implement distributed transactions against DB2 for z/OS Version 7 servers, run the `DB2T4XAIndoubtUtil` utility once for each of those DB2 for z/OS Version 7 servers.

---

## DB2T4XAIndoubtUtil for distributed transactions with DB2 UDB for OS/390 and z/OS Version 7 servers

If you plan to implement distributed transactions using IBM Data Server Driver for JDBC and SQLJ type 4 connectivity that include DB2 UDB for OS/390 and z/OS Version 7 servers, you need to run the `DB2T4XAIndoubtUtil` utility against those servers.

`DB2T4XAIndoubtUtil` allows Version 7 servers, which do not have built-in support for distributed transactions that implement the XA specification, to emulate that support.

`DB2T4XAIndoubtUtil` performs one or both of the following tasks:

- Creates a table named `SYSIBM.INDOUBT` and an associated index
- Binds DB2 packages named `T4XAIN01`, `T4XAIN02`, `T4XAIN03`, and `T4XAIN04`

You should create and drop packages `T4XAIN01`, `T4XAIN02`, `T4XAIN03`, and `T4XAIN04` only by running `DB2T4XAIndoubtUtil`. You can create and drop

SYSTEM.INDOUBT and its index manually, but it is recommended that you use the utility. See DB2T4XAIndoubtUtil usage notes for instructions on how to create those objects manually.

## DB2T4XAIndoubtUtil authorization

To run the DB2T4XAIndoubtUtil utility to create SYSTEM.INDOUBT and bind packages T4XAIN01, T4XAIN02, T4XAIN03, and T4XAIN04, you need SYSADM authority.

To run the DB2T4XAIndoubtUtil only to bind packages T4XAIN01, T4XAIN02, T4XAIN03, and T4XAIN04, you need BIND authority on the packages.

## DB2T4XAIndoubtUtil syntax

```

▶▶ java com.ibm.db2.jcc.DB2T4XAIndoubtUtil --url jdbc:db2://server[:port]/database
▶ --user user-ID --password password [-owner owner-ID] [-help] [-delete]
▶ [-priqty integer] [-secqty integer] [-bindonly] [-showSQL]
▶ [-jdbcCollection NULLID]
▶ [-jdbcCollection collection-ID]

```

## DB2T4XAIndoubtUtil parameter descriptions

### -url

Specifies the data source at which DB2T4XAIndoubtUtil is to run. The variable parts of the -url value are:

#### jdbc:db2:

Indicates that the connection is to a server in the DB2 family.

#### server

The domain name or IP address of the database server.

#### port

The TCP/IP server port number that is assigned to the database server. This is an integer between 0 and 65535. The default is 446.

#### database

A name for the database server.

*database* is the DB2 location name that is defined during installation. All characters in this value must be uppercase characters. You can determine the location name by executing the following SQL statement on the server:

```
SELECT CURRENT SERVER FROM SYSIBM.SYSDUMMY1;
```

### -user

Specifies the user ID under which DB2T4XAIndoubtUtil is to run. This user must have SYSADM authority or must be a member of a RACF® group that corresponds to a secondary authorization ID with SYSADM authority.

**-password**

Specifies the password for the user ID.

**-owner**

Specifies a secondary authorization ID that has SYSADM authority. Use the -owner parameter if the -user parameter value does not have SYSADM authority. The -user parameter value must be a member of a RACF group whose name is *owner-ID*.

When the -owner parameter is specified, DB2T4XAIndoubtUtil uses *owner-ID* as:

- The authorization ID for creating the SYSIBM.INDOUBT table.
- The authorization ID of the owner of the T4XAIN01, T4XAIN02, T4XAIN03, and T4XAIN04 packages. SQL statements in those packages are executed using the authority of *owner-ID*.

**-help**

Specifies that the DB2T4XAIndoubtUtil utility describes each of the options that it supports. If any other options are specified with -help, they are ignored.

**-delete**

Specifies that the DB2T4XAIndoubtUtil utility deletes the objects that were created when DB2T4XAIndoubtUtil was run previously.

**-priqty**

Specifies the primary space allocation, in kilobytes, for the table space that contains the SYSIBM.INDOUBT table. The default value for -priqty is 1000.

**Important:** The -priqty value divided by the page size for the table space in which SYSIBM.INDOUBT resides must be greater than the maximum number of indoubt transactions that are allowed at a given time. For example, for a 4 KB page size, the default -priqty value of 1000 allows about 250 concurrent indoubt transactions.

**-secqty**

Specifies the secondary space allocation, in kilobytes, for the table space that contains the SYSIBM.INDOUBT table. The default value for -secqty is 0.

**Recommendation:** Always use the default value of 0 for the -secqty value, and specify a -priqty value that is large enough to accommodate the maximum number of concurrent indoubt transactions.

**-bindonly**

Specifies that the DB2T4XAIndoubtUtil utility binds the T4XAIN01, T4XAIN02, T4XAIN03, and T4XAIN04 packages and grants permission to PUBLIC to execute the packages, but does not create the SYSIBM.INDOUBT table.

**-showSQL**

Specifies that the DB2T4XAIndoubtUtil utility displays the SQL statements that it executes.

**-jdbcCollection** *collection-name* | NULLID

Specifies the value of the -collection parameter that was used when the IBM Data Server Driver for JDBC and SQLJ packages were bound with the DB2Binder utility. The -jdbcCollection parameter *must* be specified if the explicitly or implicitly specified value of the -collection parameter was *not* NULLID.

The default is -jdbcCollection NULLID.

## DB2T4XAIndoubtUtil usage notes

To create the SYSTEM.INDOUBT table and its index manually, use these SQL statements:

```
CREATE TABLESPACE INDBTTS
  USING STOGROUP
  LOCKSIZE ROW
  BUFFERPOOL BP0
  SEGSIZE 32
  CCSID EBCDIC;

CREATE TABLE SYSIBM.INDOUBT(indbtXid VARCHAR(140) FOR BIT DATA NOT NULL,
                             uowId VARCHAR(25) FOR BIT DATA NOT NULL,
                             pSyncLog VARCHAR(150) FOR BIT DATA,
                             cSyncLog VARCHAR(150) FOR BIT DATA)

  IN INDBTTS;

CREATE UNIQUE INDEX INDBTIDX ON SYSIBM.INDOUBT(indbtXid, uowId);
```

## DB2T4XAIndoubtUtil example

Run the DB2T4XAIndoubtUtil to allow a DB2 for OS/390 and z/OS Version 7 subsystem that has IP address mvs1, port number 446, and DB2 location name SJCEC1 to participate in XA distributed transactions.

```
java com.ibm.db2.jcc.DB2T4XAIndoubtUtil -url jdbc:db2://mvs1:446/SJCEC1 \
  -user SYSADM -password mypass
```

---

## Chapter 3. JDBC application programming

Writing a JDBC application has much in common with writing an SQL application in any other language.

In general, you need to do the following things:

- Access the Java packages that contain JDBC methods.
- Declare variables for sending data to or retrieving data from DB2 tables.
- Connect to a data source.
- Execute SQL statements.
- Handle SQL errors and warnings.
- Disconnect from the data source.

Although the tasks that you need to perform are similar to those in other languages, the way that you execute those tasks is somewhat different.

---

### Example of a simple JDBC application

A simple JDBC application demonstrates the basic elements that JDBC applications need to include.

*Figure 1. Simple JDBC application*

```
import java.sql.*; 1

public class EzJava
{
    public static void main(String[] args)
    {
        String urlPrefix = "jdbc:db2:";
        String url;
        String user;
        String password;
        String empNo; 2
        Connection con;
        Statement stmt;
        ResultSet rs;

        System.out.println ("**** Enter class EzJava");

        // Check the that first argument has the correct form for the portion
        // of the URL that follows jdbc:db2:,
        // as described
        // in the Connecting to a data source using the DriverManager
        // interface with the IBM Data Server Driver for JDBC and SQLJ topic.
        // For example, for IBM Data Server Driver for
        // JDBC and SQLJ type 2 connectivity,
        // args[0] might be MVS1DB2M. For
        // type 4 connectivity, args[0] might
        // be //stlmvs1:10110/MVS1DB2M.

        if (args.length!=3)
        {
            System.err.println ("Invalid value. First argument appended to "+
                "jdbc:db2: must specify a valid URL.");
            System.err.println ("Second argument must be a valid user ID.");
            System.err.println ("Third argument must be the password for the user ID.");
        }
    }
}
```

```

        System.exit(1);
    }
    url = urlPrefix + args[0];
    user = args[1];
    password = args[2];
    try
    {
        // Load the driver
        Class.forName("com.ibm.db2.jcc.DB2Driver");
        System.out.println("**** Loaded the JDBC driver");
        3a

        // Create the connection using the IBM Data Server Driver for JDBC and SQLJ
        con = DriverManager.getConnection (url, user, password);
        // Commit changes manually
        con.setAutoCommit(false);
        System.out.println("**** Created a JDBC connection to the data source");
        3b

        // Create the Statement
        stmt = con.createStatement();
        System.out.println("**** Created JDBC Statement object");
        4a

        // Execute a query and generate a ResultSet instance
        rs = stmt.executeQuery("SELECT EMPNO FROM EMPLOYEE");
        System.out.println("**** Created JDBC ResultSet object");
        4b

        // Print all of the employee numbers to standard output device
        while (rs.next()) {
            empNo = rs.getString(1);
            System.out.println("Employee number = " + empNo);
        }
        System.out.println("**** Fetched all rows from JDBC ResultSet");
        // Close the ResultSet
        rs.close();
        System.out.println("**** Closed JDBC ResultSet");

        // Close the Statement
        stmt.close();
        System.out.println("**** Closed JDBC Statement");

        // Connection must be on a unit-of-work boundary to allow close
        con.commit();
        System.out.println ( "**** Transaction committed" );

        // Close the connection
        con.close();
        System.out.println("**** Disconnected from data source");
        6

        System.out.println("**** JDBC Exit from class EzJava - no errors");
    }

    catch (ClassNotFoundException e)
    {
        System.err.println("Could not load JDBC driver");
        System.out.println("Exception: " + e);
        e.printStackTrace();
    }

    catch(SQLException ex)
    {
        System.err.println("SQLException information");
        while(ex!=null) {
            System.err.println ("Error msg: " + ex.getMessage());
            System.err.println ("SQLSTATE: " + ex.getSQLState());
            System.err.println ("Error code: " + ex.getErrorCode());
            ex.printStackTrace();
            ex = ex.getNextException(); // For drivers that support chained exceptions
        }
    }

```

```

    }
  }
} // End main
} // End EzJava

```

Notes to Figure 1 on page 25:

Note	Description
1	This statement imports the java.sql package, which contains the JDBC core API. For information on other Java packages that you might need to access, see "Java packages for JDBC support".
2	String variable empNo performs the function of a host variable. That is, it is used to hold data retrieved from an SQL query. See "Variables in JDBC applications" for more information.
3a and 3b	These two sets of statements demonstrate how to connect to a data source using one of two available interfaces. See "How JDBC applications connect to a data source" for more details.
4a and 4b	Step 3a (loading the JDBC driver) is not necessary if you use JDBC 4.0 or later. These two sets of statements demonstrate how to perform a SELECT in JDBC. For information on how to perform other SQL operations, see "JDBC interfaces for executing SQL".
5	This try/catch block demonstrates the use of the SQLException class for SQL error handling. For more information on handling SQL errors, see "Handling an SQLException under the IBM Data Server Driver for JDBC and SQLJ". For information on handling SQL warnings, see "Handling an SQLWarning under the IBM Data Server Driver for JDBC and SQLJ".
6	This statement disconnects the application from the data source. See "Disconnecting from data sources in JDBC applications".

---

## How JDBC applications connect to a data source

Before you can execute SQL statements in any SQL program, you must be connected to a data source.

The IBM Data Server Driver for JDBC and SQLJ supports type 2 and type 4 connectivity. Connections to DB2 databases can use type 2 or type 4 connectivity. Connections to IBM Informix databases can use type 4 connectivity.

The following figure shows how a Java application connects to a data source using IBM Data Server Driver for JDBC and SQLJ type 2 connectivity.



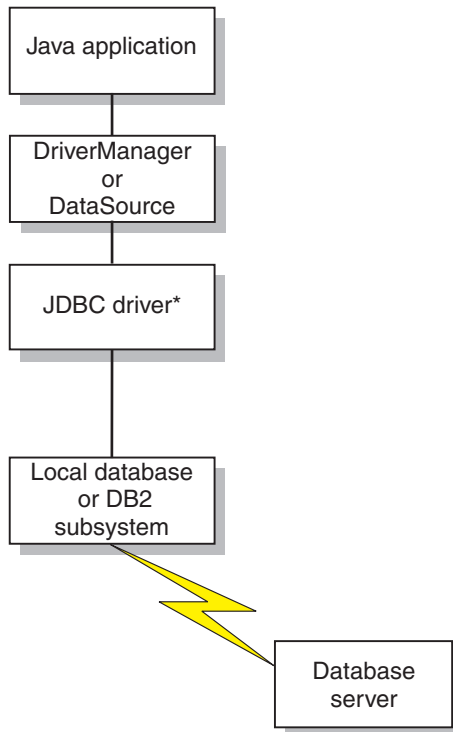

\*Java byte code executed under JVM, and native code

Figure 2. Java application flow for IBM Data Server Driver for JDBC and SQLJ type 2 connectivity

The following figure shows how a Java application connects to a data source using IBM Data Server Driver for JDBC and SQLJ type 4 connectivity.

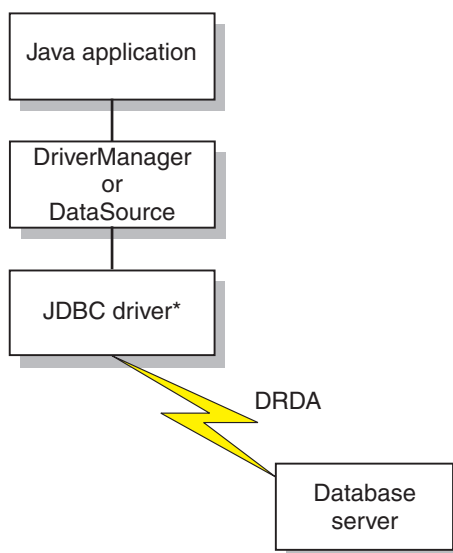

\*Java byte code executed under JVM

Figure 3. Java application flow for IBM Data Server Driver for JDBC and SQLJ type 4 connectivity

## Connecting to a data source using the DriverManager interface with the IBM Data Server Driver for JDBC and SQLJ

A JDBC application can establish a connection to a data source using the JDBC DriverManager interface, which is part of the `java.sql` package.

### About this task

The steps for establishing a connection are:

### Procedure

1. Load the JDBC driver by invoking the `Class.forName` method.

If you are using JDBC 4.0 or later, you do not need to explicitly load the JDBC driver.

For the IBM Data Server Driver for JDBC and SQLJ, you load the driver by invoking the `Class.forName` method with the following argument:

```
com.ibm.db2.jcc.DB2Driver
```

For compatibility with previous JDBC drivers, you can use the following argument instead:

```
COM.ibm.db2os390.sqlj.jdbc.DB2SQLJDriver
```

The following code demonstrates loading the IBM Data Server Driver for JDBC and SQLJ:

```
try {
    // Load the IBM Data Server Driver for JDBC and SQLJ with DriverManager
    Class.forName("com.ibm.db2.jcc.DB2Driver");
} catch (ClassNotFoundException e) {
    e.printStackTrace();
}
```

The catch block is used to print an error if the driver is not found.

2. Connect to a data source by invoking the `DriverManager.getConnection` method.

You can use one of the following forms of `getConnection`:

```
getConnection(String url);
getConnection(String url, user, password);
getConnection(String url, java.util.Properties info);
```

For IBM Data Server Driver for JDBC and SQLJ type 4 connectivity, the `getConnection` method must specify a user ID and password, through parameters or through property values.

The `url` argument represents a data source, and indicates what type of JDBC connectivity you are using.

The `info` argument is an object of type `java.util.Properties` that contains a set of driver properties for the connection. Specifying the `info` argument is an alternative to specifying `property=value`; strings in the URL. See "Properties for the IBM Data Server Driver for JDBC and SQLJ" for the properties that you can specify.

There are several ways to specify a user ID and password for a connection:

- Use the form of the `getConnection` method that specifies `url` with `property=value`; clauses, and include the user and password properties in the URL.
- Use the form of the `getConnection` method that specifies `user` and `password`.

- Use the form of the `getConnection` method that specifies *info*, after setting the user and password properties in a `java.util.Properties` object.

## Example

*Example: Establishing a connection and setting the user ID and password in a URL:*

```
String url = "jdbc:db2://myhost:5021/mydb:" +
    "user=dbadm;password=dbadm;";

// Set URL for data source
Connection con = DriverManager.getConnection(url);
// Create connection
```

*Example: Establishing a connection and setting the user ID and password in user and password parameters:*

```
String url = "jdbc:db2://myhost:5021/mydb";
// Set URL for data source

String user = "dbadm";
String password = "dbadm";
Connection con = DriverManager.getConnection(url, user, password);
// Create connection
```

*Example: Establishing a connection and setting the user ID and password in a java.util.Properties object:*

```
Properties properties = new Properties(); // Create Properties object
properties.put("user", "dbadm"); // Set user ID for connection
properties.put("password", "dbadm"); // Set password for connection
String url = "jdbc:db2://myhost:5021/mydb";
// Set URL for data source
Connection con = DriverManager.getConnection(url, properties);
// Create connection
```

## URL format for IBM Data Server Driver for JDBC and SQLJ type 4 connectivity

If you are using type 4 connectivity in your JDBC application, and you are making a connection using the `DriverManager` interface, you need to specify a URL in the `DriverManager.getConnection` call that indicates type 4 connectivity.

### IBM Data Server Driver for JDBC and SQLJ type 4 connectivity URL syntax

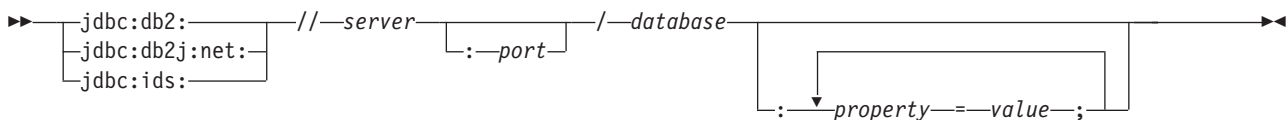

### IBM Data Server Driver for JDBC and SQLJ type 4 connectivity URL option descriptions

The parts of the URL have the following meanings:

#### **jdbc:db2: or jdbc:db2j:net:**

The meanings of the initial portion of the URL are:

#### **jdbc:db2:**

Indicates that the connection is to a DB2 for z/OS, DB2 Database for Linux, UNIX, and Windows.

`jdbc:db2:` can also be used for a connection to an IBM Informix database, for application portability.

**`jdbc:db2j:net:`**

Indicates that the connection is to a remote IBM Cloudscape server.

**`jdbc:ids:`**

Indicates that the connection is to an IBM Informix data source. `jdbc:informix-sqli:` also indicates that the connection is to an IBM Informix data source, but `jdbc:ids:` should be used.

**server**

The domain name or IP address of the data source.

**port**

The TCP/IP server port number that is assigned to the data source. This is an integer between 0 and 65535. The default is 446.

**database**

A name for the data source.

- If the connection is to a DB2 for z/OS server, *database* is the DB2 location name that is defined during installation. All characters in the DB2 location name must be uppercase characters. The IBM Data Server Driver for JDBC and SQLJ does not convert lowercase characters in the database value to uppercase for IBM Data Server Driver for JDBC and SQLJ type 4 connectivity.

You can determine the location name by executing the following SQL statement on the server:

```
SELECT CURRENT SERVER FROM SYSIBM.SYSDUMMY1;
```

- If the connection is to a DB2 for z/OS server or a DB2 for i server, all characters in *database* must be uppercase characters.
- If the connection is to a DB2 Database for Linux, UNIX, and Windows server, *database* is the database name that is defined during installation.
- If the connection is to an IBM Informix server, *database* is the database name. The name is case-insensitive. The server converts the name to lowercase.
- If the connection is to an IBM Cloudscape server, the *database* is the fully-qualified name of the file that contains the database. This name must be enclosed in double quotation marks ("). For example:

```
"c:/databases/testdb"
```

***property=value;***

A property and its value for the JDBC connection. You can specify one or more property and value pairs. Each property and value pair, including the last one, must end with a semicolon (;). Do not include spaces or other white space characters anywhere within the list of property and value strings.

Some properties with an int data type have predefined constant field values. You must resolve constant field values to their integer values before you can use those values in the *url* parameter. For example, you cannot use `com.ibm.db2.jcc.DB2BaseDataSource.TRACE_ALL` in a *url* parameter. However, you can build a URL string that includes `com.ibm.db2.jcc.DB2BaseDataSource.TRACE_ALL`, and assign the URL string to a String variable. Then you can use the String variable in the *url* parameter:

```
String url =  
    "jdbc:db2://sysmvs1.stl.ibm.com:5021/STLEC1" +  
    ":user=dbadm;password=dbadm;" +  
    "traceLevel=" +
```

```
(com.ibm.db2.jcc.DB2BaseDataSource.TRACE_ALL) + ";";
Connection con =
    java.sql.DriverManager.getConnection(url);
```

## URL format for IBM Data Server Driver for JDBC and SQLJ type 2 connectivity

If you are using type 2 connectivity in your JDBC application, and you are making a connection using the DriverManager interface, you need to specify a URL in the DriverManager.getConnection call that indicates type 2 connectivity.

### IBM Data Server Driver for JDBC and SQLJ type 2 connectivity URL syntax

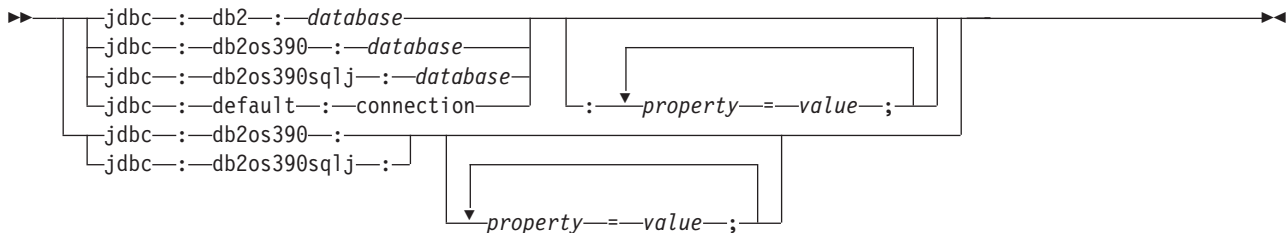

### IBM Data Server Driver for JDBC and SQLJ type 2 connectivity URL options descriptions

The parts of the URL have the following meanings:

**jdbc:db2:** or **jdbc:db2os390:** or **jdbc:db2os390sqlj:** or **jdbc:default:connection**

The meanings of the initial portion of the URL are:

**jdbc:db2:** or **jdbc:db2os390:** or **jdbc:db2os390sqlj:**

Indicates that the connection is to a DB2 for z/OS or DB2 Database for Linux, UNIX, and Windows server. `jdbc:db2os390:` and `jdbc:db2os390sqlj:` are for compatibility of programs that were written for older drivers, and apply to IBM Data Server Driver for JDBC and SQLJ type 2 connectivity to DB2 for z/OS only.

**jdbc:default:connection**

Indicates that the URL is for a connection to the local subsystem through a DB2 thread that is controlled by CICS®, IMS™, or the Java stored procedure environment.

#### database

A name for the database server.

- `database` is the database name that is defined during installation, if the value of the `serverName` connection property is null. If the value of `serverName` property is not null, `database` is a database alias.

#### property=value;

A property and its value for the JDBC connection. You can specify one or more property and value pairs. Each property and value pair, including the last one, must end with a semicolon (;). Do not include spaces or other white space characters anywhere within the list of property and value strings.

Some properties with an int data type have predefined constant field values. You must resolve constant field values to their integer values before you can use those values in the `url` parameter. For example, you cannot use `com.ibm.db2.jcc.DB2BaseDataSource.TRACE_ALL` in a `url` parameter. However,

you can build a URL string that includes `com.ibm.db2.jcc.DB2BaseDataSource.TRACE_ALL`, and assign the URL string to a String variable. Then you can use the String variable in the `url` parameter:

```
String url =
    "jdbc:db2:STLEC1" +
    ":user=dbadm;password=dbadm;" +
    "traceLevel=" +
    (com.ibm.db2.jcc.DB2BaseDataSource.TRACE_ALL) + ";";
Connection con =
    java.sql.DriverManager.getConnection(url);
```

## Connecting to a data source using the DataSource interface

If your applications need to be portable among data sources, you should use the DataSource interface.

### About this task

Using DriverManager to connect to a data source reduces portability because the application must identify a specific JDBC driver class name and driver URL. The driver class name and driver URL are specific to a JDBC vendor, driver implementation, and data source.

When you connect to a data source using the DataSource interface, you use a DataSource object.

The simplest way to use a DataSource object is to create and use the object in the same application, as you do with the DriverManager interface. However, this method does not provide portability.

The best way to use a DataSource object is for your system administrator to create and manage it separately, using WebSphere Application Server or some other tool. The program that creates and manages a DataSource object also uses the Java Naming and Directory Interface (JNDI) to assign a logical name to the DataSource object. The JDBC application that uses the DataSource object can then refer to the object by its logical name, and does not need any information about the underlying data source. In addition, your system administrator can modify the data source attributes, and you do not need to change your application program.

To learn more about using WebSphere to deploy DataSource objects, go to this URL on the web:

<http://www.ibm.com/software/webservers/appserv/>

To learn about deploying DataSource objects yourself, see "Creating and deploying DataSource objects".

You can use the DataSource interface and the DriverManager interface in the same application, but for maximum portability, it is recommended that you use only the DataSource interface to obtain connections.

To obtain a connection using a DataSource object that the system administrator has already created and assigned a logical name to, follow these steps:

### Procedure

1. From your system administrator, obtain the logical name of the data source to which you need to connect.

2. Create a Context object to use in the next step. The Context interface is part of the Java Naming and Directory Interface (JNDI), not JDBC.
3. In your application program, use JNDI to get the DataSource object that is associated with the logical data source name.
4. Use the DataSource.getConnection method to obtain the connection.

You can use one of the following forms of the getConnection method:

```
getConnection();
getConnection(String user, String password);
```

Use the second form if you need to specify a user ID and password for the connection that are different from the ones that were specified when the DataSource was deployed.

## Example

*Example of obtaining a connection using a DataSource object that was created by the system administrator:* In this example, the logical name of the data source that you need to connect to is jdbc/sampledb. The numbers to the right of selected statements correspond to the previously-described steps.

```
import java.sql.*;
import javax.naming.*;
import javax.sql.*;
...
Context ctx=new InitialContext();
DataSource ds=(DataSource)ctx.lookup("jdbc/sampledb");
Connection con=ds.getConnection();
```

2  
3  
4

Figure 4. Obtaining a connection using a DataSource object

*Example of creating and using a DataSource object in the same application:*

Figure 5. Creating and using a DataSource object in the same application

```
import java.sql.*;          // JDBC base
import javax.sql.*;        // Additional methods for JDBC
import com.ibm.db2.jcc.*;   // IBM Data Server Driver for JDBC and SQLJ
                           // interfaces
DB2SimpleDataSource dbds=new DB2SimpleDataSource();
dbds.setDatabaseName("dbloc1");
                           // Assign the location name
dbds.setDescription("Our Sample Database");
                           // Description for documentation
dbds.setUser("john");
                           // Assign the user ID
dbds.setPassword("dbadm");
                           // Assign the password
Connection con=dbds.getConnection();
                           // Create a Connection object
```

1

2  
3

4

Note	Description
1	Import the package that contains the implementation of the DataSource interface.
2	Creates a DB2SimpleDataSource object. DB2SimpleDataSource is one of the IBM Data Server Driver for JDBC and SQLJ implementations of the DataSource interface. See "Creating and deploying DataSource objects" for information on DB2's DataSource implementations.

Note	Description
3	The <code>setDatabaseName</code> , <code>setDescription</code> , <code>setUser</code> , and <code>setPassword</code> methods assign attributes to the <code>DB2SimpleDataSource</code> object. See "Properties for the IBM Data Server Driver for JDBC and SQLJ" for information about the attributes that you can set for a <code>DB2SimpleDataSource</code> object under the IBM Data Server Driver for JDBC and SQLJ.
4	Establishes a connection to the data source that <code>DB2SimpleDataSource</code> object <code>dbds</code> represents.

## How to determine which type of IBM Data Server Driver for JDBC and SQLJ connectivity to use

The IBM Data Server Driver for JDBC and SQLJ supports two types of connectivity: type 2 connectivity and type 4 connectivity.

For the `DriverManager` interface, you specify the type of connectivity through the URL in the `DriverManager.getConnection` method. For the `DataSource` interface, you specify the type of connectivity through the `driverType` property.

The following table summarizes the differences between type 2 connectivity and type 4 connectivity:

*Table 7. Comparison of IBM Data Server Driver for JDBC and SQLJ type 2 connectivity and IBM Data Server Driver for JDBC and SQLJ type 4 connectivity*

Function	IBM Data Server Driver for JDBC and SQLJ type 2 connectivity support	IBM Data Server Driver for JDBC and SQLJ type 4 connectivity support
Sysplex workload balancing and connection concentrator	Supported through DB2 Connect	Supported directly by the driver for a connection within a single JVM  Supported through DB2 Connect across JVMs
Communication protocols	TCP/IP	TCP/IP
Performance	Better for accessing a local DB2 server	Better for accessing a remote DB2 server
Installation	Requires installation of native libraries in addition to Java classes	Requires installation of Java classes only
Stored procedures	Can be used to call or execute stored procedures	Can be used only to call stored procedures
Distributed transaction processing (XA)	Supported	Supported
J2EE 1.4 compliance	Compliant	Compliant

The following points can help you determine which type of connectivity to use.

Use IBM Data Server Driver for JDBC and SQLJ type 2 connectivity under these circumstances:

- Your JDBC or SQLJ application runs locally most of the time.  
Local applications have better performance with type 2 connectivity.
- You are *running* a Java stored procedure.

A stored procedure environment consists of two parts: a client program, from which you call a stored procedure, and a server program, which is the stored



procedure. You can call a stored procedure in a JDBC or SQLJ program that uses type 2 or type 4 connectivity, but you must run a Java stored procedure using type 2 connectivity.

Use IBM Data Server Driver for JDBC and SQLJ type 4 connectivity under these circumstances:

- Your JDBC or SQLJ application runs remotely most of the time. Remote applications have better performance with type 4 connectivity.
- You are using IBM Data Server Driver for JDBC and SQLJ connection concentrator and Sysplex workload balancing support.

## JDBC connection objects

When you connect to a data source by either connection method, you create a Connection object, which represents the connection to the data source.

You use this Connection object to do the following things:

- Create Statement, PreparedStatement, and CallableStatement objects for executing SQL statements. These are discussed in "Executing SQL statements in JDBC applications".
- Gather information about the data source to which you are connected. This process is discussed in "Learning about a data source using DatabaseMetaData methods".
- Commit or roll back transactions. You can commit transactions manually or automatically. These operations are discussed in "Commit or roll back a JDBC transaction".
- Close the connection to the data source. This operation is discussed in "Disconnecting from data sources in JDBC applications".

## Creating and deploying DataSource objects

JDBC versions starting with version 2.0 provide the DataSource interface for connecting to a data source. Using the DataSource interface is the preferred way to connect to a data source.

### About this task

Using the DataSource interface involves two parts:

- Creating and deploying DataSource objects. This is usually done by a system administrator, using a tool such as WebSphere Application Server.
- Using the DataSource objects to create a connection. This is done in the application program.

This topic contains information that you need if you create and deploy the DataSource objects yourself.

The IBM Data Server Driver for JDBC and SQLJ provides the following DataSource implementations:

- `com.ibm.db2.jcc.DB2SimpleDataSource`, which does not support connection pooling. You can use this implementation with IBM Data Server Driver for JDBC and SQLJ type 2 connectivity or IBM Data Server Driver for JDBC and SQLJ type 4 connectivity.

- `com.ibm.db2.jcc.DB2ConnectionPoolDataSource`, which supports connection pooling. You can use this implementation with IBM Data Server Driver for JDBC and SQLJ type 2 connectivity or IBM Data Server Driver for JDBC and SQLJ type 4 connectivity.
- `com.ibm.db2.jcc.DB2XADataSource`, which supports connection pooling and distributed transactions. The connection pooling is provided by WebSphere Application Server or another application server. You can use this implementation only with IBM Data Server Driver for JDBC and SQLJ type 4 connectivity.

When you create and deploy a `DataSource` object, you need to perform these tasks:

1. Create an instance of the appropriate `DataSource` implementation.
2. Set the properties of the `DataSource` object.
3. Register the object with the Java Naming and Directory Interface (JNDI) naming service.

The following example shows how to perform these tasks.

```
import java.sql.*;           // JDBC base
import javax.naming.*;      // JNDI Naming Services
import javax.sql.*;        // Additional methods for JDBC
import com.ibm.db2.jcc.*;   // IBM Data Server Driver for
                           // JDBC and SQLJ
                           // implementation of JDBC
                           // standard extension APIs

DB2SimpleDataSource dbds = new com.ibm.db2.jcc.DB2SimpleDataSource(); 1

dbds.setDatabaseName("db2loc1");                                       2
dbds.setDescription("Our Sample Database");
dbds.setUser("john");
dbds.setPassword("mypw");
...
Context ctx=new InitialContext();                                       3
ctx.bind("jdbc/sampledb",dbds);                                        4
```

Figure 6. Example of creating and deploying a `DataSource` object

Note	Description
1	Creates an instance of the <code>DB2SimpleDataSource</code> class.
2	This statement and the next three statements set values for properties of this <code>DB2SimpleDataSource</code> object.
3	Creates a context for use by JNDI.
4	Associates <code>DBSimple2DataSource</code> object <code>dbds</code> with the logical name <code>jdbc/sampledb</code> . An application that uses this object can refer to it by the name <code>jdbc/sampledb</code> .

---

## Java packages for JDBC support

Before you can invoke JDBC methods, you need to be able to access all or parts of various Java packages that contain those methods.

You can do that either by importing the packages or specific classes, or by using the fully-qualified class names. You might need the following packages or classes for your JDBC program:

**java.sql**  
Contains the core JDBC API.

**javax.naming**

Contains classes and interfaces for Java Naming and Directory Interface (JNDI), which is often used for implementing a DataSource.

**javax.sql**

Contains methods for producing server-side applications using Java

**com.ibm.db2.jcc**

Contains the implementation of JDBC for the IBM Data Server Driver for JDBC and SQLJ.

---

## Learning about a data source using DatabaseMetaData methods

The DatabaseMetaData interface contains methods that retrieve information about a data source. These methods are useful when you write generic applications that can access various data sources.

### About this task

In generic applications that can access various data sources, you need to test whether a data source can handle various database operations before you execute them. For example, you need to determine whether the driver at a data source is at the JDBC 3.0 level before you invoke JDBC 3.0 methods against that driver.

DatabaseMetaData methods provide the following types of information:

- Features that the data source supports, such as the ANSI SQL level
- Specific information about the JDBC driver, such as the driver level
- Limits, such as the maximum number of columns that an index can have
- Whether the data source supports data definition statements (CREATE, ALTER, DROP, GRANT, REVOKE)
- Lists of objects at the data source, such as tables, indexes, or procedures
- Whether the data source supports various JDBC functions, such as batch updates or scrollable ResultSets
- A list of scalar functions that the driver supports

To invoke DatabaseMetaData methods, you need to perform these basic steps:

### Procedure

1. Create a DatabaseMetaData object by invoking the getMetaData method on the connection.
2. Invoke DatabaseMetaData methods to get information about the data source.
3. If the method returns a ResultSet:
  - a. In a loop, position the cursor using the next method, and retrieve data from each column of the current row of the ResultSet object using getXXX methods.
  - b. Invoke the close method to close the ResultSet object.

### Example

**Example:** The following code demonstrates how to use DatabaseMetaData methods to determine the driver version, to get a list of the stored procedures that are available at the data source, and to get a list of datetime functions that the driver supports. The numbers to the right of selected statements correspond to the previously-described steps.

Figure 7. Using DatabaseMetaData methods to get information about a data source

```

Connection con;
DatabaseMetaData dbmtda;
ResultSet rs;
int mtadtaint;
String procSchema;
String procName;
String dtfnList;
...
dbmtda = con.getMetaData(); // Create the DatabaseMetaData object 1
mtadtaint = dbmtda.getDriverVersion(); // Check the driver version 2
System.out.println("Driver version: " + mtadtaint);
rs = dbmtda.getProcedures(null, null, "%"); // Get information for all procedures
while (rs.next()) { // Position the cursor 3a
    procSchema = rs.getString("PROCEDURE_SCHEM"); // Get procedure schema
    procName = rs.getString("PROCEDURE_NAME"); // Get procedure name
    System.out.println(procSchema + "." + procName); // Print the qualified procedure name
}
dtfnList = dbmtda.getTimeDateFunctions(); // Get list of supported datetime functions
System.out.println("Supported datetime functions:");
System.out.println(dtfnList); // Print the list of datetime functions
rs.close(); // Close the ResultSet 3b

```

## DatabaseMetaData methods for identifying the type of data source

You can use the DatabaseMetaData.getDatabaseProductName and DatabaseMetaData.getProductVersion methods to identify the type and level of the database manager to which you are connected, and the operating system on which the database manager is running.

DatabaseMetaData.getDatabaseProductName returns a string that identifies the database manager and the operating system. The string has one of the following formats:

*database-product*  
*database-product/operating-system*

The following table shows examples of values that are returned by DatabaseMetaData.getDatabaseProductName.

Table 8. Examples of DatabaseMetaData.getDatabaseProductName values

getDatabaseProductName value	Database product
DB2	DB2 for z/OS
DB2/LINUX8664	DB2 Database for Linux, UNIX, and Windows on Linux on x86
IBM Informix/UNIX64	IBM Informix on UNIX

DatabaseMetaData.getDatabaseVersionName returns a string that contains the database product indicator and the version number, release number, and maintenance level of the data source.

The following table shows examples of values that are returned by `DatabaseMetaData.getDatabaseProductVersion`.

Table 9. Examples of `DatabaseMetaData.getDatabaseProductVersion` values

<code>getDatabaseProductVersion</code> value	Database product version
DSN09015	DB2 for z/OS Version 9.1 in new-function mode
SQL09010	DB2 Database for Linux, UNIX, and Windows Version 9.1
IFX11100	IBM Informix Version 11.10

## DatabaseMetaData extensions for obtaining information about modules

The `com.ibm.db2.jcc.DB2DatabaseMetaData` class contains methods that let you retrieve information about procedures, functions, and user-defined types that are in modules.

A *module* is a database object that is a collection of other database objects such as functions, procedures, types, and variables. Modules are similar to Java classes. The primary purpose of modules is to group together object definitions that have a common business purpose or use. Modules are supported by DB2 Database for Linux, UNIX, and Windows Version 9.7 or later.

The IBM Data Server Driver for JDBC and SQLJ provides the following methods in the `DB2DatabaseMetaData` interface that let you retrieve information about database objects that are in modules. Each method returns a result set that contains all of the columns in the related `java.sql.DatabaseMetaData` method, and an extra column that identifies the module in which the database object resides.

Method	Related <code>DatabaseMetaData</code> method	Information returned
<code>getDBFunctionColumns</code>	<code>getFunctionColumns</code>	Information about the parameters and return values for user-defined functions or built-in functions that are at a data source.
<code>getDBFunctions</code>	<code>getFunctions</code>	Information about the user-defined functions or built-in functions that are at a data source.
<code>getDBProcedureColumns</code>	<code>getProcedureColumns</code>	Information about the parameters and return values for stored procedures that are at a data source.
<code>getDBProcedures</code>	<code>getProcedures</code>	Information about the stored procedures that are at a data source.
<code>getDBUDTs</code>	<code>getUDTs</code>	Information about the user-defined types that are at a data source.

If the same stored procedures, functions, or user-defined types are defined in several different modules, and you call one of the `DatabaseMetaData` methods, those methods return more than one row for the same procedure, function, or

user-defined type. Those rows are identical, except for the SPECIFICNAME column. To uniquely identify stored procedures, functions, or user-defined types by module name, use the DB2DatabaseMetaData methods.

## Example

Suppose that your ID is DB2ADMIN, and you create two modules, named MYMOD1 and MYMOD2:

```
...
stmt.execute ("CREATE MODULE MYMOD1");
stmt.execute ("CREATE MODULE MYMOD2");
...
```

Next, you create the same SQL procedure named PROC1 in module MYMOD1 and module MYMOD2:

```
...
stmt.execute ("ALTER MODULE MYMOD1 PUBLISH PROCEDURE PROC1 ( " +
              "IN PARM1 BOOLEAN, " +
              "INOUT PARM2 INTEGER) " +
              "LANGUAGE SQL " +
              "BEGIN...END");
stmt.execute ("ALTER MODULE MYMOD2 PUBLISH PROCEDURE PROC1 ( " +
              "IN PARM1 BOOLEAN, " +
              "INOUT PARM2 INTEGER) " +
              "LANGUAGE SQL " +
              "BEGIN...END");
```

The following example uses the DB2DatabaseMetaData.getDBProcedures method to return information about all procedures named PROC1 in schema DB2ADMIN that are in modules with a name like "MYMOD%".

```
Connection con;
...
DatabaseMetaData dbmd = con.getMetaData();
// Establish a connection to the data source
// Create a DatabaseMetaData object
String schemaname="DB2ADMIN";
String modulename="MYMOD%";
String procname="PROC1";
// Indicate that you want information
// about all procedures that meet these
// criteria:
// Schema: DB2ADMIN
// Module: MYMOD%
// Procedure name: PROC1
ResultSet rs =
((com.ibm.db2.jcc.DB2DatabaseMetaData)dbmd).
getDBProcedures(null,schemaname,modulename,procname);
// Cast the DatabaseMetaData object
// to a DB2DatabaseMetaData object,
// and call DB2DatabaseMetaData.getDBProcedures
ResultSetMetaData rsmd = rs.getMetaData();
// Retrieve a ResultSetMetaData object from
// the ResultSet that contains the procedure
// information, so you know how many columns
// to retrieve, and the name of each column.
while (rs.next ()) {
System.out.println ("----- Row " + rowcount++ + " -----");
// Retrieve each row in the ResultSet
for (int i = 1; i <= rsmd.getColumnCount (); i++) {
System.out.println (i + ": " + rsmd.getColumnName (i) + " = " +
rs.getString (i));
}
}
}
```

The values that are returned are similar to these:

```
----- Row 1 -----
1: PROCEDURE_CAT = null
2: PROCEDURE_SCHEM = DBADMIN
3: ROUTINENAME = PROC1
4: NUM_INPUT_PARAMS = 0
5: NUM_OUTPUT_PARAMS = 0
6: RESULT_SETS = 0
7: REMARKS = null
8: PROCEDURE_TYPE = 1
9: SPECIFICNAME = SQL090504144847100
10: MODULENAME = MYMOD1
----- Row 2 -----
1: PROCEDURE_CAT = null
2: PROCEDURE_SCHEM = DBADMIN
3: ROUTINENAME = PROC1
4: NUM_INPUT_PARAMS = 0
5: NUM_OUTPUT_PARAMS = 0
6: RESULT_SETS = 0
7: REMARKS = null
8: PROCEDURE_TYPE = 1
9: SPECIFICNAME = SQL090504144847800
10: MODULENAME = MYMOD2
```

---

## Variables in JDBC applications

As in any other Java application, when you write JDBC applications, you declare variables. In Java applications, those variables are known as Java identifiers.

Some of those identifiers have the same function as host variables in other languages: they hold data that you pass to or retrieve from database tables. Identifier `empNo` in the following code holds data that you retrieve from the `EMPNO` table column, which has the `CHAR` data type.

```
String empNo;
// Execute a query and generate a ResultSet instance
rs = stmt.executeQuery("SELECT EMPNO FROM EMPLOYEE");
while (rs.next()) {
    String empNo = rs.getString(1);
    System.out.println("Employee number = " + empNo);
}
```

Your choice of Java data types can affect performance because DB2 picks better access paths when the data types of your Java variables map closely to the DB2 data types.

---

## JDBC interfaces for executing SQL

You execute SQL statements in a traditional SQL program to update data in tables, retrieve data from the tables, or call stored procedures. To perform the same functions in a JDBC program, you invoke methods.

Those methods are defined in the following interfaces:

- The `Statement` interface supports all SQL statement execution. The following interfaces inherit methods from the `Statement` interface:
  - The `PreparedStatement` interface supports any SQL statement containing input parameter markers. Parameter markers represent input variables. The `PreparedStatement` interface can also be used for SQL statements with no parameter markers.

With the IBM Data Server Driver for JDBC and SQLJ, the `PreparedStatement` interface can be used to call stored procedures that have input parameters and no output parameters, and that return no result sets. However, the preferred interface is `CallableStatement`.

- The `CallableStatement` interface supports the invocation of a stored procedure. The `CallableStatement` interface can be used to call stored procedures with input parameters, output parameters, or input and output parameters, or no parameters. With the IBM Data Server Driver for JDBC and SQLJ, you can also use the `Statement` interface to call stored procedures, but those stored procedures must have no parameters.
- The `ResultSet` interface provides access to the results that a query generates. The `ResultSet` interface has the same purpose as the cursor that is used in SQL applications in other languages.

## Creating and modifying database objects using the `Statement.executeUpdate` method

The `Statement.executeUpdate` is one of the JDBC methods that you can use to update tables and call stored procedures.

### About this task

You can use the `Statement.executeUpdate` method to do the following things:

- Execute data definition statements, such as `CREATE`, `ALTER`, `DROP`, `GRANT`, `REVOKE`
- Execute `INSERT`, `UPDATE`, `DELETE`, and `MERGE` statements that do not contain parameter markers.
- With the IBM Data Server Driver for JDBC and SQLJ, execute the `CALL` statement to call stored procedures that have no parameters and that return no result sets.

To execute these SQL statements, you need to perform these steps:

### Procedure

1. Invoke the `Connection.createStatement` method to create a `Statement` object.
2. Invoke the `Statement.executeUpdate` method to perform the SQL operation.
3. Invoke the `Statement.close` method to close the `Statement` object.

### Example

Suppose that you want to execute this SQL statement:

```
UPDATE EMPLOYEE SET PHONENO='4657' WHERE EMPNO='000010'
```

The following code creates `Statement` object `stmt`, executes the `UPDATE` statement, and returns the number of rows that were updated in `numUpd`. The numbers to the right of selected statements correspond to the previously-described steps.



```

Connection con;
Statement stmt;
int numUpd;
...
stmt = con.createStatement();           // Create a Statement object 1
numUpd = stmt.executeUpdate(
    "UPDATE EMPLOYEE SET PHONENO='4657' WHERE EMPNO='000010'"); 2
// Perform the update
stmt.close();                           // Close Statement object 3

```

Figure 8. Using `Statement.executeUpdate`

## Updating data in tables using the `PreparedStatement.executeUpdate` method

The `Statement.executeUpdate` method works if you update DB2 tables with constant values. However, updates often need to involve passing values in variables to DB2 tables. To do that, you use the `PreparedStatement.executeUpdate` method.

### About this task

With the IBM Data Server Driver for JDBC and SQLJ, you can also use `PreparedStatement.executeUpdate` to call stored procedures that have input parameters and no output parameters, and that return no result sets.

DB2 for z/OS does not support dynamic execution of the `CALL` statement. For calls to stored procedures that are on DB2 for z/OS data sources, the parameters can be parameter markers or literals, but not expressions. The following types of literals are supported:

- Integer
- Double
- Decimal
- Character
- Hexadecimal
- Graphic

For calls to stored procedures that are on IBM Informix data sources, the `PreparedStatement` object can be a `CALL` statement or an `EXECUTE PROCEDURE` statement.

When you execute an SQL statement many times, you can get better performance by creating the SQL statement as a `PreparedStatement`.

For example, the following `UPDATE` statement lets you update the employee table for only one phone number and one employee number:

```
UPDATE EMPLOYEE SET PHONENO='4657' WHERE EMPNO='000010'
```

Suppose that you want to generalize the operation to update the employee table for any set of phone numbers and employee numbers. You need to replace the constant phone number and employee number with variables:

```
UPDATE EMPLOYEE SET PHONENO=? WHERE EMPNO=?
```

Variables of this form are called parameter markers. To execute an SQL statement with parameter markers, you need to perform these steps:

## Procedure

1. Invoke the `Connection.prepareStatement` method to create a `PreparedStatement` object.
2. Invoke the `PreparedStatement.setXXX` methods to pass values to the input variables.  
This step assumes that you use standard parameter markers. Alternatively, if you use named parameter markers, you use IBM Data Server Driver for JDBC and SQLJ-only methods to pass values to the input parameters.
3. Invoke the `PreparedStatement.executeUpdate` method to update the table with the variable values.
4. Invoke the `PreparedStatement.close` method to close the `PreparedStatement` object when you have finished using that object.

## Example

The following code performs the previous steps to update the phone number to '4657' for the employee with employee number '000010'. The numbers to the right of selected statements correspond to the previously-described steps.

```
Connection con;
PreparedStatement pstmt;
int numUpd;
...
pstmt = con.prepareStatement(
    "UPDATE EMPLOYEE SET PHONENO=? WHERE EMPNO=?");
pstmt.setString(1,"4657");           // Create a PreparedStatement object      1
pstmt.setString(2,"000010");        // Assign first value to first parameter  2
numUpd = pstmt.executeUpdate();     // Assign first value to second parameter
pstmt.setString(1,"4658");          // Perform first update                  3
pstmt.setString(2,"000020");        // Assign second value to first parameter
numUpd = pstmt.executeUpdate();     // Assign second value to second parameter
pstmt.close();                      // Perform second update
// Close the PreparedStatement object      4
```

Figure 9. Using `PreparedStatement.executeUpdate` for an SQL statement with parameter markers

You can also use the `PreparedStatement.executeUpdate` method for statements that have no parameter markers. The steps for executing a `PreparedStatement` object with no parameter markers are similar to executing a `PreparedStatement` object with parameter markers, except you skip step 2. The following example demonstrates these steps.

```
Connection con;
PreparedStatement pstmt;
int numUpd;
...
pstmt = con.prepareStatement(
    "UPDATE EMPLOYEE SET PHONENO='4657' WHERE EMPNO='000010'");
numUpd = pstmt.executeUpdate();     // Create a PreparedStatement object      1
pstmt.close();                      // Perform the update                  3
// Close the PreparedStatement object      4
```

Figure 10. Using `PreparedStatement.executeUpdate` for an SQL statement without parameter markers

## JDBC executeUpdate methods against a DB2 for z/OS server

The JDBC standard states that the executeUpdate method returns a row count or 0. However, if the executeUpdate method is executed against a DB2 for z/OS server, it can return a value of -1.

For executeUpdate statements against a DB2 for z/OS server, the value that is returned depends on the type of SQL statement that is being executed:

- For an SQL statement that can have an update count, such as an INSERT, UPDATE, DELETE, or MERGE statement, the returned value is the number of affected rows. It can be:
  - A positive number, if a positive number of rows are affected by the operation, and the operation is not a mass delete on a segmented table space.
  - 0, if no rows are affected by the operation.
  - -1, if the operation is a mass delete on a segmented table space.
- For an SQL CALL statement, a value of -1 is returned, because the data source cannot determine the number of affected rows. Calls to getUpdateCount or getMoreResults for a CALL statement also return -1.
- For any other SQL statement, a value of -1 is returned.

## Making batch updates in JDBC applications

With batch updates, instead of updating rows of a table one at a time, you can direct JDBC to execute a group of updates at the same time. Statements that can be included in the same batch of updates are known as *batchable* statements.

### About this task

If a statement has input parameters or host expressions, you can include that statement only in a batch that has other instances of the same statement. This type of batch is known as a *homogeneous batch*. If a statement has no input parameters, you can include that statement in a batch only if the other statements in the batch have no input parameters or host expressions. This type of batch is known as a *heterogeneous batch*. Two statements that can be included in the same batch are known as *batch compatible*.

Use the following Statement methods for creating, executing, and removing a batch of SQL updates:

- addBatch
- executeBatch
- clearBatch

Use the following PreparedStatement and CallableStatement method for creating a batch of parameters so that a single statement can be executed multiple times in a batch, with a different set of parameters for each execution.

- addBatch

### Restrictions on executing statements in a batch:

- If you try to execute a SELECT statement in a batch, a BatchUpdateException is thrown.
- A CallableStatement object that you execute in a batch can contain output parameters. However, you cannot retrieve the values of the output parameters. If you try to do so, a BatchUpdateException is thrown.

- You cannot retrieve `ResultSet` objects from a `CallableStatement` object that you execute in a batch. A `BatchUpdateException` is not thrown, but the `getResultSet` method invocation returns a null value.

To make batch updates using several statements with no input parameters, follow these basic steps:

1. For each SQL statement that you want to execute in the batch, invoke the `addBatch` method.
2. Invoke the `executeBatch` method to execute the batch of statements.
3. Check for errors. If no errors occurred:
  - a. Get the number of rows that were affected by each SQL statement from the array that the `executeBatch` invocation returns. This number does not include rows that were affected by triggers or by referential integrity enforcement.
  - b. If `AutoCommit` is disabled for the `Connection` object, invoke the `commit` method to commit the changes.

If `AutoCommit` is enabled for the `Connection` object, the IBM Data Server Driver for JDBC and SQLJ adds a `commit` method at the end of the batch.

To make batch updates using a single statement with several sets of input parameters, follow these basic steps:

### Procedure

1. If the batched statement is a searched `UPDATE`, searched `DELETE`, or `MERGE` statement, set the `autocommit` mode for the connection to `false`.
2. Invoke the `prepareStatement` method to create a `PreparedStatement` object.
3. For each set of input parameter values:
  - a. Execute `setXXX` methods to assign values to the input parameters.
  - b. Invoke the `addBatch` method to add the set of input parameters to the batch.
4. Invoke the `executeBatch` method to execute the statements with all sets of parameters.
5. If no errors occurred:
  - a. Get the number of rows that were updated by each execution of the SQL statement from the array that the `executeBatch` invocation returns. The number of affected rows does not include rows that were affected by triggers or by referential integrity enforcement.

If the following conditions are true, the IBM Data Server Driver for JDBC and SQLJ returns `Statement.SUCCESS_NO_INFO (-2)`, instead of the number of rows that were affected by each SQL statement:

- The application is connected to a subsystem that is in DB2 for z/OS Version 8 new-function mode, or later.
- The application is using Version 3.1 or later of the IBM Data Server Driver for JDBC and SQLJ.
- The IBM Data Server Driver for JDBC and SQLJ uses multi-row `INSERT` operations to execute batch updates.

This occurs because with multi-row `INSERT`, the database server executes the entire batch as a single operation, so it does not return results for individual SQL statements.

- b. If `AutoCommit` is disabled for the `Connection` object, invoke the `commit` method to commit the changes.

- If AutoCommit is enabled for the Connection object, the IBM Data Server Driver for JDBC and SQLJ adds a commit method at the end of the batch.
- c. If the PreparedStatement object returns automatically generated keys, call DB2PreparedStatement.getDBGeneratedKeys to retrieve an array of ResultSet objects that contains the automatically generated keys.
 

Check the length of the returned array. If the length of the returned array is 0, an error occurred during retrieval of the automatically generated keys.
6. If errors occurred, process the BatchUpdateException.

## Example

In the following code fragment, two sets of parameters are batched. An UPDATE statement that takes two input parameters is then executed twice, once with each set of parameters. The numbers to the right of selected statements correspond to the previously-described steps.

```
try {
...
    PreparedStatement preps = conn.prepareStatement(
        "UPDATE DEPT SET MGRNO=? WHERE DEPTNO=?");
    ps.setString(1,mgrnum1);
    ps.setString(2,deptnum1);
    ps.addBatch();

    ps.setString(1,mgrnum2);
    ps.setString(2,deptnum2);
    ps.addBatch();
    int [] numUpdates=ps.executeBatch();
    for (int i=0; i < numUpdates.length; i++) {
        if (numUpdates[i] == SUCCESS_NO_INFO)
            System.out.println("Execution " + i +
                ": unknown number of rows updated");
        else
            System.out.println("Execution " + i +
                "successful: " numUpdates[i] + " rows updated");
    }
    conn.commit();
} catch (BatchUpdateException b) {
    // process BatchUpdateException
}
```

In the following code fragment, a batched INSERT statement returns automatically generated keys.

```
import java.sql.*;
import com.ibm.db2.jcc.*;
...
Connection conn;
...
try {
...
    PreparedStatement ps = conn.prepareStatement(
        "INSERT INTO DEPT (DEPTNO, DEPTNAME, ADMRDEPT) " +
        "VALUES (?, ?, ?)",
        Statement.RETURN_GENERATED_KEYS);
    ps.setString(1,"X01");
    ps.setString(2,"Finance");
    ps.setString(3,"A00");
    ps.addBatch();
    ps.setString(1,"Y01");
    ps.setString(2,"Accounting");
    ps.setString(3,"A00");
    ps.addBatch();
```

```

int [] numUpdates=preps.executeBatch(); 4

for (int i=0; i < numUpdates.length; i++) { 5a
    if (numUpdates[i] == SUCCESS_NO_INFO)
        System.out.println("Execution " + i +
            ": unknown number of rows updated");
    else
        System.out.println("Execution " + i +
            "successful: " numUpdates[i] + " rows updated");
}
conn.commit(); 5b
ResultSet[] resultList =
    ((DB2PreparedStatement)ps).getDBGeneratedKeys(); 5c
if (resultList.length != 0) {
    for (i = 0; i < resultList.length; i++) {
        while (resultList[i].next()) {
            java.math.BigDecimal idColVar = rs.getBigDecimal(1);
                // Get automatically generated key
                // value
            System.out.println("Automatically generated key value = "
                + idColVar);
        }
    }
}
else {
    System.out.println("Error retrieving automatically generated keys");
}
} catch (BatchUpdateException b) { 6
    // process BatchUpdateException
}

```

In the following code fragment, a batched UPDATE statement returns automatically generated keys. The code names the DEPTNO column as an automatically generated key, updates two rows in the DEPT table in a batch, and retrieves the values of DEPTNO for the updated rows. The numbers to the right of selected statements correspond to the previously described steps.

```

import java.sql.*;
import com.ibm.db2.jcc.*;
...
Connection conn;
...
String[] agkNames = {"DEPTNO"};
try {
    ...
    conn.setAutoCommit(false); 1
    PreparedStatement ps = conn.prepareStatement( 2
        "UPDATE DEPT SET DEPTNAME=? " +
        "WHERE DEPTNO=?",agkNames);
    ps.setString(1,"X01"); 3a
    ps.setString(2,"Planning");
    ps.addBatch(); 3b
    ps.setString(1,"Y01");
    ps.setString(2,"Bookkeeping");
    ps.addBatch();

    int [] numUpdates=ps.executeBatch(); 4

    for (int i=0; i < numUpdates.length; i++) { 5a
        if (numUpdates[i] == SUCCESS_NO_INFO)
            System.out.println("Execution " + i +
                ": unknown number of rows updated");
        else
            System.out.println("Execution " + i +
                "successful: " numUpdates[i] + " rows updated");
    }
    conn.commit(); 5b
}

```

```

ResultSet[] resultList =
    ((DB2PreparedStatement)ps).getDBGeneratedKeys(); 5c
if (resultList.length != 0) {
    for (i = 0; i < resultList.length; i++) {
        while (resultList[i].next()) {
            String deptNoKey = rs.getString(1);
                                // Get automatically generated key
                                // value
            System.out.println("Automatically generated key value = "
                + deptNoKey);
        }
    }
}
else {
    System.out.println("Error retrieving automatically generated keys");
}
}
catch (BatchUpdateException b) { 6
    // process BatchUpdateException
}

```

## Learning about parameters in a PreparedStatement using ParameterMetaData methods

The IBM Data Server Driver for JDBC and SQLJ includes support for the ParameterMetaData interface. The ParameterMetaData interface contains methods that retrieve information about the parameter markers in a PreparedStatement object.

### About this task

ParameterMetaData methods provide the following types of information:

- The data types of parameters, including the precision and scale of decimal parameters.
- The parameters' database-specific type names. For parameters that correspond to table columns that are defined with distinct types, these names are the distinct type names.
- Whether parameters are nullable.
- Whether parameters are input or output parameters.
- Whether the values of a numeric parameter can be signed.
- The fully-qualified Java class name that PreparedStatement.setObject uses when it sets a parameter value.

To invoke ParameterMetaData methods, you need to perform these basic steps:

### Procedure

1. Invoke the Connection.prepareStatement method to create a PreparedStatement object.
2. Invoke the PreparedStatement.getParameterMetaData method to retrieve a ParameterMetaData object.
3. Invoke ParameterMetaData.getParameterCount to determine the number of parameters in the PreparedStatement.
4. Invoke ParameterMetaData methods on individual parameters.

### Example

The following code demonstrates how to use ParameterMetaData methods to determine the number and data types of parameters in an SQL UPDATE statement.

The numbers to the right of selected statements correspond to the previously-described steps.

```
Connection con;
ParameterMetaData pmtadta;
int mtadtacnt;
String sqlType;
...
pstmt = con.prepareStatement(
    "UPDATE EMPLOYEE SET PHONENO=? WHERE EMPNO=?");
// Create a PreparedStatement object 1
pmtadta = pstmt.getParameterMetaData();
// Create a ParameterMetaData object 2
mtadtacnt = pmtadta.getParameterCount();
// Determine the number of parameters 3
System.out.println("Number of statement parameters: " + mtadtacnt);
for (int i = 1; i <= mtadtacnt; i++) {
    sqlType = pmtadta.getParameterTypeName(i);
    // Get SQL type for each parameter 4
    System.out.println("SQL type of parameter " + i + " is " + sqlType);
}
...
pstmt.close(); // Close the PreparedStatement
```

Figure 11. Using *ParameterMetaData* methods to get information about a *PreparedStatement*

## Data retrieval in JDBC applications

In JDBC applications, you retrieve data using *ResultSet* objects. A *ResultSet* represents the result set of a query.

### Retrieving data from tables using the *Statement.executeQuery* method

To retrieve data from a table using a *SELECT* statement with no parameter markers, you can use the *Statement.executeQuery* method.

#### About this task

This method returns a result table in a *ResultSet* object. After you obtain the result table, you need to use *ResultSet* methods to move through the result table and obtain the individual column values from each row.

With the IBM Data Server Driver for JDBC and SQLJ, you can also use the *Statement.executeQuery* method to retrieve a result set from a stored procedure call, if that stored procedure returns only one result set. If the stored procedure returns multiple result sets, you need to use the *Statement.execute* method.

This topic discusses the simplest kind of *ResultSet*, which is a read-only *ResultSet* in which you can only move forward, one row at a time. The IBM Data Server Driver for JDBC and SQLJ also supports updatable and scrollable *ResultSets*.

To retrieve rows from a table using a *SELECT* statement with no parameter markers, you need to perform these steps:

#### Procedure

1. Invoke the *Connection.createStatement* method to create a *Statement* object.
2. Invoke the *Statement.executeQuery* method to obtain the result table from the *SELECT* statement in a *ResultSet* object.



3. In a loop, position the cursor using the next method, and retrieve data from each column of the current row of the ResultSet object using getXXX methods. XXX represents a data type.
4. Invoke the ResultSet.close method to close the ResultSet object.
5. Invoke the Statement.close method to close the Statement object when you have finished using that object.

## Example

The following code demonstrates how to retrieve all rows from the employee table. The numbers to the right of selected statements correspond to the previously-described steps.

```
String empNo;
Connection con;
Statement stmt;
ResultSet rs;
...
stmt = con.createStatement(); // Create a Statement object 1
rs = stmt.executeQuery("SELECT EMPNO FROM EMPLOYEE"); // Get the result table from the query 2
while (rs.next()) { // Position the cursor 3
    empNo = rs.getString(1); // Retrieve only the first column value
    System.out.println("Employee number = " + empNo); // Print the column value
}
rs.close(); // Close the ResultSet 4
stmt.close(); // Close the Statement 5
```

Figure 12. Using Statement.executeQuery

## Retrieving data from tables using the PreparedStatement.executeQuery method

To retrieve data from a table using a SELECT statement with parameter markers, you use the PreparedStatement.executeQuery method.

### About this task

This method returns a result table in a ResultSet object. After you obtain the result table, you need to use ResultSet methods to move through the result table and obtain the individual column values from each row.

With the IBM Data Server Driver for JDBC and SQLJ, you can also use the PreparedStatement.executeQuery method to retrieve a result set from a stored procedure call, if that stored procedure returns only one result set and has only input parameters. If the stored procedure returns multiple result sets, you need to use the PreparedStatement.execute method.

You can also use the PreparedStatement.executeQuery method for statements that have no parameter markers. When you execute a query many times, you can get better performance by creating the SQL statement as a PreparedStatement.

To retrieve rows from a table using a SELECT statement with parameter markers, you need to perform these steps:

### Procedure

1. Invoke the Connection.prepareStatement method to create a PreparedStatement object.

2. Invoke `PreparedStatement.setXXX` methods to pass values to the input parameters.
3. Invoke the `PreparedStatement.executeQuery` method to obtain the result table from the `SELECT` statement in a `ResultSet` object.
4. In a loop, position the cursor using the `ResultSet.next` method, and retrieve data from each column of the current row of the `ResultSet` object using `getXXX` methods.
5. Invoke the `ResultSet.close` method to close the `ResultSet` object.
6. Invoke the `PreparedStatement.close` method to close the `PreparedStatement` object when you have finished using that object.

## Example

The following code demonstrates how to retrieve rows from the employee table for a specific employee. The numbers to the right of selected statements correspond to the previously-described steps.

```
String empnum, phonenum;
Connection con;
PreparedStatement pstmt;
ResultSet rs;
...
pstmt = con.prepareStatement(
    "SELECT EMPNO, PHONENO FROM EMPLOYEE WHERE EMPNO=?");
pstmt.setString(1,"000010");
rs = pstmt.executeQuery();
while (rs.next()) {
    empnum = rs.getString(1);
    phonenum = rs.getString(2);
    System.out.println("Employee number = " + empnum +
        "Phone number = " + phonenum);
}
rs.close();
pstmt.close();
```

1  
2  
3  
4  
5  
6

Figure 13. Example of using `PreparedStatement.executeQuery`

## Making batch queries in JDBC applications

The IBM Data Server Driver for JDBC and SQLJ provides a `IBM Data Server Driver for JDBC and SQLJ-only DB2PreparedStatement` interface that lets you perform batch queries on a homogeneous batch.

### About this task

To make batch queries using a single statement with several sets of input parameters, follow these basic steps:

#### Procedure

1. Invoke the `prepareStatement` method to create a `PreparedStatement` object for the `SQL` statement with input parameters.
2. For each set of input parameter values:
  - a. Execute `PreparedStatement.setXXX` methods to assign values to the input parameters.
  - b. Invoke the `PreparedStatement.addBatch` method to add the set of input parameters to the batch.

3. Cast the PreparedStatement object to a DB2PreparedStatement object, and invoke the DB2PreparedStatement.executeDB2QueryBatch method to execute the statement with all sets of parameters.
4. In a loop, retrieve the ResultSet objects:
  - a. Retrieve each ResultSet object.
  - b. Retrieve all the rows from each ResultSet object.

## Example

**Example:** In the following code fragment, two sets of parameters are batched. A SELECT statement that takes one input parameter is then executed twice, once with each parameter value. The numbers to the right of selected statements correspond to the previously described steps.

```

java.sql.Connection con = java.sql.DriverManager.getConnection(url, properties);
java.sql.Statement s = con.createStatement();
// Clean up from previous executions
try {
    s.executeUpdate ("drop table TestQBatch");
}
catch (Exception e) {
}

// Create and populate a test table
s.executeUpdate ("create table TestQBatch (col1 int, col2 char(10))");
s.executeUpdate ("insert into TestQBatch values (1, 'test1')");
s.executeUpdate ("insert into TestQBatch values (2, 'test2')");
s.executeUpdate ("insert into TestQBatch values (3, 'test3')");
s.executeUpdate ("insert into TestQBatch values (4, 'test4')");
s.executeUpdate ("insert into TestQBatch values (1, 'test5')");
s.executeUpdate ("insert into TestQBatch values (2, 'test6')");

try {
    PreparedStatement pstmt =
        con.prepareStatement("Select * from TestQBatch where col1 = ?");
    pstmt.setInt(1,1);
    pstmt.addBatch();
    // Add some more values to the batch
    pstmt.setInt(1,2);
    pstmt.addBatch();
    pstmt.setInt(1,3);
    pstmt.addBatch();
    pstmt.setInt(1,4);
    pstmt.addBatch();
    ((com.ibm.db2.jcc.DB2PreparedStatement)pstmt).executeDB2QueryBatch();
} catch (BatchUpdateException b) {
    // process BatchUpdateException
}
ResultSet rs;
while(pstmt.getMoreResults()) {
    rs = pstmt.getResultSet();
    while (rs.next()) {
        System.out.print (rs.getInt (1) + " ");
        System.out.println (rs.getString (2));
    }
    System.out.println();
    rs.close ();
}
// Clean up
s.close ();
pstmt.close ();
con.close ();

```

## Learning about a ResultSet using ResultSetMetaData methods

You cannot always know the number of columns and data types of the columns in a table or result set. This is true especially when you are retrieving data from a remote data source.

### About this task

When you write programs that retrieve unknown ResultSets, you need to use ResultSetMetaData methods to determine the characteristics of the ResultSets before you can retrieve data from them.

ResultSetMetaData methods provide the following types of information:

- The number of columns in a ResultSet
- The qualifier for the underlying table of the ResultSet
- Information about a column, such as the data type, length, precision, scale, and nullability
- Whether a column is read-only

After you invoke the executeQuery method to generate a ResultSet for a query on a table, follow these basic steps to determine the contents of the ResultSet:

### Procedure

1. Invoke the getMetaData method on the ResultSet object to create a ResultSetMetaData object.
2. Invoke the getColumnCount method to determine how many columns are in the ResultSet.
3. For each column in the ResultSet, execute ResultSetMetaData methods to determine column characteristics.

The results of ResultSetMetaData.getColumnNames call reflects the column name information that is stored in the DB2 catalog for that data source.

### Example

The following code demonstrates how to determine the data types of all the columns in the employee table. The numbers to the right of selected statements correspond to the previously-described steps.

```

String s;
Connection con;
Statement stmt;
ResultSet rs;
ResultSetMetaData rsmtadta;
int colCount;
int mtadtaint;
int i;
String colName;
String colType;
...
stmt = con.createStatement(); // Create a Statement object
rs = stmt.executeQuery("SELECT * FROM EMPLOYEE");
// Get the ResultSet from the query
rsmtadta = rs.getMetaData(); // Create a ResultSetMetaData object 1
colCount = rsmtadta.getColumnCount(); // Find number of columns in EMP 2
for (i=1; i<= colCount; i++) { 3
    colName = rsmtadta.getColumnName(); // Get column name
    colType = rsmtadta.getColumnTypeName(); // Get column data type
    System.out.println("Column = " + colName +
        " is data type " + colType);
    // Print the column value
}

```

Figure 14. Using *ResultSetMetaData* methods to get information about a *ResultSet*

## Characteristics of a JDBC *ResultSet* under the IBM Data Server Driver for JDBC and SQLJ

The IBM Data Server Driver for JDBC and SQLJ provides support for scrollable, updatable, and holdable cursors.

In addition to moving forward, one row at a time, through a *ResultSet*, you might want to do the following things:

- Move backward or go directly to a specific row
- Update, delete, or insert rows in a *ResultSet*
- Leave the *ResultSet* open after a COMMIT

The following terms describe characteristics of a *ResultSet*:

### scrollability

Whether the cursor for the *ResultSet* can move forward only, or forward one or more rows, backward one or more rows, or to a specific row.

If a cursor for a *ResultSet* is scrollable, it also has a sensitivity attribute, which describes whether the cursor is sensitive to changes to the underlying table.

### updatability

Whether the cursor can be used to update or delete rows. This characteristic does not apply to a *ResultSet* that is returned from a stored procedure, because a stored procedure *ResultSet* cannot be updated.

### holdability

Whether the cursor stays open after a COMMIT.

You set the updatability, scrollability, and holdability characteristics of a *ResultSet* through parameters in the `Connection.prepareStatement` or `Connection.createStatement` methods. The *ResultSet* settings map to attributes of a

cursor in the database. The following table lists the JDBC scrollability, updatability, and holdability settings, and the corresponding cursor attributes.

Table 10. JDBC ResultSet characteristics and SQL cursor attributes

JDBC setting	DB2 cursor setting	IBM Informix cursor setting
CONCUR_READ_ONLY	FOR READ ONLY	FOR READ ONLY
CONCUR_UPDATABLE	FOR UPDATE	FOR UPDATE
HOLD_CURSORS_OVER_COMMIT	WITH HOLD	WITH HOLD
TYPE_FORWARD_ONLY	SCROLL not specified	SCROLL not specified
TYPE_SCROLL_INSENSITIVE	INSENSITIVE SCROLL	SCROLL
TYPE_SCROLL_SENSITIVE	SENSITIVE STATIC, SENSITIVE DYNAMIC, or ASENSITIVE, depending on the cursorSensitivity Connection and DataSource property	Not supported

If a JDBC ResultSet is static, the size of the result table and the order of the rows in the result table do not change after the cursor is opened. This means that if you insert rows into the underlying table, the result table for a static ResultSet does not change. If you delete a row of a result table, a delete hole occurs. You cannot update or delete a delete hole.

### Specifying updatability, scrollability, and holdability for ResultSets in JDBC applications:

You use special parameters in the Connection.prepareStatement or Connection.createStatement methods to specify the updatability, scrollability, and holdability of a ResultSet.

#### About this task

By default, ResultSet objects are not scrollable and not updatable. The default holdability depends on the data source, and can be determined from the DatabaseMetaData.getResultSetHoldability method. To change the scrollability, updatability, and holdability attributes for a ResultSet, follow these steps:

#### Procedure

1. If the SELECT statement that defines the ResultSet has no input parameters, invoke the createStatement method to create a Statement object. Otherwise, invoke the prepareStatement method to create a PreparedStatement object. You need to specify forms of the createStatement or prepareStatement methods that include the *resultSetType*, *resultSetConcurrency*, or *resultSetHoldability* parameters. The form of the createStatement method that supports scrollability and updatability is:

```
createStatement(int resultSetType, int resultSetConcurrency);
```

The form of the createStatement method that supports scrollability, updatability, and holdability is:

```
createStatement(int resultSetType, int resultSetConcurrency,
    int resultSetHoldability);
```

The form of the prepareStatement method that supports scrollability and updatability is:

```
prepareStatement(String sql, int resultSetType,
    int resultSetConcurrency);
```

The form of the `prepareStatement` method that supports scrollability, updatability, and holdability is:

```
prepareStatement(String sql, int resultSetType,
    int resultSetConcurrency, int resultSetHoldability);
```

The following table contains a list of valid values for `resultSetType` and `resultSetConcurrency`.

*Table 11. Valid combinations of resultSetType and resultSetConcurrency for ResultSets*

<i>resultSetType</i> value	<i>resultSetConcurrency</i> value
TYPE_FORWARD_ONLY	CONCUR_READ_ONLY
TYPE_FORWARD_ONLY	CONCUR_UPDATABLE
TYPE_SCROLL_INSENSITIVE	CONCUR_READ_ONLY
TYPE_SCROLL_SENSITIVE <sup>1</sup>	CONCUR_READ_ONLY
TYPE_SCROLL_SENSITIVE <sup>1</sup>	CONCUR_UPDATABLE

**Note:**

1. This value does not apply to connections to IBM Informix.

`resultSetHoldability` has two possible values: `HOLD_CURSORS_OVER_COMMIT` and `CLOSE_CURSORS_AT_COMMIT`. Either of these values can be specified with any valid combination of `resultSetConcurrency` and `resultSetHoldability`. The value that you set overrides the default holdability for the connection.

**Restriction:** If the `ResultSet` is scrollable, and the `ResultSet` is used to select columns from a table on a DB2 Database for Linux, UNIX, and Windows server, the `SELECT` list of the `SELECT` statement that defines the `ResultSet` cannot include columns with the following data types:

- LONG VARCHAR
  - LONG VARCHAR
  - BLOB
  - CLOB
  - XML
  - A distinct type that is based on any of the previous data types in this list
  - A structured type
2. If the `SELECT` statement has input parameters, invoke `setXXX` methods to pass values to the input parameters.
  3. Invoke the `executeQuery` method to obtain the result table from the `SELECT` statement in a `ResultSet` object.
  4. For each row that you want to access:
    - a. Position the cursor using one of the methods that are listed in the following table.

*Table 12. ResultSet methods for positioning a scrollable cursor*

Method	Positions the cursor
<code>first</code> <sup>1</sup>	On the first row of the <code>ResultSet</code>
<code>last</code> <sup>1</sup>	On the last row of the <code>ResultSet</code>
<code>next</code> <sup>2</sup>	On the next row of the <code>ResultSet</code>
<code>previous</code> <sup>1,3</sup>	On the previous row of the <code>ResultSet</code>

Table 12. *ResultSet* methods for positioning a scrollable cursor (continued)

Method	Positions the cursor
<code>absolute(int n)</code> <sup>1,4</sup>	If $n > 0$ , on row $n$ of the <i>ResultSet</i> . If $n < 0$ , and $m$ is the number of rows in the <i>ResultSet</i> , on row $m+n+1$ of the <i>ResultSet</i> .
<code>relative(int n)</code> <sup>1,5,6</sup>	If $n > 0$ , on the row that is $n$ rows after the current row. If $n < 0$ , on the row that is $n$ rows before the current row. If $n = 0$ , on the current row.
<code>afterLast</code> <sup>1</sup>	After the last row in the <i>ResultSet</i>
<code>beforeFirst</code> <sup>1</sup>	Before the first row in the <i>ResultSet</i>

**Notes:**

1. This method does not apply to connections to IBM Informix.
2. If the cursor is before the first row of the *ResultSet*, this method positions the cursor on the first row.
3. If the cursor is after the last row of the *ResultSet*, this method positions the cursor on the last row.
4. If the absolute value of  $n$  is greater than the number of rows in the result set, this method positions the cursor after the last row if  $n$  is positive, or before the first row if  $n$  is negative.
5. The cursor must be on a valid row of the *ResultSet* before you can use this method. If the cursor is before the first row or after the last row, the method throws an *SQLException*.
6. Suppose that  $m$  is the number of rows in the *ResultSet* and  $x$  is the current row number in the *ResultSet*. If  $n > 0$  and  $x+n > m$ , the driver positions the cursor after the last row. If  $n < 0$  and  $x+n < 1$ , the driver positions the cursor before the first row.

- b. If you need to know the current cursor position, use the `getRow`, `isFirst`, `isLast`, `isBeforeFirst`, or `isAfterLast` method to obtain this information.
- c. If you specified a *resultSetType* value of `TYPE_SCROLL_SENSITIVE` in step 1 on page 57, and you need to see the latest values of the current row, invoke the `refreshRow` method.

**Recommendation:** Because refreshing the rows of a *ResultSet* can have a detrimental effect on the performance of your applications, you should invoke `refreshRow` *only* when you need to see the latest data.

- d. Perform one or more of the following operations:
  - To retrieve data from each column of the current row of the *ResultSet* object, use `getXXX` methods.
  - To update the current row from the underlying table, use `updateXXX` methods to assign column values to the current row of the *ResultSet*. Then use `updateRow` to update the corresponding row of the underlying table. If you decide that you do not want to update the underlying table, invoke the `cancelRowUpdates` method instead of the `updateRow` method. The *resultSetConcurrency* value for the *ResultSet* must be `CONCUR_UPDATABLE` for you to use these methods.
  - To delete the current row from the underlying table, use the `deleteRow` method. Invoking `deleteRow` causes the driver to replace the current row of the *ResultSet* with a hole. The *resultSetConcurrency* value for the *ResultSet* must be `CONCUR_UPDATABLE` for you to use this method.

5. Invoke the `close` method to close the *ResultSet* object.
6. Invoke the `close` method to close the *Statement* or *PreparedStatement* object.



## Example

The following code demonstrates how to retrieve all rows from the employee table in reverse order, and update the phone number for employee number "000010". The numbers to the right of selected statements correspond to the previously-described steps.

```
String s;
String stmtsrc;
Connection con;
Statement stmt;
ResultSet rs;
...
stmt = con.createStatement(ResultSet.TYPE_SCROLL_SENSITIVE,
                           ResultSet.CONCUR_UPDATABLE);           1
                           // Create a Statement object
                           // for a scrollable, updatable
                           // ResultSet

stmtsrc = "SELECT EMPNO, PHONENO FROM EMPLOYEE " +
          "FOR UPDATE OF PHONENO";

rs = stmt.executeQuery(stmtsrc);           3
rs.afterLast();                           // Position the cursor at the end of
                                           // the ResultSet           4a

while (rs.previous()) {                   // Position the cursor backward
    s = rs.getString("EMPNO");           // Retrieve the employee number 4d
                                           // (column 1 in the result
                                           // table)

    System.out.println("Employee number = " + s);
                                           // Print the column value

    if (s.compareTo("000010") == 0) {    // Look for employee 000010
        rs.updateString("PHONENO", "4657"); // Update their phone number
        rs.updateRow();                   // Update the row
    }
}
rs.close();                               // Close the ResultSet           5
stmt.close();                             // Close the Statement           6
```

Figure 15. Using a scrollable cursor

*Multi-row SQL operations in JDBC applications:*

The IBM Data Server Driver for JDBC and SQLJ supports multi-row INSERT, UPDATE, and FETCH for connections to data sources that support these operations.

### Multi-row INSERT

In JDBC applications, when you execute INSERT or MERGE statements that use parameter markers in a batch, if the data server supports multi-row INSERT, the IBM Data Server Driver for JDBC and SQLJ can transform the batch INSERT or MERGE operations into multi-row INSERT statements. Multi-row INSERT operations can provide better performance in the following ways:

- For local applications, multi-row INSERTs result in fewer accesses of the data server.
- For distributed applications, multi-row INSERTs result in fewer network operations.

You cannot execute a multi-row INSERT operation by including a multi-row INSERT statement in a statement string in your JDBC application.

Multi-row INSERT is used by default. You can use the Connection or DataSource property `enableMultiRowInsertSupport` to control whether multi-row INSERT is used. Multi-row INSERT cannot be used for INSERT FROM SELECT statements that are executed in a batch.

### Multi-row FETCH

Multi-row FETCH can provide better performance than retrieving one row with each FETCH statement. For IBM Data Server Driver for JDBC and SQLJ type 2 connectivity on DB2 for z/OS, multi-row FETCH can be used for forward-only cursors and scrollable cursors. For IBM Data Server Driver for JDBC and SQLJ type 4 connectivity, multi-row FETCH can be used only for scrollable cursors.

When you retrieve data in your applications, the IBM Data Server Driver for JDBC and SQLJ determines whether to use multi-row FETCH, depending on several factors:

- The setting of the `enableRowsetSupport` property
- The setting of the `useRowsetCursor` property, for connections to DB2 for z/OS
- The type of IBM Data Server Driver for JDBC and SQLJ connectivity that is being used
- The version of the IBM Data Server Driver for JDBC and SQLJ

For IBM Data Server Driver for JDBC and SQLJ type 4 connectivity to DB2 for z/OS, one of the following sets of conditions must be true for multi-row FETCH to be used.

- First set of conditions:
  - The IBM Data Server Driver for JDBC and SQLJ version is 3.51 or later.
  - The `enableRowsetSupport` property value is `com.ibm.db2.jcc.DB2BaseDataSource.YES (1)`, **or** the `enableRowsetSupport` property value is `com.ibm.db2.jcc.DB2BaseDataSource.NOT_SET (0)` and the `useRowsetCursor` property value is `true`.
  - The FETCH operation uses a scrollable cursor.  
For forward-only cursors, fetching of multiple rows might occur through DRDA block FETCH. However, this behavior does not utilize the data source's multi-row FETCH capability.
- Second set of conditions:
  - The IBM Data Server Driver for JDBC and SQLJ version is 3.1.
  - The `useRowsetCursor` property value is `com.ibm.db2.jcc.DB2BaseDataSource.YES (1)`.
  - The FETCH operation uses a scrollable cursor.  
For forward-only cursors, fetching of multiple rows might occur through DRDA block FETCH. However, this behavior does not utilize the data source's multi-row FETCH capability.

For IBM Data Server Driver for JDBC and SQLJ type 2 connectivity to DB2 for z/OS the following conditions must be true for multi-row FETCH to be used.

- The IBM Data Server Driver for JDBC and SQLJ version is 3.51 or later.
- The `enableRowsetSupport` property value is `com.ibm.db2.jcc.DB2BaseDataSource.YES (1)`.
- The FETCH operation uses a scrollable cursor or a forward-only cursor.

For IBM Data Server Driver for JDBC and SQLJ type 2 connectivity on DB2 for z/OS, you can control the maximum size of a rowset for each statement by setting the `maxRowsetSize` property.

### Multi-row positioned UPDATE or DELETE

The IBM Data Server Driver for JDBC and SQLJ supports a technique for performing positioned update or delete operations that follows the JDBC 1 standard. That technique involves using the `ResultSet.getCursorName` method to obtain the name of the cursor for the `ResultSet`, and defining a positioned UPDATE or positioned DELETE statement of the following form:

```
UPDATE table SET col1=value1,...coln=valueN WHERE CURRENT OF cursorname
DELETE FROM table WHERE CURRENT OF cursorname
```

*Multi-row UPDATE or DELETE when useRowsetCursor is set to true:* If you use the JDBC 1 technique to update or delete data on a database server that supports multi-row FETCH, and multi-row FETCH is enabled through the `useRowsetCursor` property, the positioned UPDATE or DELETE statement might update or delete multiple rows, when you expect it to update or delete a single row. To avoid unexpected updates or deletes, you can take one of the following actions:

- Use an updatable `ResultSet` to retrieve and update one row at a time, as shown in the previous example.
- Set `useRowsetCursor` to `false`.

*Multi-row UPDATE or DELETE when enableRowsetSupport is set to com.ibm.db2.jcc.DB2BaseDataSource.YES (1):* The JDBC 1 technique for updating or deleting data is incompatible with multi-row FETCH that is enabled through the `enableRowsetSupport` property.

**Recommendation:** If your applications use the JDBC 1 technique, update them to use the JDBC 2.0 `ResultSet.updateRow` or `ResultSet.deleteRow` methods for positioned update or delete activity.

### Testing whether the current row of a ResultSet is a delete hole or update hole in a JDBC application:

If a `ResultSet` has the `TYPE_SCROLL_SENSITIVE` attribute, and the underlying cursor is `SENSITIVE STATIC`, you need to test for delete holes or update holes before you attempt to retrieve rows of the `ResultSet`.

#### About this task

After a `SENSITIVE STATIC` `ResultSet` is opened, it does not change size. This means that deleted rows are replaced by placeholders, which are also called *holes*. If updated rows no longer fit the criteria for the `ResultSet`, those rows also become holes. You cannot retrieve rows that are holes.

To test whether the current row in a `ResultSet` is a delete hole or update hole, follow these steps:

#### Procedure

1. Call the `DatabaseMetaData.deletesAreDetected` or `DatabaseMetaData.updatesAreDetected` method with the `TYPE_SCROLL_SENSITIVE` argument to determine whether the data source creates holes for a `TYPE_SCROLL_SENSITIVE` `ResultSet`.

2. If `DatabaseMetaData.deletesAreDetected` or `DatabaseMetaData.updatesAreDetected` returns `true`, which means that the data source can create holes, call the `ResultSet.rowDeleted` or `ResultSet.rowUpdated` method to determine whether the current row is a delete or update hole. If the method returns `true`, the current row is a hole.

### Example

The following code tests whether the current row is a delete hole.

```
Statement stmt = con.createStatement(ResultSet.TYPE_SCROLL_SENSITIVE,
    ResultSet.CONCUR_UPDATABLE);
// Create a Statement object
// for a scrollable, updatable
// ResultSet

ResultSet rs =
    stmt.executeQuery("SELECT EMPNO FROM EMPLOYEE FOR UPDATE OF PHONENO");
// Create the ResultSet

DatabaseMetaData dbmd = con.getMetaData();
// Create the DatabaseMetaData object

boolean dbSeesDeletes =
    dbmd.deletesAreDetected(ResultSet.TYPE_SCROLL_SENSITIVE);
// Can the database see delete holes?

rs.afterLast();
// Position the cursor at the end of
// the ResultSet

while (rs.previous()) {
// Position the cursor backward
    if (dbSeesDeletes) {
// If delete holes can be detected
        if (!(rs.rowDeleted()))
// If this row is not a delete hole
        {
            s = rs.getString("EMPNO");
// Retrieve the employee number
            System.out.println("Employee number = " + s);
// Print the column value
        }
    }
}

rs.close();
// Close the ResultSet
stmt.close();
// Close the Statement
```

### Inserting a row into a ResultSet in a JDBC application:

If a `ResultSet` has a `resultSetConcurrency` attribute of `CONCUR_UPDATABLE`, you can insert rows into the `ResultSet`.

#### About this task

To insert a row into a `ResultSet`, follow these steps:

#### Procedure

1. Perform the following steps for each row that you want to insert.
  - a. Call the `ResultSet.moveToInsertRow` method to create the row that you want to insert. The row is created in a buffer outside the `ResultSet`.  
If an insert buffer already exists, all old values are cleared from the buffer.
  - b. Call `ResultSet.updateXXX` methods to assign values to the row that you want to insert.

You need to assign a value to at least one column in the `ResultSet`. If you do not do so, an `SQLException` is thrown when the row is inserted into the `ResultSet`.

If you do not assign a value to a column of the `ResultSet`, when the underlying table is updated, the data source inserts the default value for the associated table column.

If you assign a null value to a column that is defined as NOT NULL, the JDBC driver throws an SQLException.

- c. Call `ResultSet.insertRow` to insert the row into the `ResultSet`.

After you call `ResultSet.insertRow`, all values are always cleared from the insert buffer, even if `ResultSet.insertRow` fails.

2. Reposition the cursor within the `ResultSet`.

To move the cursor from the insert row to the `ResultSet`, you can invoke any of the methods that position the cursor at a specific row, such as `ResultSet.first`, `ResultSet.absolute`, or `ResultSet.relative`. Alternatively, you can call `ResultSet.moveToCurrentRow` to move the cursor to the row in the `ResultSet` that was the current row before the insert operation occurred.

After you call `ResultSet.moveToCurrentRow`, all values are cleared from the insert buffer.

### Example

**Example:** The following code illustrates inserting a row into a `ResultSet` that consists of all rows in the sample DEPARTMENT table. After the row is inserted, the code places the cursor where it was located in the `ResultSet` before the insert operation. The numbers to the right of selected statements correspond to the previously-described steps.

```
stmt = con.createStatement(ResultSet.TYPE_SCROLL_SENSITIVE,  
                           ResultSet.CONCUR_UPDATABLE);  
ResultSet rs = stmt.executeQuery("SELECT * FROM DEPARTMENT");  
rs.moveToInsertRow();  
rs.updateString("DEPT_NO", "M13");  
rs.updateString("DEPTNAME", "TECHNICAL SUPPORT");  
rs.updateString("MGRNO", "000010");  
rs.updateString("ADMRDEPT", "A00");  
rs.insertRow();  
rs.moveToCurrentRow();
```

1a  
1b

1c  
2

### Testing whether the current row was inserted into a `ResultSet` in a JDBC application:

If a `ResultSet` is dynamic, you can insert rows into it. After you insert rows into a `ResultSet` you might need to know which rows were inserted.

#### About this task

To test whether the current row in a `ResultSet` was inserted, follow these steps:

#### Procedure

1. Call the `DatabaseMetaData.ownInsertsAreVisible` and `DatabaseMetaData.othersInsertsAreVisible` methods to determine whether inserts can be visible to the given type of `ResultSet`.
2. If inserts can be visible to the `ResultSet`, call the `DatabaseMetaData.insertsAreDetected` method to determine whether the given type of `ResultSet` can detect inserts.
3. If the `ResultSet` can detect inserts, call the `ResultSet.rowInserted` method to determine whether the current row was inserted.

## Calling stored procedures in JDBC applications

To call stored procedures, you invoke methods in the `CallableStatement` or `PreparedStatement` class.

## About this task

The basic steps for calling a stored procedures using standard CallableStatement methods are:

### Procedure

1. Invoke the Connection.prepareCall method with the CALL statement as its argument to create a CallableStatement object.

You can represent parameters with standard parameter markers (?), named parameter markers, or named parameters. You can mix named parameters and standard parameter markers in the same CALL statement, but you cannot mix named parameter markers with standard parameter markers or named parameters.

**Restriction:** The parameter types that are permitted depend on whether the data source supports dynamic execution of the CALL statement. DB2 for z/OS does not support dynamic execution of the CALL statement. For a call to a stored procedure that is on a DB2 for z/OS database server, the parameters can be parameter markers or literals, but not expressions. Even if all parameters are literals, you cannot use Statement methods to execute CALL statements. You must use PreparedStatement methods or CallableStatement methods. The following table lists the types of literals that are supported, and the JDBC types to which they map.

Table 13. Supported literal types in parameters in DB2 for z/OS stored procedure calls

Literal parameter type	JDBC type	Examples
Integer	java.sql.Types.INTEGER	-122, 40022, +27
Floating-point decimal	java.sql.Types.DOUBLE	23E12, 40022E-4, +2723E+15, 1E+23, 0E0
Fixed-point decimal	java.sql.Types.DECIMAL	-23.12, 40022.4295, 0.0, +2723.23, 10000000000
Character	java.sql.Types.VARCHAR	'Grantham Lutz', 'O'Conner', 'ABcde?z?'
Hexadecimal	java.sql.Types.VARBINARY	X'C1C30427', X'00CF18E0'
Unicode string	java.sql.Types.VARCHAR	UX'0041', UX'0054006500730074'

2. Invoke the CallableStatement.setXXX methods to pass values to the input parameters (parameters that are defined as IN or INOUT in the CREATE PROCEDURE statement).

This step assumes that you use standard parameter markers or named parameters. Alternatively, if you use named parameter markers, you use IBM Data Server Driver for JDBC and SQLJ-only methods to pass values to the input parameters.

**Restriction:** If the data source does not support dynamic execution of the CALL statement, you must specify the data types for CALL statement input parameters **exactly** as they are specified in the stored procedure definition.

3. Invoke the CallableStatement.registerOutParameter method to register parameters that are defined as OUT in the CREATE PROCEDURE statement with specific data types.

This step assumes that you use standard parameter markers or named parameters. Alternatively, if you use named parameter markers, you use IBM Data Server Driver for JDBC and SQLJ-only methods to register OUT parameters with specific data types.

**Restriction:** If the data source does not support dynamic execution of the CALL statement, you must specify the data types for CALL statement OUT, IN, or INOUT parameters **exactly** as they are specified in the stored procedure definition.

4. Invoke one of the following methods to call the stored procedure:

**CallableStatement.executeUpdate**

Invoke this method if the stored procedure does not return result sets.

**CallableStatement.executeQuery**

Invoke this method if the stored procedure returns one result set.

You can invoke `CallableStatement.executeQuery` for a stored procedure that returns no result sets if you set property `allowNullResultSetForExecuteQuery` to `DB2BaseDataSource.YES (1)`. In that case, `CallableStatement.executeQuery` returns null. This behavior does not conform to the JDBC standard.

**CallableStatement.execute**

Invoke this method if the stored procedure returns multiple result sets, or an unknown number of result sets.

**Restriction:** IBM Informix data sources do not support multiple result sets.

5. If the stored procedure returns multiple result sets, retrieve the result sets.

**Restriction:** IBM Informix data sources do not support multiple result sets.

6. Invoke the `CallableStatement.getXXX` methods to retrieve values from the OUT parameters or INOUT parameters.
7. Invoke the `CallableStatement.close` method to close the `CallableStatement` object when you have finished using that object.

## Example

**Example:** The following code illustrates calling a stored procedure that has one input parameter, four output parameters, and no returned ResultSets. The numbers to the right of selected statements correspond to the previously-described steps.

```
int ifcaret;
int ifcareas;
int xsbytes;
String errbuff;
Connection con;
CallableStatement cstmt;
ResultSet rs;
...
cstmt = con.prepareCall("CALL DSN8.DSN8ED2(?,?,?,?)");           1
// Create a CallableStatement object
cstmt.setString (1, "DISPLAY THREAD(*)");                         2
// Set input parameter (DB2 command)
cstmt.registerOutParameter (2, Types.INTEGER);                   3
// Register output parameters
cstmt.registerOutParameter (3, Types.INTEGER);
cstmt.registerOutParameter (4, Types.INTEGER);
cstmt.registerOutParameter (5, Types.VARCHAR);
cstmt.executeUpdate();                                           4
// Call the stored procedure
ifcaret = cstmt.getInt(2);                                       6
// Get the output parameter values
ifcareas = cstmt.getInt(3);
xsbytes = cstmt.getInt(4);
errbuff = cstmt.getString(5);
cstmt.close();                                                  7
```



## Using named parameters in CALL statements in JDBC applications

The IBM Data Server Driver for JDBC and SQLJ provides several ways to use named parameters when you call stored procedures. Named parameters use a different syntax from named parameter markers.

### About this task

You can use named parameters in either or both of the following places in a JDBC application:

- In the CALL statement

With named parameters, you do not need to specify parameters in the CALL statement in the same order that they appear in the stored procedure definition. In addition, you do not need to specify all parameters in the CALL statement. Unspecified parameters take the default values that are specified in the stored procedure definition.

- In CallableStatement.setXXX, CallableStatement.getXXX, and CallableStatement.registerOutParameter methods

You can make your programs easier to read by specifying parameter names as they appear in the stored procedure definition, rather than the positions of the parameters in the definition.

To use named parameters with CALL statements, follow these steps.

### Procedure

1. Invoke the Connection.prepareCall method with the CALL statement as its argument to create a CallableStatement object.

To indicate each parameter, you can use a parameter markers (?), or this syntax:

*parameter-name*=>?

*parameter-name* identifies a parameter in the CREATE PROCEDURE statement.

You can explicitly assign the default value or the null value to a named parameter by specifying the DEFAULT keyword or the NULL keyword. For parameters for which a default value is specified in the CREATE PROCEDURE statement, you can implicitly assign the default values to named parameters by omitting those parameters from the CALL statement. You can omit parameters only if all of the omitted parameters have default values in the stored procedure definition.

You cannot mix named parameters and named parameter markers in the same CALL statement.

2. Invoke the CallableStatement.setXXX methods to pass values to the input parameters (parameters that are defined as IN or INOUT in the CREATE PROCEDURE statement).

You can assign values in either of the following ways:

- By position, using CallableStatement.setXXX(parameterIndex,...)
- By name, using CallableStatement.setXXX(parameterName,...)

*parameterName* is a string that is enclosed in double quotation marks, whose value matches a parameter name in the CREATE PROCEDURE statement.

3. Invoke the CallableStatement.registerOutParameter method to register parameters that are defined as OUT in the CREATE PROCEDURE statement with specific data types.



4. Invoke `CallableStatement.executeUpdate`, `CallableStatement.executeQuery`, or `CallableStatement.execute` to execute the stored procedure.
5. If the stored procedure returns multiple result sets, retrieve those result sets. You can register the output parameters in either of the following ways:
  - By position, using `CallableStatement.registerOutParameter(parameterIndex,...)`
  - By name, using `CallableStatement.registerOutParameter(parameterName,...)`  
*parameterName* is a string that is enclosed in double quotation marks, whose value matches a parameter name in the `CREATE PROCEDURE` statement.
6. Invoke the `CallableStatement.getXXX` methods to retrieve values from the `OUT` parameters or `INOUT` parameters. You can retrieve values in either of the following ways:
  - By position, using `CallableStatement.getXXX(parameterIndex,...)`
  - By name, using `CallableStatement.getXXX(parameterName,...)`  
*parameterName* is a string that is enclosed in double quotation marks, whose value matches a parameter name in the `CREATE PROCEDURE` statement.
7. Invoke the `CallableStatement.close` method to close the `CallableStatement` object when you have finished using that object.

## Example

The following code illustrates calling a stored procedure that has the following definition:

```
CREATE PROCEDURE SALS (
  OUT retcode INTEGER,
  IN lowsal DOUBLE,
  IN medsal DOUBLE,
  IN highsals DOUBLE DEFAULT 100000,
  IN department CHAR(3) DEFAULT '---')
SPECIFIC JDBC_SALS
DYNAMIC RESULT SETS 0
DETERMINISTIC
LANGUAGE JAVA
PARAMETER STYLE JAVA
NO DBINFO
FENCED
THREADSAFE
MODIFIES SQL DATA
PROGRAM TYPE SUB
EXTERNAL NAME 'MYJAR:MyClass.sals'
```

The input parameters in the `CALL` statement are represented by named parameters. The third and fourth parameters are called with the default values for the stored procedure. The numbers to the right of selected statements correspond to the previously-described steps.

```
int hvRetCode; // Host variable for output parameter
Connection con;
CallableStatement cstmt;
ResultSet rs;
...

cstmt = con.prepareCall(
  "CALL SALS(retcode=>?, lowsal=>?, medsal=>?, highsals=>DEFAULT)"); 1
  // Prepare the Call statement.
  // Implicitly use the default
  // value for the last parameter
  // by omitting it.

cstmt.setDouble ("lowsal", 10000); 2
cstmt.setDouble ("medsal", 50000);
```

```

cstmt.registerOutParameter ("retcode", Types.INTEGER);
// Register output parameter
cstmt.executeUpdate(); // Call the stored procedure
hvRetCode = cstmt.getInt("retcode");
System.out.println("Return code from SALS call: " + hvRetCode);
cstmt.close();

```

3  
4  
6  
7

## Retrieving data from cursor output parameters in JDBC applications

DB2 Database for Linux, UNIX, and Windows stored procedures can have OUT parameters of the cursor type. To retrieve data from those parameters in JDBC applications, you use `ResultSet` objects.

### About this task

To retrieve data from cursor variables, follow these steps.

### Procedure

1. Define a `ResultSet` object for each OUT parameter that has the cursor data type.
2. Invoke the `Connection.prepareStatement` method with the `CALL` statement as its argument to create a `CallableStatement` object.
3. Invoke the `CallableStatement.registerOutParameter` method to register the data types of parameters that are defined as OUT in the `CREATE PROCEDURE` statement.

The data type for cursor type output parameters is `com.ibm.db2.jcc.DB2Types.CURSOR`.

4. Call the stored procedure.
5. Invoke the `CallableStatement.getObject` method to retrieve the `ResultSet` for each OUT cursor parameter.

You can call only `CallableStatement.getObject` or `CallableStatement.getString` on a cursor parameter. Calling `CallableStatement.getString` returns a name that is associated with the result set that is returned for the parameter.

If more than one OUT cursor parameter references the same cursor at the data source, the same `ResultSet` instance is returned for all parameters.

6. Retrieve rows from the `ResultSet` object for each OUT cursor parameter.
7. Close the `ResultSet`.

If the `autocommit` value is `true`, a commit operation occurs only when **all** of the result sets that are returned by cursor type output parameters or by the stored procedure are closed.

### Example

A cursor data type and a stored procedure have the following definitions:

```

CREATE TYPE myRowType AS ROW (name VARCHAR(128))
CREATE TYPE myCursorType AS myRowType CURSOR
CREATE PROCEDURE MYPROC(IN pempNo VARCHAR(6), OUT pcv1 myCursorType)
  RESULT SETS 0
  LANGUAGE SQL
  BEGIN
    DECLARE c1 CURSOR WITH RETURN FOR
      SELECT empno FROM EMPLOYEE;
    OPEN c1;
    SET pcv1 = CURSOR FOR SELECT name FROM employee WHERE empNo = pempNo;
    OPEN pcv1;
  END

```

The following code calls stored procedure MYPROC and uses a ResultSet object to retrieve data from cursor pcv1. The numbers to the right of selected statements correspond to the previously-described steps.

```

Connection con;
ResultSet rs = null;           // Output parameter           1
...
CallableStatement cstmt = conn.prepareCall("CALL MYPROC(?, ?)");  2
String hvEmpNo="000500";
cstmt.setString (1, hvEmpNo);
cstmt.registerOutParameter (2, DB2Types.CURSOR);           3
cstmt.executeUpdate();                                     4 // Call the stored procedure
String hvEmpName = null;
rs = (java.sql.ResultSet)cstmt.getObject(2);              5
while (rs.next()) {                                       6 // Retrieve result set rows
    hvEmpName=rs.getString(1);
    System.out.println("Employee name for " + hvEmpNo
        + ": " + hvEmpName);
}
rs.close();                                               7 // Close the ResultSet

```

## Invoking stored procedures with ROW parameters in JDBC applications

DB2 Database for Linux, UNIX, and Windows stored procedures can have parameters of the ROW type. To retrieve or update data in those parameters in JDBC applications, you use Struct objects.

### About this task

To retrieve or update data in ROW parameters, follow these steps.

### Procedure

1. Define a Struct object for each parameter that has the ROW data type.
 

If you are using the SDK for Java Version 6 or later, use the createStruct method of the java.sql.Connection interface. If you are using an earlier version of the SDK for Java, use the createStruct object of the com.ibm.db2.jcc.DB2Connection interface.
2. Invoke the Connection.prepareCall method with the CALL statement as its argument to create a CallableStatement object.
3. Invoke CallableStatement.setXXX methods to assign values to the IN or INOUT parameters in the CREATE PROCEDURE statement.
 

Use the CallableStatement.setObject method for ROW parameters.
4. Invoke the CallableStatement.registerOutParameter method to register the data types of parameters that are defined as OUT in the CREATE PROCEDURE statement.
 

The data type for ROW type output parameters is java.sql.Types.STRUCT.
5. Call the stored procedure.
6. Invoke the CallableStatement.getObject method to retrieve the value of each OUT ROW parameter. Cast the returned objects as java.sql.Struct values.
7. Retrieve data from the Struct object for each OUT ROW parameter.

### Example

A ROW type and a stored procedure have the following definitions:

```

CREATE TYPE MYTYPE.PERSON_T AS ROW
    ID INTEGER
    FIRSTNAME VARCHAR(20)

```

```

LASTNAME VARCHAR(20)
SALARY INTEGER

CREATE PROCEDURE MYSP.PERSON_SP
(IN PIN MYTYPE.PERSON_T, OUT POUT MYTYPE.PERSON_T)
LANGUAGE SQL
BEGIN
...
END

```

The following code calls stored procedure MYSP.PERSON\_SP and uses Struct objects to assign data to ROW parameter PIN and to retrieve data from ROW parameter POUT. The numbers to the right of selected statements correspond to the previously-described steps.

```

Connection con;
CallableStatement cstmt;
...
personAttributes = new Object[] {
    new Integer(1), "John", "Doe", new Integer(60000)
};
person = con.createStruct("MYTYPE.PERSON_T", personAttributes);
cstmt = con.prepareCall("CALL MYSP.PERSON_SP(?,?)");
cstmt.setObject(1, person);
cstmt.registerOutParameter(2, java.sql.Types.STRUCT);
cstmt.execute();
person = (java.sql.Struct)cstmt.getObject(2);
Object[] personAttributes = person.getAttributes();
Integer id = (Integer)personAttributes[0];
String firstName = (String)personAttributes[1];
String lastName = (String)personAttributes[2];
Integer salary = (Integer)personAttributes[3];
cstmt.close();

```

1  
2  
3  
4  
5  
6  
7

## Invoking stored procedures with ARRAY of ROW parameters in JDBC applications

DB2 Database for Linux, UNIX, and Windows stored procedures can have parameters of the ARRAY of ROW type. To retrieve or update data in those parameters in JDBC applications, you use arrays of Struct objects.

### About this task

To retrieve or update data in ARRAY of ROW parameters, follow these steps.

### Procedure

1. Define a Struct object for each row of each input parameter that has the ARRAY of ROW data type.  
If you are using the SDK for Java Version 6 or later, use the createStruct method of the java.sql.Connection interface. If you are using an earlier version of the SDK for Java, use the createStruct object of the com.ibm.db2.jcc.DB2Connection interface.
2. Define an Array object for each array of rows.  
If you are using the SDK for Java Version 6 or later, use the createArrayOf method of the java.sql.Connection interface. If you are using an earlier version of the SDK for Java, use the createArrayOf object of the com.ibm.db2.jcc.DB2Connection interface.
3. Invoke the Connection.prepareCall method with the CALL statement as its argument to create a CallableStatement object.
4. Invoke CallableStatement.setXXX methods to assign values to the IN or INOUT parameters in the CREATE PROCEDURE statement.

Use the `CallableStatement.setArray` method for ARRAY of ROW parameters.

5. Invoke the `CallableStatement.registerOutParameter` method to register the data types of parameters that are defined as OUT in the CREATE PROCEDURE statement.

The data type for ARRAY of ROW type output parameters is `java.sql.Types.ARRAY`.

6. Call the stored procedure.
7. Invoke the `CallableStatement.getArray` method to retrieve the array from each OUT ARRAY of ROW parameter into a `java.sql.Array` object.
8. Invoke the `java.sql.Array.getArray` method to retrieve the contents of the `java.sql.Array` object. Cast the retrieved objects as `java.sql.Struct[]` arrays.
9. Retrieve data from each element of the array of Struct objects for each OUT ARRAY of ROW parameter.

## Example

A ROW type and a stored procedure have the following definitions:

```
CREATE TYPE MYTYPE.PERSON_T AS ROW
  ID INTEGER
  FIRSTNAME VARCHAR(20)
  LASTNAME VARCHAR(20)
  SALARY INTEGER

CREATE TYPE MYTYPE.PEOPLE_T AS MYTYPE.PERSON_T ARRAY[10]

CREATE PROCEDURE MYSP.PEOPLE_SP
  (IN PIN MYTYPE.PEOPLE_T, OUT POUT MYTYPE.PEOPLE_T)
  LANGUAGE SQL
  BEGIN
  ...
  END
```

The following code calls stored procedure `MYSP.PEOPLE_SP`, and uses arrays of Struct objects to assign data to ARRAY of ROW parameter `PIN` and to retrieve data from ARRAY of ROW parameter `POUT`. The numbers to the right of selected statements correspond to the previously described steps.

```
Connection con;
CallableStatement cstmt;
...

peopleElements = new java.sql.Struct[2];
personAttributes = new Object[] {
    new Integer(1), "John", "Doe", new Integer(60000)
};
peopleElements[0] =
    con.createStruct("MYTYPE.PERSON_T", personAttributes);
personAttributes = new Object[] {
    new Integer(2), "Jane", "Doe", new Integer(65000)
};
peopleElements[1] =
    con.createStruct("MYTYPE.PERSON_T", personAttributes);
Array people = con.createArrayOf("MYTYPE.PERSON_T", peopleElements);
cstmt = con.prepareCall("CALL MYSP.PEOPLE_SP(?,?)");
cstmt.setArray(1, people);
cstmt.registerOutParameter(2, java.sql.Types.ARRAY);
cstmt.execute();
java.sql.Array people = cstmt.getArray(2);
java.sql.Struct[] persons =
    (java.sql.Struct[])people.getArray();
for (int i = 0; i < persons.length; i++) {
```

1

2

3

4

5

6

7

8

9

```

java.sql.Struct person = persons[i];
Object[] personAttributes = person.getAttributes();
Integer id = (Integer)personAttributes[0];
String firstName = (String)personAttributes[1];
String lastName = (String)personAttributes[2];
Integer salary = (Integer)personAttributes[3];
}

```

## Invoking stored procedures with nested ROW or ARRAY of ROW types in JDBC applications

In DB2 Database for Linux, UNIX, and Windows stored procedure parameters, ROW types can be nested. You can retrieve or update data in those parameters in JDBC applications.

### About this task

To retrieve or update data in parameters with nested ROW or ARRAY of ROW types, follow these steps.

### Procedure

1. Define a Struct object for each of the most deeply nested ROW types, or a Struct[] object for the most deeply nested ARRAY or ROW type.  
If you are using the SDK for Java Version 6 or later, use the createStruct method of the java.sql.Connection interface. If you are using an earlier version of the SDK for Java, use the createStruct object of the com.ibm.db2.jcc.DB2Connection interface.
2. Repeat step 1 for the next most deeply nested ROW type. Continue this process until you have defined and populated a Struct object for the outermost ROW type.
3. Invoke the Connection.prepareCall method with the CALL statement as its argument to create a CallableStatement object.
4. Invoke CallableStatement.setXXX methods to assign values to the IN or INOUT parameters in the CREATE PROCEDURE statement.  
Use the CallableStatement.setObject method for ROW parameters.
5. Invoke the CallableStatement.registerOutParameter method to register the data types of parameters that are defined as OUT in the CREATE PROCEDURE statement.  
The data type for ROW type output parameters is java.sql.Types.STRUCT.
6. Call the stored procedure.
7. Invoke the CallableStatement.getObject method to retrieve the value of each OUT ROW parameter. Cast the returned objects as java.sql.Struct values.
8. Retrieve data from the Struct object for each OUT ROW parameter, and each ROW type that is nested within a ROW parameter.

### Example

Suppose that ARRAY and ROW objects are defined as follows:

MYTYPE.SKILLS is an ARRAY type.

```
CREATE TYPE MYTYPE.SKILLS AS VARCHAR(20) ARRAY[10]
```

ROW type MYTYPE.PERSON\_T contains a field with ARRAY type MYTYPE.SKILLS.

```

CREATE TYPE MYTYPE.PERSON_T AS ROW
  ID INTEGER
  FIRSTNAME VARCHAR(20)
  LASTNAME VARCHAR(20)
  JOBSKILLS MYTYPE.SKILLS

```

ROW type MYTYPE.PEOPLE\_T is an array of objects that have ROW type MYTYPE.PERSON\_T.

```

CREATE TYPE MYTYPE.PEOPLE_T AS MYTYPE.PERSON_T ARRAY[10]

```

ROW type MYTYPE.DEPARTMENT contains a field that has the ARRAY of ROW type MYTYPE.PEOPLE\_T.

```

CREATE TYPE MYTYPE.DEPARTMENT AS ROW
  (ID INTEGER,
  DEPTNAME VARCHAR(20),
  DEPTPEOPLE MYTYPE.PEOPLE_T)

```

Stored procedure MYSP.DEPARTMENT\_SP has two parameters, each of which has the MYTYPE.DEPARTMENT type.

```

CREATE PROCEDURE MYSP.DEPARTMENT_SP
  (IN PIN MYTYPE.DEPARTMENT, OUT POUT MYTYPE.DEPARTMENT)
  LANGUAGE SQL
  BEGIN
  ...
  END

```

The following code demonstrates how to use Struct objects to assign values to nested ROW objects in a stored procedure input parameter, and how to use Struct objects to retrieve data from nested ROW objects in a stored procedure output parameter. The numbers to the right of selected statements correspond to the previously-described steps.

```

Connection con;
...
java.sql.Struct[] people = new java.sql.Struct[3];
    // Construct an array of Struct objects for the
    // MYTYPE.PEOPLE_T array or ROW objects
String[] skills1 = {"java", "C++", "java script"};
    // Create and populate the first array for the
    // MYTYPE.SKILLS ARRAY object
Object[] attributes1 =
    new Object [] {new Integer (1), "Alpha", "Doe", skills1};
    // Create an object with the content of the first
    // input row that corresponds to MYTYPE.PERSON_T
people[0] = ((com.ibm.db2.jcc.DB2Connection)con).
    createStruct ("PERSON_T", attributes1);
    // Populate the first element of the array of Struct
    // for input to the MYTYPE.PEOPLE_T type
String[] skills2 = {"java", "C++", "C"};
    // Create and populate the second array for the
    // MYTYPE.SKILLS ARRAY object
Object[] attributes2 =
    new Object [] {new Integer (2), "Beta", "Doe", skills2};
    // Create an object with the content of the second
    // input row that corresponds to MYTYPE.PERSON_T
people[1] = ((com.ibm.db2.jcc.DB2Connection)con).
    createStruct ("PERSON_T", attributes2);
    // Populate the second element of the array of Struct
    // for input to the MYTYPE.PEOPLE_T type
java.sql.Array peopleArray = ((com.ibm.db2.jcc.DB2Connection)con).
    createArrayOf("MYTYPE.PEOPLE_T", people);
    // Create and populate an Array object for
    // input to the DEPTPEOPLE object
Object[] deptAttributes =

```

```

        new Object [] {new Integer (1), "Jcc", peopleArray };
        // Create an object with the content of an
        // input row for parameter PIN
java.sql.Struct deptStruct = ((com.ibm.db2.jcc.DB2Connection)con).
        createStruct ("DEPARTMENT", deptAttributes);
        // Create and populate a Struct object for
        // input to the PIN parameter
java.sql.CallableStatement cs = con.prepareCall
        ("CALL MYSP.DEPARTMENT_SP (?, ?)");
cs.setObject(1, deptStruct);
        // Assign the row object to input parameter PIN
cs.registerOutParameter(2, java.sql.Types.STRUCT);
        // Register the output parameter as a STRUCT type
cs.executeUpdate();
        // Call the stored procedure
java.sql.Struct outputStruct = (java.sql.Struct)cs.getObject (2);
        // Retrieve the content of the POUT row parameter
Object[] structAttributes = outputStruct.getAttributes ();
        // Retrieve an array of objects that contains the
        // attributes of the outermost output structure
int departmentID = (Integer)structAttributes[0];
String departmentName = (String)structAttributes[1];
System.out.println ("The department ID is: " + departmentID);
System.out.println ("The department Name is: " + departmentName);
java.sql.Struct[] departmentPeople =
        (java.sql.Struct[])structAttributes[2];
        // Retrieve the contents of the nested structure
java.sql.Struct personStruct;
System.out.println ("The people in the department are: " );
for (int i = 0; i < departmentPeople.length; i++) {
        // Retrieve the elements of the inner
        // array of rows
        personStruct = departmentPeople[i];
        structAttributes = personStruct.getAttributes ();
        System.out.println (
                "id> " + (Integer)structAttributes[0] + " : " +
                "firstName> " + (String)structAttributes[1] + " : " +
                "lastName> " + (String)structAttributes[2] + " : " +
                "skills> ");
        for (int j = 0; j < ((String[]) structAttributes[3]).length; j++)
            System.out.print ("--" + ((String[])structAttributes[3])[j]);
}

```

## Retrieving multiple result sets from a stored procedure in a JDBC application

If you call a stored procedure that returns result sets, you need to include code to retrieve the result sets.

### About this task

The steps that you take depend on whether you know how many result sets are returned, and whether you know the contents of those result sets.

### Retrieving a known number of result sets from a stored procedure in a JDBC application:

Retrieving a known number of result sets from a stored procedure is a simpler procedure than retrieving an unknown number of result sets.

### About this task

To retrieve result sets when you know the number of result sets and their contents, follow these steps:



## Procedure

1. Invoke the `Statement.execute` method, the `PreparedStatement.execute` method, or the `CallableStatement.execute` method to call the stored procedure.  
Use `PreparedStatement.execute` if the stored procedure has input parameters.
2. Invoke the `getResultSet` method to obtain the first result set, which is in a `ResultSet` object.
3. In a loop, position the cursor using the `next` method, and retrieve data from each column of the current row of the `ResultSet` object using `getXXX` methods.
4. If there are  $n$  result sets, repeat the following steps  $n-1$  times:
  - a. Invoke the `getMoreResults` method to close the current result set and point to the next result set.
  - b. Invoke the `getResultSet` method to obtain the next result set, which is in a `ResultSet` object.
  - c. In a loop, position the cursor using the `next` method, and retrieve data from each column of the current row of the `ResultSet` object using `getXXX` methods.

## Example

**Example:** The following code illustrates retrieving two result sets. The first result set contains an `INTEGER` column, and the second result set contains a `CHAR` column. The numbers to the right of selected statements correspond to the previously described steps.

```
CallableStatement cstmt;
ResultSet rs;
int i;
String s;
...
cstmt.execute(); // Call the stored procedure 1
rs = cstmt.getResultSet(); // Get the first result set 2
while (rs.next()) { // Position the cursor 3
    i = rs.getInt(1); // Retrieve current result set value
    System.out.println("Value from first result set = " + i);
    // Print the value
}
cstmt.getMoreResults(); // Point to the second result set 4a
// and close the first result set
rs = cstmt.getResultSet(); // Get the second result set 4b
while (rs.next()) { // Position the cursor 4c
    s = rs.getString(1); // Retrieve current result set value
    System.out.println("Value from second result set = " + s);
    // Print the value
}
rs.close(); // Close the result set
cstmt.close(); // Close the statement
```

## Retrieving an unknown number of result sets from a stored procedure in a JDBC application:

Retrieving an unknown number of result sets from a stored procedure is a more complicated procedure than retrieving a known number of result sets.

## About this task

To retrieve result sets when you do not know the number of result sets or their contents, you need to retrieve `ResultSets`, until no more `ResultSets` are returned. For each `ResultSet`, use `ResultSetMetaData` methods to determine its contents.

After you call a stored procedure, follow these basic steps to retrieve the contents of an unknown number of result sets.

### Procedure

1. Check the value that was returned from the execute statement that called the stored procedure.  
If the returned value is true, there is at least one result set, so you need to go to the next step.
2. Repeat the following steps in a loop:
  - a. Invoke the `getResultSet` method to obtain a result set, which is in a `ResultSet` object. Invoking this method closes the previous result set.
  - b. Use `ResultSetMetaData` methods to determine the contents of the `ResultSet`, and retrieve data from the `ResultSet`.
  - c. Invoke the `getMoreResults` method to determine whether there is another result set. If `getMoreResults` returns true, go to step 1 to get the next result set.

### Example

**Example:** The following code illustrates retrieving result sets when you do not know the number of result sets or their contents. The numbers to the right of selected statements correspond to the previously described steps.

```
CallableStatement cstmt;  
ResultSet rs;  
...  
boolean resultsAvailable = cstmt.execute(); // Call the stored procedure  
while (resultsAvailable) { // Test for result sets 1  
    ResultSet rs = cstmt.getResultSet(); // Get a result set 2a  
    ... // Process the ResultSet  
        // as you would process  
        // a ResultSet from a table  
    resultsAvailable = cstmt.getMoreResults(); // Check for next result set 2c  
        // (Also closes the  
        // previous result set)  
}
```

### Keeping result sets open when retrieving multiple result sets from a stored procedure in a JDBC application:

The `getMoreResults` method has a form that lets you leave the current `ResultSet` open when you open the next `ResultSet`.

#### About this task

To specify whether result sets stay open, follow this process:

### Procedure

When you call `getMoreResults` to check for the next `ResultSet`, use this form:

```
CallableStatement.getMoreResults(int current);
```

- To keep the current `ResultSet` open when you check for the next `ResultSet`, specify a value of `Statement.KEEP_CURRENT_RESULT` for `current`.
- To close the current `ResultSet` when you check for the next `ResultSet`, specify a value of `Statement.CLOSE_CURRENT_RESULT` for `current`.

- To close **all** ResultSet objects, specify a value of `Statement.CLOSE_ALL_RESULTS` for *current*.

### Example

**Example:** The following code keeps all ResultSets open until the final ResultSet has been retrieved, and then closes all ResultSets.

```
CallableStatement cstmt;
...
boolean resultsAvailable = cstmt.execute(); // Call the stored procedure
if (resultsAvailable==true) {              // Test for result set
    ResultSet rs1 = cstmt.getResultSet();   // Get a result set
    ...
    resultsAvailable = cstmt.getMoreResults(Statement.KEEP_CURRENT_RESULT);
                                           // Check for next result set
                                           // but do not close
                                           // previous result set
    if (resultsAvailable==true) {          // Test for another result set
        ResultSet rs2 = cstmt.getResultSet(); // Get next result set
        ...                                // Process either ResultSet
    }
}
resultsAvailable = cstmt.getMoreResults(Statement.CLOSE_ALL_RESULTS);
                                           // Close the result sets
```

### Learning about stored procedure parameter names using DB2ParameterMetaData methods:

The `DB2ParameterMetaData.getProcedureParameterName` method lets you retrieve the defined name of a parameter in an SQL CALL statement.

### About this task

To invoke `ParameterMetaData.getProcedureParameterName`, you need to perform these basic steps:

#### Procedure

1. Invoke the `Connection.prepareCall` method with the CALL statement as its argument to create a `CallableStatement` object.
2. Pass values to the input parameters (parameters that are defined as IN or INOUT in the CREATE PROCEDURE statement).
3. Register parameters that are defined as OUT in the CREATE PROCEDURE statement with specific data types.
4. Call the stored procedure.
5. Invoke `CallableStatement.getParameterMetaData` to retrieve information about the stored procedure parameters.
6. Cast the retrieved `ParameterMetaData` object as a `DB2ParameterMetaData` object.
7. Call the `DB2ParameterMetaData.getProcedureParameterName` method for each CALL statement parameter for which you need to retrieve the parameter name in the CREATE PROCEDURE statement.

## Example

The following code demonstrates how to use `DB2ParameterMetaData.getProcedureParameterName` to determine the names that correspond to standard parameter markers in a stored procedure that is defined like this:

```
CREATE PROCEDURE SP
  (OUT PARM CHAR(10), IN CHAR(10))
```

The numbers to the right of selected statements correspond to the previously-described steps.

```
Connection con;
...
CallableStatement cstmt = con.prepareCall("CALL SP(?, ?)");           1
    // Create a CallableStatement object
cstmt.setString (2, "INPUT_VALUE");                                   2
    // Set input parameter
cstmt.registerOutParameter (1, java.sql.Types.CHAR);                 3
    // Register output parameter
cstmt.execute();                                                     4
    // Call the stored procedure
DB2ParameterMetaData md =                                           5,6
  (DB2ParameterMetaData)cstmt.getParameterMetaData ();
md.getProcedureParameterName(1); // Returns "PARM"                   7
md.getProcedureParameterName(2); // Returns "2"
```

The following code demonstrates how to use `DB2ParameterMetaData.getProcedureParameterName` to determine the names that correspond to named parameter markers in a stored procedure that is defined like this:

```
CREATE PROCEDURE SP
  (OUT PARM CHAR(10), IN CHAR(10))
```

The numbers to the right of selected statements correspond to the previously-described steps.

```
Connection con;
...
CallableStatement cstmt = con.prepareCall("CALL SP(:output, :input)"); 1
    // Create a CallableStatement object
((DB2PreparedStatement)cstmt).setJccStringAtName("input", "INPUT_VALUE"); 2
    // Set input parameter
((DB2CallableStatement)cstmt).registerJccOutParameterAtName           3
  ("output", java.sql.Types.CHAR);
cstmt.execute();                                                       4
    // Register output parameter
    // Call the stored procedure
DB2ParameterMetaData md =                                           5,6
  (DB2ParameterMetaData)cstmt.getParameterMetaData ();
md.getProcedureParameterName(1); // Returns "PARM"                   7
md.getProcedureParameterName(2); // Returns "2"
```

## LOBs in JDBC applications with the IBM Data Server Driver for JDBC and SQLJ

The IBM Data Server Driver for JDBC and SQLJ supports methods for updating and retrieving data from BLOB, CLOB, and DBCLOB columns in a table, and for calling stored procedures or user-defined functions with BLOB or CLOB parameters.

## Progressive streaming with the IBM Data Server Driver for JDBC and SQLJ

If the data source supports progressive streaming, also known as dynamic data format, the IBM Data Server Driver for JDBC and SQLJ can use progressive streaming to retrieve data in LOB or XML columns.

DB2 for z/OS Version 9.1 and later supports progressive streaming for LOBs and XML objects. DB2 Database for Linux, UNIX, and Windows Version 9.5 and later, IBM Informix Version 11.50 and later, and DB2 for i V6R1 and later support progressive streaming for LOBs.

With progressive streaming, the data source dynamically determines the most efficient mode in which to return LOB or XML data, based on the size of the LOBs or XML objects.

Progressive streaming is the default behavior in the following environments:

Minimum IBM Data Server Driver for JDBC and SQLJ version	Minimum data server version	Types of objects
3.53	DB2 for i V6R1	LOB, XML
3.50	DB2 Database for Linux, UNIX, and Windows Version 9.5	LOB
3.50	IBM Informix Version 11.50	LOB
3.2	DB2 for z/OS Version 9	LOB, XML

You set the progressive streaming behavior on new connections using the IBM Data Server Driver for JDBC and SQLJ `progressiveStreaming` property.

For DB2 for z/OS Version 9.1 and later data sources, or DB2 Database for Linux, UNIX, and Windows Version 9.5 and later data sources, you can set the progressive streaming behavior for existing connections with the **`DB2Connection.setDBProgressiveStreaming(DB2BaseDataSource.YES)`** method. If you call **`DB2Connection.setDBProgressiveStreaming(DB2BaseDataSource.YES)`**, all `ResultSet` objects that are created on the connection use progressive streaming behavior.

When progressive streaming is enabled, you can control when the JDBC driver materializes LOBs with the `streamBufferSize` property. If a LOB or XML object is less than or equal to the `streamBufferSize` value, the object is materialized.

**Important:** With progressive streaming, when you retrieve a LOB or XML value from a `ResultSet` into an application variable, you can manipulate the contents of that application variable until you move the cursor or close the cursor on the `ResultSet`. After that, the contents of the application variable are no longer available to you. If you perform any actions on the LOB in the application variable, you receive an `SQLException`. For example, suppose that progressive streaming is enabled, and you execute statements like this:

```
...
ResultSet rs = stmt.executeQuery("SELECT CLOB COL FROM MY_TABLE");
rs.next(); // Retrieve the first row of the ResultSet
Clob clobFromRow1 = rs.getClob(1);
// Put the CLOB from the first column of
// the first row in an application variable
```

```

String substr1Clob = clobFromRow1.getSubString(1,50);
// Retrieve the first 50 bytes of the CLOB
rs.next(); // Move the cursor to the next row.
// clobFromRow1 is no longer available.
// String substr2Clob = clobFromRow1.getSubString(51,100);
// This statement would yield an SQLException
Clob clobFromRow2 = rs.getClob(1);
// Put the CLOB from the first column of
// the second row in an application variable
rs.close(); // Close the ResultSet.
// clobFromRow2 is also no longer available.

```

After you execute `rs.next()` to position the cursor at the second row of the `ResultSet`, the CLOB value in `clobFromRow1` is no longer available to you. Similarly, after you execute `rs.close()` to close the `ResultSet`, the values in `clobFromRow1` and `clobFromRow2` are no longer available.

If you disable progressive streaming, the way in which the IBM Data Server Driver for JDBC and SQLJ handles LOBs depends on the value of the `fullyMaterializeLobData` property.

Use of progressive streaming is the preferred method of LOB or XML data retrieval.

## LOB locators with the IBM Data Server Driver for JDBC and SQLJ

The IBM Data Server Driver for JDBC and SQLJ can use LOB locators to retrieve data in LOB columns.

To cause JDBC to use LOB locators to retrieve data from LOB columns, you need to set the `fullyMaterializeLobData` property to `false` and set the `progressiveStreaming` property to `NO` (`DB2BaseDataSource.NO` in an application program).

The effect of `fullyMaterializeLobData` depends on whether the data source supports progressive streaming and the value of the `progressiveStreaming` property:

- If the data source does not support progressive locators:  
If the value of `fullyMaterializeLobData` is `true`, LOB data is fully materialized within the JDBC driver when a row is fetched. If the value is `false`, LOB data is streamed. The driver uses locators internally to retrieve LOB data in chunks on an as-needed basis. It is highly recommended that you set this value to `false` when you retrieve LOBs that contain large amounts of data. The default is `true`.
- If the data source supports progressive streaming, also known as dynamic data format:  
The JDBC driver ignores the value of `fullyMaterializeLobData` if the `progressiveStreaming` property is set to `YES` (`DB2BaseDataSource.YES` in an application program) or is not set.

`fullyMaterializeLobData` has no effect on stored procedure parameters.

As in any other language, a LOB locator in a Java application is associated with only one data source. You cannot use a single LOB locator to move data between two different data sources. To move LOB data between two data sources, you need to materialize the LOB data when you retrieve it from a table in the first data source and then insert that data into the table in the second data source.

## LOB operations with the IBM Data Server Driver for JDBC and SQLJ

The IBM Data Server Driver for JDBC and SQLJ supports methods for updating and retrieving data from BLOB, CLOB, and DBCLOB columns in a table, and for calling stored procedures or user-defined functions with BLOB or CLOB parameters.

Among the operations that you can perform on LOB data under the IBM Data Server Driver for JDBC and SQLJ are:

- Specify a BLOB or column as an argument of the following ResultSet methods to retrieve data from a BLOB or CLOB column:

For BLOB columns:

- getBinaryStream
- getBlob
- getBytes

For CLOB columns:

- getAsciiStream
- getCharacterStream
- getClob
- getString

- Call the following ResultSet methods to update a BLOB or CLOB column in an updatable ResultSet:

For BLOB columns:

- updateBinaryStream
- updateBlob

For CLOB columns:

- updateAsciiStream
- updateCharacterStream
- updateClob

If you specify -1 for the *length* parameter in any of the previously listed methods, the IBM Data Server Driver for JDBC and SQLJ reads the input data until it is exhausted.

- Use the following PreparedStatement methods to set the values for parameters that correspond to BLOB or CLOB columns:

For BLOB columns:

- setBytes
- setBlob
- setBinaryStream
- setObject, where the *Object* parameter value is an InputStream.

For CLOB columns:

- setString
- setAsciiStream
- setClob
- setCharacterStream
- setObject, where the *Object* parameter value is a Reader.

If you specify -1 for *length*, the IBM Data Server Driver for JDBC and SQLJ reads the input data until it is exhausted.

- Retrieve the value of a JDBC CLOB parameter using the CallableStatement.getString method.

**Restriction:** With IBM Data Server Driver for JDBC and SQLJ type 2 connectivity, you cannot call a stored procedure that has DBCLOB OUT or INOUT parameters.



If you are using the IBM Data Server Driver for JDBC and SQLJ version 4.0 or later, you can perform the following additional operations:

- Use `ResultSet.updateXXX` or `PreparedStatement.setXXX` methods to update a BLOB or CLOB with a *length* value of up to 2GB for a BLOB or CLOB. For example, these methods are defined for BLOBs:

```
ResultSet.updateBlob(int columnIndex, InputStream x, long length)
ResultSet.updateBlob(String columnLabel, InputStream x, long length)
ResultSet.updateBinaryStream(int columnIndex, InputStream x, long length)
ResultSet.updateBinaryStream(String columnLabel, InputStream x, long length)
PreparedStatement.setBlob(int columnIndex, InputStream x, long length)
PreparedStatement.setBlob(String columnLabel, InputStream x, long length)
PreparedStatement.setBinaryStream(int columnIndex, InputStream x, long length)
PreparedStatement.setBinaryStream(String columnLabel, InputStream x, long length)
```
- Use `ResultSet.updateXXX` or `PreparedStatement.setXXX` methods without the *length* parameter when you update a BLOB or CLOB, to cause the IBM Data Server Driver for JDBC and SQLJ to read the input data until it is exhausted. For example:

```
ResultSet.updateBlob(int columnIndex, InputStream x)
ResultSet.updateBlob(String columnLabel, InputStream x)
ResultSet.updateBinaryStream(int columnIndex, InputStream x)
ResultSet.updateBinaryStream(String columnLabel, InputStream x)
PreparedStatement.setBlob(int columnIndex, InputStream x)
PreparedStatement.setBlob(String columnLabel, InputStream x)
PreparedStatement.setBinaryStream(int columnIndex, InputStream x)
PreparedStatement.setBinaryStream(String columnLabel, InputStream x)
```
- Create a Blob or Clob object that contains no data, using the `Connection.createBlob` or `Connection.createClob` method.
- Materialize a Blob or Clob object on the client, when progressive streaming or locators are in use, using the `Blob.getBinaryStream` or `Clob.getCharacterStream` method.
- Free the resources that a Blob or Clob object holds, using the `Blob.free` or `Clob.free` method.

## Java data types for retrieving or updating LOB column data in JDBC applications

When the JDBC driver cannot immediately determine the data type of a parameter that is used with a LOB column, you need to choose a parameter data type that is compatible with the LOB data type.

When the `deferPrepares` property is set to true, and the IBM Data Server Driver for JDBC and SQLJ processes a `PreparedStatement.setXXX` call, the driver might need to do extra processing to determine data types. This extra processing can impact performance.

### Input parameters for BLOB columns

For IN parameters for BLOB columns, or INOUT parameters that are used for input to BLOB columns, you can use one of the following techniques:

- Use a `java.sql.Blob` input variable, which is an exact match for a BLOB column:

```
cstmt.setBlob(paramIndex, blobData);
```
- Use a `CallableStatement.setObject` call that specifies that the target data type is BLOB:

```
byte[] byteData = {(byte)0x1a, (byte)0x2b, (byte)0x3c};
cstmt.setObject(paramInd, byteData, java.sql.Types.BLOB);
```



- Use an input parameter of type of `java.io.ByteArrayInputStream` with a `CallableStatement.setBinaryStream` call. A `java.io.ByteArrayInputStream` object is compatible with a BLOB data type. For this call, you need to specify the exact length of the input data:

```
java.io.ByteArrayInputStream byteStream =
    new java.io.ByteArrayInputStream(byteData);
int numBytes = byteData.length;
cstmt.setBinaryStream(parmIndex, byteStream, numBytes);
```

## Output parameters for BLOB columns

For OUT parameters for BLOB columns, or INOUT parameters that are used for output from BLOB columns, you can use the following technique:

- Use the `CallableStatement.registerOutParameter` call to specify that an output parameter is of type BLOB. Then you can retrieve the parameter value into any variable that has a data type that is compatible with a BLOB data type. For example, the following code lets you retrieve a BLOB value into a `byte[]` variable:

```
cstmt.registerOutParameter(parmIndex, java.sql.Types.BLOB);
cstmt.execute();
byte[] byteData = cstmt.getBytes(parmIndex);
```

## Input parameters for CLOB columns

For IN parameters for CLOB columns, or INOUT parameters that are used for input to CLOB columns, you can use one of the following techniques:

- Use a `java.sql.Clob` input variable, which is an exact match for a CLOB column:
- ```
cstmt.setClob(parmIndex, clobData);
```
- Use a `CallableStatement.setObject` call that specifies that the target data type is CLOB:

```
String charData = "CharacterString";
cstmt.setObject(parmInd, charData, java.sql.Types.CLOB);
```

- Use one of the following types of stream input parameters:
  - A `java.io.StringReader` input parameter with a `cstmt.setCharacterStream` call:

```
java.io.StringReader reader = new java.io.StringReader(charData);
cstmt.setCharacterStream(parmIndex, reader, charData.length);
```

- A `java.io.ByteArrayInputStream` parameter with a `cstmt.setAsciiStream` call, for ASCII data:

```
byte[] charDataBytes = charData.getBytes("US-ASCII");
java.io.ByteArrayInputStream byteStream =
    new java.io.ByteArrayInputStream(charDataBytes);
cstmt.setAsciiStream(parmIndex, byteStream, charDataBytes.length);
```

For these calls, you need to specify the exact length of the input data.

- Use a String input parameter with a `cstmt.setString` call:
- ```
cstmt.setString(parmIndex, charData);
```

If the length of the data is greater than 32KB, and the JDBC driver has no DESCRIBE information about the parameter data type, the JDBC driver assigns the CLOB data type to the input data.

- Use a String input parameter with a `cstmt.setObject` call, and specify the target data type as VARCHAR or LONGVARCHAR:

```
cstmt.setObject(parmIndex, charData, java.sql.Types.VARCHAR);
```

If the length of the data is greater than 32KB, and the JDBC driver has no DESCRIBE information about the parameter data type, the JDBC driver assigns the CLOB data type to the input data.

### Output parameters for CLOB columns

For OUT parameters for CLOB columns, or INOUT parameters that are used for output from CLOB columns, you can use one of the following techniques:

- Use the `CallableStatement.registerOutParameter` call to specify that an output parameter is of type CLOB. Then you can retrieve the parameter value into a `Clob` variable. For example:

```
cstmt.registerOutParameter(parmIndex, java.sql.Types.CLOB);
cstmt.execute();
Clob clobData = cstmt.getClob(parmIndex);
```

- Use the `CallableStatement.registerOutParameter` call to specify that an output parameter is of type VARCHAR or LONGVARCHAR:

```
cstmt.registerOutParameter(parmIndex, java.sql.Types.VARCHAR);
cstmt.execute();
String charData = cstmt.getString(parmIndex);
```

This technique should be used only if you know that the length of the retrieved data is less than or equal to 32KB. Otherwise, the data is truncated.

## ROWIDs in JDBC with the IBM Data Server Driver for JDBC and SQLJ

DB2 for z/OS and DB2 for i support the ROWID data type for a column in a database table. A ROWID is a value that uniquely identifies a row in a table.

Although IBM Informix also supports rowids, those rowids have the INTEGER data type. You can select an IBM Informix rowid column into a variable with a four-byte integer data type.

You can use the following `ResultSet` methods to retrieve data from a ROWID column:

- `getRowId` (JDBC 4.0 and later)
- `getBytes`
- `getObject`

You can use the following `ResultSet` method to update a ROWID column of an updatable `ResultSet`:

- `updateRowId` (JDBC 4.0 and later)  
`updateRowId` is valid only if the target database system supports updating of ROWID columns.

If you are using JDBC 3.0, for `getObject`, the IBM Data Server Driver for JDBC and SQLJ returns an instance of the IBM Data Server Driver for JDBC and SQLJ-only class `com.ibm.db2.jcc.DB2RowID`.

If you are using JDBC 4.0, for `getObject`, the IBM Data Server Driver for JDBC and SQLJ returns an instance of the class `java.sql.RowId`.

You can use the following `PreparedStatement` methods to set a value for a parameter that is associated with a ROWID column:

- `setRowId` (JDBC 4.0 and later)
- `setBytes`

- setObject

If you are using JDBC 3.0, for setObject, use the IBM Data Server Driver for JDBC and SQLJ-only type `com.ibm.db2.jcc.Types.ROWID` or an instance of the `com.ibm.db2.jcc.DB2RowID` class as the target type for the parameter.

If you are using JDBC 4.0, for setObject, use the type `java.sql.Types.ROWID` or an instance of the `java.sql.RowId` class as the target type for the parameter.

You can use the following CallableStatement methods to retrieve a ROWID column as an output parameter from a stored procedure call:

- getRowId (JDBC 4.0 and later)
- getObject

To call a stored procedure that is defined with a ROWID output parameter, register that parameter to be of the `java.sql.Types.ROWID` type.

ROWID values are valid for different periods of time, depending on the data source on which those ROWID values are defined. Use the `DatabaseMetaData.getRowIdLifetime` method to determine the time period for which a ROWID value is valid. The values that are returned for the data sources are listed in the following table.

*Table 14. DatabaseMetaData.getRowIdLifetime values for supported data sources*

Database server	DatabaseMetaData.getRowIdLifetime
DB2 for z/OS	ROWID_VALID_TRANSACTION
DB2 Database for Linux, UNIX, and Windows	ROWID_UNSUPPORTED
DB2 for i	ROWID_VALID_FOREVER
IBM Informix	ROWID_VALID_FOREVER

*Example: Using PreparedStatement.setRowId with a java.sql.RowId target type:* Suppose that `rowid` is a `RowId` object. To set parameter 1, use this form of the `setRowId` method:

```
ps.setRowId(1, rowid);
```

*Example: Using ResultSet.getRowId to retrieve a ROWID value from a data source:* To retrieve a ROWID value from the first column of a result set into `RowId` object `rowid`, use this form of the `ResultSet.getRowId` method:

```
java.sql.RowId rowid = rs.getRowId(1);
```

*Example: Using CallableStatement.registerOutParameter with a java.sql.Types.ROWID parameter type:* To register parameter 1 of a CALL statement as a `java.sql.Types.ROWID` data type, use this form of the `registerOutParameter` method:

```
cs.registerOutParameter(1, java.sql.Types.ROWID)
```

## Update and retrieval of timestamps with time zone information in JDBC applications

The JDBC methods and data types that you use and the information that the IBM Data Server Driver for JDBC and SQLJ has about the column data types determine the timestamp values that are sent to and received from `TIMESTAMP WITH TIME ZONE` or `TIMESTAMP` columns.

## Updates of values in **TIMESTAMP** or **TIMESTAMP WITH TIME ZONE** columns

You can use the following standard JDBC methods to update a **TIMESTAMP WITH TIME ZONE** or **TIMESTAMP** column:

- `PreparedStatement.setObject`
- `PreparedStatement.setTimestamp`
- `PreparedStatement.setString`

For a `PreparedStatement.setTimestamp` call in which the second parameter is a `DBTimestamp` object and the third parameter is a `Calendar` object, the value that is passed to a **TIMESTAMP WITH TIME ZONE** or **TIMESTAMP** column contains the time zone value in the `Calendar` parameter, and not the time zone value in the `DBTimestamp` object. For a `PreparedStatement.setTimestamp` in which the second parameter is a `DBTimestamp` object and there is no `Calendar` parameter, the IBM Data Server Driver for JDBC and SQLJ value that is passed to a **TIMESTAMP WITH TIME ZONE** or **TIMESTAMP** column has the default time zone, which is that of the Java virtual machine in which the application is running.

If you want the value that is passed to a **TIMESTAMP WITH TIME ZONE** or **TIMESTAMP** column to use the time zone that is in the `DBTimestamp` object, you need to use `PreparedStatement.setObject`.

*Example:* Suppose that table `TSTABLE` is defined like this:

```
CREATE TABLE TSTABLE (  
    TSCOL TIMESTAMP,  
    TSTZCOL TIMESTAMP WITH TIME ZONE)
```

Also suppose that the default time zone of the Java Virtual Machine (JVM) is `GMT-08:00` (Pacific Standard Time). The following code assigns timestamp values to the column.

```
...  
java.util.TimeZone esttz = java.util.TimeZone.getTimeZone("EST");  
java.util.Calendar estcal = java.util.Calendar.getInstance(esttz);  
    // Construct a Calendar object with the  
    // GMT-05:00 (Eastern Standard Time) time zone.  
java.util.Calendar defcal = java.util.Calendar.getInstance();  
    // Construct a Calendar object  
    // with the default time zone.  
java.sql.Timestamp ts =  
    java.sql.Timestamp.valueOf("2010-10-27 21:22:33.123456");  
    // Assign a timestamp to a Timestamp object.  
DBTimestamp dbts = new DBTimestamp(ts,estcal);  
    // Construct a DBTimestamp object that has  
    // the GMT-05:00 time zone.  
...  
PreparedStatement ps = con.prepareStatement(  
    "INSERT INTO TSTABLE (TSCOL,TSTZCOL) VALUES (?,?)");  
//  
// Use setTimestamp methods to assign a timestamp value to a  
// TIMESTAMP WITH TIME ZONE or TIMESTAMP column  
//  
ps.setTimestamp(1, ts); // Assign a timestamp value in a Timestamp  
    // object to a TIMESTAMP column.  
ps.setTimestamp(2,ts); // Assign the same timestamp value to  
    // a TIMESTAMP WITH TIME ZONE column.  
ps.execute(); // 2010-10-27-21.22.33.123456 is assigned to TSCOL  
    // if the driver has information that the column  
    // has the TIMESTAMP data type.  
    // 2010-10-27-21.22.33.123456-08:00 is assigned to TSCOL  
    // if the driver has no information about the column
```

```

        // data type.
        // 2010-10-27-21.22.33.123456-08:00 is assigned
        // to TSTZCOL regardless of whether the driver
        // has information that the the column has
        // the TIMESTAMP WITH TIME ZONE data type.
ps.setTimestamp(1, dbts);
        // Assign a timestamp value in a DBTimestamp
        // object to a TIMESTAMP column.
ps.setTimestamp(2,dbts);
        // Assign the same timestamp value to
        // a TIMESTAMP WITH TIME ZONE column.
ps.execute(); // 2010-10-27-21.22.33.123456 is assigned to TSCOL
        // if the driver has information that the column
        // has the TIMESTAMP data type.
        // 2010-10-27-21.22.33.123456-08:00 is assigned to TSCOL
        // if the driver has no information about the column
        // data type.
        // 2010-02-27-21.22.33.123456-08:00 is assigned
        // to TSTZCOL regardless of whether the driver
        // has information that the the column has
        // the TIMESTAMP WITH TIME ZONE data type. The
        // default time zone of GMT-08:00 is sent to
        // the column.
ps.setTimestamp(1, ts, estcal);
        // Assign a timestamp value in a Timestamp
        // object to a TIMESTAMP column. Include
        // a Calendar parameter that specifies
        // the GMT-05:00 time zone.
ps.setTimestamp(2, ts, estcal);
        // Assign the same timestamp value to
        // a TIMESTAMP WITH TIME ZONE column. Include
        // a Calendar parameter that specifies the
        // GMT-05:00 time zone.
ps.execute(); // 2010-10-28-00.22.33.123456 is assigned to TSCOL
        // if the driver has information that the column
        // has the TIMESTAMP data type.
        // The value is adjusted for the difference
        // between the time zone in the Calendar parameter and
        // the default time zone.
        // 2010-10-28-00.22.33.123456-05:00 is assigned to TSCOL
        // if the driver has no information about the column
        // data type. The value is adjusted for the difference
        // between the time zone in the Calendar parameter and
        // the default time zone.
        // 2010-10-28-00.22.33.123456-05:00 is assigned
        // to TSTZCOL regardless of whether the driver
        // has information that the the column has
        // the TIMESTAMP WITH TIME ZONE data type.
        // The value is adjusted for the difference
        // between the time zone in the Calendar parameter and
        // the default time zone.
ps.setTimestamp(1, dbts, estcal);
        // Assign a timestamp value in a DBTimestamp
        // object to a TIMESTAMP column. Include
        // a Calendar parameter that specifies the
        // GMT-05:00 time zone.
ps.setTimestamp(2, dbts, estcal);
        // Assign the same timestamp value to
        // a TIMESTAMP WITH TIME ZONE column.
ps.execute(); // 2010-10-28-00.22.33.123456 is assigned to TSCOL
        // if the driver has information that the column
        // has the TIMESTAMP data type.
        // The value is adjusted for the difference
        // between the time zone in the Calendar parameter and
        // the default time zone.
        // 2010-10-28-00.22.33.123456-05:00 is assigned to TSCOL
        // if the driver has no information about the column

```

```

// data type.
// The value is adjusted for the difference
// between the time zone in the Calendar parameter and
// the default time zone.
// 2010-10-28-00.22.33.123456-05:00 is assigned
// to TSTZCOL regardless of whether the driver
// has information that the the column has
// the TIMESTAMP WITH TIME ZONE data type. The
// time zone in the Calendar parameter, GMT-05:00,
// is sent to the column.
// The value is adjusted for the difference
// between the time zone in the Calendar parameter and
// the default time zone.
ps.setTimestamp(1, ts, defcal);
// Assign a timestamp value in a Timestamp
// object to a TIMESTAMP column. Include
// a Calendar parameter that specifies
// the default time zone (GMT-08:00).
ps.setTimestamp(2, ts, defcal);
// Assign the same timestamp value to
// a TIMESTAMP WITH TIME ZONE column. Include
// a Calendar parameter that specifies the
// default (GMT-08:00) time zone.
ps.execute(); // 2010-10-27-21.22.33.123456 is assigned to TSCOL
// if the driver has information that the column
// has the TIMESTAMP data type.
// 2010-10-27-21.22.33.123456-08:00 is assigned to TSCOL
// if the driver has no information about the column
// data type.
// 2010-10-27-21.22.33.123456-08:00 is assigned
// to TSTZCOL regardless of whether the driver
// has information that the the column has
// the TIMESTAMP WITH TIME ZONE data type.
ps.setTimestamp(1, dbts, defcal);
// Assign a timestamp value in a DBTimestamp
// object to a TIMESTAMP column
ps.setTimestamp(2, dbts, defcal);
// Assign the same timestamp value to
// a TIMESTAMP WITH TIME ZONE column
ps.execute(); // 2010-10-27-21.22.33.123456 is assigned to TSCOL
// if the driver has information that the column
// has the TIMESTAMP data type
// 2010-10-27-21.22.33.123456-08:00 is assigned to TSCOL
// if the driver has no information about the column
// data type
// 2010-10-27-21.22.33.123456-08:00 is assigned
// to TSTZCOL regardless of whether the driver
// has information that the the column has
// the TIMESTAMP WITH TIME ZONE data type. The
// default time zone in the Calendar parameter,
// GMT-08:00, is sent to the column.
//
// Use setObject methods to assign a timestamp value to a
// TIMESTAMP WITH TIME ZONE or TIMESTAMP column
//
ps.setObject(1, ts); // Assign a timestamp value in a Timestamp
// object to a TIMESTAMP column.
ps.setObject(2, ts);
// Assign the same timestamp value to
// a TIMESTAMP WITH TIME ZONE column.
ps.execute(); // 2010-10-27-21.22.33.123456 is assigned to TSCOL
// if the driver has information that the column
// has the TIMESTAMP data type.
// 2010-10-27-21.22.33.123456-08:00 is assigned to TSCOL
// if the driver has no information about the column
// data type. The time zone is the default time zone.
// 2010-10-27-21.22.33.123456-08:00 is assigned

```

```

        // to TSTZCOL regardless of whether the driver
        // has information that the the column has
        // the TIMESTAMP WITH TIME ZONE data type. The
        // time zone is the default time zone.
ps.setObject(1, dbts);
        // Assign a timestamp value in a DBTimestamp
        // object to a TIMESTAMP column.
ps.setObject(2, dbts);
        // Assign the same timestamp value to
        // a TIMESTAMP WITH TIME ZONE column.
ps.execute(); // 2010-10-28-00.22.33.123456 is assigned to TSCOL
        // if the driver has information that the column
        // has the TIMESTAMP data type.
        // 2010-10-28-00.22.33.123456-05:00 is assigned to TSCOL
        // if the driver has no information about the column
        // data type.
        // 2010-10-28-00.22.33.123456-05:00 is assigned
        // to TSTZCOL regardless of whether the driver
        // has information that the the column has
        // the TIMESTAMP WITH TIME ZONE data type.
        // The time zone is the time zone in the DBTimestamp
        // object.
//
// Use setString methods to assign a timestamp value to a
// TIMESTAMP WITH TIME ZONE or TIMESTAMP column
//
ps.setString(1, "2010-10-27-21.22.33.123456");
        // Assign a constant timestamp value
        // with no time zone to a TIMESTAMP column.
ps.setString(2, "2010-10-27-21.22.33.123456");
        // Assign the same timestamp value to
        // a TIMESTAMP WITH TIME ZONE column.
ps.execute(); // 2010-10-27-21.22.33.123456 is assigned to TSCOL
        // regardless of whether the driver has information
        // that the column has the TIMESTAMP data type.
        // 2010-10-27-21.22.33.123456-08:00 is assigned
        // to TSTZCOL if the driver has information that
        // the column has the TIMESTAMP WITH TIME ZONE
        // data type. The time zone is the default time zone.
        // 2010-10-27-21.22.33.123456 is assigned to TSTZCOL
        // if the driver has no information about the column
        // data type.
ps.setString(1, "2010-10-27-21.22.33.123456-05:00");
        // Assign a constant timestamp value
        // with a time zone to a TIMESTAMP column.
ps.setString(2, "2010-10-27-21.22.33.123456-05:00");
        // Assign the same timestamp value to
        // a TIMESTAMP WITH TIME ZONE column.
ps.execute(); // 2010-10-27-21.22.33.123456 is assigned to TSCOL
        // if the driver has information that the column
        // data type is TIMESTAMP.
        // 2010-10-27-21.22.33.123456-05:00 is assigned to
        // TSCOL if the driver has no information about the
        // column data type.
        // 2010-10-27-21.22.33.123456-05:00 is assigned
        // to TSTZCOL regardless of whether the driver has
        // information that the column data type is
        // TIMESTAMP WITH TIME ZONE.

```

Alternatively, if you want to assign data that has a time zone or has a precision of greater than nine to a `TIMESTAMP WITH TIME ZONE` column, you can construct a `DBTimestamp` object, and use the IBM Data Server Driver for JDBC and SQLJ-only method `DB2PreparedStatement.setDBTimestamp` to update a `TIMESTAMP WITH TIME ZONE` column.

*Example:* Suppose that table `TSTABLE` is defined like this:



```
CREATE TABLE TSTABLE (
    TSCOL TIMESTAMP,
    TSTZCOL TIMESTAMP(12) WITH TIME ZONE)
```

The following code assigns a timestamp value with a time zone and a precision of 10 to each column.

```
...
DBTimestamp tstz =
    DBTimestamp.valueOfDBString("2010-10-28-00.22.33.1234567890-05:00");
    // Create a DBTimestamp object from the input value
PreparedStatement ps = con.prepareStatement(
    "INSERT INTO TSTABLE (TSCOL, TSTXCOL) VALUES (?,?)");

DB2PreparedStatement dbps = (DB2PreparedStatement)ps;
dbps.setDBTimestamp(1, tstz);
dbps.setDBTimestamp(2, tstz);
dbps.execute(); // 2010-10-28-00.22.33.123456 is assigned to TSCOL if
                // the driver has information that the column data type is
                // TIMESTAMP.
                // 2010-10-28-00.22.33.1234567890-05:00 is assigned to TSCOL
                // if the driver has no information about the column
                // data type.
                // 2010-10-28-00.22.33.1234567890-05:00 is assigned to TSTZCOL
                // regardless of whether the driver has information that
                // the column data type is TIMESTAMP(12) WITH TIME ZONE.
```

## Retrieval of values from **TIMESTAMP** or **TIMESTAMP WITH TIME ZONE** columns

You can use the following standard JDBC methods to retrieve data from a **TIMESTAMP WITH TIME ZONE** or **TIMESTAMP** column or output parameter:

- `ResultSet.getTimestamp`
- `CallableStatement.getTimestamp`
- `ResultSet.getObject`
- `CallableStatement.getObject`
- `ResultSet.getString`
- `CallableStatement.getString`

For a `ResultSet.getTimestamp`, `CallableStatement.getTimestamp`, `ResultSet.getObject`, or `CallableStatement.getObject` call, you can specify the type of object that you want the IBM Data Server Driver for JDBC and SQLJ to return by setting the `DB2BaseDataSource.timestampOutputType` property:

- If you set the property to `DB2BaseDataSource.JDBC_TIMESTAMP` (1), the driver returns a `java.sql.Timestamp` object.
- If you set the property to `DB2BaseDataSource.JCC_DBTIMESTAMP` (2), the driver returns a `com.ibm.db2.jcc.DBTimestamp` object.

For a `ResultSet.getTimestamp` or `CallableStatement.getTimestamp` call, if the `ResultSet.getTimestamp` or `CallableStatement.getTimestamp` call has a `Calendar` parameter with a non-null value, the IBM Data Server Driver for JDBC and SQLJ uses the `Calendar` object when it constructs the returned object. If the `ResultSet.getTimestamp` or `CallableStatement.getTimestamp` call has no `Calendar` parameter, or the `Calendar` parameter value is null, the IBM Data Server Driver for JDBC and SQLJ uses the default time zone when it constructs the returned object.

If you want to retrieve a timestamp with the time zone value that is in a **TIMESTAMP WITH TIME ZONE** column, call `ResultSet.getObject` or `CallableStatement.getObject`, and then call `DBTimestamp.toDBString(true)` to retrieve the timestamp with the time zone.



getString retrieves the timestamp value in the standard JDBC format: without the time zone, and with a precision of up to nine. The returned value is adjusted for the difference between the time zone of the column value and the default time zone.

*Example:* Suppose that table TSTABLE is defined like this:

```
CREATE TABLE TSTABLE (
  TSCOL TIMESTAMP,
  TSTZCOL TIMESTAMP WITH TIME ZONE)
```

Also suppose that the default time zone is GMT-08:00 (Pacific Standard Time). The following code retrieves timestamp values from the TIMESTAMP column.

```
...
java.util.TimeZone esttz = java.util.TimeZone.getTimeZone("EST");
java.util.Calendar estcal = java.util.Calendar.getInstance(esttz);
java.util.Calendar defcal = java.util.Calendar.getInstance();
Statement stmt = conn.createStatement ();
ResultSet rs = stmt.executeQuery("SELECT TSCOL, TSTZCOL FROM TSTABLE");
com.ibm.db2.jcc.DB2ResultSet dbrs = (com.ibm.db2.jcc.DB2ResultSet)rs;
Timestamp ts;
DBTimestamp dbts;
...
rs.next();
// Suppose that the TSCOL column value is 2010-10-27-21.22.33.123456

ts=rs.getTimestamp(1);           // Retrieve the TIMESTAMP column value
                                // into a Timestamp object.
ts.toString();                   // Format the Timestamp object as a String.
                                // 2010-10-27-21:22:33.123456 is
                                // returned.
((DBTimestamp)ts).toDBString(false); // Cast the retrieved object to a
                                // DBTimestamp object, and format the
                                // value as a String, without the time
                                // zone information.
                                // 2010-10-27-21.22.33.123456 is returned.
((DBTimestamp)ts).toDBString(true);  // Cast the retrieved object to a
                                // DBTimestamp object, and format the value
                                // as a String, with the time zone
                                // information.
                                // 2009-02-27-21.22.33.123456-08:00 is
                                // returned. The time zone is the default
                                // time zone.
ts=rs.getTimestamp(1,estcal);      // Retrieve the TIMESTAMP column value
                                // into a Timestamp object. Specify a
                                // calendar parameter that says that the
                                // time zone is GMT-05:00.
ts.toString();                     // Format the value as a String, using the
                                // default time zone of GMT-08:00.
                                // 2010-10-27-18:22:33.123456 is
                                // returned.
((DBTimestamp)ts).toDBString(false); // Cast the retrieved object to a
                                // DBTimestamp object, and format the
                                // value as a String, without the time zone
                                // information.
                                // 2010-10-27-21.22.33.123456 is returned.
((DBTimestamp)ts).toDBString(true);  // Cast the retrieved object to a
                                // DBTimestamp object, and format the
                                // value as a String, with the time zone
                                // information.
                                // 2010-10-27-21.22.33.123456-05:00 is
                                // returned. The time zone is the time zone
                                // in the Calendar parameter.
ts=rs.getObject(1);               // Retrieve the TIMESTAMP column value
                                // into an Object.
ts.toString();                     // Format the Timestamp object as a String.
```

```

// 2010-10-27-21:22:33.123456 is
// returned.
((DBTimestamp)ts).toDBString(false); // Cast the retrieved object to a
// DBTimestamp object, and format the
// value as a String, without the time
// zone information.
// 2010-10-27-21.22.33.123456 is returned.
((DBTimestamp)ts).toDBString(true); // Cast the retrieved object to a
// DBTimestamp object, and format the value
// as a String, with the time zone
// information.
// 2009-02-27-21.22.33.123456-08:00 is
// returned. The time zone is the default
// time zone.

```

Alternatively, you can use DB2ResultSet methods to retrieve the `TIMESTAMP` or `TIMESTAMP WITH TIME ZONE` column values.

*Example:* Suppose that table `TSTABLE` is defined like this:

```

CREATE TABLE TSTABLE (
  TSCOL TIMESTAMP,
  TSTZCOL TIMESTAMP(12) WITH TIME ZONE)

```

Also suppose that the default time zone is `GMT-08:00` (Pacific Standard Time). The following code retrieves timestamp values from the `TIMESTAMP` and `TIMESTAMP WITH TIME ZONE` columns.

```

...
java.util.TimeZone esttz = java.util.TimeZone.getTimeZone("EST");
java.util.Calendar estcal = java.util.Calendar.getInstance(esttz);
java.util.Calendar defcal = java.util.Calendar.getInstance();
Statement stmt = conn.createStatement ();
ResultSet rs = stmt.executeQuery("SELECT TSCOL, TSTZCOL FROM TSTABLE");
com.ibm.db2.jcc.DB2ResultSet dbrs = (com.ibm.db2.jcc.DB2ResultSet)rs;
Timestamp ts;
DBTimestamp dbts;
...
rs.next();
// Suppose that the TSTZCOL column value is 2010-10-28-00.22.33.123456-05:00, and
// the TSCOL column value is 2010-10-27-21.22.33.123456.
ts=dbrs.getDBTimestamp(1); // Retrieve the TIMESTAMP column value into
// a Timestamp object.
ts.toString(); // Format the Timestamp object as a String.
// 2010-10-27-21:22:33.123456 is
// returned.
((DBTimestamp)ts).toDBString(false); // Format the value as a String, without
// the time zone information.
// 2010-10-27-21.22.33.123456 is returned.
((DBTimestamp)ts).toDBString(true); // Format the value as a String, with the
// time zone information.
// 2009-02-27-21.22.33.123456-08:00 is
// returned. The time zone is the default
// time zone.
ts=dbrs.getDBTimestamp(2); // Retrieve the TIMESTAMP WITH TIME ZONE
// column value into a Timestamp object.
ts.toString(); // Format the Timestamp object as a String.
// 2010-10-27-21:22:33.123456 is
// returned. The returned value differs
// from the original value because toString
// uses the default time zone in its
// calculations.
((DBTimestamp)ts).toDBString(false); // Format the value as a String, without
// the time zone information.
// 2010-10-28-00.22.33.123456 is returned.
((DBTimestamp)ts).toDBString(true); // Format the value as a String, with the
// time zone information.

```

```

// 2010-10-28-00.22.33.123456-05:00 is
// returned. The time zone is the time zone
// from the retrieved column value.
dbts = (DBTimestamp)rs.getTimestamp(2);
// Retrieve the TIMESTAMP WITH TIME ZONE
// column value into a DBTimestamp object.
dbts.toString();
// Format the DBTimestamp object as a String.
// 2010-10-27-21:22:33.123456 is
// returned. The value is adjusted for the
// difference between the time zone in the
// column value and the default time zone.
dbts.toDBString(false);
// Format the value as a String, without
// the time zone information. The value is
// adjusted for the difference between the
// time zone in the column value and the
// default time zone.
// 2010-10-27-21.22.33.123456 is returned.
dbts.toDBString(true);
// Format the value as a String, with the
// time zone information.
// 2009-02-27-21.22.33.123456-08:00 is
// returned. The time zone is the default
// time zone. The value is adjusted for
// the difference between the time zone in
// the column value and the default
// time zone.
dbts = (DBTimestamp)rs.getTimestamp(2, defcal);
// Retrieve the TIMESTAMP WITH TIME ZONE
// column value into a DBTimestamp object,
// using the default Calendar to construct
// the DBTimestamp object.
dbts.toString();
// Format the DBTimestamp object as a String.
// 2010-10-27-21:22:33.123456 is
// returned. The value is adjusted for
// the difference between the time zone in
// the column value and the time zone
// in the Calendar parameter.
dbts.toDBString(false);
// Format the value as a String, without
// the time zone information.
// 2010-10-27-21.22.33.123456 is returned.
// The value is adjusted for
// the difference between the time zone in
// the column value and the time zone
// in the Calendar parameter.
dbts.toDBString(true);
// Format the value as a String, with the
// time zone information.
// 2009-02-27-21.22.33.123456-08:00 is
// returned. The value is adjusted for
// the difference between the time zone in
// the column value and the time zone
// in the Calendar parameter.
dbts = (DBTimestamp)rs.getObject(2);
// Retrieve the TIMESTAMP WITH TIME ZONE
// column value into an Object, and cast
// the object as a DBTimestamp object.
dbts.toString();
// Format the DBTimestamp object as a String.
// 2010-10-27-21:22:33.123456 is
// returned. The returned value differs from
// the original value because toString uses
// the default time zone in its calculations.
dbts.toDBString(false);
// Format the value as a String, without
// the time zone information.
// 2010-10-28-00.22.33.123456 is returned.
dbts.toDBString(true);
// Format the value as a String, with the
// time zone information.
// 2009-10-28-00.22.33.123456-05:00 is
// returned. The time zone is the time
// zone in the retrieved column value.

```

**Recommendation:** Use `getObject` or `getDBTimestamp`, followed by `setObject` or `setDBTimestamp` when you need to preserve the original timestamp with time zone information when you retrieve data from one table and insert it into another table.

## Distinct types in JDBC applications

A distinct type is a user-defined data type that is internally represented as a built-in SQL data type. You create a distinct type by executing the SQL statement `CREATE DISTINCT TYPE`.

In a JDBC program, you can create a distinct type using the `executeUpdate` method to execute the `CREATE DISTINCT TYPE` statement. You can also use `executeUpdate` to create a table that includes a column of that type. When you retrieve data from a column of that type, or update a column of that type, you use Java identifiers with data types that correspond to the built-in types on which the distinct types are based.

The following example creates a distinct type that is based on an `INTEGER` type, creates a table with a column of that type, inserts a row into the table, and retrieves the row from the table:

```
Connection con;
Statement stmt;
ResultSet rs;
String empNumVar;
int shoeSizeVar;
...
stmt = con.createStatement();           // Create a Statement object
stmt.executeUpdate(
    "CREATE DISTINCT TYPE SHOESIZE AS INTEGER"); // Create distinct type
stmt.executeUpdate(
    "CREATE TABLE EMP_SHOE (EMPNO CHAR(6), EMP_SHOE_SIZE SHOESIZE)"); // Create table with distinct type
stmt.executeUpdate("INSERT INTO EMP_SHOE " +
    "VALUES ('000010', 6)");           // Insert a row
rs=stmt.executeQuery("SELECT EMPNO, EMP_SHOE_SIZE FROM EMP_SHOE); // Create ResultSet for query
while (rs.next()) {
    empNumVar = rs.getString(1);       // Get employee number
    shoeSizeVar = rs.getInt(2);        // Get shoe size (use int
                                        // because underlying type
                                        // of SHOESIZE is INTEGER)
    System.out.println("Employee number = " + empNumVar +
        " Shoe size = " + shoeSizeVar);
}
rs.close();                            // Close ResultSet
stmt.close();                           // Close Statement
```

Figure 16. Creating and using a distinct type

## Invocation of stored procedures with ARRAY parameters in JDBC applications

JDBC applications that run under the IBM Data Server Driver for JDBC and SQLJ can call stored procedures that have `ARRAY` parameters. `ARRAY` parameters are supported in stored procedures on DB2 Database for Linux, UNIX, and Windows Version 9.5 and later.

You can use `java.sql.Array` objects as `IN`, `OUT`, or `INOUT` parameters in a stored procedure.

For IN or INOUT parameters, use the `DB2Connection.createArrayOf` method (JDBC 3.0 or earlier) or the `Connection.createArrayOf` method (JDBC 4.0 or later) to create a `java.sql.Array` object. Use the `CallableStatement.setArray` method or the `CallableStatement.setObject` method to assign a `java.sql.Array` object to an ARRAY stored procedure parameter.

You can register an OUT ARRAY parameter for a stored procedure call by specifying `java.sql.Types.ARRAY` as the parameter type in a `CallableStatement.registerOutParameter` call.

There are two ways to retrieve data from an ARRAY output parameter:

- Use the `CallableStatement.getArray` method to retrieve the data into a `java.sql.Array` object, and use the `java.sql.Array.getArray` method to retrieve the contents of the `java.sql.Array` object into a Java array.
- Use the `CallableStatement.getArray` method to retrieve the data into a `java.sql.Array` object. Use the `java.sql.Array.getResultSet()` method to retrieve the data into a `ResultSet` object. Use `ResultSet` methods to retrieve elements of the array. Each row of the `ResultSet` contains two columns:
  - An index into the array, which starts at 1
  - The array element

**Example:** Suppose that input and output parameters `IN_PHONE` and `OUT_PHONE` in stored procedure `GET_EMP_DATA` are arrays that are defined like this:

```
CREATE TYPE PHONENUMBERS AS VARCHAR(10) ARRAY[5]
```

Call `GET_EMP_DATA` with the two parameters.

```
Connection con;
CallableStatement cstmt;
ResultSet rs;
java.sql.Array inPhoneData;
...
cstmt = con.prepareCall("CALL GET_EMP_DATA(?,?)");
// Create a CallableStatement object
cstmt.setObject (1, inPhoneData); // Set input parameter
cstmt.registerOutParameter (2, java.sql.Types.ARRAY);
// Register out parameters
cstmt.executeUpdate(); // Call the stored procedure
Array outPhoneData = cstmt.getArray(2);
// Get the output parameter array
System.out.println("Parameter values from GET_EMP_DATA call: ");
String [] outPhoneNums = (String [])outPhoneData.getArray();
// Retrieve output data from the JDBC Array object
// into a Java String array
for(int i=0; i<outPhoneNums.length; i++) {
    System.out.print(outPhoneNums[i]);
    System.out.println();
}
```

## Savepoints in JDBC applications

An SQL savepoint represents the state of data and schemas at a particular point in time within a unit of work. You can use SQL statements to set a savepoint, release a savepoint, and restore data and schemas to the state that the savepoint represents.

The IBM Data Server Driver for JDBC and SQLJ supports the following methods for using savepoints:

**Connection.setSavepoint() or Connection.setSavepoint(String name)**

Sets a savepoint. These methods return a Savepoint object that is used in later releaseSavepoint or rollback operations.

When you execute either of these methods, DB2 executes the form of the SAVEPOINT statement that includes ON ROLLBACK RETAIN CURSORS.

**Connection.releaseSavepoint(Savepoint savepoint)**

Releases the specified savepoint, and all subsequently established savepoints.

**Connection.rollback(Savepoint savepoint)**

Rolls back work to the specified savepoint.

**DatabaseMetaData.supportsSavepoints()**

Indicates whether a data source supports savepoints.

You can indicate whether savepoints are unique by calling the method DB2Connection.setSavePointUniqueOption. If you call this method with a value of true, the application cannot set more than one savepoint with the same name within the same unit of recovery. If you call this method with a value of false (the default), multiple savepoints with the same name can be created within the same unit of recovery, but creation of a savepoint destroys a previously created savepoint with the same name.

The following example demonstrates how to set a savepoint, roll back to the savepoint, and release the savepoint.

```

Connection con;
Statement stmt;
ResultSet rs;
String empNumVar;
int shoeSizeVar;
...
con.setAutoCommit(false);           // set autocommit OFF
stmt = con.createStatement();        // Create a Statement object
...                                  // Perform some SQL
con.commit();                        // Commit the transaction
stmt.executeUpdate("INSERT INTO EMP_SHOE " +
    "VALUES ('000010', 6)");         // Insert a row
((com.ibm.db2.jcc.DB2Connection)con).setSavePointUniqueOption(true);
// Indicate that savepoints
// are unique within a unit
// of recovery
Savepoint savept = con.setSavepoint("savepoint1");
// Create a savepoint
...
stmt.executeUpdate("INSERT INTO EMP_SHOE " +
    "VALUES ('000020', 10)");       // Insert another row
conn.rollback(savept);              // Roll back work to the point
// after the first insert
...
con.releaseSavepoint(savept);       // Release the savepoint
stmt.close();                       // Close the Statement
conn.commit();                      // Commit the transaction

```

Figure 17. Setting, rolling back to, and releasing a savepoint in a JDBC application

## Retrieval of automatically generated keys in JDBC applications

With the IBM Data Server Driver for JDBC and SQLJ, you can retrieve automatically generated keys (also called auto-generated keys) from a table using JDBC 3.0 methods.

An *automatically generated key* is any value that is generated by the data server, instead of being specified by the user. One type of automatically generated key is the contents of an identity column. An identity column is a table column that provides a way for the data source to automatically generate a numeric value for each row. You define an identity column in a CREATE TABLE or ALTER TABLE statement by specifying the AS IDENTITY clause when you define a column that has an exact numeric type with a scale of 0 (SMALLINT, INTEGER, BIGINT, DECIMAL with a scale of zero, or a distinct type based on one of these types).

For connections to DB2 for z/OS or DB2 Database for Linux, UNIX, and Windows, the IBM Data Server Driver for JDBC and SQLJ supports the return of automatically generated keys for INSERT statements, for searched UPDATE or searched DELETE statements, or for MERGE statements. For UPDATE, DELETE, or MERGE statements, you can identify any columns as automatically generated keys, even if they are not generated by the data server. In this case, the column values that are returned are the column values for the rows that are modified by the UPDATE, DELETE, or MERGE statement.

**Restriction:** If the Connection or DataSource property atomicMultiRowInsert is set to DB2BaseDataSource.YES (1), you cannot prepare an SQL statement for retrieval of automatically generated keys and use the PreparedStatement object for batch updates. The IBM Data Server Driver for JDBC and SQLJ version 3.50 or later throws an SQLException when you call the addBatch or executeBatch method on a PreparedStatement object that is prepared to return automatically generated keys.

### Retrieving auto-generated keys for an INSERT statement

With the IBM Data Server Driver for JDBC and SQLJ, you can use JDBC 3.0 methods to retrieve the keys that are automatically generated when you execute an INSERT statement.

#### About this task

To retrieve automatically generated keys that are generated by an INSERT statement, you need to perform these steps.

#### Procedure

1. Use one of the following methods to indicate that you want to return automatically generated keys:
  - If you plan to use the PreparedStatement.executeUpdate method to insert rows, invoke one of these forms of the Connection.prepareStatement method to create a PreparedStatement object:

The following form is valid for a table on any data source that supports identity columns. *sql-statement* must be a single-row INSERT statement.

**Restriction:** For IBM Data Server Driver for JDBC and SQLJ version 3.57 or later, the following form is not valid for inserting rows into a view on a DB2 for z/OS data server.

```
Connection.prepareStatement(sql-statement,  
Statement.RETURN_GENERATED_KEYS);
```

The following forms are valid only if the data source supports SELECT FROM INSERT statements. *sql-statement* can be a single-row INSERT statement or a multiple-row INSERT statement. With the first form, you specify the names of the columns for which you want automatically generated keys. With the second form, you specify the positions in the table of the columns for which you want automatically generated keys.



```

Connection.prepareStatement(sql-statement, String [] columnNames);
Connection.prepareStatement(sql-statement, int [] columnIndexes);

```

- If you use the Statement.executeUpdate method to insert rows, invoke one of these forms of the Statement.executeUpdate method:

The following form is valid for a table on any data source that supports identity columns. *sql-statement* must be a single-row INSERT statement.

**Restriction:** For IBM Data Server Driver for JDBC and SQLJ version 3.57 or later, the following form is not valid for inserting rows into a view on a DB2 for z/OS data server.

```
Statement.executeUpdate(sql-statement, Statement.RETURN_GENERATED_KEYS);
```

The following forms are valid only if the data source supports SELECT FROM INSERT statements. *sql-statement* can be a single-row INSERT statement or a multiple-row INSERT statement. With the first form, you specify the names of the columns for which you want automatically generated keys. With the second form, you specify the positions in the table of the columns for which you want automatically generated keys.

```
Statement.executeUpdate(sql-statement, String [] columnNames);
Statement.executeUpdate(sql-statement, int [] columnIndexes);
```

2. Invoke the PreparedStatement.getGeneratedKeys method or the Statement.getGeneratedKeys method to retrieve a ResultSet object that contains the automatically generated key values.

If you include the Statement.RETURN\_GENERATED\_KEYS parameter, the data type of the automatically generated keys in the ResultSet is DECIMAL, regardless of the data type of the corresponding column.

## Example

The following code creates a table with an identity column, inserts a row into the table, and retrieves the automatically generated key value for the identity column. The numbers to the right of selected statements correspond to the previously described steps.

```

import java.sql.*;
import java.math.*;
import com.ibm.db2.jcc.*;

Connection con;
Statement stmt;
ResultSet rs;
java.math.BigDecimal idColVar;
...
stmt = con.createStatement();           // Create a Statement object

stmt.executeUpdate(
    "CREATE TABLE EMP_PHONE (EMPNO CHAR(6), PHONENO CHAR(4), " +
    "IDENTCOL INTEGER GENERATED ALWAYS AS IDENTITY)");
// Create table with identity column
stmt.executeUpdate("INSERT INTO EMP_PHONE (EMPNO, PHONENO) " + // 1
    "VALUES ('000010', '5555')", // Insert a row
    Statement.RETURN_GENERATED_KEYS); // Indicate you want automatically
// generated keys
rs = stmt.getGeneratedKeys(); // 2 // Retrieve the automatically
// generated key value in a ResultSet.
// Only one row is returned.
// Create ResultSet for query

while (rs.next()) {
    java.math.BigDecimal idColVar = rs.getBigDecimal(1);
// Get automatically generated key
// value

```



```

    System.out.println("automatically generated key value = " + idColVar);
}
rs.close();                // Close ResultSet
stmt.close();              // Close Statement

```

The following code creates a table with an identity column, inserts two rows into the table using a multiple-row INSERT statement, and retrieves the automatically generated key values for the identity column. The numbers to the right of selected statements correspond to the previously-described steps.

```

import java.sql.*;
import java.math.*;
import com.ibm.db2.jcc.*;

Connection con;
Statement stmt;
ResultSet rs;
...
stmt = con.createStatement();

stmt.executeUpdate(
    "CREATE TABLE EMP_PHONE (EMPNO CHAR(6), PHONENO CHAR(4), " +
    "IDENTCOL INTEGER GENERATED ALWAYS AS IDENTITY)");
// Create table with identity column

String[] id_col = {"IDENTCOL"};
int updateCount = 1
    stmt.executeUpdate("INSERT INTO EMP_PHONE (EMPNO, PHONENO)" +
    "VALUES ('000010', '5555'), ('000020', '5556')", id_col);
// Insert two rows
// Indicate you want automatically
// generated keys

rs = stmt.getGeneratedKeys(); // Retrieve the automatically 2
// generated key values in a ResultSet.
// Two rows are returned.
// Create ResultSet for query

while (rs.next()) {
    int idColVar = rs.getInt(1);
// Get automatically generated key
// values

    System.out.println("automatically generated key value = " + idColVar);
}
stmt.close();
con.close();

```

## Retrieving auto-generated keys for an UPDATE, DELETE, or MERGE statement

With the IBM Data Server Driver for JDBC and SQLJ, you can use JDBC 3.0 methods to retrieve the keys that are automatically generated when you execute a searched UPDATE, searched DELETE, or MERGE statement.

### About this task

To retrieve automatically generated keys that are generated by an UPDATE, DELETE, or MERGE statement, you need to perform these steps.

### Procedure

1. Construct a String array that contains the names of the columns from which you want to return automatically generated keys.  
The array must be an array of column names, and not column indexes.
2. Set the autocommit mode for the connection to false.
3. Use one of the following methods to indicate that you want to return automatically generated keys:

- If you plan to use the `PreparedStatement.executeUpdate` method to update, delete, or merge rows, invoke this form of the `Connection.prepareStatement` method to create a `PreparedStatement` object:
 

```
Connection.prepareStatement(sql-statement, String [] columnNames);
```
  - If you use the `Statement.executeUpdate` method to update, delete, or merge rows, invoke this form of the `Statement.executeUpdate` method:
 

```
Statement.executeUpdate(sql-statement, String [] columnNames);
```
4. Invoke the `PreparedStatement.getGeneratedKeys` method or the `Statement.getGeneratedKeys` method to retrieve a `ResultSet` object that contains the automatically generated key values.

## Example

Suppose that a table is defined like this and has thirty rows:

```
CREATE TABLE EMP_BONUS
  (EMPNO CHAR(6),
   BONUS DECIMAL(9,2))
```

The following code names the `EMPNO` column as an automatically generated key, updates the thirty rows in the `EMP_BONUS` table, and retrieves the values of `EMPNO` for the updated rows. The numbers to the right of selected statements correspond to the previously described steps.

```
import java.sql.*;
...
Connection conn;
...
String[] agkNames = {"EMPNO"};           1
int updateCount = 0;
conn.setAutoCommit(false);              2
PreparedStatement ps =                   3
  conn.prepareStatement("UPDATE EMP_BONUS SET BONUS = " +
  " BONUS + 300.00",agkNames);
updateCount = ps.executeUpdate();
ResultSet rs = ps.getGeneratedKeys();    4
while (rs.next()) {
  String agkEmpNo = rs.getString(1);
  // Get automatically generated key value
  System.out.println("Automatically generated key value = " + agkEmpNo);
}
ps.close();
conn.close();
```

## Using named parameter markers in JDBC applications

You can use named parameter markers instead of standard parameter markers in `PreparedStatement` and `CallableStatement` objects to assign values to the input parameter markers. You can also use named parameter markers instead of standard parameter markers in `CallableStatement` objects to register OUT parameters that have named parameter markers.

### About this task

SQL strings that contain the following SQL elements can include named parameter markers:

- CALL
- DELETE
- INSERT
- MERGE
- PL/SQL block

- SELECT
- SET
- UPDATE

Named parameter markers make your JDBC applications more readable. If you have named parameter markers in an application, set the IBM Data Server Driver for JDBC and SQLJ Connection or DataSource property `enableNamedParameterMarkers` to `DB2BaseDataSource.YES (1)` to direct the driver to accept named parameter markers and send them to the data source as standard parameter markers.

If you are connected to a DB2 Database for Linux, UNIX, and Windows Version 9.7 or later data server, your SQL strings can include PL/SQL blocks with named parameters. Before you can use named parameters in PL/SQL blocks, the `DB2_COMPATIBILITY_VECTOR` registry variable needs to be set at the data server to allow PL/SQL compilation.

### Using named parameter markers with PreparedStatement objects

You can use named parameter markers instead of standard parameter markers in PreparedStatement objects to assign values to the parameter markers.

#### Before you begin

To ensure that applications with named parameters work correctly, regardless of the data server type and version, before you use named parameter markers in your applications, set the Connection or DataSource property `enableNamedParameterMarkers` to `DB2BaseDataSource.YES`.

#### About this task

To use named parameter markers with PreparedStatement objects, follow these steps.

#### Procedure

1. Execute the `Connection.prepareStatement` method on an SQL statement string that contains named parameter markers. The named parameter markers must follow the rules for SQL host variable names.

You cannot mix named parameter markers and standard parameter markers in the same SQL statement string.

Named parameter markers are case-insensitive.

2. For each named parameter marker, use a `DB2PreparedStatement.setJccXXXAtName` method to assign a value to each named input parameter.

If you use the same named parameter marker more than once in the same SQL statement string, you need to call a `setJccXXXAtName` method for that parameter marker only once.

**Recommendation:** Do not use the same named parameter marker more than once in the same SQL statement string if the input to that parameter marker is a stream. Doing so can cause unexpected results.

**Restriction:** You cannot use standard JDBC `PreparedStatement.setXXX` methods with named parameter markers. Doing so causes an exception to be thrown.

3. Execute the `PreparedStatement`.

## Example

The following code uses named parameter markers to update the phone number to '4657' for the employee with employee number '000010'. The numbers to the right of selected statements correspond to the previously described steps.

```
Connection con;
PreparedStatement pstmt;
int numUpd;
...
pstmt = con.prepareStatement(
    "UPDATE EMPLOYEE SET PHONENO=:phonenum WHERE EMPNO=:empnum");
// Create a PreparedStatement object 1
((com.ibm.db2.jcc.DB2PreparedStatement)pstmt).setJccStringAtName
("phonenum", "4567");
// Assign a value to phonenum parameter 2
((com.ibm.db2.jcc.DB2PreparedStatement)pstmt).setJccStringAtName
("empnum", "000010");
// Assign a value to empnum parameter
numUpd = pstmt.executeUpdate(); // Perform the update 3
pstmt.close(); // Close the PreparedStatement object
```

The following code uses named parameter markers to update values in a PL/SQL block. The numbers to the right of selected statements correspond to the previously described steps.

```
Connection con;
PreparedStatement pstmt;
int numUpd;
...
String sql =
    "BEGIN " +
    " UPDATE EMPLOYEE SET PHONENO = :phonenum WHERE EMPNO = :empnum; " +
    "END;";
pstmt = con.prepareStatement(sql); // Create a PreparedStatement object 1
((com.ibm.db2.jcc.DB2PreparedStatement)pstmt).setJccStringAtName
("phonenum", "4567");
// Assign a value to phonenum parameter 2
((com.ibm.db2.jcc.DB2PreparedStatement)pstmt).setJccStringAtName
("empnum", "000010");
// Assign a value to empnum parameter
numUpd = pstmt.executeUpdate(); // Perform the update 3
pstmt.close(); // Close the PreparedStatement object
```

## Using named parameter markers with CallableStatement objects

You can use named parameter markers instead of standard parameter markers in CallableStatement objects to assign values to IN or INOUT parameters and to register OUT parameters.

### Before you begin

To ensure that applications with named parameters work correctly, regardless of the data server type and version, before you use named parameter markers in your applications, set the Connection or DataSource property `enableNamedParameterMarkers` to `DB2BaseDataSource.YES`.

### About this task

To use named parameter markers with CallableStatement objects, follow these steps.

## Procedure

1. Execute the `Connection.prepareCall` method on an SQL statement string that contains named parameter markers.

The named parameter markers must follow the rules for SQL host variable names.

You cannot mix named parameter markers and standard parameter markers in the same SQL statement string.

Named parameter markers are case-insensitive.

2. If you do not know the names of the named parameter markers in the CALL statement, or the mode of the parameters (IN, OUT, or INOUT):

- a. Call the `CallableStatement.getParameterMetaData` method to obtain a `ParameterMetaData` object with information about the parameters.
- b. Call the `ParameterMetaData.getParameterMode` method to retrieve the parameter mode.
- c. Cast the `ParameterMetaData` object to a `DB2ParameterMetaData` object.
- d. Call the `DB2ParameterMetaData.getParameterMarkerNames` method to retrieve the parameter names.

3. For each named parameter marker that represents an OUT parameter, use a `DB2CallableStatement.registerJccOutParameterAtName` method to register the OUT parameter with a data type.

If you use the same named parameter marker more than once in the same SQL statement string, you need to call a `registerJccOutParameterAtName` method for that parameter marker only once. All parameters with the same name are registered as the same data type.

**Restriction:** You cannot use standard JDBC

`CallableStatement.registerOutParameter` methods with named parameter markers. Doing so causes an exception to be thrown.

4. For each named parameter marker for an input parameter, use a `DB2CallableStatement.setJccXXXAtName` method to assign a value to each named input parameter.

`setJccXXXAtName` methods are inherited from `DB2PreparedStatement`.

If you use the same named parameter marker more than once in the same SQL statement string, you need to call a `setJccXXXAtName` method for that parameter marker only once.

**Recommendation:** Do not use the same named parameter marker more than once in the same SQL statement string if the input to that parameter marker is a stream. Doing so can cause unexpected results.

5. Execute the `CallableStatement`.
6. Call `CallableStatement.getXXX` methods or `DB2CallableStatement.getJccXXXAtName` methods to retrieve output parameter values.

## Example

The following code illustrates calling a stored procedure that has one input VARCHAR parameter and one output INTEGER parameter, which are represented by named parameter markers. The numbers to the right of selected statements correspond to the previously described steps.

```

...
CallableStatement cstmt =
    con.prepareCall("CALL MYSP(:inparm,:outparm)");
                                // Create a CallableStatement object 1
((com.ibm.db2.jcc.DB2CallableStatement)cstmt).
    registerJccOutParameterAtName("outparm", java.sql.Types.INTEGER);
                                // Register OUT parameter data type 3
((com.ibm.db2.jcc.DB2CallableStatement)cstmt).setJccStringAtName("inparm", "4567");
                                // Assign a value to inparm parameter 4

cstmt.executeUpdate();          // Call the stored procedure 5
int outssid = cstmt.getInt(2);  // Get the output parameter value 6
cstmt.close();

```

The following code illustrates the use of named parameter markers in a PL/SQL block. The numbers to the right of selected statements correspond to the previously described steps.

```

...
// Read in a PL/SQL block, and assign it to String variable plsql
CallableStatement cstmt = con.prepareCall(plsql);
                                // Create a CallableStatement object 1

DB2ParameterMetaData pm =
    (DB2ParameterMetaData)cs.getParameterMetaData();
                                // Get ParameterMetaData, cast it to 2a,2b
                                // DB2ParameterMetaData

String[] markers = pm.getParameterMarkerNames();
                                // Get parameter marker names 2c

// Process ParameterMetaData. Assume that the first parameter marker
// is the only OUT parameter, and it has an INTEGER data type.
...
String parameterName = markers[0]; // Get OUT parameter name
((com.ibm.db2.jcc.DB2CallableStatement)cstmt).
    registerJccOutParameterAtName(parameterName, java.sql.Types.INTEGER);
                                // Register OUT parameter data type 3
// Assign a values to input parameters 4

...
cstmt.executeUpdate();          // Call the stored procedure 5
int outval = cs.getJccIntAtName(parameterName);
// Get the output parameter value using the parameter name 6
cstmt.close();

```

## Providing extended client information to the data source with IBM Data Server Driver for JDBC and SQLJ-only methods

A set of IBM Data Server Driver for JDBC and SQLJ-only methods provide extra information about the client to the server. This information can be used for accounting, workload management, or debugging.

### About this task

Extended client information is sent to the database server when the application performs an action that accesses the server, such as executing SQL.

In the IBM Data Server Driver for JDBC and SQLJ version 4.0 or later, the IBM Data Server Driver for JDBC and SQLJ-only methods are deprecated. You should use `java.sql.Connection.setClientInfo` instead.

The IBM Data Server Driver for JDBC and SQLJ-only methods are listed in the following table.

Table 15. Methods that provide client information to theDB2 server

Method	Information provided
setDB2ClientAccountingInformation	Accounting information
setDB2ClientApplicationInformation	Name of the application that is working with a connection
setDB2ClientDebugInfo	The CLIENT DEBUGINFO connection attribute for the Unified debugger
setDB2ClientProgramId	A caller-specified string that helps the caller identify which program is associated with a particular SQL statement. setDB2ClientProgramId does not apply to DB2 Database for Linux, UNIX, and Windows data servers.
setDB2ClientUser	User name for a connection
setDB2ClientWorkstation	Client workstation name for a connection

To set the extended client information, follow these steps:

### Procedure

1. Create a Connection.
2. Cast the `java.sql.Connection` object to a `com.ibm.db2.jcc.DB2Connection`.
3. Call any of the methods shown in Table 15.
4. Execute an SQL statement to cause the information to be sent to theDB2 server.

### Example

The following code performs the previous steps to pass a user name and a workstation name to theDB2 server. The numbers to the right of selected statements correspond to the previously-described steps.

```
public class ClientInfoTest {
    public static void main(String[] args) {
        String url = "jdbc:db2://sysmvs1.stl.ibm.com:5021/san_jose";
        try {
            Class.forName("com.ibm.db2.jcc.DB2Driver");
            String user = "db2adm";
            String password = "db2adm";
            Connection conn = DriverManager.getConnection(url,          1
                user, password);
            if (conn instanceof DB2Connection) {
                DB2Connection db2conn = (DB2Connection) conn;          2
                db2conn.setDB2ClientUser("Michael L Thompson");          3
                db2conn.setDB2ClientWorkstation("sjwkstn1");
                // Execute SQL to force extended client information to be sent
                // to the server
                conn.prepareStatement("SELECT * FROM SYSIBM.SYSDUMMY1"
                    + "WHERE 0 = 1").executeQuery();          4
            }
        } catch (Throwable e) {
            e.printStackTrace();
        }
    }
}
```

Figure 18. Example of passing extended client information to aDB2 server

## Providing extended client information to the data source with client info properties

The IBM Data Server Driver for JDBC and SQLJ version 4.0 supports JDBC 4.0 client info properties, which you can use to provide extra information about the client to the server. This information can be used for accounting, workload management, or debugging.

### About this task

Extended client information is sent to the database server when the application performs an action that accesses the server, such as executing SQL.

The application can also use the `Connection.getClientInfo` method to retrieve client information from the database server, or execute the `DatabaseMetaData.getClientInfoProperties` method to determine which client information the driver supports.

The JDBC 4.0 client info properties should be used instead IBM Data Server Driver for JDBC and SQLJ-only methods, which are deprecated.

To set client info properties, follow these steps:

### Procedure

1. Create a `Connection`.
2. Call the `java.sql.Connection.setClientInfo` method to set any of the client info properties that the database server supports.
3. Execute an SQL statement to cause the information to be sent to the database server.

### Example

The following code performs the previous steps to pass a client's user name and host name to the DB2 server. The numbers to the right of selected statements correspond to the previously-described steps.

```
public class ClientInfoTest {
    public static void main(String[] args) {
        String url = "jdbc:db2://sysmvs1.st1.ibm.com:5021/san_jose";
        try {
            Class.forName("com.ibm.db2.jcc.DB2Driver");
            String user = "db2adm";
            String password = "db2adm";
            Connection conn = DriverManager.getConnection(url,      1
                user, password);
            conn.setClientInfo("ClientUser", "Michael L Thompson"); 2
            conn.setClientInfo("ClientHostname", "sjwkstn1");
            // Execute SQL to force extended client information to be sent
            // to the server
            conn.prepareStatement("SELECT * FROM SYSIBM.SYSDUMMY1"
                + "WHERE 0 = 1").executeQuery(); 3
        } catch (Throwable e) {
            e.printStackTrace();
        }
    }
}
```

Figure 19. Example of passing extended client information to a DB2 server



## Client info properties support by the IBM Data Server Driver for JDBC and SQLJ

JDBC 4.0 includes client info properties, which contain information about a connection to a data source. The `DatabaseMetaData.getClientInfoProperties` method returns a list of client info properties that the IBM Data Server Driver for JDBC and SQLJ supports.

When you call `DatabaseMetaData.getClientInfoProperties`, a result set is returned that contains the following columns:

- NAME
- MAX\_LEN
- DEFAULT\_VALUE
- DESCRIPTION

The following table lists the client info property values that the IBM Data Server Driver for JDBC and SQLJ returns for DB2 Database for Linux, UNIX, and Windows and for DB2 for i.

*Table 16. Client info property values for DB2 Database for Linux, UNIX, and Windows and for DB2 for i*

NAME	MAX_LEN (bytes)	DEFAULT_VALUE	DESCRIPTION
ApplicationName	255	Empty string	The name of the application that is currently using the connection. This value is stored in DB2 special register CURRENT CLIENT_APPLNAME.
ClientAccountingInformation	255	Empty string	The value of the accounting string from the client information that is specified for the connection. This value is stored in DB2 special register CURRENT CLIENT_ACCTNG.
ClientHostname	255	The value that is set by <code>DB2Connection.setDB2ClientWorkstation</code> . If the value is not set, the default is the host name of the local host.	The host name of the computer on which the application that is using the connection is running. This value is stored in DB2 special register CURRENT CLIENT_WRKSTNNAME.
ClientUser	255	Empty string	The name of the user on whose behalf the application that is using the connection is running. This value is stored in DB2 special register CURRENT CLIENT_USERID.

The following table lists the client info property values that the IBM Data Server Driver for JDBC and SQLJ returns for DB2 for z/OS when the connection uses type 4 connectivity.

*Table 17. Client info property values for type 4 connectivity to DB2 for z/OS*

NAME	MAX_LEN (bytes)	DEFAULT_VALUE	DESCRIPTION
ApplicationName	32	clientProgramName property value, if set. "db2jcc_application" otherwise.	The name of the application that is currently using the connection. This value is stored in DB2 special register CURRENT CLIENT_APPLNAME.

Table 17. Client info property values for type 4 connectivity to DB2 for z/OS (continued)

NAME	MAX_LEN (bytes)	DEFAULT_VALUE	DESCRIPTION
ClientAccountingInformation	200	A string that is the concatenation of the following values: <ul style="list-style-type: none"> <li>• "JCCnnnnn", where nnnnn is the driver level, such as 04000.</li> <li>• The value that is set by DB2Connection.setDB2ClientWorkstation. If the value is not set, the default is the host name of the local host.</li> <li>• applicationName property value, if set. 20 blanks otherwise.</li> <li>• clientUser property value, if set. Eight blanks otherwise.</li> </ul>	The value of the accounting string from the client information that is specified for the connection. This value is stored in DB2 special register CURRENT CLIENT_ACCTNG.
ClientHostname	18	The value that is set by DB2Connection.setDB2ClientWorkstation. If the value is not set, the default is the host name of the local host.	The host name of the computer on which the application that is using the connection is running. This value is stored in DB2 special register CURRENT CLIENT_WRKSTNNAME.
ClientUser	16	The value that is set by DB2Connection.setDB2ClientUser. If the value is not set, the default is the current user ID that is used to connect to the database.	The name of the user on whose behalf the application that is using the connection is running. This value is stored in DB2 special register CURRENT CLIENT_USERID.

The following table lists the client info property values that the IBM Data Server Driver for JDBC and SQLJ returns for DB2 for z/OS when the connection uses type 2 connectivity.

Table 18. Client info property values for type 2 connectivity on DB2 for z/OS

NAME	MAX_LEN (bytes)	DEFAULT_VALUE	DESCRIPTION
ApplicationName	32	Empty string	The name of the application that is currently using the connection. This value is stored in DB2 special register CURRENT CLIENT_APPLNAME.
ClientAccountingInformation	200	Empty string	The value of the accounting string from the client information that is specified for the connection. This value is stored in DB2 special register CURRENT CLIENT_ACCTNG.
ClientHostname	18	Empty string	The host name of the computer on which the application that is using the connection is running. This value is stored in DB2 special register CURRENT CLIENT_WRKSTNNAME.
ClientUser	16	Empty string	The name of the user on whose behalf the application that is using the connection is running. This value is stored in DB2 special register CURRENT CLIENT_USERID.

The following table lists the client info property values that the IBM Data Server Driver for JDBC and SQLJ returns for IBM Informix

Table 19. Client info property values for IBM Informix

NAME	MAX_LEN (bytes)	DEFAULT_VALUE	DESCRIPTION
ApplicationName	20	Empty string	The name of the application that is currently using the connection.
ClientAccountingInformation	199	Empty string	The value of the accounting string from the client information that is specified for the connection.
ClientHostname	20	The value that is set by <code>DB2Connection.setDB2ClientWorkstation</code> . If the value is not set, the default is the host name of the local host.	The host name of the computer on which the application that is using the connection is running.
ClientUser	1024	Empty string	The name of the user on whose behalf the application that is using the connection is running.

## Extended parameter information with the IBM Data Server Driver for JDBC and SQLJ

IBM Data Server Driver for JDBC and SQLJ-only methods and constants let you assign the default value or no value to table columns or `ResultSet` columns.

The data server must support extended indicators before you can use the methods that provide extended indicator information in your Java applications. If you call one of those methods against a data server that does not support extended indicators, an exception is thrown. Extended parameter information is supported by DB2 for z/OS Version 10 or later, or DB2 Database for Linux, UNIX, and Windows Version 9.7 or later.

The methods that provide extended parameter information are listed in the following table.

Extended parameter information methods	Purpose
<code>DB2PreparedStatement.setDBDefault</code> , <code>DB2PreparedStatement.setJccDBDefaultAtName</code>	Sets an input parameter to its default value.
<code>DB2PreparedStatement.setDBUnassigned</code> , <code>DB2PreparedStatement.setJccDBUnassignedAtName</code>	Indicates that an input parameter is unassigned. This action yields the same behavior that would occur if the input parameter did not appear in the SQL statement text.
<code>DB2ResultSet.updateDBDefault</code>	Sets a column value in the current <code>ResultSet</code> row to its default value.

These methods are applicable only for parameter markers that appear in one of the following places:

- The SET list of an UPDATE statement
- The SET list of a MERGE statement
- The VALUES list of an INSERT statement
- The VALUES list of a MERGE statement
- The source table in a MERGE statement
- The SELECT list of an INSERT from SELECT statement

An SQLException is raised if you use these methods in any other context.

Alternatively, you can use the standard PreparedStatement.setObject or ResultSet.updateObject methods with IBM Data Server Driver for JDBC and SQLJ-only constants DB2PreparedStatement.DB\_PARAMETER\_DEFAULT or DB2PreparedStatement.DB\_PARAMETER\_UNASSIGNED to assign the default value or no value to parameters.

Extended parameter information can simplify application programs that have several input variables, each of which can send a value or the default value to the data server, or does not need to appear in the SQL statement. Instead of preparing separate statement strings for all combinations of variable values, you can prepare a single statement string. The resulting PreparedStatement object can be used in a homogeneous batch, whereas multiple different PreparedStatement objects cannot be used in a homogeneous batch.

## Using DB2PreparedStatement methods or constants to provide extended parameter information

Use DB2PreparedStatement methods or PreparedStatement methods with DB2PreparedStatement constants to assign default values to target columns or to assign no values to target columns.

### About this task

Follow these steps to send extended client information for a PreparedStatement to the data server.

### Procedure

1. Create a PreparedStatement object.  
The SQL statement is a INSERT, UPDATE, or MERGE statement.
2. If you are not using setObject to assign the values, cast the PreparedStatement object to a com.ibm.db2.jcc.DB2PreparedStatement object.
3. Call one of the following methods:
  - If you are not using setObject to assign the value:
    - To assign the default value of the target column to the input parameter, call DB2PreparedStatement.setDBDefault or DB2PreparedStatement.setJccDBDefaultAtName.
    - To mark the input parameter as unassigned, call DB2PreparedStatement.setDBUnassigned or DB2PreparedStatement.setJccDBUnassignedAtName.
  - If you are using setObject to assign the value:
    - To assign the default value of the target column to the input parameter, call PreparedStatement.setObject with DB2PreparedStatement.DB\_PARAMETER\_DEFAULT as the assigned value.
    - To mark the input parameter as unassigned, call PreparedStatement.setObject with DB2PreparedStatement.DB\_PARAMETER\_UNASSIGNED as the assigned value.
4. Execute the SQL statement.

## Example

The following code assigns the default values of the target columns to the third and fifth parameters in an INSERT statement. The numbers to the right of selected statements correspond to the previously described steps.

```
import java.sql.*;
import com.ibm.db2.jcc.*;

Connection conn;
...
PreparedStatement p = conn.prepareStatement(
    "INSERT INTO DEPARTMENT " +
    "(DEPTNO, DEPTNAME, MGRNO, ADMRDEPT, LOCATION) " +
    "VALUES (?, ?, ?, ?, ?)");
p.setString(1, "X00");
p.setString(2, "FACILITIES");
p.setString(4, "A00");
((com.ibm.db2.jcc.DB2PreparedStatement)p).setDBDefault(3);
((com.ibm.db2.jcc.DB2PreparedStatement)p).setDBDefault(5);
int uCount = p.executeUpdate();
...
p.close(); // Close PreparedStatement
```

The following code uses the PreparedStatement.setObject method and DB2PreparedStatement constants to perform the same function as in the previous example. The numbers to the right of selected statements correspond to the previously described steps.

```
import java.sql.*;
import com.ibm.db2.jcc.*;

Connection conn;
...
PreparedStatement p = conn.prepareStatement(
    "INSERT INTO DEPARTMENT " +
    "(DEPTNO, DEPTNAME, MGRNO, ADMRDEPT, LOCATION) " +
    "VALUES (?, ?, ?, ?, ?)");
p.setString(1, "X00");
p.setString(2, "FACILITIES");
p.setString(4, "A00");
p.setObject(3, DB2PreparedStatement.DB_PARAMETER_DEFAULT);
p.setObject(5, DB2PreparedStatement.DB_PARAMETER_DEFAULT);
int uCount = p.executeUpdate();
...
p.close(); // Close PreparedStatement
```

In these examples, use of the method DB2PreparedStatement.setDBDefault or the constant DB2PreparedStatement.DB\_PARAMETER\_DEFAULT simplifies programming of the INSERT operation. If DB2PreparedStatement.setDBDefault or DB2PreparedStatement.DB\_PARAMETER\_DEFAULT is not used, up to 32 different PreparedStatement objects are necessary to cover all combinations of default and non-default input values.

## Using DB2ResultSet methods or DB2PreparedStatement constants to provide extended parameter information

Use DB2ResultSet methods or ResultSet methods with DB2PreparedStatement constants to assign default values to target columns in a DB2ResultSet.

## About this task

Follow these steps to update a `ResultSet` with extended client information.

### Procedure

1. Create a `PreparedStatement` object.  
The SQL statement is a `SELECT` statement.
2. Invoke `PreparedStatement.setXXX` methods to pass values to any input parameters.
3. Invoke the `PreparedStatement.executeQuery` method to obtain the result table from the `SELECT` statement in a `ResultSet` object.
4. Position the cursor to the row that you want to update or insert.
5. Update columns in the `ResultSet` row.
  - If you are not using `updateObject` to update a value:
    - To assign the default value to the target column of the `ResultSet`, cast the `ResultSet` to a `DB2ResultSet`, and call `DB2ResultSet.updateDBDefault`.
  - If you are using `updateObject` to assign the value:
    - To assign the default value to the target column of the `ResultSet`, call `ResultSet.updateObject` with `DB2PreparedStatement.DB_PARAMETER_DEFAULT` as the assigned value.
6. Execute `ResultSet.updateRow` if you are updating an existing row, or `ResultSet.insertRow` if you are inserting a new row.

### Example

The following code inserts a row into a `ResultSet` with the default value in the second column, and does not modify the value in the first column. The numbers to the right of selected statements correspond to the previously described steps.

```
import java.sql.*;
import com.ibm.db2.jcc.*;

Connection conn;
...
PreparedStatement p = conn.prepareStatement (           1
    "SELECT MGRNO, LOCATION " +
    "FROM DEPARTMENT");
ResultSet rs = p.executeQuery ();                    3
rs.next ();
rs.moveToInsertRow();                               4
((DB2ResultSet)rs).updateDBDefault (2);             5
rs.insertRow();                                     6
...
rs.close();                                         // Close ResultSet
p.close();                                         // Close PreparedStatement
```

The following code uses the `ResultSet` interface with `DB2PreparedStatement` constants to perform the same function as in the previous example. The numbers to the right of selected statements correspond to the previously described steps.

```
import java.sql.*;
import com.ibm.db2.jcc.*;

Connection conn;
...
PreparedStatement p = conn.prepareStatement (           1
    "SELECT MGRNO, LOCATION " +
    "FROM DEPARTMENT");
```

```

ResultSet rs = p.executeQuery ();
rs.next ();
rs.moveToInsertRow();
rs.updateObject (2,
    DB2PreparedStatement.DB_PARAMETER_DEFAULT);
rs.insertRow();
...
rs.close();
p.close();

```

3  
4  
5  
6

// Close ResultSet  
// Close PreparedStatement

---

## Optimistic locking in JDBC applications

You can write JDBC applications to take advantage of optimistic locking on a data source.

*Optimistic locking* is a technique that applications can use to release locks between SELECT and UPDATE or DELETE operations. If the selected rows change before that application updates or deletes them, the UPDATE or DELETE operation fails. Optimistic locking minimizes the time during which a given resource is unavailable for use by other transactions.

For connections to a DB2 for i data source, use of optimistic locking requires DB2 for i V6R1 or later.

In general, an application performs these steps to use optimistic locking:

1. Select rows from a table.
2. Release locks on the table.
3. Update the selected rows, if they have not changed.

To check whether the row has changed, the application queries the row change token. The row change token is not always a completely accurate indicator of whether the row has changed. If you create a table with a row change timestamp column, the row change token is completely accurate. If you create the table without a row change timestamp column, or alter a table to add a row change timestamp column, the row change token might not accurately reflect updates to a row. This means that the row change token might indicate that a row has changed, even though it has not. This condition is called a *false negative* condition.

When you write a JDBC application to perform optimistic locking you follow similar steps:

1. Prepare and execute a query.
  - Indicate whether you want optimistic locking information, and whether that information can include false negatives.
2. Determine whether the ResultSet has optimistic locking information, and whether that information can produce false negatives.
  - Based on the type of optimistic locking information, you can decide whether to continue with optimistic locking.
3. Release locks on the table.
4. Update the selected rows, if the row change token indicates that they have not changed.

The following code demonstrates how a JDBC application can perform optimistic locking. The numbers in the example correspond to the previously listed steps.

```

com.ibm.db2.jcc.DB2Statement s1 =
    (com.ibm.db2.jcc.DB2Statement)conn.createStatement();
ResultSet rs =

```

```

((com.ibm.db2.jcc.DB2Statement)s1).executeDB2OptimisticLockingQuery
("SELECT EMPNO, SALARY FROM EMP WHERE EMP.LASTNAME = 'HAAS'",
com.ibm.db2.jcc.DB2Statement.RETURN_OPTLOCK_COLUMN_NO_FALSE_NEGATIVES); 1
    // Indicate that you plan to do
    // optimistic locking, and that you
    // want optimistic locking information
    // that does not generate
    // false negatives
ResultSetMetaData rsm = rs.getMetaData();
int optColumns = 2
    ((com.ibm.db2.jcc.DB2ResultSetMetaData)rsm).getDB2OptimisticLockingColumns();
    // Retrieve the optimistic locking
    // information.
boolean optColumnsReturned = false;

if (optColumns == 0);           // If optimistic locking information is not
    // returned, do not attempt to do
    // optimistic locking.
else if (optColumns == 1);     // A value of 1 is never returned if
    // RETURN_OPTLOCK_COLUMN_NO_FALSE_NEGATIVES
    // is specified, because 1 indicates
    // that there could be false negatives.
else if (optColumns == 2)     // If optimistic locking information is
    optColumnsReturned = true; // returned, and false negatives will not
    // occur, try optimistic locking.

rs.next();                     // Retrieve the contents of the ResultSet
int emp_id = rs.getInt(1);
double salary = rs.getDouble(2);

long rowChangeToken = 0;
Object rid = null;
int type = -1;

if (optColumnsReturned) {
    rowChangeToken =           // Get the row change token.
        ((com.ibm.db2.jcc.DB2ResultSet)rs).getDB2RowChangeToken();
    rid = ((com.ibm.db2.jcc.DB2ResultSet)rs).getDB2RID();
        // Get the RID, which uniquely identifies
        // the row.
    int type = ((com.ibm.db2.jcc.DB2ResultSet)rs).getDB2RIDType ();
        // Get the data type of the RID.
}
// *****
// Release the locks or disconnect from the database.
// Perform some work on the retrieved data.
// Reconnect to the data source.
// *****
...
PreparedStatement s2 =
conn.prepareStatement ("UPDATE EMP SET SALARY = ? " +
    "WHERE EMPNO = ? AND ROW CHANGE TOKEN FOR EMP = ? and " +
    "RID_BIT(EMP) = ?");
    // Statement for updating the
    // previously selected rows that
    // have not changed.
s2.setDouble(1, salary+10000);
s2.setInt(2, emp_id);
    // Set the new row values.
s2.setLong(3, rowChangeToken);
    // Set the row change token of the
    // previously retrieved row.
if (type == java.sql.Types.BIGINT)
    s2.setLong (4, ((Long)rid).longValue());
else if (type == java.sql.Types.VARBINARY)
    s2.setBytes (4, (byte[])rid);
    // Set the RID of the previously
    // retrieved row.
    // Use the correct setXXX method
    // for the data type of the RID.
int updateCount = s2.executeUpdate(); 3
    // Perform the update.
if (updateCount == 1);
else
    // Update is successful.
    // Update failed.
...

```



---

## Compound SQL in Java applications

SQLJ statement clauses in SQLJ applications or SQL statements in JDBC applications can include compound statements.

A compound statement is a BEGIN-END block that includes SQL and procedural statements. All compound statements in JDBC and SQLJ applications are executed dynamically.

The data server must be DB2 Database for Linux, UNIX, and Windows Version 9.7 or later.

The IBM Data Server Driver for JDBC and SQLJ passes the compound SQL to the data server without modification.

If your compound SQL contains parameter markers, you need to set the Connection or DataSource property enableNamedParameterMarkers to DB2BaseDataSource.YES (1).

In addition, at the data server, you need to set the DB2\_COMPATIBILITY\_VECTOR registry variable to enable PL/SQL compilation and execution.

The following example shows JDBC code that executes an inlined compound SQL statement. The compound SQL statement contains parameter markers, so you need to set enableNamedParameterMarkers to DB2BaseDataSource.YES (1).

```
...
Properties properties = new Properties(); // Create a Properties object
properties.put("user", "db2adm");      // Set user ID for the connection
properties.put("password", "db2adm");  // Set password for the connection
properties.put("enableNamedParameterMarkers",
    new String(" +
    com.ibm.db2.jcc.DB2BaseDataSource.YES + "));
String url = "jdbc:db2://luw1.myloc.ibm.com:9896/sample";
    // Set enableNamedParameterMarkers
    // Set URL for the data source
Connection conn1 = DriverManager.getConnection(url, properties);
    // Create the connection
...
    // Prepare and execute the compound
    // statement in the same way that
    // you prepare a single SQL statement
PreparedStatement ps = conn1.prepareStatement(
    "BEGIN atomic " +
    " for row as " +
    " select pk, c1, discretize (c1) as d from source " +
    " do " +
    " if row.d is null then " +
    " insert into except values (row.pk, ?); " +
    " else " +
    " insert into target values (row.pk, ?); " +
    " end if; " +
    " end for; " +
    "end");
ps.setInt(1, 98);
ps.setInt(2, 88);
ps.execute();
...
```

---

## XML data in JDBC applications

In JDBC applications, you can store data in XML columns and retrieve data from XML columns.

In database tables, the XML built-in data type is used to store XML data in a column as a structured set of nodes in a tree format.

JDBC applications can send XML data to the data server or retrieve XML data from the data server in one of the following forms:

- As textual XML data
- As binary XML data, if the data server supports it

In JDBC applications, you can:

- Store an entire XML document in an XML column using `setXXX` methods.
- Retrieve an entire XML document from an XML column using `getXXX` methods.
- Retrieve a sequence from a document in an XML column by using the SQL `XMLQUERY` function to retrieve the sequence into a serialized sequence in the database, and then using `getXXX` methods to retrieve the data into an application variable.
- Retrieve a sequence from a document in an XML column by using an `XQuery` expression, prepended with the string `'XQUERY'`, to retrieve the elements of the sequence into a result table in the database, in which each row of the result table represents an item in the sequence. Then use `getXXX` methods to retrieve the data into application variables.
- Retrieve a sequence from a document in an XML column as a user-defined table by using the SQL `XMLTABLE` function to define the result table and retrieve it. Then use `getXXX` methods to retrieve the data from the result table into application variables.

JDBC 4.0 `java.sql.SQLXML` objects can be used to retrieve and update data in XML columns. Invocations of metadata methods, such as `ResultSetMetaData.getColumnTypeName` return the integer value `java.sql.Types.SQLXML` for an XML column type.

## XML column updates in JDBC applications

In a JDBC application, you can update or insert data into XML columns of a table at a DB2 data server using XML textual data. You can update or insert data into XML columns of a table using binary XML data (data that is in the Extensible Dynamic Binary XML DB2 Client/Server Binary XML Format), if the data server supports binary XML data.

The following table lists the methods and corresponding input data types that you can use to put data in XML columns.

*Table 20. Methods and data types for updating XML columns*

Method	Input data type
<code>PreparedStatement.setAsciiStream</code>	<code>InputStream</code>
<code>PreparedStatement.setBinaryStream</code>	<code>InputStream</code>
<code>PreparedStatement.setBlob</code>	<code>Blob</code>
<code>PreparedStatement.setBytes</code>	<code>byte[]</code>
<code>PreparedStatement.setCharacterStream</code>	<code>Reader</code>

Table 20. Methods and data types for updating XML columns (continued)

Method	Input data type
PreparedStatement.setClob	Clob
PreparedStatement.setObject	byte[], Blob, Clob, SQLXML, DB2Xml (deprecated), InputStream, Reader, String
PreparedStatement.setSQLXML <sup>1</sup>	SQLXML
PreparedStatement.setString	String

**Note:**

1. This method requires JDBC 4.0 or later.

The encoding of XML data can be derived from the data itself, which is known as *internally encoded* data, or from external sources, which is known as *externally encoded* data. XML data that is sent to the database server as binary data is treated as internally encoded data. XML data that is sent to the data source as character data is treated as externally encoded data.

External encoding for Java applications is always Unicode encoding.

Externally encoded data can have internal encoding. That is, the data might be sent to the data source as character data, but the data contains encoding information. The data source handles incompatibilities between internal and external encoding as follows:

- If the data source is DB2 Database for Linux, UNIX, and Windows, the database source generates an error if the external and internal encoding are incompatible, unless the external and internal encoding are Unicode. If the external and internal encoding are Unicode, the database source ignores the internal encoding.
- If the database source is DB2 for z/OS, the database source ignores the internal encoding.

Data in XML columns is stored in UTF-8 encoding. The database source handles conversion of the data from its internal or external encoding to UTF-8.

**Example:** The following example demonstrates inserting data from an SQLXML object into an XML column. The data is String data, so the database source treats the data as externally encoded.

```
public void insertSQLXML()
{
    Connection con = DriverManager.getConnection(url);
    SQLXML info = con.createSQLXML();
    // Create an SQLXML object
    PreparedStatement insertStmt = null;
    String infoData =
        "<customerinfo xmlns=\"http://posample.org\" \" +
        \"Cid=\"1000\">...</customerinfo>";
    info.setString(infoData);
    // Populate the SQLXML object
    int cid = 1000;
    try {
        sqls = "INSERT INTO CUSTOMER (CID, INFO) VALUES (?, ?)";
        insertStmt = con.prepareStatement(sqls);
        insertStmt.setInt(1, cid);
        insertStmt.setSQLXML(2, info);
        // Assign the SQLXML object value
        // to an input parameter
    }
}
```

```

        if (insertStmt.executeUpdate() != 1) {
            System.out.println("insertSQLXML: No record inserted.");
        }
    }
    catch (IOException ioe) {
        ioe.printStackTrace();
    }
    catch (SQLException sqle) {
        System.out.println("insertSQLXML: SQL Exception: " +
            sqle.getMessage());
        System.out.println("insertSQLXML: SQL State: " +
            sqle.getSQLState());
        System.out.println("insertSQLXML: SQL Error Code: " +
            sqle.getErrorCode());
    }
}

```

**Example:** The following example demonstrates inserting data from a file into an XML column. The data is inserted as binary data, so the database server honors the internal encoding.

```

public void insertBinStream(Connection conn)
{
    PreparedStatement insertStmt = null;
    String sqls = null;
    int cid = 0;
    Statement stmt=null;
    try {
        sqls = "INSERT INTO CUSTOMER (CID, INFO) VALUES (?, ?)";
        insertStmt = conn.prepareStatement(sqls);
        insertStmt.setInt(1, cid);
        File file = new File(fn);
        insertStmt.setBinaryStream(2,
            new FileInputStream(file), (int)file.length());
        if (insertStmt.executeUpdate() != 1) {
            System.out.println("insertBinStream: No record inserted.");
        }
    }
    catch (IOException ioe) {
        ioe.printStackTrace();
    }
    catch (SQLException sqle) {
        System.out.println("insertBinStream: SQL Exception: " +
            sqle.getMessage());
        System.out.println("insertBinStream: SQL State: " +
            sqle.getSQLState());
        System.out.println("insertBinStream: SQL Error Code: " +
            sqle.getErrorCode());
    }
}

```

**Example:** The following example demonstrates inserting binary XML data from a file into an XML column.

```

...
SQLXML info = conn.createSQLXML();
OutputStream os = info.setBinaryStream ();
FileInputStream fis = new FileInputStream("c7.xml");
int read;
while ((read = fis.read ()) != -1) {
    os.write (read);
}

PreparedStatement insertStmt = null;
String sqls = null;

```

```

int cid = 1015;
sqls = "INSERT INTO MyCustomer (Cid, Info) VALUES (?, ?)";
insertStmt = conn.prepareStatement(sqls);
insertStmt.setInt(1, cid);
insertStmt.setSQLXML(2, info);
insertStmt.executeUpdate();

```

## XML data retrieval in JDBC applications

In JDBC applications, you use `ResultSet.getXXX` or `ResultSet.getObject` methods to retrieve data from XML columns.

In a JDBC application, you can retrieve data from XML columns in a DB2 table as XML textual data. You can retrieve data from XML columns in a table as binary XML data (data that is in the Extensible Dynamic Binary XML DB2 Client/Server Binary XML Format), if the data server supports binary XML data.

You can use one of the following techniques to retrieve XML data:

- Use the `ResultSet.getSQLXML` method to retrieve the data. Then use a `SQLXML.getXXX` method to retrieve the data into a compatible output data type. This technique requires JDBC 4.0 or later.  
For example, you can retrieve data by using the `SQLXML.getBinaryStream` method or the `SQLXML.getSource` method.
- Use a `ResultSet.getXXX` method other than `ResultSet.getObject` to retrieve the data into a compatible data type.
- Use the `ResultSet.getObject` method to retrieve the data, and then cast it to the `DB2Xml` type and assign it to a `DB2Xml` object. Then use a `DB2Xml.getDB2XXX` or `DB2Xml.getDB2XmlXXX` method to retrieve the data into a compatible output data type.

You need to use this technique if you are not using a version of the IBM Data Server Driver for JDBC and SQLJ that supports JDBC 4.0.

The following table lists the `ResultSet` methods and corresponding output data types for retrieving XML data.

Table 21. *ResultSet methods and data types for retrieving XML data*

Method	Output data type
<code>ResultSet.getAsciiStream</code>	<code>InputStream</code>
<code>ResultSet.getBinaryStream</code>	<code>InputStream</code>
<code>ResultSet.getBytes</code>	<code>byte[]</code>
<code>ResultSet.getCharacterStream</code>	<code>Reader</code>
<code>ResultSet.getObject</code>	<code>Object</code>
<code>ResultSet.getSQLXML</code>	<code>SQLXML</code>
<code>ResultSet.getString</code>	<code>String</code>

The following table lists the methods that you can call to retrieve data from a `java.sql.SQLXML` or a `com.ibm.db2.jcc.DB2Xml` object, and the corresponding output data types and type of encoding in the XML declarations.

Table 22. *SQLXML and DB2Xml methods, data types, and added encoding specifications*

Method	Output data type	Type of XML internal encoding declaration added
<code>SQLXML.getBinaryStream</code>	<code>InputStream</code>	None

Table 22. SQLXML and DB2Xml methods, data types, and added encoding specifications (continued)

Method	Output data type	Type of XML internal encoding declaration added
SQLXML.getCharacterStream	Reader	None
SQLXML.getSource	Source <sup>1</sup>	None
SQLXML.getString	String	None
DB2Xml.getDB2AsciiStream	InputStream	None
DB2Xml.getDB2BinaryStream	InputStream	None
DB2Xml.getDB2Bytes	byte[]	None
DB2Xml.getDB2CharacterStream	Reader	None
DB2Xml.getDB2String	String	None
DB2Xml.getDB2XmlAsciiStream	InputStream	US-ASCII
DB2Xml.getDB2XmlBinaryStream	InputStream	Specified by getDB2XmlBinaryStream <i>targetEncoding</i> parameter
DB2Xml.getDB2XmlBytes	byte[]	Specified by DB2Xml.getDB2XmlBytes <i>targetEncoding</i> parameter
DB2Xml.getDB2XmlCharacterStream	Reader	ISO-10646-UCS-2
DB2Xml.getDB2XmlString	String	ISO-10646-UCS-2

**Note:**

1. The class that is returned is specified by the invoker of getSource, but the class must extend javax.xml.transform.Source.

If the application executes the XMLSERIALIZE function on the data that is to be returned, after execution of the function, the data has the data type that is specified in the XMLSERIALIZE function, not the XML data type. Therefore, the driver handles the data as the specified type and ignores any internal encoding declarations.

**Example:** The following example demonstrates retrieving data from an XML column into an SQLXML object, and then using the SQLXML.getString method to retrieve the data into a string.

```
public void fetchToSQLXML(long cid, java.sql.Connection conn)
{
    System.out.println(">> fetchToSQLXML: Get XML data as an SQLXML object " +
        "using getSQLXML");
    PreparedStatement selectStmt = null;
    String sqls = null, stringDoc = null;
    ResultSet rs = null;

    try{
        sqls = "SELECT info FROM customer WHERE cid = " + cid;
        selectStmt = conn.prepareStatement(sqls);
        rs = selectStmt.executeQuery();

        // Get metadata
        // Column type for XML column is the integer java.sql.Types.OTHER
        ResultSetMetaData meta = rs.getMetaData();
        int colType = meta.getColumnType(1);
        System.out.println("fetchToSQLXML: Column type = " + colType);
        while (rs.next()) {
            // Retrieve the XML data with getSQLXML.
            // Then write it to a string with
            // explicit internal ISO-10646-UCS-2 encoding.
            java.sql.SQLXML xml = rs.getSQLXML(1);
            System.out.println (xml.getString());
        }
    }
}
```

```

    }
    rs.close();
}
catch (SQLException sqle) {
    System.out.println("fetchToSQLXML: SQL Exception: " +
        sqle.getMessage());
    System.out.println("fetchToSQLXML: SQL State: " +
        sqle.getSQLState());
    System.out.println("fetchToSQLXML: SQL Error Code: " +
        sqle.getErrorCode());
}
}

```

**Example:** The following example demonstrates retrieving data from an XML column into an SQLXML object, and then using the SQLXML.getBinaryStream method to retrieve the data as binary data into an InputStream.

```

String sql = "SELECT INFO FROM Customer WHERE Cid='1000'";
PreparedStatement pstmt = con.prepareStatement(sql);
ResultSet resultSet = pstmt.executeQuery();
// Get the result XML as a binary stream
SQLXML sqlxml = resultSet.getSQLXML(1);
InputStream binaryStream = sqlxml.getBinaryStream();

```

**Example:** The following example demonstrates retrieving data from an XML column into a String variable.

```

public void fetchToString(long cid, java.sql.Connection conn)
{
    System.out.println(">> fetchToString: Get XML data " +
        "using getString");
    PreparedStatement selectStmt = null;
    String sqls = null, stringDoc = null;
    ResultSet rs = null;

    try{
        sqls = "SELECT info FROM customer WHERE cid = " + cid;
        selectStmt = conn.prepareStatement(sqls);
        rs = selectStmt.executeQuery();

        // Get metadata
        // Column type for XML column is the integer java.sql.Types.OTHER
        ResultSetMetaData meta = rs.getMetaData();
        int colType = meta.getColumnType(1);
        System.out.println("fetchToString: Column type = " + colType);

        while (rs.next()) {
            stringDoc = rs.getString(1);
            System.out.println("Document contents:");
            System.out.println(stringDoc);
        }
    }
    catch (SQLException sqle) {
        System.out.println("fetchToString: SQL Exception: " +
            sqle.getMessage());
        System.out.println("fetchToString: SQL State: " +
            sqle.getSQLState());
        System.out.println("fetchToString: SQL Error Code: " +
            sqle.getErrorCode());
    }
}

```

**Example:** The following example demonstrates retrieving data from an XML column into a DB2Xml object, and then using the DB2Xml.getDB2XmlString method to retrieve the data into a string with an added XML declaration with an ISO-10646-UCS-2 encoding specification.

```

public void fetchToDB2Xml(long cid, java.sql.Connection conn)
{
    System.out.println(">> fetchToDB2Xml: Get XML data as a DB2XML object " +
        "using getObject");
    PreparedStatement selectStmt = null;
    String sqls = null, stringDoc = null;
    ResultSet rs = null;

    try{
        sqls = "SELECT info FROM customer WHERE cid = " + cid;
        selectStmt = conn.prepareStatement(sqls);
        rs = selectStmt.executeQuery();

        // Get metadata
        // Column type for XML column is the integer java.sql.Types.OTHER
        ResultSetMetaData meta = rs.getMetaData();
        int colType = meta.getColumnType(1);
        System.out.println("fetchToDB2Xml: Column type = " + colType);
        while (rs.next()) {
            // Retrieve the XML data with getObject, and cast the object
            // as a DB2Xml object. Then write it to a string with
            // explicit internal ISO-10646-UCS-2 encoding.
            com.ibm.db2.jcc.DB2Xml xml =
                (com.ibm.db2.jcc.DB2Xml) rs.getObject(1);
            System.out.println (xml.getDB2XmlString());
        }
        rs.close();
    }
    catch (SQLException sqle) {
        System.out.println("fetchToDB2Xml: SQL Exception: " +
            sqle.getMessage());
        System.out.println("fetchToDB2Xml: SQL State: " +
            sqle.getSQLState());
        System.out.println("fetchToDB2Xml: SQL Error Code: " +
            sqle.getErrorCode());
    }
}

```

## Invocation of routines with XML parameters in Java applications

Java applications can call stored procedures at DB2 Database for Linux, UNIX, and Windows or DB2 for z/OS data sources that have XML parameters.

For native SQL procedures, XML parameters in the stored procedure definition have the XML type. For external stored procedures and user-defined functions on DB2 Database for Linux, UNIX, and Windows data sources, XML parameters in the routine definition have the XML AS CLOB type. When you call a stored procedure or user-defined function that has XML parameters, you need to use a compatible data type in the invoking statement.

To call a routine with XML input parameters from a JDBC program, use parameters of the `java.sql.SQLXML` or `com.ibm.db2.jcc.DB2Xml` type. To register XML output parameters, register the parameters as the `java.sql.Types.SQLXML` or `com.ibm.db2.jcc.DB2Types.XML` type. (The `com.ibm.db2.jcc.DB2Xml` and `com.ibm.db2.jcc.DB2Types.XML` types are deprecated.)

**Example:** JDBC program that calls a stored procedure that takes three XML parameters: an IN parameter, an OUT parameter, and an INOUT parameter. This example requires JDBC 4.0 or later.



```

java.sql.SQLXML in_xml = xmlvar;
java.sql.SQLXML out_xml = null;
java.sql.SQLXML inout_xml = xmlvar;
                                // Declare an input, output, and
                                // INOUT XML parameter

Connection con;
CallableStatement cstmt;
ResultSet rs;
...
cstmt = con.prepareCall("CALL SP_xml(?,?,?)");
                                // Create a CallableStatement object
cstmt.setObject (1, in_xml);    // Set input parameter
cstmt.setObject (3, inout_xml); // Set inout parameter
cstmt.registerOutParameter (2, java.sql.Types.SQLXML);
                                // Register out and input parameters
cstmt.registerOutParameter (3, java.sql.Types.SQLXML);
cstmt.executeUpdate();         // Call the stored procedure
out_xml = cstmt.getSQLXML(2);  // Get the OUT parameter value
inout_xml = cstmt.getSQLXML(3); // Get the INOUT parameter value
System.out.println("Parameter values from SP_xml call: ");
System.out.println("Output parameter value ");
MyUtilities.printString(out_xml.getString());
                                // Use the SQLXML.getString
                                // method to convert the out_xml
                                // value to a string for printing.
                                // Call a user-defined method called
                                // printString (not shown) to print
                                // the value.
System.out.println("INOUT parameter value ");
MyUtilities.printString(inout_xml.getString());
                                // Use the SQLXML.getString
                                // method to convert the inout_xml
                                // value to a string for printing.
                                // Call a user-defined method called
                                // printString (not shown) to print
                                // the value.

```

To call a routine with XML parameters from an SQLJ program, use parameters of the `java.sql.SQLXML` or `com.ibm.db2.jcc.DB2Xml` type.

**Example:** SQLJ program that calls a stored procedure that takes three XML parameters: an IN parameter, an OUT parameter, and an INOUT parameter. This example requires JDBC 4.0 or later.

```

java.sql.SQLXML in_xml = xmlvar;
java.sql.SQLXML out_xml = null;
java.sql.SQLXML inout_xml = xmlvar;
                                // Declare an input, output, and
                                // INOUT XML parameter

...
#sql [myConnCtx] {CALL SP_xml(:IN in_xml,
                                :OUT out_xml,
                                :INOUT inout_xml)};
                                // Call the stored procedure
System.out.println("Parameter values from SP_xml call: ");
System.out.println("Output parameter value ");
MyUtilities.printString(out_xml.getString());
                                // Use the SQLXML.getString
                                // method to convert the out_xml value
                                // to a string for printing.
                                // Call a user-defined method called
                                // printString (not shown) to print
                                // the value.
System.out.println("INOUT parameter value ");
MyUtilities.printString(inout_xml.getString());
                                // Use the SQLXML.getString

```

```

// method to convert the inout_xml
// value to a string for printing.
// Call a user-defined method called
// printString (not shown) to print
// the value.

```

## Java support for XML schema registration and removal

The IBM Data Server Driver for JDBC and SQLJ provides methods that let you write Java application programs to register and remove XML schemas and their components.

The methods are:

### **DB2Connection.registerDB2XMLSchema**

Registers an XML schema in DB2, using one or more XML schema documents. There are two forms of this method: one form for XML schema documents that are input from `InputStream` objects, and one form for XML schema documents that are in a `String`.

### **DB2Connection.deregisterDB2XMLObject**

Removes an XML schema definition from DB2.

### **DB2Connection.updateDB2XmlSchema**

Replaces the XML schema documents in a registered XML schema with the XML schema documents from another registered XML schema. Optionally drops the XML schema whose contents are copied. This method is available only for connections to DB2 Database for Linux, UNIX, and Windows.

Before you can invoke these methods, the stored procedures that support these methods must be installed on the DB2 database server.

*Example: Registration of an XML schema:* The following example demonstrates the use of `registerDB2XmlSchema` to register an XML schema in DB2 using a single XML schema document (`customer.xsd`) that is read from an input stream. The SQL schema name for the registered schema is `SYSXSR`. No additional properties are registered.

```

public static void registerSchema(
    Connection con,
    String schemaName)
    throws SQLException {
    // Define the registerDB2XmlSchema parameters
    String[] xmlSchemaNameQualifiers = new String[1];
    String[] xmlSchemaNames = new String[1];
    String[] xmlSchemaLocations = new String[1];
    InputStream[] xmlSchemaDocuments = new InputStream[1];
    int[] xmlSchemaDocumentsLengths = new int[1];
    java.io.InputStream[] xmlSchemaDocumentsProperties = new InputStream[1];
    int[] xmlSchemaDocumentsPropertiesLengths = new int[1];
    InputStream xmlSchemaProperties;
    int xmlSchemaPropertiesLength;
    //Set the parameter values
    xmlSchemaLocations[0] = "";
    FileInputStream fi = null;
    xmlSchemaNameQualifiers[0] = "SYSXSR";
    xmlSchemaNames[0] = schemaName;
    try {
        fi = new FileInputStream("customer.xsd");
        xmlSchemaDocuments[0] = new BufferedInputStream(fi);
    } catch (FileNotFoundException e) {
        e.printStackTrace();
    }
    try {

```

```

        xmlSchemaDocumentsLengths[0] = (int) fi.getChannel().size();
        System.out.println(xmlSchemaDocumentsLengths[0]);
    } catch (IOException e1) {
        e1.printStackTrace();
    }
    xmlSchemaDocumentsProperties[0] = null;
    xmlSchemaDocumentsPropertiesLengths[0] = 0;
    xmlSchemaProperties = null;
    xmlSchemaPropertiesLength = 0;
    DB2Connection ds = (DB2Connection) con;
    // Invoke registerDB2XmlSchema
    ds.registerDB2XmlSchema(
        xmlSchemaNameQualifiers,
        xmlSchemaNames,
        xmlSchemaLocations,
        xmlSchemaDocuments,
        xmlSchemaDocumentsLengths,
        xmlSchemaDocumentsProperties,
        xmlSchemaDocumentsPropertiesLengths,
        xmlSchemaProperties,
        xmlSchemaPropertiesLength,
        false);
}

```

*Example: Removal of an XML schema:* The following example demonstrates the use of `deregisterDB2XmlObject` to remove an XML schema from DB2. The SQL schema name for the registered schema is `SYSXSR`.

```

public static void deregisterSchema(
    Connection con,
    String schemaName)
    throws SQLException {
    // Define and assign values to the deregisterDB2XmlObject parameters
    String xmlSchemaNameQualifier = "SYSXSR";
    String xmlSchemaName = schemaName;
    DB2Connection ds = (DB2Connection) con;
    // Invoke deregisterDB2XmlObject
    ds.deregisterDB2XmlObject(
        xmlSchemaNameQualifier,
        xmlSchemaName);
}

```

*Example: Update of an XML schema:* The following example applies only to connections to DB2 Database for Linux, UNIX, and Windows. It demonstrates the use of `updateDB2XmlSchema` to update the contents of an XML schema with the contents of another XML schema. The schema that is copied is kept in the repository. The SQL schema name for both registered schemas is `SYSXSR`.

```

public static void updateSchema(
    Connection con,
    String schemaNameTarget,
    String schemaNameSource)
    throws SQLException {
    // Define and assign values to the updateDB2XmlSchema parameters
    String xmlSchemaNameQualifierTarget = "SYSXSR";
    String xmlSchemaNameQualifierSource = "SYSXSR";
    String xmlSchemaNameTarget = schemaNameTarget;
    String xmlSchemaNameSource = schemaNameSource;
    boolean dropSourceSchema = false;
    DB2Connection ds = (DB2Connection) con;
    // Invoke updateDB2XmlSchema
    ds.updateDB2XmlSchema(
        xmlSchemaNameQualifierTarget,
        xmlSchemaNameTarget,

```

```

xmlSchemaNameQualifierSource,
xmlSchemaNameSource,
dropSourceSchema);
}

```

---

## Transaction control in JDBC applications

In JDBC applications, as in other types of SQL applications, transaction control involves explicitly or implicitly committing and rolling back transactions, and setting the isolation level for transactions.

### IBM Data Server Driver for JDBC and SQLJ isolation levels

The IBM Data Server Driver for JDBC and SQLJ supports a number of isolation levels, which correspond to database server isolation levels.

JDBC isolation levels can be set for a unit of work within a JDBC program, using the `Connection.setTransactionIsolation` method. The default isolation level can be set with the `defaultIsolationLevel` property.

The following table shows the values of *level* that you can specify in the `Connection.setTransactionIsolation` method and their DB2 database server equivalents.

*Table 23. Equivalent JDBC and DB2 isolation levels*

JDBC value	DB2 isolation level
<code>java.sql.Connection.TRANSACTION_SERIALIZABLE</code>	Repeatable read
<code>java.sql.Connection.TRANSACTION_REPEATABLE_READ</code>	Read stability
<code>java.sql.Connection.TRANSACTION_READ_COMMITTED</code>	Cursor stability
<code>java.sql.Connection.TRANSACTION_READ_UNCOMMITTED</code>	Uncommitted read

The following table shows the values of *level* that you can specify in the `Connection.setTransactionIsolation` method and their IBM Informix equivalents.

*Table 24. Equivalent JDBC and IBM Informix isolation levels*

JDBC value	IBM Informix isolation level
<code>java.sql.Connection.TRANSACTION_SERIALIZABLE</code>	Repeatable read
<code>java.sql.Connection.TRANSACTION_REPEATABLE_READ</code>	Repeatable read
<code>java.sql.Connection.TRANSACTION_READ_COMMITTED</code>	Committed read
<code>java.sql.Connection.TRANSACTION_READ_UNCOMMITTED</code>	Dirty read
<code>com.ibm.db2.jcc.DB2Connection.TRANSACTION_IDS_CURSOR_STABILITY</code>	IBM Informix cursor stability
<code>com.ibm.db2.jcc.DB2Connection.TRANSACTION_IDS_LAST_COMMITTED</code>	Committed read, last committed

## Committing or rolling back JDBC transactions

In JDBC, to commit or roll back transactions explicitly, use the commit or rollback methods.

### About this task

For example:

```

Connection con;
...
con.commit();

```

If autocommit mode is on, the database manager performs a commit operation after every SQL statement completes. To set autocommit mode on, invoke the `Connection.setAutoCommit(true)` method. To set autocommit mode off, invoke the `Connection.setAutoCommit(false)` method. To determine whether autocommit mode is on, invoke the `Connection.getAutoCommit` method.

Connections that participate in distributed transactions cannot invoke the `setAutoCommit(true)` method.

When you change the autocommit state, the database manager executes a commit operation, if the application is not already on a transaction boundary.

While a connection is participating in a distributed transaction, the associated application cannot issue the commit or rollback methods.

## Default JDBC autocommit modes

The default autocommit mode depends on the data source to which the JDBC application connects.

### Autocommit default for DB2 data sources

For connections to DB2 data sources, the default autocommit mode is `true`.

### Autocommit default for IBM Informix data sources

For connections to IBM Informix data sources, the default autocommit mode depends on the type of data source. The following table shows the defaults.

*Table 25. Default autocommit modes for IBM Informix data sources*

Type of data source	Default autocommit mode for local transactions	Default autocommit mode for global transactions
ANSI-compliant database	true	false
Non-ANSI-compliant database without logging	false	not applicable
Non-ANSI-compliant database with logging	true	false

## Exceptions and warnings under the IBM Data Server Driver for JDBC and SQLJ

In JDBC applications, SQL errors throw exceptions, which you handle using try/catch blocks. SQL warnings do not throw exceptions, so you need to invoke methods to check whether warnings occurred after you execute SQL statements.

The IBM Data Server Driver for JDBC and SQLJ provides the following classes and interfaces, which provide information about errors and warnings.

## SQLException

The SQLException class for handling errors. All JDBC methods throw an instance of SQLException when an error occurs during their execution. According to the JDBC specification, an SQLException object contains the following information:

- An int value that contains an error code. SQLException.getErrorCode retrieves this value.
- A String object that contains the SQLSTATE, or null. SQLException.getSQLState retrieves this value.
- A String object that contains a description of the error, or null. SQLException.getMessage retrieves this value.
- A pointer to the next SQLException, or null. SQLException.getNextException retrieves this value.

When a JDBC method throws a single SQLException, that SQLException might be caused by an underlying Java exception that occurred when the IBM Data Server Driver for JDBC and SQLJ processed the method. In this case, the SQLException wraps the underlying exception, and you can use the SQLException.getCause method to retrieve information about the error.

## DB2Diagnosable

The IBM Data Server Driver for JDBC and SQLJ-only interface com.ibm.db2.jcc.DB2Diagnosable extends the SQLException class. The DB2Diagnosable interface gives you more information about errors that occur when the data source is accessed. If the JDBC driver detects an error, DB2Diagnosable gives you the same information as the standard SQLException class. However, if the database server detects the error, DB2Diagnosable adds the following methods, which give you additional information about the error:

### getSqlca

Returns an DB2Sqlca object with the following information:

- An SQL error code
- The SQLERRMC values
- The SQLERRP value
- The SQLERRD values
- The SQLWARN values
- The SQLSTATE

### getThrowable

Returns a java.lang.Throwable object that caused the SQLException, or null, if no such object exists.

### printTrace

Prints diagnostic information.

## SQLException subclasses

If you are using JDBC 4.0 or later, you can obtain more specific information than an SQLException provides by catching the following exception classes:

- SQLNonTransientException  
An SQLNonTransientException is thrown when an SQL operation that failed previously cannot succeed when the operation is retried, unless some corrective action is taken. The SQLNonTransientException class has these subclasses:
  - SQLFeatureNotSupportedException
  - SQLNonTransientConnectionException

- SQLException
- SQLDataException
- SQLIntegrityConstraintViolationException
- SQLInvalidAuthorizationSpecException
- SQLSyntaxException
- SQLTransientException
 

An SQLTransientException is thrown when an SQL operation that failed previously might succeed when the operation is retried, without intervention from the application. A connection is still valid after an SQLTransientException is thrown. The SQLTransientException class has these subclasses:

  - SQLTransientConnectionException
  - SQLTransientRollbackException
  - SQLTimeoutException
- SQLRecoverableException
 

An SQLRecoverableException is thrown when an operation that failed previously might succeed if the application performs some recovery steps, and retries the transaction. A connection is no longer valid after an SQLRecoverableException is thrown.
- SQLClientInfoException
 

A SQLClientInfoException is thrown by the Connection.setClientInfo method when one or more client properties cannot be set. The SQLClientInfoException indicates which properties cannot be set.

## BatchUpdateException

A BatchUpdateException object contains the following items about an error that occurs during execution of a batch of SQL statements:

- A String object that contains a description of the error, or null.
- A String object that contains the SQLSTATE for the failing SQL statement, or null
- An integer value that contains the error code, or zero
- An integer array of update counts for SQL statements in the batch, or null
- A pointer to an SQLException object, or null

One BatchUpdateException is thrown for the entire batch. At least one SQLException object is chained to the BatchUpdateException object. The SQLException objects are chained in the same order as the corresponding statements were added to the batch. To help you match SQLException objects to statements in the batch, the error description field for each SQLException object begins with this string:

Error for batch element #*n*:

*n* is the number of the statement in the batch.

SQL warnings during batch execution do not throw BatchUpdateExceptions. To obtain information about warnings, use the Statement.getWarnings method on the object on which you ran the executeBatch method. You can then retrieve an error description, SQLSTATE, and error code for each SQLWarning object.

## SQLWarning

The IBM Data Server Driver for JDBC and SQLJ accumulates warnings when SQL statements return positive SQLCODEs, and when SQL statements return 0 SQLCODEs with non-zero SQLSTATES.



Calling `getWarnings` retrieves an `SQLWarning` object.

**Important:** When a call to `Statement.executeUpdate` or `PreparedStatement.executeUpdate` affects no rows, the IBM Data Server Driver for JDBC and SQLJ generates an `SQLWarning` with error code +100.

When a call to `ResultSet.next` returns no rows, the IBM Data Server Driver for JDBC and SQLJ does not generate an `SQLWarning`.

A generic `SQLWarning` object contains the following information:

- A `String` object that contains a description of the warning, or null
- A `String` object that contains the `SQLSTATE`, or null
- An `int` value that contains an error code
- A pointer to the next `SQLWarning`, or null

Under the IBM Data Server Driver for JDBC and SQLJ, like an `SQLException` object, an `SQLWarning` object can also contain DB2-specific information. The DB2-specific information for an `SQLWarning` object is the same as the DB2-specific information for an `SQLException` object.

## Handling an `SQLException` under the IBM Data Server Driver for JDBC and SQLJ

As in all Java programs, error handling for JDBC applications is done using `try/catch` blocks. Methods throw exceptions when an error occurs, and the code in the catch block handles those exceptions.

### About this task

The basic steps for handling an `SQLException` in a JDBC program that runs under the IBM Data Server Driver for JDBC and SQLJ are:

### Procedure

1. Give the program access to the `com.ibm.db2.jcc.DB2Diagnosable` interface and the `com.ibm.db2.jcc.DB2Sqlca` class. You can fully qualify all references to them, or you can import them:

```
import com.ibm.db2.jcc.DB2Diagnosable;
import com.ibm.db2.jcc.DB2Sqlca;
```

2. Optional: During a connection to a data server, set the `retrieveMessagesFromServerOnGetMessage` property to `true` if you want full message text from an `SQLException.getMessage` call.
3. Optional: During a IBM Data Server Driver for JDBC and SQLJ type 2 connectivity connection to a DB2 for z/OS data source, set the `extendedDiagnosticLevel` property to `EXTENDED_DIAG_MESSAGE_TEXT (241)` if you want extended diagnostic information similar to the information that is provided by the SQL `GET DIAGNOSTICS` statement from an `SQLException.getMessage` call.
4. Put code that can generate an `SQLException` in a `try` block.
5. In the catch block, perform the following steps in a loop:
  - a. Test whether you have retrieved the last `SQLException`. If not, continue to the next step.
  - b. Optional: For an SQL statement that executes on an IBM Informix data source, execute the



`com.ibm.db2.jcc.DB2Statement.getIDSQLStatementOffset` method to determine which columns have syntax errors.

`DB2Statement.getIDSQLStatementOffset` returns the offset into the SQL statement of the first syntax error.

- c. Optional: For an SQL statement that executes on an IBM Informix data source, execute the `SQLException.getCause` method to retrieve any ISAM error messages.
  - 1) If the `Throwable` that is returned by `SQLException.getCause` is not null, perform one of the following sets of steps:
    - Issue `SQLException.printStackTrace` to print an error message that includes the ISAM error message text. The ISAM error message text is preceded by the string "Caused by:".
    - Retrieve the error code and message text for the ISAM message:
      - a) Test whether the `Throwable` is an instance of an `SQLException`. If so, retrieve the SQL error code from that `SQLException`.
      - b) Execute the `Throwable.getMessage` method to retrieve the text of the ISAM message.
- d. Check whether any IBM Data Server Driver for JDBC and SQLJ-only information exists by testing whether the `SQLException` is an instance of `DB2Diagnosable`. If so:
  - 1) Cast the object to a `DB2Diagnosable` object.
  - 2) Optional: Invoke the `DB2Diagnosable.printStackTrace` method to write all `SQLException` information to a `java.io.PrintWriter` object.
  - 3) Invoke the `DB2Diagnosable.getThrowable` method to determine whether an underlying `java.lang.Throwable` caused the `SQLException`.
  - 4) Invoke the `DB2Diagnosable.getSqlca` method to retrieve the `DB2Sqlca` object.
  - 5) Invoke the `DB2Sqlca.getSqlCode` method to retrieve an SQL error code value.
  - 6) Invoke the `DB2Sqlca.getSqlErrmc` method to retrieve a string that contains all `SQLERRMC` values, or invoke the `DB2Sqlca.getSqlErrmcTokens` method to retrieve the `SQLERRMC` values in an array.
  - 7) Invoke the `DB2Sqlca.getSqlErrp` method to retrieve the `SQLERRP` value.
  - 8) Invoke the `DB2Sqlca.getSqlErrd` method to retrieve the `SQLERRD` values in an array.
  - 9) Invoke the `DB2Sqlca.getSqlWarn` method to retrieve the `SQLWARN` values in an array.
  - 10) Invoke the `DB2Sqlca.getSqlState` method to retrieve the `SQLSTATE` value.
  - 11) Invoke the `DB2Sqlca.getMessage` method to retrieve error message text from the data source.
- e. Invoke the `SQLException.getNextException` method to retrieve the next `SQLException`.

## Example

The following code demonstrates how to obtain IBM Data Server Driver for JDBC and SQLJ-specific information from an `SQLException` that is provided with the IBM Data Server Driver for JDBC and SQLJ. The numbers to the right of selected

statements correspond to the previously-described steps.

*Figure 20. Processing an SQLException under the IBM Data Server Driver for JDBC and SQLJ*

```

import java.sql.*;           // Import JDBC API package
import com.ibm.db2.jcc.DB2Diagnosable; // Import packages for DB2
import com.ibm.db2.jcc.DB2Sqlca; // SQLException support
java.io.PrintWriter printWriter; // For dumping all SQLException
                                // information
String url = "jdbc:db2://myhost:9999/myDB:" +
    "retrieveMessagesFromServerOnGetMessage=true;";
                                // Set properties to retrieve full message
                                // text

String user = "db2adm";
String password = "db2adm";
java.sql.Connection con =
    java.sql.DriverManager.getConnection (url, user, password)
                                // Connect to a DB2 for z/OS data source

...
try {
    // Code that could generate SQLExceptions
    ...
} catch(SQLException sqle) {
    while(sqle != null) {
        // Check whether there are more
        // SQLExceptions to process
        //====> Optional IBM Data Server Driver for JDBC and SQLJ-only
        // error processing
        if (sqle instanceof DB2Diagnosable) {
            // Check if IBM Data Server Driver for JDBC and SQLJ-only
            // information exists
            com.ibm.db2.jcc.DB2Diagnosable diagnosable =
                (com.ibm.db2.jcc.DB2Diagnosable)sqle;
            diagnosable.printStackTrace (printWriter, "");
            java.lang.Throwable throwable =
                diagnosable.getThrowable();
            if (throwable != null) {
                // Extract java.lang.Throwable information
                // such as message or stack trace.
                ...
            }
            DB2Sqlca sqlca = diagnosable.getSqlca();
            // Get DB2Sqlca object
            if (sqlca != null) {
                // Check that DB2Sqlca is not null
                int sqlCode = sqlca.getSqlCode(); // Get the SQL error code
                String sqlErrmc = sqlca.getSqlErrmc();
                // Get the entire SQLERRMC
                String[] sqlErrmcTokens = sqlca.getSqlErrmcTokens();
                // You can also retrieve the
                // individual SQLERRMC tokens
                String sqlErrp = sqlca.getSqlErrp();
                // Get the SQLERRP
                int[] sqlErrrd = sqlca.getSqlErrrd();
                // Get SQLERRD fields
                char[] sqlWarn = sqlca.getSqlWarn();
                // Get SQLWARN fields
                String sqlState = sqlca.getSqlState();
                // Get SQLSTATE
                String errMessage = sqlca.getMessage();
                // Get error message

                System.err.println ("Server error message: " + errMessage);

                System.err.println ("----- SQLCA -----");
            }
        }
    }
}

```



3. Perform the following steps in a loop:
  - a. Test whether the `SQLWarning` object is null. If not, continue to the next step.
  - b. Invoke the `SQLWarning.getMessage` method to retrieve the warning description.
  - c. Invoke the `SQLWarning.getSQLState` method to retrieve the `SQLSTATE` value.
  - d. Invoke the `SQLWarning.getErrorCode` method to retrieve the error code value.
  - e. If you want DB2-specific warning information, perform the same steps that you perform to get DB2-specific information for an `SQLException`.
  - f. Invoke the `SQLWarning.getNextWarning` method to retrieve the next `SQLWarning`.

## Example

The following code illustrates how to obtain generic `SQLWarning` information. The numbers to the right of selected statements correspond to the previously-described steps.

```
String url = "jdbc:db2://myhost:9999/myDB:" + 1
    "retrieveMessagesFromServerOnGetMessage=true;";
    // Set properties to retrieve full message
    // text

String user = "db2adm";
String password = "db2adm";
java.sql.Connection con =
    java.sql.DriverManager.getConnection (url, user, password)
    // Connect to a DB2 for z/OS data source

Statement stmt;
ResultSet rs;
SQLWarning sqlwarn;
...
stmt = con.createStatement(); // Create a Statement object
rs = stmt.executeQuery("SELECT * FROM EMPLOYEE");
    // Get the result table from the query

sqlwarn = stmt.getWarnings(); // Get any warnings generated 2
while (sqlwarn != null) { // While there are warnings, get and 3a
    // print warning information
    System.out.println ("Warning description: " + sqlwarn.getMessage()); 3b
    System.out.println ("SQLSTATE: " + sqlwarn.getSQLState()); 3c
    System.out.println ("Error code: " + sqlwarn.getErrorCode()); 3d
    sqlwarn=sqlwarn.getNextWarning(); // Get next SQLWarning 3f
}
}
```

Figure 21. Example of processing an `SQLWarning`

## Retrieving information from a `BatchUpdateException`

When an error occurs during execution of a statement in a batch, processing continues. However, `executeBatch` throws a `BatchUpdateException`.

### About this task

To retrieve information from the `BatchUpdateException`, follow these steps:

### Procedure

1. Use the `BatchUpdateException.getUpdateCounts` method to determine the number of rows that each SQL statement in the batch updated before the exception was thrown.

getUpdateCount returns an array with an element for each statement in the batch. An element has one of the following values:

*n* The number of rows that the statement updated.

#### **Statement.SUCCESS\_NO\_INFO**

This value is returned if the number of updated rows cannot be determined. The number of updated rows cannot be determined if the following conditions are true:

- The application is connected to a subsystem that is in DB2 for z/OS Version 8 new-function mode, or later.
- The application is using Version 3.1 or later of the IBM Data Server Driver for JDBC and SQLJ.
- The IBM Data Server Driver for JDBC and SQLJ uses multi-row INSERT operations to execute batch updates.

#### **Statement.EXECUTE\_FAILED**

This value is returned if the statement did not execute successfully.

2. If the batched statement can return automatically generated keys:
  - a. Cast the BatchUpdateException to a `com.ibm.db2.jcc.DBBatchUpdateException`.
  - b. Call the `DBBatchUpdateException.getDBGeneratedKeys` method to retrieve an array of `ResultSet` objects that contains the automatically generated keys for each execution of the batched SQL statement.
  - c. Test whether each `ResultSet` in the array is null.  
Each `ResultSet` contains:
    - If the `ResultSet` is not null, it contains the automatically generated keys for an execution of the batched SQL statement.
    - If the `ResultSet` is null, execution of the batched statement failed.
3. Use `SQLException` methods `getMessage`, `getSQLState`, and `getErrorCode` to retrieve the description of the error, the `SQLSTATE`, and the error code for the first error.
4. Use the `BatchUpdateException.getNextException` method to get a chained `SQLException`.
5. In a loop, execute the `getMessage`, `getSQLState`, `getErrorCode`, and `getNextException` method calls to obtain information about an `SQLException` and get the next `SQLException`.

## **Example**

The following code fragment demonstrates how to obtain the fields of a `BatchUpdateException` and the chained `SQLException` objects for a batched statement that returns automatically generated keys. The example assumes that there is only one column in the automatically generated key, and that there is always exactly one key value, whose data type is numeric. The numbers to the right of selected statements correspond to the previously-described steps.

```
try {  
    // Batch updates  
} catch (BatchUpdateException buex) {  
    System.err.println("Contents of BatchUpdateException:");  
    System.err.println(" Update counts: ");  
    int [] updateCounts = buex.getUpdateCounts();  
    for (int i = 0; i < updateCounts.length; i++) {  
        System.err.println(" Statement " + i + ":" + updateCounts[i]);  
    }  
    ResultSet[] resultList =
```

**1**

```

        ((DBBatchUpdateException)buex).getDBGGeneratedKeys(); 2
    for (i = 0; i < resultList.length; i++)
    {
        if (resultList[i] == null)
            continue; // Skip the ResultSet for which there was a failure
        else {
            rs.next();
            java.math.BigDecimal idColVar = rs.getBigDecimal(1);
                // Get automatically generated key
                // value
            System.out.println("Automatically generated key value = " + idColVar);
        }
    }
    System.err.println(" Message: " + buex.getMessage()); 3
    System.err.println(" SQLSTATE: " + buex.getSQLState());
    System.err.println(" Error code: " + buex.getErrorCode());
    SQLException ex = buex.getNextException(); 4
    while (ex != null) { 5
        System.err.println("SQL exception:");
        System.err.println(" Message: " + ex.getMessage());
        System.err.println(" SQLSTATE: " + ex.getSQLState());
        System.err.println(" Error code: " + ex.getErrorCode());
        ex = ex.getNextException();
    }
}

```

---

## Disconnecting from data sources in JDBC applications

When you have finished with a connection to a data source, it is *essential* that you close the connection to the data source. Doing this releases the Connection object's database and JDBC resources immediately.

### About this task

To close the connection to the data source, use the close method. For example:

```

    Connection con;
    ...
    con.close();

```

For a connection to a DB2 data source, if autocommit mode is not on, the connection needs to be on a unit-of-work boundary before you close the connection.

For a connection to an IBM Informix database, if the database supports logging, and autocommit mode is not on, the connection needs to be on a unit-of-work boundary before you close the connection.



---

## Chapter 4. SQLJ application programming

Writing an SQLJ application has much in common with writing an SQL application in any other language.

In general, you need to do the following things:

- Import the Java packages that contain SQLJ and JDBC methods.
- Declare variables for sending data to or retrieving data from DB2 tables.
- Connect to a data source.
- Execute SQL statements.
- Handle SQL errors and warnings.
- Disconnect from the data source.

Although the tasks that you need to perform are similar to those in other languages, the way that you execute those tasks, and the order in which you execute those tasks, is somewhat different.

---

### Example of a simple SQLJ application

A simple SQLJ application demonstrates the basic elements that JDBC applications need to include.

Figure 22. Simple SQLJ application

```
import sqlj.runtime.*; 1
import java.sql.*;

#sql context EzSqljCtx; 3a
#sql iterator EzSqljNameIter (String LASTNAME); 4a

public class EzSqlj {
    public static void main(String args[])
        throws SQLException
    {
        EzSqljCtx ctx = null;
        String URLprefix = "jdbc:db2:";
        String url;
        url = new String(URLprefix + args[0]);

        String hvmgr="000010"; 2
        String hvdeptno="A00";
        try { 3b
            Class.forName("com.ibm.db2.jcc.DB2Driver");
        } catch (Exception e)
        {
            throw new SQLException("Error in EzSqlj: Could not load the driver");
        }
        try
        {
            System.out.println("About to connect using url: " + url);
            Connection con0 = DriverManager.getConnection(url); 3c
            con0.setAutoCommit(false); // Create a JDBC Connection
            ctx = new EzSqljCtx(con0); // set autocommit OFF 3d

            try
            {
```



```

EzSqljNameIter iter;
int count=0;

#sql [ctx] iter =
    {SELECT LASTNAME FROM EMPLOYEE};
// Create result table of the SELECT
while (iter.next()) {
    System.out.println(iter.LASTNAME());
// Retrieve rows from result table
    count++;
}
System.out.println("Retrieved " + count + " rows of data");
iter.close();
// Close the iterator
}
catch( SQLException e )
{
    System.out.println ("**** SELECT SQLException...");
    while(e!=null) {
        System.out.println ("Error msg: " + e.getMessage());
        System.out.println ("SQLSTATE: " + e.getSQLState());
        System.out.println ("Error code: " + e.getErrorCode());
        e = e.getNextException(); // Check for chained exceptions
    }
}
catch( Exception e )
{
    System.out.println("**** NON-SQL exception = " + e);
    e.printStackTrace();
}
try
{
    #sql [ctx]
    {UPDATE DEPARTMENT SET MGRNO=:hvmgr
        WHERE DEPTNO=:hvdeptno}; // Update data for one department
// Commit the update
    #sql [ctx] {COMMIT};
}
catch( SQLException e )
{
    System.out.println ("**** UPDATE SQLException...");
    System.out.println ("Error msg: " + e.getMessage() + ". SQLSTATE=" +
        e.getSQLState() + " Error code=" + e.getErrorCode());
    e.printStackTrace();
}
catch( Exception e )
{
    System.out.println("**** NON-SQL exception = " + e);
    e.printStackTrace();
}
ctx.close();
}
}
catch(SQLException e)
{
    System.out.println ("**** SQLException ...");
    System.out.println ("Error msg: " + e.getMessage() + ". SQLSTATE=" +
        e.getSQLState() + " Error code=" + e.getErrorCode());
    e.printStackTrace();
}
}
catch(Exception e)
{
    System.out.println ("**** NON-SQL exception = " + e);
    e.printStackTrace();
}
}
}

```

Notes to Figure 22 on page 139:

Note	Description
1	These statements import the java.sql package, which contains the JDBC core API, and the sqlj.runtime package, which contains the SQLJ API. For information on other packages or classes that you might need to access, see "Java packages for SQLJ support".
2	String variables hvmgr and hvdeptno are <i>host identifiers</i> , which are equivalent to DB2 host variables. See "Variables in SQLJ applications" for more information.
3a, 3b, 3c, and 3d	These statements demonstrate how to connect to a data source using one of the three available techniques. See "Connecting to a data source using SQLJ" for more details.
4a , 4b, 4c, and 4d	Step 3b (loading the JDBC driver) is not necessary if you use JDBC 4.0 or later. These statements demonstrate how to execute SQL statements in SQLJ. Statement 4a demonstrates the SQLJ equivalent of declaring an SQL cursor. Statements 4b and 4c show one way of doing the SQLJ equivalent of executing an SQL OPEN CURSOR and SQL FETCHes. Statement 4d shows how to do the SQLJ equivalent of performing an SQL UPDATE. For more information, see "SQL statements in an SQLJ application".
5	This try/catch block demonstrates the use of the SQLException class for SQL error handling. For more information on handling SQL errors, see "Handling SQL errors in an SQLJ application". For more information on handling SQL warnings, see "Handling SQL warnings in an SQLJ application".
6	This is an example of a comment. For rules on including comments in SQLJ programs, see "Comments in an SQLJ application".
7	This statement closes the connection to the data source. See "Closing the connection to the data source in an SQLJ application".

---

## Connecting to a data source using SQLJ

In an SQLJ application, as in any other DB2 application, you must be connected to a data source before you can execute SQL statements.

### About this task

You can use one of six techniques to connect to a data source in an SQLJ program. Two use the JDBC DriverManager interface, two use the JDBC DataSource interface, one uses a previously created connection context, and one uses the default connection.

## SQLJ connection technique 1: JDBC DriverManager interface

SQLJ connection technique 1 uses the JDBC DriverManager interface as the underlying means for creating the connection.

### About this task

To use SQLJ connection technique 1, follow these steps:

#### Procedure

1. Execute an SQLJ *connection declaration clause*.

Doing this generates a *connection context class*. The simplest form of the connection declaration clause is:

```
#sql context context-class-name;
```

The name of the generated connection context class is *context-class-name*.

2. Load a JDBC driver by invoking the `Class.forName` method.
  - For the IBM Data Server Driver for JDBC and SQLJ, invoke `Class.forName` this way:

```
Class.forName("com.ibm.db2.jcc.DB2Driver");
```

This step is unnecessary if you use the JDBC 4.0 driver or later.
3. Invoke the constructor for the connection context class that you created in step 1 on page 141.

Doing this creates a connection context object that you specify in each SQL statement that you execute at the associated data source. The constructor invocation statement needs to be in one of the following forms:

```
connection-context-class connection-context-object=  
new connection-context-class(String url, boolean autocommit);
```

```
connection-context-class connection-context-object=  
new connection-context-class(String url, String user,  
String password, boolean autocommit);
```

```
connection-context-class connection-context-object=  
new connection-context-class(String url, Properties info,  
boolean autocommit);
```

The meanings of the parameters are:

*url*

A string that specifies the location name that is associated with the data source. That argument has one of the forms that are specified in "Connect to a data source using the DriverManager interface with the IBM Data Server Driver for JDBC and SQLJ". The form depends on which JDBC driver you are using.

*user and password*

Specify a user ID and password for connection to the data source, if the data source to which you are connecting requires them.

*info*

Specifies an object of type `java.util.Properties` that contains a set of driver properties for the connection. For the IBM Data Server Driver for JDBC and SQLJ, you can specify any of the properties listed in "Properties for the IBM Data Server Driver for JDBC and SQLJ".

*autocommit*

Specifies whether you want the database manager to issue a COMMIT after every statement. Possible values are `true` or `false`. If you specify `false`, you need to do explicit commit operations.

## Example

The following code uses connection technique 1 to create a connection to location NEWYORK. The connection requires a user ID and password, and does not require `autocommit`. The numbers to the right of selected statements correspond to the previously-described steps.

```

#sql context Ctx;           // Create connection context class Ctx      1
String userid="dbadm";     // Declare variables for user ID and password
String password="dbadm";
String empname;           // Declare a host variable
...
try {                       // Load the JDBC driver
    Class.forName("com.ibm.db2.jcc.DB2Driver");                       2
}
catch (ClassNotFoundException e) {
    e.printStackTrace();
}
Ctx myConnCtx=             3
    new Ctx("jdbc:db2://sysmvs1.st1.ibm.com:5021/NEWYORK",
        userid,password,false); // Create connection context object myConnCtx
                                // for the connection to NEWYORK
#sql [myConnCtx] {SELECT LASTNAME INTO :empname FROM EMPLOYEE
    WHERE EMPNO='000010'};
                                // Use myConnCtx for executing an SQL statement

```

Figure 23. Using connection technique 1 to connect to a data source

## SQLJ connection technique 2: JDBC DriverManager interface

SQLJ connection technique 2 uses the JDBC DriverManager interface as the underlying means for creating the connection.

### About this task

To use SQLJ connection technique 2, follow these steps:

#### Procedure

1. Execute an SQLJ *connection declaration clause*.

Doing this generates a *connection context class*. The simplest form of the connection declaration clause is:

```
#sql context context-class-name;
```

The name of the generated connection context class is *context-class-name*.

2. Load a JDBC driver by invoking the `Class.forName` method.

- For the IBM Data Server Driver for JDBC and SQLJ, invoke `Class.forName` this way:

```
Class.forName("com.ibm.db2.jcc.DB2Driver");
```

This step is unnecessary if you use the JDBC 4.0 driver or later.

3. Invoke the `JDBC DriverManager.getConnection` method.

Doing this creates a JDBC connection object for the connection to the data source. You can use any of the forms of `getConnection` that are specified in "Connect to a data source using the DriverManager interface with the IBM Data Server Driver for JDBC and SQLJ".

The meanings of the *url*, *user*, and *password* parameters are:

*url*

A string that specifies the location name that is associated with the data source. That argument has one of the forms that are specified in "Connect to a data source using the DriverManager interface with the IBM Data Server Driver for JDBC and SQLJ". The form depends on which JDBC driver you are using.

### *user and password*

Specify a user ID and password for connection to the data source, if the data source to which you are connecting requires them.

4. Invoke the constructor for the connection context class that you created in step 1 on page 143

Doing this creates a connection context object that you specify in each SQL statement that you execute at the associated data source. The constructor invocation statement needs to be in the following form:

```
connection-context-class connection-context-object=  
    new connection-context-class(Connection JDBC-connection-object);
```

The *JDBC-connection-object* parameter is the Connection object that you created in step 3 on page 143.

## Example

The following code uses connection technique 2 to create a connection to location NEWYORK. The connection requires a user ID and password, and does not require autocommit. The numbers to the right of selected statements correspond to the previously-described steps.

```
#sql context Ctx;           // Create connection context class Ctx      1  
String userid="dbadm";     // Declare variables for user ID and password  
String password="dbadm";  
String empname;           // Declare a host variable  
...  
try {                       // Load the JDBC driver  
    Class.forName("com.ibm.db2.jcc.DB2Driver");                       2  
} catch (ClassNotFoundException e) {  
    e.printStackTrace();  
}  
Connection jdbccon=       3  
    DriverManager.getConnection("jdbc:db2://sysmvs1.stl.ibm.com:5021/NEWYORK",  
        userid,password);  
    // Create JDBC connection object jdbccon  
jdbccon.setAutoCommit(false); // Do not autocommit  
Ctx myConnCtx=new Ctx(jdbccon); 4  
    // Create connection context object myConnCtx  
    // for the connection to NEWYORK  
#sql [myConnCtx] {SELECT LASTNAME INTO :empname FROM EMPLOYEE  
    WHERE EMPNO='000010'};  
    // Use myConnCtx for executing an SQL statement
```

Figure 24. Using connection technique 2 to connect to a data source

## SQLJ connection technique 3: JDBC DataSource interface

SQLJ connection technique 3 uses the JDBC DataSource as the underlying means for creating the connection.

### About this task

To use SQLJ connection technique 3, follow these steps:

### Procedure

1. Execute an SQLJ *connection declaration clause*.

Doing this generates a *connection context class*. The simplest form of the connection declaration clause is:

```
#sql context context-class-name;
```

- The name of the generated connection context class is *context-class-name*.
2. If your system administrator created a `DataSource` object in a different program, follow these steps. Otherwise, create a `DataSource` object and assign properties to it.
    - a. Obtain the logical name of the data source to which you need to connect.
    - b. Create a context to use in the next step.
    - c. In your application program, use the Java Naming and Directory Interface (JNDI) to get the `DataSource` object that is associated with the logical data source name.
  3. Invoke the JDBC `DataSource.getConnection` method.

Doing this creates a JDBC connection object for the connection to the data source. You can use one of the following forms of `getConnection`:

```
getConnection();  
getConnection(user, password);
```

The meanings of the *user* and *password* parameters are:

*user* **and** *password*

Specify a user ID and password for connection to the data source, if the data source to which you are connecting requires them.
  4. If the default autocommit mode is not appropriate, invoke the JDBC `Connection.setAutoCommit` method.

Doing this indicates whether you want the database manager to issue a COMMIT after every statement. The form of this method is:

```
setAutoCommit(boolean autocommit);
```
  5. Invoke the constructor for the connection context class that you created in step 1 on page 144.

Doing this creates a connection context object that you specify in each SQL statement that you execute at the associated data source. The constructor invocation statement needs to be in the following form:

```
connection-context-class connection-context-object=  
new connection-context-class(Connection JDBC-connection-object);
```

The *JDBC-connection-object* parameter is the `Connection` object that you created in step 3.

## Example

The following code uses connection technique 3 to create a connection to a location with logical name `jdbc/sampledb`. This example assumes that the system administrator created and deployed a `DataSource` object that is available through JNDI lookup. The numbers to the right of selected statements correspond to the previously-described steps.

```

import java.sql.*;
import javax.naming.*;
import javax.sql.*;
...
#sql context CtxSqlj;           // Create connection context class CtxSqlj 1
Context ctx=new InitialContext(); 2b
DataSource ds=(DataSource)ctx.lookup("jdbc/sampled"); 2c
Connection con=ds.getConnection(); 3
String empname;                // Declare a host variable
...
con.setAutoCommit(false);      // Do not autocommit 4
CtxSqlj myConnCtx=new CtxSqlj(con); 5
                                // Create connection context object myConnCtx
#sql [myConnCtx] {SELECT LASTNAME INTO :empname FROM EMPLOYEE
    WHERE EMPNO='000010'};
                                // Use myConnCtx for executing an SQL statement

```

Figure 25. Using connection technique 3 to connect to a data source

## SQLJ connection technique 4: JDBC DataSource interface

SQLJ connection technique 4 uses the JDBC DataSource as the underlying means for creating the connection. This technique **requires** that the DataSource is registered with JNDI.

### About this task

To use SQLJ connection technique 4, follow these steps:

### Procedure

1. From your system administrator, obtain the logical name of the data source to which you need to connect.
2. Execute an SQLJ connection declaration clause.

For this type of connection, the connection declaration clause needs to be of this form:

```
#sql public static context context-class-name
    with (dataSource="logical-name");
```

The connection context must be declared as public and static. *logical-name* is the data source name that you obtained in step 1.

3. Invoke the constructor for the connection context class that you created in step 2.

Doing this creates a connection context object that you specify in each SQL statement that you execute at the associated data source. The constructor invocation statement needs to be in one of the following forms:

```
connection-context-class connection-context-object=
    new connection-context-class();
```

```
connection-context-class connection-context-object=
    new connection-context-class (String user,
    String password);
```

The meanings of the *user* and *password* parameters are:

#### *user* and *password*

Specify a user ID and password for connection to the data source, if the data source to which you are connecting requires them.

## Example

The following code uses connection technique 4 to create a connection to a location with logical name jdbc/sampledb. The connection requires a user ID and password.

```
#sql public static context Ctx
    with (dataSource="jdbc/sampledb");
                                     // Create connection context class Ctx
String userid="dbadm";                // Declare variables for user ID and password
String password="dbadm";

String empname;                       // Declare a host variable
...
Ctx myConnCtx=new Ctx(userid, password);
                                     // Create connection context object myConnCtx
                                     // for the connection to jdbc/sampledb
#sql [myConnCtx] {SELECT LASTNAME INTO :empname FROM EMPLOYEE
    WHERE EMPNO='000010'};
                                     // Use myConnCtx for executing an SQL statement
```

Figure 26. Using connection technique 4 to connect to a data source

## SQLJ connection technique 5: Use a previously created connection context

SQLJ connection technique 5 uses a previously created connection context to connect to the data source.

### About this task

In general, one program declares a connection context class, creates connection contexts, and passes them as parameters to other programs. A program that uses the connection context invokes a constructor with the passed connection context object as its argument.

### Example

Program CtxGen.sqlj declares connection context Ctx and creates instance oldCtx:

```
#sql context Ctx;
...
// Create connection context object oldCtx
```

Program test.sqlj receives oldCtx as a parameter and uses oldCtx as the argument of its connection context constructor:

```
void useContext(sqlj.runtime.ConnectionContext oldCtx)
    // oldCtx was created in CtxGen.sqlj
{
    Ctx myConnCtx=
        new Ctx(oldCtx);                // Create connection context object myConnCtx
                                        // from oldCtx
    #sql [myConnCtx] {SELECT LASTNAME INTO :empname FROM EMPLOYEE
        WHERE EMPNO='000010'};
                                        // Use myConnCtx for executing an SQL statement
    ...
}
```

## SQLJ connection technique 6: Use the default connection

SQLJ connection technique 6 uses the default connection to connect to the data source. It should be used only in situations where the database thread is controlled by another resource manager, such as the Java stored procedure environment.



## About this task

You use the default connection by specifying your SQL statements without a connection context object. When you use this technique, you do not need to load a JDBC driver unless you explicitly use JDBC interfaces in your program.

The default connection context can be:

- The connection context that is associated with the data source that is bound to the logical name `jdbc/defaultDataSource`
- An explicitly created connection context that has been set as the default connection context with the `ConnectionContext.setDefaultContext` method. This method of creating a default connection context is not recommended.

## Example

The following SQLJ execution clause does not have a connection context, so it uses the default connection context.

```
#sql {SELECT LASTNAME INTO :empname FROM EMPLOYEE
      WHERE EMPNO='000010'}; // Use default connection for
                          // executing an SQL statement
```

---

## Java packages for SQLJ support

Before you can execute SQLJ statements or invoke JDBC methods in your SQLJ program, you need to be able to access all or parts of various Java packages that contain support for those statements.

You can do that either by importing the packages or specific classes, or by using fully-qualified class names. You might need the following packages or classes for your SQLJ program:

### **sqlj.runtime**

Contains the SQLJ run-time API.

### **java.sql**

Contains the core JDBC API.

### **com.ibm.db2.jcc**

Contains the driver-specific implementation of JDBC and SQLJ.

### **javax.naming**

Contains methods for performing Java Naming and Directory Interface (JNDI) lookup.

### **javax.sql**

Contains methods for creating DataSource objects.

---

## Variables in SQLJ applications

In DB2 programs in other languages, you use host variables to pass data between the application program and DB2. In SQLJ programs, you can use host variables or *host expressions*.

A host expression begins with a colon (:). The colon is followed by an optional parameter mode identifier (IN, OUT, or INOUT), which is followed by a parenthesized expression clause.

Host variables and host expressions are case sensitive.

A complex expression is an array element or Java expression that evaluates to a single value. A complex expression in an SQLJ clause must be surrounded by parentheses.

The following examples demonstrate how to use host expressions.

*Example:* Declaring a Java identifier and using it in a SELECT statement:

In this example, the statement that begins with #sql has the same function as a SELECT statement in other languages. This statement assigns the last name of the employee with employee number 000010 to Java identifier empname.

```
String empname;  
...  
#sql [ctxt]  
  {SELECT LASTNAME INTO :empname FROM EMPLOYEE WHERE EMPNO='000010'};
```

*Example:* Declaring a Java identifier and using it in a stored procedure call:

In this example, the statement that begins with #sql has the same function as an SQL CALL statement in other languages. This statement uses Java identifier empno as an input parameter to stored procedure A. The keyword IN, which precedes empno, specifies that empno is an input parameter. For a parameter in a CALL statement, IN is the default. The explicit or default qualifier that indicates how the parameter is used (IN, OUT, or INOUT) must match the corresponding value in the parameter definition that you specified in the CREATE PROCEDURE statement for the stored procedure.

```
String empno = "0000010";  
...  
#sql [ctxt] {CALL A (:IN empno)};
```

*Example:* Using a complex expression as a host identifier:

This example uses complex expression (((int)yearsEmployed++/5)\*500) as a host expression.

```
#sql [ctxt] {UPDATE EMPLOYEE  
  SET BONUS=(((int)yearsEmployed++/5)*500) WHERE EMPNO=:empID};
```

SQLJ performs the following actions when it processes a complex host expression:

- Evaluates each of the host expressions in the statement, from left to right, before assigning their respective values to the database.
- Evaluates side effects, such as operations with postfix operators, according to normal Java rules. All host expressions are fully evaluated before any of their values are passed to DB2.
- Uses Java rules for rounding and truncation.

Therefore, if the value of yearsEmployed is 6 before the UPDATE statement is executed, the value that is assigned to column BONUS by the UPDATE statement is ((int)6/5)\*500, or 500. After 500 is assigned to BONUS, the value of yearsEmployed is incremented.

**Restrictions on variable names:** Two strings have special meanings in SQLJ programs. Observe the following restrictions when you use these strings in your SQLJ programs:

- The string \_\_sJT\_ is a reserved prefix for variable names that are generated by SQLJ. Do not begin the following types of names with \_\_sJT\_:
  - Host expression names

- Java variable names that are declared in blocks that include executable SQL statements
- Names of parameters for methods that contain executable SQL statements
- Names of fields in classes that contain executable SQL statements, or in classes with subclasses or enclosed classes that contain executable SQL statements
- The string `_SJ` is a reserved suffix for resource files and classes that are generated by SQLJ. Avoid using the string `_SJ` in class names and input source file names.

---

## Indicator variables in SQLJ applications

In SQLJ programs, you can use indicator variables to pass the NULL value to or from a data server, to pass the default value for a column to the data server, or to indicate that a host variable value is unassigned.

A host variable or host expression can be followed by an indicator variable. An indicator variable begins with a colon (`:`) and has the data type short. For input, an indicator variable indicates whether the corresponding host variable or host expression has the default value, a non-null value, the null value, or is unassigned. An unassigned variable in an SQL statement yields the same results as if the variable and its target column were not in the SQL statement. For output, the indicator variable indicates where the corresponding host variable or host expression has a non-null value or a null value.

In SQLJ programs, indicator variables that indicate a null value perform the same function as assigning the Java null value to a table column. However, you need to use an indicator variable to retrieve the SQL NULL value from a table into a host variable.

You can use indicator variables that assign the default value or the unassigned value to columns to simplify the coding in your applications. For example, if a table has four columns, and you might need to update any combination of those columns, without the use of default indicator variables or unassigned indicator variables, you need 15 UPDATE statements to perform all possible combinations of updates. With default indicator variables and unassigned indicator variables, you can use one UPDATE statement with all four columns in the SET statement to perform all possible updates. You use the indicator variables to indicate which columns you want to set to their default values, and which columns you do not want to update.

For input, SQLJ supports the use of indicator variables for INSERT, UPDATE, or MERGE statements.

If you customize your SQLJ application, you can assign one of the following values to an indicator variable in an SQLJ application to specify the type of the corresponding input host variable.

Indicator value	Equivalent constant	Meaning of value
-1	<code>sqlj.runtime.ExecutionContext.DBNull</code>	Null
-2, -3, -4, -6		Null
-5	<code>sqlj.runtime.ExecutionContext.DBDefault</code>	Default
-7	<code>sqlj.runtime.ExecutionContext.DBUnassigned</code>	Unassigned

Indicator value	Equivalent constant	Meaning of value
<i>short-value</i> >=0	sqlj.runtime.ExecutionContext.DBNonNull	Non-null

If you do not customize the application, you can assign one of the following values to an indicator variable to specify the type of the corresponding input host variable.

Indicator value	Equivalent constant	Meaning of value
-1	sqlj.runtime.ExecutionContext.DBNull	Null
-7 <= <i>short-value</i> < -1		Null
0	sqlj.runtime.ExecutionContext.DBNonNull	Non-null
<i>short-value</i> >0		Non-null

For output, SQLJ supports the use of indicator variables for the following statements:

- CALL with OUT or INOUT parameters
- FETCH *iterator* INTO *host-variable*
- SELECT ... INTO *host-variable-1*,...*host-variable-n*

SQLJ assigns one of the following values to an indicator variable to indicate whether an SQL NULL value was retrieved into the corresponding host variable.

Indicator value	Equivalent constant	Meaning of value
-1	sqlj.runtime.ExecutionContext.DBNull	Retrieved value is SQL NULL
0		Retrieved value is not SQL NULL

You cannot use indicator variables to update result sets. To assign null values or default values to result sets, or to indicate that columns are unassigned, call `ResultSet.updateObject` on the underlying JDBC `ResultSet` objects of the SQLJ iterators.

The following examples demonstrate how to use indicator variables.

All examples require that the data server supports extended indicators.

*Example of using indicators to assign the default value to columns during an INSERT:*

In this example, the MGRNO and LOCATION columns need to be set to their default values. To do this, the code performs these steps:

1. Assigns the value `ExecutionContext.DBNonNull` to the indicator variables (`deptInd`, `dNameInd`, `rptDeptInd`) for the input host variables (`dept`, `dName`, `rptDept`) that send non-default values to the target columns.
2. Assigns the value `ExecutionContext.DBDefault` to the indicator variables (`mgrInd`, `locnInd`) for the input host variables (`mgr`, `locn`) that send default values to the target columns.
3. Executes an INSERT statement with the host variable and indicator variable pairs as input.

The numbers to the right of selected statements correspond to the previously described steps.

```

import sqlj.runtime.*;
...
String dept = "F01";
String dName = "SHIPPING";
String rptDept = "A00";
String mgr, locn = null;
short deptInd, dNameInd, mgrInd, rptDeptInd, locnInd;
// Set indicator variables for dept, dName, rptDept to non-null
deptInd = dNameInd = rptDeptInd = ExecutionContext.DBNotNull;
mgrInd = ExecutionContext.DBDefault;
locnInd = ExecutionContext.DBDefault;
#sql [ctxt]
{INSERT INTO DEPARTMENT
 (DEPTNO, DEPTNAME, MGRNO, ADMRDEPT, LOCATION)
 VALUES (:dept :deptInd, :dName :dNameInd, :mgr :mgrInd,
 :rptDept :rptDeptInd, :locn :locnInd)};

```

1  
2  
3

*Example of using indicators to assign the default value to leave column values unassigned during an UPDATE:*

In this example, in rows for department F01, the MGRNO column needs to be set to its default value, the DEPTNAME column value needs to be changed to RECEIVING, and the DEPTNO, DEPTNAME, ADMRDEPT, and LOCATION columns need to remain unchanged. To do this, the code performs these steps:

1. Assigns the new value for the DEPTNAME column to the dName input host variable.
2. Assigns the value ExecutionContext.DBDefault to the indicator variable (mgrInd) for the input host variable (mgr) that sends the default value to the target column.
3. Assigns the value ExecutionContext.DBUnassigned to the indicator variables (deptInd, dNameInd, rptDeptInd, and locnInd) for the input host variables (dept, dName, rptDept, and locn) that need to remain unchanged by the UPDATE operation.
4. Executes an UPDATE statement with the host variable and indicator variable pairs as input.

The numbers to the right of selected statements correspond to the previously described steps.

```

import sqlj.runtime.*;
...
String dept = null;
String dName = "RECEIVING";
String rptDept = null;
String mgr, locn = null;
short deptInd, dNameInd, mgrInd, rptDeptInd, locnInd;
dNameInd = ExecutionContext.DBNotNull;
mgrInd = ExecutionContext.DBDefault;
deptInd = rptDeptInd = locnInd = ExecutionContext.DBUnassigned;
#sql [ctxt]
{UPDATE DEPARTMENT
 SET DEPTNO = :dept :deptInd,
   DEPTNAME = :dName :dNameInd,
   MGRNO = :mgr :mgrInd,
   ADMRDEPT = :rptDept :rptDeptInd,
   LOCATION = :locn :locnInd
 WHERE DEPTNO = "F01"
};

```

1  
2  
3  
4

*Example of using indicators to retrieve NULL values from columns:*

In this example, the HIREDATE column can return the NULL value. To handle this case, the code performs these steps:

1. Defines an indicator variable to indicate when the NULL value is returned from HIREDATE.
2. Executes FETCH statements with the host variable and indicator variable pairs as output.
3. Checks the indicator variable to determine whether a NULL value was returned.

The numbers to the right of selected statements correspond to the previously described steps.

```
import sqlj.runtime.*;
...
#sql iterator ByPos(String, Date); // Declare positioned iterator ByPos
{
    ...
    ByPos positer;                // Declare object of ByPos class
    String name = null;           // Declare host variables
    Date hrdate = null;
    short indhrdate = null;      // Declare indicator variable      1
    #sql [ctxt] positer =
        {SELECT LASTNAME, HIREDATE FROM EMPLOYEE};
                                // Assign the result table of the SELECT
                                // to iterator object positer
    #sql {FETCH :positer INTO :name, :hrdate :indhrdate };           2
                                // Retrieve the first row
    while (!positer.endFetch()) // Check whether the FETCH returned a row
    { if(indhrdate == ExecutionContext.DBNotNull) {                   3
        System.out.println(name + " was hired in " +
            hrdate); }
        else {
            System.out.println(name + " has no hire date "); }
        #sql {FETCH :positer INTO :name, :hrdate };
                                // Fetch the next row
    }
    positer.close();           // Close the iterator                    5
}
```

*Example of assigning default values to result set columns:*

In this example, the HIREDATE column in a result set needs to be set to its default value. To do this, the code performs these steps:

1. Retrieves the underlying ResultSet from the iterator that holds the retrieved data.
2. Executes the ResultSet.updateObject method with the DB2PreparedStatement.DB\_PARAMETER\_DEFAULT constant to assign the default value to the result set column.

The numbers to the right of selected statements correspond to the previously described steps.

```
#sql public iterator sensitiveUpdateIter
implements sqlj.runtime.Scrollable, sqlj.runtime.ForUpdate
with (sensitivity=sqlj.runtime.ResultSetIterator.SENSITIVE,
updateColumns="LASTNAME, HIREDATE") (String, Date);

String name;                // Declare host variables
Date hrdate;

sensitiveUpdateIter iter = null;
#sql [ctx] iter = { SELECT LASTNAME, HIREDATE FROM EMPLOYEE};
```

```

iter.next();

java.sql.ResultSet rs = iter.getResultSet();
rs.updateString("LASTNAME", "FORREST");
rs.updateObject
(2, com.ibm.db2.jcc.DB2PreparedStatement.DB_PARAMETER_DEFAULT);
rs.updateRow();
iter.close();

```

**1**

**2,3**

---

## Comments in an SQLJ application

To document your SQLJ program, you need to include comments. To do that, use Java comments. Java comments are denoted by `/* */` or `//`.

You can include Java comments outside SQLJ clauses, wherever the Java language permits them. Within an SQLJ clause, you can use Java comments in the following places:

- Within a host expression (`/* */` or `//`).
  - Within an SQL statement in an executable clause, if the data source supports a comment within the SQL statement (`/* */` or `--`).
- `/*` and `*/` pairs in an SQL statement can be nested.

---

## SQL statement execution in SQLJ applications

You execute SQL statements in a traditional SQL program to create tables, update data in tables, retrieve data from the tables, call stored procedures, or commit or roll back transactions. In an SQLJ program, you also execute these statements, within SQLJ *executable clauses*.

An executable clause can have one of the following general forms:

```

#sql [connection-context] {sql-statement};
#sql [connection-context,execution-context] {sql-statement};
#sql [execution-context] {sql-statement};

```

### execution-context specification

In an executable clause, you should **always** specify an explicit connection context, with one exception: you do not specify an explicit connection context for a FETCH statement. You include an execution context only for specific cases. See "Control the execution of SQL statements in SQLJ" for information about when you need an execution context.

### connection-context specification

In an executable clause, if you do not explicitly specify a connection context, the executable clause uses the default connection context.

## Creating and modifying database objects in an SQLJ application

Use SQLJ executable clauses to execute data definition statements (CREATE, ALTER, DROP, GRANT, REVOKE) or to execute INSERT, searched or positioned UPDATE, and searched or positioned DELETE statements.

### Example

The following executable statements demonstrate an INSERT, a searched UPDATE, and a searched DELETE:



```
#sql [myConnCtx] {INSERT INTO DEPARTMENT VALUES
("X00","Operations 2","000030","E01",NULL)};
#sql [myConnCtx] {UPDATE DEPARTMENT
SET MGRNO="000090" WHERE MGRNO="000030"};
#sql [myConnCtx] {DELETE FROM DEPARTMENT
WHERE DEPTNO="X00"};
```

## Performing positioned UPDATE and DELETE operations in an SQLJ application

As in DB2 applications in other languages, performing positioned UPDATES and DELETES with SQLJ is an extension of retrieving rows from a result table.

### About this task

The basic steps are:

### Procedure

1. Declare the iterator.

The iterator can be positioned or named. For positioned UPDATE or DELETE operations, declare the iterator as updatable, using one or both of the following clauses:

#### **implements sqlj.runtime.ForUpdate**

This clause causes the generated iterator class to include methods for using updatable iterators. This clause is required for programs with positioned UPDATE or DELETE operations.

#### **with (updateColumns="column-list")**

This clause specifies a comma-separated list of the columns of the result table that the iterator will update. This clause is optional.

You need to declare the iterator as `public`, so you need to follow the rules for declaring and using `public` iterators in the same file or different files.

If you declare the iterator in a file by itself, any SQLJ source file that has addressability to the iterator and imports the generated class can retrieve data and execute positioned UPDATE or DELETE statements using the iterator.

The authorization ID under which a positioned UPDATE or DELETE statement executes depends on whether the statement executes statically or dynamically. If the statement executes statically, the authorization ID is the owner of the plan or package that includes the statement. If the statement executes dynamically the authorization ID is determined by the DYNAMICRULES behavior that is in effect. For the IBM Data Server Driver for JDBC and SQLJ, the behavior is always DYNAMICRULES BIND.

2. Disable autocommit mode for the connection.

If autocommit mode is enabled, a COMMIT operation occurs every time the positioned UPDATE statement executes, which causes the iterator to be destroyed unless the iterator has the `with (holdability=true)` attribute.

Therefore, you need to turn autocommit off to prevent COMMIT operations until you have finished using the iterator. If you want a COMMIT to occur after every update operation, an alternative way to keep the iterator from being destroyed after each COMMIT operation is to declare the iterator with `(holdability=true)`.

3. Create an instance of the iterator class.

This is the same step as for a non-updatable iterator.

4. Assign the result table of a SELECT to an instance of the iterator.



This is the same step as for a non-updatable iterator. The SELECT statement must not include a FOR UPDATE clause.

5. Retrieve and update rows.

For a positioned iterator, do this by performing the following actions in a loop:

- a. Execute a FETCH statement in an executable clause to obtain the current row.
- b. Test whether the iterator is pointing to a row of the result table by invoking the PositionedIterator.endFetch method.
- c. If the iterator is pointing to a row of the result table, execute an SQL UPDATE... WHERE CURRENT OF *:iterator-object* statement in an executable clause to update the columns in the current row. Execute an SQL DELETE... WHERE CURRENT OF *:iterator-object* statement in an executable clause to delete the current row.

For a named iterator, do this by performing the following actions in a loop:

- a. Invoke the next method to move the iterator forward.
- b. Test whether the iterator is pointing to a row of the result table by checking whether next returns true.
- c. Execute an SQL UPDATE... WHERE CURRENT OF *iterator-object* statement in an executable clause to update the columns in the current row. Execute an SQL DELETE... WHERE CURRENT OF *iterator-object* statement in an executable clause to delete the current row.

6. Close the iterator.

Use the close method to do this.

## Example

The following code shows how to declare a positioned iterator and use it for positioned UPDATES. The numbers to the right of selected statements correspond to the previously described steps.

First, in one file, declare positioned iterator UpdByPos, specifying that you want to use the iterator to update column SALARY:

```
import java.math.*; // Import this class for BigDecimal data type
#sql public iterator UpdByPos implements sqlj.runtime.ForUpdate 1
    with(updateColumns="SALARY") (String, BigDecimal);
```

Figure 27. Example of declaring a positioned iterator for a positioned UPDATE

Then, in another file, use UpdByPos for a positioned UPDATE, as shown in the following code fragment:

```

import sqlj.runtime.*;      // Import files for SQLJ and JDBC APIs
import java.sql.*;
import java.math.*;        // Import this class for BigDecimal data type
import UpdByPos;           // Import the generated iterator class that
                           // was created by the iterator declaration clause
                           // for UpdByName in another file
#sql context HSCTX;        // Create a connection context class HSCTX
public static void main (String args[])
{
    try {
        Class.forName("com.ibm.db2.jcc.DB2Driver");
    }
    catch (ClassNotFoundException e) {
        e.printStackTrace();
    }

    Connection HSjdbccon=
    DriverManager.getConnection("jdbc:db2:SANJOSE");
    // Create a JDBC connection object
    HSjdbccon.setAutoCommit(false);           2
    // Set autocommit off so automatic commits
    // do not destroy the cursor between updates

    HSCTX myConnCtx=new HSCTX(HSjdbccon);
    // Create a connection context object
    UpdByPos upditer; // Declare iterator object of UpdByPos class 3
    String empnum;    // Declares host variable to receive EMPNO
    BigDecimal sal;   // and SALARY column values
    #sql [myConnCtx]
        upditer = {SELECT EMPNO, SALARY FROM EMPLOYEE 4
                   WHERE WORKDEPT='D11'};
    // Assign result table to iterator object
    #sql {FETCH :upditer INTO :empnum,:sal}; 5a
    // Move cursor to next row
    while (!upditer.endFetch()) 5b
    {
        // Check if on a row
        #sql [myConnCtx] {UPDATE EMPLOYEE SET SALARY=SALARY*1.05 5c
                          WHERE CURRENT OF :upditer};
        // Perform positioned update
        System.out.println("Updating row for " + empnum);
        #sql {FETCH :upditer INTO :empnum,:sal};
        // Move cursor to next row
    }
    upditer.close(); // Close the iterator 6
    #sql [myConnCtx] {COMMIT};
    // Commit the changes
    myConnCtx.close(); // Close the connection context
}

```

Figure 28. Example of performing a positioned UPDATE with a positioned iterator

The following code shows how to declare a named iterator and use it for positioned UPDATES. The numbers to the right of selected statements correspond to the previously described steps.

First, in one file, declare named iterator UpdByName, specifying that you want to use the iterator to update column SALARY:

```

import java.math.*;        // Import this class for BigDecimal data type
#sql public iterator UpdByName implements sqlj.runtime.ForUpdate 1
    with(updateColumns="SALARY") (String EmpNo, BigDecimal Salary);

```

Figure 29. Example of declaring a named iterator for a positioned UPDATE

Then, in another file, use UpdByName for a positioned UPDATE, as shown in the following code fragment:

```

import sqlj.runtime.*;      // Import files for SQLJ and JDBC APIs
import java.sql.*;
import java.math.*;        // Import this class for BigDecimal data type
import UpdByName;          // Import the generated iterator class that
                           // was created by the iterator declaration clause
                           // for UpdByName in another file
#sql context HSctx;        // Create a connection context class HSctx
public static void main (String args[])
{
    try {
        Class.forName("com.ibm.db2.jcc.DB2Driver");
    }
    catch (ClassNotFoundException e) {
        e.printStackTrace();
    }
    Connection HSjdbccon=
    DriverManager.getConnection("jdbc:db2:SANJOSE");
    // Create a JDBC connection object
    HSjdbccon.setAutoCommit(false);
    // Set autocommit off so automatic commits 2
    // do not destroy the cursor between updates
    HSctx myConnCtx=new HSctx(HSjdbccon);
    // Create a connection context object
    UpdByName upditer;      // Declare iterator object of UpdByName class 3
    String empnum;          // Declare host variable to receive EmpNo
                           // column values
    #sql [myConnCtx]
        upditer = {SELECT EMPNO, SALARY FROM EMPLOYEE 4
                   WHERE WORKDEPT='D11'};
    while (upditer.next()) // Assign result table to iterator object 5a,5b
                           // Move cursor to next row and
                           // check if on a row
    {
        empnum = upditer.EmpNo(); // Get employee number from current row
        #sql [myConnCtx]
            {UPDATE EMPLOYEE SET SALARY=SALARY*1.05
              WHERE CURRENT OF :upditer}; // Perform positioned update 5c
        System.out.println("Updating row for " + empnum);
    }
    upditer.close();        // Close the iterator 6
    #sql [myConnCtx] {COMMIT};
    // Commit the changes
    myConnCtx.close();     // Close the connection context
}

```

Figure 30. Example of performing a positioned UPDATE with a named iterator

## Iterators as passed variables for positioned UPDATE or DELETE operations in an SQLJ application

SQLJ allows iterators to be passed between methods as variables.

An iterator that is used for a positioned UPDATE or DELETE statement can be identified only at runtime. The same SQLJ positioned UPDATE or DELETE statement can be used with different iterators at runtime. If you specify a value of YES for -staticpositioned when you customize your SQLJ application as part of the program preparation process, the SQLJ customizer prepares positioned UPDATE or DELETE statements to execute statically. In this case, the customizer must determine which iterators belong with which positioned UPDATE or DELETE

statements. The SQLJ customizer does this by matching iterator data types to data types in the UPDATE or DELETE statements. However, if there is not a unique mapping of tables in UPDATE or DELETE statements to iterator classes, the SQLJ customizer cannot determine exactly which iterators and UPDATE or DELETE statements go together. The SQLJ customizer must arbitrarily pair iterators with UPDATE or DELETE statements, which can sometimes result in SQL errors. The following code fragments illustrate this point.

```
#sql iterator GeneralIter implements sqlj.runtime.ForUpdate
( String );

public static void main ( String args[] )
{
...
    GeneralIter iter1 = null;
    #sql [ctxt] iter1 = { SELECT CHAR_COL1 FROM TABLE1 };

    GeneralIter iter2 = null;
    #sql [ctxt] iter2 = { SELECT CHAR_COL2 FROM TABLE2 };
...

    doUpdate ( iter1 );
}

public static void doUpdate ( GeneralIter iter )
{
    #sql [ctxt] { UPDATE TABLE1 ... WHERE CURRENT OF :iter };
}
```

*Figure 31. Static positioned UPDATE that fails*

In this example, only one iterator is declared. Two instances of that iterator are declared, and each is associated with a different SELECT statement that retrieves data from a different table. During customization and binding with -staticpositioned YES, SQLJ creates two DECLARE CURSOR statements, one for each SELECT statement, and attempts to bind an UPDATE statement for each cursor. However, the bind process fails with SQLCODE -509 when UPDATE TABLE1 ... WHERE CURRENT OF :iter is bound for the cursor for SELECT CHAR\_COL2 FROM TABLE2 because the table for the UPDATE does not match the table for the cursor.

You can avoid a bind time error for a program like the one in Figure 31 by specifying the bind option SQLERROR(CONTINUE). However, this technique has the drawback that it causes the DB2 database manager to build a package, regardless of the SQL errors that are in the program. A better technique is to write the program so that there is a one-to-one mapping between tables in positioned UPDATE or DELETE statements and iterator classes. Figure 32 on page 160 shows an example of how to do this.

```

#sql iterator Table2Iter(String);
#sql iterator Table1Iter(String);
    public static void main ( String args[] )
    {
    ...
        Table2Iter iter2 = null;
        #sql [ctxt] iter2 = { SELECT CHAR_COL2 FROM TABLE2 };

        Table1Iter iter1 = null;
        #sql [ctxt] iter1 = { SELECT CHAR_COL1 FROM TABLE1 };
    ...

        doUpdate(iter1);

    }

    public static void doUpdate ( Table1Iter iter )
    {
        ...
        #sql [ctxt] { UPDATE TABLE1 ... WHERE CURRENT OF :iter };
        ...
    }
    public static void doUpdate ( Table2Iter iter )
    {
        ...
        #sql [ctxt] { UPDATE TABLE2 ... WHERE CURRENT OF :iter };
        ...
    }
}

```

Figure 32. Static positioned UPDATE that succeeds

With this method of coding, each iterator class is associated with only one table. Therefore, the DB2 bind process can always associate the positioned UPDATE statement with a valid iterator.

## Making batch updates in SQLJ applications

The IBM Data Server Driver for JDBC and SQLJ supports batch updates in SQLJ. With batch updates, instead of updating rows of a table one at a time, you can direct SQLJ to execute a group of updates at the same time.

### About this task

You can include the following types of statements in a batch update:

- Searched INSERT, UPDATE, or DELETE, or MERGE statements
- CREATE, ALTER, DROP, GRANT, or REVOKE statements
- CALL statements with input parameters only

Unlike JDBC, SQLJ allows heterogeneous batches that contain statements with input parameters or host expressions. You can therefore combine any of the following items in an SQLJ batch:

- Instances of the same statement
- Different statements
- Statements with different numbers of input parameters or host expressions
- Statements with different data types for input parameters or host expressions
- Statements with no input parameters or host expressions

For all cases except homogeneous batches of INSERT statements, when an error occurs during execution of a statement in a batch, the remaining statements are executed, and a BatchUpdateException is thrown after all the statements in the batch have executed.

For homogeneous batches of INSERT statements, the behavior is as follows:

- If you set `atomicMultiRowInsert` to `DB2BaseDataSource.YES (1)` when you run `db2sqljcustomize`, and the target data server is DB2 for z/OS, when an error occurs during execution of an INSERT statement in a batch, the remaining statements are not executed, and a `BatchUpdateException` is thrown.
- If you do not set `atomicMultiRowInsert` to `DB2BaseDataSource.YES (1)` when you run `db2sqljcustomize`, or the target data server is not DB2 for z/OS, when an error occurs during execution of an INSERT statement in a batch, the remaining statements are executed, and a `BatchUpdateException` is thrown after all the statements in the batch have executed.

To obtain information about warnings, use the `ExecutionContext.getWarnings` method on the `ExecutionContext` that you used to submit statements to be batched. You can then retrieve an error description, `SQLSTATE`, and error code for each `SQLWarning` object.

When a batch is executed implicitly because the program contains a statement that cannot be added to the batch, the batch is executed before the new statement is processed. If an error occurs during execution of the batch, the statement that caused the batch to execute does not execute.

The basic steps for creating, executing, and deleting a batch of statements are:

### Procedure

1. Disable `AutoCommit` for the connection.  
Do this so that you can control whether to commit changes to already-executed statements when an error occurs during batch execution.
2. Acquire an execution context.  
All statements that execute in a batch must use this execution context.
3. Invoke the `ExecutionContext.setBatching(true)` method to create a batch.  
Subsequent batchable statements that are associated with the execution context that you created in step 2 are added to the batch for later execution.  
If you want to batch sets of statements that are not batch compatible in parallel, you need to create an execution context for each set of batch compatible statements.
4. Include SQLJ executable clauses for SQL statements that you want to batch.  
These clauses must include the execution context that you created in step 2.  
If an SQLJ executable clause has input parameters or host expressions, you can include the statement in the batch multiple times with different values for the input parameters or host expressions.  
To determine whether a statement was added to an existing batch, was the first statement in a new batch, or was executed inside or outside a batch, invoke the `ExecutionContext.getUpdateCount` method. This method returns one of the following values:

#### **ExecutionContext.ADD\_BATCH\_COUNT**

This is a constant that is returned if the statement was added to an existing batch.

#### **ExecutionContext.NEW\_BATCH\_COUNT**

This is a constant that is returned if the statement was the first statement in a new batch.

**ExecutionContext.EXEC\_BATCH\_COUNT**

This is a constant that is returned if the statement was part of a batch, and the batch was executed.

*Other integer*

This value is the number of rows that were updated by the statement. This value is returned if the statement was executed rather than added to a batch.

## 5. Execute the batch explicitly or implicitly.

- Invoke the `ExecutionContext.executeBatch` method to execute the batch explicitly.

`executeBatch` returns an integer array that contains the number of rows that were updated by each statement in the batch. The order of the elements in the array corresponds to the order in which you added statements to the batch.

- Alternatively, a batch executes implicitly under the following circumstances:
  - You include a batchable statement in your program that is not compatible with statements that are already in the batch. In this case, SQLJ executes the statements that are already in the batch and creates a new batch that includes the incompatible statement.
  - You include a statement in your program that is not batchable. In this case, SQLJ executes the statements that are already in the batch. SQLJ also executes the statement that is not batchable.
  - After you invoke the `ExecutionContext.setBatchLimit(n)` method, you add a statement to the batch that brings the number of statements in the batch to *n* or greater. *n* can have one of the following values:

**ExecutionContext.UNLIMITED\_BATCH**

This constant indicates that implicit execution occurs only when SQLJ encounters a statement that is batchable but incompatible, or not batchable. Setting this value is the same as not invoking `setBatchLimit`.

**ExecutionContext.AUTO\_BATCH**

This constant indicates that implicit execution occurs when the number of statements in the batch reaches a number that is set by SQLJ.

*Positive integer*

When this number of statements have been added to the batch, SQLJ executes the batch implicitly. However, the batch might be executed before this many statements have been added if SQLJ encounters a statement that is batchable but incompatible, or not batchable.

To determine the number of rows that were updated by a batch that was executed implicitly, invoke the `ExecutionContext.getBatchUpdateCounts` method. `getBatchUpdateCounts` returns an integer array that contains the number of rows that were updated by each statement in the batch. The order of the elements in the array corresponds to the order in which you added statements to the batch. Each array element can be one of the following values:

- 2 This value indicates that the SQL statement executed successfully, but the number of rows that were updated could not be determined.
- 3 This value indicates that the SQL statement failed.

*Other integer*

This value is the number of rows that were updated by the statement.

6. Optionally, when all statements have been added to the batch, disable batching. Do this by invoking the `ExecutionContext.setBatching(false)` method. When you disable batching, you can still execute the batch implicitly or explicitly, but no more statements are added to the batch. Disabling batching is useful when a batch already exists, and you want to execute a batch compatible statement, rather than adding it to the batch.  
If you want to clear a batch without executing it, invoke the `ExecutionContext.cancel` method.
7. If batch execution was implicit, perform a final, explicit `executeBatch` to ensure that all statements have been executed.

## Example

The following example demonstrates batching of UPDATE statements. The numbers to the right of selected statements correspond to the previously described steps.

```
#sql iterator GetMgr(String);           // Declare positioned iterator
...
{
    GetMgr deptiter;                    // Declare object of GetMgr class
    String mgrnum = null;                // Declare host variable for manager number
    int raise = 400;                    // Declare raise amount
    int currentSalary;                  // Declare current salary
    String url, username, password;     // Declare url, user ID, password
    ...
    TestContext c1 = new TestContext (url, username, password, false); 1
    ExecutionContext ec = new ExecutionContext(); 2
    ec.setBatching(true); 3

    #sql [c1] deptiter =
        {SELECT MGRNO FROM DEPARTMENT};
        // Assign the result table of the SELECT
        // to iterator object deptiter
    #sql {FETCH :deptiter INTO :mgrnum};
        // Retrieve the first manager number
    while (!deptiter.endFetch()) {      // Check whether the FETCH returned a row
        #sql [c1]
            {SELECT SALARY INTO :currentSalary FROM EMPLOYEE
                WHERE EMPNO=:mgrnum};
        #sql [c1, ec] 4
            {UPDATE EMPLOYEE SET SALARY=(currentSalary+raise)
                WHERE EMPNO=:mgrnum};
        #sql {FETCH :deptiter INTO :mgrnum };
        // Fetch the next row
    }
    ec.executeBatch(); 5
    ec.setBatching(false); 6
    #sql [c1] {COMMIT};
    deptiter.close();                // Close the iterator
    c1.close();                       // Close the connection
}
```

The following example demonstrates batching of INSERT statements. Suppose that `ATOMICtbl` is defined like this:

```
CREATE TABLE ATOMICtbl(
    INTCOL INTEGER NOT NULL UNIQUE,
    CHARCOL VARCHAR(10))
```

Also suppose that the table already has a row with the values 2 and "val2". Because of the uniqueness constraint on `INTCOL`, when the following code is executed, the second INSERT statement in the batch fails.



If the target data server is DB2 for z/OS, and this application is customized without `atomicMultiRowInsert` set to `DB2BaseDataSource.YES`, the batch INSERT is non-atomic, so the first set of values is inserted in the table. However, if the application is customized with `atomicMultiRowInsert` set to `DB2BaseDataSource.YES`, the batch INSERT is atomic, so the first set of values is not inserted.

The numbers to the right of selected statements correspond to the previously described steps.

```

...
TestContext ctx = new TestContext (url, username, password, false);
ctx.getExecutionContext().setBatching(true);
try {
    for (int i = 1; i<= 2; ++i) {
        if (i == 1) {
            intVar = 3;
            strVar = "val1";
            {
                if (i == 2) {
                    intVar = 1;
                    strVar = "val2";
                }
            }
            #sql [ctx] {INSERT INTO ATOMICtbl values(:intVar, :strVar)};
        }
        int[] counts = ctx.getExecutionContext().executeBatch();
        for (int i = 0; i<counts.length; ++i) {
            System.out.println(" count[" + i + "]:" + counts[i]);
        }
    }
} catch (SQLException e) {
    System.out.println(" Exception Caught: " + e.getMessage());
    SQLException excp = null;
    if (e instanceof SQLException)
    {
        System.out.println(" SQLCode: " + ((SQLException)e).getErrorCode() + "
        Message: " + e.getMessage() );
        excp = ((SQLException)e).getNextException();
        while ( excp != null ) {
            System.out.println(" SQLCode: " + ((SQLException)excp).getErrorCode() +
            " Message: " + excp.getMessage() );
            excp = excp.getNextException();
        }
    }
}

```

## Data retrieval in SQLJ applications

SQLJ applications use a *result set iterator* to retrieve result sets. Like a cursor, a result set iterator can be non-scrollable or scrollable.

Just as in DB2 applications in other languages, if you want to retrieve a single row from a table in an SQLJ application, you can write a `SELECT INTO` statement with a `WHERE` clause that defines a result table that contains only that row:

```

#sql [myConnCtx] {SELECT DEPTNO INTO :hvdeptno
FROM DEPARTMENT WHERE DEPTNAME="OPERATIONS"};

```

However, most `SELECT` statements that you use create result tables that contain many rows. In DB2 applications in other languages, you use a cursor to select the individual rows from the result table. That cursor can be non-scrollable, which means that when you use it to fetch rows, you move the cursor serially, from the beginning of the result table to the end. Alternatively, the cursor can be scrollable,

which means that when you use it to fetch rows, you can move the cursor forward, backward, or to any row in the result table.

This topic discusses how to use non-scrollable iterators. For information on using scrollable iterators, see "Use scrollable iterators in an SQLJ application".

A result set iterator is a Java object that you use to retrieve rows from a result table. Unlike a cursor, a result set iterator can be passed as a parameter to a method.

The basic steps in using a result set iterator are:

1. Declare the iterator, which results in an iterator class
2. Define an instance of the iterator class.
3. Assign the result table of a SELECT to an instance of the iterator.
4. Retrieve rows.
5. Close the iterator.

There are two types of iterators: *positioned iterators* and *named iterators*. Positioned iterators extend the interface `sqlj.runtime.PositionedIterator`. Positioned iterators identify the columns of a result table by their position in the result table. Named iterators extend the interface `sqlj.runtime.NamedIterator`. Named iterators identify the columns of the result table by result table column names.

## Using a named iterator in an SQLJ application

Use a named iterator to refer to each of the columns in a result table by name.

### About this task

The steps in using a named iterator are:

#### Procedure

1. Declare the iterator.

You declare any result set iterator using an *iterator declaration clause*. This causes an iterator class to be created that has the same name as the iterator. For a named iterator, the iterator declaration clause specifies the following information:

- The name of the iterator
- A list of column names and Java data types
- Information for a Java class declaration, such as whether the iterator is `public` or `static`
- A set of attributes, such as whether the iterator is holdable, or whether its columns can be updated

When you declare a named iterator for a query, you specify names for each of the iterator columns. Those names must match the names of columns in the result table for the query. An iterator column name and a result table column name that differ only in case are considered to be matching names. The named iterator class that results from the iterator declaration clause contains *accessor methods*. There is one accessor method for each column of the iterator. Each accessor method name is the same as the corresponding iterator column name. You use the accessor methods to retrieve data from columns of the result table.

You need to specify Java data types in the iterators that closely match the corresponding DB2 column data types. See "Java, JDBC, and SQL data types" for a list of the best mappings between Java data types and DB2 data types.

You can declare an iterator in a number of ways. However, because a Java class underlies each iterator, you need to ensure that when you declare an iterator, the underlying class obeys Java rules. For example, iterators that contain a *with-clause* must be declared as `public`. Therefore, if an iterator needs to be `public`, it can be declared only where a `public` class is allowed. The following list describes some alternative methods of declaring an iterator:

- As `public`, in a source file by itself

This method lets you use the iterator declaration in other code modules, and provides an iterator that works for all SQLJ applications. In addition, there are no concerns about having other top-level classes or `public` classes in the same source file.

- As a top-level class in a source file that contains other top-level class definitions

Java allows only one `public`, top-level class in a code module. Therefore, if you need to declare the iterator as `public`, such as when the iterator includes a *with-clause*, no other classes in the code module can be declared as `public`.

- As a nested static class within another class

Using this alternative lets you combine the iterator declaration with other class declarations in the same source file, declare the iterator and other classes as `public`, and make the iterator class visible to other code modules or packages. However, when you reference the iterator from outside the nesting class, you must fully-qualify the iterator name with the name of the nesting class.

- As an inner class within another class

When you declare an iterator in this way, you can instantiate it only within an instance of the nesting class. However, you can declare the iterator and other classes in the file as `public`.

You cannot cast a JDBC `ResultSet` to an iterator if the iterator is declared as an inner class. This restriction does not apply to an iterator that is declared as a static nested class. See "Use SQLJ and JDBC in the same application" for more information on casting a `ResultSet` to a iterator.

2. Create an instance of the iterator class.

You declare an object of the named iterator class to retrieve rows from a result table.

3. Assign the result table of a `SELECT` to an instance of the iterator.

To assign the result table of a `SELECT` to an iterator, you use an SQLJ *assignment clause*. The format of the assignment clause for a named iterator is:

```
#sql context-clause iterator-object={select-statement};
```

See "SQLJ assignment-clause" and "SQLJ context-clause" for more information.

4. Retrieve rows.

Do this by invoking accessor methods in a loop. Accessor methods have the same names as the corresponding columns in the iterator, and have no parameters. An accessor method returns the value from the corresponding column of the current row in the result table. Use the `NamedIterator.next()` method to move the cursor forward through the result table.

To test whether you have retrieved all rows, check the value that is returned when you invoke the `next` method. `next` returns a `boolean` with a value of `false` if there is no next row.

5. Close the iterator.

Use the `NamedIterator.close` method to do this.

## Example

The following code demonstrates how to declare and use a named iterator. The numbers to the right of selected statements correspond to the previously-described steps.

```
#sql iterator ByName(String LastName, Date HireDate);           1
// Declare named iterator ByName
{
  ...
  ByName nameiter;           // Declare object of ByName class   2
  #sql [ctxt]
  nameiter={SELECT LASTNAME, HIREDATE FROM EMPLOYEE};          3
// Assign the result table of the SELECT
// to iterator object nameiter
  while (nameiter.next())   // Move the iterator through the result 4
// table and test whether all rows retrieved
  {
    System.out.println( nameiter.LastName() + " was hired on "
      + nameiter.HireDate()); // Use accessor methods LastName and
// HireDate to retrieve column values
  }
  nameiter.close();       // Close the iterator                   5
}
```

Figure 33. Example of using a named iterator

## Using a positioned iterator in an SQLJ application

Use a positioned iterator to refer to columns in a result table by their position in the result set.

### About this task

The steps in using a positioned iterator are:

#### Procedure

1. Declare the iterator.

You declare any result set iterator using an *iterator declaration clause*. This causes an iterator class to be created that has the same name and attributes as the iterator. For a positioned iterator, the iterator declaration clause specifies the following information:

- The name of the iterator
- A list of Java data types
- Information for a Java class declaration, such as whether the iterator is public or static
- A set of attributes, such as whether the iterator is holdable, or whether its columns can be updated

The data type declarations represent columns in the result table and are referred to as columns of the result set iterator. The columns of the result set iterator correspond to the columns of the result table, in left-to-right order. For example, if an iterator declaration clause has two data type declarations, the first data type declaration corresponds to the first column in the result table, and the second data type declaration corresponds to the second column in the result table.

You need to specify Java data types in the iterators that closely match the corresponding DB2 column data types. See "Java, JDBC, and SQL data types" for a list of the best mappings between Java data types and DB2 data types.

You can declare an iterator in a number of ways. However, because a Java class underlies each iterator, you need to ensure that when you declare an iterator, the underlying class obeys Java rules. For example, iterators that contain a *with-clause* must be declared as `public`. Therefore, if an iterator needs to be `public`, it can be declared only where a `public` class is allowed. The following list describes some alternative methods of declaring an iterator:

- As `public`, in a source file by itself

This is the most versatile method of declaring an iterator. This method lets you use the iterator declaration in other code modules, and provides an iterator that works for all SQLJ applications. In addition, there are no concerns about having other top-level classes or `public` classes in the same source file.

- As a top-level class in a source file that contains other top-level class definitions

Java allows only one `public`, top-level class in a code module. Therefore, if you need to declare the iterator as `public`, such as when the iterator includes a *with-clause*, no other classes in the code module can be declared as `public`.

- As a nested static class within another class

Using this alternative lets you combine the iterator declaration with other class declarations in the same source file, declare the iterator and other classes as `public`, and make the iterator class visible from other code modules or packages. However, when you reference the iterator from outside the nesting class, you must fully-qualify the iterator name with the name of the nesting class.

- As an inner class within another class

When you declare an iterator in this way, you can instantiate it only within an instance of the nesting class. However, you can declare the iterator and other classes in the file as `public`.

You cannot cast a JDBC `ResultSet` to an iterator if the iterator is declared as an inner class. This restriction does not apply to an iterator that is declared as a static nested class. See "Use SQLJ and JDBC in the same application" for more information on casting a `ResultSet` to a iterator.

2. Create an instance of the iterator class.

You declare an object of the positioned iterator class to retrieve rows from a result table.

3. Assign the result table of a `SELECT` to an instance of the iterator.

To assign the result table of a `SELECT` to an iterator, you use an SQLJ *assignment clause*. The format of the assignment clause for a positioned iterator is:

```
#sql context-clause iterator-object={select-statement};
```

4. Retrieve rows.

Do this by executing `FETCH` statements in executable clauses in a loop. The `FETCH` statements looks the same as a `FETCH` statements in other languages.

To test whether you have retrieved all rows, invoke the `PositionedIterator.endFetch` method after each `FETCH`. `endFetch` returns a `boolean` with the value `true` if the `FETCH` failed because there are no rows to retrieve.

5. Close the iterator.

Use the `PositionedIterator.close` method to do this.

## Example

The following code demonstrates how to declare and use a positioned iterator. The numbers to the right of selected statements correspond to the previously-described steps.

```
#sql iterator ByPos(String,Date); // Declare positioned iterator ByPos 1
{
    ...
    ByPos positer; // Declare object of ByPos class 2
    String name = null; // Declare host variables
    Date hrdate;
    #sql [ctxt] positer =
        {SELECT LASTNAME, HIREDATE FROM EMPLOYEE}; 3
        // Assign the result table of the SELECT
        // to iterator object positer
    #sql {FETCH :positer INTO :name, :hrdate }; 4
        // Retrieve the first row
    while (!positer.endFetch()) // Check whether the FETCH returned a row
    { System.out.println(name + " was hired in " +
        hrdate);
        #sql {FETCH :positer INTO :name, :hrdate };
        // Fetch the next row
    }
    positer.close(); // Close the iterator 5
}
```

Figure 34. Example of using a positioned iterator

## Multiple open iterators for the same SQL statement in an SQLJ application

With the IBM Data Server Driver for JDBC and SQLJ, your application can have multiple concurrently open iterators for a single SQL statement in an SQLJ application. With this capability, you can perform one operation on a table using one iterator while you perform a different operation on the same table using another iterator.

When you use concurrently open iterators in an application, you should close iterators when you no longer need them to prevent excessive storage consumption in the Java heap.

The following examples demonstrate how to perform the same operations on a table without concurrently open iterators on a single SQL statement and with concurrently open iterators on a single SQL statement. These examples use the following iterator declaration:

```
import java.math.*;
#sql public iterator MultiIter(String EmpNo, BigDecimal Salary);
```

Without the capability for multiple, concurrently open iterators for a single SQL statement, if you want to select employee and salary values for a specific employee number, you need to define a different SQL statement for each employee number, as shown in Figure 35 on page 170.

```

MultiIter iter1 = null;           // Iterator instance for retrieving
                                  // data for first employee
String EmpNo1 = "000100";       // Employee number for first employee
#sql [ctx] iter1 =
    {SELECT EMPNO, SALARY FROM EMPLOYEE WHERE EMPNO = :EmpNo1};
                                  // Assign result table to first iterator
MultiIter iter2 = null;         // Iterator instance for retrieving
                                  // data for second employee
String EmpNo2 = "000200";       // Employee number for second employee
#sql [ctx] iter2 =
    {SELECT EMPNO, SALARY FROM EMPLOYEE WHERE EMPNO = :EmpNo2};
                                  // Assign result table to second iterator

// Process with iter1
// Process with iter2
iter1.close();                   // Close the iterators
iter2.close();

```

*Figure 35. Example of concurrent table operations using iterators with different SQL statements*

Figure 36 demonstrates how you can perform the same operations when you have the capability for multiple, concurrently open iterators for a single SQL statement.

```

...
MultiIter iter1 = openIter("000100"); // Invoke openIter to assign the result table
                                        // (for employee 100) to the first iterator
MultiIter iter2 = openIter("000200"); // Invoke openIter to assign the result
                                        // table to the second iterator
                                        // iter1 stays open when iter2 is opened

// Process with iter1
// Process with iter2
...
iter1.close();                         // Close the iterators
iter2.close();
...
public MultiIter openIter(String EmpNo)
    // Method to assign a result table
    // to an iterator instance
{
    MultiIter iter;
    #sql [ctx] iter =
        {SELECT EMPNO, SALARY FROM EMPLOYEE WHERE EMPNO = :EmpNo};
    return iter;                         // Method returns an iterator instance
}

```

*Figure 36. Example of concurrent table operations using iterators with the same SQL statement*

## Multiple open instances of an iterator in an SQLJ application

Multiple instances of an iterator can be open concurrently in a single SQLJ application. One application for this ability is to open several instances of an iterator that uses host expressions. Each instance can use a different set of host expression values.

The following example shows an application with two concurrently open instances of an iterator.

```

...
ResultSet myFunc(String empid) // Method to open an iterator and get a resultSet
{
    MyIter iter;
    #sql iter = {SELECT * FROM EMPLOYEE WHERE EMPNO = :empid};
    return iter.getResultSet();
}

// An application can call this method to get a resultSet for each
// employee ID. The application can process each resultSet separately.
...
ResultSet rs1 = myFunc("000100"); // Get employee record for employee ID 000100
...
ResultSet rs2 = myFunc("000200"); // Get employee record for employee ID 000200

```

Figure 37. Example of opening more than one instance of an iterator in a single application

As with any other iterator, you need to remember to close this iterator after the last time you use it to prevent excessive storage consumption.

### Using scrollable iterators in an SQLJ application

In addition to moving forward, one row at a time, through a result table, you might want to move backward or go directly to a specific row. The IBM Data Server Driver for JDBC and SQLJ provides this capability.

#### About this task

An iterator in which you can move forward, backward, or to a specific row is called a *scrollable iterator*. A scrollable iterator in SQLJ is equivalent to the result table of a database cursor that is declared as SCROLL.

Like a scrollable cursor, a scrollable iterator can be *insensitive* or *sensitive*. A sensitive scrollable iterator can be *static* or *dynamic*. Insensitive means that changes to the underlying table after the iterator is opened are not visible to the iterator. Insensitive iterators are read-only. Sensitive means that changes that the iterator or other processes make to the underlying table are visible to the iterator. Asensitive means that if the cursor is a read-only cursor, it behaves as an insensitive cursor. If it is not a read-only cursor, it behaves as a sensitive cursor.

If a scrollable iterator is static, the size of the result table and the order of the rows in the result table do not change after the iterator is opened. This means that you cannot insert into result tables, and if you delete a row of a result table, a delete hole occurs. If you update a row of the result table so that the row no longer qualifies for the result table, an update hole occurs. Fetching from a hole results in an SQLException.

If a scrollable iterator is dynamic, the size of the result table and the order of the rows in the result table can change after the iterator is opened. Rows that are inserted or deleted with INSERT and DELETE statements that are executed by the same application process are immediately visible. Rows that are inserted or deleted with INSERT and DELETE statements that are executed by other application processes are visible after the changes are committed.

**Important:** DB2 Database for Linux, UNIX, and Windows servers do not support dynamic scrollable cursors. You can use dynamic scrollable iterators in your SQLJ applications only if those applications access data on DB2 for z/OS servers, at Version 9 or later.

**Important:**



To create and use a scrollable iterator, you need to follow these steps:

## Procedure

1. Specify an iterator declaration clause that includes the following clauses:
  - implements `sqlj.runtime.Scrollable`  
This indicates that the iterator is scrollable.
  - with (`sensitivity=INSENSITIVE|SENSITIVE|ASENSITIVE`) or with (`sensitivity=SENSITIVE, dynamic=true|false`)  
`sensitivity=INSENSITIVE|SENSITIVE|ASENSITIVE` indicates whether update or delete operations on the underlying table can be visible to the iterator. The default sensitivity is `INSENSITIVE`.  
`dynamic=true|false` indicates whether the size of the result table or the order of the rows in the result table can change after the iterator is opened. The default value of `dynamic` is `false`.

The iterator can be a named or positioned iterator.

**Example:** The following iterator declaration clause declares a positioned, sensitive, dynamic, scrollable iterator:

```
#sql public iterator ByPos
  implements sqlj.runtime.Scrollable
  with (sensitivity=SENSITIVE, dynamic=true) (String);
```

**Example:** The following iterator declaration clause declares a named, insensitive, scrollable iterator:

```
#sql public iterator ByName
  implements sqlj.runtime.Scrollable
  with (sensitivity=INSENSITIVE) (String EmpNo);
```

**Restriction:** You cannot use a scrollable iterator to select columns with the following data types from a table on a DB2 Database for Linux, UNIX, and Windows server:

- LONG VARCHAR
  - LONG VARGRAPHIC
  - BLOB
  - CLOB
  - XML
  - A distinct type that is based on any of the previous data types in this list
  - A structured type
2. Create an iterator object, which is an instance of your iterator class.
  3. If you want to give the SQLJ runtime environment a hint about the initial fetch direction, use the `setFetchDirection(int direction)` method. `direction` can be `FETCH_FORWARD` or `FETCH_REVERSE`. If you do not invoke `setFetchDirection`, the fetch direction is `FETCH_FORWARD`.
  4. For each row that you want to access:
    - For a named iterator, perform the following steps:
      - a. Position the cursor using one of the methods listed in the following table.

Table 26. `sqlj.runtime.Scrollable` methods for positioning a scrollable cursor

Method	Positions the cursor
<code>first</code> <sup>1</sup>	On the first row of the result table
<code>last</code> <sup>1</sup>	On the last row of the result table
<code>previous</code> <sup>1,2</sup>	On the previous row of the result table
<code>next</code>	On the next row of the result table

Table 26. *sqlj.runtime.Scrollable* methods for positioning a scrollable cursor (continued)

Method	Positions the cursor
<code>absolute(int n)</code> <sup>1,3</sup>	If $n > 0$ , on row $n$ of the result table. If $n < 0$ , and $m$ is the number of rows in the result table, on row $m+n+1$ of the result table.
<code>relative(int n)</code> <sup>1,4</sup>	If $n > 0$ , on the row that is $n$ rows after the current row. If $n < 0$ , on the row that is $n$ rows before the current row. If $n=0$ , on the current row.
<code>afterLast</code> <sup>1</sup>	After the last row in the result table
<code>beforeFirst</code> <sup>1</sup>	Before the first row in the result table

**Notes:**

1. This method does not apply to connections to IBM Informix.
2. If the cursor is after the last row of the result table, this method positions the cursor on the last row.
3. If the absolute value of  $n$  is greater than the number of rows in the result table, this method positions the cursor after the last row if  $n$  is positive, or before the first row if  $n$  is negative.
4. Suppose that  $m$  is the number of rows in the result table and  $x$  is the current row number in the result table. If  $n > 0$  and  $x+n > m$ , the iterator is positioned after the last row. If  $n < 0$  and  $x+n < 1$ , the iterator is positioned before the first row.

- b. If you need to know the current cursor position, use the `getRow`, `isFirst`, `isLast`, `isBeforeFirst`, or `isAfterLast` method to obtain this information. If you need to know the current fetch direction, invoke the `getFetchDirection` method.
- c. Use accessor methods to retrieve the current row of the result table.
- d. If update or delete operations by the iterator or by other means are visible in the result table, invoke the `getWarnings` method to check whether the current row is a hole.

For a positioned iterator, perform the following steps:

- a. Use a `FETCH` statement with a fetch orientation clause to position the iterator and retrieve the current row of the result table. Table 27 lists the clauses that you can use to position the cursor.

Table 27. *FETCH* clauses for positioning a scrollable cursor

Method	Positions the cursor
<code>FIRST</code> <sup>1</sup>	On the first row of the result table
<code>LAST</code> <sup>1</sup>	On the last row of the result table
<code>PRIOR</code> <sup>1,2</sup>	On the previous row of the result table
<code>NEXT</code>	On the next row of the result table
<code>ABSOLUTE(n)</code> <sup>1,3</sup>	If $n > 0$ , on row $n$ of the result table. If $n < 0$ , and $m$ is the number of rows in the result table, on row $m+n+1$ of the result table.
<code>RELATIVE(n)</code> <sup>1,4</sup>	If $n > 0$ , on the row that is $n$ rows after the current row. If $n < 0$ , on the row that is $n$ rows before the current row. If $n=0$ , on the current row.
<code>AFTER</code> <sup>1,5</sup>	After the last row in the result table
<code>BEFORE</code> <sup>1,5</sup>	Before the first row in the result table

Table 27. *FETCH* clauses for positioning a scrollable cursor (continued)

Method	Positions the cursor
<b>Notes:</b>	
1.	This value is not supported for connections to IBM Informix
2.	If the cursor is after the last row of the result table, this method positions the cursor on the last row.
3.	If the absolute value of $n$ is greater than the number of rows in the result table, this method positions the cursor after the last row if $n$ is positive, or before the first row if $n$ is negative.
4.	Suppose that $m$ is the number of rows in the result table and $x$ is the current row number in the result table. If $n > 0$ and $x + n > m$ , the iterator is positioned after the last row. If $n < 0$ and $x + n < 1$ , the iterator is positioned before the first row.
5.	Values are not assigned to host expressions.
	b. If update or delete operations by the iterator or by other means are visible in the result table, invoke the <code>getWarnings</code> method to check whether the current row is a hole.
5.	Invoke the <code>close</code> method to close the iterator.

### Example

The following code demonstrates how to use a named iterator to retrieve the employee number and last name from all rows from the employee table in reverse order. The numbers to the right of selected statements correspond to the previously-described steps.

```
#sql context Ctx;           // Create connection context class Ctx
#sql iterator ScrollIter implements sqlj.runtime.Scrollable 1
    (String EmpNo, String LastName);
{
    ...
    Ctx ctxt =
        new Ctx("jdbc:db2://sysmvs1.st1.ibm.com:5021/NEWYORK",
            userid,password,false); // Create connection context object ctxt
                                   // for the connection to NEWYORK
    ScrollIter scliter; 2
    #sql [ctxt]
        scliter={SELECT EMPNO, LASTNAME FROM EMPLOYEE};
    scliter.afterLast();
    while (scliter.previous() 4a
    {
        System.out.println(scliter.EmpNo() + " " 4c
            + scliter.LastName());
    }
    scliter.close(); 5
}
```

## Calling stored procedures in SQLJ applications

To call a stored procedure, you use an executable clause that contains an SQL CALL statement.

### About this task

You can execute the CALL statement with host identifier parameters. You can execute the CALL statement with literal parameters only if the DB2 server on which the CALL statement runs supports execution of the CALL statement dynamically.

The basic steps in calling a stored procedure are:

### Procedure

1. Assign values to input (IN or INOUT) parameters.
2. Call the stored procedure.
3. Process output (OUT or INOUT) parameters.
4. If the stored procedure returns multiple result sets, retrieve those result sets.

### Example

The following code illustrates calling a stored procedure that has three input parameters and three output parameters. The numbers to the right of selected statements correspond to the previously-described steps.

```
String FirstName="TOM";           // Input parameters           1
String LastName="NARISINST";
String Address="IBM";
int CustNo;                       // Output parameters
String Mark;
String MarkErrorText;
...
#sql [myConnCtx] {CALL ADD_CUSTOMER(:IN FirstName,           2
                                   :IN LastName,
                                   :IN Address,
                                   :OUT CustNo,
                                   :OUT Mark,
                                   :OUT MarkErrorText)};
                                   // Call the stored procedure
System.out.println("Output parameters from ADD_CUSTOMER call: ");
System.out.println("Customer number for " + LastName + ": " + CustNo); 3
System.out.println(Mark);
If (MarkErrorText != null)
    System.out.println(" Error messages:" + MarkErrorText);
```

Figure 38. Example of calling a stored procedure in an SQLJ application

## Using named parameters in CALL statements in SQLJ applications

You can use named parameters to map host variable names in a CALL statement to the parameter names in the stored procedure definition.

### About this task

With named parameters, you do not need to specify parameters in the CALL statement in the same order that they appear in the stored procedure definition. In addition, you do not need to specify all parameters in the CALL statement. Unspecified parameters take the default values that are specified in the stored procedure definition.

To use named parameters with CALL statements, follow these steps.

### Procedure

1. In the CALL statement, assign values to IN or INOUT host variables.

The named parameters point to the host variables. The rules for naming of named parameters and assignment to named parameters must follow the rules for named parameters in SQL CALL statements. You can explicitly assign the default value or the null value to a named parameter by specifying the DEFAULT keyword or the NULL keyword. For parameters for which a default

value is specified in the CREATE PROCEDURE statement, you can implicitly assign the default values to named parameters by omitting those parameters from the CALL statement. You can omit parameters only if all of the omitted parameters have default values in the stored procedure definition.

You cannot mix named parameters and unnamed parameters in the same CALL statement.

2. Process output (OUT or INOUT) parameters.
3. If the stored procedure returns multiple result sets, retrieve those result sets.

## Example

The following code illustrates calling a stored procedure that has the following definition:

```
CREATE PROCEDURE SALS (  
    OUT retcode INTEGER,  
    IN lowsai DOUBLE,  
    IN medsal DOUBLE,  
    IN highsai DOUBLE DEFAULT 100000,  
    IN department CHAR(3) DEFAULT '---')  
SPECIFIC JDBC_SALS  
DYNAMIC RESULT SETS 0  
DETERMINISTIC  
LANGUAGE JAVA  
PARAMETER STYLE JAVA  
NO DBINFO  
FENCED  
THREADSAFE  
MODIFIES SQL DATA  
PROGRAM TYPE SUB  
EXTERNAL NAME 'MYJAR:MyClass.sals'
```

The input parameters in the CALL statement are represented by named parameters. The third and fourth parameters are called with the default values for the stored procedure. The numbers to the right of selected statements correspond to the previously-described steps.

```
double hvLowSal=10000;           // Host variables for input parameters  
double hvMedSal=50000;  
int hvRetCode;                 // Host variable for output parameter  
...  
#sql [myConnCtx] {CALL SALS(retcode=>:OUT hvRetCode,           1  
    lowsai=>:IN hvLowSal,  
    medsal=>:IN hvMedSal,  
    highsai=>DEFAULT)};  
                                // Call the stored procedure.  
                                // Implicitly use the default  
                                // value for the last parameter  
                                // by omitting it.  
System.out.println("Return code from SALS call: " + hvRetCode); 2
```

## Retrieving data from cursor output parameters in SQLJ applications

DB2 Database for Linux, UNIX, and Windows stored procedures can have OUT parameters of the cursor type. To retrieve data from those parameters in SQLJ applications, you use iterators or ResultSet objects.

### About this task

To retrieve data from cursor variables, follow these steps.

## Procedure

1. Define an iterator or `ResultSet` object for each OUT parameter that has the `CURSOR` data type in the stored procedure definition.  
Iterators for retrieving cursor OUT parameters can be named or positioned.
2. Assign values to input parameters.
3. Call the stored procedure.
4. Retrieve rows from the cursor parameters.
  - If you declare a positioned iterator for the cursor parameter, use `FETCH` statements to retrieve the data.
  - If you declare a named iterator for the cursor parameter, use `NamedIterator` methods to retrieve the data.
  - If you define a `ResultSet` object for the cursor parameter, use `ResultSet` methods to position the cursor and retrieve values from result set rows.
5. If the stored procedure returns multiple result sets by opening cursors that are defined as `WITH RETURN`, retrieve those result sets.

A single stored procedure can return data through multiple result sets as well as `CURSOR` parameters.

## Example

A cursor data type and a stored procedure have the following definitions:

```
CREATE TYPE myRowType AS ROW (name VARCHAR(128))
CREATE TYPE myCursorType AS myRowType CURSOR
CREATE PROCEDURE MYPROC(IN pempNo VARCHAR(6), OUT pcv1 myCursorType)
  RESULT SETS 0
  LANGUAGE SQL
  BEGIN
    SET pcv1 = CURSOR FOR SELECT name FROM employee WHERE empNo = pempNo;
    OPEN pcv1;
  END
```

The following code calls stored procedure `MYPROC` and uses a positioned iterator to retrieve data from cursor `pcv1`. The numbers to the right of selected statements correspond to the previously-described steps.

```
#sql iterator iter (String);          // Declare a positioned iterator
...
Iter iter = null;                    // Output parameter           1
String hvPempNo="000500";           // Input parameter       2
#sql [ctx] {CALL MYPROC (:IN hvPempNo, :OUT iter)};                // Call the stored procedure 3

String hvEmpName = null;
while (true) {                       // Retrieve rows from the result set
  #sql { FETCH :iter into :hvName };  // Retrieve rows from the result set 4
  if (iter.endFetch()) break;
  System.out.println("Employee name for " + hvPempNo
    + ": " + hvEmpName);
}
```

The following code calls stored procedure `MYPROC` and uses a `ResultSet` object to retrieve data from cursor `pcv1`. The numbers to the right of selected statements correspond to the previously-described steps.

```
...
ResultSet rs = null;                 // Output parameter           1
String hvPempNo="000500";           // Input parameter       2
#sql [ctx] {CALL MYPROC (:IN hvPempNo, :OUT rs)};                // Call the stored procedure 3

String hvEmpName = null;
```

```

while (rs.next()) {
    hvEmpName=rs.getString(1);
    System.out.println("Employee name for " + hvPempNo
        + ": " + hvEmpName);
}

```

4

## Retrieving multiple result sets from a stored procedure in an SQLJ application

Some stored procedures return one or more result sets to the calling program by including the `DYNAMIC RESULT SETS n` clause in the definition, with  $n > 0$ , and opening cursors that are defined with the `WITH RETURN` clause. The calling program needs to retrieve the contents of those result sets.

To retrieve the rows from those result sets, you execute these steps:

1. Acquire an execution context for retrieving the result set from the stored procedure.
2. Associate the execution context with the `CALL` statement for the stored procedure.  
Do not use this execution context for any other purpose until you have retrieved and processed the last result set.
3. For each result set:
  - a. Use the `ExecutionContext` method `getNextResultSet` to retrieve the result set.
  - b. If you do not know the contents of the result set, use `ResultSetMetaData` methods to retrieve this information.
  - c. Use an SQLJ result set iterator or JDBC `ResultSet` to retrieve the rows from the result set.

Result sets are returned to the calling program in the same order that their cursors are opened in the stored procedure. When there are no more result sets to retrieve, `getNextResultSet` returns a null value.

`getNextResultSet` has two forms:

```

getNextResultSet();
getNextResultSet(int current);

```

When you invoke the first form of `getNextResultSet`, SQLJ closes the currently-open result set and advances to the next result set. When you invoke the second form of `getNextResultSet`, the value of `current` indicates what SQLJ does with the currently-open result set before it advances to the next result set:

### **java.sql.Statement.CLOSE\_CURRENT\_RESULT**

Specifies that the current `ResultSet` object is closed when the next `ResultSet` object is returned.

### **java.sql.Statement.KEEP\_CURRENT\_RESULT**

Specifies that the current `ResultSet` object stays open when the next `ResultSet` object is returned.

### **java.sql.Statement.CLOSE\_ALL\_RESULTS**

Specifies that all open `ResultSet` objects are closed when the next `ResultSet` object is returned.

The following code calls a stored procedure that returns multiple result sets. For this example, it is assumed that the caller does not know the number of result sets to be returned or the contents of those result sets. It is also assumed that `autoCommit` is false. The numbers to the right of selected statements correspond to

the previously-described steps.

```
ExecutionContext execCtx=myConnCtx.getExecutionContext();
#sql [myConnCtx, execCtx] {CALL MULTRSSP()};
// MULTRSSP returns multiple result sets
ResultSet rs;
while ((rs = execCtx.getNextResultSet()) != null)
{
    ResultSetMetaData rsmeta=rs.getMetaData();
    int numcols=rsmeta.getColumnCount();
    while (rs.next())
    {
        for (int i=1; i<=numcols; i++)
        {
            String colval=rs.getString(i);
            System.out.println("Column " + i + "value is " + colval);
        }
    }
}
```

1  
2

3a

3b

3c

Figure 39. Retrieving result sets from a stored procedure

## LOBs in SQLJ applications with the IBM Data Server Driver for JDBC and SQLJ

With the IBM Data Server Driver for JDBC and SQLJ, you can retrieve LOB data into Clob or Blob host expressions or update CLOB, BLOB, or DBCLOB columns from Clob or Blob host expressions. You can also declare iterators with Clob or Blob data types to retrieve data from CLOB, BLOB, or DBCLOB columns.

**Retrieving or updating LOB data:** To retrieve data from a BLOB column, declare an iterator that includes a data type of Blob or byte[]. To retrieve data from a CLOB or DBCLOB column, declare an iterator in which the corresponding column has a Clob data type.

To update data in a BLOB column, use a host expression with data type Blob. To update data in a CLOB or DBCLOB column, use a host expression with data type Clob.

**Progressive streaming or LOB locators:** In SQLJ applications, you can use progressive streaming, also known as dynamic data format, or LOB locators in the same way that you use them in JDBC applications.

### Java data types for retrieving or updating LOB column data in SQLJ applications

When the deferPrepares property is set to true, and the IBM Data Server Driver for JDBC and SQLJ processes an uncustomized SQLJ statement that includes host expressions, the driver might need to do extra processing to determine data types. This extra processing can impact performance.

When the JDBC driver cannot immediately determine the data type of a parameter that is used with a LOB column, you need to choose a parameter data type that is compatible with the LOB data type.

### Input parameters for BLOB columns

For input parameters for BLOB columns, you can use either of the following techniques:

- Use a java.sql.Blob input variable, which is an exact match for a BLOB column:



```
java.sql.Blob blobData;
#sql {CALL STORPROC(:IN blobData)};
```

Before you can use a `java.sql.Blob` input variable, you need to create a `java.sql.Blob` object, and then populate that object.

- Use an input parameter of type of `sqlj.runtime.BinaryStream`. A `sqlj.runtime.BinaryStream` object is compatible with a BLOB data type. For example:

```
java.io.ByteArrayInputStream byteStream =
    new java.io.ByteArrayInputStream(byteData);
int numBytes = byteData.length;
sqlj.runtime.BinaryStream binStream =
    new sqlj.runtime.BinaryStream(byteStream, numBytes);
#sql {CALL STORPROC(:IN binStream)};
```

You cannot use this technique for INOUT parameters.

## Output parameters for BLOB columns

For output or INOUT parameters for BLOB columns, you can use the following technique:

- Declare the output parameter or INOUT variable with a `java.sql.Blob` data type:

```
java.sql.Blob blobData = null;
#sql CALL STORPROC (:OUT blobData)};

java.sql.Blob blobData = null;
#sql CALL STORPROC (:INOUT blobData)};
```

## Input parameters for CLOB columns

For input parameters for CLOB columns, you can use one of the following techniques:

- Use a `java.sql.Clob` input variable, which is an exact match for a CLOB column:
 

```
#sql CALL STORPROC(:IN clobData)};
```

Before you can use a `java.sql.Clob` input variable, you need to create a `java.sql.Clob` object, and then populate that object.

- Use one of the following types of stream IN parameters:

- A `sqlj.runtime.CharacterStream` input parameter:

```
java.lang.String charData;
java.io.StringReader reader = new java.io.StringReader(charData);
sqlj.runtime.CharacterStream charStream =
    new sqlj.runtime.CharacterStream (reader, charData.length);
#sql {CALL STORPROC(:IN charStream)};
```

- A `sqlj.runtime.UnicodeStream` parameter, for Unicode UTF-16 data:

```
byte[] charDataBytes = charData.getBytes("UnicodeBigUnmarked");
java.io.ByteArrayInputStream byteStream =
    new java.io.ByteArrayInputStream(charDataBytes);
sqlj.runtime.UnicodeStream uniStream =
    new sqlj.runtime.UnicodeStream(byteStream, charDataBytes.length );
#sql {CALL STORPROC(:IN uniStream)};
```

- A `sqlj.runtime.AsciiStream` parameter, for ASCII data:

```
byte[] charDataBytes = charData.getBytes("US-ASCII");
java.io.ByteArrayInputStream byteStream =
    new java.io.ByteArrayInputStream (charDataBytes);
sqlj.runtime.AsciiStream asciiStream =
    new sqlj.runtime.AsciiStream (byteStream, charDataBytes.length);
#sql {CALL STORPROC(:IN asciiStream)};
```

For these calls, you need to specify the exact length of the input data. You cannot use this technique for INOUT parameters.

- Use a `java.lang.String` input parameter:

```
java.lang.String charData;  
#sql {CALL STORPROC(:IN charData)};
```

### Output parameters for CLOB columns

For output or INOUT parameters for CLOB columns, you can use one of the following techniques:

- Use a `java.sql.Clob` output variable, which is an exact match for a CLOB column:

```
java.sql.Clob clobData = null;  
#sql CALL STORPROC(:OUT clobData)};
```

- Use a `java.lang.String` output variable:

```
java.lang.String charData = null;  
#sql CALL STORPROC(:OUT charData)};
```

This technique should be used only if you know that the length of the retrieved data is less than or equal to 32KB. Otherwise, the data is truncated.

### Output parameters for DBCLOB columns

DBCLOB output or INOUT parameters for stored procedures are not supported.

## SQLJ and JDBC in the same application

You can combine SQLJ clauses and JDBC calls in a single program.

To do this effectively, you need to be able to do the following things:

- Use a JDBC Connection to build an SQLJ ConnectionContext, or obtain a JDBC Connection from an SQLJ ConnectionContext.
- Use an SQLJ iterator to retrieve data from a JDBC ResultSet or generate a JDBC ResultSet from an SQLJ iterator.

*Building an SQLJ ConnectionContext from a JDBC Connection:* To do that:

1. Execute an SQLJ connection declaration clause to create a ConnectionContext class.
2. Load the driver or obtain a DataSource instance.
3. Invoke the SQLJ DriverManager.getConnection or DataSource.getConnection method to obtain a JDBC Connection.
4. Invoke the ConnectionContext constructor with the Connection as its argument to create the ConnectionContext object.

*Obtaining a JDBC Connection from an SQLJ ConnectionContext:* To do this,

1. Execute an SQLJ connection declaration clause to create a ConnectionContext class.
2. Load the driver or obtain a DataSource instance.
3. Invoke the ConnectionContext constructor with the URL of the driver and any other necessary parameters as its arguments to create the ConnectionContext object.
4. Invoke the JDBC ConnectionContext.getConnection method to create the JDBC Connection object.

See "Connect to a data source using SQLJ" for more information on SQLJ connections.

*Retrieving JDBC result sets using SQLJ iterators:* Use the *iterator conversion statement* to manipulate a JDBC result set as an SQLJ iterator. The general form of an iterator conversion statement is:

```
#sql iterator={CAST :result-set};
```

Before you can successfully cast a result set to an iterator, the iterator must conform to the following rules:

- The iterator must be declared as public.
- If the iterator is a positioned iterator, the number of columns in the result set must match the number of columns in the iterator. In addition, the data type of each column in the result set must match the data type of the corresponding column in the iterator.
- If the iterator is a named iterator, the name of each accessor method must match the name of a column in the result set. In addition, the data type of the object that an accessor method returns must match the data type of the corresponding column in the result set.

The code in Figure 40 builds and executes a query using a JDBC call, executes an iterator conversion statement to convert the JDBC result set to an SQLJ iterator, and retrieves rows from the result table using the iterator.

```
#sql public iterator ByName(String LastName, Date HireDate); 1
public void HireDates(ConnectionContext connCtx, String whereClause)
{
    ByName nameiter;          // Declare object of ByName class
    Connection conn=connCtx.getConnection();
                               // Create JDBC connection
    Statement stmt = conn.createStatement(); 2
    String query = "SELECT LASTNAME, HIREDATE FROM EMPLOYEE";
    query+=whereClause; // Build the query
    ResultSet rs = stmt.executeQuery(query); 3
    #sql [connCtx] nameiter = {CAST :rs}; 4
    while (nameiter.next())
    {
        System.out.println( nameiter.LastName() + " was hired on "
            + nameiter.HireDate());
    }
    nameiter.close(); 5
    stmt.close();
}
```

Figure 40. Converting a JDBC result set to an SQLJ iterator

Notes to Figure 40:

Note	Description
<b>1</b>	This SQLJ clause creates the named iterator class <code>ByName</code> , which has accessor methods <code>LastName()</code> and <code>HireDate()</code> that return the data from result table columns <code>LASTNAME</code> and <code>HIREDATE</code> .
<b>2</b>	This statement and the following two statements build and prepare a query for dynamic execution using JDBC.
<b>3</b>	This JDBC statement executes the <code>SELECT</code> statement and assigns the result table to result set <code>rs</code> .

**Note**      **Description**

- 4**      This iterator conversion clause converts the JDBC ResultSet rs to SQLJ iterator nameiter, and the following statements use nameiter to retrieve values from the result table.
- 5**      The nameiter.close() method closes the SQLJ iterator and JDBC ResultSet rs.

*Generating JDBC ResultSets from SQLJ iterators:* Use the getResultSet method to generate a JDBC ResultSet from an SQLJ iterator. Every SQLJ iterator has a getResultSet method. After you access the ResultSet that underlies an iterator, you need to fetch rows using only the ResultSet.

The code in Figure 41 generates a positioned iterator for a query, converts the iterator to a result set, and uses JDBC methods to fetch rows from the table.

```
#sql iterator EmpIter(String, java.sql.Date);
{
...
  EmpIter iter=null;
  #sql [connCtx] iter=
    {SELECT LASTNAME, HIREDATE FROM EMPLOYEE};
  ResultSet rs=iter.getResultSet();
  while (rs.next())
  { System.out.println(rs.getString(1) + " was hired in " +
    rs.getDate(2));
  }
  rs.close();
}
```

Figure 41. Converting an SQLJ iterator to a JDBC ResultSet

Notes to Figure 41:

**Note**      **Description**

- 1**      This SQLJ clause executes the SELECT statement, constructs an iterator object that contains the result table for the SELECT statement, and assigns the iterator object to variable iter.
- 2**      The getResultSet() method accesses the ResultSet that underlies iterator iter.
- 3**      The JDBC getString() and getDate() methods retrieve values from the ResultSet. The next() method moves the cursor to the next row in the ResultSet.
- 4**      The rs.close() method closes the SQLJ iterator as well as the ResultSet.

*Rules and restrictions for using JDBC ResultSets in SQLJ applications:* When you write SQLJ applications that include JDBC result sets, observe the following rules and restrictions:

- You cannot cast a ResultSet to an SQLJ iterator if the ResultSet and the iterator have different holdability attributes.  
A JDBC ResultSet or an SQLJ iterator can remain open after a COMMIT operation. For a JDBC ResultSet, this characteristic is controlled by the IBM Data Server Driver for JDBC and SQLJ property resultSetHoldability. For an SQLJ iterator, this characteristic is controlled by the with holdability parameter of the iterator declaration. Casting a ResultSet that has holdability to an SQLJ iterator that does not, or casting a ResultSet that does not have holdability to an SQLJ iterator that does, is not supported.
- Close the iterator or the underlying ResultSet object as soon as the program no longer uses the iterator or ResultSet, and before the end of the program.

Closing the iterator also closes the ResultSet object. Closing the ResultSet object also closes the iterator object. In general, it is best to close the object that is used last.

- For the IBM Data Server Driver for JDBC and SQLJ, which supports scrollable iterators and scrollable and updatable ResultSet objects, the following restrictions apply:
  - Scrollable iterators have the same restrictions as their underlying JDBC ResultSet objects.
  - You cannot cast a JDBC ResultSet that is not updatable to an SQLJ iterator that is updatable.

## Controlling the execution of SQL statements in SQLJ

You can use selected methods of the SQLJ ExecutionContext class to control or monitor the execution of SQL statements.

### About this task

To use ExecutionContext methods, follow these steps:

### Procedure

1. Acquire the default execution context from the connection context.

There are two ways to acquire an execution context:

- Acquire the default execution context from the connection context. For example:

```
ExecutionContext execCtx = connCtx.getExecutionContext();
```

- Create a new execution context by invoking the constructor for ExecutionContext. For example:

```
ExecutionContext execCtx=new ExecutionContext();
```

2. Associate the execution context with an SQL statement.

To do that, specify an execution context after the connection context in the execution clause that contains the SQL statement.

3. Invoke ExecutionContext methods.

Some ExecutionContext methods are applicable before the associated SQL statement is executed, and some are applicable only after their associated SQL statement is executed.

For example, you can use method `getUpdateCount` to count the number of rows that are deleted by a DELETE statement after you execute the DELETE statement.

### Example

The following code demonstrates how to acquire an execution context, and then use the `getUpdateCount` method on that execution context to determine the number of rows that were deleted by a DELETE statement. The numbers to the right of selected statements correspond to the previously-described steps.

```
ExecutionContext execCtx=new ExecutionContext();  
#sql [connCtx, execCtx] {DELETE FROM EMPLOYEE WHERE SALARY > 10000};  
System.out.println("Deleted " + execCtx.getUpdateCount() + " rows");
```

1  
2  
3

## ROWIDs in SQLJ with the IBM Data Server Driver for JDBC and SQLJ

DB2 for z/OS and DB2 for i support the ROWID data type for a column in a table. A ROWID is a value that uniquely identifies a row in a table.

Although IBM Informix also supports rowids, those rowids have the INTEGER data type. You can select an IBM Informix rowid column into a variable with a four-byte integer data type.

If you use columns with the ROWID data type in SQLJ programs, you need to customize those programs.

JDBC 4.0 includes interface `java.sql.RowId` that you can use in iterators and in CALL statement parameters. If you do not have JDBC 4.0, you can use the IBM Data Server Driver for JDBC and SQLJ-only class `com.ibm.db2.jcc.DB2RowID`. For an iterator, you can also use the `byte[]` object type to retrieve ROWID values.

The following code shows an example of an iterator that is used to select values from a ROWID column:

```
#sql iterator PosIter(int,String,java.sql.RowId);
                                // Declare positioned iterator
                                // for retrieving ITEM_ID (INTEGER),
                                // ITEM_FORMAT (VARCHAR), and ITEM_ROWID (ROWID)
                                // values from table ROWIDTAB
{
    PosIter positrowid;          // Declare object of PosIter class
    java.sql.RowId rowid = null;
    int id = 0;
    String i_fmt = null;

                                // Declare host expressions
#sql [ctxt] positrowid =
    {SELECT ITEM_ID, ITEM_FORMAT, ITEM_ROWID FROM ROWIDTAB
     WHERE ITEM_ID=3};
                                // Assign the result table of the SELECT
                                // to iterator object positrowid
#sql {FETCH :positrowid INTO :id, :i_fmt, :rowid};
                                // Retrieve the first row
while (!positrowid.endFetch())
                                // Check whether the FETCH returned a row
{System.out.println("Item ID " + id + " Item format " +
    i_fmt + " Item ROWID ");
    MyUtilities.printBytes(rowid.getBytes());
                                // Use the getBytes method to
                                // convert the value to bytes for printing.
                                // Call a user-defined method called
                                // printBytes (not shown) to print
                                // the value.
    #sql {FETCH :positrowid INTO :id, :i_fmt, :rowid};
                                // Retrieve the next row
}
    positrowid.close();        // Close the iterator
}
```

Figure 42. Example of using an iterator to retrieve ROWID values

The following code shows an example of calling a stored procedure that takes three ROWID parameters: an IN parameter, an OUT parameter, and an INOUT parameter.

```

java.sql.RowId in_rowid = rowid;
java.sql.RowId out_rowid = null;
java.sql.RowId inout_rowid = rowid;
                                // Declare an IN, OUT, and
                                // INOUT ROWID parameter
...
#sql [myConnCtx] {CALL SP_ROWID(:IN in_rowid,
                                :OUT out_rowid,
                                :INOUT inout_rowid)};
                                // Call the stored procedure
System.out.println("Parameter values from SP_ROWID call: ");
System.out.println("OUT parameter value ");
MyUtilities.printBytes(out_rowid.getBytes());
                                // Use the getBytes method to
                                // convert the value to bytes for printing
                                // Call a user-defined method called
                                // printBytes (not shown) to print
                                // the value.
System.out.println("INOUT parameter value ");
MyUtilities.printBytes(inout_rowid.getBytes());

```

Figure 43. Example of calling a stored procedure with a ROWID parameter

## TIMESTAMP WITH TIME ZONE values in SQLJ applications

DB2 for z/OS supports table columns with the `TIMESTAMP WITH TIME ZONE` data type. IBM Data Server Driver for JDBC and SQLJ supports update into and retrieval from a column with the `TIMESTAMP WITH TIME ZONE` data type in SQLJ programs.

When you update or retrieve a `TIMESTAMP WITH TIME ZONE` value, or call a stored procedure with a `TIMESTAMP WITH TIME ZONE` parameter, you need to use host variables that are `com.ibm.db2.jcc.DBTimestamp` objects to retain the time zone information. If you use `java.sql.Timestamp` objects to pass `TIMESTAMP WITH TIME ZONE` values to and from the data server, you lose the time zone information.

Because the `com.ibm.db2.jcc.DBTimestamp` class is a IBM Data Server Driver for JDBC and SQLJ-only class, if you run an uncustomized SQLJ application that uses `com.ibm.db2.jcc.DBTimestamp` objects, the application receives an `SQLException`.

### Examples

Suppose that table `TSTABLE` has a single column, `TSCOL`, which has data type `TIMESTAMP WITH TIME ZONE`. The following code assigns a timestamp value with a time zone to the column, and retrieves the value from the column.

```

#sql iterator TSIter(com.ibm.db2.jcc.DBTimestamp TSVar);
{
...
java.util.TimeZone esttz = java.util.TimeZone.getTimeZone("EST");
                                // Set the time zone to GMT-5
java.util.Calendar estcal= java.util.Calendar.getInstance(esttz);
                                // Create a calendar instance
                                // with the EST time zone
java.sql.Timestamp ts =
java.sql.Timestamp.valueOf("2009-02-27 21:22:33.444444");
                                // Initialize a timestamp object
                                // with the datetime value that you
                                // want to put in the table
com.ibm.db2.jcc.DBTimestamp dbts =

```

```

        new com.ibm.db2.jcc.DBTimestamp(ts,estcal);
                                // Create a datetime object that
                                // includes the time zone
#sql[ctx] {INSERT INTO TSTABLE (TSCOL) VALUES (:dbts)};
                                // Insert the datetime object in
                                // the table
#sql[ctx] {COMMIT};

TSIter iter = null;
#sql [ctx] iter = {SELECT TSCOL FROM TSTABLE};
                                // Assign the result table of the SELECT
while (iter.next()) {
    System.out.println ("Timestamp = " +
        ((com.ibm.db2.jcc.DBTimestamp)iter.TSVar()).toDBString(true));
                                // Use accessor method TSVar to retrieve
                                // the TIMESTAMP WITH TIME ZONE value,
                                // cast it to a DBTimestamp value,
                                // and retrieve its string representation.
                                // Value retrieved:
                                // 2009-02-27 21:22:33.444444-05:00
    }
}

```

Suppose that stored procedure TSSP has a single INOUT parameter, TSPARM, which has data type `TIMESTAMP WITH TIME ZONE`. The following code calls the stored procedure with a timestamp value that includes a time zone, and retrieves a parameter value with a timestamp value that includes a time zone.

```

{
    ...
    java.util.TimeZone esttz = java.util.TimeZone.getTimeZone("EST");
                                // Set the time zone to GMT-5
    java.util.Calendar estcal= java.util.Calendar.getInstance(esttz);
                                // Create a calendar instance
                                // with the EST time zone
    java.sql.Timestamp ts =
    java.sql.Timestamp.valueOf("2009-02-27 21:22:33.444444");
                                // Initialize a timestamp object
                                // with the timestamp value that you
                                // want to pass to the stored procedure
    com.ibm.db2.jcc.DBTimestamp dbts =
    new com.ibm.db2.jcc.DBTimestamp(ts,estcal);
                                // Create a timestamp object that
                                // includes the time zone to
                                // pass to the stored procedure
#sql[ctx] { CALL TSSP (:INOUT dbts) };
    System.out.println ("Output parameter: " + dbts.toDBString (true));
                                // Call the stored procedure with
                                // the timestamp value as input,
                                // and retrieve a timestamp value
                                // with a time zone in the same
                                // parameter
}

```

## Distinct types in SQLJ applications

In an SQLJ program, you can create a distinct type using the `CREATE DISTINCT TYPE` statement in an executable clause.

You can also use `CREATE TABLE` in an executable clause to create a table that includes a column of that type. When you retrieve data from a column of that type, or update a column of that type, you use Java host variables or expressions with data types that correspond to the built-in types on which the distinct types are based.



The following example creates a distinct type that is based on an INTEGER type, creates a table with a column of that type, inserts a row into the table, and retrieves the row from the table:

```
String empNumVar;
int shoeSizeVar;
...
#sql [myConnCtx] {CREATE DISTINCT TYPE SHOESIZE AS INTEGER WITH COMPARISONS};
// Create distinct type
#sql [myConnCtx] {COMMIT}; // Commit the create
#sql [myConnCtx] {CREATE TABLE EMP_SHOE
  (EMPNO CHAR(6), EMP_SHOE_SIZE SHOESIZE)};
// Create table using distinct type
#sql [myConnCtx] {COMMIT}; // Commit the create
#sql [myConnCtx] {INSERT INTO EMP_SHOE
  VALUES('000010',6)}; // Insert a row in the table
#sql [myConnCtx] {COMMIT}; // Commit the INSERT
#sql [myConnCtx] {SELECT EMPNO, EMP_SHOE_SIZE
  INTO :empNumVar, :shoeSizeVar
  FROM EMP_SHOE}; // Retrieve the row
System.out.println("Employee number: " + empNumVar +
  " Shoe size: " + shoeSizeVar);
```

Figure 44. Defining and using a distinct type

## Invocation of stored procedures with ARRAY parameters in SQLJ applications

SQLJ applications that run under the IBM Data Server Driver for JDBC and SQLJ and connect to DB2 Database for Linux, UNIX, and Windows data sources can call stored procedures that have ARRAY parameters.

You can use `java.sql.Array` objects as IN, OUT, or INOUT parameters in a stored procedure.

For IN or INOUT parameters, use the `DB2Connection.createArrayOf` method (JDBC 3.0 or earlier) or the `Connection.createArrayOf` method (JDBC 4.0 or later) to create a `java.sql.Array` object.

There are two ways to retrieve data from an ARRAY output stored procedure parameter:

- Use the `java.sql.Array.getArray` method to retrieve the contents of output parameter into a Java array.
- Use a `java.sql.Array.getResultSet` method to retrieve the output parameter data into a `ResultSet` object. Then use `ResultSet` methods to retrieve elements of the array. Each row of the `ResultSet` contains two columns:
  - An index into the array, which starts at 1
  - The array element

You need to retrieve the array elements from the `ResultSet` using the `getObject` method.

**Example:** Suppose that input and output parameters `IN_PHONE` and `OUT_PHONE` in stored procedure `GET_EMP_DATA` are arrays that are defined like this:

```
CREATE TYPE PHONENUMBERS AS VARCHAR(10) ARRAY[5]
```

Call `GET_EMP_DATA` with the two parameters.

```

Connection con;
String type = "CHAR";
String [] contents = {"1234", "5678", "9101"};
...
com.ibm.db2.jcc.DB2Connection db2con = (com.ibm.db2.jcc.DB2Connection) con;
// Cast the Connection as a DB2Connection
// so you can use the
// DB2Connection.createArrayOf method
java.sql.Array inPhoneData = db2con.createArrayOf(type, contents);
java.sql.Array outPhoneData;
try {
    #sql [db2con] {CALL GET_EMP_DATA(:IN inPhoneData, :OUT outPhoneData ) };
}
catch( SQLException e )
{
    throw e;
}
ResultSet rs = outPhoneData.getResultSet();
while (rs.next()) {
    String phoneNum = (String)rs.getObject(2); // Get phone number
    System.out.println("Phone number = " + phoneNum);
}

```

## Savepoints in SQLJ applications

Under the IBM Data Server Driver for JDBC and SQLJ, you can include any form of the SQL SAVEPOINT statement in your SQLJ program.

An SQL savepoint represents the state of data and schemas at a particular point in time within a unit of work. SQL statements exist to set a savepoint, release a savepoint, and restore data and schemas to the state that the savepoint represents.

The following example demonstrates how to set a savepoint, roll back to the savepoint, and release the savepoint.

*Figure 45. Setting, rolling back to, and releasing a savepoint in an SQLJ application*

```

#sql context Ctx; // Create connection context class Ctx
String empNumVar;
int shoeSizeVar;
...
try { // Load the JDBC driver
    Class.forName("com.ibm.db2.jcc.DB2Driver");
}
catch (ClassNotFoundException e) {
    e.printStackTrace();
}
Connection jdbccon=
    DriverManager.getConnection("jdbc:db2://sysmvsl.stl.ibm.com:5021/NEWYORK",
        userid,password);
// Create JDBC connection object jdbccon
jdbccon.setAutoCommit(false); // Do not autocommit
Ctx ctxt=new Ctx(jdbccon);
// Create connection context object myConnCtx
// for the connection to NEWYORK
... // Perform some SQL
#sql [ctxt] {COMMIT}; // Commit the transaction
// Commit the create
#sql [ctxt]
    {INSERT INTO EMP_SHOE VALUES ('000010', 6)};
// Insert a row
#sql [ctxt]
    {SAVEPOINT SVPT1 ON ROLLBACK RETAIN CURSORS};
// Create a savepoint

```

```

...
#sql [ctxt]
    {INSERT INTO EMP_SHOE VALUES ('000020', 10)};
                                // Insert another row
#sql [ctxt] {ROLLBACK TO SAVEPOINT SVPT1};
                                // Roll back work to the point
                                // after the first insert
...
#sql [ctxt] {RELEASE SAVEPOINT SVPT1};
                                // Release the savepoint
ctx.close();                    // Close the connection context

```

---

## XML data in SQLJ applications

In SQLJ applications, you can store data in XML columns and retrieve data from XML columns.

In DB2 tables, the XML built-in data type is used to store XML data in a column as a structured set of nodes in a tree format.

SQLJ applications can send XML data to the data server or retrieve XML data from the data server in one of the following forms:

- As textual XML data
- As binary XML data (data that is in the Extensible Dynamic Binary XML DB2 Client/Server Binary XML Format), if the data server supports it

In SQLJ applications, you can:

- Store an entire XML document in an XML column using INSERT, UPDATE, or MERGE statements.
- Retrieve an entire XML document from an XML column using single-row SELECT statements or iterators.
- Retrieve a sequence from a document in an XML column by using the SQL XMLQUERY function to retrieve the sequence in the database, and then using single-row SELECT statements or iterators to retrieve the serialized XML string data into an application variable.
- Retrieve a sequence from a document in an XML column by using an XQuery expression, prepended with the string 'XQUERY', to retrieve the elements of the sequence into a result table in the database, in which each row of the result table represents an item in the sequence. Then use using single-row SELECT statements or iterators to retrieve the data into application variables.
- Retrieve a sequence from a document in an XML column as a user-defined table by using the SQL XMLTABLE function to define the result table and retrieve it. Then use using single-row SELECT statements or iterators to retrieve the data from the result table into application variables.
- You can update or retrieve XML data as textual XML data. Alternatively, for connections to a data server that supports binary XML data, you can update or retrieve XML data as binary XML data. You use the Datasource or Connection property xmlFormat to control whether the data format is textual XML or binary XML. The format of XML data is transparent to the application. Storage and retrieval of binary XML data on a DB2 for z/OS data server requires version 4.9 or later of the IBM Data Server Driver for JDBC and SQLJ. Storage and retrieval of binary XML data on a DB2 Database for Linux, UNIX, and Windows data server requires version 4.11 or later of the IBM Data Server Driver for JDBC and SQLJ.

JDBC 4.0 `java.sql.SQLXML` objects can be used to retrieve and update data in XML columns. Invocations of metadata methods, such as `ResultSetMetaData.getColumnType` return the integer value `java.sql.Types.SQLXML` for an XML column type.

## XML column updates in SQLJ applications

In an SQLJ application, you can update or insert data into XML columns of a table at a DB2 data server using XML textual data. You can update or insert data into XML columns of a table using binary XML data (data that is in the Extensible Dynamic Binary XML DB2 Client/Server Binary XML Format), if the data server supports binary XML data.

The host expression data types that you can use to update XML columns are:

- `java.sql.SQLXML` (requires an SDK for Java Version 6 or later, and the IBM Data Server Driver for JDBC and SQLJ version 4.0 or later)
- `com.ibm.db2.jcc.DB2Xml` (deprecated)
- `String`
- `byte`
- `Blob`
- `Clob`
- `sqlj.runtime.AsciiStream`
- `sqlj.runtime.BinaryStream`
- `sqlj.runtime.CharacterStream`

The encoding of XML data can be derived from the data itself, which is known as *internally encoded* data, or from external sources, which is known as *externally encoded* data. XML data that is sent to the database server as binary data is treated as internally encoded data. XML data that is sent to the data source as character data is treated as externally encoded data. The external encoding is the default encoding for the JVM.

External encoding for Java applications is always Unicode encoding.

Externally encoded data can have internal encoding. That is, the data might be sent to the data source as character data, but the data contains encoding information. The data source handles incompatibilities between internal and external encoding as follows:

- If the data source is DB2 Database for Linux, UNIX, and Windows, the data source generates an error if the external and internal encoding are incompatible, unless the external and internal encoding are Unicode. If the external and internal encoding are Unicode, the data source ignores the internal encoding.
- If the data source is DB2 for z/OS, the data source ignores internal encoding.

Data in XML columns is stored in UTF-8 encoding.

**Example:** Suppose that you use the following statement to insert data from `String` host expression `xmlString` into an XML column in a table. `xmlString` is a character type, so its external encoding is used, whether or not it has an internal encoding specification.

```
#sql [ctx] {INSERT INTO CUSTACC VALUES (1, :xmlString)};
```

**Example:** Suppose that you copy the data from `xmlString` into a byte array with CP500 encoding. The data contains an XML declaration with an encoding declaration for CP500. Then you insert the data from the `byte[]` host expression into an XML column in a table.

```
byte[] xmlBytes = xmlString.getBytes("CP500");
#sql[ctx] {INSERT INTO CUSTACC VALUES (4, :xmlBytes)};
```

A byte string is considered to be internally encoded data. The data is converted from its internal encoding scheme to UTF-8, if necessary, and stored in its hierarchical format on the data source.

**Example:** Suppose that you copy the data from `xmlString` into a byte array with US-ASCII encoding. Then you construct an `sqlj.runtime.AsciiStream` host expression, and insert data from the `sqlj.runtime.AsciiStream` host expression into an XML column in a table on a data source.

```
byte[] b = xmlString.getBytes("US-ASCII");
java.io.ByteArrayInputStream xmlAsciiInputStream =
    new java.io.ByteArrayInputStream(b);
sqlj.runtime.AsciiStream sqljXmlAsciiStream =
    new sqlj.runtime.AsciiStream(xmlAsciiInputStream, b.length);
#sql[ctx] {INSERT INTO CUSTACC VALUES (4, :sqljXmlAsciiStream)};
```

`sqljXmlAsciiStream` is a stream type, so its internal encoding is used. The data is converted from its internal encoding to UTF-8 encoding and stored in its hierarchical form on the data source.

**Example: `sqlj.runtime.CharacterStream` host expression:** Suppose that you construct an `sqlj.runtime.CharacterStream` host expression, and insert data from the `sqlj.runtime.CharacterStream` host expression into an XML column in a table.

```
java.io.StringReader xmlReader =
    new java.io.StringReader(xmlString);
sqlj.runtime.CharacterStream sqljXmlCharacterStream =
    new sqlj.runtime.CharacterStream(xmlReader, xmlString.length());
#sql [ctx] {INSERT INTO CUSTACC VALUES (4, :sqljXmlCharacterStream)};
```

`sqljXmlCharacterStream` is a character type, so its external encoding is used, whether or not it has an internal encoding specification.

**Example:** Suppose that you retrieve a document from an XML column into a `java.sql.SQLXML` host expression, and insert the data into an XML column in a table.

```
java.sql.ResultSet rs = s.executeQuery ("SELECT * FROM CUSTACC");
rs.next();
java.sql.SQLXML xmlObject = (java.sql.SQLXML)rs.getObject(2);
#sql [ctx] {INSERT INTO CUSTACC VALUES (6, :xmlObject)};
```

After you retrieve the data it is still in UTF-8 encoding, so when you insert the data into another XML column, no conversion occurs.

**Example:** Suppose that you retrieve a document from an XML column into a `com.ibm.db2.jcc.DB2Xml` host expression, and insert the data into an XML column in a table.

```
java.sql.ResultSet rs = s.executeQuery ("SELECT * FROM CUSTACC");
rs.next();
com.ibm.db2.jcc.DB2Xml xmlObject = (com.ibm.db2.jcc.DB2Xml)rs.getObject(2);
#sql [ctx] {INSERT INTO CUSTACC VALUES (6, :xmlObject)};
```

After you retrieve the data it is still in UTF-8 encoding, so when you insert the data into another XML column, no conversion occurs.

## XML data retrieval in SQLJ applications

When you retrieve data from XML columns of a database table in an SQLJ application, the output data must be explicitly or implicitly serialized.

The host expression or iterator data types that you can use to retrieve data from XML columns are:

- `java.sql.SQLXML` (requires an SDK for Java Version 6 or later, and the IBM Data Server Driver for JDBC and SQLJ version 4.0 or later)
- `com.ibm.db2.jcc.DB2Xml` (deprecated)
- `String`
- `byte[]`
- `sqlj.runtime.AsciiStream`
- `sqlj.runtime.BinaryStream`
- `sqlj.runtime.CharacterStream`

If the application does not call the `XMLSERIALIZE` function before data retrieval, the data is converted from UTF-8 to the external application encoding for the character data types, or the internal encoding for the binary data types. No XML declaration is added. If the host expression is an object of the `java.sql.SQLXML` or `com.ibm.db2.jcc.DB2Xml` type, you need to call an additional method to retrieve the data from this object. The method that you call determines the encoding of the output data and whether an XML declaration with an encoding specification is added.

The following table lists the methods that you can call to retrieve data from a `java.sql.SQLXML` or a `com.ibm.db2.jcc.DB2Xml` object, and the corresponding output data types and type of encoding in the XML declarations.

Table 28. *SQLXML and DB2Xml methods, data types, and added encoding specifications*

Method	Output data type	Type of XML internal encoding declaration added
<code>SQLXML.getBinaryStream</code>	<code>InputStream</code>	None
<code>SQLXML.getCharacterStream</code>	<code>Reader</code>	None
<code>SQLXML.getSource</code>	<code>Source</code>	None
<code>SQLXML.getString</code>	<code>String</code>	None
<code>DB2Xml.getDB2AsciiStream</code>	<code>InputStream</code>	None
<code>DB2Xml.getDB2BinaryStream</code>	<code>InputStream</code>	None
<code>DB2Xml.getDB2Bytes</code>	<code>byte[]</code>	None
<code>DB2Xml.getDB2CharacterStream</code>	<code>Reader</code>	None
<code>DB2Xml.getDB2String</code>	<code>String</code>	None
<code>DB2Xml.getDB2XmlAsciiStream</code>	<code>InputStream</code>	US-ASCII
<code>DB2Xml.getDB2XmlBinaryStream</code>	<code>InputStream</code>	Specified by <code>getDB2XmlBinaryStream</code> <i>targetEncoding</i> parameter
<code>DB2Xml.getDB2XmlBytes</code>	<code>byte[]</code>	Specified by <code>DB2Xml.getDB2XmlBytes</code> <i>targetEncoding</i> parameter
<code>DB2Xml.getDB2XmlCharacterStream</code>	<code>Reader</code>	ISO-10646-UCS-2
<code>DB2Xml.getDB2XmlString</code>	<code>String</code>	ISO-10646-UCS-2

If the application executes the `XMLSERIALIZE` function on the data that is to be returned, after execution of the function, the data has the data type that is specified

in the XMLSERIALIZE function, not the XML data type. Therefore, the driver handles the data as the specified type and ignores any internal encoding declarations.

**Example:** Suppose that you retrieve data from an XML column into a String host expression.

```
#sql iterator XmlStringIter (int, String);
#sql [ctx] siter = {SELECT c1, CADOC from CUSTACC};
#sql {FETCH :siter INTO :row, :outString};
```

The String type is a character type, so the data is converted from UTF-8 to the external encoding, which is the default JVM encoding, and returned without any XML declaration.

**Example:** Suppose that you retrieve data from an XML column into a byte[] host expression.

```
#sql iterator XmlByteArrayIter (int, byte[]);
XmlByteArrayIter biter = null;
#sql [ctx] biter = {SELECT c1, CADOC from CUSTACC};
#sql {FETCH :biter INTO :row, :outBytes};
```

The byte[] type is a binary type, so no data conversion from UTF-8 encoding occurs, and the data is returned without any XML declaration.

**Example:** Suppose that you retrieve a document from an XML column into a java.sql.SQLXML host expression, but you need the data in a binary stream.

```
#sql iterator SqlXmlIter (int, java.sql.SQLXML);
SqlXmlIter SQLXMLiter = null;
java.sql.SQLXML outSqlXml = null;
#sql [ctx] SqlXmlIter = {SELECT c1, CADOC from CUSTACC};
#sql {FETCH :SqlXmlIter INTO :row, :outSqlXml};
java.io.InputStream XmlStream = outSqlXml.getBinaryStream();
```

The FETCH statement retrieves the data into the SQLXML object in UTF-8 encoding. The SQLXML.getBinaryStream stores the data in a binary stream.

**Example:** Suppose that you retrieve a document from an XML column into a com.ibm.db2.jcc.DB2Xml host expression, but you need the data in a byte string with an XML declaration that includes an internal encoding specification for UTF-8.

```
#sql iterator DB2XmlIter (int, com.ibm.db2.jcc.DB2Xml);
DB2XmlIter db2xmliter = null;
com.ibm.db2.jcc.DB2Xml outDB2Xml = null;
#sql [ctx] db2xmliter = {SELECT c1, CADOC from CUSTACC};
#sql {FETCH :db2xmliter INTO :row, :outDB2Xml};
byte[] byteArray = outDB2XML.getDB2XmlBytes("UTF-8");
```

The FETCH statement retrieves the data into the DB2Xml object in UTF-8 encoding. The getDB2XmlBytes method with the UTF-8 argument adds an XML declaration with a UTF-8 encoding specification and stores the data in a byte array.

## XMLCAST in SQLJ applications

Before you can use XMLCAST to cast a host variable to the XML data type in an SQLJ application, you need to cast the host variable to the corresponding SQL data type.



**Example:** The following code demonstrates a situation in which it is necessary to cast a String host variable to an SQL character type, such as VARCHAR, before you use XMLCAST to cast the value to the XML data type.

```
String xmlresult = null;
String varchar_hv = "San Jose";
...
#sql [con] {SELECT XMLCAST(CAST(:varchar_hv AS VARCHAR(32)) AS XML) INTO
:xmlresult FROM SYSIBM.SYSDUMMY1};
```

---

## SQLJ utilization of SDK for Java Version 5 function

Your SQLJ applications can use a number of functions that were introduced with the SDK for Java Version 5.

### Static import

The static import construct lets you access static members without qualifying those members with the name of the class to which they belong. For SQLJ applications, this means that you can use static members in host expressions without qualifying them.

**Example:** Suppose that you want to declare a host expression of this form:

```
double r = cos(PI * E);
```

cos, PI, and E are members of the java.lang.Math class. To declare r without explicitly qualifying cos, PI, and E, include the following static import statement in your program:

```
import static java.lang.Math.*;
```

### Annotations

Java annotations are a means for adding metadata to Java programs that can also affect the way that those programs are treated by tools and libraries. Annotations are declared with annotation type declarations, which are similar to interface declarations. Java annotations can appear in the following types of classes or interfaces:

- Class declaration
- Interface declaration
- Nested class declaration
- Nested interface declaration

You cannot include Java annotations directly in SQLJ programs, but you can include annotations in Java source code, and then include that source code in your SQLJ programs.

**Example:** Suppose that you declare the following marker annotation in a program called MyAnnot.java:

```
public @interface MyAnot { }
```

You also declare the following marker annotation in a program called MyAnnot2.java:

```
public @interface MyAnot2 { }
```

You can then use those annotations in an SQLJ program:



```

// Class annotations
@MyAnot2 public @MyAnot class TestAnnotation
{
    // Field annotation
    @MyAnot
    private static final int field1 = 0;
    // Constructor annotation
    @MyAnot2 public @MyAnot TestAnnotation () { }
    // Method annotation
    @MyAnot
    public static void main (String a[])
    {
        TestAnnotation TestAnnotation_o = new TestAnnotation();
        TestAnnotation_o.runThis();
    }
    // Inner class annotation
    public static @MyAnot class TestAnotherInnerClass { }
    // Inner interface annotation
    public static @MyAnot interface TestAnotInnerInterface { }
}

```

## Enumerated types

An enumerated type is a data type that consists of a set of ordered values. The SDK for Java version 5 introduces the enum type for enumerated types.

You can include enums in the following places:

- In Java source files (.java files) that you include in an SQLJ program
- In SQLJ class declarations

**Example:** The TestEnum.sqlj class declaration includes an enum type:

```

public class TestEnum2
{
    public enum Color {
        RED,ORANGE,YELLOW,GREEN,BLUE,INDIGO,VIOLET}
    Color color;
    ... // Get the value of color
    switch (color) {
    case RED:
        System.out.println("Red is at one end of the spectrum.");
        #sql[ctx] { INSERT INTO MYTABLE VALUES (:color) };
        break;
    case VIOLET:
        System.out.println("Violet is on the other end of the spectrum.");
        break;
    case ORANGE:
    case YELLOW:
    case GREEN:
    case BLUE:
    case INDIGO:
        System.out.println("Everything else is in the middle.");
        break;
    }
}

```

## Generics

You can use generics in your Java programs to assign a type to a Java collection. The SQLJ translator tolerates Java generic syntax. Examples of generics that you can use in SQLJ programs are:

- A List of List objects:

```
List <List<String>> strList2 = new ArrayList<List<String>>();
```

- A HashMap in which the key/value pair has the String type:  

```
Map <String,String> map = new HashMap<String,String>();
```
- A method that takes a List with elements of any type:  

```
public void mthd(List <?> obj) {
    ...
}
```

Although you can use generics in SQLJ host variables, the value of doing so is limited because the SQLJ translator cannot determine the types of those host variables.

## Enhanced for loop

The enhanced for lets you specify that a set of operations is performed on each member of a collection or array. You can use the iterator in the enhanced for loop in host expressions.

**Example:** INSERT each of the items in array names into table TAB.

```
String[] names = {"ABC","DEF","GHI"};
for (String n : names)
{
    #sql {INSERT INTO TAB (VARCHARCOL) VALUES(:n) };
}
```

## Varargs

Varargs make it easier to pass an arbitrary number of values to a method. A Vararg in the last argument position of a method declaration indicates that the last arguments are an array or a sequence of arguments. An SQLJ program can use the passed arguments in host expressions.

**Example:** Pass an arbitrary number of parameters of type Object, to a method that inserts each parameter value into table TAB.

```
public void runThis(Object... objects) throws SQLException
{
    for (Object obj : objects)
    {
        #sql { INSERT INTO TAB (VARCHARCOL) VALUES(:obj) };
    }
}
```

---

## Transaction control in SQLJ applications

In SQLJ applications, as in other types of SQL applications, transaction control involves explicitly or implicitly committing and rolling back transactions, and setting the isolation level for transactions.

### Setting the isolation level for an SQLJ transaction

To set the isolation level for a unit of work within an SQLJ program, use the SET TRANSACTION ISOLATION LEVEL clause.

#### About this task

The following table shows the values that you can specify in the SET TRANSACTION ISOLATION LEVEL clause and their DB2 equivalents.

Table 29. Equivalent SQLJ and DB2 isolation levels

SET TRANSACTION value	DB2 isolation level
SERIALIZABLE	Repeatable read
REPEATABLE READ	Read stability
READ COMMITTED	Cursor stability
READ UNCOMMITTED	Uncommitted read

The isolation level affects the underlying JDBC connection as well as the SQLJ connection.

## Committing or rolling back SQLJ transactions

If you disable autocommit for an SQLJ connection, you need to perform explicit commit or rollback operations.

### About this task

You do this using execution clauses that contain the SQL COMMIT or ROLLBACK statements.

### Example

To commit a transaction in an SQLJ program, use a statement like this:

```
#sql [myConnCtx] {COMMIT};
```

To roll back a transaction in an SQLJ program, use a statement like this:

```
#sql [myConnCtx] {ROLLBACK};
```

---

## Handling SQL errors and warnings in SQLJ applications

SQLJ clauses throw `SQLExceptions` when SQL errors occur, but not when most SQL warnings occur.

### About this task

SQLJ generates an `SQLException` under the following circumstances:

- When any SQL statement returns a negative SQL error code
- When a SELECT INTO SQL statement returns a +100 SQL error code

You need to explicitly check for other SQL warnings.

### Procedure

- For SQL error handling, include try/catch blocks around SQLJ statements.
- For SQL warning handling, invoke the `getWarnings` method after every SQLJ statement.

## Handling SQL errors in an SQLJ application

SQLJ clauses use the JDBC class `java.sql.SQLException` for error handling.

### About this task

To handle SQL errors in SQLJ applications, following these steps:

## Procedure

1. Import the `java.sql.SQLException` class.
2. Use the Java error handling `try/catch` blocks to modify program flow when an SQL error occurs.
3. Obtain error information from the `SQLException`.

You can use the `getErrorCode` method to retrieve SQL error codes and the `getSQLState` method to retrieve `SQLSTATES`.

If you are using the IBM Data Server Driver for JDBC and SQLJ, obtain additional information from the `SQLException` by casting it to a `DB2Diagnosable` object, in the same way that you obtain this information in a JDBC application.

## Example

The following code prints out the SQL error that occurred if a `SELECT` statement fails.

```
try {
    #sql [ctxt] {SELECT LASTNAME INTO :empname
                FROM EMPLOYEE WHERE EMPNO='000010'};
}
catch(SQLException e) {
    System.out.println("Error code returned: " + e.getErrorCode());
}
```

## Handling SQL warnings in an SQLJ application

Other than a +100 SQL error code on a `SELECT INTO` statement, warnings from the data server do not throw `SQLExceptions`. To handle warnings from the data server, you need to give the program access to the `java.sql.SQLWarning` class.

### About this task

If you want to retrieve data-server-specific information about a warning, you also need to give the program access to the `com.ibm.db2.jcc.DB2Diagnosable` interface and the `com.ibm.db2.jcc.DB2Sqlca` class. Then follow these steps:

## Procedure

1. Set up an execution context for that SQL clause. See "Control the execution of SQL statements in SQLJ" for information on how to set up an execution context.
2. To check for a warning from the data server, invoke the `getWarnings` method after you execute an SQLJ clause.  
`getWarnings` returns the first `SQLWarning` object that an SQL statement generates. Subsequent `SQLWarning` objects are chained to the first one.
3. To retrieve data-server-specific information from the `SQLWarning` object with the IBM Data Server Driver for JDBC and SQLJ, follow the instructions in "Handle an `SQLException` under the IBM Data Server Driver for JDBC and SQLJ".

## Example

The following example demonstrates how to retrieve an `SQLWarning` object for an SQL clause with execution context `execCtx`. The numbers to the right of selected statements correspond to the previously-described steps.

```

ExecutionContext execCtx=myConnCtx.getExecutionContext(); 1
// Get default execution context from
// connection context

SQLWarning sqlWarn;

...
#sql [myConnCtx,execCtx] {SELECT LASTNAME INTO :empname
FROM EMPLOYEE WHERE EMPNO='000010'};
if ((sqlWarn = execCtx.getWarnings()) != null) 2
System.out.println("SQLWarning " + sqlWarn);

```

---

## Closing the connection to a data source in an SQLJ application

When you have finished with a connection to a data source, you need to close the connection to the data source. Doing so releases the DB2 and SQLJ resources for the associated `ConnectionContext` object immediately.

### About this task

If you do not close a `ConnectionContext` object after you use it, unexpected behavior might occur if a Java finalizer closes the `ConnectionContext` object. Examples of the unexpected behavior are:

- An `ObjectClosedException` on the underlying `ResultSet` or `Statement` objects
- Agent hangs in DB2 stored procedures

### Procedure

To close the connection to the data source, use one of the `ConnectionContext.close` methods.

- If you execute `ConnectionContext.close()` or `ConnectionContext.close(ConnectionContext.CLOSE_CONNECTION)`, the connection context, as well as the connection to the data source, are closed.
- If you execute `ConnectionContext.close(ConnectionContext.KEEP_CONNECTION)` the connection context is closed, but the connection to the data source is not.

### Example

The following code closes the connection context, but does not close the connection to the data source.

```

...
ctx = new EzSqljctx(con0);           // Create a connection context object
// from JDBC connection con0
...
// Perform various SQL operations
EzSqljctx.close(ConnectionContext.KEEP_CONNECTION);
// Close the connection context but keep
// the connection to the data source open

```

## Chapter 5. Security under the IBM Data Server Driver for JDBC and SQLJ

When you use the IBM Data Server Driver for JDBC and SQLJ, you choose a security mechanism by specifying a value for the `securityMechanism` property.

You can set this property in one of the following ways:

- If you use the `DriverManager` interface, set `securityMechanism` in a `java.util.Properties` object before you invoke the form of the `getConnection` method that includes the `java.util.Properties` parameter.
- If you use the `DataSource` interface, and you are creating and deploying your own `DataSource` objects, invoke the `DataSource.setSecurityMechanism` method after you create a `DataSource` object.

You can determine the security mechanism that is in effect for a connection by calling the `DB2Connection.getDB2SecurityMechanism` method.

The following table lists the security mechanisms that the IBM Data Server Driver for JDBC and SQLJ supports, and the data sources that support those security mechanisms.

*Table 30. Data server support for IBM Data Server Driver for JDBC and SQLJ security mechanisms*

Security mechanism	Supported by DB2 Database for Linux, UNIX, and Windows	Supported by DB2 for z/OS	Supported by IBM Informix	Supported by DB2 for i
User ID and password	Yes	Yes	Yes	Yes
User ID only	Yes	Yes	Yes	Yes
User ID and encrypted password	Yes	Yes	Yes	Yes <sup>2</sup>
Encrypted user ID	Yes	Yes	No	No
Encrypted user ID and encrypted password	Yes	Yes	Yes	Yes <sup>2</sup>
Encrypted user ID and encrypted security-sensitive data	No	Yes	No	No
Encrypted user ID, encrypted password, and encrypted security-sensitive data	Yes	Yes	No	No
Kerberos <sup>1</sup>	Yes	Yes	No	Yes
Plugin <sup>1</sup>	Yes	No	No	No

**Note:**

1. Available for IBM Data Server Driver for JDBC and SQLJ type 4 connectivity only.
2. The version of the data source must be DB2 for i V6R1 or later.

The following table lists the security mechanisms that the IBM Data Server Driver for JDBC and SQLJ supports, and the value that you need to specify for the `securityMechanism` property to specify each security mechanism.

The default security mechanism is `CLEAR_TEXT_PASSWORD_SECURITY`. If the server does not support `CLEAR_TEXT_PASSWORD_SECURITY` but supports `ENCRYPTED_USER_AND_PASSWORD_SECURITY`, the IBM Data Server Driver for JDBC and SQLJ driver updates the security mechanism to `ENCRYPTED_USER_AND_PASSWORD_SECURITY` and attempts to connect to the server. Any other mismatch in security mechanism support between the requester and the server results in an error.

*Table 31. Security mechanisms supported by the IBM Data Server Driver for JDBC and SQLJ*

<b>Security mechanism</b>	<b>securityMechanism property value</b>
User ID and password	<code>DB2BaseDataSource.CLEAR_TEXT_PASSWORD_SECURITY</code>
User ID only	<code>DB2BaseDataSource.USER_ONLY_SECURITY</code>
User ID and encrypted password	<code>DB2BaseDataSource.ENCRYPTED_PASSWORD_SECURITY</code>
Encrypted user ID	<code>DB2BaseDataSource.ENCRYPTED_USER_ONLY_SECURITY</code>
Encrypted user ID and encrypted password	<code>DB2BaseDataSource.ENCRYPTED_USER_AND_PASSWORD_SECURITY</code>
Encrypted user ID and encrypted security-sensitive data	<code>DB2BaseDataSource.ENCRYPTED_USER_AND_DATA_SECURITY</code>
Encrypted user ID, encrypted password, and encrypted security-sensitive data	<code>DB2BaseDataSource.ENCRYPTED_USER_PASSWORD_AND_DATA_SECURITY</code>
Kerberos	<code>DB2BaseDataSource.KERBEROS_SECURITY</code>
Plugin	<code>DB2BaseDataSource.PLUGIN_SECURITY</code>

The following table shows possible DB2 Database for Linux, UNIX, and Windows server authentication types and the compatible IBM Data Server Driver for JDBC and SQLJ `securityMechanism` property values.

*Table 32. Compatible DB2 Database for Linux, UNIX, and Windows server authentication types and IBM Data Server Driver for JDBC and SQLJ securityMechanism values*

<b>DB2 Database for Linux, UNIX, and Windows server authentication type</b>	<b>securityMechanism setting</b>
CLIENT	<code>USER_ONLY_SECURITY</code>
SERVER	<code>CLEAR_TEXT_PASSWORD_SECURITY</code>
SERVER_ENCRYPT	<code>CLEAR_TEXT_PASSWORD_SECURITY</code> , <code>ENCRYPTED_PASSWORD_SECURITY</code> , or <code>ENCRYPTED_USER_AND_PASSWORD_SECURITY</code>
DATA_ENCRYPT	<code>ENCRYPTED_USER_PASSWORD_AND_DATA_SECURITY</code>
KERBEROS	<code>KERBEROS_SECURITY</code> or <code>PLUGIN_SECURITY</code> <sup>2</sup>
KRB_SERVER_ENCRYPT	<code>KERBEROS_SECURITY</code> , <code>PLUGIN_SECURITY</code> <sup>1</sup> , <code>ENCRYPTED_PASSWORD_SECURITY</code> , or <code>ENCRYPTED_USER_AND_PASSWORD_SECURITY</code>
GSSPLUGIN	<code>PLUGIN_SECURITY</code> <sup>1</sup> or <code>KERBEROS_SECURITY</code>

Table 32. Compatible DB2 Database for Linux, UNIX, and Windows server authentication types and IBM Data Server Driver for JDBC and SQLJ securityMechanism values (continued)

DB2 Database for Linux, UNIX, and Windows server authentication type	securityMechanism setting
GSS_SERVER_ENCRYPT <sup>3</sup>	CLEAR_TEXT_PASSWORD_SECURITY, ENCRYPTED_PASSWORD_SECURITY, ENCRYPTED_USER_AND_PASSWORD_SECURITY, PLUGIN_SECURITY, or KERBEROS_SECURITY
<b>Notes:</b> <ol style="list-style-type: none"> <li>1. For PLUGIN_SECURITY, the plugin must be a Kerberos plugin.</li> <li>2. For PLUGIN_SECURITY, one of the plugins at the server identifies itself as supporting Kerberos.</li> <li>3. GSS_SERVER_ENCRYPT is a combination of GSSPLUGIN and SERVER_ENCRYPT.</li> </ol>	

## User ID and password security under the IBM Data Server Driver for JDBC and SQLJ

With the IBM Data Server Driver for JDBC and SQLJ, one of the available security methods is user ID and password security.

To specify user ID and password security for a JDBC connection, use one of the following techniques.

*For the DriverManager interface:* You can specify the user ID and password directly in the DriverManager.getConnection invocation. For example:

```
import java.sql.*;          // JDBC base
...
String id = "dbadm";       // Set user ID
String pw = "dbadm";       // Set password
String url = "jdbc:db2://mvs1.sj.ibm.com:5021/san_jose";
                          // Set URL for the data source

Connection con = DriverManager.getConnection(url, id, pw);
                          // Create connection
```

Another method is to set the user ID and password directly in the URL string. For example:

```
import java.sql.*;          // JDBC base
...
String url =
    "jdbc:db2://mvs1.sj.ibm.com:5021/san_jose:user=dbadm;password=dbadm;";
                          // Set URL for the data source
Connection con = DriverManager.getConnection(url);
                          // Create connection
```

Alternatively, you can set the user ID and password by setting the user and password properties in a Properties object, and then invoking the form of the getConnection method that includes the Properties object as a parameter. Optionally, you can set the securityMechanism property to indicate that you are using user ID and password security. For example:

```
import java.sql.*;          // JDBC base
import com.ibm.db2.jcc.*;   // IBM Data Server Driver for JDBC
                          // and SQLJ implementation of JDBC
...
Properties properties = new java.util.Properties();
                          // Create Properties object
```



```

properties.put("user", "dbadm");           // Set user ID for the connection
properties.put("password", "dbadm");       // Set password for the connection
properties.put("securityMechanism",
    new String(" " + com.ibm.db2.jcc.DB2BaseDataSource.CLEAR_TEXT_PASSWORD_SECURITY +
    ""));
                                           // Set security mechanism to
                                           // user ID and password
String url = "jdbc:db2://mvs1.sj.ibm.com:5021/san_jose";
                                           // Set URL for the data source
Connection con = DriverManager.getConnection(url, properties);
                                           // Create connection

```

*For the DataSource interface:* you can specify the user ID and password directly in the DataSource.getConnection invocation. For example:

```

import java.sql.*;           // JDBC base
import com.ibm.db2.jcc.*;    // IBM Data Server Driver for JDBC
                             // and SQLJ implementation of JDBC
...
Context ctx=new InitialContext(); // Create context for JNDI
DataSource ds=(DataSource)ctx.lookup("jdbc/sampled");
                             // Get DataSource object
String id = "dbadm";         // Set user ID
String pw = "dbadm";         // Set password
Connection con = ds.getConnection(id, pw);
                             // Create connection

```

Alternatively, if you create and deploy the DataSource object, you can set the user ID and password by invoking the DataSource.setUser and DataSource.setPassword methods after you create the DataSource object. Optionally, you can invoke the DataSource.setSecurityMechanism method property to indicate that you are using user ID and password security. For example:

```

...
com.ibm.db2.jcc.DB2SimpleDataSource ds = // Create DB2SimpleDataSource object
    new com.ibm.db2.jcc.DB2SimpleDataSource();
ds.setDriverType(4); // Set driver type
ds.setDatabaseName("san_jose"); // Set location
ds.setServerName("mvs1.sj.ibm.com"); // Set server name
ds.setPortNumber(5021); // Set port number
ds.setUser("dbadm"); // Set user ID
ds.setPassword("dbadm"); // Set password
ds.setSecurityMechanism(
    com.ibm.db2.jcc.DB2BaseDataSource.CLEAR_TEXT_PASSWORD_SECURITY);
                             // Set security mechanism to
                             // user ID and password

```

**RACF password phrase security:** If you are connecting to a DB2 for z/OS that is configured for RACF protection, and the RACF version supports RACF password phrases, you can supply a RACF password phrase for the password property value, instead of a simple password. A password phrase must conform to the following rules:

- A password phrase is a character string that can consist of mixed-case letters, numbers, and special characters, including blanks.
- The length of the password phrase can be 9 to 100 characters, or 14 to 100 characters.

Password phrases of between 9 and 13 characters are allowed when the new-password-phrase exit (ICHPWX11) is installed on the z/OS system, and the exit allows password phrases of fewer than 14 characters.

- A password phrase must not contain the user ID, as sequential uppercase or sequential lowercase characters.

- A password phrase must contain at least two alphabetic characters (A through Z or a through z).
- A password phrase must contain at least two non-alphabetic characters (numerics, punctuation, or special characters).
- A password phrase must not contain more than two consecutive characters that are identical.
- If a single quotation mark (') is part of the password phrase, the single quotation mark must be represented as two consecutive single quotation marks (").

The following example uses a password phrase for a connection:

```
import java.sql.*;           // JDBC base
import com.ibm.db2.jcc.*;   // IBM Data Server Driver for JDBC
                             // and SQLJ implementation of JDBC
...
Properties properties = new java.util.Properties();
                             // Create Properties object
properties.put("user", "dbadm"); // Set user ID for the connection
properties.put("password", "a*b!c@ D12345 678");
                             // Set password phrase for the connection

properties.put("securityMechanism",
  new String("" + com.ibm.db2.jcc.DB2BaseDataSource.CLEAR_TEXT_PASSWORD_SECURITY +
  ""));
                             // Set security mechanism to
                             // user ID and password
String url = "jdbc:db2://mvs1.sj.ibm.com:5021/san_jose";
                             // Set URL for the data source
Connection con = DriverManager.getConnection(url, properties);
                             // Create connection
```

---

## User ID-only security under the IBM Data Server Driver for JDBC and SQLJ

With the IBM Data Server Driver for JDBC and SQLJ, one of the available security methods is user-ID only security.

To specify user ID security for a JDBC connection, use one of the following techniques.

*For the `DriverManager` interface:* Set the user ID and security mechanism by setting the user and securityMechanism properties in a Properties object, and then invoking the form of the getConnection method that includes the Properties object as a parameter. For example:

```
import java.sql.*;           // JDBC base
import com.ibm.db2.jcc.*;   // IBM Data Server Driver
                             // for JDBC and SQLJ
                             // implementation of JDBC
...
Properties properties = new Properties();
                             // Create a Properties object
properties.put("user", "db2adm"); // Set user ID for the connection
properties.put("securityMechanism",
  new String("" + com.ibm.db2.jcc.DB2BaseDataSource.USER_ONLY_SECURITY + ""));
                             // Set security mechanism to
                             // user ID only
String url = "jdbc:db2://mvs1.sj.ibm.com:5021/san_jose";
                             // Set URL for the data source
Connection con = DriverManager.getConnection(url, properties);
                             // Create the connection
```

*For the DataSource interface:* If you create and deploy the DataSource object, you can set the user ID and security mechanism by invoking the DataSource.setUser and DataSource.setSecurityMechanism methods after you create the DataSource object. For example:

```
import java.sql.*;           // JDBC base
import com.ibm.db2.jcc.*;    // IBM Data Server Driver
                             // for JDBC and SQLJ
                             // implementation of JDBC
...
com.ibm.db2.jcc.DB2SimpleDataSource db2ds =
    new com.ibm.db2.jcc.DB2SimpleDataSource();
db2ds.setDriverType(4);      // Create DB2SimpleDataSource object
                             // Set the driver type
db2ds.setDatabaseName("san_jose"); // Set the location
db2ds.setServerName("mvs1.sj.ibm.com");
                             // Set the server name
db2ds.setPortNumber(5021);  // Set the port number
db2ds.setUser("db2adm");    // Set the user ID
db2ds.setSecurityMechanism(
    com.ibm.db2.jcc.DB2BaseDataSource.USER_ONLY_SECURITY);
                             // Set security mechanism to
                             // user ID only
```

---

## Encrypted password, user ID, or user ID and password security under the IBM Data Server Driver for JDBC and SQLJ

IBM Data Server Driver for JDBC and SQLJ supports encrypted password security, encrypted user ID security, or encrypted user ID and encrypted password security for accessing data sources.

The IBM Data Server Driver for JDBC and SQLJ supports 56-bit DES (weak) encryption or 256-bit AES (strong) encryption. AES encryption is available with IBM Data Server Driver for JDBC and SQLJ type 4 connectivity only. You set the encryptionAlgorithm driver property to choose between 56-bit DES encryption (encryptionAlgorithm value of 1) and 256-bit AES encryption (encryptionAlgorithm value of 2). 256-bit AES encryption is used for a connection only if the database server supports it and is configured to use it.

If you use encrypted password security, encrypted user ID security, or encrypted user ID and encrypted password security, the IBM Java Cryptography Extension (JCE) needs to be enabled on your client. The IBM JCE is part of the IBM SDK for Java, Version 1.4.2 or later.

The IBM JCE needs to use 56-bit DES or 256-bit AES encrypted client/server communication from the IBM Data Server Driver for JDBC and SQLJ driver to DB2 Database for Linux, UNIX, and Windows servers.

For AES encryption, you need an unrestricted policy file for JCE. For the IBM SDK for Java, the file is available at the following location:

<https://www14.software.ibm.com/webapp/iwm/web/preLogin.do?source=jcesdk>

When you use AES encryption with the SDK for Java from Oracle, the JCE Unlimited Strength Jurisdiction Policy File needs to be installed. That file is available from Oracle. If the JCE Unlimited Strength Jurisdiction Policy File is not found, a java.security.InvalidKeyException is thrown.

Connections to DB2 for i V6R1 or later servers can use encrypted password security or encrypted user ID and encrypted password security. For encrypted

password security or encrypted user ID and encrypted password security, the IBM Java Cryptography Extension (ibmjceprovider.jar) must be installed on your client. The IBM JCE is part of the IBM SDK for Java, Version 1.4.2 or later.

You can also use encrypted security-sensitive data in addition to encrypted user ID security or encrypted user ID and encrypted password security. You specify encryption of security-sensitive data through the ENCRYPTED\_USER\_AND\_DATA\_SECURITY or ENCRYPTED\_USER\_PASSWORD\_AND\_DATA\_SECURITY securityMechanism value. ENCRYPTED\_USER\_AND\_DATA\_SECURITY is valid for connections to DB2 for z/OS servers only, and only for DES encryption (encryptionAlgorithm value of 1).

DB2 for z/OS or DB2 Database for Linux, UNIX, and Windows database servers encrypt the following data when you specify encryption of security-sensitive data:

- SQL statements that are being prepared, executed, or bound into a package
- Input and output parameter information
- Result sets
- LOB data
- XML data
- Results of describe operations

Before you can use encrypted security-sensitive data, the z/OS Integrated Cryptographic Services Facility needs to be installed and enabled on the z/OS operating system.

To specify encrypted user ID or encrypted password security for a JDBC connection, use one of the following techniques.

*For the DriverManager interface:* Set the user ID, password, and security mechanism by setting the user, password, and securityMechanism properties in a Properties object, and then invoking the form of the getConnection method that includes the Properties object as a parameter. For example, use code like this to set the user ID and encrypted password security mechanism, with AES encryption:

```
import java.sql.*;           // JDBC base
import com.ibm.db2.jcc.*;    // IBM Data Server Driver for JDBC
                             // and SQLJ implementation of JDBC
...
Properties properties = new Properties(); // Create a Properties object
properties.put("user", "dbadm");        // Set user ID for the connection
properties.put("password", "dbadm");    // Set password for the connection
properties.put("securityMechanism", "2");
    new String(" + com.ibm.db2.jcc.DB2BaseDataSource.ENCRYPTED_PASSWORD_SECURITY +
    "");
                                     // Set security mechanism to
                                     // user ID and encrypted password
properties.put("encryptionAlgorithm", "2");
                                     // Request AES security
String url = "jdbc:db2://mvs1.sj.ibm.com:5021/san_jose";
                                     // Set URL for the data source
Connection con = DriverManager.getConnection(url, properties);
                                     // Create the connection
```

*For the DataSource interface:* If you create and deploy the DataSource object, you can set the user ID, password, and security mechanism by invoking the DataSource.setUser, DataSource.setPassword, and DataSource.setSecurityMechanism methods after you create the DataSource object. For example, use code like this to set the encrypted user ID and encrypted password security mechanism, with AES encryption:

```

import java.sql.*;           // JDBC base
import com.ibm.db2.jcc.*;   // IBM Data Server Driver for JDBC
                             // and SQLJ implementation of JDBC
...
com.ibm.db2.jcc.DB2SimpleDataSource ds =
    new com.ibm.db2.jcc.DB2SimpleDataSource();
    // Create the DataSource object
ds.setDriverType(4);        // Set the driver type
ds.setDatabaseName("san_jose"); // Set the location
ds.setServerName("mvs1.sj.ibm.com");
    // Set the server name
ds.setPortNumber(5021);    // Set the port number
ds.setUser("db2adm");      // Set the user ID
ds.setPassword("db2adm");  // Set the password
ds.setSecurityMechanism(
    com.ibm.db2.jcc.DB2BaseDataSource.ENCRYPTED_PASSWORD_SECURITY);
    // Set security mechanism to
    // User ID and encrypted password
ds.setEncryptionAlgorithm(2); // Request AES encryption

```

**RACF password phrase security:** If you are connecting to a DB2 for z/OS that is configured for RACF protection, and the RACF version supports RACF password phrases, you can supply a RACF password phrase for the password property value, instead of a simple password. A password phrase must conform to the following rules:

- A password phrase is a character string that can consist of mixed-case letters, numbers, and special characters, including blanks.
- The length of the password phrase can be 9 to 100 characters, or 14 to 100 characters.  
Password phrases of between 9 and 13 characters are allowed when the new-password-phrase exit (ICHPWX11) is installed on the z/OS system, and the exit allows password phrases of fewer than 14 characters.
- A password phrase must not contain the user ID, as sequential uppercase or sequential lowercase characters.
- A password phrase must contain at least two alphabetic characters (A through Z or a through z).
- A password phrase must contain at least two non-alphabetic characters (numerics, punctuation, or special characters).
- A password phrase must not contain more than two consecutive characters that are identical.
- If a single quotation mark (') is part of the password phrase, the single quotation mark must be represented as two consecutive single quotation marks (").

---

## Kerberos security under the IBM Data Server Driver for JDBC and SQLJ

JDBC support for Kerberos security is available for IBM Data Server Driver for JDBC and SQLJ type 4 connectivity only.

To enable JDBC support for Kerberos security, you also need to enable the following components of your software development kit (SDK) for Java:

- Java Cryptography Extension
- Java Generic Security Service (JGSS)
- Java Authentication and Authorization Service (JAAS)

See the documentation for your SDK for Java for information on how to enable these components.

There are three ways to specify Kerberos security for a connection:

- With a user ID and password
- Without a user ID or password
- With a delegated credential

## Kerberos security with a user ID and password

For this case, Kerberos uses the specified user ID and password to obtain a ticket-granting ticket (TGT) that lets you authenticate to the database server.

You need to set the user, password, `kerberosServerPrincipal`, and `securityMechanism` properties. Set the `securityMechanism` property to `com.ibm.db2.jcc.DB2BaseDataSource.KERBEROS_SECURITY` (11). The `kerberosServerPrincipal` property specifies the principal name that the database server registers with a Kerberos Key Distribution Center (KDC).

*For the `DriverManager` interface:* Set the user ID, password, Kerberos server, and security mechanism by setting the user, password, `kerberosServerPrincipal`, and `securityMechanism` properties in a `Properties` object, and then invoking the form of the `getConnection` method that includes the `Properties` object as a parameter. For example, use code like this to set the Kerberos security mechanism with a user ID and password:

```
import java.sql.*;           // JDBC base
import com.ibm.db2.jcc.*;    // IBM Data Server Driver for JDBC
                              // and SQLJ implementation of JDBC
...
Properties properties = new Properties(); // Create a Properties object
properties.put("user", "db2adm");      // Set user ID for the connection
properties.put("password", "db2adm");  // Set password for the connection
properties.put("kerberosServerPrincipal",
    "sample/srvlsj.ibm.com@SRVLSJ.SJ.IBM.COM");
                              // Set the Kerberos server
properties.put("securityMechanism",
    new String(" +
    com.ibm.db2.jcc.DB2BaseDataSource.KERBEROS_SECURITY + "));
                              // Set security mechanism to
                              // Kerberos
String url = "jdbc:db2://mvs1.sj.ibm.com:5021/san_jose";
                              // Set URL for the data source
Connection con = DriverManager.getConnection(url, properties);
                              // Create the connection
```

*For the `DataSource` interface:* If you create and deploy the `DataSource` object, set the Kerberos server and security mechanism by invoking the `DataSource.setKerberosServerPrincipal` and `DataSource.setSecurityMechanism` methods after you create the `DataSource` object. For example:

```
import java.sql.*;           // JDBC base
import com.ibm.db2.jcc.*;    // IBM Data Server Driver for JDBC
                              // and SQLJ implementation of JDBC
...
com.ibm.db2.jcc.DB2SimpleDataSource db2ds =
    new com.ibm.db2.jcc.DB2SimpleDataSource();
                              // Create the DataSource object
db2ds.setDriverType(4);      // Set the driver type
db2ds.setDatabaseName("san_jose"); // Set the location
db2ds.setUser("db2adm");     // Set the user
db2ds.setPassword("db2adm"); // Set the password
db2ds.setServerName("mvs1.sj.ibm.com");
                              // Set the server name
db2ds.setPortNumber(5021);   // Set the port number
db2ds.setKerberosServerPrincipal(
```



```

    "sample/srvlsj.ibm.com@SRVLSJ.SJ.IBM.COM");
                                                    // Set the Kerberos server
db2ds.setSecurityMechanism(
    com.ibm.db2.jcc.DB2BaseDataSource.KERBEROS_SECURITY);
                                                    // Set security mechanism to
                                                    // Kerberos

```

## Kerberos security with no user ID or password

For this case, the Kerberos default credentials cache must contain a ticket-granting ticket (TGT) that lets you authenticate to the database server.

You need to set the `kerberosServerPrincipal` and `securityMechanism` properties. Set the `securityMechanism` property to `com.ibm.db2.jcc.DB2BaseDataSource.KERBEROS_SECURITY` (11).

*For the DriverManager interface:* Set the Kerberos server and security mechanism by setting the `kerberosServerPrincipal` and `securityMechanism` properties in a `Properties` object, and then invoking the form of the `getConnection` method that includes the `Properties` object as a parameter. For example, use code like this to set the Kerberos security mechanism without a user ID and password:

```

import java.sql.*;                // JDBC base
import com.ibm.db2.jcc.*;         // IBM Data Server Driver for JDBC
                                    // and SQLJ implementation of JDBC
...
Properties properties = new Properties(); // Create a Properties object
properties.put("kerberosServerPrincipal",
    "sample/srvlsj.ibm.com@SRVLSJ.SJ.IBM.COM");
                                                    // Set the Kerberos server
properties.put("securityMechanism",
    new String("" +
    com.ibm.db2.jcc.DB2BaseDataSource.KERBEROS_SECURITY + ""));
                                                    // Set security mechanism to
                                                    // Kerberos
String url = "jdbc:db2://mvs1.sj.ibm.com:5021/san_jose";
                                                    // Set URL for the data source
Connection con = DriverManager.getConnection(url, properties);
                                                    // Create the connection

```

*For the DataSource interface:* If you create and deploy the `DataSource` object, set the Kerberos server and security mechanism by invoking the `DataSource.setKerberosServerPrincipal` and `DataSource.setSecurityMechanism` methods after you create the `DataSource` object. For example:

```

import java.sql.*;                // JDBC base
import com.ibm.db2.jcc.*;         // IBM Data Server Driver for JDBC
                                    // and SQLJ implementation of JDBC
...
DB2SimpleDataSource db2ds =
    new com.ibm.db2.jcc.DB2SimpleDataSource();
                                                    // Create the DataSource object
db2ds.setDriverType(4);           // Set the driver type
db2ds.setDatabaseName("san_jose"); // Set the location
db2ds.setServerName("mvs1.sj.ibm.com");
                                                    // Set the server name
db2ds.setPortNumber(5021);       // Set the port number
db2ds.setKerberosServerPrincipal(
    "sample/srvlsj.ibm.com@SRVLSJ.SJ.IBM.COM");
                                                    // Set the Kerberos server
db2ds.setSecurityMechanism(
    com.ibm.db2.jcc.DB2BaseDataSource.KERBEROS_SECURITY);
                                                    // Set security mechanism to
                                                    // Kerberos

```

## Kerberos security with a delegated credential from another principal

For this case, you authenticate to the database server using a delegated credential that another principal passes to you.

You need to set the `kerberosServerPrincipal`, `gssCredential`, and `securityMechanism` properties. Set the `securityMechanism` property to `com.ibm.db2.jcc.DB2BaseDataSource.KERBEROS_SECURITY` (11).

*For the `DriverManager` interface:* Set the Kerberos server, delegated credential, and security mechanism by setting the `kerberosServerPrincipal`, and `securityMechanism` properties in a `Properties` object. Then invoke the form of the `getConnection` method that includes the `Properties` object as a parameter. For example, use code like this to set the Kerberos security mechanism without a user ID and password:

```
import java.sql.*;           // JDBC base
import com.ibm.db2.jcc.*;    // IBM Data Server Driver for JDBC
                              // and SQLJ implementation of JDBC
...
Properties properties = new Properties(); // Create a Properties object
properties.put("kerberosServerPrincipal",
    "sample/srv1sj.ibm.com@SRVLSJ.SJ.IBM.COM");
                              // Set the Kerberos server
properties.put("gssCredential",delegatedCredential);
                              // Set the delegated credential
properties.put("securityMechanism",
    new String(" +
    com.ibm.db2.jcc.DB2BaseDataSource.KERBEROS_SECURITY + "));
                              // Set security mechanism to
                              // Kerberos
String url = "jdbc:db2://mvs1.sj.ibm.com:5021/san_jose";
                              // Set URL for the data source
Connection con = DriverManager.getConnection(url, properties);
                              // Create the connection
```

*For the `DataSource` interface:* If you create and deploy the `DataSource` object, set the Kerberos server, delegated credential, and security mechanism by invoking the `DataSource.setKerberosServerPrincipal`, `DataSource.setGssCredential`, and `DataSource.setSecurityMechanism` methods after you create the `DataSource` object. For example:

```
DB2SimpleDataSource db2ds = new com.ibm.db2.jcc.DB2SimpleDataSource();
                              // Create the DataSource object
db2ds.setDriverType(4);       // Set the driver type
db2ds.setDatabaseName("san_jose"); // Set the location
db2ds.setServerName("mvs1.sj.ibm.com"); // Set the server name
db2ds.setPortNumber(5021);    // Set the port number
db2ds.setKerberosServerPrincipal(
    "sample/srv1sj.ibm.com@SRVLSJ.SJ.IBM.COM");
                              // Set the Kerberos server
db2ds.setGssCredential(delegatedCredential);
                              // Set the delegated credential
db2ds.setSecurityMechanism(
    com.ibm.db2.jcc.DB2BaseDataSource.KERBEROS_SECURITY);
                              // Set security mechanism to
                              // Kerberos
```



---

## IBM Data Server Driver for JDBC and SQLJ security plugin support

You can create your own authentication mechanisms in the form of loadable libraries, or plugins, that DB2 Database for Linux, UNIX, and Windows loads to perform user authentication. To support development of security plugins in Java, the IBM Data Server Driver for JDBC and SQLJ provides security plugin support.

IBM Data Server Driver for JDBC and SQLJ security plugin support is available for IBM Data Server Driver for JDBC and SQLJ type 4 connectivity to DB2 Database for Linux, UNIX, and Windows servers only.

To use plugin security, you need a security plugin on the client and another plugin on the server.

The security plugins need to include the following things:

- A class that extends the `com.ibm.db2.jcc.DB2JCCPlugin` abstract class  
The `com.ibm.db2.jcc.DB2JCCPlugin` abstract class is provided with the IBM Data Server Driver for JDBC and SQLJ.
- Within the `com.ibm.db2.jcc.DB2JCCPlugin` class, a `com.ibm.db2.jcc.DB2JCCPlugin.getTicket` method  
This method retrieves a Kerberos ticket for a user and returns security context information in a byte array. The information in the byte array is used by the IBM Data Server Driver for JDBC and SQLJ to access the DB2 database server.
- Implementations of several methods that are defined in the `org.ietf.jgss.GSSContext` and `org.ietf.jgss.GSSCredential` interfaces  
These method implementations need to follow the Generic Security Service Application Program Interface, Version 2 (IETF RFC2743) and Generic Security Service API Version 2: Java-Bindings (IETF RFC2853) specifications. The plugin must implement and call the following methods:

### **GSSContext.dispose**

Releases any system resources and cryptographic information that are stored in a context object, and invalidates the context.

### **GSSContext.getCredDelegState**

Determines whether credential delegation is enabled on a context.

### **GSSContext.getMutualAuthState**

Determines whether mutual authentication is enabled on the context.

### **GSSContext.initSecContext**

Starts the context creation phase, and processes any tokens that are generated by the peer's `acceptSecContext` method.

### **GSSContext.requestCredDeleg**

Requests that the credentials of the initiator are delegated to the acceptor when a context is established.

### **GSSContext.requestMutualAuth**

Requests mutual authentication when a context is established.

### **GSSCredential.dispose**

Releases any sensitive information that the `GSSCredential` object contains.

Two Java plugin samples are provided in `sqllib/samples/java/jdbc` to help you write Java security plugins:

### JCCSimpleGSSPlugin.java

An implementation of a GSS-API plugin for the server, which performs user ID and password checking. This sample is a Java version of the C language sample program gssapi\_simple.c.

### JCKKerberosPlugin.java

A Kerberos security plugin for the client. This sample is a Java version of the C language sample program IBMkrb5.c.

When an application program obtains a connection using JDBC plugin security, it needs to set the following Connection or DataSource properties:

Table 33. Connection or DataSource property settings for Java security plugin use

Property	Setting
com.ibm.db2.jcc.DB2BaseDataSource.user	The user ID under which the Connection is to be obtained
com.ibm.db2.jcc.DB2BaseDataSource.password	The password for the user ID
com.ibm.db2.jcc.DB2BaseDataSource.securityMechanism	com.ibm.db2.jcc.DB2BaseDataSource.PLUGIN_SECURITY
com.ibm.db2.jcc.DB2BaseDataSource.pluginName	The name of the plugin module for a server-side security plugin
com.ibm.db2.jcc.DB2BaseDataSource.plugin	The plugin object for a client-side security plugin

*Example:* The following code sets the properties for a connection that uses GSS-API plugin security. The connection uses the JCCSimpleGSSPlugin sample plugin on the client side, and the gssapi\_simple sample plugin on the server side.

```
java.util.Properties properties = new java.util.Properties();
properties.put("user", "db2admin");
properties.put("password", "admindb2");
properties.put("pluginName", "gssapi_simple");
properties.put("securityMechanism",
    new String(""+com.ibm.db2.jcc.DB2BaseDataSource.PLUGIN_SECURITY+""));
com.ibm.db2.jcc.DB2JCCPlugin plugin =
    new com.ibm.db2.jcc.samples.plugins.JCCSimpleGSSplugin();
properties.put("plugin", plugin);
Connection con = java.sql.DriverManager.getConnection(url,
    properties);
```

## Use of alternative security mechanisms with the IBM Data Server Driver for JDBC and SQLJ

If you are using IBM Data Server Driver for JDBC and SQLJ type 4 connectivity, and you set the `retryWithAlternativeSecurityMechanism` to `com.ibm.db2.jcc.DB2BaseDataSource.YES (1)`, and the original security mechanism for a connection fails, the driver retries the connection with the most secure alternative security mechanism.

The following table lists the IBM Data Server Driver for JDBC and SQLJ security mechanisms, and the alternative security mechanisms that are used when the original connection has an authorization failure.

**Table 34. Original and alternative IBM Data Server Driver for JDBC and SQLJ security mechanisms**

Server authentication type	IBM Data Server Driver for JDBC and SQLJ authentication type for the original connection	IBM Data Server Driver for JDBC and SQLJ authentication type for retrying the connection
CLIENT	<ul style="list-style-type: none"> <li>• CLEAR_TEXT_PASSWORD_SECURITY</li> <li>• ENCRYPTED_PASSWORD_SECURITY</li> <li>• ENCRYPTED_USER_AND_PASSWORD_SECURITY</li> <li>• KERBEROS_SECURITY</li> <li>• ENCRYPTED_USER_AND_DATA_SECURITY</li> <li>• ENCRYPTED_USER_PASSWORD_AND_DATA_SECURITY</li> <li>• PLUGIN_SECURITY</li> <li>• ENCRYPTED_USER_ONLY_SECURITY</li> </ul>	USER_ONLY_SECURITY
	USER_ONLY_SECURITY	None. USER_ONLY_SECURITY does not fail on the original connection.
SERVER	<ul style="list-style-type: none"> <li>• USER_ONLY_SECURITY</li> <li>• ENCRYPTED_PASSWORD_SECURITY</li> <li>• ENCRYPTED_USER_AND_PASSWORD_SECURITY</li> <li>• KERBEROS_SECURITY</li> <li>• ENCRYPTED_USER_AND_DATA_SECURITY</li> <li>• ENCRYPTED_USER_PASSWORD_AND_DATA_SECURITY</li> <li>• PLUGIN_SECURITY</li> <li>• ENCRYPTED_USER_ONLY_SECURITY</li> </ul>	CLEAR_TEXT_PASSWORD_SECURITY
	CLEAR_TEXT_PASSWORD_SECURITY	None. CLEAR_TEXT_PASSWORD_SECURITY does not fail on the original connection.
SERVER_ENCRYPT for DB2 Database for Linux, UNIX, and Windows Version 8 Fix Pack 9 or earlier	<ul style="list-style-type: none"> <li>• CLEAR_TEXT_PASSWORD_SECURITY</li> <li>• USER_ONLY_SECURITY</li> <li>• KERBEROS_SECURITY</li> <li>• ENCRYPTED_USER_AND_DATA_SECURITY</li> <li>• ENCRYPTED_USER_PASSWORD_AND_DATA_SECURITY</li> <li>• PLUGIN_SECURITY</li> <li>• ENCRYPTED_USER_ONLY_SECURITY</li> </ul>	ENCRYPTED_USER_AND_PASSWORD_SECURITY
	<ul style="list-style-type: none"> <li>• ENCRYPTED_PASSWORD_SECURITY</li> <li>• ENCRYPTED_USER_AND_PASSWORD_SECURITY</li> </ul>	None. ENCRYPTED_PASSWORD_SECURITY and ENCRYPTED_USER_AND_PASSWORD_SECURITY do not fail on the original connection.
SERVER_ENCRYPT for DB2 Database for Linux, UNIX, and Windows Version 8 Fix Pack 10 or later	<ul style="list-style-type: none"> <li>• USER_ONLY_SECURITY</li> <li>• KERBEROS_SECURITY</li> <li>• ENCRYPTED_USER_AND_DATA_SECURITY</li> <li>• ENCRYPTED_USER_PASSWORD_AND_DATA_SECURITY</li> <li>• PLUGIN_SECURITY</li> <li>• ENCRYPTED_USER_ONLY_SECURITY</li> </ul>	ENCRYPTED_USER_AND_PASSWORD_SECURITY
	<ul style="list-style-type: none"> <li>• CLEAR_TEXT_PASSWORD_SECURITY</li> <li>• ENCRYPTED_PASSWORD_SECURITY</li> <li>• ENCRYPTED_USER_AND_PASSWORD_SECURITY</li> </ul>	None. CLEAR_TEXT_PASSWORD_SECURITY, ENCRYPTED_PASSWORD_SECURITY, and ENCRYPTED_USER_AND_PASSWORD_SECURITY do not fail on the original connection.
DATA_ENCRYPT	<ul style="list-style-type: none"> <li>• CLEAR_TEXT_PASSWORD_SECURITY</li> <li>• USER_ONLY_SECURITY</li> <li>• ENCRYPTED_PASSWORD_SECURITY</li> <li>• ENCRYPTED_USER_AND_PASSWORD_SECURITY</li> <li>• KERBEROS_SECURITY</li> <li>• ENCRYPTED_USER_AND_DATA_SECURITY</li> <li>• PLUGIN_SECURITY</li> <li>• ENCRYPTED_USER_ONLY_SECURITY</li> </ul>	ENCRYPTED_USER_PASSWORD_AND_DATA_SECURITY
	ENCRYPTED_USER_PASSWORD_AND_DATA_SECURITY	None. ENCRYPTED_USER_PASSWORD_AND_DATA_SECURITY does not fail on the original connection.

*Table 34. Original and alternative IBM Data Server Driver for JDBC and SQLJ security mechanisms (continued)*

Server authentication type	IBM Data Server Driver for JDBC and SQLJ authentication type for the original connection	IBM Data Server Driver for JDBC and SQLJ authentication type for retrying the connection
KERBEROS	<ul style="list-style-type: none"> <li>• CLEAR_TEXT_PASSWORD_SECURITY</li> <li>• USER_ONLY_SECURITY</li> <li>• ENCRYPTED_PASSWORD_SECURITY</li> <li>• ENCRYPTED_USER_AND_PASSWORD_SECURITY</li> <li>• ENCRYPTED_USER_AND_DATA_SECURITY</li> <li>• ENCRYPTED_USER_PASSWORD_AND_DATA_SECURITY</li> <li>• PLUGIN_SECURITY</li> <li>• ENCRYPTED_USER_ONLY_SECURITY</li> </ul>	KERBEROS_SECURITY
	KERBEROS_SECURITY	None. KERBEROS_SECURITY does not fail on the original connection.
GSSPLUGIN	<ul style="list-style-type: none"> <li>• CLEAR_TEXT_PASSWORD_SECURITY</li> <li>• USER_ONLY_SECURITY</li> <li>• ENCRYPTED_PASSWORD_SECURITY</li> <li>• ENCRYPTED_USER_AND_PASSWORD_SECURITY</li> <li>• KERBEROS_SECURITY</li> <li>• ENCRYPTED_USER_AND_DATA_SECURITY</li> <li>• ENCRYPTED_USER_PASSWORD_AND_DATA_SECURITY</li> <li>• ENCRYPTED_USER_ONLY_SECURITY</li> </ul>	PLUGIN_SECURITY
	PLUGIN_SECURITY	None. PLUGIN_SECURITY does not fail on the original connection.
KRB_SERVER_ENCRYPT	<ul style="list-style-type: none"> <li>• USER_ONLY_SECURITY</li> <li>• ENCRYPTED_USER_AND_DATA_SECURITY</li> <li>• ENCRYPTED_USER_PASSWORD_AND_DATA_SECURITY</li> <li>• ENCRYPTED_USER_ONLY_SECURITY</li> </ul>	KERBEROS_SECURITY
	<ul style="list-style-type: none"> <li>• CLEAR_TEXT_PASSWORD_SECURITY</li> <li>• ENCRYPTED_PASSWORD_SECURITY</li> <li>• ENCRYPTED_USER_AND_PASSWORD_SECURITY</li> <li>• KERBEROS_SECURITY</li> <li>• PLUGIN_SECURITY</li> </ul>	None. CLEAR_TEXT_PASSWORD_SECURITY, ENCRYPTED_PASSWORD_SECURITY, ENCRYPTED_USER_AND_PASSWORD_SECURITY, KERBEROS_SECURITY, and PLUGIN_SECURITY do not fail on the original connection.
GSS_SERVER_ENCRYPT	<ul style="list-style-type: none"> <li>• USER_ONLY_SECURITY</li> <li>• ENCRYPTED_USER_AND_DATA_SECURITY</li> <li>• ENCRYPTED_USER_PASSWORD_AND_DATA_SECURITY</li> <li>• ENCRYPTED_USER_ONLY_SECURITY</li> </ul>	KERBEROS_SECURITY
	<ul style="list-style-type: none"> <li>• CLEAR_TEXT_PASSWORD_SECURITY</li> <li>• ENCRYPTED_PASSWORD_SECURITY</li> <li>• ENCRYPTED_USER_AND_PASSWORD_SECURITY</li> <li>• KERBEROS_SECURITY</li> <li>• PLUGIN_SECURITY</li> </ul>	None. CLEAR_TEXT_PASSWORD_SECURITY, ENCRYPTED_PASSWORD_SECURITY, ENCRYPTED_USER_AND_PASSWORD_SECURITY, KERBEROS_SECURITY, and PLUGIN_SECURITY do not fail on the original connection.

## IBM Data Server Driver for JDBC and SQLJ trusted context support

The IBM Data Server Driver for JDBC and SQLJ provides methods that allow you to establish and use trusted connections in Java programs.

Trusted connections are supported for:

- IBM Data Server Driver for JDBC and SQLJ type 4 connectivity to:
  - DB2 Database for Linux, UNIX, and Windows Version 9.5 or later
  - DB2 for z/OS Version 9.1 or later
  - IBM Informix Version 11.70 or later
- IBM Data Server Driver for JDBC and SQLJ type 2 connectivity on DB2 for z/OS Version 9.1 or later

A three-tiered application model consists of a database server, a middleware server such as WebSphere Application Server, and end users. With this model, the

middleware server is responsible for accessing the database server on behalf of end users. Trusted context support ensures that an end user's database identity and database privileges are used when the middleware server performs any database requests on behalf of that end user.

A trusted context is an object that the database administrator defines that contains a system authorization ID and a set of trust attributes. Currently, for DB2 database servers, a database connection is the only type of context that is supported. The trust attributes identify a set of characteristics of a connection that are required for the connection to be considered a trusted connection. The relationship between a database connection and a trusted context is established when the connection to the database server is first created, and that relationship remains for the life of the database connection.

After a trusted context is defined, and an initial trusted connection to the data server is made, the middleware server can use that database connection under a different user without reauthenticating the new user at the database server.

To avoid vulnerability to security breaches, an application server that uses these trusted methods should not use untrusted connection methods.

The `DB2ConnectionPoolDataSource` class provides several versions of the `getDB2TrustedPooledConnection` method, and the `DB2XADataSource` class provides several versions of the `getDB2TrustedXAConnection` method, which allow an application server to establish the initial trusted connection. You choose a method based on the types of connection properties that you pass and whether you use Kerberos security. When an application server calls one of these methods, the IBM Data Server Driver for JDBC and SQLJ returns an `Object[]` array with two elements:

- The first element contains a connection instance for the initial connection.
- The second element contains a unique cookie for the connection instance. The cookie is generated by the JDBC driver and is used for authentication during subsequent connection reuse.

The `DB2PooledConnection` class provides several versions of the `getDB2Connection` method, and the `DB2Connection` class provides several versions of the `reuseDB2Connection` method, which allow an application server to reuse an existing trusted connection on behalf of a new user. The application server uses the method to pass the following items to the new user:

- The cookie from the initial connection
- New connection properties for the reused connection

The JDBC driver checks that the supplied cookie matches the cookie of the underlying trusted physical connection, to ensure that the connection request originates from the application server that established the trusted physical connection. If the cookies match, the connection becomes available for immediate use by this new user, with the new properties.

**Example:** Obtain the initial trusted connection:

```
// Create a DB2ConnectionPoolDataSource instance
com.ibm.db2.jcc.DB2ConnectionPoolDataSource dataSource =
    new com.ibm.db2.jcc.DB2ConnectionPoolDataSource();
// Set properties for this instance
dataSource.setDatabaseName ("STLEC1");
dataSource.setServerName ("v7ec167.svl.ibm.com");
dataSource.setDriverType (4);
```

```

dataSource.setPortNumber(446);
java.util.Properties properties = new java.util.Properties();
// Set other properties using
// properties.put("property", "value");
// Supply the user ID and password for the connection
String user = "user";
String password = "password";
// Call getDB2TrustedPooledConnection to get the trusted connection
// instance and the cookie for the connection
Object[] objects = dataSource.getDB2TrustedPooledConnection(
    user,password, properties);

```

**Example:** Reuse an existing trusted connection:

```

// The first item that was obtained from the previous getDB2TrustedPooledConnection
// call is a connection object. Cast it to a PooledConnection object.
javax.sql.PooledConnection pooledCon =
    (javax.sql.PooledConnection)objects[0];
properties = new java.util.Properties();
// Set new properties for the reused object using
// properties.put("property", "value");
// The second item that was obtained from the previous getDB2TrustedPooledConnection
// call is the cookie for the connection. Cast it as a byte array.
byte[] cookie = ((byte[])objects[1]);
// Supply the user ID for the new connection.
String newuser = "newuser";
// Supply the name of a mapping service that maps a workstation user
// ID to a z/OS RACF ID
String userRegistry = "registry";
// Do not supply any security token data to be traced.
byte[] userSecTkn = null;
// Do not supply a previous user ID.
String originalUser = null;
// Call getDB2Connection to get the connection object for the new
// user.
java.sql.Connection con =
    ((com.ibm.db2.jcc.DB2PooledConnection)pooledCon).getDB2Connection(
        cookie,newuser,password,userRegistry,userSecTkn,originalUser,properties);

```

---

## IBM Data Server Driver for JDBC and SQLJ support for SSL

The IBM Data Server Driver for JDBC and SQLJ provides support for the Secure Sockets Layer (SSL) through the Java Secure Socket Extension (JSSE).

You can use SSL support in your Java applications if you use IBM Data Server Driver for JDBC and SQLJ type 4 connectivity to DB2 for z/OS Version 9 or later, to DB2 Database for Linux, UNIX, and Windows Version 9.1, Fix Pack 2 or later, or to IBM Informix Version 11.50 or later.

If you use SSL support for a connection to a DB2 for z/OS data server, and the z/OS version is V1.8, V1.9, or V1.10, the appropriate PTF for APAR PK72201 must be applied to Communication Server for z/OS IP Services.

To use SSL connections, you need to:

- Configure connections to the data server to use SSL.
- Configure your Java Runtime Environment to use SSL.

## Configuring connections under the IBM Data Server Driver for JDBC and SQLJ to use SSL

To configure database connections under the IBM Data Server Driver for JDBC and SQLJ to use SSL, you need to set the `DB2BaseDataSource.sslConnection` property to `true`.

### Before you begin

Before a connection to a data source can use SSL, the port to which the application connects must be configured in the database server as the SSL listener port.

### Procedure

1. Set `DB2BaseDataSource.sslConnection` on a `Connection` or `DataSource` instance.
2. Optional: Set `DB2BaseDataSource.sslTrustStoreLocation` on a `Connection` or `DataSource` instance to identify the location of the truststore. Setting the `sslTrustStoreLocation` property is an alternative to setting the Java `javax.net.ssl.trustStore` property. If you set `DB2BaseDataSource.sslTrustStoreLocation`, `javax.net.ssl.trustStore` is not used.
3. Optional: Set `DB2BaseDataSource.sslTrustStorePassword` on a `Connection` or `DataSource` instance to identify the truststore password. Setting the `sslTrustStorePassword` property is an alternative to setting the Java `javax.net.ssl.trustStorePassword` property. If you set `DB2BaseDataSource.sslTrustStorePassword`, `javax.net.ssl.trustStorePassword` is not used.

### Example

The following example demonstrates how to set the `sslConnection` property on a `Connection` instance:

```
java.util.Properties properties = new java.util.Properties();
properties.put("user", "xxxx");
properties.put("password", "yyyy");
properties.put("sslConnection", "true");
java.sql.Connection con =
    java.sql.DriverManager.getConnection(url, properties);
```

## Configuring the Java Runtime Environment to use SSL

Before you can use Secure Sockets Layer (SSL) connections in your JDBC and SQLJ applications, you need to configure the Java Runtime Environment to use SSL. An example procedure is provided. However, the procedure might be different depending on the Java Runtime Environment that you use.

### Before you begin

Before you can configure your Java Runtime Environment for SSL, you need to satisfy the following prerequisites:

- The Java Runtime Environment must include a Java security provider. The IBM JSSE provider or the SunJSSE provider must be installed. The IBM JSSE provider is automatically installed with the IBM SDK for Java.

**Restriction:** You can only use the SunJSSE provider only with an Oracle Java Runtime Environment. The SunJSSE provider does not work with an IBM Java Runtime Environment.

- SSL support must be configured on the database server.



## About this task

To configure your Java Runtime Environment to use SSL, follow these steps.

### Procedure

1. Import a certificate from the database server to a Java truststore on the client.

Use the Java keytool utility to import the certificate into the truststore.

For example, suppose that the server certificate is stored in a file named `jcc.cacert`. Issue the following keytool utility statement to read the certificate from file `jcc.cacert`, and store it in a truststore named `cacerts`.

```
keytool -import -file jcc.cacert -keystore cacerts
```

2. Configure the Java Runtime Environment for the Java security providers by adding entries to the `java.security` file.

The format of a security provider entry is:

```
security.provider.n=provider-package-name
```

A provider with a lower value of *n* takes precedence over a provider with a higher value of *n*.

The Java security provider entries that you add depend on whether you use the IBM JSSE provider or the SunJSSE provider.

- If you use the SunJSSE provider, add entries for the Oracle security providers to your `java.security` file.
- If you use the IBM JSSE provider, use one of the following methods:
  - **Use the IBMJSSE2 provider (supported for the IBM SDK for Java 1.4.2 and later):**

**Recommendation:** Use the IBMJSSE2 provider, and use it in FIPS mode.

- If you do not need to operate in FIPS-compliant mode:
  - For the IBM SDK for Java 1.4.2, add an entry for the IBMJSSE2Provider to the `java.security` file. Ensure that an entry for the IBMJCE provider is in the `java.security` file. The `java.security` file that is shipped with the IBM SDK for Java contains an entry for entries for IBMJCE.
  - For later versions of the IBM SDK for Java, ensure that entries for the IBMJSSE2Provider and the IBMJCE provider are in the `java.security` file. The `java.security` file that is shipped with the IBM SDK for Java contains entries for those providers.
- If you need to operate in FIPS-compliant mode:
  - Add an entry for the IBMJCEFIPS provider to your `java.security` file before the entry for the IBMJCE provider. Do not remove the entry for the IBMJCE provider.
  - Enable FIPS mode in the IBMJSSE2 provider. See step 3 on page 220.
- **Use the IBMJSSE provider (supported for the IBM SDK for Java 1.4.2 only):**
  - If you do not need to operate in FIPS-compliant mode, ensure that entries for the IBMJSSEProvider and the IBMJCE provider are in the `java.security` file. The `java.security` file that is shipped with the IBM SDK for Java contains entries for those providers.
  - If you need to operate in FIPS-compliant mode, add entries for the FIPS-approved provider IBMJSSEFIPSProvider and the IBMJCEFIPS provider to your `java.security` file, before the entry for the IBMJCE provider.



**Restriction:** If you use the IBMJSSE provider on the Solaris operating system, you need to include an entry for the SunJSSE provider before entries for the IBMJCE, IBMJCEFIPS, IBMJSSE, or IBMJSSE2 providers.

**Example:** Use a `java.security` file similar to this one if you need to run in FIPS-compliant mode, and you enable FIPS mode in the IBMJSSE2 provider:

```
# Set the Java security providers
security.provider.1=com.ibm.jsse2.IBMJSSEProvider2
security.provider.2=com.ibm.crypto.fips.provider.IBMJCEFIPS
security.provider.3=com.ibm.crypto.provider.IBMJCE
security.provider.4=com.ibm.security.jgss.IBMJGSSProvider
security.provider.5=com.ibm.security.cert.IBMCertPath
security.provider.6=com.ibm.security.sasl.IBMSASL
```

**Example:** Use a `java.security` file similar to this one if you need to run in FIPS-compliant mode, and you use the IBMJSSE provider:

```
# Set the Java security providers
security.provider.1=com.ibm.fips.jsse.IBMJSSEFIPSProvider
security.provider.2=com.ibm.crypto.fips.provider.IBMJCEFIPS
security.provider.3=com.ibm.crypto.provider.IBMJCE
security.provider.4=com.ibm.security.jgss.IBMJGSSProvider
security.provider.5=com.ibm.security.cert.IBMCertPath
security.provider.6=com.ibm.security.sasl.IBMSASL
```

**Example:** Use a `java.security` file similar to this one if you use the SunJSSE provider:

```
# Set the Java security providers
security.provider.1=sun.security.provider.Sun
security.provider.2=com.sun.rsa.jca.Provider
security.provider.3=com.sun.crypto.provider.SunJCE
security.provider.4=com.sun.net.ssl.internal.ssl.Provider
```

3. If you plan to use the IBM Data Server Driver for JDBC and SQLJ in FIPS-compliant mode, you need to set the `com.ibm.jsse2.JSSEFIPS` Java system property:

```
com.ibm.jsse2.JSSEFIPS=true
```

**Restriction:** Non-FIPS-mode JSSE applications cannot run in a JVM that is in FIPS mode.

**Restriction:** When the IBMJSSE2 provider runs in FIPS mode, it cannot use hardware cryptography.

4. Configure the Java Runtime Environment for the SSL socket factory providers by adding entries to the `java.security` file. This step is not necessary if you are using the SunJSSE provider and the Java Runtime Environment, 7 or later.

The format of SSL socket factory provider entries are:

```
ssl.SocketFactory.provider=provider-package-name
ssl.ServerSocketFactory.provider=provider-package-name
```

Specify the SSL socket factory provider for the Java security provider that you are using.

**Example:** Include SSL socket factory provider entries like these in the `java.security` file when you enable FIPS mode in the IBMJSSE2 provider:

```
# Set the SSL socket factory provider
ssl.SocketFactory.provider=com.ibm.jsse2.SSLSocketFactoryImpl
ssl.ServerSocketFactory.provider=com.ibm.jsse2.SSLServerSocketFactoryImpl
```

**Example:** Include SSL socket factory provider entries like these in the `java.security` file when you enable FIPS mode in the IBMJSSE provider:

```
# Set the SSL socket factory provider
ssl.SocketFactory.provider=com.ibm.fips.jsse.JSSESocketFactory
ssl.ServerSocketFactory.provider=com.ibm.fips.jsse.JSSEServerSocketFactory
```

**Example:** Include SSL socket factory provider entries like these when you use the SunJSSE provider, and the Java Runtime Environment, 6 or earlier:

```
# Set the SSL socket factory provider
ssl.SocketFactory.provider=com.sun.net.ssl.internal.ssl.SSLSocketFactoryImpl
ssl.ServerSocketFactory.provider=com.sun.net.ssl.internal.ssl.SSLServerSocketFactoryImpl
```

5. Configure Java system properties to use the truststore.

To do that, set the following Java system properties:

**javax.net.ssl.trustStore**

Specifies the name of the truststore that you specified with the -keystore parameter in the keytool utility in step 1 on page 219.

If the IBM Data Server Driver for JDBC and SQLJ property DB2BaseDataSource.sslTrustStoreLocation is set, its value overrides the javax.net.ssl.trustStore property value.

**javax.net.ssl.trustStorePassword (optional)**

Specifies the password for the truststore. You do not need to set a truststore password. However, if you do not set the password, you cannot protect the integrity of the truststore.

If the IBM Data Server Driver for JDBC and SQLJ property DB2BaseDataSource.sslTrustStorePassword is set, its value overrides the javax.net.ssl.trustStorePassword property value.

**Example:** One way that you can set Java system properties is to specify them as the arguments of the -D option when you run a Java application. Suppose that you want to run a Java application named MySSL.java, which accesses a data source using an SSL connection. You have defined a truststore named cacerts. The following command sets the truststore name when you run the application.

```
java -Djavax.net.ssl.trustStore=cacerts MySSL
```

---

## Security for preparing SQLJ applications with the IBM Data Server Driver for JDBC and SQLJ

You can provide security during SQLJ application preparation by allowing users to customize applications only and limiting access to a specific set of tables during customization. If the target data server is DB2 for z/OS, you can also provide security by allowing customers to prepare but not execute applications.

### Allowing users to customize only

You can use one of the following techniques to allow a set of users to customize SQLJ applications, but not to bind or run those applications:

- **Create a database system for customization only (recommended solution):**

Follow these steps:

1. Create a new database manager instance. This is the customization-only system.
2. On the customization-only system, define all the tables and views that are accessed by the SQLJ applications. The table or view definitions must be the same as the definitions on the database manager instance where the application will be bound and will run (the bind-and-run system). Executing the DESCRIBE statement on the tables or views must give the same results on the customization-only system and the bind-and-run system.
3. On the customization-only system, grant the necessary table or view privileges to users who will customize SQLJ applications.

4. On the customization-only system, users run the sqlj command with the -compile=true option to create Java byte codes and serialized profiles for their programs. Then they run the db2sqljcustomize command with the -automaticbind NO option to create customized serialized profiles.
  5. Copy the java byte code files and customized serialized profiles to the bind-and-run system.
  6. A user with authority to bind packages on the bind-and-run system runs the db2sqljbind command on the customized serialized profiles that were copied from the customization-only system.
- **Use a stored procedure to do customization:** Write a Java stored procedure that customizes serialized profiles and binds packages for SQLJ applications on behalf of the end user. This Java stored procedure needs to use a JDBC driver package that was bound with one of the DYNAMICRULES options that causes dynamic SQL to be performed under a different user ID from the end user's authorization ID. For example, you might use the DYNAMICRULES option DEFINEBIND or DEFINERUN to execute dynamic SQL under the authorization ID of the creator of the Java stored procedure. You need to grant EXECUTE authority on the stored procedure to users who need to do SQLJ customization. The stored does the following things:
    1. Receives the compiled SQLJ program and serialized profiles in BLOB input parameters
    2. Copies the input parameters to its file system
    3. Runs db2sqljcustomize to customize the serialized profiles and bind the packages for the SQLJ program
    4. Returns the customized serialized profiles in output parameters
  - **Use a stand-alone program to do customization:** This technique involves writing a program that performs the same steps as a Java stored procedure that customizes serialized profiles and binds packages for SQLJ applications on behalf of the end user. However, instead of running the program as a stored procedure, you run the program as a stand-alone program under a library server.

## Allowing users to customize and bind only

If the target data server is DB2 for z/OS Version 10 or later, you can allow users to customize and bind SQLJ applications, but not to execute the SQL statements in them, by granting those users the EXPLAIN privilege.

## Restricting table access during customization

When you customize serialized profiles, you should do online checking, to give the application program information about the data types and lengths of table columns that the program accesses. By default, customization includes online checking.

Online checking requires that the user who customizes a serialized profile has authorization to execute PREPARE and DESCRIBE statements against SQL statements in the SQLJ program. That authorization includes the SELECT privilege on tables and views that are accessed by the SQL statements. If SQL statements contain unqualified table names, the qualifier that is used during online checking is the value of the db2sqljcustomize -qualifier parameter. Therefore, for online checking of tables and views with unqualified names in an SQLJ application, you can grant the SELECT privilege only on tables and views with a qualifier that matches the value of the -qualifier parameter.

---

## Chapter 6. Building Java database applications

You can build JDBC and SQLJ database applications manually. Alternatively, you can use a Java makefile to build JDBC applications, and use the `bldsqlj` build file that is shipped with DB2 Database for Linux, UNIX, and Windows to build SQLJ applications.

---

### Building JDBC applets

You can use a Java makefile or manually execute the `javac` command to build JDBC applications.

#### About this task

The following steps demonstrate how to build and run the `Applt.java` sample JDBC applet.

#### Procedure

1. Compile `Applt.java` to produce the file `Applt.class` with this command:

```
javac Applt.java
```

2. Ensure that your working directory is accessible by your web browser, or by your Java applet viewer, if you are using it. If your directory is not accessible, copy the following files into a directory that is accessible:
  - `Applt.html`
  - `Applt.class`
3. Copy `sqllib\java\db2jcc.jar` on Windows or `sqllib/java/db2jcc.jar` on UNIX, into the same directory as `Applt.class` and `Applt.html`.

If you are using any JDBC 4.0 or later functions, copy `db2jcc4.jar` instead of `db2jcc.jar`.

4. If you are using the IBM Data Server Driver for JDBC and SQLJ, connect with that driver by modifying the `Applt.html` file according to the instructions in the file. For the TCP/IP port number, you should use the database port number 50000.
5. To run this applet, either ensure that a web server is installed and running on your DB2 machine (server or client), or you can use the applet viewer that comes with the SDK for Java by entering the following command in the working directory of your client machine:

```
appletviewer Applt.html
```

---

### Building JDBC applications

You can use a Java makefile or manually execute the `javac` command to build JDBC applications.

#### About this task

The following steps demonstrate how to build and run the `DbInfo` sample JDBC application.

## Procedure

1. Compile DbInfo.java to produce the file DbInfo.class with this command:  

```
javac DbInfo.java
```
2. If you are running a Java application on UNIX in a 64-bit DB2 instance but the software development kit for Java is 32-bit, you need to change the DB2 library path before running the application. For example, on AIX:
  - If using bash or Korn shell:  

```
export LIBPATH=$HOME/sqllib/lib32
```
  - If using C shell:  

```
setenv LIBPATH $HOME/sqllib/lib32
```
3. Run the Java interpreter on the application with this command:  

```
java DbInfo
```

---

## Building JDBC routines

You can use a Java makefile or the javac command to build JDBC routines. After you build those routines, you need to catalog them.

### About this task

The following steps demonstrate how to build and run these routines:

- The SpServer sample JDBC stored procedure
- The UDFsrv sample user-defined function, which has no SQL statements
- The UDFsqlsv sample user-defined function, which has SQL statements

### Procedure

- To build and run the SpServer.java stored procedure on the server, from the command line:
  1. Compile SpServer.java to produce the file SpServer.class with this command:  

```
javac SpServer.java
```
  2. Copy SpServer.class to the sqllib\function directory on Windows operating systems, or to the sqllib/function directory on UNIX.
  3. Catalog the routines by running the spcat script on the server. The spcat script connects to the sample database, uncatalogs the routines if they were previously cataloged by calling SpDrop.db2, then catalogs them by calling SpCreate.db2, and finally disconnects from the database. You can also run the SpDrop.db2 and SpCreate.db2 scripts individually.
  4. Stop and restart the database to allow the new class file to be recognized. If necessary, set the file mode for the class file to "read" so it is readable by the fenced user.
  5. Compile and run the SpClient client application to access the stored procedure class.
- To build and run the UDFsrv.java user-defined function program (user-defined function with no SQL statements) on the server, from the command line:
  1. Compile UDFsrv.java to produce the file UDFsrv.class with this command:  

```
javac UDFsrv.java
```
  2. Copy UDFsrv.class to the sqllib\function directory on Windows operating systems, or to the sqllib/function directory on UNIX.
  3. Compile and run a client program that calls UDFsrv.

To access the UDFsrv library, you can use the UDFcli.java JDBC application, or the UDFcli.sqlj SQLJ client application. Both versions of the client program contain the CREATE FUNCTION SQL statement that you use to register the user-defined functions with the database, and also contain SQL statements that use the user-defined functions.

- To build and run the UDFsqlsv.java user-defined function program (user-defined function with SQL statements) on the server, from the command line:

1. Compile UDFsqlsv.java to produce the file UDFsqlsv.class with this command:

```
javac UDFsqlsv.java
```

2. Copy UDFsqlsv.class to the sqllib\function directory on Windows operating systems, or to the sqllib/function directory on UNIX.
3. Compile and run a client program that calls UDFsqlsv.

To access the UDFsqlsv library, you can use the UDFsqlcl.java JDBC application. The client program contains the CREATE FUNCTION SQL statement that you use to register the user-defined functions with the database, and also contains SQL statements that use the user-defined functions.

---

## Building SQLJ applets

You can use a Java makefile or the bldsqlj build file to build SQLJ applets.

### About this task

The following steps demonstrate how to build and run the Applet sample SQLJ applet. These steps use the build file, bldsqlj (UNIX), or bldsqlj.bat (Windows), which contains commands to build either an SQLJ applet or application.

The build file takes up to six parameters: \$1, \$2, \$3, \$4, \$5, and \$6 on UNIX, and %1, %2, %3, %4, %5, and %6 on Windows. The first parameter specifies the name of your program. The second parameter specifies the user ID for the database instance, the third parameter specifies the password. The fourth parameter specifies the server name. The fifth parameter specifies the port number. And the sixth parameter specifies the database name. For all but the first parameter, program name, default values can be used. See the build file for details about using default parameter values.

### Procedure

1. Build the applet with this command:

```
bldsqlj Applet <userid> <password> <server_name> <port_number> <db_name>
```

2. Ensure that your working directory is accessible by your web browser, or by your Java applet viewer, if you are using it. If your directory is not accessible, copy the following files into a directory that is accessible:

- Applet.html
- Applet.class
- Applet\_Cursor1.class
- Applet\_Cursor2.class
- Applet\_SJProfileKeys.class
- Applet\_SJProfile0.ser

3. Copy sqllib\java\db2jcc.jar on Windows or sqllib/java/db2jcc.jar on UNIX, into the same directory as Applet.class and Applet.html.

If you are using any JDBC 4.0 or later functions, copy db2jcc4.jar instead of db2jcc.jar.

4. If you are using the IBM Data Server Driver for JDBC and SQLJ, connect with that driver by modifying the App1t.html file according to the instructions in the file. For the TCP/IP port number, you should use the database port number 50000.
5. To run this applet, either ensure that a web server is installed and running on your DB2 machine (server or client), or you can use the applet viewer that comes with the SDK for Java by entering the following command in the working directory of your client machine:

```
appletviewer App1t.html
```

---

## Building SQLJ applications

You can use a Java makefile or the bldsqlj build file to build SQLJ applications.

### About this task

The following steps demonstrate how to build and run the TbMod sample SQLJ application. These steps use the build file, bldsqlj (UNIX), or bldsqlj.bat (Windows), which contains commands to build either an SQLJ applet or application.

The build file takes up to six parameters: \$1, \$2, \$3, \$4, \$5, and \$6 on UNIX, and %1, %2, %3, %4, %5, and %6 on Windows. The first parameter specifies the name of your program. The second parameter specifies the user ID for the database instance, the third parameter specifies the password. The fourth parameter specifies the server name. The fifth parameter specifies the port number. And the sixth parameter specifies the database name. For all but the first parameter, program name, default values can be used. See the build file for details about using default parameter values.

### Procedure

1. Build the application with this command:

```
bldsqlj TbMod <userid> <password> <server_name> <port_number> <db_name>
```
2. If you are running a Java application on UNIX in a 64-bit DB2 instance but the software development kit for Java is 32-bit, you need to change the DB2 library path before running the application. For example, on AIX:
  - If using bash or Korn shell:

```
export LIBPATH=$HOME/sql1lib/lib32
```
  - If using C shell:

```
setenv LIBPATH $HOME/sql1lib/lib32
```
3. Run the Java interpreter on the application with this command:

```
java TbMod
```

---

## Java applet considerations

DB2 databases can be accessed by using Java applets.

Keep the following points in mind when using them:

- For a larger JDBC or SQLJ applet that consists of several Java classes, you might choose to package all its classes in a single JAR file. For an SQLJ applet, you would also have to package its serialized profiles along with its classes. If you



choose to do this, add your JAR file into the archive parameter in the "applet" tag. For details, see the documentation for your software development kit for Java.

For SQLJ applets, some browsers do not yet have support for loading a serialized object from a resource file associated with the applet. For example, you will get the following error message when trying to load the supplied sample applet `Applt` in those browsers:

```
java.lang.ClassNotFoundException: Applt_SJProfile0
```

As a workaround, there is a utility which converts a serialized profile into a profile stored in Java class format. The utility is a Java class called `sqlj.runtime.profile.util.SerProfileToClass`. It takes a serialized profile resource file as input and produces a Java class containing the profile as output. Your profile can be converted using one of the following commands:

```
profconv Applt_SJProfile0.ser
```

or

```
java sqlj.runtime.profile.util.SerProfileToClass Applt_SJProfile0.ser
```

The class `Applt_SJProfile0.class` is created as a result. Replace all profiles in `.ser` format used by the applet with profiles in `.class` format, and the problem should go away.

- You can place the file `db2jcc.jar` into a directory that is shared by several applets that might be loaded from your Web site. `db2jcc.jar` is for applets using the IBM Data Server Driver for JDBC and SQLJ or for any SQLJ applet. This file is in the `sqllib\java` directory on Windows operating systems, and in the `sqllib/java` directory on UNIX. You might need to add a `codebase` parameter into the "applet" tag in the HTML file to identify the directory. For details, see the documentation for your software development kit for Java.

If you are using any JDBC 4.0 or later functions, copy `db2jcc4.jar` instead of `db2jcc.jar`.

- The JDBC applet server (listener), `db2jd`, contains signal handling to make it more robust. As a result, you cannot use the CTRL-C key sequence to terminate `db2jd`. Therefore, the only way to terminate the listener is to kill the process by using `kill -9` (for UNIX) or the Task Manager (for Windows).

---

## SQLJ application and applet options for UNIX

The `bldsqlj` build script builds SQLJ applications and applets on UNIX operating systems. `bldsqlj` specifies a set of SQLJ translator and customizer options.

**Recommendation:** Use the same SQLJ translator and customizer options that `bldsqlj` uses when you build your SQLJ applications and applets on UNIX platforms.

The options that `bldsqlj` includes are:

**sqlj** The SQLJ translator (also compiles the program).

**"\${progname}.sqlj"**

The SQLJ source file. The `progname=${1%.sqlj}` command removes the extension if it was included in the input file name, so when the extension is added back again, it is not duplicated.

**db2sqljcustomize**

The SQLJ profile customizer.



- url** Specifies a JDBC URL for establishing a database connection, such as `jdbc:db2://servername:50000/sample`.
  - user** Specifies a user ID.
  - password**  
Specifies a password.
  - "\${progname}\_SJProfile0"**  
Specifies a serialized profile for the program.
- 

## SQLJ application and applet options for Windows

The `bldsq1j.bat` batch file builds SQLJ applications and applets on Windows operating systems. `bldsq1j.bat` specifies a set of SQLJ translator and customizer options.

**Recommendation:** Use the same SQLJ translator and customizer options that `bldsq1j.bat` uses when you build your SQLJ applications and applets on Windows operating systems.

The options that `bldsq1j.bat` includes are:

**sqlj** The SQLJ translator (also compiles the program).

**%1.sqlj**  
The SQLJ source file.

**db2sqljcustomize**  
The SQLJ profile customizer.

**-url** Specifies a JDBC URL for establishing a database connection, such as `jdbc:db2://servername:50000/sample`.

**-user** Specifies a user ID.

**-password**  
Specifies a password.

**%1\_SJProfile0**  
Specifies a serialized profile for the program.

---

## Building SQL routines

You can use a Java `makefile` or the `bldsq1js` build file to build SQLJ routines. After you build those routines, you need to catalog them.

### About this task

The following steps demonstrate how to build and run the `SpServer` sample SQLJ stored procedure. These steps use the build file, `bldsq1js` (UNIX), or `bldsq1js.bat` (Windows), which contains commands to build either an SQLJ applet or application.

The build file takes up to six parameters: `$1`, `$2`, `$3`, `$4`, `$5`, and `$6` on UNIX, and `%1`, `%2`, `%3`, `%4`, `%5`, and `%6` on Windows. The first parameter specifies the name of your program. The second parameter specifies the user ID for the database instance, the third parameter specifies the password. The fourth parameter specifies the server name. The fifth parameter specifies the port number. And the sixth parameter specifies the database name. For all but the first parameter,

program name, default values can be used. See the build file for details about using default parameter values.

## Procedure

1. Build the stored procedure application with this command:

```
bldsqljs SpServer <userid> <password> <server_name> <port_number> <db_name>
```

2. Catalog the stored procedure with this command:

```
spcat
```

This script connects to the sample database, uncatalogs the routines if they were previously cataloged by calling SpDrop.db2, then catalogs them by calling SpCreate.db2, and finally disconnects from the database. You can also run the SpDrop.db2 and SpCreate.db2 scripts individually.

3. Stop and restart the database to allow the new class file to be recognized. If necessary, set the file mode for the class file to read, so it is readable by the fenced user.
4. Compile and run the SpClient client application to access the stored procedure class. You can build SpClient with the application build file, bldsqlj (UNIX) or bldsqlj.bat (Windows).

---

## SQLJ routine options for UNIX

The bldsqljs build script builds SQLJ routines on UNIX operating systems. bldsqljs specifies a set of SQLJ translator and customizer options.

**Recommendation:** Use the same SQLJ translator and customizer options that bldsqljs uses when you build your SQLJ routines on UNIX platforms.

The options that bldsqljs includes are:

**sqlj** The SQLJ translator (also compiles the program).

**"\${programe}.sqlj"**

The SQLJ source file. The programe=\${1%.sqlj} command removes the extension if it was included in the input file name, so when the extension is added back again, it is not duplicated.

**db2sqljcustomize**

The SQLJ profile customizer.

**-url** Specifies a JDBC URL for establishing a database connection, such as jdbc:db2://servername:50000/sample.

**-user** Specifies a user ID.

**-password**

Specifies a password.

**"\${programe}\_SJProfile0"**

Specifies a serialized profile for the program.

---

## SQLJ routine options for Windows

The bldsqljs.bat batch file builds SQLJ routines on Windows operating systems. bldsqljs.bat specifies a set of SQLJ translator and customizer options.

**Recommendation:** Use the same SQLJ translator and customizer options that `bldsqljs.bat` uses when you build your SQLJ routines on Windows operating systems.

The following SQLJ translator and customizer options are used in the `bldsqljs.bat` batch file on Windows operating systems. These are the options DB2 recommends that you use to build SQLJ routines (stored procedures and user-defined functions).

**sqlj** The SQLJ translator (also compiles the program).

**%1.sqlj**

The SQLJ source file.

**db2sqljcustomize**

The DB2 for Java profile customizer.

**-url** Specifies a JDBC URL for establishing a database connection, such as `jdbc:db2://servername:50000/sample`.

**-user** Specifies a user ID.

**-password**

Specifies a password.

**%1\_SJProfile0**

Specifies a serialized profile for the program.

---

## Chapter 7. Problem diagnosis with the IBM Data Server Driver for JDBC and SQLJ

The IBM Data Server Driver for JDBC and SQLJ includes diagnostic tools and traces for diagnosing problems during connection and SQL statement execution.

### Testing a data server connection

Run the DB2Jcc utility to test a connection to a data server. You provide DB2Jcc with the URL for the data server, for IBM Data Server Driver for JDBC and SQLJ type 4 connectivity or IBM Data Server Driver for JDBC and SQLJ type 2 connectivity. DB2Jcc attempts to connect to the data server, and to execute an SQL statement and a DatabaseMetaData method. If the connection or statement execution fails, DB2Jcc provides diagnostic information about the failure.

### Collecting JDBC trace data

Use one of the following procedures to start the trace:

*Procedure 1:* For IBM Data Server Driver for JDBC and SQLJ type 4 connectivity or IBM Data Server Driver for JDBC and SQLJ type 2 connectivity for DB2 for Linux, UNIX and Windows, the recommended method is to start the trace by setting the `db2.jcc.override.traceFile` property or the `db2.jcc.override.traceDirectory` property in the IBM Data Server Driver for JDBC and SQLJ configuration properties file. You can set the `db2.jcc.tracePolling` and `db2.jcc.tracePollingInterval` properties before you start the driver to allow you to change global configuration trace properties while the driver is running.

*Procedure 2:* If you use the `DataSource` interface to connect to a data source, follow this method to start the trace:

1. Invoke the `DB2BaseDataSource.setTraceLevel` method to set the type of tracing that you need. The default trace level is `TRACE_ALL`. See "Properties for the IBM Data Server Driver for JDBC and SQLJ" for information on how to specify more than one type of tracing.
2. Invoke the `DB2BaseDataSource.setJccLogWriter` method to specify the trace destination and turn the trace on.

*Procedure 3:*

If you use the `DataSource` interface to connect to a data source, invoke the `javax.sql.DataSource.setLogWriter` method to turn the trace on. With this method, `TRACE_ALL` is the only available trace level.

If you use the `DriverManager` interface to connect to a data source, follow this procedure to start the trace.

1. Invoke the `DriverManager.getConnection` method with the `traceLevel` property set in the *info* parameter or *url* parameter for the type of tracing that you need. The default trace level is `TRACE_ALL`. See "Properties for the IBM Data Server Driver for JDBC and SQLJ" for information on how to specify more than one type of tracing.

2. Invoke the `DriverManager.setLogWriter` method to specify the trace destination and turn the trace on.

After a connection is established, you can turn the trace off or back on, change the trace destination, or change the trace level with the `DB2Connection.setJccLogWriter` method. To turn the trace off, set the `logWriter` value to `null`.

The `logWriter` property is an object of type `java.io.PrintWriter`. If your application cannot handle `java.io.PrintWriter` objects, you can use the `traceFile` property to specify the destination of the trace output. To use the `traceFile` property, set the `logWriter` property to `null`, and set the `traceFile` property to the name of the file to which the driver writes the trace data. This file and the directory in which it resides must be writable. If the file already exists, the driver overwrites it.

*Procedure 4:* If you are using the `DriverManager` interface, specify the `traceFile` and `traceLevel` properties as part of the URL when you load the driver. For example:

```
String url = "jdbc:db2://sysmvs1.stl.ibm.com:5021/san_jose" +
":traceFile=/u/db2p/jcctrace;" +
"traceLevel=" + com.ibm.db2.jcc.DB2BaseDataSource.TRACE_DRDA_FLOWS + ";";
```

*Procedure 5:* Use `DB2TraceManager` methods. The `DB2TraceManager` class provides the ability to suspend and resume tracing of any type of log writer.

*Example of starting a trace using configuration properties:* For a complete example of using configuration parameters to collect trace data, see "Example of using configuration properties to start a JDBC trace".

*Trace example program:* For a complete example of a program for tracing under the IBM Data Server Driver for JDBC and SQLJ, see "Example of a trace program under the IBM Data Server Driver for JDBC and SQLJ".

## Collecting SQLJ trace data during customization or bind

To collect trace data to diagnose problems during the SQLJ customization or bind process, specify the `-tracelevel` and `-tracefile` options when you run the `db2sqljcustomize` or `db2sqljbind` utility.

## Formatting information about an SQLJ serialized profile

The `profp` utility formats information about each SQLJ clause in a serialized profile. The format of the `profp` utility is:

►►—`profp—serialized-profile-name`—◄◄

Run the `profp` utility on the serialized profile for the connection in which the error occurs. If an exception is thrown, a Java stack trace is generated. You can determine which serialized profile was in use when the exception was thrown from the stack trace.

## Formatting information about an SQLJ customized serialized profile

The `db2sqljprint` utility formats information about each SQLJ clause in a serialized profile that is customized for the IBM Data Server Driver for JDBC and SQLJ.

Run the `db2sqljprint` utility on the customized serialized profile for the connection in which the error occurs.

---

## DB2Jcc - IBM Data Server Driver for JDBC and SQLJ diagnostic utility

DB2Jcc verifies that a data server is configured for database access.

To verify the connection, DB2Jcc connects to the specified data server, executes an SQL statement, and executes a `java.sql.DatabaseMetadata` method.

### Authorization

The user ID under which DB2Jcc runs must have the authority to connect to the specified data server and to execute the specified SQL statement.

### DB2Jcc Syntax

```
▶▶ java com.ibm.db2.jcc.DB2Jcc [_version] [_configuration] [_help]  
  
▶▶ [_url-spec] [_user user-ID password password] [_sql-spec] [_tracing]
```

#### url-spec:

```
▶▶ [_url] jdbc:db2://server [_:port] /database  
▶▶ jdbc:db2:database
```

#### sql-spec:

```
▶▶ [_sql] 'SELECT * FROM SYSIBM.SYSDUMMY1'  
▶▶ [_sql] 'sql-statement'
```

### DB2Jcc parameters

#### -help

Specifies that DB2Jcc describes each of the options that it supports. If any other options are specified with `-help`, they are ignored.

#### -version

Specifies that DB2Jcc displays the driver name and version.

#### -configuration

Specifies that DB2Jcc displays driver configuration information.

**-url**

Specifies the URL for the data server for which the connection is being tested. The URL can be a URL for IBM Data Server Driver for JDBC and SQLJ type 2 connectivity or IBM Data Server Driver for JDBC and SQLJ type 4 connectivity. The variable parts of the `-url` value are:

**server**

The domain name or IP address of the operating system on which the database server resides. *server* is used only for type 4 connectivity.

**port**

The TCP/IP server port number that is assigned to the data server. The default is 446. *port* is used only for type 4 connectivity.

**database**

A name for the database server for which the profile is to be customized.

If the connection is to a DB2 for z/OS server, *database* is the DB2 location name that is defined during installation. All characters in this value must be uppercase characters. You can determine the location name by executing the following SQL statement on the server:

```
SELECT CURRENT SERVER FROM SYSIBM.SYSDUMMY1;
```

If the connection is to a DB2 Database for Linux, UNIX, and Windows server, *database* is the database name that is defined during installation.

If the connection is to an IBM Informix data server, *database* is the database name. The name is case-insensitive. The server converts the name to lowercase.

If the connection is to an IBM Cloudscape server, the *database* is the fully-qualified name of the file that contains the database. This name must be enclosed in double quotation marks ("). For example:

```
"c:/databases/testdb"
```

**-user *user-ID***

Specifies the user ID that is to be used to test the connection to the data server.

**-password *password***

Specifies the password for the user ID that is to be used to test the connection to the data server.

**-sql '*sql-statement*'**

Specifies the SQL statement that is sent to the data server to verify the connection. If the `-sql` parameter is not specified, this SQL statement is sent to the data server:

```
SELECT * FROM SYSIBM.SYSDUMMY1
```

**-tracing**

Specifies that tracing is enabled. The trace destination is `System.out`.

If you omit the `-tracing` parameter, tracing is disabled.

## Examples

**Example:** Test the connection to a data server using IBM Data Server Driver for JDBC and SQLJ type 4 connectivity. Use the default SQL statement to test the connection. Enable tracing for the test.

```
java com.ibm.db2.jcc.DB2Jcc
-url jdbc:db2://mysys.myloc.svl.ibm.com:446/MYDB
-user db2user -password db2pass -tracing
```

**Example:** Test the connection to a data server using IBM Data Server Driver for JDBC and SQLJ type 2 connectivity. Use the following SQL statement to test the connection:

```
SELECT COUNT(*) FROM EMPLOYEE
```

Disable tracing for the test.

```
java com.ibm.db2.jcc.DB2Jcc
-ur1 jdbc:db2:MYDB
-user db2user -password db2pass
-sql 'SELECT COUNT(*) FROM EMPLOYEE'
```

---

## Examples of using configuration properties to start a JDBC trace

You can control tracing of JDBC applications without modifying those applications.

### Example of writing trace data to one trace file for each connection

Suppose that you want to collect trace data for a program named Test.java, which uses IBM Data Server Driver for JDBC and SQLJ type 4 connectivity. Test.java does no tracing, and you do not want to modify the program, so you enable tracing using configuration properties. You want your trace output to have the following characteristics:

- Trace information for each connection on the same DataSource is written to a separate trace file. Output goes into a directory named /Trace.
- Each trace file name begins with jccTrace1.
- If trace files with the same names already exist, the trace data is appended to them.

Although Test.java does not contain any code to do tracing, you want to set the configuration properties so that if the application is modified in the future to do tracing, the settings within the program will take precedence over the settings in the configuration properties. To do that, use the set of configuration properties that begin with db2.jcc, not db2.jcc.override.

The configuration property settings look like this:

- db2.jcc.traceDirectory=/Trace
- db2.jcc.traceFile=jccTrace1
- db2.jcc.traceFileAppend=true

You want the trace settings to apply only to your stand-alone program Test.java, so you create a file with these settings, and then refer to the file when you invoke the Java program by specifying the -Ddb2.jcc.propertiesFile option. Suppose that the file that contains the settings is /Test/jcc.properties. To enable tracing when you run Test.java, you issue a command like this:

```
java -Ddb2.jcc.propertiesFile=/Test/jcc.properties Test
```

Suppose that Test.java creates two connections for one DataSource. The program does not define a logWriter object, so the driver creates a global logWriter object for the trace output. When the program completes, the following files contain the trace data:

- /Trace/jccTrace1\_global\_0
- /Trace/jccTrace1\_global\_1



## Example of doing a circular trace with a fixed number of files and fixed file size

Suppose that you want to collect trace data for a program named `Test.java`, which uses IBM Data Server Driver for JDBC and SQLJ type 4 connectivity. `Test.java` does no tracing, and you do not want to modify the program, so you enable tracing using configuration properties. You want your trace output to have the following characteristics:

- Trace information for each connection on the same `DataSource` is written to a separate set of trace files.
- The maximum number of trace files that are written for each connection is 4.
- When all trace files are full, the trace overwrites existing trace data, beginning with the first trace file that was written.
- The maximum size of each trace file is 4 MB.
- Each trace file name begins with `jcc.log`, and is written into a directory named `/Trace`.
- If trace files with the same names already exist, the trace data is overwritten.

Although `Test.java` does not contain any code to do tracing, you want to set the configuration properties so that if the application is modified in the future to do tracing, the settings within the program will take precedence over the settings in the configuration properties. To do that, use the set of configuration properties that begin with `db2.jcc`.

The configuration property settings look like this:

- `db2.jcc.traceFile=jcc.log`
- `db2.jcc.traceOption=1`
- `db2.jcc.traceFileSize=4194304`
- `db2.jcc.traceFileCount=4`
- `db2.jcc.traceFileAppend=false`

You want the trace settings to apply only to your stand-alone program `Test.java`, so you create a file with these settings, and then refer to the file when you invoke the Java program by specifying the `-Ddb2.jcc.propertiesFile` option. Suppose that the file that contains the settings is `/Test/jcc.properties`. To enable tracing when you run `Test.java`, you issue a command like this:

```
java -Ddb2.jcc.propertiesFile=/Test/jcc.properties Test
```

Suppose that `Test.java` creates two connections for one `DataSource`. The program does not define a `logWriter` object, so the driver creates a global `logWriter` object for the trace output. During execution of the program, the IBM Data Server Driver for JDBC and SQLJ writes 17 MB of data for the first connection, and 10 MB of data for the second connection.

When the program completes, the following files contain the trace data:

- `/Trace/jcc.log_global_0.1`
- `/Trace/jcc.log_global_0.2`
- `/Trace/jcc.log_global_0.3`
- `/Trace/jcc.log_global_0.4`
- `/Trace/jcc.log_global_1.1`
- `/Trace/jcc.log_global_1.2`
- `/Trace/jcc.log_global_1.3`

/Trace/jcc.log\_global\_0.1 contains the last 1 MB of trace data that is written for the first connection, which overwrites the first 1 MB of trace data that was written for that connection.

---

## Example of a trace program under the IBM Data Server Driver for JDBC and SQLJ

You might want to write a single class that includes methods for tracing under the DriverManager interface, as well as the DataSource interface.

The following example shows such a class. The example uses IBM Data Server Driver for JDBC and SQLJ type 4 connectivity.

Figure 46. Example of tracing under the IBM Data Server Driver for JDBC and SQLJ

```
public class TraceExample
{
    public static void main(String[] args)
    {
        sampleConnectUsingSimpleDataSource();
        sampleConnectWithURLUsingDriverManager();
    }

    private static void sampleConnectUsingSimpleDataSource()
    {
        java.sql.Connection c = null;
        java.io.PrintWriter printWriter =
            new java.io.PrintWriter(System.out, true);
                                                // Prints to console, true means
                                                // auto-flush so you don't lose trace
        try {
            javax.sql.DataSource ds =
                new com.ibm.db2.jcc.DB2SimpleDataSource();
            ((com.ibm.db2.jcc.DB2BaseDataSource) ds).setServerName("sysmvsl.stl.ibm.com");
            ((com.ibm.db2.jcc.DB2BaseDataSource) ds).setPortNumber(5021);
            ((com.ibm.db2.jcc.DB2BaseDataSource) ds).setDatabaseName("san_jose");
            ((com.ibm.db2.jcc.DB2BaseDataSource) ds).setDriverType(4);

            ds.setLogWriter(printWriter);    // This turns on tracing

            // Refine the level of tracing detail
            ((com.ibm.db2.jcc.DB2BaseDataSource) ds).
                setTraceLevel(com.ibm.db2.jcc.DB2SimpleDataSource.TRACE_CONNECTS |
                    com.ibm.db2.jcc.DB2SimpleDataSource.TRACE_DRDA_FLOWS);

            // This connection request is traced using trace level
            // TRACE_CONNECTS | TRACE_DRDA_FLOWS
            c = ds.getConnection("myname", "mypass");

            // Change the trace level to TRACE_ALL
            // for all subsequent requests on the connection
            ((com.ibm.db2.jcc.DB2Connection) c).setJccLogWriter(printWriter,
                com.ibm.db2.jcc.DB2BaseDataSource.TRACE_ALL);
            // The following INSERT is traced using trace level TRACE_ALL
            java.sql.Statement s1 = c.createStatement();
            s1.executeUpdate("INSERT INTO sampleTable(sampleColumn) VALUES(1)");
            s1.close();

            // This code disables all tracing on the connection
            ((com.ibm.db2.jcc.DB2Connection) c).setJccLogWriter(null);

            // The following INSERT statement is not traced
        }
    }
}
```

```

        java.sql.Statement s2 = c.createStatement();
        s2.executeUpdate("INSERT INTO sampleTable(sampleColumn) VALUES(1)");
        s2.close();

        c.close();
    }
    catch(java.sql.SQLException e) {
        com.ibm.db2.jcc.DB2ExceptionFormatter.printStackTrace(e,
            printWriter, "[TraceExample]");
    }
    finally {
        cleanup(c, printWriter);
        printWriter.flush();
    }
}

// If the code ran successfully, the connection should
// already be closed. Check whether the connection is closed.
// If so, just return.
// If a failure occurred, try to roll back and close the connection.

private static void cleanup(java.sql.Connection c,
    java.io.PrintWriter printWriter)
{
    if(c == null) return;

    try {
        if(c.isClosed()) {
            printWriter.println("[TraceExample] " +
                "The connection was successfully closed");
            return;
        }

        // If we get to here, something has gone wrong.
        // Roll back and close the connection.
        printWriter.println("[TraceExample] Rolling back the connection");
        try {
            c.rollback();
        }
        catch(java.sql.SQLException e) {
            printWriter.println("[TraceExample] " +
                "Trapped the following java.sql.SQLException while trying to roll back:");
            com.ibm.db2.jcc.DB2ExceptionFormatter.printStackTrace(e, printWriter,
                "[TraceExample]");
            printWriter.println("[TraceExample] " +
                "Unable to roll back the connection");
        }
        catch(java.lang.Throwable e) {
            printWriter.println("[TraceExample] Trapped the " +
                "following java.lang.Throwable while trying to roll back:");
            com.ibm.db2.jcc.DB2ExceptionFormatter.printStackTrace(e,
                printWriter, "[TraceExample]");
            printWriter.println("[TraceExample] Unable to " +
                "roll back the connection");
        }
    }

    // Close the connection
    printWriter.println("[TraceExample] Closing the connection");
    try {
        c.close();
    }
    catch(java.sql.SQLException e) {
        printWriter.println("[TraceExample] Exception while " +
            "trying to close the connection");
        printWriter.println("[TraceExample] Deadlocks could " +
            "occur if the connection is not closed.");
        com.ibm.db2.jcc.DB2ExceptionFormatter.printStackTrace(e, printWriter,

```

```

        "[TraceExample]");
    }
    catch(java.lang.Throwable e) {
        printWriter.println("[TraceExample] Throwable caught " +
            "while trying to close the connection");
        printWriter.println("[TraceExample] Deadlocks could " +
            "occur if the connection is not closed.");
        com.ibm.db2.jcc.DB2ExceptionFormatter.printTrace(e, printWriter,
            "[TraceExample]");
    }
}
catch(java.lang.Throwable e) {
    printWriter.println("[TraceExample] Unable to " +
        "force the connection to close");
    printWriter.println("[TraceExample] Deadlocks " +
        "could occur if the connection is not closed.");
    com.ibm.db2.jcc.DB2ExceptionFormatter.printTrace(e, printWriter,
        "[TraceExample]");
}
}
private static void sampleConnectWithURLUsingDriverManager()
{
    java.sql.Connection c = null;

    // This time, send the printWriter to a file.
    java.io.PrintWriter printWriter = null;
    try {
        printWriter =
            new java.io.PrintWriter(
                new java.io.BufferedOutputStream(
                    new java.io.FileOutputStream("/temp/driverLog.txt"), 4096), true);
    }
    catch(java.io.FileNotFoundException e) {
        java.lang.System.err.println("Unable to establish a print writer for trace");
        java.lang.System.err.flush();
        return;
    }

    try {
        Class.forName("com.ibm.db2.jcc.DB2Driver");
    }
    catch(ClassNotFoundException e) {
        printWriter.println("[TraceExample] " +
            "IBM Data Server Driver for JDBC and SQLJ type 4 connectivity " +
            "is not in the application classpath. Unable to load driver.");
        printWriter.flush();
        return;
    }

    // This URL describes the target data source for Type 4 connectivity.
    // The traceLevel property is established through the URL syntax,
    // and driver tracing is directed to file "/temp/driverLog.txt"
    // The traceLevel property has type int. The constants
    // com.ibm.db2.jcc.DB2BaseDataSource.TRACE_DRDA_FLOWS and
    // com.ibm.db2.jcc.DB2BaseDataSource.TRACE_CONNECTS represent
    // int values. Those constants cannot be used directly in the
    // first getConnection parameter. Resolve the constants to their
    // int values by assigning them to a variable. Then use the
    // variable as the first parameter of the getConnection method.
    String databaseURL =
        "jdbc:db2://sysmvs1.st1.ibm.com:5021" +
        "/sample:traceFile=/temp/driverLog.txt;traceLevel=" +
        (com.ibm.db2.jcc.DB2BaseDataSource.TRACE_DRDA_FLOWS |
        com.ibm.db2.jcc.DB2BaseDataSource.TRACE_CONNECTS) + ";";

    // Set other properties
    java.util.Properties properties = new java.util.Properties();

```

```

properties.setProperty("user", "myname");
properties.setProperty("password", "mypass");

try {
    // This connection request is traced using trace level
    // TRACE_CONNECTS | TRACE_DRDA_FLOWS
    c = java.sql.DriverManager.getConnection(databaseURL, properties);

    // Change the trace level for all subsequent requests
    // on the connection to TRACE_ALL
    ((com.ibm.db2.jcc.DB2Connection) c).setJccLogWriter(printWriter,
        com.ibm.db2.jcc.DB2BaseDataSource.TRACE_ALL);

    // The following INSERT is traced using trace level TRACE_ALL
    java.sql.Statement s1 = c.createStatement();
    s1.executeUpdate("INSERT INTO sampleTable(sampleColumn) VALUES(1)");
    s1.close();

    // Disable all tracing on the connection
    ((com.ibm.db2.jcc.DB2Connection) c).setJccLogWriter(null);

    // The following SQL insert code is not traced
    java.sql.Statement s2 = c.createStatement();
    s2.executeUpdate("insert into sampleTable(sampleColumn) values(1)");
    s2.close();

    c.close();
}
catch(java.sql.SQLException e) {
    com.ibm.db2.jcc.DB2ExceptionFormatter.printTrace(e, printWriter,
        "[TraceExample]");
}
finally {
    cleanup(c, printWriter);
    printWriter.flush();
}
}
}

```

---

## Techniques for monitoring IBM Data Server Driver for JDBC and SQLJ Sysplex support

To monitor IBM Data Server Driver for JDBC and SQLJ Sysplex support, you need to monitor the global transport objects pool.

You can monitor the global transport objects pool in either of the following ways:

- Using traces that you start by setting IBM Data Server Driver for JDBC and SQLJ configuration properties
- Using an application programming interface

### Configuration properties for monitoring the global transport objects pool

The `db2.jcc.dumpPool`, `db2.jcc.dumpPoolStatisticsOnSchedule`, and `db2.jcc.dumpPoolStatisticsOnScheduleFile` configuration properties control tracing of the global transport objects pool.

For example, the following set of configuration property settings cause error messages and dump pool error messages to be written every 60 seconds to a file named `/home/WAS/logs/srv1/poolstats`:

```
db2.jcc.dumpPool=DUMP_SYSPLEX_MSG|DUMP_POOL_ERROR
db2.jcc.dumpPoolStatisticsOnSchedule=60
db2.jcc.dumpPoolStatisticsOnScheduleFile=/home/WAS/logs/srv1/poolstats
```

An entry in the pool statistics file looks like this:

```
time Scheduled PoolStatistics npr:2575 nsr:2575 lwroc:439 hwroc:1764 coc:372
aoc:362 rmoc:362 nbr:2872 tbt:857520 tpo:10
```

The meanings of the fields are:

**npr**

The total number of requests that the IBM Data Server Driver for JDBC and SQLJ has made to the pool since the pool was created.

**nsr**

The number of successful requests that the IBM Data Server Driver for JDBC and SQLJ has made to the pool since the pool was created. A successful request means that the pool returned an object.

**lwroc**

The number of objects that were reused but were not in the pool. This can happen if a Connection object releases a transport object at a transaction boundary. If the Connection object needs a transport object later, and the original transport object has not been used by any other Connection object, the Connection object can use that transport object.

**hwroc**

The number of objects that were reused from the pool.

**coc**

The number of objects that the IBM Data Server Driver for JDBC and SQLJ created since the pool was created.

**aoc**

The number of objects that exceeded the idle time that was specified by `db2.jcc.maxTransportObjectIdleTime` and were deleted from the pool.

**rmoc**

The number of objects that have been deleted from the pool since the pool was created.

**nbr**

The number of requests that the IBM Data Server Driver for JDBC and SQLJ made to the pool that the pool blocked because the pool reached its maximum capacity. A blocked request might be successful if an object is returned to the pool before the `db2.jcc.maxTransportObjectWaitTime` is exceeded and an exception is thrown.

**tbt**

The total time in milliseconds for requests that were blocked by the pool. This time can be much larger than the elapsed execution time of the application if the application uses multiple threads.

**sbt**

The shortest time in milliseconds that a thread waited to get a transport object from the pool. If the time is under one millisecond, the value in this field is zero.

**lbt**

The longest time in milliseconds that a thread waited to get a transport object from the pool.

**abt**

The average amount of time in milliseconds that threads waited to get a transport object from the pool. This value is  $tbt/nbr$ .

**tpo**

The number of objects that are currently in the pool.

## **Application programming interfaces for monitoring the global transport objects pool**

You can write applications to gather statistics on the global transport objects pool. Those applications create objects in the `DB2PoolMonitor` class and invoke methods to retrieve information about the pool.

For example, the following code creates an object for monitoring the global transport objects pool:

```
import com.ibm.db2.jcc.DB2PoolMonitor;
DB2PoolMonitor transportObjectPoolMonitor =
    DB2PoolMonitor.getPoolMonitor (DB2PoolMonitor.TRANSPORT_OBJECT);
```

After you create the `DB2PoolMonitor` object, you can use methods in the `DB2PoolMonitor` class to monitor the pool.

---

## Chapter 8. System monitoring for the IBM Data Server Driver for JDBC and SQLJ

To assist you in monitoring the performance of your applications with the IBM Data Server Driver for JDBC and SQLJ, the driver provides two methods to collect information for a connection.

### About this task

That information is:

#### Core driver time

The sum of elapsed monitored API times that were collected while system monitoring was enabled, in microseconds. In general, only APIs that might result in network I/O or database server interaction are monitored.

#### Network I/O time

The sum of elapsed network I/O times that were collected while system monitoring was enabled, in microseconds.

#### Server time

The sum of all reported database server elapsed times that were collected while system monitoring was enabled, in microseconds.

#### Application time

The sum of the application, JDBC driver, network I/O, and database server elapsed times, in milliseconds.

The two methods are:

- The `DB2SystemMonitor` interface
- The `TRACE_SYSTEM_MONITOR` trace level

*To collect system monitoring data using the `DB2SystemMonitor` interface:* Perform these basic steps:

1. Invoke the `DB2Connection.getDB2SystemMonitor` method to create a `DB2SystemMonitor` object.
2. Invoke the `DB2SystemMonitor.enable` method to enable the `DB2SystemMonitor` object for the connection.
3. Invoke the `DB2SystemMonitor.start` method to start system monitoring.
4. When the activity that is to be monitored is complete, invoke `DB2SystemMonitor.stop` to stop system monitoring.
5. Invoke the `DB2SystemMonitor.getCoreDriverTimeMicros`, `DB2SystemMonitor.getNetworkIOTimeMicros`, `DB2SystemMonitor.getServerTimeMicros`, or `DB2SystemMonitor.getApplicationTimeMillis` methods to retrieve the elapsed time data.

The server time that is returned by `DB2SystemMonitor.getServerTimeMicros` includes commit and rollback time.

For example, the following code demonstrates how to collect each type of elapsed time data. The numbers to the right of selected statements correspond to the



previously described steps.

```
import java.sql.*;
import com.ibm.db2.jcc.*;
public class TestSystemMonitor
{
    public static void main(String[] args)
    {
        String url = "jdbc:db2://sysmvs1.svl.ibm.com:5021/san_jose";
        String user="db2adm";
        String password="db2adm";
        try
        {
            // Load the IBM Data Server Driver for JDBC and SQLJ
            Class.forName("com.ibm.db2.jcc.DB2Driver");
            System.out.println("**** Loaded the JDBC driver");

            // Create the connection using the IBM Data Server Driver for JDBC and SQLJ
            Connection conn = DriverManager.getConnection (url,user,password);
            // Commit changes manually
            conn.setAutoCommit(false);
            System.out.println("**** Created a JDBC connection to the data source");
            DB2SystemMonitor systemMonitor = 1
                ((DB2Connection)conn).getDB2SystemMonitor();
            systemMonitor.enable(true); 2
            systemMonitor.start(DB2SystemMonitor.RESET_TIMES); 3
            Statement stmt = conn.createStatement();
            int numUpd = stmt.executeUpdate(
                "UPDATE EMPLOYEE SET PHONENO='4657' WHERE EMPNO='000010'");
            systemMonitor.stop(); 4
            System.out.println("Server elapsed time (microseconds)="
                + systemMonitor.getServerTimeMicros()); 5
            System.out.println("Network I/O elapsed time (microseconds)="
                + systemMonitor.getNetworkIOTimeMicros());
            System.out.println("Core driver elapsed time (microseconds)="
                + systemMonitor.getCoreDriverTimeMicros());
            System.out.println("Application elapsed time (milliseconds)="
                + systemMonitor.getApplicationTimeMillis());
            conn.rollback();
            stmt.close();
            conn.close();
        }
        // Handle errors
        catch(ClassNotFoundException e)
        {
            System.err.println("Unable to load the driver, " + e);
        }
        catch(SQLException e)
        {
            System.out.println("SQLException: " + e);
            e.printStackTrace();
        }
    }
}
```

Figure 47. Example of using `DB2SystemMonitor` methods to collect system monitoring data

To collect system monitoring information using the trace method: Start a JDBC trace, using configuration properties or `Connection` or `DataSource` properties. Include `TRACE_SYSTEM_MONITOR` when you set the `traceLevel` property. For example:

```
String url = "jdbc:db2://sysmvs1.stl.ibm.com:5021/san_jose" +
    ":traceFile=/u/db2p/jcctrace;" +
    "traceLevel=" + com.ibm.db2.jcc.DB2BaseDataSource.TRACE_SYSTEM_MONITOR + ";";
```

The trace records with system monitor information look similar to this:

```
[jcc][SystemMonitor:start]
```

```
...
```

```
[jcc][SystemMonitor:stop] core: 565.67ms | network: 211.695ms | server: 207.771ms
```

---

## IBM Data Server Driver for JDBC and SQLJ remote trace controller

The IBM Data Server Driver for JDBC and SQLJ provides a facility for controlling IBM Data Server Driver for JDBC and SQLJ traces dynamically.

This remote trace controller lets you perform operations like these for multiple driver instances:

- Start, stop, or resume a trace
- Change the output trace file or directory location
- Change the trace level

The remote trace controller uses the Java Management Extensions (JMX) architecture, which is part of the Java Standard Edition, Version 6, or later. The JMX consists of:

- A set of built-in management utilities, which let you do monitoring from a management console such as the Java Monitoring and Management Console (JConsole).
- A set of APIs that let you write applications to perform the same functions.

### Enabling the remote trace controller

Enabling the remote trace controller involves enabling Java Management Extensions (JMX) in the IBM Data Server Driver for JDBC and SQLJ, and making the JMX agent available to clients.

#### Before you begin

The remote trace controller requires Java Standard Edition, Version 6 or later.

#### About this task

The steps for enabling the remote trace controller are:

#### Procedure

1. Enable JMX to the IBM Data Server Driver for JDBC and SQLJ by setting the `db2.jcc.jmxEnabled` global configuration property to `true` or `yes`.

For example, include this string in `DB2JccConfiguration.properties`:

```
db2.jcc.jmxEnabled=true
```

2. Make the JMX agent (the platform MBean server) available to local or remote clients.

- For local clients:

Monitoring and management capabilities are automatically made available when the JVM is started. After your application is started, you can use a JMX client such as JConsole to connect locally to your Java process.

- For remote clients, use one of the following methods:

- Use the out-of-the-box JMX agent.

Out-of-the-box management uses JMX built-in management utilities. To enable out-of-the-box management, you need to set a number of Java system properties. You must at least set the following property:

```
com.sun.management.jmxremote.port=portNum
```

In addition, you should ensure that authentication and SSL are properly configured.

Full information on enabling out-of-the-box management is at the following URL:

<http://download.oracle.com/javase/6/docs/technotes/guides/management/agent.html>

- Write a JMX agent. This technique is also discussed at:

<http://download.oracle.com/javase/6/docs/technotes/guides/management/agent.html>

In the following example, an RMI connector server is created for the PlatformMBeanServer using the MyCustomJMXAuthenticator object. The MyCustomJMXAuthenticator class defines how remote credentials are converted into a JAAS Subject by implementing the JMXAuthenticator interface:

```
...
HashMap<String> env = new HashMap<String>();
env.put(JMXConnectorServer.AUTHENTICATOR, new MyCustomJMXAuthenticator());
env.put("jmx.remote.x.access.file", "my.access.file");

MBeanServer mbs =
    java.lang.management.ManagementFactory.getPlatformMBeanServer();
JMXServiceURL url =
    new JMXServiceURL("service:jmx:rmi:///jndi/rmi://:9999/jmxrmi");

JMXConnectorServer cs =
    JMXConnectorServerFactory.newJMXConnectorServer(url, env, mbs);
cs.start();

...
public class MyCustomJMXAuthenticator implements JMXAuthenticator {

    public Subject authenticate(Object credentials) {
        // the hash contains username, password, etc...
        Hashtable <String> credentialsHash
            = (Hashtable <String>) credentials;

        ...
        // Authenticate using the provided credentials
        ...
        if (authentication-successful) {
            return new Subject(true,
                Collections.singleton
                    (new JMXPrincipal(credentialsHash.get("username"))),
                Collections.EMPTY_SET,
                Collections.EMPTY_SET);
        }
        throw new SecurityException("Invalid credentials");
    }
}
```

## Accessing the remote trace controller

You can access the remote trace controller through out-of-the-box management tools, or through an application.

### About this task

You use out-of-the-box management through a JMX-compliant management client, such as JConsole, which is part of Java Standard Edition, Version 6. Information on using JConsole for out-of-the-box management is at the following URL:

<http://download.oracle.com/javase/6/docs/technotes/guides/management/jconsole.html>

In an application that accesses the remote trace controller, the remote trace controller is a managed bean (MBean). JMX manages resources through JMX agents. A JMX agent is an MBean server. Each MBean represents a resource. Every MBean has a name, which you define through an object of class `javax.management.ObjectName`. You use the `ObjectName` object to register and retrieve MBeans in the `MBeanServer`.

The MBean name has two parts: the domain and the key properties. For the `ObjectName` for the IBM Data Server Driver for JDBC and SQLJ remote trace controller, the domain is `com.ibm.db2.jcc`, and the key properties are `name=DB2TraceManager`.

An application that accesses the remote trace controller must include these steps:

## Procedure

1. Establish a Remote Method Invocation (RMI) connection to an MBean server.
2. Perform a lookup on the remote trace controller in the MBean server.
3. Invoke trace operations on the MBean.

You can operate on the MBean in the following ways:

- Using an MBean proxy
- Without a proxy, through an `MBeanServerConnection`.

## Example

**Example: accessing the remote trace controller without proxies:** This example demonstrates accessing MBeans directly from an `MBeanServerConnection`. This method is the most generic because it does not require matching interface definitions on the JMX client application.

```
Hashtable<String> env = new Hashtable<String>();
env.put(Context.INITIAL_CONTEXT_FACTORY,
"com.sun.jndi.fscontext.RefFSContextFactory");

try {
    System.out.println ("");
    System.out.println ("-----");
    System.out.println ("Establish an RMI connection to an MBeanServer");
    System.out.println ("-----");
    JMXServiceURL url =
        new JMXServiceURL ("service:jmx:rmi:///jndi/rmi://localhost:9999/jmxrmi");
    JMXConnector jmxc = JMXConnectorFactory.connect (url, env);
    MBeanServerConnection mbsc = jmxc.getMBeanServerConnection();

    System.out.println ("");
    System.out.println ("-----");
    System.out.println ("Processing MBean");
    System.out.println ("-----");
    String objectNameString = "com.ibm.db2.jcc:name=DB2TraceManager";
    ObjectName name = new ObjectName(objectNameString);
    System.out.println ("ObjectName="+objectNameString);

    System.out.println ("");
    System.out.println ("-----");
    System.out.println ("Print all attributes of the MBean");
    System.out.println ("-----");

    System.out.println(
"TraceDirectory = "+mbsc.getAttribute (name, "TraceDirectory"));
    System.out.println(
"TraceFile      = "+mbsc.getAttribute (name, "TraceFile"));
```

```

System.out.println(
    "TraceFileAppend = "+mbsc.getAttribute (name, "TraceFileAppend"));
System.out.println(
    "TraceLevel      = "+mbsc.getAttribute (name, "TraceLevel"));

System.out.println ("");
System.out.println ("-----");
System.out.println ("Invoke some operations on the MBean");
System.out.println ("-----");
System.out.print ("Invoking suspendTrace()...");
mbsc.invoke (name, "suspendTrace", null , null);
System.out.println ("success");

System.out.print ("Invoking resumeTrace()...");
mbsc.invoke (name, "resumeTrace", null , null);
System.out.println ("success");
}
catch (Exception e) {
    System.out.println ("failure");
    e.printStackTrace ();
}
}

```

**Example: accessing the remote trace controller with proxies:** This example demonstrates the creation of a proxy to an MBean. The proxy implements the `com.ibm.db2.jcc.mx.DB2TraceManagerMXBean` interface. The application makes calls directly on the proxy, and the underlying proxy implementation invokes the MBean operation on the remote MBean server.

```

Hashtable<String> env = new Hashtable<String>();
env.put(Context.INITIAL_CONTEXT_FACTORY,
    "com.sun.jndi.fscontext.ReffSContextFactory");

try {
    System.out.println ("");
    System.out.println ("-----");
    System.out.println ("Establish an RMI connection to an MBeanServer");
    System.out.println ("-----");
    JMXServiceURL url =
        new JMXServiceURL ("service:jmx:rmi:///jndi/rmi://localhost:9999/jmxrmi");
    JMXConnector jmx = JMXConnectorFactory.connect (url, env);
    MBeanServerConnection mbsc = jmx.getMBeanServerConnection();

    System.out.println ("");
    System.out.println ("-----");
    System.out.println ("Processing MBean");
    System.out.println ("-----");
    String objectNameString = "com.ibm.db2.jcc:name=DB2TraceManager";
    ObjectName name = new ObjectName(objectNameString);
    System.out.println ("ObjectName="+objectNameString);

    System.out.println ("");
    System.out.println ("-----");
    System.out.println ("Print all attributes of the MBean");
    System.out.println ("-----");
    com.ibm.db2.jcc.mx.DB2TraceManagerMXBean mbeanProxy =
        JMX.newMBeanProxy(mbsc, name,
            com.ibm.db2.jcc.mx.DB2TraceManagerMXBean.class, true);
    System.out.println ("TraceDirectory = "+mbeanProxy.getTraceDirectory ());
    System.out.println ("TraceFile      = "+mbeanProxy.getTraceFile ());
    System.out.println ("TraceFileAppend = "+mbeanProxy.getTraceFileAppend ());
    System.out.println ("TraceLevel     = "+mbeanProxy.getTraceLevel ());
    System.out.println ("");
    System.out.println ("-----");
    System.out.println ("Invoke some operations on the MBean");
    System.out.println ("-----");
    System.out.print ("Invoking suspendTrace()...");
    mbeanProxy.suspendTrace();
}

```

```
System.out.println ("success");
System.out.print ("Invoking resumeTrace()...");
mbeanProxy.resumeTrace();
System.out.println ("success");
}
catch (Exception e) {
    System.out.println ("failure");
    e.printStackTrace ();
}
```



---

## Chapter 9. Java client support for high availability on IBM data servers

Client applications that connect to DB2 Database for Linux, UNIX, and Windows, DB2 for z/OS, or IBM Informix can easily take advantage of the high availability features of those data servers.

Client applications can use the following high availability features:

- Automatic client reroute

Automatic client reroute capability is available on all IBM data servers.

Automatic client reroute uses information that is provided by the data servers to redirect client applications from a server that experiences an outage to an alternate server. Automatic client reroute enables applications to continue their work with minimal interruption. Redirection of work to an alternate server is called *failover*.

For connections to DB2 for z/OS data servers, automatic client reroute is part of the workload balancing feature. In general, for DB2 for z/OS, automatic client reroute should not be enabled without workload balancing.

- Client affinities

Client affinities is a failover solution that is controlled completely by the client. It is intended for situations in which you need to connect to a particular primary server. If an outage occurs during the connection to the primary server, you use client affinities to enforce a specific order for failover to alternate servers.

Client affinities is not applicable to a DB2 for z/OS data sharing environment, because all members of a data sharing group can access data concurrently. Data sharing is the recommended solution for high availability for DB2 for z/OS.

- Workload balancing

Workload balancing is available on all IBM data servers. Workload balancing ensures that work is distributed efficiently among servers in an IBM Informix high-availability cluster, DB2 for z/OS data sharing group, or DB2 Database for Linux, UNIX, and Windows DB2 pureScale<sup>®</sup> instance.

The following table provides links to server-side information about these features.

*Table 35. Server-side information on high availability*

Data server	Related topics
DB2 Database for Linux, UNIX, and Windows	<ul style="list-style-type: none"><li>• DB2 pureScale:</li><li>• Automatic client reroute: Automatic client reroute roadmap</li></ul>
IBM Informix	Manage Cluster Connections with the Connection Manager
DB2 for z/OS	Communicating with data sharing groups

**Important:** For connections to DB2 for z/OS, this information discusses direct connections to DB2 for z/OS. For information about high availability for connections through DB2 Connect Server, see the DB2 Connect documentation.



---

## Java client support for high availability for connections to DB2 Database for Linux, UNIX, and Windows servers

DB2 Database for Linux, UNIX, and Windows servers provide high availability for client applications, through workload balancing and automatic client reroute. This support is available for applications that use Java clients (JDBC, SQLJ, or pureQuery), as well as non-Java clients (ODBC, CLI, .NET, OLE DB, PHP, Ruby, or embedded SQL).

For Java clients, you need to use IBM Data Server Driver for JDBC and SQLJ type 4 connectivity to take advantage of DB2 Database for Linux, UNIX, and Windows high-availability support. You need IBM Data Server Driver for JDBC and SQLJ version 3.58 or 4.8, or later.

High availability support for connections to DB2 Database for Linux, UNIX, and Windows servers includes:

### Automatic client reroute

This support enables a client to recover from a failure by attempting to reconnect to the database through an alternate server. Reconnection to another server is called *failover*. For Java clients, automatic client reroute support is always enabled.

Servers can provide automatic client reroute capability in any of the following ways:

- Several servers are configured in a DB2 pureScale instance. A connection to a database is a connection to a member of that DB2 pureScale instance. Failover involves reconnection to another member of the DB2 pureScale instance. This environment requires that clients use TCP/IP to connect to the DB2 pureScale instance.
- A DB2 pureScale instance and an alternate server are defined for a database. Failover first involves reconnection to another member of the DB2 pureScale instance. Failover to the alternate server is attempted only if no member of the DB2 pureScale instance is available.
- A DB2 pureScale instance is defined for the primary server, and another DB2 pureScale instance is defined for the alternate server. Failover first involves reconnection to another member of the primary DB2 pureScale instance. Failover to the alternate DB2 pureScale instance is attempted only if no member of the primary DB2 pureScale instance is available.
- A database is defined on a single server. The configuration for that database includes specification of an alternate server. Failover involves reconnection to the alternate server.

For Java, client applications, failover for automatic client reroute can be *seamless* or *non-seamless*. With non-seamless failover, when the client application reconnects to another server, an error is always returned to the application, to indicate that failover (connection to the alternate server) occurred. With seamless failover, the driver does not return an error if a connection failure and successful reconnection to an alternate server occur during execution of the first SQL statement in a transaction.

In a DB2 pureScale instance, automatic client reroute support can be used without workload balancing or with workload balancing.

### Workload balancing

Workload balancing can improve availability of a DB2 pureScale instance.

With workload balancing, a DB2 pureScale instance ensures that work is distributed efficiently among members.

Java clients on any operating system support workload balancing. The connection from the client to the DB2 pureScale instance must use TCP/IP.

When workload balancing is enabled, the client gets frequent status information about the members of the DB2 pureScale instance through a server list. The client caches the server list and uses the information in it to determine the member to which the next transaction should be routed.

For Java applications, when JNDI is used, the cached server list can be shared by multiple JVMs for the first connection. However workload balancing is always performed within the context of a single JVM.

DB2 Database for Linux, UNIX, and Windows supports two types of workload balancing:

#### **Connection-level workload balancing**

Connection-level workload balancing is performed at connection boundaries. It is not supported for Java clients.

#### **Transaction-level workload balancing**

Transaction-level workload balancing is performed at transaction boundaries. Client support for transaction-level workload balancing is disabled by default for clients that connect to DB2 Database for Linux, UNIX, and Windows.

#### **Client affinities**

Client affinities is an automatic client reroute solution that is controlled completely by the client. It is intended for situations in which you need to connect to a particular primary server. If an outage occurs during the connection to the primary server, you use client affinities to enforce a specific order for failover to alternate servers.

## **Configuration of DB2 Database for Linux, UNIX, and Windows automatic client reroute support for Java clients**

For connections to DB2 Database for Linux, UNIX, and Windows databases, the process for configuration of automatic client reroute support on Java clients is the same for connections to a non-DB2 pureScale environment and a DB2 pureScale environment.

Automatic client reroute support for Java client applications that connect to DB2 Database for Linux, UNIX, and Windows works for connections that are obtained using the `javax.sql.DataSource`, `javax.sql.ConnectionPoolDataSource`, `javax.sql.XADataSource`, or `java.sql.DriverManager` interface.

To configure automatic client reroute on a IBM Data Server Driver for JDBC and SQLJ client:

1. Set the appropriate properties to specify the primary and alternate server addresses to use if the first connection fails.
  - If your application is using the `DriverManager` interface for connections:
    - a. Specify the server name and port number of the primary server that you want to use in the connection URL.
    - b. Set the `clientRerouteAlternateServerName` and `clientRerouteAlternatePortNumber` properties to the server name and port number of the alternate server that you want to use.

**Restriction:** Automatic client reroute support for connections that are made with the DriverManager interface has the following restrictions:

- Alternate server information is shared between DriverManager connections only if you create the connections with the same URL and properties.
- You cannot set the clientRerouteServerListJNDIName property or the clientRerouteServerListJNDIContext properties for a DriverManager connection.
- Automatic client reroute is not enabled for default connections (jdbc:default:connection).
- If your application is using the DataSource interface for connections, use one or both of the following techniques:
  - Set the server names and port numbers in DataSource properties:
    - a. Set the serverName and portNumber properties to the server name and port number of the primary server that you want to use.
    - b. Set the clientRerouteAlternateServerName and clientRerouteAlternatePortNumber properties to the server name and port number of the alternate server that you want to use.
  - Configure JNDI for automatic client reroute by using a DB2ClientRerouteServerList instance to identify the primary server and alternate server.
    - a. Create an instance of DB2ClientRerouteServerList.  
DB2ClientRerouteServerList is a serializable Java bean with the following properties:

Property name	Data type
com.ibm.db2.jcc.DB2ClientRerouteServerList.alternateServerName	String[]
com.ibm.db2.jcc.DB2ClientRerouteServerList.alternatePortNumber	int[]
com.ibm.db2.jcc.DB2ClientRerouteServerList.primaryServerName	String[]
com.ibm.db2.jcc.DB2ClientRerouteServerList.primaryPortNumber	int[]

getXXX and setXXX methods are defined for each property.

- b. Set the com.ibm.db2.jcc.DB2ClientRerouteServerList.primaryServerName and com.ibm.db2.jcc.DB2ClientRerouteServerList.primaryPortNumber properties to the server name and port number of the primary server that you want to use.
- c. Set the com.ibm.db2.jcc.DB2ClientRerouteServerList.alternateServerName and com.ibm.db2.jcc.DB2ClientRerouteServerList.alternatePortNumber properties to the server names and port numbers of the alternate server that you want to use.
- d. To make the DB2ClientRerouteServerList persistent:
  - 1) Bind the DB2ClientRerouteServerList instance to the JNDI registry.
  - 2) Assign the JNDI name of the DB2ClientRerouteServerList object to the IBM Data Server Driver for JDBC and SQLJ clientRerouteServerListJNDIName property.
  - 3) Assign the name of the JNDI context that is used for binding and lookup of the DB2ClientRerouteServerList instance to the clientRerouteServerListJNDIContext property.

When a DataSource is configured to use JNDI for storing automatic client reroute alternate information, the standard server and port properties of the DataSource are not used for a getConnection request. Instead, the primary server address is obtained from the transient clientRerouteServerList information. If the JNDI store is not available due to a JNDI bind or lookup failure, the IBM Data Server Driver for JDBC and SQLJ attempts to make a connection using the standard server and port properties of the DataSource. Warnings are accumulated to indicate that a JNDI bind or lookup failure occurred.

After a failover:

- The IBM Data Server Driver for JDBC and SQLJ attempts to propagate the updated server information to the JNDI store.
- primaryServerName and primaryPortNumber values that are specified in DB2ClientRerouteServerList are used for the connection. If primaryServerName is not specified, the serverName and portNumber values for the DataSource instance are used.

If you configure DataSource properties as well as configuring JNDI for automatic client reroute, the DataSource properties have precedence over the JNDI configuration.

2. Set properties to control the number of retries, time between retries, and the frequency with which the server list is refreshed.

The following properties control retry behavior for automatic client reroute.

#### **maxRetriesForClientReroute**

The maximum number of connection retries for automatic client reroute.

When client affinities support is not configured, if maxRetriesForClientReroute or retryIntervalForClientReroute is not set, the default behavior is that the connection is retried for 10 minutes, with a wait time between retries that increases as the length of time from the first retry increases.

When client affinities is configured, the default for maxRetriesForClientReroute is 3.

#### **retryIntervalForClientReroute**

The number of seconds between consecutive connection retries.

When client affinities support is not configured, if retryIntervalForClientReroute or maxRetriesForClientReroute is not set, the default behavior is that the connection is retried for 10 minutes, with a wait time between retries that increases as the length of time from the first retry increases.

When client affinities is configured, the default for retryIntervalForClientReroute is 0 (no wait).

## **Example of enabling DB2 Database for Linux, UNIX, and Windows automatic client reroute support in Java applications**

Java client setup for DB2 Database for Linux, UNIX, and Windows automatic client reroute support includes setting several IBM Data Server Driver for JDBC and SQLJ properties.

The following example demonstrates setting up Java client applications for DB2 Database for Linux, UNIX, and Windows automatic client reroute support.

Suppose that your installation has a primary server and an alternate server with the following server names and port numbers:

Server name	Port number
srv1.sj.ibm.com	50000
srv3.sj.ibm.com	50002

The following code sets up `DataSource` properties in an application so that the application connects to `srv1.sj.ibm.com` as the primary server, and `srv3.sj.ibm.com` as the alternative server. That is, if `srv1.sj.ibm.com` is down during the initial connection, the driver should connect to `srv3.sj.ibm.com`.

```
ds.setDriverType(4);
ds.setServerName("srv1.sj.ibm.com");
ds.setPortNumber("50000");
ds.setClientRerouteAlternateServerName("srv3.sj.ibm.com");
ds.setClientRerouteAlternatePortNumber("50002");
```

The following code configures JNDI for automatic client reroute. It creates an instance of `DB2ClientRerouteServerList`, binds that instance to the JNDI registry, and assigns the JNDI name of the `DB2ClientRerouteServerList` object to the `clientRerouteServerListJNDIName` property.

```
// Create a starting context for naming operations
InitialContext registry = new InitialContext();
// Create a DB2ClientRerouteServerList object
DB2ClientRerouteServerList address = new DB2ClientRerouteServerList();

// Set the port number and server name for the primary server
address.setPrimaryPortNumber(50000);
address.setPrimaryServerName("srv1.sj.ibm.com");

// Set the port number and server name for the alternate server
int[] port = {50002};
String[] server = {"srv3.sj.ibm.com"};
address.setAlternatePortNumber(port);
address.setAlternateServerName(server);

registry.rebind("serverList", address);
// Assign the JNDI name of the DB2ClientRerouteServerList object to the
// clientRerouteServerListJNDIName property
datasource.setClientRerouteServerListJNDIName("serverList");
```

## Configuration of DB2 Database for Linux, UNIX, and Windows workload balancing support for Java clients

To configure a IBM Data Server Driver for JDBC and SQLJ client application that connects to a DB2 Database for Linux, UNIX, and Windows DB2 pureScale instance for workload balancing, you need to connect to a member of the DB2 pureScale instance, and set the properties that enable workload balancing and the maximum number of connections.

Java client applications support transaction-level workload balancing. They do not support connection-level workload balancing. Workload balancing is supported only for connections to a DB2 pureScale instance.

Workload balancing support for Java client applications that connect to DB2 Database for Linux, UNIX, and Windows works for connections that are obtained using the `javax.sql.DataSource`, `javax.sql.ConnectionPoolDataSource`, `javax.sql.XADataSource`, or `java.sql.DriverManager` interface.

**Restriction:** Workload balancing support for connections that are made with the DriverManager interface has the following restrictions:

- Alternate server information is shared between DriverManager connections only if you create the connections with the same URL and properties.
- You cannot set the clientRerouteServerListJNDIName property or the clientRerouteServerListJNDIContext properties for a DriverManager connection.
- Workload balancing is not enabled for default connections (jdbc:default:connection).

The following table describes the basic property settings for enabling DB2 Database for Linux, UNIX, and Windows workload balancing for Java applications.

*Table 36. Basic settings to enable workload support in Java applications*

IBM Data Server Driver for JDBC and SQLJ setting	Value
enableSysplexWLB property	true
maxTransportObjects property	The maximum number of connections that the requester can make to the DB2 pureScale instance
Connection address: server	The IP address of a member of a DB2 pureScale instance <sup>1</sup>
Connection address: port	The SQL port number for the DB2 pureScale instance <sup>1</sup>
Connection address: database	The database name

**Note:**

1. Alternatively, you can use a distributor, such as Websphere Application Server Network Deployment, or multihomed DNS to establish the initial connection to the database.
  - For a distributor, you specify the IP address and port number of the distributor. The distributor analyzes the current workload distribution, and uses that information to forward the connection request to one of the members of the DB2 pureScale instance.
  - For multihomed DNS, you specify an IP address and port number that can resolve to the IP address and port number of any member of the DB2 pureScale instance. Multihomed DNS processing selects a member based on some criterion, such as simple round-robin selection or member workload distribution.

If you want to fine-tune DB2 Database for Linux, UNIX, and Windows workload balancing support, global configuration properties are available. The properties for the IBM Data Server Driver for JDBC and SQLJ are listed in the following table.

*Table 37. Configuration properties for fine-tuning DB2 Database for Linux, UNIX, and Windows workload balancing support for connections from the IBM Data Server Driver for JDBC and SQLJ*

IBM Data Server Driver for JDBC and SQLJ configuration property	Description
db2.jcc.maxRefreshInterval	Specifies the maximum amount of time in seconds between refreshes of the client copy of the server list that is used for workload balancing. The default is 30. The minimum valid value is 1.
db2.jcc.maxTransportObjectIdleTime	Specifies the maximum elapsed time in number of seconds before an idle transport is dropped. The default is 60. The minimum supported value is 0.



Table 37. Configuration properties for fine-tuning DB2 Database for Linux, UNIX, and Windows workload balancing support for connections from the IBM Data Server Driver for JDBC and SQLJ (continued)

IBM Data Server Driver for JDBC and SQLJ configuration property	Description
db2.jcc.maxTransportObjectWaitTime	Specifies the number of seconds that the client will wait for a transport to become available. The default is -1 (unlimited). The minimum supported value is 0.
db2.jcc.minTransportObjects	Specifies the lower limit for the number of transport objects in a global transport object pool. The default value is 0. Any value that is less than or equal to 0 means that the global transport object pool can become empty.

## Example of enabling DB2 Database for Linux, UNIX, and Windows workload balancing support in Java applications

Java client setup for DB2 Database for Linux, UNIX, and Windows workload balancing support includes setting several IBM Data Server Driver for JDBC and SQLJ properties.

The following example demonstrates setting up Java client applications for DB2 Database for Linux, UNIX, and Windows workload balancing support.

Before you can set up the client, the servers to which the client connects must be configured in a DB2 pureScale instance.

Follow these steps to set up the client:

1. Verify that the IBM Data Server Driver for JDBC and SQLJ is at the correct level to support workload balancing by following these steps:
  - a. Issue the following command in a command line window:

```
java com.ibm.db2.jcc.DB2Jcc -version
```
  - b. Find a line in the output like this, and check that *nnn* is 3.58 or later.
  - c.

```
[jcc] Driver: IBM Data Server Driver for JDBC and SQLJ Architecture nnn xxx
```
2. Set IBM Data Server Driver for JDBC and SQLJ properties to enable the connection concentrator or workload balancing:
  - a. Set these Connection or DataSource properties:
    - enableSysplexWLB
    - maxTransportObjects
  - b. Set the db2.jcc.maxRefreshInterval global configuration property in a DB2JccConfiguration.properties file to set the maximum refresh interval for all DataSource or Connection instances that are created under the driver.

Start with settings similar to these:

Table 38. Example of property settings for workload balancing for DB2 Database for Linux, UNIX, and Windows

Property	Setting
enableSysplexWLB	true
maxTransportObjects	80
db2.jcc.maxRefreshInterval	30

The values that are specified are not intended to be recommended values. You need to determine values based on factors such as the number of physical

connections that are available. The number of transport objects must be equal to or greater than the number of connection objects.

3. To fine-tune workload balancing for all DataSource or Connection instances that are created under the driver, set the `db2.jcc.maxTransportObjects` configuration property in a `DB2JccConfiguration.properties` file.

Start with a setting similar to this one:

```
db2.jcc.maxTransportObjects=500
```

## Operation of automatic client reroute for connections to DB2 Database for Linux, UNIX, and Windows from Java clients

When IBM Data Server Driver for JDBC and SQLJ client reroute support is enabled, a Java application that is connected to a DB2 Database for Linux, UNIX, and Windows database can continue to run when the primary server has a failure.

Automatic client reroute for a Java application that is connected to a DB2 Database for Linux, UNIX, and Windows database operates in the following way when support for client affinities is disabled:

1. During each connection to the data source, the IBM Data Server Driver for JDBC and SQLJ obtains primary and alternate server information.
  - For the first connection to a DB2 Database for Linux, UNIX, and Windows database:
    - a. If the `clientRerouteAlternateServerName` and `clientRerouteAlternatePortNumber` properties are set, the IBM Data Server Driver for JDBC and SQLJ loads those values into memory as the alternate server values, along with the primary server values `serverName` and `portNumber`.
    - b. If the `clientRerouteAlternateServerName` and `clientRerouteAlternatePortNumber` properties are not set, and a JNDI store is configured by setting the property `clientRerouteServerListJNDIName` on the `DB2BaseDataSource`, the IBM Data Server Driver for JDBC and SQLJ loads the primary and alternate server information from the JNDI store into memory.
    - c. If no DataSource properties are set for the alternate servers, and JNDI is not configured, the IBM Data Server Driver for JDBC and SQLJ checks DNS tables for primary and alternate server information. If DNS information exists, the IBM Data Server Driver for JDBC and SQLJ loads those values into memory.

In a DB2 pureScale environment, regardless of the outcome of the DNS lookup:

- 1) If configuration property `db2.jcc.outputDirectory` is set, the IBM Data Server Driver for JDBC and SQLJ searches the directory that is specified by `db2.jcc.outputDirectory` for a file named `jccServerListCache.bin`.
- 2) If `db2.jcc.outputDirectory` is not set, and the `java.io.tmpdir` system property is set, the IBM Data Server Driver for JDBC and SQLJ searches the directory that is specified by `java.io.tmpdir` for a file named `jccServerListCache.bin`.
- 3) If `jccServerListCache.bin` can be accessed, the IBM Data Server Driver for JDBC and SQLJ loads the cache into memory, and obtains the alternate server information from `jccServerListCache.bin` for the `serverName` value that is defined for the DataSource object.



- d. If no primary or alternate server information is available, a connection cannot be established, and the IBM Data Server Driver for JDBC and SQLJ throws an exception.
  - For subsequent connections, the IBM Data Server Driver for JDBC and SQLJ obtains primary and alternate server values from driver memory.
2. The IBM Data Server Driver for JDBC and SQLJ attempts to connect to the data source using the primary server name and port number.

In a non-DB2 pureScale environment, the primary server is a stand-alone server. In a DB2 pureScale environment, the primary server is a member of a DB2 pureScale instance.

If the connection is through the DriverManager interface, the IBM Data Server Driver for JDBC and SQLJ creates an internal DataSource object for automatic client reroute processing.

3. If the connection to the primary server fails:
- a. If this is the first connection, the IBM Data Server Driver for JDBC and SQLJ attempts to reconnect to a server using information that is provided by driver properties such as `clientRerouteAlternateServerName` and `clientRerouteAlternatePortNumber`.
  - b. If this is not the first connection, the IBM Data Server Driver for JDBC and SQLJ attempts to make a connection using the information from the latest server list that is returned from the server.

Connection to an alternate server is called *failover*.

The IBM Data Server Driver for JDBC and SQLJ uses the `maxRetriesForClientReroute` and `retryIntervalForClientReroute` properties to determine how many times to retry the connection and how long to wait between retries. An attempt to connect to the primary server and alternate servers counts as one retry.

4. If the connection is not established, `maxRetriesForClientReroute` and `retryIntervalForClientReroute` are not set, and the original `serverName` and `portNumber` values that are defined on the DataSource are different from the `serverName` and `portNumber` values that were used for the current connection, the connection is retried with the `serverName` and `portNumber` values that are defined on the DataSource.
5. If failover is successful during the initial connection, the driver generates an `SQLWarning`. If a successful failover occurs after the initial connection:
- If seamless failover is enabled, and the following conditions are satisfied, the driver retries the transaction on the new server, without notifying the application.
    - The `enableSeamlessFailover` property is set to `DB2BaseDataSource.YES (1)`.
    - The connection is not in a transaction. That is, the failure occurs when the first SQL statement in the transaction is executed.
    - There are no global temporary tables in use on the server.
    - There are no open, held cursors.
  - If seamless failover is not in effect, the driver throws an `SQLException` to the application with error code -4498, to indicate to the application that the connection was automatically reestablished and the transaction was implicitly rolled back. The application can then retry its transaction without doing an explicit rollback first.

A reason code that is returned with error code -4498 indicates whether any database server special registers that were modified during the original connection are reestablished in the failover connection.

You can determine whether alternate server information was used in establishing the initial connection by calling the `DB2Connection.alternateWasUsedOnConnect` method.

6. After failover, driver memory is updated with new primary and alternate server information that is returned from the new primary server.

## Examples

*Example: Automatic client reroute to a DB2 Database for Linux, UNIX, and Windows server when `maxRetriesForClientReroute` and `retryIntervalForClientReroute` are not set:* Suppose that the following properties are set for a connection to a database:

Property	Value
<code>enableClientAffinitiesList</code>	<code>DB2BaseDataSource.NO (2)</code>
<code>serverName</code>	<code>host1</code>
<code>portNumber</code>	<code>port1</code>
<code>clientRerouteAlternateServerName</code>	<code>host2</code>
<code>clientRerouteAlternatePortNumber</code>	<code>port2</code>

The following steps demonstrate an automatic client reroute scenario for a connection to a DB2 Database for Linux, UNIX, and Windows server:

1. The IBM Data Server Driver for JDBC and SQLJ loads `host1:port1` into its memory as the primary server address, and `host2:port2` into its memory as the alternate server address.
2. On the initial connection, the driver tries to connect to `host1:port1`.
3. The connection to `host1:port1` fails, so the driver tries another connection to `host1:port1`.
4. The reconnection to `host1:port1` fails, so the driver tries to connect to `host2:port2`.
5. The connection to `host2:port2` succeeds.
6. The driver retrieves alternate server information that was received from server `host2:port2`, and updates its memory with that information.  
Assume that the driver receives a server list that contains `host2:port2`, `host2a:port2a`. `host2:port2` is stored as the new primary server, and `host2a:port2a` is stored as the new alternate server. If another communication failure is detected on this same connection, or on another connection that is created from the same `DataSource`, the driver tries to connect to `host2:port2` as the new primary server. If that connection fails, the driver tries to connect to the new alternate server `host2a:port2a`.
7. A communication failure occurs during the connection to `host2:port2`.
8. The driver tries to connect to `host2a:port2a`.
9. The connection to `host2a:port2a` is successful.
10. The driver retrieves alternate server information that was received from server `host2a:port2a`, and updates its memory with that information.

*Example: Automatic client reroute to a DB2 Database for Linux, UNIX, and Windows server in a DB2 pureScale environment, when `maxRetriesForClientReroute` and `retryIntervalForClientReroute` are not set, and configuration property `db2.jcc.outputDirectory` is set:* Suppose that the following properties are set for a connection that is established from `DataSource A`:

Property	Value
enableClientAffinitiesList	DB2BaseDataSource.NO (2)
serverName	host1
portNumber	port1
db2.jcc.outputDirectory (configuration property)	/home/tmp

The following steps demonstrate an automatic client reroute scenario for a connection to a DB2 Database for Linux, UNIX, and Windows server:

1. Using the information in DataSource A, the IBM Data Server Driver for JDBC and SQLJ loads host1:port1 into its memory as the primary server address. The driver searches for cache file jccServerListCache.bin in /home/tmp, but the cache file does not exist.
2. The connection to host1:port1 succeeds. Suppose that the server returns a server list that contains host1:port1 and host2:port2.
3. The driver creates a cache in memory, with an entry that specifies host2:port2 as the alternate server list for host1:port1. The driver then creates the cache file /home/tmp/jccServerListCache.bin, and writes the cache from memory to this file.
4. The connection of Application A to host1:port1 fails, so the driver tries to connect to host2:port2.
5. The connection of Application A to host2:port2 succeeds. Suppose that the server returns a server list that contains host2:port2 and host2a:port2a. host2:port2 is the new primary server, and host2a:port2a is the new alternate server.
6. The driver looks for alternate server information for host2:port2 in the in-memory cache, but does not find any. It creates a new entry in the in-memory cache for host2:port2, with host2a:port2a as the alternate server list. The driver updates cache file /home/tmp/jccServerListCache.bin with the new entry that was added to the in-memory cache.
7. Application A completes, and the JVM exits.
8. Application B, which also uses DataSource A, starts.
9. The driver loads the server list from cache file /home/tmp/jccServerListCache.bin into memory, and finds the entry for host1:port1, which specifies host2:port2 as the alternate server list. The driver sets host2:port2 as the alternate server list for host1:port1.
10. A communication failure occurs when Application B tries to connect to host1:port1.
11. Application B attempts to connect to alternate server host2:port2.
12. The connection to host2:port2 succeeds. Application B continues.

*Example: Automatic client reroute to a DB2 Database for Linux, UNIX, and Windows server when maxRetriesForClientReroute and retryIntervalForClientReroute are set for multiple retries:* Suppose that the following properties are set for a connection to a database:

Property	Value
enableClientAffinitiesList	DB2BaseDataSource.NO (2)
serverName	host1

Property	Value
portNumber	port1
clientRerouteAlternateServerName	host2
clientRerouteAlternatePortNumber	port2
maxRetriesForClientReroute	3
retryIntervalForClientReroute	2

The following steps demonstrate an automatic client reroute scenario for a connection to a DB2 Database for Linux, UNIX, and Windows server:

1. The IBM Data Server Driver for JDBC and SQLJ loads host1:port1 into its memory as the primary server address, and host2:port2 into its memory as the alternate server address.
2. On the initial connection, the driver tries to connect to host1:port1.
3. The connection to host1:port1 fails, so the driver tries another connection to host1:port1.
4. The connection to host1:port1 fails again, so the driver tries to connect to host2:port2.
5. The connection to host2:port2 fails.
6. The driver waits two seconds.
7. The driver tries to connect to host1:port1 and fails.
8. The driver tries to connect to host2:port2 and fails.
9. The driver waits two seconds.
10. The driver tries to connect to host1:port1 and fails.
11. The driver tries to connect to host2:port2 and fails.
12. The driver waits two seconds.
13. The driver throws an SQLException with error code -4499.

## Operation of alternate group support

Alternate group support allows the IBM Data Server Driver for JDBC and SQLJ to move an application workload to an alternative DB2 pureScale instance when the primary DB2 pureScale instance is unavailable.

You enable alternate group support by providing the addresses of alternative DB2 pureScale instances in the `alternateGroupServerName`, `alternateGroupPortNumber`, and `alternateGroupDatabaseName` Connection or DataSource properties, or the `db2.jcc.alternateGroupServerName`, `db2.jcc.alternateGroupPortNumber`, and `db2.jcc.alternateGroupDatabaseName` configuration properties. The Connection or DataSource property values override the configuration property values.

In addition, you can control whether seamless failover behavior is in effect for alternate group support by setting the `enableAlternateGroupSeamlessACR` Connection or DataSource property, or the `db2.jcc.enableAlternateGroupSeamlessACR` configuration property.

After failover from the primary group to an alternate group, the value of the `databaseName` property remains the same.

For alternate group support to work properly, the data in the primary group and alternate groups must be the same.

Alternate group support operates in the following way:

- For the first connection of an application to a primary DB2 pureScale instance:
  1. The IBM Data Server Driver for JDBC and SQLJ attempts to connect the application to the primary DB2 pureScale instance.
  2. If the connection fails, the driver attempts to connect the application to the alternative DB2 pureScale instance that is specified by the first set of values in the `alternateGroupServerName`, `alternateGroupPortNumber`, and `alternateGroupDatabaseName` properties.
  3. If the connection fails, the driver attempts to connect the application to the alternative DB2 pureScale instance that is specified by the next set of values in the `alternateGroupServerName`, `alternateGroupPortNumber`, and `alternateGroupDatabaseName` properties. The driver continues this step until a successful connection is established, or the driver has tried all sets of values in the `alternateGroupServerName`, `alternateGroupPortNumber`, and `alternateGroupDatabaseName` properties.
  4. If a connection is not established, the driver returns SQL error -4499 to the application.
- For a subsequent connection after the application is connected to the primary DB2 pureScale instance:
  1. The IBM Data Server Driver for JDBC and SQLJ attempts to reconnect the application to each of the available members of the primary DB2 pureScale instance.
  2. If no members of the primary DB2 pureScale instance are available on the first attempt, the driver retries the connection to the primary DB2 pureScale instance, using the address that is specified by the set of values in the `serverName`, `portNumber`, and `databaseName` Connection or DataSource properties.
  3. If the connection to the primary DB2 pureScale instance fails, the driver attempts to connect the application to the alternative DB2 pureScale instance that is specified by the first set of values in the `alternateGroupServerName`, `alternateGroupPortNumber`, and `alternateGroupDatabaseName` properties.
  4. If the connection fails, the driver attempts to connect the application to the alternative DB2 pureScale instance that is specified by the next set of values in the `alternateGroupServerName`, `alternateGroupPortNumber`, and `alternateGroupDatabaseName` properties. The driver continues this step until a successful connection is established, or the driver has tried all sets of values in the `alternateGroupServerName`, `alternateGroupPortNumber`, and `alternateGroupDatabaseName` properties.
  5. If a connection is not established, the driver returns SQL error -4499 to the application.
- For a subsequent connection after the application is connected to an alternative DB2 pureScale instance:
  1. If no members of the alternative DB2 pureScale instance are available, the driver retries the connection to the same alternative DB2 pureScale instance, using the address that is specified for that group in the `alternateGroupServerName`, `alternateGroupPortNumber`, and `alternateGroupDatabaseName` Connection or DataSource properties.
  2. If the connection to the same alternative DB2 pureScale instance fails, the driver attempts to connect the application to the DB2 pureScale instance that is specified by the next set of entries in `alternateGroupServerName`, `alternateGroupPortNumber`, and `alternateGroupDatabaseName`.

3. If the connection fails, the driver attempts to connect the application to the alternative DB2 pureScale instance that is specified by the next set of values in the `alternateGroupServerName`, `alternateGroupPortNumber`, and `alternateGroupDatabaseName` properties. The driver continues this step until a successful connection is established, or the driver has tried all sets of values in the `alternateGroupServerName`, `alternateGroupPortNumber`, and `alternateGroupDatabaseName` properties.
  4. If a connection is not established, the driver returns SQL error -4499 to the application.
- For a connection to a primary group that is in a transaction:
    1. The IBM Data Server Driver for JDBC and SQLJ attempts to connect the application to an alternative DB2 pureScale instance.
    2. If a connection is established, `enableAlternateSeamlessGroupACR` is set to true, and the transaction qualifies for seamless failover, the transaction is retried.
    3. If a connection is established, `enableAlternateSeamlessGroupACR` is set to true, and the transaction does not qualify for seamless failover, the driver returns SQL error -30108 to the application.
    4. If a connection is established, and `enableAlternateSeamlessGroupACR` is set to false, the driver returns SQL error -30108 to the application.
    5. If a connection is not established, the driver returns SQL error -4499 to the application.

## Examples

Suppose that three groups are defined: PG1, AG1, and AG2. PG1 is the primary group, and AG1 and AG2 are alternative groups for IBM Data Server Driver for JDBC and SQLJ alternate group support.

Suppose that the groups have the following server, port, and database values:

group	Server, port, database values
PG1	host1, port1, dbname1
AG1	host2, port2, dbname2
AG2	host3, port3, dbname3

Also suppose that the following property values are set:

Property	Value
<code>serverName</code>	host1
<code>portNumber</code>	port1
<code>databaseName</code>	dbname1
<code>alternateGroupServerName</code>	host2,host3
<code>alternateGroupPortNumber</code>	port2,port3
<code>alternateGroupDatabaseName</code>	dbname2,dbname3
<code>enableAlternateGroupSeamlessACR</code>	true

The following steps demonstrate an alternate group scenario for a connection to PG1 that fails:

1. The driver attempts to connect the application to PG1, using host1:port1.
2. The connection fails.
3. The driver attempts to connect the application to AG1, using host2:port2.
4. The connection is successful.
5. The application continues to run.
6. All members of AG1 become unavailable, and the connection to AG1 fails.
7. The driver attempts to connect the application to AG1, using host2:port2.
8. The connection fails.
9. The driver attempts to connect the application to AG2, using host3:port3.
10. The connection fails.
11. The driver issues SQL error -4499.

The following steps demonstrate an alternate group scenario for a connection to PG1 that fails during a transaction:

1. The driver attempts to connect the application to PG1, using host1:port1.
2. The connection succeeds.
3. The application begins to perform work.
4. All members of PG1 go down.
5. The driver attempts to connect the application to AG1, using host2:port2.
6. The connection is successful.
7. The application meets the criteria for seamless failover, so the transaction is retried.
8. The retry fails.
9. The driver issues SQL error -30108 and rolls back work to the previous commit point.

## **Operation of workload balancing for connections to DB2 Database for Linux, UNIX, and Windows**

Workload balancing (also called transaction-level workload balancing) for connections to DB2 Database for Linux, UNIX, and Windows contributes to high availability by balancing work among servers in a DB2 pureScale instance at the start of a transaction.

The following overview describes the steps that occur when a client connects to a DB2 Database for Linux, UNIX, and Windows DB2 pureScale instance, and transaction-level workload balancing is enabled:

1. When the client first establishes a connection to the DB2 pureScale instance, the member to which the client connects returns a server list with the connection details (IP address, port, and weight) for the members of the DB2 pureScale instance.  
The server list is cached by the client. The default lifespan of the cached server list is 30 seconds.
2. At the start of a new transaction, the client reads the cached server list to identify a server that has unused capacity, and looks in the transport pool for an idle transport that is tied to the under-utilized server. (An idle transport is a transport that has no associated connection object.)
  - If an idle transport is available, the client associates the connection object with the transport.



- If, after a user-configurable timeout period (db2.jcc.maxTransportObjectWaitTime for a Java client or maxTransportWaitTime for a non-Java client), no idle transport is available in the transport pool and no new transport can be allocated because the transport pool has reached its limit, an error is returned to the application.
3. When the transaction runs, it accesses the server that is tied to the transport. When the first SQL statement in a transaction runs, if the IBM Data Server Driver for JDBC and SQLJ receives a communication failure because the data server drops the connection or the blockingReadConnectionTimeout value was exceeded, the driver retries the SQL statement 10 times before it reports an error. On every retry, the driver closes the existing transport, obtains a new transport and then executes the transaction. During these retries, if the maxRetriesForClientReroute and retryIntervalForClientReroute properties are set, their values apply only to the process of obtaining a new transport during each retry.
  4. When the transaction ends, the client verifies with the server that transport reuse is still allowed for the connection object.
  5. If transport reuse is allowed, the server returns a list of SET statements for special registers that apply to the execution environment for the connection object. The client caches these statements, which it replays in order to reconstruct the execution environment when the connection object is associated with a new transport.
  6. The connection object is then dissociated from the transport, if the client determines that it needs to do so.
  7. The client copy of the server list is refreshed when a new connection is made, or every 30 seconds, or the user-configured interval.
  8. When transaction-level workload balancing is required for a new transaction, the client uses the previously described process to associate the connection object with a transport.

## **Application programming requirements for high availability for connections to DB2 Database for Linux, UNIX, and Windows servers**

Failover for automatic client reroute can be seamless or non-seamless. If failover for connections to DB2 Database for Linux, UNIX, and Windows is not seamless, you need to add code to account for the errors that are returned when failover occurs.

If failover is non-seamless, and a connection is reestablished with the server, SQLCODE -4498 (for Java clients) or SQL30108N (for non-Java clients) is returned to the application. All work that occurred within the current transaction is rolled back. In the application, you need to:

- Check the reason code that is returned with the error. Determine whether special register settings on the failing data sharing member are carried over to the new (failover) data sharing member. Reset any special register values that are not current.
- Execute all SQL operations that occurred during the previous transaction.

The following conditions must be satisfied for failover for connections to DB2 Database for Linux, UNIX, and Windows to be seamless:

- The application programming language is Java, CLI, or .NET.



- The connection is not in a transaction. That is, the failure occurs when the first SQL statement in the transaction is executed.
- If transaction-level load balancing is enabled, the data server allows transport reuse at the end of the previous transaction.
- All global session data is closed or dropped.
- There are no open, held cursors.
- If the application uses CLI, the application cannot perform actions that require the driver to maintain a history of previously called APIs in order to replay the SQL statement. Examples of such actions are specifying data at execution time, performing compound SQL, or using array input.
- The application is not a stored procedure.
- Autocommit is not enabled. Seamless failover can occur when autocommit is enabled. However, the following situation can cause problems: Suppose that SQL work is successfully executed and committed at the data server, but the connection or server goes down before acknowledgment of the commit operation is sent back to the client. When the client re-establishes the connection, it replays the previously committed SQL statement. The result is that the SQL statement is executed twice. To avoid this situation, turn autocommit off when you enable seamless failover.

## Client affinities for DB2 Database for Linux, UNIX, and Windows

Client affinities is a client-only method for providing automatic client reroute capability.

Client affinities is available for applications that use CLI, .NET, or Java (IBM Data Server Driver for JDBC and SQLJ type 4 connectivity). All rerouting is controlled by the driver.

Client affinities is intended for situations in which you need to connect to a particular primary server. If an outage occurs during the connection to the primary server, you need to enforce a specific order for failover to alternate servers. You should use client affinities for automatic client reroute only if automatic client reroute that uses server failover capabilities does not work in your environment.

As part of configuration of client affinities, you specify a list of alternate servers, and the order in which connections to the alternate servers are tried. When client affinities is in use, connections are established based on the list of alternate servers instead of the host name and port number that are specified by the application. For example, if an application specifies that a connection is made to server1, but the configuration process specifies that servers should be tried in the order (server2, server3, server1), the initial connection is made to server2 instead of server1.

Failover with client affinities is seamless, if the following conditions are true:

- The connection is not in a transaction. That is, the failure occurs when the first SQL statement in the transaction is executed.
- There are no global temporary tables in use on the server.
- There are no open, held cursors.

When you use client affinities, you can specify that if the primary server returns to operation after an outage, connections return from an alternate server to the primary server on a transaction boundary. This activity is known as *failback*.

## Configuration of client affinities for Java clients for DB2 Database for Linux, UNIX, and Windows connections

To enable support for client affinities in Java applications, you set properties to indicate that you want to use client affinities, and to specify the primary and alternate servers.

The following table describes the property settings for enabling client affinities for Java applications.

*Table 39. Property settings to enable client affinities for Java applications*

<b>IBM Data Server Driver for JDBC and SQLJ setting</b>	<b>Value</b>
enableClientAffinitiesList	DB2BaseDataSource.YES (1)
clientRerouteAlternateServerName	A comma-separated list of the primary server and alternate servers
clientRerouteAlternatePortNumber	A comma-separated list of the port numbers for the primary server and alternate servers
enableSeamlessFailover	DB2BaseDataSource.YES (1) for seamless failover; DB2BaseDataSource.NO (2) or enableSeamlessFailover not specified for no seamless failover
maxRetriesForClientReroute	The number of times to retry the connection to each server, including the primary server, after a connection to the primary server fails. The default is 3.
retryIntervalForClientReroute	The number of seconds to wait between retries. The default is no wait.
affinityFailbackInterval	The number of seconds to wait after the first transaction boundary to fail back to the primary server. Set this value if you want to fail back to the primary server.

## Example of enabling client affinities in Java clients for DB2 Database for Linux, UNIX, and Windows connections

Before you can use client affinities for automatic client reroute in Java applications, you need to set properties to indicate that you want to use client affinities, and to identify the primary alternate servers.

The following example shows how to enable client affinities for failover without failback.

Suppose that you set the following properties for a connection to a database:

<b>Property</b>	<b>Value</b>
enableClientAffinitiesList	DB2BaseDataSource.YES (1)
clientRerouteAlternateServername	host1,host2,host3
clientRerouteAlternatePortNumber	port1,port2,port3
maxRetriesForClientReroute	3
retryIntervalForClientReroute	2

Suppose that a communication failure occurs during a connection to the server that is identified by host1:port1. The following steps demonstrate automatic client reroute with client affinities.

1. The driver tries to connect to host1:port1.
2. The connection to host1:port1 fails.
3. The driver waits two seconds.
4. The driver tries to connect to host1:port1.
5. The connection to host1:port1 fails.
6. The driver waits two seconds.
7. The driver tries to connect to host1:port1.
8. The connection to host1:port1 fails.
9. The driver waits two seconds.
10. The driver tries to connect to host2:port2.
11. The connection to host2:port2 fails.
12. The driver waits two seconds.
13. The driver tries to connect to host2:port2.
14. The connection to host2:port2 fails.
15. The driver waits two seconds.
16. The driver tries to connect to host2:port2.
17. The connection to host2:port2 fails.
18. The driver waits two seconds.
19. The driver tries to connect to host3:port3.
20. The connection to host3:port3 fails.
21. The driver waits two seconds.
22. The driver tries to connect to host3:port3.
23. The connection to host3:port3 fails.
24. The driver waits two seconds.
25. The driver tries to connect to host3:port3.
26. The connection to host3:port3 fails.
27. The driver waits two seconds.
28. The driver throws an SQLException with error code -4499.

The following example shows how to enable client affinities for failover with failback.

Suppose that you set the following properties for a connection to a database:

Property	Value
enableClientAffinitiesList	DB2BaseDataSource.YES (1)
clientRerouteAlternateServername	host1,host2,host3
clientRerouteAlternatePortNumber	port1,port2,port3
maxRetriesForClientReroute	3
retryIntervalForClientReroute	2
affinityFailbackInterval	300

Suppose that the database administrator takes the server that is identified by host1:port1 down for maintenance after a connection is made to host1:port1. The following steps demonstrate failover to an alternate server and failback to the primary server after maintenance is complete.

1. The driver successfully connects to host1:port1 on behalf of an application.
2. The database administrator brings down host1:port1.
3. The application tries to do work on the connection.
4. The driver successfully fails over to host2:port2.
5. After a total of 200 seconds have elapsed, the work is committed.
6. After a total of 300 seconds have elapsed, the failback interval has elapsed. The driver checks whether the primary server is up. It is not up, so no failback occurs.
7. After a total of 350 seconds have elapsed, host1:port1 is brought back online.
8. The application continues to do work on host2:port2, because the latest failback interval has not elapsed.
9. After a total of 600 seconds have elapsed, the failback interval has elapsed again. The driver checks whether the primary server is up. It is now up.
10. After a total of 650 seconds have elapsed, the work is committed.
11. After a total of 651 seconds have elapsed, the application tries to start a new transaction on host2:port2. Failback to host1:port1 occurs, so the new transaction starts on host1:port1.

---

## Java client support for high availability for connections to IBM Informix servers

High-availability cluster support on IBM Informix servers provides high availability for client applications, through workload balancing and automatic client reroute. This support is available for applications that use Java clients (JDBC, SQLJ, or pureQuery), or non-Java clients (ODBC, CLI, .NET, OLE DB, PHP, Ruby, or embedded SQL).

For Java clients, you need to use IBM Data Server Driver for JDBC and SQLJ type 4 connectivity to take advantage of IBM Informix high-availability cluster support.

For non-Java clients, you need to use one of the following clients or client packages to take advantage of high-availability cluster support:

- IBM Data Server Client
- IBM Data Server Runtime Client
- IBM Data Server Driver Package
- IBM Data Server Driver for ODBC and CLI

Cluster support for high availability for connections to IBM Informix servers includes:

### **Automatic client reroute**

This support enables a client to recover from a failure by attempting to reconnect to the database through any available server in a high-availability cluster. Reconnection to another server is called *failover*. You enable automatic client reroute on the client by enabling workload balancing on the client.

In an IBM Informix environment, primary and standby servers correspond to members of a high-availability cluster that is controlled by a Connection Manager. If multiple Connection Managers exist, the client can use them to

determine primary and alternate server information. The client uses alternate Connection Managers only for the initial connection.

Failover for automatic client reroute can be *seamless* or *non-seamless*. With non-seamless failover, when the client application reconnects to an alternate server, the server always returns an error to the application, to indicate that failover (connection to the alternate server) occurred.

For Java, CLI, or .NET client applications, failover for automatic client reroute can be seamless or non-seamless. Seamless failover means that when the application successfully reconnects to an alternate server, the server does not return an error to the application.

#### **Workload balancing**

Workload balancing can improve availability of an IBM Informix high-availability cluster. When workload balancing is enabled, the client gets frequent status information about the members of a high-availability cluster. The client uses this information to determine the server to which the next transaction should be routed. With workload balancing, IBM Informix Connection Managers ensure that work is distributed efficiently among servers and that work is transferred to another server if a server has a failure.

#### **Connection concentrator**

This support is available for Java applications that connect to IBM Informix. The connection concentrator reduces the resources that are required on IBM Informix database servers to support large numbers of workstation and web users. With the connection concentrator, only a few concurrent, active physical connections are needed to support many applications that concurrently access the database server. When you enable workload balancing on a Java client, you automatically enable the connection concentrator.

#### **Client affinities**

Client affinities is an automatic client reroute solution that is controlled completely by the client. It is intended for situations in which you need to connect to a particular primary server. If an outage occurs during the connection to the primary server, you use client affinities to enforce a specific order for failover to alternate servers.

## **Configuration of IBM Informix high-availability support for Java clients**

To configure a IBM Data Server Driver for JDBC and SQLJ client application that connects to an IBM Informix high-availability cluster, you need to connect to an address that represents a Connection Manager, and set the properties that enable workload balancing and the maximum number of connections.

High availability support for Java clients that connect to IBM Informix works for connections that are obtained using the `javax.sql.DataSource`, `javax.sql.ConnectionPoolDataSource`, `javax.sql.XADataSource`, or `java.sql.DriverManager` interface.

**Restriction:** High availability support for connections that are made with the `DriverManager` interface has the following restrictions:

- Alternate server information is shared between `DriverManager` connections only if you create the connections with the same URL and properties.
- You cannot set the `clientRerouteServerListJNDIName` property or the `clientRerouteServerListJNDIContext` properties for a `DriverManager` connection.

- High availability support is not enabled for default connections (jdbc:default:connection).

Before you can enable IBM Data Server Driver for JDBC and SQLJ for high availability for connections to IBM Informix, your installation must have one or more Connection Managers, a primary server, and one or more alternate servers.

The following table describes the basic property settings for enabling workload balancing for Java applications.

*Table 40. Basic settings to enable IBM Informix high availability support in Java applications*

IBM Data Server Driver for JDBC and SQLJ setting	Value
enableSysplexWLB property	true
maxTransportObjects property	The maximum number of connections that the requester can make to the high-availability cluster
Connection address: server	The IP address of a Connection Manager. See “Setting server and port properties for connecting to a Connection Manager” on page 274.
Connection address: port	The SQL port number for the Connection Manager. See “Setting server and port properties for connecting to a Connection Manager” on page 274.
Connection address: database	The database name

If you want to enable the connection concentrator, but you do not want to enable workload balancing, you can use these properties.

*Table 41. Settings to enable the IBM Informix connection concentrator without workload balancing in Java applications*

IBM Data Server Driver for JDBC and SQLJ setting	Value
enableSysplexWLB property	false
enableConnectionConcentrator property	true

If you want to fine-tune IBM Informix high-availability support, additional properties are available. The properties for the IBM Data Server Driver for JDBC and SQLJ are listed in the following table. Those properties are configuration properties, and not Connection or DataSource properties.

*Table 42. Properties for fine-tuning IBM Informix high-availability support for connections from the IBM Data Server Driver for JDBC and SQLJ*

IBM Data Server Driver for JDBC and SQLJ configuration property	Description
db2.jcc.maxTransportObjectIdleTime	Specifies the maximum elapsed time in number of seconds before an idle transport is dropped. The default is 60. The minimum supported value is 0.
db2.jcc.maxTransportObjectWaitTime	Specifies the number of seconds that the client will wait for a transport to become available. The default is -1 (unlimited). The minimum supported value is 0.

Table 42. Properties for fine-tuning IBM Informix high-availability support for connections from the IBM Data Server Driver for JDBC and SQLJ (continued)

IBM Data Server Driver for JDBC and SQLJ configuration property	Description
db2.jcc.minTransportObjects	Specifies the lower limit for the number of transport objects in a global transport object pool. The default value is 0. Any value that is less than or equal to 0 means that the global transport object pool can become empty.

## Setting server and port properties for connecting to a Connection Manager

To set the server and port number for connecting to a Connection Manager, follow this process:

- If your high-availability cluster is using a single Connection Manager, and your application is using the DataSource interface for connections, set the serverName and portNumber properties to the server name and port number of the Connection Manager.
- If your high-availability cluster is using a single Connection Manager, and your application is using the DriverManager interface for connections, specify the server name and port number of the Connection manager in the connection URL.
- If your high-availability cluster is using more than one Connection manager, and your application is using the DriverManager interface for connections:
  1. Specify the server name and port number of the main Connection Manager that you want to use in the connection URL.
  2. Set the clientRerouteAlternateServerName and clientRerouteAlternatePortNumber properties to the server names and port numbers of the alternative Connection Managers that you want to use.
- If your high-availability cluster is using more than one Connection Manager, and your application is using the DataSource interface for connections, use one of the following techniques:
  - Set the server names and port numbers in DataSource properties:
    1. Set the serverName and portNumber properties to the server name and port number of the main Connection Manager that you want to use.
    2. Set the clientRerouteAlternateServerName and clientRerouteAlternatePortNumber properties to the server names and port numbers of the alternative Connection Managers that you want to use.
  - Configure JNDI for high availability by using a DB2ClientRerouteServerList instance to identify the main Connection Manager and alternative Connection Managers.
    1. Create an instance of DB2ClientRerouteServerList.  
DB2ClientRerouteServerList is a serializable Java bean with the following properties:

Property name	Data type
com.ibm.db2.jcc.DB2ClientRerouteServerList.alternateServerName	String[]
com.ibm.db2.jcc.DB2ClientRerouteServerList.alternatePortNumber	int[]
com.ibm.db2.jcc.DB2ClientRerouteServerList.primaryServerName	String[]



Property name	Data type
com.ibm.db2.jcc.DB2ClientRerouteServerList.primaryPortNumber	int[]

getXXX and setXXX methods are defined for each property.

2. Set the com.ibm.db2.jcc.DB2ClientRerouteServerList.primaryServerName and com.ibm.db2.jcc.DB2ClientRerouteServerList.primaryPortNumber properties to the server name and port number of the main Connection Manager that you want to use.
3. Set the com.ibm.db2.jcc.DB2ClientRerouteServerList.alternateServerName and com.ibm.db2.jcc.DB2ClientRerouteServerList.alternatePortNumber properties to the server names and port numbers of the alternative Connection Managers that you want to use.
4. To make the DB2ClientRerouteServerList persistent:
  - a. Bind the DB2ClientRerouteServerList instance to the JNDI registry.
  - b. Assign the JNDI name of the DB2ClientRerouteServerList object to the IBM Data Server Driver for JDBC and SQLJ clientRerouteServerListJNDIName property.
  - c. Assign the name of the JNDI context that is used for binding and lookup of the DB2ClientRerouteServerList instance to the clientRerouteServerListJNDIContext property.

When a DataSource is configured to use JNDI for storing automatic client reroute alternate information, the standard server and port properties of the DataSource are not used for a getConnection request. Instead, the primary server address is obtained from the transient clientRerouteServerList information. If the JNDI store is not available due to a JNDI bind or lookup failure, the IBM Data Server Driver for JDBC and SQLJ attempts to make a connection using the standard server and port properties of the DataSource. Warnings are accumulated to indicate that a JNDI bind or lookup failure occurred.

After a failover:

- The IBM Data Server Driver for JDBC and SQLJ attempts to propagate the updated server information to the JNDI store.
- primaryServerName and primaryPortNumber values that are specified in DB2ClientRerouteServerList are used for the connection. If primaryServerName is not specified, the serverName value for the DataSource instance is used.

## Example of enabling IBM Informix high availability support in Java applications

Java client setup for IBM Informix high availability support includes setting several IBM Data Server Driver for JDBC and SQLJ properties.

The following example demonstrates setting up Java client applications for IBM Informix high availability support.

Before you can set up the client, you need to configure one or more high availability clusters that are controlled by Connection Managers.

Follow these steps to set up the client:

1. Verify that the IBM Data Server Driver for JDBC and SQLJ is at the correct level to support workload balancing by following these steps:



- a. Issue the following command in a command line window:
 

```
java com.ibm.db2.jcc.DB2Jcc -version
```
  - b. Find a line in the output like this, and check that *nnn* is 3.52 or later.
  - c.
 

```
[jcc] Driver: IBM Data Server Driver for JDBC and SQLJ Architecture nnn xxx
```
2. Set IBM Data Server Driver for JDBC and SQLJ properties to enable the connection concentrator or workload balancing:
    - a. Set these Connection or DataSource properties:
      - enableSysplexWLB
      - maxTransportObjects
    - b. Set the db2.jcc.maxRefreshInterval global configuration property in a DB2JccConfiguration.properties file to set the maximum refresh interval for all DataSource or Connection instances that are created under the driver.

Start with settings similar to these:

*Table 43. Example of property settings for workload balancing for DB2 Database for Linux, UNIX, and Windows*

Property	Setting
enableSysplexWLB	true
maxTransportObjects	80
db2.jcc.maxRefreshInterval	30

The values that are specified are not intended to be recommended values. You need to determine values based on factors such as the number of physical connections that are available. The number of transport objects must be equal to or greater than the number of connection objects.

3. Set IBM Data Server Driver for JDBC and SQLJ configuration properties to fine-tune the workload balancing for all DataSource or Connection instances that are created under the driver. Set the configuration properties in a DB2JccConfiguration.properties file by following these steps:
  - a. Create a DB2JccConfiguration.properties file or edit the existing DB2JccConfiguration.properties file.
  - b. Set the following configuration property:
    - db2.jcc.maxTransportObjects
 Start with a setting similar to this one:
 

```
db2.jcc.maxTransportObjects=500
```
  - c. Include the directory that contains DB2JccConfiguration.properties in the CLASSPATH concatenation.

## Operation of automatic client reroute for connections to IBM Informix from Java clients

When IBM Data Server Driver for JDBC and SQLJ client reroute support is enabled, a Java application that is connected to an IBM Informix high-availability cluster can continue to run when the primary server has a failure.

Automatic client reroute for a Java application that is connected to an IBM Informix server operates in the following way when automatic client reroute is enabled:

1. During each connection to the data source, the IBM Data Server Driver for JDBC and SQLJ obtains primary and alternate server information.
  - For the first connection to IBM Informix:

- a. The application specifies a server and port for the initial connection. Those values identify a Connection Manager.
  - b. The IBM Data Server Driver for JDBC and SQLJ uses the information from the Connection Manager to obtain information about the primary and alternate servers. IBM Data Server Driver for JDBC and SQLJ loads those values into memory.
  - c. If the initial connection to the Connection Manager fails:
    - If the `clientRerouteAlternateServerName` and `clientRerouteAlternatePortNumber` properties are set, the IBM Data Server Driver for JDBC and SQLJ connects to the Connection Manager that is identified by `clientRerouteAlternateServerName` and `clientRerouteAlternatePortNumber`, and obtains information about primary and alternate servers from that Connection Manager. The IBM Data Server Driver for JDBC and SQLJ loads those values into memory as the primary and alternate server values.
    - If the `clientRerouteAlternateServerName` and `clientRerouteAlternatePortNumber` properties are not set, and a JNDI store is configured by setting the property `clientRerouteServerListJNDIName` on the `DB2BaseDataSource`, the IBM Data Server Driver for JDBC and SQLJ connects to the Connection Manager that is identified by `DB2ClientRerouteServerList.alternateServerName` and `DB2ClientRerouteServerList.alternatePortNumber`, and obtains information about primary and alternate servers from that Connection Manager. IBM Data Server Driver for JDBC and SQLJ loads the primary and alternate server information from the Connection Manager into memory.
  - d. If `clientRerouteAlternateServerName` and `clientRerouteAlternatePortNumber` are not set, and JNDI is not configured, the IBM Data Server Driver for JDBC and SQLJ checks DNS tables for Connection Manager server and port information. If DNS information exists, the IBM Data Server Driver for JDBC and SQLJ connects to the Connection Manager, obtains information about primary and alternate servers, and loads those values into memory.
  - e. If no primary or alternate server information is available, a connection cannot be established, and the IBM Data Server Driver for JDBC and SQLJ throws an exception.
    - For subsequent connections, the IBM Data Server Driver for JDBC and SQLJ obtains primary and alternate server values from driver memory.
2. The IBM Data Server Driver for JDBC and SQLJ attempts to connect to the data source using the primary server name and port number.
- If the connection is through the `DriverManager` interface, the IBM Data Server Driver for JDBC and SQLJ creates an internal `DataSource` object for automatic client reroute processing.
3. If the connection to the primary server fails:
- a. If this is the first connection, the IBM Data Server Driver for JDBC and SQLJ attempts to reconnect to the original primary server.
  - b. If this is not the first connection, the IBM Data Server Driver for JDBC and SQLJ attempts to reconnect to the new primary server, whose server name and port number were provided by the server.
  - c. If reconnection to the primary server fails, the IBM Data Server Driver for JDBC and SQLJ attempts to connect to the alternate servers.

If this is not the first connection, the latest alternate server list is used to find the next alternate server.

Connection to an alternate server is called *failover*.

The IBM Data Server Driver for JDBC and SQLJ uses the `maxRetriesForClientReroute` and `retryIntervalForClientReroute` properties to determine how many times to retry the connection and how long to wait between retries. An attempt to connect to the primary server and alternate servers counts as one retry.

4. If the connection is not established, `maxRetriesForClientReroute` and `retryIntervalForClientReroute` are not set, and the original `serverName` and `portNumber` values that are defined on the `DataSource` are different from the `serverName` and `portNumber` values that were used for the original connection, retry the connection with the `serverName` and `portNumber` values that are defined on the `DataSource`.
5. If failover is successful during the initial connection, the driver generates an `SQLWarning`. If a successful failover occurs after the initial connection:

- If seamless failover is enabled, the driver retries the transaction on the new server, without notifying the application.

The following conditions must be satisfied for seamless failover to occur:

- The `enableSeamlessFailover` property is set to `DB2BaseDataSource.YES` (1).  
If Sysplex workload balancing is in effect (the value of the `enableSysplexWLB` is `true`), seamless failover is attempted, regardless of the `enableSeamlessFailover` setting.
- The connection is not in a transaction. That is, the failure occurs when the first SQL statement in the transaction is executed.
- There are no global temporary tables in use on the server.
- There are no open, held cursors.
- If seamless failover is not in effect, the driver throws an `SQLException` to the application with error code -4498, to indicate to the application that the connection was automatically reestablished and the transaction was implicitly rolled back. The application can then retry its transaction without doing an explicit rollback first.

A reason code that is returned with error code -4498 indicates whether any database server special registers that were modified during the original connection are reestablished in the failover connection.

You can determine whether alternate server information was used in establishing the initial connection by calling the `DB2Connection.alternateWasUsedOnConnect` method.

6. After failover, driver memory is updated with new primary and alternate server information from the new primary server.

## Examples

*Example: Automatic client reroute to an IBM Informix server when `maxRetriesForClientReroute` and `retryIntervalForClientReroute` are not set:* Suppose that the following properties are set for a connection to a database:

Property	Value
<code>enableClientAffinitiesList</code>	<code>DB2BaseDataSource.NO</code> (2)
<code>serverName</code>	<code>host1</code>
<code>portNumber</code>	<code>port1</code>

Property	Value
clientRerouteAlternateServerName	host2
clientRerouteAlternatePortNumber	port2

The following steps demonstrate an automatic client reroute scenario for a connection to IBM Informix:

1. The IBM Data Server Driver for JDBC and SQLJ tries to connect to the Connection Manager that is identified by host1:port1.
2. The connection to host1:port1 fails, so the driver tries to connect to the Connection Manager that is identified by host2:port2.
3. The connection to host2:port2 succeeds.
4. The driver retrieves alternate server information that was received from server host2:port2, and updates its memory with that information.  
Assume that the driver receives a server list that contains host2:port2, host2a:port2a. host2:port2 is stored as the new primary server, and host2a:port2a is stored as the new alternate server. If another communication failure is detected on this same connection, or on another connection that is created from the same DataSource, the driver tries to connect to host2:port2 as the new primary server. If that connection fails, the driver tries to connect to the new alternate server host2a:port2a.
5. The driver connects to host1a:port1a.
6. A failure occurs during the connection to host1a:port1a.
7. The driver tries to connect to host2a:port2a.
8. The connection to host2a:port2a is successful.
9. The driver retrieves alternate server information that was received from server host2a:port2a, and updates its memory with that information.

*Example: Automatic client reroute to an IBM Informix server when maxRetriesForClientReroute and retryIntervalForClientReroute are set for multiple retries:*  
Suppose that the following properties are set for a connection to a database:

Property	Value
enableClientAffinitiesList	DB2BaseDataSource.NO (2)
serverName	host1
portNumber	port1
clientRerouteAlternateServerName	host2
clientRerouteAlternatePortNumber	port2
maxRetriesForClientReroute	3
retryIntervalForClientReroute	2

The following steps demonstrate an automatic client reroute scenario for a connection to IBM Informix:

1. The IBM Data Server Driver for JDBC and SQLJ tries to connect to the Connection Manager that is identified by host1:port1.
2. The connection to host1:port1 fails, so the driver tries to connect to the Connection Manager that is identified by host2:port2.
3. The connection to host2:port2 succeeds.

4. The driver retrieves alternate server information from the connection manager that is identified by host2:port2, and updates its memory with that information. Assume that the Connection Manager identifies host1a:port1a as the new primary server, and host2a:port2a as the new alternate server.
5. The driver tries to connect to host1a:port1a.
6. The connection to host1a:port1a fails.
7. The driver tries to connect to host2a:port2a.
8. The connection to host2a:port2a fails.
9. The driver waits two seconds.
10. The driver tries to connect to host1a:port1a.
11. The connection to host1a:port1a fails.
12. The driver tries to connect to host2a:port2a.
13. The connection to host2a:port2a fails.
14. The driver waits two seconds.
15. The driver tries to connect to host1a:port1a.
16. The connection to host1a:port1a fails.
17. The driver tries to connect to host2a:port2a.
18. The connection to host2a:port2a fails.
19. The driver waits two seconds.
20. The driver throws an SQLException with error code -4499.

## Operation of workload balancing for connections to IBM Informix from Java clients

Workload balancing (also called transaction-level workload balancing) for connections to IBM Informix contributes to high availability by balancing work among servers in a high-availability cluster at the start of a transaction.

The following overview describes the steps that occur when a client connects to an IBM Informix Connection Manager, and workload balancing is enabled:

1. When the client first establishes a connection using the IP address of the Connection Manager, the Connection Manager returns the server list and the connection details (IP address, port, and weight) for the servers in the cluster. The server list is cached by the client. The default lifespan of the cached server list is 30 seconds.
2. At the start of a new transaction, the client reads the cached server list to identify a server that has untapped capacity, and looks in the transport pool for an idle transport that is tied to the under-utilized server. (An idle transport is a transport that has no associated connection object.)
  - If an idle transport is available, the client associates the connection object with the transport.
  - If, after a user-configurable timeout, no idle transport is available in the transport pool and no new transport can be allocated because the transport pool has reached its limit, an error is returned to the application.
3. When the transaction runs, it accesses the server that is tied to the transport. When the first SQL statement in a transaction runs, if the IBM Data Server Driver for JDBC and SQLJ receives a communication failure because the data server drops the connection or the blockingReadConnectionTimeout value was exceeded, the driver retries the SQL statement 10 times before it reports an error. On every retry, the driver closes the existing transport, obtains a new

transport and then executes the transaction. During these retries, if the `maxRetriesForClientReroute` and `retryIntervalForClientReroute` properties are set, their values apply only to the process of obtaining a new transport during each retry.

4. When the transaction ends, the client verifies with the server that transport reuse is still allowed for the connection object.
5. If transport reuse is allowed, the server returns a list of SET statements for special registers that apply to the execution environment for the connection object.  
The client caches these statements, which it replays in order to reconstruct the execution environment when the connection object is associated with a new transport.
6. The connection object is then dissociated from the transport, if the client determines that it needs to do so.
7. The client copy of the server list is refreshed when a new connection is made, or every 30 seconds, or at the user-configured interval.
8. When workload balancing is required for a new transaction, the client uses the previously described process to associate the connection object with a transport.

## **Application programming requirements for high availability for connections from Java clients to IBM Informix servers**

Failover for automatic client reroute can be seamless or non-seamless. If failover for connections to IBM Informix is not seamless, you need to add code to account for the errors that are returned when failover occurs.

If failover is non-seamless, and a connection is reestablished with the server, `SQLCODE -4498` (for Java clients) or `SQL30108N` (for non-Java clients) is returned to the application. All work that occurred within the current transaction is rolled back. In the application, you need to:

- Check the reason code that is returned with the error. Determine whether special register settings on the failing data sharing member are carried over to the new (failover) data sharing member. Reset any special register values that are not current.
- Execute all SQL operations that occurred during the previous transaction.

The following conditions must be satisfied for seamless failover to occur during connections to IBM Informix databases:

- The application programming language is Java, CLI, or .NET.
- The connection is not in a transaction. That is, the failure occurs when the first SQL statement in the transaction is executed.
- The data server must allow transport reuse at the end of the previous transaction.
- All global session data is closed or dropped.
- There are no open held cursors.
- If the application uses CLI, the application cannot perform actions that require the driver to maintain a history of previously called APIs in order to replay the SQL statement. Examples of such actions are specifying data at execution time, performing compound SQL, or using array input.
- The application is not a stored procedure.
- Autocommit is not enabled. Seamless failover can occur when autocommit is enabled. However, the following situation can cause problems: Suppose that

SQL work is successfully executed and committed at the data server, but the connection or server goes down before acknowledgment of the commit operation is sent back to the client. When the client re-establishes the connection, it replays the previously committed SQL statement. The result is that the SQL statement is executed twice. To avoid this situation, turn autocommit off when you enable seamless failover.

In addition, seamless automatic client reroute might not be successful if the application has autocommit enabled. With autocommit enabled, a statement might be executed and committed multiple times.

## Client affinities for connections to IBM Informix from Java clients

Client affinities is a client-only method for providing automatic client reroute capability.

Client affinities is available for applications that use CLI, .NET, or Java (IBM Data Server Driver for JDBC and SQLJ type 4 connectivity). All rerouting is controlled by the driver.

Client affinities is intended for situations in which you need to connect to a particular primary server. If an outage occurs during the connection to the primary server, you need to enforce a specific order for failover to alternate servers. You should use client affinities for automatic client reroute only if automatic client reroute that uses server failover capabilities does not work in your environment.

As part of configuration of client affinities, you specify a list of alternate servers, and the order in which connections to the alternate servers are tried. When client affinities is in use, connections are established based on the list of alternate servers instead of the host name and port number that are specified by the application. For example, if an application specifies that a connection is made to server1, but the configuration process specifies that servers should be tried in the order (server2, server3, server1), the initial connection is made to server2 instead of server1.

Failover with client affinities is seamless, if the following conditions are true:

- The connection is not in a transaction. That is, the failure occurs when the first SQL statement in the transaction is executed.
- There are no global temporary tables in use on the server.
- There are no open, held cursors.

When you use client affinities, you can specify that if the primary server returns to operation after an outage, connections return from an alternate server to the primary server on a transaction boundary. This activity is known as *failback*.

### Configuration of client affinities for Java clients for IBM Informix connections

To enable support for client affinities in Java applications, you set properties to indicate that you want to use client affinities, and to specify the primary and alternate servers.

The following table describes the property settings for enabling client affinities for Java applications.



Table 44. Property settings to enable client affinities for Java applications

IBM Data Server Driver for JDBC and SQLJ setting	Value
enableClientAffinitiesList	DB2BaseDataSource.YES (1)
clientRerouteAlternateServerName	A comma-separated list of the primary server and alternate servers
clientRerouteAlternatePortNumber	A comma-separated list of the port numbers for the primary server and alternate servers
enableSeamlessFailover	DB2BaseDataSource.YES (1) for seamless failover; DB2BaseDataSource.NO (2) or enableSeamlessFailover not specified for no seamless failover
maxRetriesForClientReroute	The number of times to retry the connection to each server, including the primary server, after a connection to the primary server fails. The default is 3.
retryIntervalForClientReroute	The number of seconds to wait between retries. The default is no wait.
affinityFailbackInterval	The number of seconds to wait after the first transaction boundary to fail back to the primary server. Set this value if you want to fail back to the primary server.

### Example of enabling client affinities in Java clients for IBM Informix connections

Before you can use client affinities for automatic client reroute in Java applications, you need to set properties to indicate that you want to use client affinities, and to identify the primary alternate servers.

The following example shows how to enable client affinities for failover without failback.

Suppose that you set the following properties for a connection to a database:

Property	Value
enableClientAffinitiesList	DB2BaseDataSource.YES (1)
clientRerouteAlternateServername	host1,host2,host3
clientRerouteAlternatePortNumber	port1,port2,port3
maxRetriesForClientReroute	3
retryIntervalForClientReroute	2

Suppose that a communication failure occurs during a connection to the server that is identified by host1:port1. The following steps demonstrate automatic client reroute with client affinities.

1. The driver tries to connect to host1:port1.
2. The connection to host1:port1 fails.
3. The driver waits two seconds.
4. The driver tries to connect to host1:port1.
5. The connection to host1:port1 fails.
6. The driver waits two seconds.



7. The driver tries to connect to host1:port1.
8. The connection to host1:port1 fails.
9. The driver waits two seconds.
10. The driver tries to connect to host2:port2.
11. The connection to host2:port2 fails.
12. The driver waits two seconds.
13. The driver tries to connect to host2:port2.
14. The connection to host2:port2 fails.
15. The driver waits two seconds.
16. The driver tries to connect to host2:port2.
17. The connection to host2:port2 fails.
18. The driver waits two seconds.
19. The driver tries to connect to host3:port3.
20. The connection to host3:port3 fails.
21. The driver waits two seconds.
22. The driver tries to connect to host3:port3.
23. The connection to host3:port3 fails.
24. The driver waits two seconds.
25. The driver tries to connect to host3:port3.
26. The connection to host3:port3 fails.
27. The driver waits two seconds.
28. The driver throws an SQLException with error code -4499.

The following example shows how to enable client affinities for failover with failback.

Suppose that you set the following properties for a connection to a database:

Property	Value
enableClientAffinitiesList	DB2BaseDataSource.YES (1)
clientRerouteAlternateServername	host1,host2,host3
clientRerouteAlternatePortNumber	port1,port2,port3
maxRetriesForClientReroute	3
retryIntervalForClientReroute	2
affinityFailbackInterval	300

Suppose that the database administrator takes the server that is identified by host1:port1 down for maintenance after a connection is made to host1:port1. The following steps demonstrate failover to an alternate server and failback to the primary server after maintenance is complete.

1. The driver successfully connects to host1:port1 on behalf of an application.
2. The database administrator brings down host1:port1.
3. The application tries to do work on the connection.
4. The driver successfully fails over to host2:port2.
5. After a total of 200 seconds have elapsed, the work is committed.

6. After a total of 300 seconds have elapsed, the failback interval has elapsed. The driver checks whether the primary server is up. It is not up, so no failback occurs.
7. After a total of 350 seconds have elapsed, host1:port1 is brought back online.
8. The application continues to do work on host2:port2, because the latest failback interval has not elapsed.
9. After a total of 600 seconds have elapsed, the failback interval has elapsed again. The driver checks whether the primary server is up. It is now up.
10. After a total of 650 seconds have elapsed, the work is committed.
11. After a total of 651 seconds have elapsed, the application tries to start a new transaction on host2:port2. Failback to host1:port1 occurs, so the new transaction starts on host1:port1.

---

## Java client direct connect support for high availability for connections to DB2 for z/OS servers

Sysplex workload balancing functionality on DB2 for z/OS servers provides high availability for client applications that connect directly to a data sharing group. Sysplex workload balancing functionality provides workload balancing and automatic client reroute capability. This support is available for applications that use Java clients (JDBC, SQLJ, or pureQuery) that use IBM Data Server Driver for JDBC and SQLJ type 4 connectivity, or non-Java clients (ODBC, CLI, .NET, OLE DB, PHP, Ruby, or embedded SQL). Workload balancing is transparent to applications.

A Sysplex is a set of z/OS systems that communicate and cooperate with each other through certain multisystem hardware components and software services to process customer workloads. DB2 for z/OS subsystems on the z/OS systems in a Sysplex can be configured to form a data sharing group. With data sharing, applications that run on more than one DB2 for z/OS subsystem can read from and write to the same set of data concurrently. One or more coupling facilities provide high-speed caching and lock processing for the data sharing group. The Sysplex, together with the Workload Manager (WLM), dynamic virtual IP address (DVIPA), and the Sysplex Distributor, allow a client to access a DB2 for z/OS database over TCP/IP with network resilience, and distribute transactions for an application in a balanced manner across members within the data sharing group.

Central to these capabilities is a server list that the data sharing group returns on connection boundaries and optionally on transaction boundaries. This list contains the IP address and WLM weight for each data sharing group member. With this information, a client can distribute transactions in a balanced manner, or identify the member to use when there is a communication failure.

The server list is returned on the first successful connection to the DB2 for z/OS data server. After the client has received the server list, the client directly accesses a data sharing group member based on information in the server list.

DB2 for z/OS provides several methods for clients to access a data sharing group. The access method that is set up for communication with the data sharing group determines whether Sysplex workload balancing is possible. The following table lists the access methods and indicates whether Sysplex workload balancing is possible.

Table 45. Data sharing access methods and Sysplex workload balancing

Data sharing access method <sup>1</sup>	Description	Sysplex workload balancing possible?
Group access	<p>A requester uses the group's dynamic virtual IP address (DVIPA) to make an initial connection to the DB2 for z/OS location. A connection to the data sharing group that uses the group IP address and SQL port is always successful if at least one member is started. The server list that is returned by the data sharing group contains:</p> <ul style="list-style-type: none"> <li>• A list of members that are currently active and can perform work</li> <li>• The WLM weight for each member</li> </ul> <p>The group IP address is configured using the z/OS Sysplex distributor. To clients that are outside the Sysplex, the Sysplex distributor provides a single IP address that represents a DB2 location. In addition to providing fault tolerance, the Sysplex distributor can be configured to provide connection load balancing.</p>	Yes
Member-specific access	<p>A requester uses a location alias to make an initial connection to one of the members that is represented by the alias. A connection to the data sharing group that uses the group IP address and alias SQL port is always successful if at least one member is started. The server list that is returned by the data sharing group contains:</p> <ul style="list-style-type: none"> <li>• A list of members that are currently active, can perform work, and have been configured as an alias</li> <li>• The WLM weight for each member</li> </ul> <p>The requester uses this information to connect to the member or members with the most capacity that are also associated with the location alias. Member-specific access is used when requesters need to take advantage of Sysplex workload balancing among a subset of members of a data sharing group.</p>	Yes
Single-member access	<p>Single-member access is used when requesters need to access only one member of a data sharing group. For single-member access, the connection uses the member-specific IP address.</p>	No

**Note:**

1. For more information on data sharing access methods, see [http://publib.boulder.ibm.com/infocenter/dzichelp/v2r2/topic/com.ibm.db29.doc.dshare/db2z\\_tcpipaccessmethods.htm](http://publib.boulder.ibm.com/infocenter/dzichelp/v2r2/topic/com.ibm.db29.doc.dshare/db2z_tcpipaccessmethods.htm).

*Sysplex workload balancing includes automatic client reroute:* Automatic client reroute support enables a client to recover from a failure by attempting to reconnect to the database through any available member of a Sysplex. Reconnection to another member is called *failover*.

*Sysplex workload balancing during migration of a data sharing group to DB2 9.1 for z/OS or DB2 10 for z/OS:* In general, if you use IBM Data Server Driver for JDBC and SQLJ Version 3.61 or 4.11, migration of a data sharing group from DB2 for z/OS Version 8 or Version 9.1 to Version 10, or DB2 for z/OS Version 8 to Version 9.1 does not cause an outage for Java applications that connect to the data sharing group using IBM Data Server Driver for JDBC and SQLJ type 4 connectivity. You do not need to restart all members of the data sharing group or JVMs to maintain balanced connections. In addition, if you use IBM Data Server Driver for JDBC and SQLJ Version 3.62 or 4.12 or later, in any mode during the migration from DB2 for z/OS Version 8 or Version 9.1 new-function mode to Version 10 new-function mode, or from DB2 for z/OS Version 8 new-function mode to Version 9.1 new-function mode, new applications that use features that require a higher DRDA level can coexist with old applications that use a lower DRDA level, if they use the same DataSource. This coexistence includes reversion from a mode to a previous mode, such as reversion from Version 10 ENFM9 to CM9\*. For coexistence of DRDA levels, you need to have APAR PM24292 installed on the DB2 for z/OS Version 9.1 and DB2 for z/OS Version 10 data servers.

*Sysplex workload balancing during migration of a data sharing group to DB2 9.1 for z/OS:* When you migrate a data sharing group to DB2 9.1 for z/OS new-function mode, you need to take these steps:

1. Restart all members of the data group.
2. Restart the JVMs under which applications that connect to the data sharing group using IBM Data Server Driver for JDBC and SQLJ type 4 connectivity run.

Stopping and starting all members prevents applications that use Sysplex workload balancing from having unbalanced connections.

For Java, CLI, or .NET client applications, failover for automatic client reroute can be *seamless* or *non-seamless*. Seamless failover means that when the application successfully reconnects to an alternate server, the server does not return an error to the application.

*Client direct connect support for high availability with a DB2 Connect server:* Client direct connect support for high availability requires a DB2 Connect license, but does not need a DB2 Connect server. The client connects directly to DB2 for z/OS. If you use a DB2 Connect server, but set up your environment for client high availability, you cannot take advantage of some of the features that a direct connection to DB2 for z/OS provides, such as transaction-level workload balancing or automatic client reroute capability that is provided by the Sysplex.

*Do not use client affinities:* Client affinities should not be used as a high availability solution for direct connections to DB2 for z/OS. Client affinities is not applicable to a DB2 for z/OS data sharing environment, because all members of a data sharing group can access data concurrently. A major disadvantage of client affinities in a data sharing environment is that if failover occurs because a data sharing group member fails, the member that fails might have retained locks that can severely affect transactions on the member to which failover occurs.

## **Configuration of Sysplex workload balancing and automatic client reroute for Java clients**

To configure a IBM Data Server Driver for JDBC and SQLJ client application that connects directly to DB2 for z/OS to use Sysplex workload balancing and automatic client reroute, you need to use IBM Data Server Driver for JDBC and

SQLJ type 4 connectivity. You also need to connect to an address that represents the data sharing group (for group access) or a subset of the data sharing group (for member-specific access), and set the properties that enable workload balancing and the maximum number of connections.

You should always configure Sysplex workload balancing and automatic client reroute together. When you configure a client to use Sysplex workload balancing, automatic client reroute is also enabled. Therefore, you need to change property settings that are related to automatic client reroute only to fine tune automatic client reroute operation.

The following table describes the basic property settings for Java applications.

*Table 46. Basic settings to enable Sysplex high availability support in Java applications*

<b>Data sharing access method</b>	<b>IBM Data Server Driver for JDBC and SQLJ setting</b>	<b>Value</b>
Group access	enableSysplexWLB property	true
	Connection address:	
	server	The group IP address or domain name of the data sharing group
	port	The SQL port number for the DB2 location
	database	The DB2 location name that is defined during installation
Member-specific access	enableSysplexWLB property	true
	Connection address:	
	server	The group IP address or domain name of the data sharing group
	port	The port number for the DB2 location alias
	database	The name of the DB2 location alias that represents a subset of the members of the data sharing group

If you want to fine-tune Sysplex workload balancing and automatic client reroute, additional properties are available.

The following IBM Data Server Driver for JDBC and SQLJ Connection or DataSource properties control Sysplex workload balancing and automatic client reroute.

*Table 47. Connection or DataSource properties for fine-tuning Sysplex workload balancing and automatic client reroute for direct connections from the IBM Data Server Driver for JDBC and SQLJ to DB2 for z/OS*

<b>IBM Data Server Driver for JDBC and SQLJ property</b>	<b>Description</b>
blockingReadConnectionTimeout	Specifies the amount of time in seconds before a connection socket read times out. This property affects all requests that are sent to the data source after a connection is successfully established. The default is 0, which means that there is no timeout. Set this property to a value greater by a few seconds than the time that is required to execute the longest query in the application.

Table 47. Connection or DataSource properties for fine-tuning Sysplex workload balancing and automatic client reroute for direct connections from the IBM Data Server Driver for JDBC and SQLJ to DB2 for z/OS (continued)

IBM Data Server Driver for JDBC and SQLJ property	Description
enableSeamlessFailover	Specifies whether the driver uses seamless failover for automatic client reroute. The default is that the driver does not use seamless failover. This property should be set to DB2BaseDataSource.YES (1) only if applications can handle SQLExceptions with SQL error -30108.
loginTimeout	Specifies the maximum time in seconds to wait for a new connection to a data source. After the number of seconds that are specified by loginTimeout have elapsed, the driver closes the connection to the data source. The default is 0, which means that the timeout value is the default system timeout value. The recommended value is five seconds.
maxRetriesForClientReroute	Specifies the number of times that the driver retries the connection if the primary connection to the data server fails. If maxRetriesForClientReroute or retryIntervalForClientReroute is not set, or both properties are not set, the driver performs retries for 10 minutes, with no wait between retries.
maxTransportObjects	Specifies the maximum number of connections that the requester can make to the data sharing group. The default is -1, which means an unlimited number.
retryIntervalForClientReroute	Specifies the amount of time in seconds between connection retries.

The following IBM Data Server Driver for JDBC and SQLJ configuration properties also control Sysplex workload balancing.

Table 48. Configuration properties for fine-tuning Sysplex workload balancing for direct connections from the IBM Data Server Driver for JDBC and SQLJ to DB2 for z/OS

IBM Data Server Driver for JDBC and SQLJ configuration property	Description
db2.jcc.maxRefreshInterval	Specifies the maximum amount of time in seconds between refreshes of the client copy of the server list. The default is 30. The minimum valid value is 1.
db2.jcc.maxTransportObjectIdleTime	Specifies the maximum elapsed time in number of seconds before an idle transport is dropped. The default is 60. The minimum supported value is 0.
db2.jcc.maxTransportObjectWaitTime	Specifies the number of seconds that the client will wait for a transport to become available. The default is -1 (unlimited). The minimum supported value is 0.
db2.jcc.minTransportObjects	Specifies the lower limit for the number of transport objects in a global transport object pool. The default value is 0. Any value that is less than or equal to 0 means that the global transport object pool can become empty.

## Example of enabling DB2 for z/OS Sysplex workload balancing and automatic client reroute in Java applications

Java client setup for Sysplex workload balancing and automatic client reroute includes setting several IBM Data Server Driver for JDBC and SQLJ properties.

The following examples demonstrate setting up Java client applications for Sysplex workload balancing and automatic client reroute for high availability.

Before you can set up the client, you need to configure the following server software:

- WLM for z/OS

For workload balancing to work efficiently, DB2 work needs to be classified. Classification applies to the first non-SET SQL statement in each transaction.

Among the areas by which you need to classify the work are:

- Authorization ID
- Client info properties
- Stored procedure name

The stored procedure name is used for classification only if the first statement that is issued by the client in the transaction is an SQL CALL statement.

For a complete list of classification attributes, see the information on classification attributes at the following URL:

[http://publib.boulder.ibm.com/infocenter/dzichelp/v2r2/-topic/com.ibm.db2z10.doc.perf/src/tpc/db2z\\_classificationattributes.htm](http://publib.boulder.ibm.com/infocenter/dzichelp/v2r2/-topic/com.ibm.db2z10.doc.perf/src/tpc/db2z_classificationattributes.htm)

- DB2 for z/OS, set up for data sharing

## Example of setup with WebSphere Application Server

This example assumes that you are using WebSphere Application Server. The minimum level of WebSphere Application Server is Version 5.1.

Follow these steps to set up the client:

1. Verify that the IBM Data Server Driver for JDBC and SQLJ is at the correct level to support the Sysplex workload balancing by following these steps:
  - a. Issue the following command in a command line window

```
java com.ibm.db2.jcc.DB2Jcc -version
```
  - b. Find a line in the output like this, and check that *nnn* is 3.50 or later.

```
[jcc] Driver: IBM Data Server Driver for JDBC and SQLJ Architecture nnn xxx
```
2. In the WebSphere Application Server administrative console, set the IBM Data Server Driver for JDBC and SQLJ data source property `enableSysplexWLB` to `true`, to enable Sysplex workload balancing. Enabling Sysplex workload balancing enables automatic client reroute by default.

In the WebSphere Application Server administrative console, set other properties for which the defaults are unacceptable.

*Table 49. Example of data source property settings for IBM Data Server Driver for JDBC and SQLJ Sysplex workload balancing and automatic client reroute for DB2 for z/OS*

Property	Setting
<code>enableSysplexWLB</code>	<code>true</code>
<code>maxRetriesForClientReroute</code>	10 <sup>1</sup>
<code>maxTransportObjects</code>	80 <sup>2</sup>
<code>retryIntervalForClientReroute</code>	20 <sup>1</sup>



Table 49. Example of data source property settings for IBM Data Server Driver for JDBC and SQLJ Sysplex workload balancing and automatic client reroute for DB2 for z/OS (continued)

Property	Setting
----------	---------

**Note:**

1. This combination of settings for `maxRetriesForClientReroute` and `retryIntervalForClientReroute` results in 10 retries, at 20-second intervals. You need to set `maxRetriesForClientReroute` and `retryIntervalForClientReroute`; otherwise, the default setting of continuous retries for 10 minutes is used.
2. Set `maxTransportObjects` to a value that is larger than the `MaxConnections` value for the WebSphere Application Server connection pool. Doing so allows workload balancing to occur between data sharing members without the need to open and close connections to DB2.

3. Set IBM Data Server Driver for JDBC and SQLJ configuration properties to fine-tune workload balancing for all `DataSource` or `Connection` instances that are created under the driver. Set the configuration properties in a `DB2JccConfiguration.properties` file by following these steps:
  - a. Create a `DB2JccConfiguration.properties` file or edit the existing `DB2JccConfiguration.properties` file.
  - b. Set the `db2.jcc.maxTransportObjects` configuration property only if multiple `DataSource` objects are defined that point to the same data sharing group, and the number of connections across the different `DataSource` objects needs to be limited.  
Start with a setting similar to this one:  
`db2.jcc.maxTransportObjects=500`
  - c. Set the `db2.jcc.maxRefreshInterval` configuration property. This property requires version 3.58 or later of the IBM Data Server Driver for JDBC and SQLJ.  
Start with a setting similar to this one:  
`db2.jcc.maxRefreshInterval=30`
  - d. Add the directory path for `DB2JccConfiguration.properties` to the WebSphere Application Server IBM Data Server Driver for JDBC and SQLJ classpath.
  - e. Restart WebSphere Application Server.

### Example of setup for DriverManager connections

This example assumes that you are using the `DriverManager` interface to establish a connection.

Follow these steps to set up the client:

1. Verify that the IBM Data Server Driver for JDBC and SQLJ is at the correct level to support the Sysplex workload balancing and automatic client reroute by following these steps:
  - a. Issue the following command in a command line window  
`java com.ibm.db2.jcc.DB2Jcc -version`
  - b. Find a line in the output like this, and check that `nnn` is 3.50 or later. A minimum driver level of 3.50 is required for using Sysplex workload balancing and automatic client reroute for `DriverManager` connections.
  - c.

[jcc] Driver: IBM Data Server Driver for JDBC and SQLJ Architecture `nnn xxx`



2. Set the IBM Data Server Driver for JDBC and SQLJ Connection property `enableSysplexWLB` to enable workload balancing. Enabling Sysplex workload balancing enables automatic client reroute by default. Set any other properties for which the defaults are unacceptable. For example, the following code sets the property values that are listed in Table 49 on page 290.

```
java.util.Properties properties = new java.util.Properties();
properties.put("user", "xxxx");
properties.put("password", "yyyy");
properties.put("enableSysplexWLB", "true");
properties.put("maxTransportObjects", "80");
properties.put("maxRetriesForClientReroute", "10");
properties.put("retryIntervalForClientReroute", "20");
java.sql.Connection con =
    java.sql.DriverManager.getConnection(url, properties);
```

3. Set IBM Data Server Driver for JDBC and SQLJ configuration properties to fine-tune workload balancing for all `DataSource` or `Connection` instances that are created under the driver. Set the configuration properties in a `DB2JccConfiguration.properties` file by following these steps:
  - a. Create a `DB2JccConfiguration.properties` file or edit the existing `DB2JccConfiguration.properties` file.
  - b. Set the `db2.jcc.maxTransportObjects` configuration property only if multiple `DataSource` objects are defined that point to the same data sharing group, and the number of connections across the different `DataSource` objects needs to be limited.

Start with a setting similar to this one:

```
db2.jcc.maxTransportObjects=500
```

- c. Include the directory that contains `DB2JccConfiguration.properties` in the `CLASSPATH` concatenation.

## Operation of Sysplex workload balancing for connections from Java clients to DB2 for z/OS servers

Sysplex workload balancing (also called transaction-level workload balancing) for connections to DB2 for z/OS contributes to high availability by balancing work among members of a data sharing group at the start of a transaction.

The following overview describes the steps that occur when a client connects to a DB2 for z/OS Sysplex, and Sysplex workload balancing is enabled:

1. When the client first establishes a connection using the sysplex-wide IP address called the group IP address, or when a connection is reused by another connection object, the server returns member workload distribution information.

The default lifespan of the cached server list is 30 seconds.

2. At the start of a new transaction, the client reads the cached server list to identify a member that has untapped capacity, and looks in the transport pool for an idle transport that is tied to the under-utilized member. (An idle transport is a transport that has no associated connection object.)
  - If an idle transport is available, the client associates the connection object with the transport.
  - If, after a user-configurable timeout, no idle transport is available in the transport pool and no new transport can be allocated because the transport pool has reached its limit, an error is returned to the application.
3. When the transaction runs, it accesses the member that is tied to the transport.

When the first SQL statement in a transaction runs, if the IBM Data Server Driver for JDBC and SQLJ receives a communication failure because the data server drops the connection or the `blockingReadConnectionTimeout` value was exceeded, the driver retries the SQL statement 10 times before it reports an error. On every retry, the driver closes the existing transport, obtains a new transport and then executes the transaction. During these retries, if the `maxRetriesForClientReroute` and `retryIntervalForClientReroute` properties are set, their values apply only to the process of obtaining a new transport during each retry.

4. When the transaction ends, the client verifies with the server that transport reuse is still allowed for the connection object.
5. If transport reuse is allowed, the server returns a list of SET statements for special registers that apply to the execution environment for the connection object.  
The client caches these statements, which it replays in order to reconstruct the execution environment when the connection object is associated with a new transport.
6. The connection object is then disassociated from the transport.
7. The client copy of the server list is refreshed when a new connection is made, or every 30 seconds.
8. When workload balancing is required for a new transaction, the client uses the same process to associate the connection object with a transport.

## Operation of automatic client reroute for connections from Java clients to DB2 for z/OS

Automatic client reroute support provides failover support when an IBM data server client loses connectivity to a member of a DB2 for z/OS Sysplex. Automatic client reroute enables the client to recover from a failure by attempting to reconnect to the database through any available member of the Sysplex.

Automatic client reroute is enabled by default when Sysplex workload balancing is enabled.

Client support for automatic client reroute is available in IBM data server clients that have a DB2 Connect license. The DB2 Connect server is not required to perform automatic client reroute.

Automatic client reroute for connections to DB2 for z/OS operates in the following way:

1. As part of the response to a COMMIT request from the client, the data server returns:
  - An indicator that specifies whether transports can be reused. Transports can be reused if there are no resources remaining, such as held cursors.
  - SET statements that the client can use to replay the connection state during transport reuse.
2. If the first SQL statement in a transaction fails, and transports can be reused:
  - No error is reported to the application.
  - The failing SQL statement is executed again.
  - The SET statements that are associated with the logical connection are replayed to restore the connection state.
3. If an SQL statement that is not the first SQL statement in a transaction fails, and transports can be reused:

- The transaction is rolled back.
  - The application is reconnected to the data server.
  - The SET statements that are associated with the logical connection are replayed to restore the connection state.
  - SQL error -30108 (for Java) or SQL30108N (for non-Java clients) is returned to the application to notify it of the rollback and successful reconnection. The application needs to include code to retry the failed transaction.
4. If an SQL statement that is not the first SQL statement in a transaction fails, and transports cannot be reused:
    - The logical connection is returned to its initial, default state.
    - SQL error -30081 (for Java) or SQL30081N (for non-Java clients) is returned to the application to notify it that reconnection was unsuccessful. The application needs to reconnect to the data server, reestablish the connection state, and retry the failed transaction.
  5. If connections to all members of the data sharing member list have been tried, and none have succeeded, a connection is tried using the URL that is associated with the data sharing group, to determine whether any members are now available.

## Operation of alternate group support

Alternate group support allows the IBM Data Server Driver for JDBC and SQLJ to move an application workload to an alternative data sharing group when the primary data sharing group is unavailable.

For alternate group support, the primary and alternative data sharing groups must use Dynamic virtual IP addressing (DVIPA).

You enable alternate group support by providing the addresses of alternative DB2 pureScale instances in the `alternateGroupServerName`, `alternateGroupPortNumber`, and `alternateGroupDatabaseName` Connection or DataSource properties, or the `db2.jcc.alternateGroupServerName`, `db2.jcc.alternateGroupPortNumber`, and `db2.jcc.alternateGroupDatabaseName` configuration properties. The Connection or DataSource property values override the configuration property values.

In addition, you can control whether seamless failover behavior is in effect for alternate group support by setting the `enableAlternateGroupSeamlessACR` Connection or DataSource property, or the `db2.jcc.enableAlternateGroupSeamlessACR` configuration property.

For alternate group support to work properly, the data in the primary group and alternate group must be the same.

After failover from the primary group to the alternate group, the value of the `databaseName` property remains the same.

Alternate group support operates in the following way:

- For the first connection of an application to a data sharing group:
  1. The IBM Data Server Driver for JDBC and SQLJ attempts to connect the application to the primary data sharing group.
  2. If the connection fails, the driver attempts to connect the application to the alternative data sharing group that is specified by the set of values in the `alternateGroupServerName`, `alternateGroupPortNumber`, and `alternateGroupDatabaseName` properties.

3. If a connection is not established, the driver returns SQL error -4499 to the application.
- For a subsequent connection after the application is connected to the primary data sharing group:
    1. The IBM Data Server Driver for JDBC and SQLJ attempts to reconnect the application to each of the available members of the primary data sharing group.
    2. If no members of the primary data sharing group are available on the first attempt, the driver retries the connection to the primary data sharing group, using the address that is specified by the set of values in the `serverName`, `portNumber`, and `databaseName` Connection or DataSource properties.
    3. If the connection to the primary group fails, the driver attempts to connect the application to the alternative data sharing group that is specified by the set of values in the `alternateGroupServerName`, `alternateGroupPortNumber`, and `alternateGroupDatabaseName` properties.
    4. If a connection is not established, the driver returns SQL error -4499 to the application.
  - For a subsequent connection after the application is connected to the alternative data sharing group:
    1. The IBM Data Server Driver for JDBC and SQLJ attempts to reconnect the application to each of the available members of the alternative data sharing group.
    2. If a connection is not established, the driver returns SQL error -4499 to the application.
  - For a connection to a primary data sharing group that is in a transaction:
    1. The IBM Data Server Driver for JDBC and SQLJ attempts to connect the application to the alternative data sharing group.
    2. If a connection is established, `enableAlternateSeamlessGroupACR` is set to true, and the transaction qualifies for seamless failover, the transaction is retried.
    3. If a connection is established, `enableAlternateSeamlessGroupACR` is set to true, and the transaction does not qualify for seamless failover, the driver returns SQL error -30108 to the application.
    4. If a connection is established, and `enableAlternateSeamlessGroupACR` is set to false, the driver returns SQL error -30108 to the application.
    5. If a connection is not established, the driver returns SQL error -4499 to the application.

## Examples

Suppose that two data sharing groups are defined: PG1 and AG1. Both use DVIPA network addressing. PG1 is the primary data sharing group, and AG1 is the alternative data sharing group for IBM Data Server Driver for JDBC and SQLJ alternate data sharing group support.

Suppose that the data sharing groups have the following server, port, and database values:

Data sharing group	Server, port, database values
PG1	host1, port1, dbname1
AG1	host2, port2, dbname2

Also suppose that the following property values are set:

Property	Value
serverName	host1
portNumber	port1
databaseName	dbname1
alternateGroupServerName	host2
alternateGroupPortNumber	port2
alternateGroupDatabaseName	dbname2
enableAlternateGroupSeamlessACR	true

The following steps demonstrate an alternate data sharing group scenario for a connection to PG1 that fails:

1. The driver attempts to connect the application to PG1, using host1:port1.
2. The connection fails.
3. The driver attempts to connect the application to AG1, using host2:port2.
4. The connection is successful.
5. The application continues to run.
6. All members of AG1 become unavailable, and the connection to AG1 fails.
7. The driver issues SQL error -4499.

The following steps demonstrate an alternate group scenario for a connection to PG1 that fails during a transaction:

1. The driver attempts to connect the application to PG1, using host1:port1.
2. The connection succeeds.
3. The application begins to perform work.
4. All members of PG1 go down.
5. The driver attempts to connect the application to AG1, using host2:port2.
6. The connection is successful.
7. The application meets the criteria for seamless failover, so the transaction is retried.
8. The retry fails.
9. The driver issues SQL error -30108 and rolls back work to the previous commit point.

## Application programming requirements for high availability for connections from Java clients to DB2 for z/OS servers

Failover for automatic client reroute can be seamless or non-seamless. If failover for connections to DB2 for z/OS is not seamless, you need to add code to account for the errors that are returned when failover occurs.

If failover is not seamless, and a connection is reestablished with the server, SQLCODE -30108 (SQL30108N) is returned to the application. All work that occurred within the current transaction is rolled back. In the application, you need to:

- Check the reason code that is returned with the -30108 error to determine whether special register settings on the failing data sharing member are carried over to the new (failover) data sharing member. Reset any special register values that are not current.
- Execute all SQL operations that occurred since the previous commit operation.

The following conditions must be satisfied for seamless failover to occur for direct connections to DB2 for z/OS:

- The application language is Java, CLI, or .NET.
- The connection is not in a transaction. That is, the failure occurs when the first SQL statement in the transaction is executed.
- The data server allows transport reuse at the end of the previous transaction. An exception to this condition is if transport reuse is not granted because the application was bound with KEEP DYNAMIC(YES).
- All global session data is closed or dropped.
- There are no open, held cursors.
- If the application uses CLI, the application cannot perform actions that require the driver to maintain a history of previously called APIs in order to replay the SQL statement. Examples of such actions are specifying data at execution time, performing compound SQL, or using array input.
- The application is not a stored procedure.
- The application is not running in a Federated environment.
- Two-phase commit is used, if transactions are dependent on the success of previous transactions. When a failure occurs during a commit operation, the client has no information about whether work was committed or rolled back at the server. If each transaction is dependent on the success of the previous transaction, use two-phase commit. Two-phase commit requires the use of XA support.



---

## Chapter 10. Java 2 Platform, Enterprise Edition

The Java 2 Platform, Enterprise Edition (J2EE), reduces the cost and complexity of developing multi-tier services.

In today's global business environment, organizations need to extend their reach, lower their costs, and lower their response times by providing services that are easily accessible to their customers, employees, suppliers, and other business partners. These services need to have the following characteristics:

- Highly available, to meet the requirements of global business environment
- Secure, to protect the privacy of the users and the integrity of the enterprise
- Reliable and scalable, so that business transactions are accurately and promptly processed

In most cases, these services are provided with the help of multi-tier applications with each tier serving a specific purpose.

J2EE achieves these benefits by defining a standard architecture that is delivered as the following elements:

- J2EE Application Model, a standard application model for developing multi-tier, thin-client services
- J2EE Platform, a standard platform for hosting J2EE applications
- J2EE Compatibility Test Suite for verifying that a J2EE platform product complies with the J2EE platform standard
- J2EE Reference Implementation for demonstrating the capabilities of J2EE, and for providing an operational definition of the J2EE platform

---

### Application components of Java 2 Platform, Enterprise Edition support

The Java 2 Platform, Enterprise Edition (J2EE) provides the runtime environment for hosting J2EE applications.

The runtime environment defines four application component types that a J2EE product must support:

- Application clients are Java programming language programs that are typically GUI programs that execute on a desktop computer. Application clients have access to all of the facilities of the J2EE middle tier.
- Applets are GUI components that typically execute in a web browser, but can execute in a variety of other applications or devices that support the applet programming model.
- Servlets, JavaServer Pages (JSPs), filters, and web event listeners typically execute in a web server and might respond to HTTP requests from web clients. Servlets, JSPs, and filters can be used to generate HTML pages that are an application's user interface. They can also be used to generate XML or other format data that is consumed by other application components. Servlets, pages created with the JSP technology, web filters, and web event listeners are referred to collectively in this specification as *web components*. Web applications are composed of web components and other data such as HTML pages.



- Enterprise JavaBeans (EJB) components execute in a managed environment that supports transactions. Enterprise beans typically contain the business logic for a J2EE application.

The application components listed above can be divided into three categories, based on how they can be deployed and managed:

- Components that are deployed, managed, and executed on a J2EE server.
- Components that are deployed, managed on a J2EE server, but are loaded to and executed on a client machine.
- Components whose deployment and management are not completely defined by this specification. Application clients can be under this category.

The runtime support for these components is provided by *containers*.

---

## Java 2 Platform, Enterprise Edition containers

A container provides a federated view of the underlying Java 2 Platform, Enterprise Edition (J2EE) APIs to the application components.

A typical J2EE product will provide a container for each application component type; application client container, applet container, web container, and enterprise bean container. The container tools also understand the file formats for packaging the application components for deployment.

The specification requires that these containers provide a Java-compatible runtime environment. This specification defines a set of standard services that each J2EE product must support. These standard services are:

- HTTP service
- HTTPS service
- Java transaction API
- Remote invocation method
- Java IDL
- JDBC API
- Java message service
- Java naming and directory interface
- JavaMail
- JavaBeans activation framework
- Java API for XML parsing
- Connector architecture
- Java authentication and authorization service

---

## Java 2 Platform, Enterprise Edition Server

One part of a Java 2 Platform, Enterprise Edition (J2EE) container is a server.

A J2EE Product Provider typically implements the J2EE server-side functionality. The J2EE client functionality is typically built on J2SE technology.

The IBM WebSphere Application Server is a J2EE-compliant server.

---

## Java 2 Platform, Enterprise Edition database requirements

Java 2 Platform, Enterprise Edition requires a data server to store business data. The data server must be accessible through the JDBC API.

The database is accessible from web components, enterprise beans, and application client components. The database need not be accessible from applets.

---

## Java Naming and Directory Interface (JNDI)

JNDI enables Java platform-based applications to access multiple naming and directory services.

It is a part of the Java Enterprise application programming interface (API) set. JNDI makes it possible for developers to create portable applications that are enabled for a number of different naming and directory services, including: file systems; directory services such as Lightweight Directory Access Protocol (LDAP) and Novell Directory Services, and distributed object systems such as the Common Object Request Broker Architecture (CORBA), Java Remote Method Invocation (RMI), and Enterprise JavaBeans (EJB).

The JNDI API has two parts: an application-level interface used by the application components to access naming and directory services and a service provider interface to attach a provider of a naming and directory service.

---

## Java transaction management

Java 2 Platform, Enterprise Edition (J2EE) simplifies application programming for distributed transaction management.

J2EE includes support for distributed transactions through two specifications, Java Transaction API (JTA) and Java Transaction Service (JTS). JTA is a high-level, implementation-independent, protocol-independent API that allows applications and application servers to access transactions. In addition, the JTA is always enabled.

The IBM Data Server Driver for JDBC and SQLJ implements the JTA and JTS specifications.

For IBM Data Server Driver for JDBC and SQLJ type 4 connectivity distributed transactions are supported to DB2 Database for Linux, UNIX, and Windows, DB2 for z/OS, and DB2 for i servers.

JTA specifies standard Java interfaces between a transaction manager and the parties involved in a distributed transaction system: the resource manager, the application server, and the transactional applications.

JTS specifies the implementation of a Transaction Manager which supports JTA and implements the Java mapping of the OMG Object Transaction Service (OTS) 1.1 specification at the level below the API. JTS propagates transactions using IIOP.

JTA and JTS allow application J2EE servers to take the burden of transaction management off of the component developer. Developers can define the transactional properties of EJB technology based components during design or deployment using declarative statements in the deployment descriptor. The application server takes over the transaction management responsibilities.

In the DB2 and WebSphere Application Server environment, WebSphere Application Server assumes the role of transaction manager, and DB2 acts as a resource manager. WebSphere Application Server implements JTS and part of JTA,

and the JDBC drivers also implement part of JTA so that WebSphere Application Server and DB2 can provide coordinated distributed transactions.

It is not necessary to configure DB2 to be JTA-enabled in the WebSphere Application Server environment because the JDBC drivers automatically detect this environment.

The IBM Data Server Driver for JDBC and SQLJ provides these two DataSource classes:

- `com.ibm.db2.jcc.DB2ConnectionPoolDataSource`
- `com.ibm.db2.jcc.DB2XADataSource`

WebSphere Application Server provides pooled connections to databases. If the application will be involved in a distributed transaction, the `com.ibm.db2.jdbc.DB2XADataSource` class should be used when defining DB2 data sources within the WebSphere Application Server.

For the detail information about how to configure the WebSphere Application Server with DB2, refer to WebSphere Application Server InfoCenter at:

<http://www.ibm.com/software/webservers/appserv/library.html>

## Example of a distributed transaction that uses JTA methods

Distributed transactions typically involve multiple connections to the same data source or different data sources, which can include data sources from different manufacturers.

The best way to demonstrate distributed transactions is to contrast them with local transactions. With local transactions, a JDBC application makes changes to a database permanent and indicates the end of a unit of work in one of the following ways:

- By calling the `Connection.commit` or `Connection.rollback` methods after executing one or more SQL statements
- By calling the `Connection.setAutoCommit(true)` method at the beginning of the application to commit changes after every SQL statement

Figure 48 outlines code that executes local transactions.

```
con1.setAutoCommit(false); // Set autocommit off
// execute some SQL
...
con1.commit();             // Commit the transaction
// execute some more SQL
...
con1.rollback();           // Roll back the transaction
con1.setAutoCommit(true); // Enable commit after every SQL statement
...
// Execute some more SQL, which is automatically committed after
// every SQL statement.
```

*Figure 48. Example of a local transaction*

In contrast, applications that participate in distributed transactions cannot call the `Connection.commit`, `Connection.rollback`, or `Connection.setAutoCommit(true)` methods within the distributed transaction. With distributed transactions, the `Connection.commit` or `Connection.rollback` methods do not indicate transaction boundaries. Instead, your applications let the application server manage transaction boundaries.

Figure 49 demonstrates an application that uses distributed transactions. While the code in the example is running, the application server is also executing other EJBs that are part of this same distributed transaction. When all EJBs have called `utx.commit()`, the entire distributed transaction is committed by the application server. If any of the EJBs are unsuccessful, the application server rolls back all the work done by all EJBs that are associated with the distributed transaction.

```

javax.transaction.UserTransaction utx;
// Use the begin method on a UserTransaction object to indicate
// the beginning of a distributed transaction.
utx.begin();
...
// Execute some SQL with one Connection object.
// Do not call Connection methods commit or rollback.
...
// Use the commit method on the UserTransaction object to
// drive all transaction branches to commit and indicate
// the end of the distributed transaction.

utx.commit();
...

```

*Figure 49. Example of a distributed transaction under an application server*

Figure 50 illustrates a program that uses JTA methods to execute a distributed transaction. This program acts as the transaction manager and a transactional application. Two connections to two different data sources do SQL work under a single distributed transaction.

*Figure 50. Example of a distributed transaction that uses the JTA*

```

class XASample
{
    javax.sql.XADataSource xaDS1;
    javax.sql.XADataSource xaDS2;
    javax.sql.XAConnection xaconn1;
    javax.sql.XAConnection xaconn2;
    javax.transaction.xa.XAResource xares1;
    javax.transaction.xa.XAResource xares2;
    java.sql.Connection conn1;
    java.sql.Connection conn2;

    public static void main (String args []) throws java.sql.SQLException
    {
        XASample xat = new XASample();
        xat.runThis(args);
    }
    // As the transaction manager, this program supplies the global
    // transaction ID and the branch qualifier. The global
    // transaction ID and the branch qualifier must not be
    // equal to each other, and the combination must be unique for
    // this transaction manager.
    public void runThis(String[] args)
    {
        byte[] gtrid = new byte[] { 0x44, 0x11, 0x55, 0x66 };
        byte[] bqqual = new byte[] { 0x00, 0x22, 0x00 };
        int rc1 = 0;
        int rc2 = 0;

        try
        {
            javax.naming.InitialContext context = new javax.naming.InitialContext();

```

```

/*
 * Note that javax.sql.XADataSource is used instead of a specific
 * driver implementation such as com.ibm.db2.jcc.DB2XADataSource.
 */
xaDS1 = (javax.sql.XADataSource)context.lookup("checkingAccounts");
xaDS2 = (javax.sql.XADataSource)context.lookup("savingsAccounts");

// The XADataSource contains the user ID and password.
// Get the XAConnection object from each XADataSource
xaconn1 = xaDS1.getXAConnection();
xaconn2 = xaDS2.getXAConnection();

// Get the java.sql.Connection object from each XAConnection
conn1 = xaconn1.getConnection();
conn2 = xaconn2.getConnection();

// Get the XAResource object from each XAConnection
xares1 = xaconn1.getXAResource();
xares2 = xaconn2.getXAResource();
// Create the Xid object for this distributed transaction.
// This example uses the com.ibm.db2.jcc.DB2Xid implementation
// of the Xid interface. This Xid can be used with any JDBC driver
// that supports JTA.
javax.transaction.xa.Xid xid1 =
    new com.ibm.db2.jcc.DB2Xid(100, gtrid, bqual);

// Start the distributed transaction on the two connections.
// The two connections do NOT need to be started and ended together.
// They might be done in different threads, along with their SQL operations.
xares1.start(xid1, javax.transaction.xa.XAResource.TMNOFLAGS);
xares2.start(xid1, javax.transaction.xa.XAResource.TMNOFLAGS);
...
// Do the SQL operations on connection 1.
// Do the SQL operations on connection 2.
...
// Now end the distributed transaction on the two connections.
xares1.end(xid1, javax.transaction.xa.XAResource.TMSUCCESS);
xares2.end(xid1, javax.transaction.xa.XAResource.TMSUCCESS);

// If connection 2 work had been done in another thread,
// a thread.join() call would be needed here to wait until the
// connection 2 work is done.

try
{ // Now prepare both branches of the distributed transaction.
  // Both branches must prepare successfully before changes
  // can be committed.
  // If the distributed transaction fails, an XAException is thrown.
  rc1 = xares1.prepare(xid1);
  if(rc1 == javax.transaction.xa.XAResource.XA_OK)
  { // Prepare was successful. Prepare the second connection.
    rc2 = xares2.prepare(xid1);
    if(rc2 == javax.transaction.xa.XAResource.XA_OK)
    { // Both connections prepared successfully and neither was read-only.
      xares1.commit(xid1, false);
      xares2.commit(xid1, false);
    }
    else if(rc2 == javax.transaction.xa.XAException.XA_RDONLY)
    { // The second connection is read-only, so just commit the
      // first connection.
      xares1.commit(xid1, false);
    }
  }
}
else if(rc1 == javax.transaction.xa.XAException.XA_RDONLY)
{ // SQL for the first connection is read-only (such as a SELECT).
  // The prepare committed it. Prepare the second connection.
  rc2 = xares2.prepare(xid1);

```

```

        if(rc2 == javax.transaction.xa.XAResource.XA_OK)
        { // The first connection is read-only but the second is not.
          // Commit the second connection.
          xares2.commit(xid1, false);
        }
        else if(rc2 == javax.transaction.xa.XAException.XA_RDONLY)
        { // Both connections are read-only, and both already committed,
          // so there is nothing more to do.
        }
      }
    }
  } catch (javax.transaction.xa.XAException xae)
  { // Distributed transaction failed, so roll it back.
    // Report XAException on prepare/commit.
    System.out.println("Distributed transaction prepare/commit failed. " +
      "Rolling it back.");
    System.out.println("XAException error code = " + xae.errorCode);
    System.out.println("XAException message = " + xae.getMessage());
    xae.printStackTrace();
    try
    {
      xares1.rollback(xid1);
    }
    catch (javax.transaction.xa.XAException xae1)
    { // Report failure of rollback.
      System.out.println("distributed Transaction rollback xares1 failed");
      System.out.println("XAException error code = " + xae1.errorCode);
      System.out.println("XAException message = " + xae1.getMessage());
    }
    try
    {
      xares2.rollback(xid1);
    }
    catch (javax.transaction.xa.XAException xae2)
    { // Report failure of rollback.
      System.out.println("distributed Transaction rollback xares2 failed");
      System.out.println("XAException error code = " + xae2.errorCode);
      System.out.println("XAException message = " + xae2.getMessage());
    }
  }
}

try
{
  conn1.close();
  xaconn1.close();
}
catch (Exception e)
{
  System.out.println("Failed to close connection 1: " + e.toString());
  e.printStackTrace();
}
try
{
  conn2.close();
  xaconn2.close();
}
catch (Exception e)
{
  System.out.println("Failed to close connection 2: " + e.toString());
  e.printStackTrace();
}
}
catch (java.sql.SQLException sqe)
{
  System.out.println("SQLException caught: " + sqe.getMessage());
  sqe.printStackTrace();
}
catch (javax.transaction.xa.XAException xae)

```

```

        {
            System.out.println("XA error is " + xae.getMessage());
            xae.printStackTrace();
        }
        catch (javax.naming.NamingException nme)
        {
            System.out.println(" Naming Exception: " + nme.getMessage());
        }
    }
}

```

**Recommendation:** For better performance, complete a distributed transaction before you start another distributed or local transaction.

## Setting the transaction timeout value for an XAResource instance

Use the `XAResource.setTransactionTimeout` method to reduce occurrences of deadlocks in a DB2 database that is the target of distributed transactions.

### About this task

A distributed transaction to DB2 Database for Linux, UNIX, and Windows that ends, but cannot be prepared, is not an indoubt transaction. Therefore, the transaction manager cannot recover the transaction, and the DB2 resource manager does not put the transaction in its list of indoubt transactions. The DB2 resource manager does not roll back the transaction immediately, but waits until all connections to the database are released. During this period of inactivity, the transaction continues to hold locks on the database. If the transaction manager does not disconnect all connections to the database to allow rollback, the ended transaction continues to lock database records. If another application attempts to access those locked records, a deadlock can occur.

In a Java application that uses distributed transactions and IBM Data Server Driver for JDBC and SQLJ type 4 connectivity, you can prevent a transaction from holding locks on a database indefinitely by calling the `XAResource.setTransactionTimeout` method to set a timeout value on transactions. To do that, follow these steps:

### Procedure

1. On the DB2 Database for Linux, UNIX, and Windows instance, issue this command to cause the instance to check for timeout values.

```
DB2 UPDATE DBM CFG USING RESYNC_INTERVAL seconds
```

*seconds* needs to be less than the minimum timeout value that you set for a transaction.

2. In your application, after you create an `XAResource` object, call the `XAResource.setTransactionTimeout` method to set the timeout value.

You can check the current timeout value by calling `XAResource.getTransactionTimeout`.

---

## Enterprise Java Beans

The Enterprise Java beans architecture is a component architecture for the development and deployment of component-based distributed business applications.



Applications that are written using the Enterprise Java beans architecture can be written once, and then deployed on any server platform that supports the Enterprise Java beans specification. Java 2 Platform, Enterprise Edition (J2EE) applications implement server-side business components using Enterprise Java beans (EJBs) that include session beans and entity beans.

Session beans represent business services and are not shared between users. Entity beans are multi-user, distributed transactional objects that represent persistent data. The transactional boundaries of a EJB application can be set by specifying either container-managed or bean-managed transactions.

The sample program `AccessEmployee.ear` uses Enterprise Java beans to implement a J2EE application to access a data source. You can find this sample in the `SQLLIB/samples/websphere` directory.

The EJB sample application provides two business services. One service allows the user to access information about an employee (which is stored in the `EMPLOYEE` table of the **sample** database) through that employee's employee number. The other service allows the user to retrieve a list of the employee numbers, so that the user can obtain an employee number to use for querying employee data.

The following sample uses EJBs to implement a J2EE application to access a data source. The sample utilizes the Model-View-Controller (MVC) architecture, which is a commonly-used GUI architecture. The JSP is used to implement the view (the presentation component). A servlet acts as the controller in the sample. It controls the workflow and delegates the user's request to the model, which is implemented using EJBs. The model component of the sample consists of two EJBs, one session bean and one entity bean. The container-managed persistence (CMP) bean, `Employee`, represents the distributed transactional objects that represent the persistent data in the `EMPLOYEE` table of the sample database. The term container-managed persistence means that the EJB container handles all database access required by the entity bean. The bean's code contains no database access (SQL) calls. As a result, the bean's code is not tied to a specific persistent storage mechanism (database). The session bean, `AccessEmployee`, acts as the Façade of the entity bean and provides provide a uniform client access strategy. This Façade design reduces the network traffic between the EJB client and the entity bean and is more efficient in distributed transactions than if the EJB client accesses the entity bean directly. Access to the database server can be provided from the session bean or entity bean. The two services of the sample application demonstrate both approaches to accessing the database server. In the first service, the entity bean is used:

```
//=====
// This method returns an employee's information by
// interacting with the entity bean located by the
// provided employee number
public EmployeeInfo getEmployeeInfo(String empNo)
throws java.rmi.RemoteException
}
Employee employee = null;
try
}
employee = employeeHome.findByPrimaryKey(new EmployeeKey(empNo));
EmployeeInfo empInfo = new EmployeeInfo(empNo);
//set the employee's information to the dependent value object
empInfo.setEmpno(employee.getEmpno());
empInfo.setFirstName (employee.getFirstName());
empInfo.setMidInit(employee.getMidInit());
empInfo.setLastName(employee.getLastName());
empInfo.setWorkDept(employee.getWorkDept());
```



```

empInfo.setPhoneNo(employee.getPhoneNo());
empInfo.setHireDate(employee.getHireDate());
empInfo.setJob(employee.getJob());
empInfo.setEdLevel(employee.getEdLevel());
empInfo.setSex(employee.getSex());
empInfo.setBirthDate(employee.getBirthDate());
empInfo.setSalary(employee.getSalary());
empInfo.setBonus(employee.getBonus());
empInfo.setComm(employee.getComm());
return empInfo;
}
catch (java.rmi.RemoteException rex)
{
.....

```

In the second service, which displays employee numbers, the session bean, `AccessEmployee`, directly accesses the database table.

```

/=====
* Get the employee number list.
* @return Collection
*/
public Collection getEmpNoList()
{
    ResultSet rs = null;
    PreparedStatement ps = null;
    Vector list = new Vector();
    DataSource ds = null;
    Connection con = null;
    try
    {
        ds = getDataSource();
        con = ds.getConnection();
        String schema = getEnvProps(DBSchema);
        String query = "Select EMPNO from " + schema + ".EMPLOYEE";
        ps = con.prepareStatement(query);
        ps.executeQuery();
        rs = ps.getResultSet();
        EmployeeKey pk;
        while (rs.next())
        {
            pk = new EmployeeKey();
            pk.employeeId = rs.getString(1);
            list.addElement(pk.employeeId);
        }
        rs.close();
    }
    return list;
}

```

---

## Chapter 11. JDBC and SQLJ connection pooling support

*Connection pooling* is part of JDBC DataSource support, and is supported by the IBM Data Server Driver for JDBC and SQLJ.

The IBM Data Server Driver for JDBC and SQLJ provides a factory of pooled connections that are used by WebSphere Application Server or other application servers. The application server actually does the pooling. Connection pooling is completely transparent to a JDBC or SQLJ application.

Connection pooling is a framework for caching physical data source connections, which are equivalent to DB2 threads. When JDBC reuses physical data source connections, the expensive operations that are required for the creation and subsequent closing of `java.sql.Connection` objects are minimized.

Without connection pooling, each `java.sql.Connection` object represents a physical connection to the data source. When the application establishes a connection to a data source, DB2 creates a new physical connection to the data source. When the application calls the `java.sql.Connection.close` method, DB2 terminates the physical connection to the data source.

In contrast, with connection pooling, a `java.sql.Connection` object is a temporary, logical representation of a physical data source connection. The physical data source connection can be serially reused by logical `java.sql.Connection` instances. The application can use the logical `java.sql.Connection` object in exactly the same manner as it uses a `java.sql.Connection` object when there is no connection pooling support.

With connection pooling, when a JDBC application invokes the `DataSource.getConnection` method, the data source determines whether an appropriate physical connection exists. If an appropriate physical connection exists, the data source returns a `java.sql.Connection` instance to the application. When the JDBC application invokes the `java.sql.Connection.close` method, JDBC does not close the physical data source connection. Instead, JDBC closes only JDBC resources, such as `Statement` or `ResultSet` objects. The data source returns the physical connection to the connection pool for reuse.

Connection pooling can be *homogeneous* or *heterogeneous*.

With homogeneous pooling, all `Connection` objects that come from a connection pool should have the same properties. The first logical `Connection` that is created with the `DataSource` has the properties that were defined for the `DataSource`. However, an application can change those properties. When a `Connection` is returned to the connection pool, an application server or a pooling module should reset the properties to their original values. However, an application server or pooling module might not reset the changed properties. The JDBC driver does not modify the properties. Therefore, depending on the application server or pool module design, a reused logical `Connection` might have the same properties as those that are defined for the `DataSource` or different properties.

With heterogeneous pooling, `Connection` objects with different properties can share the same connection pool.



---

## Chapter 12. IBM Data Server Driver for JDBC and SQLJ statement caching

The IBM Data Server Driver for JDBC and SQLJ can use an internal statement cache to improve the performance of Java applications by caching and pooling prepared statements.

Internal statement caching is available for connections that use IBM Data Server Driver for JDBC and SQLJ type 4 connectivity, or for connections that use IBM Data Server Driver for JDBC and SQLJ type 2 connectivity on DB2 for z/OS.

You enable internal statement caching in any of the following ways:

- By setting one of the following properties to a positive value:
  - `com.ibm.db2.jcc.DB2ConnectionPoolDataSource.maxStatements`, for objects that are created using the `javax.sql.ConnectionPoolDataSource` interface.
  - `com.ibm.db2.jcc.DB2XADataSource.maxStatements`, for objects that are created using the `javax.sql.XADataSource` interface.
  - `com.ibm.db2.jcc.DB2SimpleDataSource.maxStatements`, for objects that are created using the `com.ibm.db2.jcc.DB2SimpleDataSource` interfaces.
- By setting the `maxStatements` property in a URL, and passing the URL to the `DriverManager.getConnection` method.

When internal statement caching is enabled, the IBM Data Server Driver for JDBC and SQLJ can cache `PreparedStatement` objects, `CallableStatement` objects, and JDBC resources that are used by SQLJ statements when those objects or resources are logically closed. When you explicitly or implicitly invoke the `close` method on a statement, you logically close the statement.

Reuse of a previously cached statement is transparent to applications. The statement cache exists for the life of an open connection. When the connection is closed, the driver deletes the statement cache and closes all pooled statements.

A logically open statement becomes ineligible for caching under either of the following circumstances:

- An exception occurs on the statement.
- JDBC 4.0 method `Statement.setPoolable(false)` is called.

When the IBM Data Server Driver for JDBC and SQLJ attempts to cache a statement, and the internal statement cache is full, the driver purges the least recently used cached statement, and inserts the new statement.

The internal statement cache is purged under the following conditions:

- A SET statement is issued that affects target objects of the SQL statement.
- A SET statement is executed that the IBM Data Server Driver for JDBC and SQLJ does not recognize.
- The IBM Data Server Driver for JDBC and SQLJ detects that a property that modifies target objects of the SQL statement was modified during connection reuse. `currentSchema` is an example of a property that modifies target objects of an SQL statement.

In a Java program, you can test whether the internal statement cache is enabled by issuing the `DatabaseMetaData.supportsStatementPooling` method. The method returns `true` if the internal statement cache is enabled.

The IBM Data Server Driver for JDBC and SQLJ does not check whether the definitions of target objects of statements in the internal statement cache have changed. If you execute SQL data definition language statements in an application, you need to disable internal statement caching for that application.

The internal statement cache requires extra memory. If memory becomes constrained, you can increase the JVM size, or decrease the value of `maxStatements`.

---

## Chapter 13. JDBC and SQLJ reference information

The IBM implementations of JDBC and SQLJ provide a number of application programming interfaces, properties, and commands for developing JDBC and SQLJ applications.

---

### Data types that map to database data types in Java applications

To write efficient JDBC and SQLJ programs, you need to use the best mappings between Java data types and table column data types.

The following tables summarize the mappings of Java data types to JDBC and database data types for a DB2 Database for Linux, UNIX, and Windows, DB2 for z/OS, or IBM Informix system.

#### Data types for updating table columns

The following table summarizes the mappings of Java data types to database data types for `PreparedStatement.setXXX` or `ResultSet.updateXXX` methods in JDBC programs, and for input host expressions in SQLJ programs. When more than one Java data type is listed, the first data type is the recommended data type.

Table 50. Mappings of Java data types to database server data types for updating database tables

Java data type	Database data type
short, java.lang.Short	SMALLINT
boolean <sup>1</sup> , byte <sup>1</sup> , java.lang.Boolean, java.lang.Byte	SMALLINT
int, java.lang.Integer	INTEGER
long, java.lang.Long	BIGINT <sup>12</sup>
java.math.BigInteger	BIGINT <sup>11</sup>
java.math.BigDecimal	CHAR( <i>n</i> ) <sup>11,5</sup>
float, java.lang.Float	REAL
double, java.lang.Double	DOUBLE
java.math.BigDecimal	DECIMAL( <i>p,s</i> ) <sup>2</sup>
java.math.BigDecimal	DECFLOAT( <i>n</i> ) <sup>3,4</sup>
java.lang.String	CHAR( <i>n</i> ) <sup>5</sup>
java.lang.String	GRAPHIC( <i>m</i> ) <sup>6</sup>
java.lang.String	VARCHAR( <i>n</i> ) <sup>7</sup>
java.lang.String	VARGRAPHIC( <i>m</i> ) <sup>8</sup>
java.lang.String	CLOB <sup>9</sup>
java.lang.String	XML <sup>10</sup>
byte[]	CHAR( <i>n</i> ) FOR BIT DATA <sup>5</sup>
byte[]	VARCHAR( <i>n</i> ) FOR BIT DATA <sup>7</sup>
byte[]	BINARY( <i>n</i> ) <sup>5, 13</sup>
byte[]	VARBINARY( <i>n</i> ) <sup>7, 13</sup>
byte[]	BLOB <sup>9</sup>

Table 50. Mappings of Java data types to database server data types for updating database tables (continued)

Java data type	Database data type
byte[]	ROWID
byte[]	XML <sup>10</sup>
java.sql.Blob	BLOB
java.sql.Blob	XML <sup>10</sup>
java.sql.Clob	CLOB
java.sql.Clob	DBCLOB <sup>9</sup>
java.sql.Clob	XML <sup>10</sup>
java.sql.Date	DATE
java.sql.Time	TIME
java.sql.Timestamp	TIMESTAMP, TIMESTAMP( <i>p</i> ), TIMESTAMP WITH TIME ZONE, TIMESTAMP( <i>p</i> ) WITH TIME ZONE <sup>14,15</sup>
java.io.ByteArrayInputStream	BLOB
java.io.StringReader	CLOB
java.io.ByteArrayInputStream	CLOB
java.io.InputStream	XML <sup>10</sup>
com.ibm.db2.jcc.DB2RowID (deprecated)	ROWID
java.sql.RowId	ROWID
com.ibm.db2.jcc.DB2Xml (deprecated)	XML <sup>10</sup>
java.sql.SQLXML	XML <sup>10</sup>
java.util.Date	CHAR( <i>n</i> ) <sup>11,5</sup>
java.util.Date	VARCHAR( <i>n</i> ) <sup>11,5</sup>
java.util.Date	DATE <sup>11</sup>
java.util.Date	TIME <sup>11</sup>
java.util.Date	TIMESTAMP, TIMESTAMP( <i>p</i> ), TIMESTAMP WITH TIME ZONE, TIMESTAMP( <i>p</i> ) WITH TIME ZONE <sup>11,14,15</sup>
java.util.Calendar	CHAR( <i>n</i> ) <sup>11,5</sup>
java.util.Calendar	VARCHAR( <i>n</i> ) <sup>11,5</sup>
java.util.Calendar	DATE <sup>11</sup>
java.util.Calendar	TIME <sup>11</sup>
java.util.Calendar	TIMESTAMP, TIMESTAMP( <i>p</i> ), TIMESTAMP WITH TIME ZONE, TIMESTAMP( <i>p</i> ) WITH TIME ZONE <sup>11,14,15</sup>

Table 50. Mappings of Java data types to database server data types for updating database tables (continued)

Java data type	Database data type
<b>Notes:</b>	
1.	For column updates, the data server has no exact equivalent for the Java boolean or byte data types, but the best fit is SMALLINT.
2.	$p$ is the decimal precision and $s$ is the scale of the table column. You should design financial applications so that java.math.BigDecimal columns map to DECIMAL columns. If you know the precision and scale of a DECIMAL column, updating data in the DECIMAL column with data in a java.math.BigDecimal variable results in better performance than using other combinations of data types.
3.	$n=16$ or $n=34$ .
4.	DECFLOAT is valid for connections to DB2 Version 9.1 for z/OS, DB2 V9.5 for Linux, UNIX, and Windows, or DB2 for i V6R1, or later database servers. Use of DECFLOAT requires the SDK for Java Version 5 (1.5) or later.
5.	$n \leq 254$ .
6.	$m \leq 127$ .
7.	$n \leq 32672$ .
8.	$m \leq 16336$ .
9.	This mapping is valid only if the database server can determine the data type of the column.
10.	XML is valid for connections to DB2 Version 9.1 for z/OS or later database servers or DB2 V9.1 for Linux, UNIX, and Windows or later database servers.
11.	This mapping is valid only for IBM Data Server Driver for JDBC and SQLJ version 4.13 or later.
12.	BIGINT is valid for connections to DB2 Version 9.1 for z/OS or later database servers, DB2 V9.1 for Linux, UNIX, and Windows or later database servers, and all supported DB2 for i database servers.
13.	BINARY and VARBINARY are valid for connections to DB2 Version 9.1 for z/OS or later database servers or DB2 for i5/OS® V5R3 and later database servers.
14.	$p$ indicates the timestamp precision, which is the number of digits in the fractional part of the timestamp. $0 < p \leq 12$ . The default is 6. TIMESTAMP( $p$ ) is supported for connections to DB2 Database for Linux, UNIX, and Windows V9.7 and later and DB2 for z/OS V10 and later only.
15.	The WITH TIME ZONE clause is supported for connections to DB2 for z/OS V10 and later only.

## Data types for retrieval from table columns

The following table summarizes the mappings of DB2 or IBM Informix data types to Java data types for ResultSet.getXXX methods in JDBC programs, and for iterators in SQLJ programs. This table does not list Java numeric wrapper object types, which are retrieved using ResultSet.getObject.

Table 51. Mappings of database server data types to Java data types for retrieving data from database server tables

SQL data type	Recommended Java data type or Java object type	Other supported Java data types
SMALLINT	short	byte, int, long, float, double, java.math.BigDecimal, boolean, java.lang.String
INTEGER	int	short, byte, long, float, double, java.math.BigDecimal, boolean, java.lang.String
BIGINT <sup>5</sup>	long	int, short, byte, float, double, java.math.BigDecimal, boolean, java.lang.String
DECIMAL( $p,s$ ) or NUMERIC( $p,s$ )	java.math.BigDecimal	long, int, short, byte, float, double, boolean, java.lang.String



Table 51. Mappings of database server data types to Java data types for retrieving data from database server tables (continued)

SQL data type	Recommended Java data type or Java object type	Other supported Java data types
DECFLOAT( <i>n</i> ) <sup>1,2</sup>	java.math.BigDecimal	long, int, short, byte, float, double, java.math.BigDecimal, boolean, java.lang.String
REAL	float	long, int, short, byte, double, java.math.BigDecimal, boolean, java.lang.String
DOUBLE	double	long, int, short, byte, float, java.math.BigDecimal, boolean, java.lang.String
CHAR( <i>n</i> )	java.lang.String	long, int, short, byte, float, double, java.math.BigDecimal, boolean, java.sql.Date, java.sql.Time, java.sql.Timestamp, java.io.InputStream, java.io.Reader
VARCHAR( <i>n</i> )	java.lang.String	long, int, short, byte, float, double, java.math.BigDecimal, boolean, java.sql.Date, java.sql.Time, java.sql.Timestamp, java.io.InputStream, java.io.Reader
CHAR( <i>n</i> ) FOR BIT DATA	byte[]	java.lang.String, java.io.InputStream, java.io.Reader
VARCHAR( <i>n</i> ) FOR BIT DATA	byte[]	java.lang.String, java.io.InputStream, java.io.Reader
BINARY( <i>n</i> ) <sup>6</sup>	byte[]	None
VARBINARY( <i>n</i> ) <sup>6</sup>	byte[]	None
GRAPHIC( <i>m</i> )	java.lang.String	long, int, short, byte, float, double, java.math.BigDecimal, boolean, java.sql.Date, java.sql.Time, java.sql.Timestamp, java.io.InputStream, java.io.Reader
VARGRAPHIC( <i>m</i> )	java.lang.String	long, int, short, byte, float, double, java.math.BigDecimal, boolean, java.sql.Date, java.sql.Time, java.sql.Timestamp, java.io.InputStream, java.io.Reader
CLOB( <i>n</i> )	java.sql.Clob	java.lang.String
BLOB( <i>n</i> )	java.sql.Blob	byte[] <sup>3</sup>
DBCLOB( <i>m</i> )	No exact equivalent. Use java.sql.Clob.	
ROWID	java.sql.RowId	byte[], com.ibm.db2.jcc.DB2RowID (deprecated)
XML <sup>4</sup>	java.sql.SQLXML	byte[], java.lang.String, java.io.InputStream, java.io.Reader
DATE	java.sql.Date	java.sql.String, java.sql.Timestamp
TIME	java.sql.Time	java.sql.String, java.sql.Timestamp

Table 51. Mappings of database server data types to Java data types for retrieving data from database server tables (continued)

SQL data type	Recommended Java data type or Java object type	Other supported Java data types
TIMESTAMP, TIMESTAMP( <i>p</i> ), TIMESTAMP WITH TIME ZONE, TIMESTAMP( <i>p</i> ) WITH TIME ZONE <sup>7,8</sup>	java.sql.Timestamp	java.sql.String, java.sql.Date, java.sql.Time, java.sql.Timestamp

**Notes:**

1.  $n=16$  or  $n=34$ .
2. DECFLOAT is valid for connections to DB2 Version 9.1 for z/OS, DB2 V9.5 for Linux, UNIX, and Windows, or DB2 for i V6R1, or later database servers. Use of DECFLOAT requires the SDK for Java Version 5 (1.5) or later.
3. This mapping is valid only if the database server can determine the data type of the column.
4. XML is valid for connections to DB2 Version 9.1 for z/OS or later database servers or DB2 V9.1 for Linux, UNIX, and Windows or later database servers.
5. BIGINT is valid for connections to DB2 Version 9.1 for z/OS or later database servers, DB2 V9.1 for Linux, UNIX, and Windows or later database servers, and all supported DB2 for i database servers.
6. BINARY and VARBINARY are valid for connections to DB2 Version 9.1 for z/OS or later database servers or DB2 for i5/OS V5R3 or later database servers.
7.  $p$  indicates the timestamp precision, which is the number of digits in the fractional part of the timestamp.  $0 \leq p \leq 12$ . The default is 6. TIMESTAMP( $p$ ) is supported for connections to DB2 Database for Linux, UNIX, and Windows V9.7 and later and DB2 for z/OS V10 and later only.
8. The WITH TIME ZONE clause is supported for connections to DB2 for z/OS V10 and later only.

## Data types for calling stored procedures and user-defined functions

The following table summarizes mappings of Java data types to JDBC data types and DB2 or IBM Informix data types for calling user-defined function and stored procedure parameters. The mappings of Java data types to JDBC data types are for CallableStatement.registerOutParameter methods in JDBC programs. The mappings of Java data types to database server data types are for parameters in stored procedure or user-defined function invocations.

If more than one Java data type is listed in the following table, the first data type is the **recommended** data type.

Table 52. Mappings of Java, JDBC, and SQL data types for calling stored procedures and user-defined functions

Java data type	JDBC data type	SQL data type
boolean <sup>3</sup> , java.lang.Boolean	BOOLEAN	BOOLEAN <sup>1,2</sup>
boolean <sup>3</sup> , java.lang.Boolean	BIT	SMALLINT
byte <sup>3</sup> , java.lang.Byte	TINYINT	SMALLINT
short, java.lang.Short	SMALLINT	SMALLINT
int, java.lang.Integer	INTEGER	INTEGER
long, java.lang.Long	BIGINT	BIGINT <sup>7</sup>
float, java.lang.Float	REAL	REAL
float, java.lang.Float	FLOAT	REAL
double, java.lang.Double	DOUBLE	DOUBLE
java.math.BigDecimal	NUMERIC	DECIMAL
java.math.BigDecimal	DECIMAL	DECIMAL

Table 52. Mappings of Java, JDBC, and SQL data types for calling stored procedures and user-defined functions (continued)

Java data type	JDBC data type	SQL data type
java.math.BigDecimal	java.types.OTHER	DECFLOAT $n^4$
java.math.BigDecimal	com.ibm.db2.jcc.DB2Types.DECFLOAT	DECFLOAT $n^4$
java.lang.String	CHAR	CHAR
java.lang.String	CHAR	GRAPHIC
java.lang.String	VARCHAR	VARCHAR
java.lang.String	VARCHAR	VARGRAPHIC
java.lang.String	LONGVARCHAR	VARCHAR
java.lang.String	VARCHAR	CLOB
java.lang.String	LONGVARCHAR	CLOB
java.lang.String	CLOB	CLOB
byte[]	BINARY	CHAR FOR BIT DATA
byte[]	VARBINARY	VARCHAR FOR BIT DATA
byte[]	BINARY	BINARY <sup>6</sup>
byte[]	VARBINARY	VARBINARY <sup>6</sup>
byte[]	LONGVARBINARY	VARCHAR FOR BIT DATA
byte[]	VARBINARY	BLOB <sup>5</sup>
byte[]	LONGVARBINARY	BLOB <sup>5</sup>
java.sql.Date	DATE	DATE
java.sql.Time	TIME	TIME
java.sql.Timestamp	TIMESTAMP	TIMESTAMP, TIMESTAMP( $p$ ), TIMESTAMP WITH TIME ZONE, TIMESTAMP( $p$ ) WITH TIME ZONE <sup>8,9</sup>
java.sql.Blob	BLOB	BLOB
java.sql.Clob	CLOB	CLOB
java.sql.Clob	CLOB	DBCLOB
java.io.ByteArrayInputStream	None	BLOB
java.io.StringReader	None	CLOB
java.io.ByteArrayInputStream	None	CLOB
com.ibm.db2.jcc.DB2RowID (deprecated)	com.ibm.db2.jcc.DB2Types.ROWID	ROWID
java.sql.RowId	java.sql.Types.ROWID	ROWID
com.ibm.db2.jcc.DB2Xml (deprecated)	com.ibm.db2.jcc.DB2Types.XML	XML AS CLOB
java.sql.SQLXML	java.sql.Types.SQLXML	XML
java.sql.SQLXML	java.sql.Types.SQLXML	XML AS CLOB
java.sql.Array	java.sql.Types.ARRAY	ARRAY <sup>2</sup>
java.sql.Struct	java.sql.Types.STRUCT	ROW <sup>1,2</sup>
java.sql.ResultSet	com.ibm.db2.jcc.DB2Types.CURSOR	CURSOR type <sup>2</sup>

Table 52. Mappings of Java, JDBC, and SQL data types for calling stored procedures and user-defined functions (continued)

Java data type	JDBC data type	SQL data type
<b>Notes:</b>		
1. This parameter data type is supported for IBM Data Server Driver for JDBC and SQLJ type 4 connectivity to DB2 Database for Linux, UNIX, and Windows only.		
2. This parameter data type is supported for stored procedure calls only.		
3. A stored procedure or user-defined function that is defined with a SMALLINT parameter can be invoked with a boolean or byte parameter. However, this is not recommended.		
4. DECFLOAT parameters in Java routines are valid only for connections to DB2 Version 9.1 for z/OS or later database servers. DECFLOAT parameters in Java routines are not supported for connections to for Linux, UNIX, and Windows or DB2 for i. Use of DECFLOAT requires the SDK for Java Version 5 (1.5) or later.		
5. This mapping is valid only if the database server can determine the data type of the column.		
6. BINARY and VARBINARY are valid for connections to DB2 Version 9.1 for z/OS or later database servers or DB2 for i5/OS V5R3 and later database servers.		
7. BIGINT is valid for connections to DB2 Version 9.1 for z/OS or later database servers, DB2 V9.1 for Linux, UNIX, and Windows or later database servers, and all supported DB2 for i database servers.		
8. <i>p</i> indicates the timestamp precision, which is the number of digits in the fractional part of the timestamp. $0 \leq p \leq 12$ . The default is 6. <code>TIMESTAMP(<i>p</i>)</code> is supported for connections to DB2 Database for Linux, UNIX, and Windows V9.7 and later and DB2 for z/OS V10 and later only.		
9. The WITH TIME ZONE clause is supported for connections to DB2 for z/OS V10 and later only.		

## Data types in Java stored procedures and user-defined functions

The following table summarizes mappings of the SQL parameter data types in a CREATE PROCEDURE or CREATE FUNCTION statement to the data types in the corresponding Java stored procedure or user-defined function method.

For DB2 Database for Linux, UNIX, and Windows, if more than one Java data type is listed for an SQL data type, only the **first** Java data type is valid.

For DB2 for z/OS, if more than one Java data type is listed, and you use a data type other than the first data type as a method parameter, you need to include a method signature in the EXTERNAL clause of your CREATE PROCEDURE or CREATE FUNCTION statement that specifies the Java data types of the method parameters.

Table 53. Mappings of SQL data types in a CREATE PROCEDURE or CREATE FUNCTION statement to data types in the corresponding Java stored procedure or user-defined function program

SQL data type in CREATE PROCEDURE or CREATE FUNCTION	Data type in Java stored procedure or user-defined function method <sup>2</sup>
SMALLINT	short, java.lang.Integer
BOOLEAN <sup>1</sup>	boolean
INTEGER	int, java.lang.Integer
BIGINT <sup>3</sup>	long, java.lang.Long
REAL	float, java.lang.Float
DOUBLE	double, java.lang.Double
DECIMAL	java.math.BigDecimal
DECFLOAT <sup>4</sup>	java.math.BigDecimal
CHAR	java.lang.String

Table 53. Mappings of SQL data types in a CREATE PROCEDURE or CREATE FUNCTION statement to data types in the corresponding Java stored procedure or user-defined function program (continued)

SQL data type in CREATE PROCEDURE or CREATE FUNCTION	Data type in Java stored procedure or user-defined function method <sup>2</sup>
VARCHAR	java.lang.String
CHAR FOR BIT DATA	byte[]
VARCHAR FOR BIT DATA	byte[]
BINARY <sup>5</sup>	byte[]
VARBINARY <sup>5</sup>	byte[]
DATE	java.sql.Date
TIME	java.sql.Time
TIMESTAMP, TIMESTAMP( <i>p</i> ), TIMESTAMP WITH TIME ZONE, TIMESTAMP( <i>p</i> ) WITH TIME ZONE <sup>6,7</sup>	java.sql.Timestamp
BLOB	java.sql.Blob
CLOB	java.sql.Clob
DBCLOB	java.sql.Clob
ROWID	java.sql.Types.ROWID
ARRAY <sup>1</sup>	java.sql.Array
ROW <sup>1</sup>	java.sql.Struct
XML AS CLOB	java.sql.Types.SQLXML

**Notes:**

1. This parameter data type is supported for stored procedures only.
2. For a stored procedure or user-defined function on a DB2 Database for Linux, UNIX, and Windows server, only the **first** data type is valid.
3. BIGINT is valid for connections to DB2 Version 9.1 for z/OS or later database servers or DB2 V9.1 for Linux, UNIX, and Windows or later database servers.
4. DECFLOAT parameters in Java routines are valid only for connections to DB2 Version 9.1 for z/OS or later database servers. DECFLOAT parameters in Java routines are not supported for connections to for Linux, UNIX, and Windows or DB2 for i. Use of DECFLOAT requires the SDK for Java Version 5 (1.5) or later.
5. BINARY and VARBINARY are valid for connections to DB2 Version 9.1 for z/OS or later database servers.
6. *p* indicates the timestamp precision, which is the number of digits in the fractional part of the timestamp.  $0 \leq p \leq 12$ . The default is 6. TIMESTAMP(*p*) is supported for connections to DB2 Database for Linux, UNIX, and Windows V9.7 and later and DB2 for z/OS V10 and later only.
7. The WITH TIME ZONE clause is supported for connections to DB2 for z/OS V10 and later only.

## Date, time, and timestamp values that can cause problems in JDBC and SQLJ applications

You might receive unexpected results in JDBC and SQLJ applications if you use date, time, and timestamp values that do not correspond to real dates and times.

The following items might cause problems:

- Use of the hour '24' to represent midnight
- Use of a date between October 5, 1582, and October 14, 1582, inclusive

## Problems with using the hour '24' as midnight

The IBM Data Server Driver for JDBC and SQLJ uses Java data types for its internal processing of input and output parameters and ResultSet content in JDBC and SQLJ applications. The Java data type that is used by the driver is based on the best match for the corresponding SQL type when the target SQL type is known to the driver.

For values that are assigned to or retrieved from DATE, TIME, or TIMESTAMP SQL types, the IBM Data Server Driver for JDBC and SQLJ uses java.sql.Date for DATE SQL types, java.sql.Time for TIME SQL types, and java.sql.Timestamp for TIMESTAMP SQL types.

When you assign a string value to a DATE, TIME, or TIMESTAMP target, the IBM Data Server Driver for JDBC and SQLJ uses Java facilities to convert the string value to a java.sql.Date, java.sql.Time, or java.sql.Timestamp value. If a string representation of a date, time, or timestamp value does not correspond to a real date or time, Java adjusts the value to a real date or time value. In particular, Java adjusts an hour value of '24' to '00' of the next day. This adjustment can result in an exception for a timestamp value of '9999-12-31 24:00:00.0', because the adjusted year value becomes '10000'.

**Important:** To avoid unexpected results when you assign or retrieve date, time, or timestamp values in JDBC or SQLJ applications, ensure that the values are real date, time, or timestamp values. In addition, do not use '24' as the hour component of a time or timestamp value.

If a value that does not correspond to a real date or time, such as a value with an hour component of '24', is stored in a TIME or TIMESTAMP column, you can avoid adjustment during retrieval by executing the SQL CHAR function against that column in the SELECT statement that defines a ResultSet. Executing the CHAR function converts the date or time value to a character string value on the database side. However, if you use the getTime or getTimestamp method to retrieve that value from the ResultSet, the IBM Data Server Driver for JDBC and SQLJ converts the value to a java.sql.Time or java.sql.Timestamp type, and Java adjusts the value. To avoid date adjustment, execute the CHAR function against the column value, *and* retrieve the value from the ResultSet with the getString method.

The following examples show the results of updating DATE, TIME, or TIMESTAMP columns in JDBC or SQLJ applications, when the application data does not represent real dates or times.

Table 54. Examples of updating DATE, TIME, or TIMESTAMP SQL values with Java date, time, or timestamp values that do not represent real dates or times

String input value	Target type in database	Value sent to table column, or exception
2008-13-35	DATE	2009-02-04
25:00:00	TIME	01:00:00
24:00:00	TIME	00:00:00
2008-15-36 28:63:74.0	TIMESTAMP	2009-04-06 05:04:14.0
9999-12-31 24:00:00.0	TIMESTAMP	Exception, because the adjusted value (10000-01-01 00:00:00.0) exceeds the maximum year of 9999.

The following examples demonstrate the results of retrieving data from `TIMESTAMP` columns in JDBC or SQLJ applications, when the values in those columns do not represent real dates or times.

Table 55. Results of retrieving `DATE`, `TIME`, or `TIMESTAMP` SQL values that do not represent real dates or times into Java application variables

SELECT statement	Value in <code>TIMESTAMP</code> column <code>TS_COL</code>	Target type in application (getXXX method for retrieval)	Value retrieved from table column
SELECT <code>TS_COL</code> FROM <code>TABLE1</code>	2000-01-01 24:00:00.000000	java.sql.Timestamp (getTimestamp)	2000-01-02 00:00:00.000000
SELECT <code>TS_COL</code> FROM <code>TABLE1</code>	2000-01-01 24:00:00.000000	String (getString)	2000-01-02 00:00:00.000000
SELECT CHAR( <code>TS_COL</code> ) FROM <code>TABLE1</code>	2000-01-01 24:00:00.000000	java.sql.Timestamp (getTimestamp)	2000-01-02 00:00:00.000000
SELECT CHAR( <code>TS_COL</code> ) FROM <code>TABLE1</code>	2000-01-01 24:00:00.000000	String (getString)	2000-01-01 24:00:00.000000 (no adjustment by Java)

## Problems with using dates in the range October 5, 1582, through October 14, 1582

The Java `java.util.Date` and `java.util.Timestamp` classes use the Julian calendar for dates before October 4, 1582, and the Gregorian calendar for dates starting with October 4, 1582. In the Gregorian calendar, October 4, 1582, is followed by October 15, 1582. If a Java program encounters a `java.util.Date` or `java.util.Timestamp` value that is between October 5, 1582, and October 14, 1582, inclusive, Java adds 10 days to that date. Therefore, a `DATE` or `TIMESTAMP` value in a DB2 table that has a value between October 5, 1582, and October 14, 1582, inclusive, is retrieved in a Java program as a `java.util.Date` or `java.util.Timestamp` value between October 15, 1582, and October 24, 1582, inclusive. A `java.util.Date` or `java.util.Timestamp` value in a Java program that is between October 5, 1582, and October 14, 1582, inclusive, is stored in a DB2 table as a `DATE` or `TIMESTAMP` value between October 15, 1582, and October 24, 1582, inclusive.

**Example:** Retrieve October 10, 1582, from a `DATE` column.

```
// DATETABLE has one date column with one row.
// Its value is 1582-10-10.
java.sql.ResultSet rs =
    statement.executeQuery(select * from DATETABLE);
rs.next();
System.out.println(rs.getDate(1)); // Value is retrieved as 1582-10-20
```

**Example:** Store October 10, 1582, in a `DATE` column.

```
java.sql.Date d = java.sql.Date.valueOf("1582-10-10");
java.sql.PreparedStatement ps =
    c.prepareStatement("Insert into DATETABLE values(?)");
ps.setDate(1, d);
ps.executeUpdate(); // Value is inserted as 1582-10-20
```

To retrieve a value in the range October 5, 1582, to October 14, 1582, from a DB2 table without date adjustment, execute the SQL `CHAR` function against the `DATE` or `TIMESTAMP` column in the `SELECT` statement that defines a `ResultSet`. Executing the `CHAR` function converts the date or time value to a character string value on the database side.



To store a value in the range October 5, 1582, to October 14, 1582 in a DB2 table without date adjustment, you can use one of the following techniques:

- For a JDBC or an SQLJ application, use the `setString` method to assign the value to a String input parameter. Cast the input parameter as `VARCHAR`, and execute the `DATE` or `TIMESTAMP` function against the result of the cast. Then store the result of the `DATE` or `TIMESTAMP` function in the `DATE` or `TIMESTAMP` column.
- For a JDBC application, set the `Connection` or `DataSource` property `sendDataAsIs` to **true**, and use the `setString` method to assign the date or timestamp value to the input parameter. Then execute an SQL statement to assign the String value to the `DATE` or `TIMESTAMP` column.

**Example:** Retrieve October 10, 1582, from a `DATE` column without date adjustment.

```
// DATETABLE has one date column called DATECOL with one row.
// Its value is 1582-10-10.
java.sql.ResultSet rs =
    statement.executeQuery(SELECT CHAR(DATECOL) FROM DATETABLE);
rs.next();
System.out.println(rs.getString(1)); // Value is retrieved as 1582-10-10
```

**Example:** Store October 10, 1582, in a `DATE` column without date adjustment.

```
String s = "1582-10-10";
java.sql.Statement stmt = c.createStatement();
java.sql.PreparedStatement ps =
    c.prepareStatement("Insert INTO DATETABLE VALUES " +
        "(DATE(CAST (? AS VARCHAR)))");
ps.setString(1, s);
ps.executeUpdate(); // Value is inserted as 1582-10-10
```

## Data loss for timestamp data in JDBC and SQLJ applications

For DB2 for z/OS Version 10 or later, or DB2 Database for Linux, UNIX, and Windows Version 9.7 or later, you can specify the precision of the fractional part of a `TIMESTAMP` column, with a maximum precision of 12 digits. The fractional part of a Java timestamp value can have up to 9 digits of precision. Depending on the column definition, data loss can occur when you update a `TIMESTAMP(p)` column or retrieve data from a `TIMESTAMP(p)` column.

### Data loss for input data

If you use a `setTimestamp` call to pass a timestamp value to a `TIMESTAMP(p)` column, the maximum precision of the Java value that is sent to the data source is 9. If you use a `setTimestamp` call to pass a timestamp value to a `TIMESTAMP` column at a data source that does not support `TIMESTAMP(p)`, the maximum precision of the Java value that is sent to the data source is 6. For input to a `TIMESTAMP(p)` column, if the precision of the target column is less than the precision of the input value, the data source truncates the excess digits in the fractional part of the timestamp.

If you use a `setString` call to pass the input value, it is possible to send a value with a precision of greater than 9 to the data source.

For IBM Data Server Driver for JDBC and SQLJ version 3.59 or later, no data loss occurs if the `TIMESTAMP(p)` column is big enough to accommodate the input



value. For IBM Data Server Driver for JDBC and SQLJ version 3.58 or earlier, data loss depends on the setting of the `deferPrepares` property and the `sendDataAsIs` property:

- If `sendDataAsIs` is set to `true`, the IBM Data Server Driver for JDBC and SQLJ sends the string to the data source as-is, so the fractional part of the timestamp value can be more than 9 digits. If the value of  $p$  in the `TIMESTAMP( $p$ )` column is greater than or equal to the number of digits in the fractional part of the input data, no data loss occurs.
- If `sendDataAsIs` is set to `false`, data loss depends on the `deferPrepares` setting.
- If `deferPrepares` is set to `true`, the *first* time that an `UPDATE` statement is executed, the IBM Data Server Driver for JDBC and SQLJ sends the string to the data source as-is, so the fractional part of the timestamp value can be more than 9 digits. If the value of  $p$  in the `TIMESTAMP( $p$ )` column is greater than or equal to the number of digits in the fractional part of the input data, no data loss occurs.

For subsequent executions of the `UPDATE` statement, the IBM Data Server Driver for JDBC and SQLJ can determine that the target data type is a `TIMESTAMP` data type. If the data source supports `TIMESTAMP( $p$ )` columns, the driver converts the input value to a `java.sql.Timestamp` value with a maximum precision of 9. If the data source does not support `TIMESTAMP( $p$ )` columns, the driver converts the input value to a `java.sql.Timestamp` value with a maximum precision of 6. Data loss occurs if the original value has more precision than the converted `java.sql.Timestamp` value, or if the `java.sql.Timestamp` value has more precision than the `TIMESTAMP( $p$ )` column.

- If `deferPrepares` is set to `false`, the IBM Data Server Driver for JDBC and SQLJ can determine that the target data type is a `TIMESTAMP` data type. If the data source supports `TIMESTAMP( $p$ )` columns, the driver converts the input value to a `java.sql.Timestamp` value with a maximum precision of 9. If the data source does not support `TIMESTAMP( $p$ )` columns, the driver converts the input value to a `java.sql.Timestamp` value with a maximum precision of 6. Data loss occurs if the original value has more precision than the converted `java.sql.Timestamp` value, or if the `java.sql.Timestamp` value has more precision than the `TIMESTAMP( $p$ )` column.

You can lessen data loss for input timestamp values by using a `setString` call and setting `sendDataAsIs` to `true`. However, if you set `sendDataAsIs` to `true`, you need to ensure that application data types are compatible with data source data types.

## Data loss for output data

When you use a `getTimestamp` or `getString` call to retrieve data from a `TIMESTAMP( $p$ )` column, the IBM Data Server Driver for JDBC and SQLJ converts the value to a `java.sql.Timestamp` value with a maximum precision of 9. If the source value has a precision of greater than 9, the driver truncates the fractional part of the retrieved value to nine digits. If you do not want truncation to occur, in the `SELECT` statement that retrieves the `TIMESTAMP( $p$ )` value, you can cast the `TIMESTAMP( $p$ )` value to a character data type, such as `VARCHAR`, and use `getString` to retrieve the value from the `ResultSet`.

## Retrieval of special values from DECFLOAT columns in Java applications

Special handling is necessary if you retrieve values from `DECFLOAT` columns into `java.math.BigDecimal` variables, and the `DECFLOAT` columns contain the values `NaN`, `Infinity`, or `-Infinity`.

The recommended Java data type for retrieval of DECFLOAT column values is `java.math.BigDecimal`. However, if you receive SQL error code -4231 if you perform either of these operations:

- Retrieve the value NaN, Infinity, or -Infinity from a DECFLOAT column using the JDBC `java.sql.ResultSet.getBigDecimal` or `java.sql.ResultSet.getObject` method
- Retrieve the value NaN, Infinity, or -Infinity from a DECFLOAT column into a `java.math.BigDecimal` variable in an SQLJ clause of an SQLJ program

You can circumvent this restriction by testing for the -4231 error, and retrieving the special value using the `java.sql.ResultSet.getDouble` method.

Suppose that the following SQL statements were used to create and populate a table.

```
CREATE TABLE TEST.DECFLOAT_TEST
(
  INT_VAL INT,
  DEC_FLOAT_VAL DECFLOAT
);
INSERT INTO TEST.DECFLOAT_TEST (INT_VAL, DEC_FLOAT_VAL) VALUES (1, 123.456),
INSERT INTO TEST.DECFLOAT_TEST (INT_VAL, DEC_FLOAT_VAL) VALUES (2, INFINITY),
INSERT INTO TEST.DECFLOAT_TEST (INT_VAL, DEC_FLOAT_VAL) VALUES (3, -123.456),
INSERT INTO TEST.DECFLOAT_TEST (INT_VAL, DEC_FLOAT_VAL) VALUES (4, -INFINITY),
INSERT INTO TEST.DECFLOAT_TEST (INT_VAL, DEC_FLOAT_VAL) VALUES (5, NaN);
```

The following code retrieves the contents of the DECFLOAT column using the `java.sql.ResultSet.getBigDecimal` method. If retrieval fails because the column value is NaN, INFINITY, or -INFINITY, the program retrieves the value using the `java.sql.ResultSet.getDouble` method.

```
final static int DEC_FLOAT_SPECIALVALUE_ENCOUNTERED = -4231;
java.sql.Connection con =
    java.sql.DriverManager.getConnection("jdbc:db2://localhost:50000/sample"
        , "userid", "password");
java.sql.Statement stmt = con.createStatement();
java.sql.ResultSet rs = stmt.executeQuery(
    "SELECT INT_VAL, DEC_FLOAT_VAL FROM TEST.DECFLOAT_TEST ORDER BY INT_VAL");
int i = 0;
while (rs.next()) {
    try {
        System.out.println("\nRow " + ++i);
        System.out.println("INT_VAL      = " + rs.getInt(1));
        System.out.println("DEC_FLOAT_VAL = " + rs.getBigDecimal(2));
    }
    catch (java.sql.SQLException e) {
        System.out.println("Caught SQLException" + e.getMessage());
        if (e.getErrorCode() == DEC_FLOAT_SPECIALVALUE_ENCOUNTERED) {
            // getBigDecimal failed because the retrieved value is NaN,
            // INFINITY, or -INFINITY, so retry with getDouble.
            double d = rs.getDouble(2);
            if (d == Double.POSITIVE_INFINITY) {
                System.out.println("DEC_FLOAT_VAL = +INFINITY");
            } else if (d == Double.NEGATIVE_INFINITY) {
                System.out.println("DEC_FLOAT_VAL = -INFINITY");
            } else if (d == Double.NaN) {
                System.out.println("DEC_FLOAT_VAL = NaN");
            } else {
                System.out.println("DEC_FLOAT_VAL = " + d);
            }
        } else {
            e.printStackTrace();
        }
    }
}
```

---

## Properties for the IBM Data Server Driver for JDBC and SQLJ

IBM Data Server Driver for JDBC and SQLJ properties define how the connection to a particular data source should be made. Most properties can be set for a `DataSource` object or for a `Connection` object.

### Methods for setting the properties

Properties can be set in one of the following ways:

- Using `setXXX` methods, where `XXX` is the unqualified property name, with the first character capitalized.

Properties are applicable to the following IBM Data Server Driver for JDBC and SQLJ-specific implementations that inherit from

`com.ibm.db2.jcc.DB2BaseDataSource`:

- `com.ibm.db2.jcc.DB2SimpleDataSource`
- `com.ibm.db2.jcc.DB2ConnectionPoolDataSource`
- `com.ibm.db2.jcc.DB2XADataSource`

- In a `java.util.Properties` value in the *info* parameter of a `DriverManager.getConnection` call.
- In a `java.lang.String` value in the *url* parameter of a `DriverManager.getConnection` call.

Some properties with an `int` data type have predefined constant field values. You must resolve constant field values to their integer values before you can use those values in the *url* parameter. For example, you cannot use `com.ibm.db2.jcc.DB2BaseDataSource.TRACE_ALL` in a *url* parameter. However, you can build a URL string that includes `com.ibm.db2.jcc.DB2BaseDataSource.TRACE_ALL`, and assign the URL string to a `String` variable. Then you can use the `String` variable in the *url* parameter:

```
String url =
    "jdbc:db2://sysmvs1.st1.ibm.com:5021/STLEC1" +
    ":user=dbadm;password=dbadm;" +
    "traceLevel=" +
    (com.ibm.db2.jcc.DB2BaseDataSource.TRACE_ALL) + ";";

Connection con =
    java.sql.DriverManager.getConnection(url);
```

## Common IBM Data Server Driver for JDBC and SQLJ properties for all supported database products

Most of the IBM Data Server Driver for JDBC and SQLJ properties apply to all database products that the driver supports.

Unless otherwise noted, all properties are in `com.ibm.db2.jcc.DB2BaseDataSource`.

Those properties are:

### **affinityFailbackInterval**

Specifies the length of the interval, in seconds, that the IBM Data Server Driver for JDBC and SQLJ waits between attempts to fail back an existing connection to the primary server. A value that is less than or equal to 0 means that the connection does not fail back. The default is `DB2BaseDataSource.NOT_SET` (0).

Attempts to fail back connections to the primary server are made at transaction boundaries, after the specified interval elapses.

`affinityFailbackInterval` is used only if the values of properties `enableSeamlessFailover` and `enableClientAffinitiesList` are `DB2BaseDataSource.YES (1)`.

`affinityFailbackInterval` applies only to IBM Data Server Driver for JDBC and SQLJ type 4 connectivity.

#### **allowNextOnExhaustedResultSet**

Specifies how the IBM Data Server Driver for JDBC and SQLJ handles a `ResultSet.next()` call for a forward-only cursor that is positioned after the last row of the `ResultSet`. The data type of this property is `int`.

Possible values are:

##### **DB2BaseDataSource.YES (1)**

For a `ResultSet` that is defined as `TYPE_FORWARD_ONLY`, `ResultSet.next()` returns `false` if the cursor was previously positioned after the last row of the `ResultSet`. `false` is returned, regardless of whether the cursor is open or closed.

##### **DB2BaseDataSource.NO (2)**

For a `ResultSet` that is defined as `TYPE_FORWARD_ONLY`, when `ResultSet.next()` is called, and the cursor was previously positioned after the last row of the `ResultSet`, the driver throws a `java.sql.SQLException` with error text "Invalid operation: result set is closed." This is the default.

#### **allowNullResultSetForExecuteQuery**

Specifies whether the IBM Data Server Driver for JDBC and SQLJ returns null when `Statement.executeQuery`, `PreparedStatement.executeQuery`, or `CallableStatement.executeQuery` is used to execute a `CALL` statement for a stored procedure that does not return any result sets.

Possible values are:

##### **DB2BaseDataSource.NOT\_SET (0)**

The behavior is the same as for `DB2BaseDataSource.NO`.

##### **DB2BaseDataSource.YES (1)**

The IBM Data Server Driver for JDBC and SQLJ returns null when `Statement.executeQuery`, `PreparedStatement.executeQuery`, or `CallableStatement.executeQuery` is used to execute a `CALL` statement for a stored procedure that does not return any result sets. This behavior does not conform to the JDBC standard.

##### **DB2BaseDataSource.NO (2)**

The IBM Data Server Driver for JDBC and SQLJ throws an `SQLException` when `Statement.executeQuery`, `PreparedStatement.executeQuery`, or `CallableStatement.executeQuery` is used to execute a `CALL` statement for a stored procedure that does not return any result sets. This behavior conforms to the JDBC standard.

#### **atomicMultiRowInsert**

Specifies whether batch operations that use `PreparedStatement` methods to modify a table are atomic or non-atomic. The data type of this property is `int`.

For connections to DB2 for z/OS, this property applies only to batch `INSERT` operations.

For connections to DB2 Database for Linux, UNIX, and Windows or IBM Informix, this property applies to batch `INSERT`, `MERGE`, `UPDATE` or `DELETE` operations.

Possible values are:

**DB2BaseDataSource.YES (1)**

Batch operations are atomic. Insertion of all rows in the batch is considered to be a single operation. If insertion of a single row fails, the entire operation fails with a `BatchUpdateException`. Use of a batch statement that returns auto-generated keys fails with a `BatchUpdateException`.

If `atomicMultiRowInsert` is set to `DB2BaseDataSource.YES (1)`:

- Execution of statements in a heterogeneous batch is not allowed.
- If the target data source is DB2 for z/OS the following operations are not allowed:
  - Insertion of more than 32767 rows in a batch results in a `BatchUpdateException`.
  - Calling more than one of the following methods against the same parameter in different rows results in a `BatchUpdateException`:
    - `PreparedStatement.setAsciiStream`
    - `PreparedStatement.setCharacterStream`
    - `PreparedStatement.setUnicodeStream`

**DB2BaseDataSource.NO (2)**

Batch inserts are non-atomic. Insertion of each row is considered to be a separate execution. Information on the success of each insert operation is provided by the `int[]` array that is returned by `Statement.executeBatch`.

**DB2BaseDataSource.NOT\_SET (0)**

Batch inserts are non-atomic. Insertion of each row is considered to be a separate execution. Information on the success of each insert operation is provided by the `int[]` array that is returned by `Statement.executeBatch`. This is the default.

**blockingReadConnectionTimeout**

The amount of time in seconds before a connection socket read times out. This property applies only to IBM Data Server Driver for JDBC and SQLJ type 4 connectivity, and affects all requests that are sent to the data source after a connection is successfully established. The default is 0. A value of 0 means that there is no timeout.

**clientDebugInfo**

Specifies a value for the `CLIENT DEBUGINFO` connection attribute, to notify the data server that stored procedures and user-defined functions that are using the connection are running in debug mode. `CLIENT DEBUGINFO` is used by the DB2 Unified Debugger. The data type of this property is `String`. The maximum length is 254 bytes.

This property applies only to IBM Data Server Driver for JDBC and SQLJ type 4 connectivity.

**clientRerouteAlternateServerName**

Specifies one or more server names for client reroute. The data type of this property is `String`.

When `enableClientAffinitiesList=DB2BaseDataSource.YES (1)`, `clientRerouteAlternateServerName` must contain the name of the primary server as well as alternate server names. The server that is identified by `serverName` and `portNumber` is the primary server. That server name must appear at the beginning of the `clientRerouteAlternateServerName` list.

If more than one server name is specified, delimit the server names with commas (,) or spaces. The number of values that is specified for `clientRerouteAlternateServerName` must match the number of values that is specified for `clientRerouteAlternatePortNumber`.

`clientRerouteAlternateServerName` applies to IBM Data Server Driver for JDBC and SQLJ type 2 connectivity to DB2 Database for Linux, UNIX, and Windows and IBM Data Server Driver for JDBC and SQLJ type 4 connectivity.

#### **clientRerouteAlternatePortNumber**

Specifies one or more port numbers for client reroute. The data type of this property is String.

When `enableClientAffinitiesList=DB2BaseDataSource.YES (1)`, `clientRerouteAlternatePortNumber` must contain the port number for the primary server as well as port numbers for alternate servers. The server that is identified by `serverName` and `portNumber` is the primary server. That port number must appear at the beginning of the `clientRerouteAlternatePortNumber` list.

If more than one port number is specified, delimit the port numbers with commas (,) or spaces. The number of values that is specified for `clientRerouteAlternatePortNumber` must match the number of values that is specified for `clientRerouteAlternateServerName`.

`clientRerouteAlternatePortNumber` applies to IBM Data Server Driver for JDBC and SQLJ type 2 connectivity to DB2 Database for Linux, UNIX, and Windows and IBM Data Server Driver for JDBC and SQLJ type 4 connectivity.

#### **clientRerouteServerListJNDIName**

Identifies a JNDI reference to a `DB2ClientRerouteServerList` instance in a JNDI repository of reroute server information. `clientRerouteServerListJNDIName` applies only to IBM Data Server Driver for JDBC and SQLJ type 4 connectivity, and to connections that are established through the `DataSource` interface.

If the value of `clientRerouteServerListJNDIName` is not null, `clientRerouteServerListJNDIName` provides the following functions:

- Allows information about reroute servers to persist across JVMs
- Provides an alternate server location if the first connection to the data source fails

#### **clientRerouteServerListJNDIContext**

Specifies the JNDI context that is used for binding and lookup of the `DB2ClientRerouteServerList` instance. `clientRerouteServerListJNDIContext` applies only to IBM Data Server Driver for JDBC and SQLJ type 4 connectivity, and to connections that are established through the `DataSource` interface.

If `clientRerouteServerListJNDIContext` is not set, the IBM Data Server Driver for JDBC and SQLJ creates an initial context using system properties or the `jndi.properties` file.

`clientRerouteServerListJNDIContext` can be set **only** by using the following method:

```
public void setClientRerouteServerListJNDIContext(javax.naming.Context registry)
```

#### **connectionCloseWithInFlightTransaction**

Specifies whether the IBM Data Server Driver for JDBC and SQLJ throws an `SQLException` or rolls back a transaction without throwing an `SQLException` when a connection is closed in the middle of the transaction. Possible values are:



**DB2BaseDataSource.NOT\_SET (0)**

The behavior is the same as for  
DB2BaseDataSource.CONNECTION\_CLOSE\_WITH\_EXCEPTION.

**DB2BaseDataSource.CONNECTION\_CLOSE\_WITH\_EXCEPTION (1)**

When a connection is closed in the middle of a transaction, an  
SQLException with error -4471 is thrown.

**DB2BaseDataSource.CONNECTION\_CLOSE\_WITH\_ROLLBACK (2)**

When a connection is closed in the middle of a transaction, the  
transaction is rolled back, and no SQLException is thrown.

**databaseName**

Specifies the name for the data source. This name is used as the *database* portion of the connection URL. The name depends on whether IBM Data Server Driver for JDBC and SQLJ type 4 connectivity or IBM Data Server Driver for JDBC and SQLJ type 2 connectivity is used.

For IBM Data Server Driver for JDBC and SQLJ type 4 connectivity:

- If the connection is to a DB2 for z/OS server, the databaseName value is the DB2 location name that is defined during installation. All characters in this value must be uppercase characters. You can determine the location name by executing the following SQL statement on the server:

```
SELECT CURRENT SERVER FROM SYSIBM.SYSDUMMY1;
```

- If the connection is to a DB2 Database for Linux, UNIX, and Windows server, the databaseName value is the database name that is defined during installation.
- If the connection is to an IBM Informix server, *database* is the database name. The name is case-insensitive. The server converts the name to lowercase.
- If the connection is to an IBM Cloudscape server, the databaseName value is the fully-qualified name of the file that contains the database. This name must be enclosed in double quotation marks ("). For example:

```
"c:/databases/testdb"
```

If this property is not set, connections are made to the local site.

For IBM Data Server Driver for JDBC and SQLJ type 2 connectivity:

- The databaseName value is the database name that is defined during installation, if the value of the serverName connection property is null. If the value of serverName property is not null, the databaseName value is a database alias.

**decimalSeparator**

Specifies the decimal separator for input and output, for decimal, floating point, or decimal floating-point data values. The data type of this property is int.

If the value of the sendDataAsIs property is true, decimalSeparator affects only output values.

Possible values are:

**DB2BaseDataSource.DECIMAL\_SEPARATOR\_NOT\_SET (0)**

A period is used as the decimal separator. This is the default.

**DB2BaseDataSource.DECIMAL\_SEPARATOR\_PERIOD (1)**

A period is used as the decimal separator.

**DB2BaseDataSource.DECIMAL\_SEPARATOR\_COMMA (2)**

A comma is used as the decimal separator.

When `DECIMAL_SEPARATOR_COMMA` is set, the result of `ResultSet.getString` on a decimal, floating point, or decimal floating-point value has a comma as a separator. However, if the `toString` method is executed on a value that is retrieved with a `ResultSet.getXXX` method that returns a decimal, floating point, or decimal floating-point value, the result has a decimal point as the decimal separator.

#### **decimalStringFormat**

Specifies the string format for data that is retrieved from a `DECIMAL` or `DECFLOAT` column when the SDK for Java is Version 1.5 or later. The data type of this property is `int`. Possible values are:

##### **DB2BaseDataSource.DECIMAL\_STRING\_FORMAT\_NOT\_SET (0)**

The IBM Data Server Driver for JDBC and SQLJ returns decimal values in the format that the `java.math.BigDecimal.toString` method returns them. This is the default.

For example, the value 0.0000000004 is returned as 4E-10.

##### **DB2BaseDataSource.DECIMAL\_STRING\_FORMAT\_TO\_STRING (1)**

The IBM Data Server Driver for JDBC and SQLJ returns decimal values in the format that the `java.math.BigDecimal.toString` method returns them.

For example, the value 0.0000000004 is returned as 4E-10.

##### **DB2BaseDataSource.DECIMAL\_STRING\_FORMAT\_TO\_PLAIN\_STRING (2)**

The IBM Data Server Driver for JDBC and SQLJ returns decimal values in the format that the `java.math.BigDecimal.toPlainString` method returns them.

For example, the value 0.0000000004 is returned as 0.0000000004.

This property has no effect for earlier versions of the SDK for Java. For those versions, the IBM Data Server Driver for JDBC and SQLJ returns decimal values in the format that the `java.math.BigDecimal.toString` method returns them.

#### **defaultIsolationLevel**

Specifies the default transaction isolation level for new connections. The data type of this property is `int`. When `defaultIsolationLevel` is set on a `DataSource`, all connections that are created from that `DataSource` have the default isolation level that is specified by `defaultIsolationLevel`.

For DB2 data sources, the default is `java.sql.Connection.TRANSACTION_READ_COMMITTED`.

For IBM Informix databases, the default depends on the type of data source. The following table shows the defaults.

*Table 56. Default isolation levels for IBM Informix databases*

Type of data source	Default isolation level
ANSI-compliant database with logging	<code>java.sql.Connection.TRANSACTION_SERIALIZABLE</code>
Database without logging	<code>java.sql.Connection.TRANSACTION_READ_UNCOMMITTED</code>
Non-ANSI-compliant database with logging	<code>java.sql.Connection.TRANSACTION_READ_COMMITTED</code>

#### **deferPrepares**

Specifies whether invocation of the `Connection.prepareStatement` method



results in immediate preparation of an SQL statement on the data source, or whether statement preparation is deferred until the `PreparedStatement.execute` method is executed. The data type of this property is boolean.

`deferPrepares` is supported for IBM Data Server Driver for JDBC and SQLJ type 2 connectivity to DB2 Database for Linux, UNIX, and Windows, and for IBM Data Server Driver for JDBC and SQLJ type 4 connectivity.

Possible values are:

- true** Statement preparation on the data source does not occur until the `PreparedStatement.execute` method is executed. This is the default.
- false** Statement preparation on the data source occurs when the `Connection.prepareStatement` method is executed.

Deferring prepare operations can reduce network delays. However, if you defer prepare operations, you need to ensure that input data types match table column types.

#### **description**

A description of the data source. The data type of this property is String.

#### **downgradeHoldCursorsUnderXa**

Specifies whether cursors that are defined WITH HOLD can be opened under XA connections.

`downgradeHoldCursorsUnderXa` applies to:

- IBM Data Server Driver for JDBC and SQLJ type 4 connectivity to DB2 for z/OS servers.
- IBM Data Server Driver for JDBC and SQLJ type 4 connectivity or IBM Data Server Driver for JDBC and SQLJ type 2 connectivity to DB2 Database for Linux, UNIX, and Windows servers.

The default is `false`, which means that a cursor that is defined WITH HOLD cannot be opened under an XA connection. An exception is thrown when an attempt is made to open that cursor.

If `downgradeHoldCursorsUnderXa` is set to `true`, a cursor that is defined WITH HOLD can be opened under an XA connection. However, the cursor has the following restrictions:

- When the cursor is opened under an XA connection, the cursor does not have WITH HOLD behavior. The cursor is closed at XA End.
- A cursor that is open before XA Start on a local transaction is closed at XA Start.

#### **driverType**

For the `DataSource` interface, determines which driver to use for connections. The data type of this property is `int`. Valid values are 2 or 4. 2 is the default.

#### **enableClientAffinitiesList**

Specifies whether the IBM Data Server Driver for JDBC and SQLJ enables client affinities for cascaded failover support. The data type of this property is `int`. Possible values are:

##### **DB2BaseDataSource.YES (1)**

The IBM Data Server Driver for JDBC and SQLJ enables client affinities for cascaded failover support. This means that only servers that are specified in the `clientRerouteAlternateServerName` and `clientRerouteAlternatePortNumber` properties are retried. The driver does not attempt to reconnect to any other servers.

For example, suppose that `clientRerouteAlternateServerName` contains the following string:

```
host1,host2,host3
```

Also suppose that `clientRerouteAlternatePortNumber` contains the following string:

```
port1,port2,port3
```

When client affinities are enabled, the retry order is:

1. host1:port1
2. host2:port2
3. host3:port3

#### **DB2BaseDataSource.NO (2)**

The IBM Data Server Driver for JDBC and SQLJ does not enable client affinities for cascaded failover support.

#### **DB2BaseDataSource.NOT\_SET (0)**

The IBM Data Server Driver for JDBC and SQLJ does not enable client affinities for cascaded failover support. This is the default.

The effect of the `maxRetriesForClientReroute` and `retryIntervalForClientReroute` properties differs depending on whether `enableClientAffinitiesList` is enabled.

This property applies only to IBM Data Server Driver for JDBC and SQLJ type 4 connectivity.

#### **enableNamedParameterMarkers**

Specifies whether support for named parameter markers is enabled in the IBM Data Server Driver for JDBC and SQLJ. The data type of this property is `int`. Possible values are:

#### **DB2BaseDataSource.YES (1)**

Named parameter marker support is enabled in the IBM Data Server Driver for JDBC and SQLJ.

#### **DB2BaseDataSource.NO (2)**

Named parameter marker support is not enabled in the IBM Data Server Driver for JDBC and SQLJ.

The driver sends an SQL statement with named parameter markers to the target data source without modification. The success or failure of the statement depends on a number of factors, including the following ones:

- Whether the target data source supports named parameter markers
- Whether the `deferPrepares` property value is true or false
- Whether the `sendDataAsIs` property value is true or false

**Recommendation:** To avoid unexpected behavior in an application that uses named parameter markers, set `enableNamedParameterMarkers` to YES.

#### **DB2BaseDataSource.NOT\_SET (0)**

The behavior is the same as the behavior for `DB2BaseDataSource.NO (2)`. This is the default.

#### **enableSeamlessFailover**

Specifies whether the IBM Data Server Driver for JDBC and SQLJ uses seamless failover for client reroute. The data type of this property is `int`.

For connections to DB2 for z/OS, if `enableSysplexWLB` is set to true, `enableSeamlessFailover` has no effect. The IBM Data Server Driver for JDBC and SQLJ uses seamless failover regardless of the `enableSeamlessFailover` setting.

Possible values of `enableSeamlessFailover` are:

#### **DB2BaseDataSource.YES (1)**

The IBM Data Server Driver for JDBC and SQLJ uses seamless failover. This means that the driver does not throw an `SQLException` with SQL error code -4498 after a failed connection has been successfully re-established if the following conditions are true:

- The connection was not being used for a transaction at the time the failure occurred.
- There are no outstanding global resources, such as global temporary tables or open, held cursors, or connection states that prevent a seamless failover to another server.

When seamless failover occurs, after the connection to a new data source has been established, the driver re-issues the SQL statement that was being processed when the original connection failed.

**Recommendation:** Set the `queryCloseImplicit` property to `DB2BaseDataSource.QUERY_CLOSE_IMPLICIT_NO (2)` when you set `enableSeamlessFailover` to `DB2BaseDataSource.YES`, if the application uses held cursors.

#### **DB2BaseDataSource.NO (2)**

The IBM Data Server Driver for JDBC and SQLJ does not use seamless failover.

When this setting is in effect, if a server goes down, the driver tries to fail back or fail over to an alternate server. If failover or failback is successful, the driver throws an `SQLException` with SQL error code -4498, which indicates that a connection failed but was successfully reestablished. An `SQLException` with SQL error code -4498 informs the application that it should retry the transaction during which the connection failure occurred. If the driver cannot reestablish a connection, it throws an `SQLException` with SQL error code -4499.

#### **DB2BaseDataSource.NOT\_SET (0)**

The IBM Data Server Driver for JDBC and SQLJ does not use seamless failover. This is the default.

#### **enableSysplexWLB**

Indicates whether the Sysplex workload balancing function of the IBM Data Server Driver for JDBC and SQLJ is enabled. The data type of `enableSysplexWLB` is boolean. The default is false.

`enableSysplexWLB` applies only to IBM Data Server Driver for JDBC and SQLJ type 4 connectivity.

#### **fetchSize**

Specifies the default fetch size for `ResultSet` objects that are generated from `Statement` objects. The data type of this property is `int`.

The `fetchSize` default can be overridden by the `Statement.setFetchSize` method. The `fetchSize` property does not affect `Statement` objects that already exist when `fetchSize` is set.

Possible values of `fetchSize` are:

**0** or *positive-integer*

The default *fetchSize* value for newly created Statement objects. If the *fetchSize* property value is invalid, the IBM Data Server Driver for JDBC and SQLJ sets the default *fetchSize* value to 0.

**DB2BaseDataSource.FETCHSIZE\_NOT\_SET (-1)**

Indicates that the default *fetchSize* value for Statement objects is 0. This is the property default.

The *fetchSize* property differs from the *queryDataSize* property. *fetchSize* affects the number of rows that are returned, and *queryDataSize* affects the number of bytes that are returned.

**fullyMaterializeLobData**

Indicates whether the driver retrieves LOB locators for FETCH operations. The data type of this property is boolean.

The effect of *fullyMaterializeLobData* depends on whether the data source supports progressive streaming, which is also known as dynamic data format:

- If the data source does not support progressive streaming:  
If the value of *fullyMaterializeLobData* is true, LOB data is fully materialized within the JDBC driver when a row is fetched. If the value is false, LOB data is streamed. The driver uses locators internally to retrieve LOB data in chunks on an as-needed basis. It is highly recommended that you set this value to false when you retrieve LOBs that contain large amounts of data. The default is true.
- If the data source supports progressive streaming:  
The JDBC driver ignores the value of *fullyMaterializeLobData* if the *progressiveStreaming* property is set to `DB2BaseDataSource.YES` or `DB2BaseDataSource.NOT_SET`.

This property has no effect on stored procedure parameters or on LOBs that are fetched using scrollable cursors. LOB stored procedure parameters are always fully materialized. LOBs that are fetched using scrollable cursors use LOB locators if progressive streaming is not in effect.

**interruptProcessingMode**

Specifies the behavior of the IBM Data Server Driver for JDBC and SQLJ when an application executes the `Statement.cancel` method. Possible values are:

**DB2BaseDataSource.INTERRUPT\_PROCESSING\_MODE\_DISABLED (0)**

Interrupt processing is disabled. When an application executes `Statement.cancel`, the IBM Data Server Driver for JDBC and SQLJ does nothing.

**DB2BaseDataSource.INTERRUPT\_PROCESSING\_MODE\_STATEMENT\_CANCEL (1)**

When an application executes `Statement.cancel`, the IBM Data Server Driver for JDBC and SQLJ cancels the currently executing statement, if the data server supports interrupt processing. If the data server does not support interrupt processing, the IBM Data Server Driver for JDBC and SQLJ throws an `SQLException` that indicates that the feature is not supported.

`INTERRUPT_PROCESSING_MODE_STATEMENT_CANCEL` is the default.

For DB2 Database for Linux, UNIX, and Windows clients, when *interruptProcessingMode* is set to `INTERRUPT_PROCESSING_MODE_STATEMENT_CANCEL`, the DB2

Connect setting for `INTERRUPT_ENABLED` and the DB2 registry variable setting for `DB2CONNECT_DISCONNECT_ON_INTERRUPT` override this value.

#### **DB2BaseDataSource.INTERRUPT\_PROCESSING\_MODE\_CLOSE\_SOCKET (2)**

When an application executes `Statement.cancel`, the IBM Data Server Driver for JDBC and SQLJ performs one of the following actions:

- If automatic client reroute or client affinities is not enabled, the IBM Data Server Driver for JDBC and SQLJ drops the underlying socket, closes the connection, and throws an `SQLException` that indicates that the application is being disconnected from the data server. Any subsequent operations that are invoked on any `Statement` objects that are created from the same connection receive an `SQLException` that indicates that the connection is closed.
- If automatic client reroute or client affinities is enabled, the IBM Data Server Driver for JDBC and SQLJ drops the underlying socket, closes the connection, and then attempts to re-establish the connection. If re-connection is successful, the driver throws an `SQLException` that indicates that the connection was re-established. the driver does not re-execute any SQL statements, even if the `enableSeamlessFailover` property is set to `DB2BaseDataSource.YES`.

#### **loginTimeout**

The maximum time in seconds to wait for a connection to a data source. After the number of seconds that are specified by `loginTimeout` have elapsed, the driver closes the connection to the data source. The data type of this property is `int`. The default is 0. A value of 0 means that the timeout value is the default system timeout value. This property is not supported for IBM Data Server Driver for JDBC and SQLJ type 2 connectivity on DB2 for z/OS.

If the data server environment is a DB2 for z/OS Sysplex workload balancing environment or a DB2 pureScale environment, the wait time for a connection is determined by a combination of `loginTimeout`, `maxRetriesForClientReroute`, and `retryIntervalForClientReroute`. `loginTimeout` determines only the time for a single attempt to establish a connection to a data server. There might be multiple attempts to establish a connection, based on the `maxRetriesForClientReroute` value. There might also be gaps between attempts to establish a connection, based on the `retryIntervalForClientReroute` value.

#### **logWriter**

The character output stream to which all logging and trace messages for the `DataSource` object are printed. The data type of this property is `java.io.PrintWriter`. The default value is null, which means that no logging or tracing for the `DataSource` is output.

#### **maxRetriesForClientReroute**

During automatic client reroute, limit the number of retries if the primary connection to the data source fails.

The data type of this property is `int`.

The IBM Data Server Driver for JDBC and SQLJ uses the `maxRetriesForClientReroute` property only if the `retryIntervalForClientReroute` property is also set.

If the `enableClientAffinitiesList` is set to `DB2BaseDataSource.NO (2)`, an attempt to connect to the primary server and alternate servers counts as one retry. If `enableClientAffinitiesList` is set to `DB2BaseDataSource.YES (1)`, each server that is specified by the `clientRerouteAlternateServerName` and

clientRerouteAlternatePortNumber values is retried the number of times that is specified by maxRetriesForClientReroute.

The default for maxRetriesForClientReroute is determined as follows:

- If enableClientAffinitiesList is DB2BaseDataSource.YES (1), the default is 0.
- For version 3.63 or 4.13 or later of the IBM Data Server Driver for JDBC and SQLJ:
  - If enableSysplexWLB property is set to false, or the data server is not DB2 for z/OS, and maxRetriesForClientReroute and retryIntervalForClientReroute are not set, the connection is retried for 10 minutes, with a wait time between retries that increases as the length of time from the first retry increases.
  - If enableSysplexWLB property is set to true, and the data server is DB2 for z/OS, and maxRetriesForClientReroute and retryIntervalForClientReroute are not set, the default is 5.
- For versions of the IBM Data Server Driver for JDBC and SQLJ before 3.63 or 4.13, if maxRetriesForClientReroute and retryIntervalForClientReroute are not set, the connection is retried for 10 minutes, with a wait time between retries that increases as the length of time from the first retry increases.

If the value of maxRetriesForClientReroute is 0, client reroute processing does not occur.

#### **maxStatements**

Controls an internal statement cache that is associated with a Connection. The data type of this property is int. Possible values are:

##### **positive integer**

Enables the internal statement cache for a Connection, and specifies the number of statements that the IBM Data Server Driver for JDBC and SQLJ keeps open in the cache.

##### **0 or negative integer**

Disables internal statement caching for the Connection. 0 is the default.

com.ibm.db2.jcc.DB2SimpleDataSource.maxStatements controls the internal statement cache that is associated with a Connection only when the Connection object is created. com.ibm.db2.jcc.DB2SimpleDataSource.maxStatements has no effect on caching in an already existing Connection object.

com.ibm.db2.jcc.DB2SimpleDataSource.maxStatements applies only to IBM Data Server Driver for JDBC and SQLJ type 4 connectivity.

#### **password**

The password to use for establishing connections. The data type of this property is String. When you use the DataSource interface to establish a connection, you can override this property value by invoking this form of the DataSource.getConnection method:

```
getConnection(user, password);
```

#### **portNumber**

The port number where the DRDA server is listening for requests. The data type of this property is int.

#### **progressiveStreaming**

Specifies whether the JDBC driver uses progressive streaming when progressive streaming is supported on the data source.



DB2 for z/OS Version 9.1 and later supports progressive streaming for LOBs and XML objects. DB2 Database for Linux, UNIX, and Windows Version 9.5 and later, and IBM Informix Version 11.50 and later support progressive streaming for LOBs.

With progressive streaming, also known as dynamic data format, the data source dynamically determines the most efficient mode in which to return LOB or XML data, based on the size of the LOBs or XML objects. The value of the `streamBufferSize` parameter determines whether the data is materialized when it is returned.

The data type of `progressiveStreaming` is `int`. Valid values are `DB2BaseDataSource.YES` (1) and `DB2BaseDataSource.NO` (2). If the `progressiveStreaming` property is not specified, the `progressiveStreaming` value is `DB2BaseDataSource.NOT_SET` (0).

If the connection is to a data source that supports progressive streaming, and the value of `progressiveStreaming` is `DB2BaseDataSource.YES` or `DB2BaseDataSource.NOT_SET`, the JDBC driver uses progressive streaming to return LOBs and XML data.

If the value of `progressiveStreaming` is `DB2BaseDataSource.NO`, or the data source does not support progressive streaming, the way in which the JDBC driver returns LOB or XML data depends on the value of the `fullyMaterializeLobData` property.

#### **queryCloseImplicit**

Specifies whether cursors are closed immediately after all rows are fetched. `queryCloseImplicit` applies only to connections to IBM Data Server Driver for JDBC and SQLJ type 4 connectivity to DB2 for z/OS Version 8 or later, and IBM Data Server Driver for JDBC and SQLJ type 4 connectivity or IBM Data Server Driver for JDBC and SQLJ type 2 connectivity DB2 Database for Linux, UNIX, and Windows Version 9.7 or later. Possible values are:

##### **DB2BaseDataSource.QUERY\_CLOSE\_IMPLICIT\_YES (1)**

Close cursors immediately after all rows are fetched.

A value of `DB2BaseDataSource.QUERY_CLOSE_IMPLICIT_YES` can provide better performance because this setting results in less network traffic.

##### **DB2BaseDataSource.QUERY\_CLOSE\_IMPLICIT\_NO (2)**

Do not close cursors immediately after all rows are fetched.

##### **DB2BaseDataSource.QUERY\_CLOSE\_IMPLICIT\_COMMIT (3)**

Perform these actions:

- Implicitly close the cursor after all rows are fetched.
- If the application is in autocommit mode, implicitly send a commit request to the data source for the current unit of work.

**Important:** When this value is set, there might be impacts on other resources, just as an explicit commit operation might impact other resources. For example, other non-held cursors are closed, LOB locators go out of scope, progressive references are reset, and scrollable cursors lose their position.

**Restriction:** The following restrictions apply to `QUERY_CLOSE_IMPLICIT_COMMIT` behavior:

- This behavior applies only to `SELECT` statements that are issued by the application. It does not apply to `SELECT` statements that are generated by the IBM Data Server Driver for JDBC and SQLJ.

- If QUERY\_CLOSE\_IMPLICIT\_COMMIT is set, and the application is not in autocommit mode, the driver uses the default behavior (QUERY\_CLOSE\_IMPLICIT\_NOT\_SET behavior). If QUERY\_CLOSE\_IMPLICIT\_COMMIT is the default behavior, the driver uses QUERY\_CLOSE\_IMPLICIT\_YES behavior.
- If QUERY\_CLOSE\_IMPLICIT\_COMMIT is set, and the data source does not support QUERY\_CLOSE\_IMPLICIT\_COMMIT behavior, the driver uses QUERY\_CLOSE\_IMPLICIT\_YES behavior.
- This behavior is not supported for batched statements.
- This behavior is supported on an XA Connection only when the connection is in a local transaction.

#### **DB2BaseDataSource.QUERY\_CLOSE\_IMPLICIT\_NOT\_SET (0)**

This is the default. The following table describes the behavior for a connection to each type of data source.

<b>Data source</b>	<b>Version</b>	<b>Data sharing environment</b>	<b>Behavior</b>
DB2 for z/OS	Version 10	Data sharing or non-data sharing	QUERY_CLOSE_IMPLICIT_COMMIT
DB2 for z/OS	Version 9 with APAR PK68746	Non-data sharing, or in a data sharing group but not in coexistence mode with Version 8 members	QUERY_CLOSE_IMPLICIT_COMMIT
DB2 for z/OS	Version 9 without APAR PK68746	Non-data sharing, or in a data sharing group but not in coexistence mode with Version 8 members	QUERY_CLOSE_IMPLICIT_YES
DB2 for z/OS	Version 9 with APAR PK68746	In a data sharing group in coexistence mode with Version 8 members	QUERY_CLOSE_IMPLICIT_COMMIT
DB2 for z/OS	Version 9 without APAR PK68746	In a data sharing group in coexistence mode with Version 8 members	QUERY_CLOSE_IMPLICIT_YES
DB2 for z/OS	Version 8 with or without APAR PK68746		QUERY_CLOSE_IMPLICIT_YES
DB2 Database for Linux, UNIX, and Windows	Version 9.7		QUERY_CLOSE_IMPLICIT_YES

#### **queryDataSize**

Specifies a hint that is used to control the amount of query data, in bytes, that is returned from the data source on each fetch operation. This value can be used to optimize the application by controlling the number of trips to the data source that are required to retrieve data.

Use of a larger value for queryDataSize can result in less network traffic, which can result in better performance. For example, if the result set size is 50 KB, and the value of queryDataSize is 32767 (32KB), two trips to the database server are required to retrieve the result set. However, if queryDataSize is set to 65535 (64 KB), only one trip to the data source is required to retrieve the result set.

The following table lists minimum, maximum, and default values of queryDataSize for each data source.



Table 57. Default, minimum, and maximum values of queryDataSize

Data source	Product Version	Default	Minimum	Maximum	Valid values
DB2 Database for Linux, UNIX, and Windows	All	32767	4096	262143	4096-32767, 98303, 131071, 163839, 196607, 229375, 262143 <sup>1</sup>
IBM Informix	All	32767	4096	10485760	4096-10485760
DB2 for i	V5R4	32767	4096	65535	4096-65535
DB2 for i	V6R1	32767	4096	262143	4096-65535, 98303, 131071, 163839, 196607, 229375, 262143 <sup>1</sup>
DB2 for z/OS	Version 8 (IBM Data Server Driver for JDBC and SQLJ type 4 connectivity)	32767	32767	32767	32767
DB2 for z/OS	Version 9 (IBM Data Server Driver for JDBC and SQLJ type 4 connectivity)	32767	32767	65535	32767, 65535
DB2 for z/OS	Version 10 (IBM Data Server Driver for JDBC and SQLJ type 4 connectivity)	32767	32767	262143	32767, 65535, 98303, 131071, 163839, 196607, 229375, 262143 <sup>1</sup>
DB2 for z/OS	Version 10 (IBM Data Server Driver for JDBC and SQLJ type 2 connectivity)	32767	32767	1048575	32767, 65535, 98303, 131071, 163839, 196607, 229375, 262143, 294911, 327679, 360447, 393215, 425983, 458751, 491519, 524287, 557055, 589823, 622591, 655359, 688127, 720895, 753663, 786431, 819199, 851967, 884735, 917503, 950271, 983039, 1015807, 1048575 <sup>1</sup>

**Note:**

1. If you specify a value between the minimum and maximum value that is not a valid value, the IBM Data Server Driver for JDBC and SQLJ sets queryDataSize to the nearest valid value.

**queryTimeoutInterruptProcessingMode**

Specifies what happens when the query timeout interval for a Statement object expires. Valid values are:

**DB2BaseDataSource.-**

**INTERRUPT\_PROCESSING\_MODE\_STATEMENT\_CANCEL (1)**

Specifies that when the query timeout interval for a Statement object expires, the IBM Data Server Driver for JDBC and SQLJ cancels the currently executing SQL statement, if the data server supports interruption of SQL statements. If the data server does not support interruption of SQL statements, the driver throws an Exception that indicates that the feature is not supported.

**DB2BaseDataSource.-**

INTERRUPT\_PROCESSING\_MODE\_STATEMENT\_CANCEL is the default.

**DB2BaseDataSource.INTERRUPT\_PROCESSING\_MODE\_CLOSE\_SOCKET**

(2) Specifies that the underlying socket is dropped and the connection is closed when the query timeout interval for a Statement object expires.

When the Statement object times out, and automatic client reroute or client affinities is not configured, a DisconnectException with SQL error code -4499 is thrown. Any subsequent operations on the Statement object, or on any other Statement objects that were created from the same connection receive an Exception that indicates that the connection is closed. After a Statement object times out, the application must establish a new connection before it can execute a new transaction.

If automatic client reroute or client affinities is configured, the IBM Data Server Driver for JDBC and SQLJ tries to re-establish a connection according to the reroute mechanism in effect. If a new connection is successfully re-established, the driver returns an SQL error code of -4498 or -30108, instead of -4499. However, the driver does not execute the timed-out SQL statements again, even if enableSeamlessFailover is set to DB2BaseDataSource.YES (1).

**resultSetHoldability**

Specifies whether cursors remain open after a commit operation. The data type of this property is int. Valid values are:

**DB2BaseDataSource.HOLD\_CURSORS\_OVER\_COMMIT (1)**

Leave cursors open after a commit operation.

This setting is not valid for a connection that is part of a distributed (XA) transaction.

**DB2BaseDataSource.CLOSE\_CURSORS\_AT\_COMMIT (2)**

Close cursors after a commit operation.

**DB2BaseDataSource.NOT\_SET (0)**

This is the default value. The behavior is:

- For connections that are part of distributed (XA) transactions, cursors are closed after a commit operation.
- For connections that are not part of a distributed transaction:
  - For connections to all versions of DB2 for z/OS, DB2 Database for Linux, UNIX, and Windows, or DB2 for i servers, or to Cloudscape Version 8.1 or later servers, cursors remain open after a commit operation.
  - For connections to all versions of IBM Informix, or to Cloudscape versions earlier than Version 8.1, cursors are closed after a commit operation.

**retrieveMessagesFromServerOnGetMessage**

Specifies whether JDBC SQLException.getMessage or SQLWarning.getMessage calls cause the IBM Data Server Driver for JDBC and SQLJ to invoke a DB2 for z/OS stored procedure that retrieves the message text for the error. The data type of this property is boolean. The default is false, which means that the full message text is not returned to the client.

For example, if retrieveMessagesFromServerOnGetMessage is set to true, a message similar to this one is returned by SQLException.getMessage after an attempt to perform an SQL operation on nonexistent table

ADMFO01.NO\_TABLE:

```
ADMFO01.NO_TABLE IS AN UNDEFINED NAME. SQLCODE=-204,  
SQLSTATE=42704, DRIVER=3.50.54
```

If `retrieveMessagesFromServerOnGetMessage` is set to `false`, a message similar to this one is returned:

```
DB2 SQL Error: SQLCODE=-204, SQLSTATE=42704, DRIVER=3.50.54
```

An alternative to setting this property to `true` is to use the IBM Data Server Driver for JDBC and SQLJ-only `DB2Sqlca.getMessage` method in applications. Both techniques result in a stored procedure call, which starts a unit of work.

#### **retryIntervalForClientReroute**

For automatic client reroute, specifies the amount of time in seconds between connection retries.

The data type of this property is `int`.

The IBM Data Server Driver for JDBC and SQLJ uses the `retryIntervalForClientReroute` property only if the `maxRetriesForClientReroute` property is also set.

If `maxRetriesForClientReroute` or `retryIntervalForClientReroute` is not set, the IBM Data Server Driver for JDBC and SQLJ performs retries for 10 minutes.

If the `enableClientAffinitiesList` is set to `DB2BaseDataSource.NO (2)`, an attempt to connect to the primary server and alternate servers counts as one retry. The driver waits the number of seconds that is specified by `retryIntervalForClientReroute` before retrying the connection. If `enableClientAffinitiesList` is set to `DB2BaseDataSource.YES (1)`, each server that is specified by the `clientRerouteAlternateServerName` and `clientRerouteAlternatePortNumber` values is retried after the number of seconds that is specified by `retryIntervalForClientReroute`.

The default for `retryIntervalForClientReroute` is determined as follows:

- If `enableClientAffinitiesList` is `DB2BaseDataSource.YES (1)`, the default is 0.
- For version 3.63 or 4.13 or later of the IBM Data Server Driver for JDBC and SQLJ:
  - If `enableSysplexWLB` property is set to `false`, or the data server is not DB2 for z/OS, and `maxRetriesForClientReroute` and `retryIntervalForClientReroute` are not set, the connection is retried for 10 minutes, with a wait time between retries that increases as the length of time from the first retry increases.
  - If `enableSysplexWLB` property is set to `true`, and the data server is DB2 for z/OS, and `maxRetriesForClientReroute` and `retryIntervalForClientReroute` are not set, the default is 0.
- For versions of the IBM Data Server Driver for JDBC and SQLJ before 3.63 or 4.13, if `maxRetriesForClientReroute` and `retryIntervalForClientReroute` are not set, the connection is retried for 10 minutes, with a wait time between retries that increases as the length of time from the first retry increases.

#### **securityMechanism**

Specifies the DRDA security mechanism. The data type of this property is `int`. Possible values are:

**CLEAR\_TEXT\_PASSWORD\_SECURITY (3)**  
User ID and password

**USER\_ONLY\_SECURITY (4)**  
User ID only

**ENCRYPTED\_PASSWORD\_SECURITY (7)**  
User ID, encrypted password

**ENCRYPTED\_USER\_AND\_PASSWORD\_SECURITY (9)**

Encrypted user ID and password

**KERBEROS\_SECURITY (11)**

Kerberos. This value does not apply to connections to IBM Informix.

**ENCRYPTED\_USER\_AND\_DATA\_SECURITY (12)**

Encrypted user ID and encrypted security-sensitive data. This value applies to connections to DB2 for z/OS only.

**ENCRYPTED\_USER\_PASSWORD\_AND\_DATA\_SECURITY (13)**

Encrypted user ID and password, and encrypted security-sensitive data. This value does not apply to connections to IBM Informix.

**PLUGIN\_SECURITY (15)**

Plug-in security. This value applies to connections to DB2 Database for Linux, UNIX, and Windows only.

**ENCRYPTED\_USER\_ONLY\_SECURITY (16)**

Encrypted user ID. This value does not apply to connections to IBM Informix.

If this property is specified, the specified security mechanism is the only mechanism that is used. If the security mechanism is not supported by the connection, an exception is thrown.

The default value for securityMechanism is CLEAR\_TEXT\_PASSWORD\_SECURITY. If the server does not support CLEAR\_TEXT\_PASSWORD\_SECURITY but supports ENCRYPTED\_USER\_AND\_PASSWORD\_SECURITY, the IBM Data Server Driver for JDBC and SQLJ driver updates the security mechanism to ENCRYPTED\_USER\_AND\_PASSWORD\_SECURITY and attempts to connect to the server. Any other mismatch in security mechanism support between the requester and the server results in an error.

**sendDataAsIs**

Specifies that the IBM Data Server Driver for JDBC and SQLJ does not convert input parameter values to the target column data types. The data type of this property is boolean. The default is false.

You should use this property only for applications that always ensure that the data types in the application match the data types in the corresponding database tables.

**serverName**

The host name or the TCP/IP address of the data source. The data type of this property is String.

**sslConnection**

Specifies whether the IBM Data Server Driver for JDBC and SQLJ uses an SSL socket to connect to the data source. If sslConnection is set to true, the connection uses an SSL socket. If sslConnection is set to false, the connection uses a plain socket.

This property is applicable only to IBM Data Server Driver for JDBC and SQLJ type 4 connectivity.

**sslTrustStoreLocation**

Specifies the name of the Java truststore on the client that contains the server certificate for an SSL connection.

The IBM Data Server Driver for JDBC and SQLJ uses this option only if the `sslConnection` property is set to `true`.

If `sslTrustStore` is set, and `sslConnection` is set to `true`, the IBM Data Server Driver for JDBC and SQLJ uses the `sslTrustStoreLocation` value instead of the value in the `javax.net.ssl.trustStore` Java property.

This property is applicable only to IBM Data Server Driver for JDBC and SQLJ type 4 connectivity.

#### **sslTrustStorePassword**

Specifies the password for the Java truststore on the client that contains the server certificate for an SSL connection.

The IBM Data Server Driver for JDBC and SQLJ uses this option only if the `sslConnection` property is set to `true`.

If `sslTrustStorePassword` is set, and `sslConnection` is set to `true`, the IBM Data Server Driver for JDBC and SQLJ uses the `sslTrustStorePassword` value instead of the value in the `javax.net.ssl.trustStorePassword` Java property.

This property is applicable only to IBM Data Server Driver for JDBC and SQLJ type 4 connectivity.

#### **stripTrailingZerosForDecimalNumbers**

Specifies whether the IBM Data Server Driver for JDBC and SQLJ removes trailing zeroes when it retrieves data from a `DECFLOAT`, `DECIMAL`, or `NUMERIC` column. This property is meaningful only if the SDK for Java is Version 1.5 or later. The data type of this property is `int`.

Possible values are:

##### **DB2BaseDataSource.NOT\_SET (0)**

The IBM Data Server Driver for JDBC and SQLJ does not remove trailing zeroes from the retrieved value. This is the default.

##### **DB2BaseDataSource.YES (1)**

The IBM Data Server Driver for JDBC and SQLJ removes trailing zeroes when it retrieves a value from a `DECFLOAT`, `DECIMAL`, or `NUMERIC` column as a `java.math.BigDecimal` object.

For example, when the driver retrieves the value `234.04000`, it returns the value `234.04` to the application.

##### **DB2BaseDataSource.NO (2)**

The IBM Data Server Driver for JDBC and SQLJ does not remove trailing zeroes from the retrieved value.

#### **timerLevelForQueryTimeout**

Specifies the level at which the IBM Data Server Driver for JDBC and SQLJ creates a `java.util.Timer` object for waiting for query execution to time out.

Possible values are:

##### **DB2BaseDataSource.QUERYTIMEOUT\_STATEMENT\_LEVEL (1)**

The IBM Data Server Driver for JDBC and SQLJ creates a `Timer` object for each `Statement` object. When the `Statement` object is closed, the driver deletes the `Timer` object. This is the default.

##### **DB2BaseDataSource.QUERYTIMEOUT\_CONNECTION\_LEVEL (2)**

The IBM Data Server Driver for JDBC and SQLJ creates a `Timer` object for each `Connection` object. When the `Connection` object is closed, the driver deletes the `Timer` object.

### DB2BaseDataSource.QUERYTIMEOUT\_DISABLED (-1)

The IBM Data Server Driver for JDBC and SQLJ does not create a Timer object to control query execution timeout.

### timestampFormat

Specifies the format in which the result of the `ResultSet.getString` or `CallableStatement.getString` method against a `TIMESTAMP` column is returned. The data type of `timestampFormat` is `int`.

Possible values of `timestampFormat` are:

Constant	Integer value	Format
<code>com.ibm.db2.jcc.DB2BaseDataSource.ISO</code>	1	<code>yyyy-mm-dd-hh.mm.ss.nnnnnnnnn<sup>1</sup></code>
<code>com.ibm.db2.jcc.DB2BaseDataSource.JDBC</code>	5	<code>yyyy-mm-dd hh:mm:ss.nnnnnnnnn<sup>1</sup></code>

### Note:

1. The number of digits in the fractional part of the timestamp depends on the precision of the `TIMESTAMP(p)` column in the source table. If  $p < 9$ ,  $p$  digits are returned. If  $p \geq 9$ , 9 digits are returned, and the remaining digits are truncated.

The default is `com.ibm.db2.jcc.DB2BaseDataSource.JDBC`.

`timestampFormat` affects the format of output only.

### timestampPrecisionReporting

Specifies whether trailing zeroes are truncated in the result of a `ResultSet.getString` call for a `TIMESTAMP` value. The data type of this property is `int`. Possible values are:

#### TIMESTAMP\_JDBC\_STANDARD (1)

Trailing zeroes are truncated in the result of a `ResultSet.getString` call for a `TIMESTAMP` value. This is the default.

For example:

- A `TIMESTAMP` value of `2009-07-19-10.12.00.000000` is truncated to `2009-07-19-10.12.00.0` after retrieval.
- A `TIMESTAMP` value of `2009-12-01-11.30.00.100000` is truncated to `2009-12-01-11.30.00.1` after retrieval.

#### TIMESTAMP\_ZERO\_PADDING (2)

Trailing zeroes are not truncated in the result of a `ResultSet.getString` call for a `TIMESTAMP` value.

### traceDirectory

Specifies a directory into which trace information is written. The data type of this property is `String`. When `traceDirectory` is specified, trace information for multiple connections on the same `DataSource` is written to multiple files.

When `traceDirectory` is specified, a connection is traced to a file named `traceFile_origin_n`.

$n$  is the  $n$ th connection for a `DataSource`.

*origin* indicates the origin of the log writer that is in use. Possible values of *origin* are:

**cpds** The log writer for a `DB2ConnectionPoolDataSource` object.

**driver** The log writer for a `DB2Driver` object.

**global** The log writer for a DB2TraceManager object.

**sds** The log writer for a DB2SimpleDataSource object.

**xads** The log writer for a DB2XADDataSource object.

If the traceFile property is also specified, the traceDirectory value is not used.

#### **traceFile**

Specifies the name of a file into which the IBM Data Server Driver for JDBC and SQLJ writes trace information. The data type of this property is String. The traceFile property is an alternative to the logWriter property for directing the output trace stream to a file.

#### **traceFileAppend**

Specifies whether to append to or overwrite the file that is specified by the traceFile property. The data type of this property is boolean. The default is false, which means that the file that is specified by the traceFile property is overwritten.

#### **traceLevel**

Specifies what to trace. The data type of this property is int.

You can specify one or more of the following traces with the traceLevel property:

- com.ibm.db2.jcc.DB2BaseDataSource.TRACE\_NONE (X'00')
- com.ibm.db2.jcc.DB2BaseDataSource.TRACE\_CONNECTION\_CALLS (X'01')
- com.ibm.db2.jcc.DB2BaseDataSource.TRACE\_STATEMENT\_CALLS (X'02')
- com.ibm.db2.jcc.DB2BaseDataSource.TRACE\_RESULT\_SET\_CALLS (X'04')
- com.ibm.db2.jcc.DB2BaseDataSource.TRACE\_DRIVER\_CONFIGURATION (X'10')
- com.ibm.db2.jcc.DB2BaseDataSource.TRACE\_CONNECTS (X'20')
- com.ibm.db2.jcc.DB2BaseDataSource.TRACE\_DRDA\_FLOWS (X'40')
- com.ibm.db2.jcc.DB2BaseDataSource.TRACE\_RESULT\_SET\_META\_DATA (X'80')
- com.ibm.db2.jcc.DB2BaseDataSource.TRACE\_PARAMETER\_META\_DATA (X'100')
- com.ibm.db2.jcc.DB2BaseDataSource.TRACE\_DIAGNOSTICS (X'200')
- com.ibm.db2.jcc.DB2BaseDataSource.TRACE\_SQLJ (X'400')
- com.ibm.db2.jcc.DB2BaseDataSource.TRACE\_XA\_CALLS (IBM Data Server Driver for JDBC and SQLJ type 2 connectivity for DB2 Database for Linux, UNIX, and Windows only) (X'800')
- com.ibm.db2.jcc.DB2BaseDataSource.TRACE\_META\_CALLS (X'2000')
- com.ibm.db2.jcc.DB2BaseDataSource.TRACE\_DATASOURCE\_CALLS (X'4000')
- com.ibm.db2.jcc.DB2BaseDataSource.TRACE\_LARGE\_OBJECT\_CALLS (X'8000')
- com.ibm.db2.jcc.DB2BaseDataSource.TRACE\_SYSTEM\_MONITOR (X'20000')
- com.ibm.db2.jcc.DB2BaseDataSource.TRACE\_TRACEPOINTS (X'40000')
- com.ibm.db2.jcc.DB2BaseDataSource.TRACE\_ALL (X'FFFFFFFF')

To specify more than one trace, use one of these techniques:

- Use bitwise OR (|) operators with two or more trace values. For example, to trace DRDA flows and connection calls, specify this value for traceLevel:  
TRACE\_DRDA\_FLOWS|TRACE\_CONNECTION\_CALLS
- Use a bitwise complement (~) operator with a trace value to specify all except a certain trace. For example, to trace everything except DRDA flows, specify this value for traceLevel:  
~TRACE\_DRDA\_FLOWS

#### **traceFileCount**

Specifies the maximum number of trace files for circular tracing. The IBM Data



Server Driver for JDBC and SQLJ uses this property only when `traceOption` is set to `DB2BaseDataSource.TRACE_OPTION_CIRCULAR (1)`. The data type of this property is `int`. The default value is 2.

#### **traceFileSize**

Specifies the maximum size of each trace file, for circular tracing. The IBM Data Server Driver for JDBC and SQLJ uses this property only when `traceOption` is set to `DB2BaseDataSource.TRACE_OPTION_CIRCULAR (1)`. The data type of this property is `int`. The default value is 10485760 (10 MB).

#### **useJDBC41DefinitionForGetColumns**

Specifies whether the `DatabaseMetaData.getColumns` method returns a result set with a column with the name `SCOPE_CATALOG` or `SCOPE_CATLOG`. Possible values are:

##### **DB2BaseDataSource.NOT\_SET (0)**

Specifies that for version 4.13 or later of the IBM Data Server Driver for JDBC and SQLJ, the result set from `DatabaseMetaData.getColumns` contains a column named `SCOPE_CATALOG`. For version 4.12 or earlier of the IBM Data Server Driver for JDBC and SQLJ, that column is named `SCOPE_CATLOG`.

##### **DB2BaseDataSource.YES (1)**

Specifies that for version 4.13 or later of the IBM Data Server Driver for JDBC and SQLJ, the result set from `DatabaseMetaData.getColumns` contains a column named `SCOPE_CATALOG`. For version 4.12 or earlier of the IBM Data Server Driver for JDBC and SQLJ, that column is named `SCOPE_CATLOG`.

##### **DB2BaseDataSource.NO (2)**

Specifies that for all versions of the IBM Data Server Driver for JDBC and SQLJ, the result set from `DatabaseMetaData.getColumns` contains a column named `SCOPE_CATLOG`.

#### **traceOption**

Specifies the way in which trace data is collected. The data type of this property is `int`. Possible values are:

##### **DB2BaseDataSource.NOT\_SET (0)**

Specifies that a single trace file is generated, and that there is no limit to the size of the file. This is the default.

If the value of `traceOption` is `NOT_SET`, the `traceFileSize` and `traceFileCount` properties are ignored.

##### **DB2BaseDataSource.TRACE\_OPTION\_CIRCULAR (1)**

Specifies that the IBM Data Server Driver for JDBC and SQLJ does circular tracing. Circular tracing is done as follows:

1. When an application writes its first trace record, the driver creates a file.
2. The driver writes trace data to the file.
3. When the size of the file is equal to the value of property `traceFileSize`, the driver creates another file.
4. The driver repeats steps 2 and 3 until the number of files to which data has been written is equal to the value of property `traceFileCount`.
5. The driver writes data to the first trace file, overwriting the existing data.



- The driver repeats steps 3 on page 347 through 5 on page 347 until the application completes.

The file names for the trace files are the file names that are determined by the `traceFile` or `traceDirectory` property, appended with `.1` for the first file, `.2` for the second file, and so on.

**user**

The user ID to use for establishing connections. The data type of this property is String. When you use the `DataSource` interface to establish a connection, you can override this property value by invoking this form of the `DataSource.getConnection` method:

```
getConnection(user, password);
```

**xaNetworkOptimization**

Specifies whether XA network optimization is enabled for IBM Data Server Driver for JDBC and SQLJ type 4 connectivity. You might need to disable XA network optimization in an environment in which an XA Start and XA End are issued from one Java process, and an XA Prepare and an XA Commit are issued from another Java process. With XA network optimization, the XA Prepare can reach the data source before the XA End, which results in an XAER\_PROTO error. To prevent the XAER\_PROTO error, disable XA network optimization.

The default is true, which means that XA network optimization is enabled. If `xaNetworkOptimization` is false, which means that XA network optimization is disabled, the driver closes any open cursors at XA End time.

`xaNetworkOptimization` can be set on a `DataSource` object, or in the `url` parameter in a `getConnection` call. The value of `xaNetworkOptimization` cannot be changed after a connection is obtained.

## Common IBM Data Server Driver for JDBC and SQLJ properties for DB2 servers

Some of the IBM Data Server Driver for JDBC and SQLJ properties apply to DB2 for z/OS and DB2 Database for Linux, UNIX, and Windows only.

Unless otherwise noted, all properties are in `com.ibm.db2.jcc.DB2BaseDataSource`.

Those properties are:

**alternateGroupDatabaseName**

Specifies the database names for alternate groups to which an application can connect. The data type of this property is String. For a connection to a DB2 for z/OS data server, this value is the location name for a data sharing group. For a connection to a DB2 Database for Linux, UNIX, and Windows data server, each of these values is the database name for a DB2 pureScale instance. If more than one database name is specified, the database names must be separated by commas.

For connections to DB2 for z/OS, only one value can be specified.

**alternateGroupPortNumber**

Specifies the port numbers for alternate groups to which an application can connect. The data type of this property is String. For a connection to a DB2 for z/OS data server, this value is the TCP/IP server port number that is assigned to the data sharing group. For a connection to a DB2 Database for Linux, UNIX, and Windows data server, each of these values is the TCP/IP server

port number that is assigned to a DB2 pureScale instance. If more than one port number is specified, the port numbers must be separated by commas.

For connections to DB2 for z/OS, only one value can be specified.

**alternateGroupServerName**

Specifies the host names for alternate groups to which an application can connect. The data type of this property is String. The data type of this property is String. For a connection to a DB2 for z/OS data server, this value is the domain name or IP address that is assigned to the data sharing group. For a connection to a DB2 Database for Linux, UNIX, and Windows data server, each of these values is the domain name or IP address that is assigned to a DB2 pureScale instance. If more than one host name is specified, the host names must be separated by commas.

For connections to DB2 for z/OS, only one value can be specified.

**clientAccountingInformation**

Specifies accounting information for the current client for the connection. This information is for client accounting purposes. This value can change during a connection. The data type of this property is String. The maximum length is 255 bytes. A Java empty string ("") is valid for this value, but a Java null value is not valid.

**clientApplicationInformation**

Specifies the application or transaction name of the end user's application. You can use this property to provide the identity of the client end user for accounting and monitoring purposes. This value can change during a connection. The data type of this property is String. For a DB2 for z/OS server, the maximum length is 32 bytes. For a DB2 Database for Linux, UNIX, and Windows server, the maximum length is 255 bytes. A Java empty string ("") is valid for this value, but a Java null value is not valid.

**clientProgramId**

Specifies a value for the client program ID that can be used to identify the end user. The data type of this property is String, and the length is 80 bytes. If the program ID value is less than 80 bytes, the value must be padded with blanks.

**clientProgramName**

Specifies an application ID that is fixed for the duration of a physical connection for a client. The value of this property becomes the correlation ID on a DB2 for z/OS server. Database administrators can use this property to correlate work on a DB2 for z/OS server to client applications. The data type of this property is String. The maximum length is 12 bytes. If this value is null, the IBM Data Server Driver for JDBC and SQLJ supplies a value of *db2jccthread-name*.

This property applies only to IBM Data Server Driver for JDBC and SQLJ type 4 connectivity.

**concurrentAccessResolution**

Specifies whether the IBM Data Server Driver for JDBC and SQLJ requests that a read transaction can access a committed and consistent image of rows that are incompatibly locked by write transactions, if the data source supports accessing currently committed data, and the application isolation level is cursor stability (CS) or read stability (RS). This option has the same effect as the DB2 CONCURRENTACCESSRESOLUTION bind option. Possible values are:

**DB2BaseDataSource.-**

**CONCURRENTACCESS\_USE\_CURRENTLY\_COMMITTED (1)**

The IBM Data Server Driver for JDBC and SQLJ requests that:

- Read transactions access the currently committed data when the data is being updated or deleted.
- Read transactions skip rows that are being inserted.

#### **DB2BaseDataSource.CONCURRENTACCESS\_WAIT\_FOR\_OUTCOME (2)**

The IBM Data Server Driver for JDBC and SQLJ requests that:

- Read transactions wait for a commit or rollback operation when they encounter data that is being updated or deleted.
- Read transactions do not skip rows that are being inserted.

#### **DB2BaseDataSource.CONCURRENTACCESS\_NOT\_SET (0)**

Enables the data server's default behavior for read transactions when lock contention occurs. This is the default value.

#### **currentDegree**

Specifies the degree of parallelism for the execution of queries that are dynamically prepared. The type of this property is String. The currentDegree value is used to set the CURRENT DEGREE special register on the data source. If currentDegree is not set, no value is passed to the data source.

#### **currentExplainMode**

Specifies the value for the CURRENT EXPLAIN MODE special register. The CURRENT EXPLAIN MODE special register enables and disables the Explain facility. The data type of this property is String. The maximum length is 254 bytes. This property applies only to connections to data sources that support the CURRENT EXPLAIN MODE special register.

#### **currentFunctionPath**

Specifies the SQL path that is used to resolve unqualified data type names and function names in SQL statements that are in JDBC programs. The data type of this property is String. For a DB2 Database for Linux, UNIX, and Windows server, the maximum length is 254 bytes. For a DB2 for z/OS server, the maximum length is 2048 bytes. The value is a comma-separated list of schema names. Those names can be ordinary or delimited identifiers.

#### **currentMaintainedTableTypesForOptimization**

Specifies a value that identifies the types of objects that can be considered when the data source optimizes the processing of dynamic SQL queries. This register contains a keyword representing table types. The data type of this property is String.

Possible values of currentMaintainedTableTypesForOptimization are:

##### **ALL**

Indicates that all materialized query tables will be considered.

##### **NONE**

Indicates that no materialized query tables will be considered.

##### **SYSTEM**

Indicates that only system-maintained materialized query tables that are refresh deferred will be considered.

##### **USER**

Indicates that only user-maintained materialized query tables that are refresh deferred will be considered.

#### **currentPackagePath**

Specifies a comma-separated list of collections on the server. The database server searches these collections for JDBC and SQLJ packages.

The precedence rules for the `currentPackagePath` and `currentPackageSet` properties follow the precedence rules for the `CURRENT PACKAGESET` and `CURRENT PACKAGE PATH` special registers.

#### **currentPackageSet**

Specifies the collection ID to search for JDBC and SQLJ packages. The data type of this property is `String`. The default is `NULLID`. If `currentPackageSet` is set, its value overrides the value of `jdbcCollection`.

Multiple instances of the IBM Data Server Driver for JDBC and SQLJ can be installed at a database server by running the `DB2Binder` utility multiple times. The `DB2binder` utility includes a `-collection` option that lets the installer specify the collection ID for each IBM Data Server Driver for JDBC and SQLJ instance. To choose an instance of the IBM Data Server Driver for JDBC and SQLJ for a connection, you specify a `currentPackageSet` value that matches the collection ID for one of the IBM Data Server Driver for JDBC and SQLJ instances.

The precedence rules for the `currentPackagePath` and `currentPackageSet` properties follow the precedence rules for the `CURRENT PACKAGESET` and `CURRENT PACKAGE PATH` special registers.

#### **currentRefreshAge**

Specifies a timestamp duration value that is the maximum duration since a `REFRESH TABLE` statement was processed on a system-maintained `REFRESH DEFERRED` materialized query table such that the materialized query table can be used to optimize the processing of a query. This property affects dynamic statement cache matching. The data type of this property is `long`.

#### **currentSchema**

Specifies the default schema name that is used to qualify unqualified database objects in dynamically prepared SQL statements. The value of this property sets the value in the `CURRENT SCHEMA` special register on the database server. The schema name is case-sensitive, and must be specified in uppercase characters.

#### **cursorSensitivity**

Specifies whether the `java.sql.ResultSet.TYPE_SCROLL_SENSITIVE` value for a JDBC `ResultSet` maps to the `SENSITIVE DYNAMIC` attribute, the `SENSITIVE STATIC` attribute, or the `ASENSITIVE` attribute for the underlying database cursor. The data type of this property is `int`. Possible values are `TYPE_SCROLL_SENSITIVE_STATIC` (0), `TYPE_SCROLL_SENSITIVE_DYNAMIC` (1), or `TYPE_SCROLL_ASENSITIVE` (2). The default is `TYPE_SCROLL_SENSITIVE_STATIC`.

If the data source does not support sensitive dynamic scrollable cursors, and `TYPE_SCROLL_SENSITIVE_DYNAMIC` is requested, the JDBC driver accumulates a warning and maps the sensitivity to `SENSITIVE STATIC`. For DB2 for i database servers, which do not support sensitive static cursors, `java.sql.ResultSet.TYPE_SCROLL_SENSITIVE` always maps to `SENSITIVE DYNAMIC`.

#### **dateFormat**

Specifies:

- The format in which the `String` argument of the `PreparedStatement.setString` method against a `DATE` column must be specified.
- The format in which the result of the `ResultSet.getString` or `CallableStatement.getString` method against a `DATE` column is returned.

The data type of `dateFormat` is `int`.

Possible values of `dateFormat` are:

Constant	Integer value	Format
com.ibm.db2.jcc.DB2BaseDataSource.ISO	1	yyyy-mm-dd
com.ibm.db2.jcc.DB2BaseDataSource.USA	2	mm/dd/yyyy
com.ibm.db2.jcc.DB2BaseDataSource.EUR	3	dd.mm.yyyy
com.ibm.db2.jcc.DB2BaseDataSource.JIS	4	yyyy-mm-dd

The default is com.ibm.db2.jcc.DB2BaseDataSource.ISO.

#### **decimalRoundingMode**

Specifies the rounding mode for assignment to decimal floating-point variables or DECFLOAT columns on DB2 for z/OS or DB2 Database for Linux, UNIX, and Windows data servers.

Possible values are:

##### **DB2BaseDataSource.ROUND\_DOWN (1)**

Rounds the value towards 0 (truncation). The discarded digits are ignored.

##### **DB2BaseDataSource.ROUND\_CEILING (2)**

Rounds the value towards positive infinity. If all of the discarded digits are zero or if the sign is negative the result is unchanged other than the removal of the discarded digits. Otherwise, the result coefficient is incremented by 1.

##### **DB2BaseDataSource.ROUND\_HALF\_EVEN (3)**

Rounds the value to the nearest value; if the values are equidistant, rounds the value so that the final digit is even. If the discarded digits represents greater than half (0.5) of the value of one in the next left position then the result coefficient is incremented by 1. If they represent less than half, then the result coefficient is not adjusted (that is, the discarded digits are ignored). Otherwise the result coefficient is unaltered if its rightmost digit is even, or is incremented by 1 if its rightmost digit is odd (to make an even digit).

##### **DB2BaseDataSource.ROUND\_HALF\_UP (4)**

Rounds the value to the nearest value; if the values are equidistant, rounds the value away from zero. If the discarded digits represent greater than or equal to half (0.5) of the value of one in the next left position then the result coefficient is incremented by 1. Otherwise the discarded digits are ignored.

##### **DB2BaseDataSource.ROUND\_FLOOR (6)**

Rounds the value towards negative infinity. If all of the discarded digits are zero or if the sign is positive the result is unchanged other than the removal of discarded digits. Otherwise, the sign is negative and the result coefficient is incremented by 1.

##### **DB2BaseDataSource.ROUND\_UNSET (-2147483647)**

No rounding mode was explicitly set. The IBM Data Server Driver for JDBC and SQLJ does not use the decimalRoundingMode to set the rounding mode on the data server. The rounding mode is ROUND\_HALF\_EVEN.

If you explicitly set the decimalRoundingMode value, that value updates the CURRENT DECFLOAT ROUNDING MODE special register value on a DB2 for z/OS data server.

If you explicitly set the `decimalRoundingMode` value, that value does not update the CURRENT DECFLOAT ROUNDING MODE special register value on a DB2 Database for Linux, UNIX, and Windows data server. If the value to which you set `decimalRoundingMode` is not the same as the value of the CURRENT DECFLOAT ROUNDING MODE special register, an Exception is thrown. To change the data server value, you need to set that value with the `decflt_rounding` database configuration parameter.

`decimalRoundingMode` does not affect decimal value assignments. The IBM Data Server Driver for JDBC and SQLJ always rounds decimal values down.

#### **enableAlternateGroupSeamlessACR**

Specifies whether failover to an alternate group is seamless or non-seamless. The data type of this property is boolean. Possible values are:

**false** Failover is non-seamless. `false` is the default.

With non-seamless behavior, if an application that is currently connected to a primary group is executing a transaction, and the entire primary group goes down, the IBM Data Server Driver for JDBC and SQLJ fails over to alternate group. If failover is successful, the driver throws an `SQLException` with SQL error code -30108.

**true** Failover is seamless.

With seamless behavior, if an application that is currently connected to a primary group is executing a transaction, and the entire primary group goes down, the IBM Data Server Driver for JDBC and SQLJ fails over to alternate group. If the transaction is eligible for seamless failover, the connection is retried. If the connection is successful, no `SQLException` is thrown.

For connections to DB2 for z/OS, only one value can be specified.

#### **enableExtendedIndicators**

Specifies whether support for extended indicators is enabled in the IBM Data Server Driver for JDBC and SQLJ. Possible values are:

##### **DB2BaseDataSource.YES (1)**

Support for extended indicators is enabled in the IBM Data Server Driver for JDBC and SQLJ.

##### **DB2BaseDataSource.NO (2)**

Support for extended indicators is disabled in the IBM Data Server Driver for JDBC and SQLJ.

##### **DB2BaseDataSource.NOT\_SET (0)**

Support for extended indicators is enabled in the IBM Data Server Driver for JDBC and SQLJ. This is the default value.

#### **enableRowsetSupport**

Specifies whether the IBM Data Server Driver for JDBC and SQLJ uses multiple-row `FETCH` for forward-only cursors or scrollable cursors, if the data server supports multiple-row `FETCH`. The data type of this property is `int`.

For connections to DB2 for z/OS, when `enableRowsetSupport` is set, its value overrides the `useRowsetCursor` property value.

Possible values are:

##### **DB2BaseDataSource.YES (1)**

Specifies that:



- For IBM Data Server Driver for JDBC and SQLJ type 2 connectivity to DB2 for z/OS, multiple-row FETCH is used for scrollable cursors and forward-only cursors, if the data server supports multiple-row FETCH.
- For IBM Data Server Driver for JDBC and SQLJ type 4 connectivity, or IBM Data Server Driver for JDBC and SQLJ type 2 connectivity to DB2 Database for Linux, UNIX, and Windows, multiple-row fetch is used for scrollable cursors, if the data server supports multiple-row FETCH.

**DB2BaseDataSource.NO (2)**

Specifies that multiple-row fetch is not used.

**DB2BaseDataSource.NOT\_SET (0)**

Specifies that if the enableRowsetSupport property is not set:

- For IBM Data Server Driver for JDBC and SQLJ type 2 connectivity to DB2 for z/OS, multiple-row fetch is not used.
- For IBM Data Server Driver for JDBC and SQLJ type 4 connectivity to DB2 for z/OS, multiple-row fetch is used if useRowsetCursor is set to true.
- For connections to DB2 Database for Linux, UNIX, and Windows, multiple row fetch is used for scrollable cursors, if the data server supports multiple-row FETCH.

For IBM Data Server Driver for JDBC and SQLJ type 2 connectivity to DB2 for z/OS, multiple-row fetch is not compatible with progressive streaming. Therefore, if progressive streaming is used for a FETCH operation, multiple-row FETCH is not used.

**encryptionAlgorithm**

Specifies whether the IBM Data Server Driver for JDBC and SQLJ uses 56-bit DES (weak) encryption or 256-bit AES (strong) encryption. The data type of this property is int. Possible values are:

- 1 The driver uses 56-bit DES encryption.
- 2 The driver uses 256-bit AES encryption, if the database server supports it. 256-bit AES encryption is available for IBM Data Server Driver for JDBC and SQLJ type 4 connectivity only.

For AES encryption, you need an unrestricted policy file for JCE. For the IBM SDK for Java, the file is available at the following location:

<https://www14.software.ibm.com/webapp/iwm/web/preLogin.do?source=jcesdk>

The SDK for Java from Oracle might support AES encryption, but not DES encryption. When you use AES encryption with the SDK for Java from Oracle, the JCE Unlimited Strength Jurisdiction Policy File needs to be installed. That file is available from Oracle. If the JCE Unlimited Strength Jurisdiction Policy File is not found, a `java.security.InvalidKeyException` is thrown.

encryptionAlgorithm can be specified only if the securityMechanism value is ENCRYPTED\_PASSWORD\_SECURITY (7) or ENCRYPTED\_USER\_AND\_PASSWORD\_SECURITY (9).

**fullyMaterializeInputStreams**

Indicates whether streams are fully materialized before they are sent from the client to a data source. The data type of this property is boolean. The default is false.

If the value of `fullyMaterializeInputStreams` is true, the JDBC driver fully materialized the streams before sending them to the server.

#### **gssCredential**

For a data source that uses Kerberos security, specifies a delegated credential that is passed from another principal. The data type of this property is `org.ietf.jgss.GSSCredential`. Delegated credentials are used in multi-tier environments, such as when a client connects to WebSphere Application Server, which, in turn, connects to the data source. You obtain a value for this property from the client, by invoking the `GSSContext.getDelegCred` method. `GSSContext` is part of the IBM Java Generic Security Service (GSS) API. If you set this property, you also need to set the `Mechanism` and `KerberosServerPrincipal` properties.

This property is applicable only to IBM Data Server Driver for JDBC and SQLJ type 4 connectivity.

For more information on using Kerberos security with the IBM Data Server Driver for JDBC and SQLJ, see "Using Kerberos security under the IBM Data Server Driver for JDBC and SQLJ".

#### **kerberosServerPrincipal**

For a data source that uses Kerberos security, specifies the name that is used for the data source when it is registered with the Kerberos Key Distribution Center (KDC). The data type of this property is `String`.

This property is applicable only to IBM Data Server Driver for JDBC and SQLJ type 4 connectivity.

#### **pdqProperties**

Specifies properties that control the interaction between the IBM Data Server Driver for JDBC and SQLJ and the client optimization feature of `pureQuery`.

The data type of this property is `String`.

Set the `pdqProperties` property **only** if you are using the client optimization feature of `pureQuery`. See the Integrated Data Management Information Center for information about valid values for `pdqProperties`.

#### **readOnly**

Specifies whether the connection is read-only. The data type of this property is `boolean`. The default is `false`.

#### **resultSetHoldabilityForCatalogQueries**

Specifies whether cursors for queries that are executed on behalf of `DatabaseMetaData` methods remain open after a commit operation. The data type of this property is `int`.

When an application executes `DatabaseMetaData` methods, the IBM Data Server Driver for JDBC and SQLJ executes queries against the catalog of the target data source. By default, the holdability of those cursors is the same as the holdability of application cursors. To use different holdability for catalog queries, use the `resultSetHoldabilityForCatalogQueries` property. Possible values are:

##### **DB2BaseDataSource.HOLD\_CURSORS\_OVER\_COMMIT (1)**

Leave cursors for catalog queries open after a commit operation, regardless of the `resultSetHoldability` setting.

##### **DB2BaseDataSource.CLOSE\_CURSORS\_AT\_COMMIT (2)**

Close cursors for catalog queries after a commit operation, regardless of the `resultSetHoldability` setting.



**DB2BaseDataSource.NOT\_SET (0)**

Use the resultSetHoldability setting for catalog queries. This is the default value.

**returnAlias**

Specifies whether the JDBC driver returns rows for table aliases and synonyms for DatabaseMetaData methods that return table information, such as getTables. The data type of returnAlias is int. Possible values are:

- 0 Do not return rows for aliases or synonyms of tables in output from DatabaseMetaData methods that return table information.
- 1 For tables that have aliases or synonyms, return rows for aliases and synonyms of those tables, as well as rows for the tables, in output from DatabaseMetaData methods that return table information. This is the default.

**statementConcentrator**

Specifies whether the IBM Data Server Driver for JDBC and SQLJ uses the data source's statement concentrator functionality. The statement concentrator is the ability to bypass preparation of a statement when it is the same as a statement in the dynamic statement cache, except for literal values. Statement concentrator functionality applies only to SQL statements that have literals but no parameter markers. Possible values are:

**DB2BaseDataSource.STATEMENT\_CONCENTRATOR\_OFF (1)**

The IBM Data Server Driver for JDBC and SQLJ does not use the data source's statement concentrator functionality.

**DB2BaseDataSource.STATEMENT\_CONCENTRATOR\_WITH\_LITERALS (2)**

The IBM Data Server Driver for JDBC and SQLJ uses the data source's statement concentrator functionality.

**DB2BaseDataSource.STATEMENT\_CONCENTRATOR\_NOT\_SET (0)**

Enables the data server's default behavior for statement concentrator functionality. This is the default value.

For DB2 Database for Linux, UNIX, and Windows data sources that support statement concentrator functionality, the functionality is used if the STMT\_CONC configuration parameter is set to ON at the data source. Otherwise, statement concentrator functionality is not used.

For DB2 for z/OS data sources that support statement concentrator functionality, the functionality is not used if statementConcentrator is not set.

**streamBufferSize**

Specifies the size, in bytes, of the JDBC driver buffers for chunking LOB or XML data. The JDBC driver uses the streamBufferSize value whether or not it uses progressive streaming. The data type of streamBufferSize is int. The default is 1048576.

If the JDBC driver uses progressive streaming, LOB or XML data is materialized if it fits in the buffers, and the driver does not use the fullyMaterializeLobData property.

DB2 for z/OS Version 9.1 and later supports progressive streaming for LOBs and XML objects. DB2 Database for Linux, UNIX, and Windows Version 9.5 and later, and IBM Informix Version 11.50 and later support progressive streaming for LOBs.

### **supportsAsynchronousXARollback**

Specifies whether the IBM Data Server Driver for JDBC and SQLJ supports asynchronous XA rollback operations. The data type of this property is `int`. The default is `DB2BaseDataSource.NO` (2). If the application runs against a BEA WebLogic Server application server, set `supportsAsynchronousXARollback` to `DB2BaseDataSource.YES` (1).

### **sysSchema**

Specifies the schema of the shadow catalog tables or views that are searched when an application invokes a `DatabaseMetaData` method. The `sysSchema` property was formerly called `cliSchema`.

### **timeFormat**

Specifies:

- The format in which the `String` argument of the `PreparedStatement.setString` method against a `TIME` column must be specified.
- The format in which the result of the `ResultSet.getString` or `CallableStatement.getString` method against a `TIME` column is returned.

The data type of `timeFormat` is `int`.

Possible values of `timeFormat` are:

<b>Constant</b>	<b>Integer value</b>	<b>Format</b>
<code>com.ibm.db2.jcc.DB2BaseDataSource.ISO</code>	1	<i>hh:mm:ss</i>
<code>com.ibm.db2.jcc.DB2BaseDataSource.USA</code>	2	<i>hh:mm am</i> or <i>hh:mm pm</i>
<code>com.ibm.db2.jcc.DB2BaseDataSource.EUR</code>	3	<i>hh.mm.ss</i>
<code>com.ibm.db2.jcc.DB2BaseDataSource.JIS</code>	4	<i>hh:mm:ss</i>

The default is `com.ibm.db2.jcc.DB2BaseDataSource.ISO`.

### **timestampOutputType**

Specifies whether the IBM Data Server Driver for JDBC and SQLJ returns a `java.sql.Timestamp` object or a `com.ibm.db2.jcc.DBTimestamp` when the standard JDBC interfaces `ResultSet.getTimestamp`, `CallableStatement.getTimestamp`, `ResultSet.getObject`, or `CallableStatement.getObject` are called to return timestamp information.

Possible values are:

#### **DB2BaseDataSource.JDBC\_TIMESTAMP (1)**

The IBM Data Server Driver for JDBC and SQLJ returns `java.sql.Timestamp` objects from `ResultSet.getTimestamp`, `CallableStatement.getTimestamp`, `ResultSet.getObject`, or `CallableStatement.getObject` calls.

#### **DB2BaseDataSource.JCC\_DBTIMESTAMP (2)**

The IBM Data Server Driver for JDBC and SQLJ returns `com.ibm.db2.jcc.DBTimestamp` objects from `ResultSet.getTimestamp`, `CallableStatement.getTimestamp`, `ResultSet.getObject`, or `CallableStatement.getObject` calls.

#### **DB2BaseDataSource.NOT\_SET (0)**

This is the default behavior.

The behavior is the same as the behavior for `DB2BaseDataSource.JDBC_TIMESTAMP`.

**useCachedCursor**

Specifies whether the underlying cursor for PreparedStatement objects is cached and reused on subsequent executions of the PreparedStatement. The data type of useCachedCursor is boolean.

If useCachedCursor is set to true, the cursor for PreparedStatement objects is cached, which can improve performance. true is the default.

Set useCachedCursor to false if PreparedStatement objects access tables whose column types or lengths change between executions of those PreparedStatement objects.

**useIdentityValLocalForAutoGeneratedKeys**

Specifies whether the IBM Data Server Driver for JDBC and SQLJ uses only the SQL built-in function IDENTITY\_VAL\_LOCAL to determine automatically generated key values. The data type of this property is boolean. Possible values are:

**true** Specifies that the IBM Data Server Driver for JDBC and SQLJ always uses the SQL built-in function IDENTITY\_VAL\_LOCAL to determine automatically generated key values. The driver uses IDENTITY\_VAL\_LOCAL even if it is possible to use SELECT FROM INSERT.

Specify true if the target data server supports SELECT FROM INSERT, but the target objects do not. For example, SELECT FROM INSERT is not valid for a table on which a trigger is defined.

**false** Specifies that the IBM Data Server Driver for JDBC and SQLJ determines whether to use SELECT FROM INSERT or IDENTITY\_VAL\_LOCAL to determine automatically generated keys. false is the default.

**useJDBC4ColumnNameAndLabelSemantics**

Specifies how the IBM Data Server Driver for JDBC and SQLJ handles column labels in ResultSetMetaData.getColumnName, ResultSetMetaData.getColumnLabel, and ResultSet.findColumn method calls.

Possible values are:

**DB2BaseDataSource.YES (1)**

The IBM Data Server Driver for JDBC and SQLJ uses the following rules, which conform to the JDBC 4.0 specification, to determine the value that ResultSetMetaData.getColumnName, ResultSetMetaData.getColumnLabel, and ResultSet.findColumn return:

- The column name that is returned by ResultSetMetaData.getColumnName is its name from the database.
- The column label that is returned by ResultSetMetaData.getColumnLabel is the label that is specified with the SQL AS clause. If the SQL AS clause is not specified, the label is the name of the column.
- ResultSet.findColumn takes the label for the column, as specified with the SQL AS clause, as input. If the SQL AS clause was not specified, the label is the column name.
- The IBM Data Server Driver for JDBC and SQLJ does not use a column label that is assigned by the SQL LABEL ON statement.

These rules apply to IBM Data Server Driver for JDBC and SQLJ version 3.50 and later, for connections to the following database systems:

- DB2 for z/OS Version 8 or later
- DB2 Database for Linux, UNIX, and Windows Version 8.1 or later
- DB2 UDB for iSeries® V5R3 or later

For earlier versions of the driver or the database systems, the rules for a useJDBC4ColumnNameAndLabelSemantics value of DB2BaseDataSource.NO apply, even if useJDBC4ColumnNameAndLabelSemantics is set to DB2BaseDataSource.YES.

#### **DB2BaseDataSource.NO (2)**

The IBM Data Server Driver for JDBC and SQLJ uses the following rules to determine the values that ResultSetMetaData.getColumnNames, ResultSetMetaData.getColumnLabels, and ResultSet.findColumn return:

If the data source does not support the LABEL ON statement, or the source column is not defined with the LABEL ON statement:

- The value that is returned by ResultSetMetaData.getColumnNames is its name from the database, if no SQL AS clause is specified. If the SQL AS clause is specified, the value that is returned is the column label.
- The value that is returned by ResultSetMetaData.getColumnLabels is the label that is specified with the SQL AS clause. If the SQL AS clause is not specified, the value that is returned is the name of the column.
- ResultSet.findColumn takes the column name as input.

If the source column is defined with the LABEL ON statement:

- The value that is returned by ResultSetMetaData.getColumnNames is the column name from the database, if no SQL AS clause is specified. If the SQL AS clause is specified, the value that is returned is the column label that is specified in the AS clause.
- The value that is returned by ResultSetMetaData.getColumnLabels is the label that is specified in the LABEL ON statement.
- ResultSet.findColumn takes the column name as input.

These rules conform to the behavior of the IBM Data Server Driver for JDBC and SQLJ before Version 3.50.

#### **DB2BaseDataSource.NOT\_SET (0)**

This is the default behavior.

For the IBM Data Server Driver for JDBC and SQLJ version 3.50 and earlier, the default behavior for useJDBC4ColumnNameAndLabelSemantics is the same as the behavior for DB2BaseDataSource.NO.

For the IBM Data Server Driver for JDBC and SQLJ version 4.0 and later:

- The default behavior for useJDBC4ColumnNameAndLabelSemantics is the same as the behavior for DB2BaseDataSource.YES, for connections to the following database systems:
  - DB2 for z/OS Version 8 or later
  - DB2 Database for Linux, UNIX, and Windows Version 8.1 or later
  - DB2 UDB for iSeries V5R3 or later
- For connections to earlier versions of these database systems, the default behavior for useJDBC4ColumnNameAndLabelSemantics is DB2BaseDataSource.NO.

### **xmlFormat**

Specifies the format that is used to send XML data to the data server or retrieve XML data from the data server. The XML format cannot be modified after a connection is established. Possible values are:

**com.ibm.db2.jcc.DB2BaseDataSource.XML\_FORMAT\_NOT\_SET (-Integer.MAX\_VALUE)**

Specifies that the default XML format is used. For connections to DB2 for z/OS data servers, the default is binary XML format, if the data server supports it. For connections to DB2 Database for Linux, UNIX, and Windows data servers, the default is textual XML format.

**com.ibm.db2.jcc.DB2BaseDataSource.XML\_FORMAT\_TEXTUAL (0)**  
Specifies that the XML textual format is used.

**com.ibm.db2.jcc.DB2BaseDataSource.XML\_FORMAT\_BINARY (1)**  
Specifies that the binary XML format is used.

When binary XML is used, the XML data that is passed to the IBM Data Server Driver for JDBC and SQLJ cannot refer to external entities, internal entities, or internal DTDs. External DTDs are supported only if those DTDs were previously registered in the data source.

### **com.ibm.db2.jcc.DB2ConnectionPoolDataSource.maxStatements**

Controls an internal statement cache that is associated with a PooledConnection. The data type of this property is int. Possible values are:

#### **positive integer**

Enables the internal statement cache for a PooledConnection, and specifies the number of statements that the IBM Data Server Driver for JDBC and SQLJ keeps open in the cache.

#### **0 or negative integer**

Disables internal statement caching for the PooledConnection. 0 is the default.

maxStatements controls the internal statement cache that is associated with a PooledConnection only when the PooledConnection object is created.

maxStatements has no effect on caching in an already existing PooledConnection object.

maxStatements applies only to IBM Data Server Driver for JDBC and SQLJ type 2 connectivity on DB2 for z/OS, and to IBM Data Server Driver for JDBC and SQLJ type 4 connectivity.

## **Common IBM Data Server Driver for JDBC and SQLJ properties for DB2 for z/OS and IBM Informix**

Some of the IBM Data Server Driver for JDBC and SQLJ properties apply to IBM Informix and DB2 for z/OS database servers.

Properties that apply to IBM Informix and DB2 for z/OS are:

### **enableConnectionConcentrator**

Indicates whether the connection concentrator function of the IBM Data Server Driver for JDBC and SQLJ is enabled.

The data type of enableConnectionConcentrator is boolean. The default is false.

enableConnectionConcentrator applies only to IBM Data Server Driver for JDBC and SQLJ type 4 connectivity.

### **keepDynamic**

Specifies whether the data source keeps already prepared dynamic SQL statements in the dynamic statement cache after commit points so that those prepared statements can be reused. The data type of this property is int. Valid values are `DB2BaseDataSource.YES` (1) and `DB2BaseDataSource.NO` (2).

If the `keepDynamic` property is not specified, the `keepDynamic` value is `DB2BaseDataSource.NOT_SET` (0). If the connection is to a DB2 for z/OS server, caching of dynamic statements for a connection is not done if the property is not set. If the connection is to an IBM Informix data source, caching of dynamic statements for a connection is done if the property is not set.

`keepDynamic` is used with the `DB2Binder -keepdynamic` option. The `keepDynamic` property value that is specified must match the `-keepdynamic` value that was specified when `DB2Binder` was run.

For a DB2 for z/OS database server, dynamic statement caching can be done only if the EDM dynamic statement cache is enabled on the data source. The `CACHEDYN` subsystem parameter must be set to `DB2BaseDataSource.YES` to enable the dynamic statement cache.

### **maxTransportObjects**

Specifies the maximum number of transport objects that can be used for all connections with the associated `DataSource` object. The IBM Data Server Driver for JDBC and SQLJ uses transport objects and a global transport objects pool to support the connection concentrator and Sysplex workload balancing. There is one transport object for each physical connection to the data source.

The data type of this property is int.

The `maxTransportObjects` value is ignored if the `enableConnectionConcentrator` or `enableSysplexWLB` properties are not set to enable the use of the connection concentrator or Sysplex workload balancing.

If the `maxTransportObjects` value has not been reached, and a transport object is not available in the global transport objects pool, the pool creates a new transport object. If the `maxTransportObjects` value has been reached, the application waits for the amount of time that is specified by the `db2.jcc.maxTransportObjectWaitTime` configuration property. After that amount of time has elapsed, if there is still no available transport object in the pool, the pool throws an `SQLException`.

`maxTransportObjects` does **not** override the `db2.jcc.maxTransportObjects` configuration property. `maxTransportObjects` has no effect on connections from other `DataSource` objects. If the `maxTransportObjects` value is larger than the `db2.jcc.maxTransportObjects` value, `maxTransportObjects` does not increase the `db2.jcc.maxTransportObjects` value.

The default value for `maxTransportObjects` is -1, which means that the number of transport objects for the `DataSource` is limited only by the `db2.jcc.maxTransportObjects` value for the driver.

## **Common IBM Data Server Driver for JDBC and SQLJ properties for IBM Informix and DB2 Database for Linux, UNIX, and Windows**

Some of the IBM Data Server Driver for JDBC and SQLJ properties apply to IBM Informix and DB2 Database for Linux, UNIX, and Windows database servers.



Properties that apply to IBM Informix and DB2 Database for Linux, UNIX, and Windows are:

**currentLockTimeout**

Specifies whether DB2 Database for Linux, UNIX, and Windows servers wait for a lock when the lock cannot be obtained immediately. The data type of this property is int. Possible values are:

*integer* Wait for *integer seconds*. *integer* is between -1 and 32767, inclusive.

**LOCK\_TIMEOUT\_NO\_WAIT**

Do not wait for a lock. This is the default.

**LOCK\_TIMEOUT\_WAIT\_INDEFINITELY**

Wait indefinitely for a lock.

**LOCK\_TIMEOUT\_NOT\_SET**

Use the default for the data source.

## IBM Data Server Driver for JDBC and SQLJ properties for DB2 Database for Linux, UNIX, and Windows

Some of the IBM Data Server Driver for JDBC and SQLJ properties apply only to DB2 Database for Linux, UNIX, and Windows servers.

Those properties are:

**connectNode**

Specifies the target database partition server that an application connects to. The data type of this property is int. The value can be between 0 and 999. The default is database partition server that is defined with port 0. connectNode applies to IBM Data Server Driver for JDBC and SQLJ type 4 connectivity to DB2 Database for Linux, UNIX, and Windows servers only.

**currentExplainSnapshot**

Specifies the value for the CURRENT EXPLAIN SNAPSHOT special register. The CURRENT EXPLAIN SNAPSHOT special register enables and disables the Explain snapshot facility. The data type of this property is String. The maximum length is eight bytes. This property applies only to connections to data sources that support the CURRENT EXPLAIN SNAPSHOT special register, such as DB2 Database for Linux, UNIX, and Windows.

**currentQueryOptimization**

Specifies a value that controls the class of query optimization that is performed by the database manager when it binds dynamic SQL statements. The data type of this property is int. The possible values of currentQueryOptimization are:

- 0 Specifies that a minimal amount of optimization is performed to generate an access plan. This class is most suitable for simple dynamic SQL access to well-indexed tables.
- 1 Specifies that optimization roughly comparable to DB2 Database for Linux, UNIX, and Windows Version 1 is performed to generate an access plan.
- 2 Specifies a level of optimization higher than that of DB2 Database for Linux, UNIX, and Windows Version 1, but at significantly less optimization cost than levels 3 and above, especially for very complex queries.

- 3 Specifies that a moderate amount of optimization is performed to generate an access plan.
- 5 Specifies a significant amount of optimization is performed to generate an access plan. For complex dynamic SQL queries, heuristic rules are used to limit the amount of time spent selecting an access plan. Where possible, queries will use materialized query tables instead of the underlying base tables.
- 7 Specifies a significant amount of optimization is performed to generate an access plan. This value is similar to 5 but without the heuristic rules.
- 9 Specifies the maximum amount of optimization is performed to generate an access plan. This can greatly expand the number of possible access plans that are evaluated. This class should be used to determine if a better access plan can be generated for very complex and very long-running queries using large tables. Explain and performance measurements can be used to verify that a better plan has been generated.

**optimizationProfile**

Specifies an optimization profile that is used during SQL optimization. The data type of this property is String. The optimizationProfile value is used to set the OPTIMIZATION PROFILE special register. The default is null.

optimizationProfile applies to DB2 Database for Linux, UNIX, and Windows servers only.

**optimizationProfileToFlush**

Specifies the name of an optimization profile that is to be removed from the optimization profile cache. The data type of this property is String. The default is null.

**plugin**

The name of a client-side JDBC security plug-in. This property has the Object type and contains a new instance of the JDBC security plug-in method.

**pluginName**

The name of a server-side security plug-in module.

**retryWithAlternativeSecurityMechanism**

Specifies whether the IBM Data Server Driver for JDBC and SQLJ retries a connection with an alternative security mechanism if the security mechanism that is specified by property securityMechanism is not supported by the data source. The data type of this property is int. Possible values are:

**com.ibm.db2.jcc.DB2BaseDataSource.YES (1)**

Retry the connection using an alternative security mechanism. The IBM Data Server Driver for JDBC and SQLJ issues warning code +4222 and retries the connection with the most secure available security mechanism.

**com.ibm.db2.jcc.DB2BaseDataSource.NO (2) or  
com.ibm.db2.jcc.DB2BaseDataSource.NOT\_SET (0)**

Do not retry the connection using an alternative security mechanism.

retryWithAlternativeSecurityMechanism applies to IBM Data Server Driver for JDBC and SQLJ type 4 connectivity connections to DB2 Database for Linux, UNIX, and Windows only.



**useTransactionRedirect**

Specifies whether the DB2 system directs SQL statements to different database partitions for better performance. The data type of this property is boolean. The default is false.

This property is applicable only under the following conditions:

- The connection is to a DB2 Database for Linux, UNIX, and Windows server that uses a partitioned database environment.
- The partitioning key remains constant throughout a transaction.

If useTransactionRedirect is true, the IBM Data Server Driver for JDBC and SQLJ sends connection requests to the DPF node that contains the target data of the first directable statement in the transaction. DB2 Database for Linux, UNIX, and Windows then directs the SQL statement to different partitions as needed.

## IBM Data Server Driver for JDBC and SQLJ properties for DB2 for z/OS

Some of the IBM Data Server Driver for JDBC and SQLJ properties apply only to DB2 for z/OS servers.

Those properties are:

**accountingInterval**

Specifies whether DB2 accounting records are produced at commit points or on termination of the physical connection to the data source. The data type of this property is String.

If the value of accountingInterval is "COMMIT", and there are no open, held cursors, DB2 writes an accounting record each time that the application commits work. If the value of accountingInterval is "COMMIT", and the application performs a commit operation while a held cursor is open, the accounting interval spans that commit point and ends at the next valid accounting interval end point. If the value of accountingInterval is not "COMMIT", accounting records are produced on termination of the physical connection to the data source.

The accountingInterval property sets the *accounting-interval* parameter for an underlying RRSF signon call. If the value of subsystem parameter ACCUMACC is not NO, the ACCUMACC value overrides the accountingInterval setting.

accountingInterval applies only to IBM Data Server Driver for JDBC and SQLJ type 2 connectivity on DB2 for z/OS. accountingInterval is not applicable to connections under CICS or IMS, or for Java stored procedures.

The accountingInterval property overrides the db2.jcc.accountingInterval configuration property.

**charOutputSize**

Specifies the maximum number of bytes to use for INOUT or OUT stored procedure parameters that are registered as Types.CHAR charOutputSize applies only to IBM Data Server Driver for JDBC and SQLJ type 2 connectivity to DB2 for z/OS database servers.

Because DESCRIBE information for stored procedure INOUT and OUT parameters is not available at run time, by default, the IBM Data Server Driver for JDBC and SQLJ sets the maximum length of each character INOUT or OUT

parameter to 32767. For stored procedures with many Types.CHAR parameters, this maximum setting can result in allocation of much more storage than is necessary.

To use storage more efficiently, set charOutputSize to the largest expected length for any Types.CHAR INOUT or OUT parameter.

charOutputSize has no effect on INOUT or OUT parameters that are registered as Types.VARCHAR or Types.LONGVARCHAR. The driver uses the default length of 32767 for Types.VARCHAR and Types.LONGVARCHAR parameters.

The value that you choose for charOutputSize needs to take into account the possibility of expansion during character conversion. Because the IBM Data Server Driver for JDBC and SQLJ has no information about the server-side CCSID that is used for output parameter values, the driver requests the stored procedure output data in UTF-8 Unicode. The charOutputSize value needs to be the maximum number of bytes that are needed after the parameter value is converted to UTF-8 Unicode. UTF-8 Unicode characters can require up to three bytes. (The euro symbol is an example of a three-byte UTF-8 character.) To ensure that the value of charOutputSize is large enough, if you have no information about the output data, set charOutputSize to three times the defined length of the largest CHAR parameter.

#### **clientUser**

Specifies the current client user name for the connection. This information is for client accounting purposes. Unlike the JDBC connection user name, this value can change during a connection. For a DB2 for z/OS server, the maximum length is 16 bytes.

This property applies only to IBM Data Server Driver for JDBC and SQLJ type 2 connectivity on DB2 for z/OS.

#### **clientWorkstation**

Specifies the workstation name for the current client for the connection. This information is for client accounting purposes. This value can change during a connection. The data type of this property is String. For a DB2 for z/OS server, the maximum length is 18 bytes. A Java empty string ("") is valid for this value, but a Java null value is not valid.

This property applies only to IBM Data Server Driver for JDBC and SQLJ type 2 connectivity on DB2 for z/OS.

#### **currentSQLID**

Specifies:

- The authorization ID that is used for authorization checking on dynamically prepared CREATE, GRANT, and REVOKE SQL statements.
- The owner of a table space, database, storage group, or synonym that is created by a dynamically issued CREATE statement.
- The implicit qualifier of all table, view, alias, and index names specified in dynamic SQL statements.

currentSQLID sets the value in the CURRENT SQLID special register on a DB2 for z/OS server. If the currentSQLID property is not set, the default schema name is the value in the CURRENT SQLID special register.

#### **enableMultiRowInsertSupport**

Specifies whether the IBM Data Server Driver for JDBC and SQLJ uses multi-row INSERT for batched INSERT or MERGE operations, when the target data server is a DB2 for z/OS server that supports multi-row INSERT. The

batch operations must be PreparedStatement calls with parameter markers. The data type of this property is boolean. The default is true.

The enableMultiRowInsertSupport value cannot be changed for the duration of a connection. enableMultiRowInsertSupport must be set to false if INSERT FROM SELECT statements are executed in a batch. Otherwise, the driver throws a BatchUpdateException.

#### **jdbcCollection**

Specifies the collection ID for the packages that are used by an instance of the IBM Data Server Driver for JDBC and SQLJ at run time. The data type of jdbcCollection is String. The default is NULLID.

This property is used with the DB2Binder -collection option. The DB2Binder utility must have previously bound IBM Data Server Driver for JDBC and SQLJ packages at the server using a -collection value that matches the jdbcCollection value.

The jdbcCollection setting does not determine the collection that is used for SQLJ applications. For SQLJ, the collection is determined by the -collection option of the SQLJ customizer.

jdbcCollection does not apply to IBM Data Server Driver for JDBC and SQLJ type 2 connectivity on DB2 for z/OS.

#### **maxRowsetSize**

Specifies the maximum number of bytes that are used for rowset buffering for each statement, when the IBM Data Server Driver for JDBC and SQLJ uses multiple-row FETCH for cursors. The data type of this property is int. The default is 32767.

maxRowsetSize applies only to IBM Data Server Driver for JDBC and SQLJ type 2 connectivity on DB2 for z/OS.

#### **reportLongTypes**

Specifies whether DatabaseMetaData methods report LONG VARCHAR and LONG VARGRAPHIC column data types as long data types. The data type of this property is short. Possible values are:

**com.ibm.db2.jcc.DB2BaseDataSource.NO (2) or**

**com.ibm.db2.jcc.DB2BaseDataSource.NOT\_SET (0)**

Specifies that DatabaseMetaData methods that return information about a LONG VARCHAR or LONG VARGRAPHIC column return java.sql.Types.VARCHAR in the DATA\_TYPE column and VARCHAR or VARGRAPHIC in the TYPE\_NAME column of the result set. This is the default for DB2 for z/OS Version 9 or later.

**com.ibm.db2.jcc.DB2BaseDataSource.YES (1)**

Specifies that DatabaseMetaData methods that return information about a LONG VARCHAR or LONG VARGRAPHIC column return java.sql.Types.LONGVARCHAR in the DATA\_TYPE column and LONG VARCHAR or LONG VARGRAPHIC in the TYPE\_NAME column of the result set.

#### **sendCharInputsUTF8**

Specifies whether the IBM Data Server Driver for JDBC and SQLJ converts character input data to the CCSID of the DB2 for z/OS database server, or sends the data in UTF-8 encoding for conversion by the database server. sendCharInputsUTF8 applies to IBM Data Server Driver for JDBC and SQLJ type 2 connectivity to DB2 for z/OS database servers only. The data type of

this property is int. If this property is also set at the driver level (db2.jcc.sendCharInputsUTF8), this value overrides the driver-level value.

Possible values are:

**com.ibm.db2.jcc.DB2BaseDataSource.NO (2)**

Specifies that the IBM Data Server Driver for JDBC and SQLJ converts character input data to the target encoding before the data is sent to the DB2 for z/OS database server.

com.ibm.db2.jcc.DB2BaseDataSource.NO is the default.

**com.ibm.db2.jcc.DB2BaseDataSource.YES (1)**

Specifies that the IBM Data Server Driver for JDBC and SQLJ sends character input data to the DB2 for z/OS database server in UTF-8 encoding. The database server converts the data from UTF-8 encoding to the target CCSID.

Specify com.ibm.db2.jcc.DB2BaseDataSource.YES only if conversion to the target CCSID by the SDK for Java causes character conversion problems. The most common problem occurs when you use IBM Data Server Driver for JDBC and SQLJ type 2 connectivity to insert a Unicode line feed character (U+000A) into a table column that has CCSID 37, and then retrieve that data from a non-z/OS client. If the SDK for Java does the conversion during insertion of the character into the column, the line feed character is converted to the EBCDIC new line character X'15'. However, during retrieval, some SDKs for Java on operating systems other than z/OS convert the X'15' character to the Unicode next line character (U+0085) instead of the line feed character (U+000A). The next line character causes unexpected behavior for some XML parsers. If you set sendCharInputsUTF8 to com.ibm.db2.jcc.DB2BaseDataSource.YES, the DB2 for z/OS database server converts the U+000A character to the EBCDIC line feed character X'25' during insertion into the column, so the character is always retrieved as a line feed character.

Conversion of data to the target CCSID on the database server might cause the IBM Data Server Driver for JDBC and SQLJ to use more memory than conversion by the driver. The driver allocates memory for conversion of character data from the source encoding to the encoding of the data that it sends to the database server. The amount of space that the driver allocates for character data that is sent to a table column is based on the maximum possible length of the data. UTF-8 data can require up to three bytes for each character. Therefore, if the driver sends UTF-8 data to the database server, the driver needs to allocate three times the maximum number of characters in the input data. If the driver does the conversion, and the target CCSID is a single-byte CCSID, the driver needs to allocate only the maximum number of characters in the input data.

**sessionTimeZone**

Specifies the setting for the CURRENT SESSION TIME ZONE special register. The data type of this property is String.

The sessionTimeZone value is a time zone value that is in the format of *sth:tm*. *s* is the sign, *th* is the time zone hour, and *tm* is time zone minutes. The range of valid values is -12:59 to +14:00.

**sqljEnableClassLoaderSpecificProfiles**

Specifies whether the IBM Data Server Driver for JDBC and SQLJ allows using and loading of SQLJ profiles with the same Java name in multiple J2EE

application (.ear) files. The data type of this property is boolean. The default is `false`. `sqljEnableClassLoaderSpecificProfiles` is a `DataSource` property. This property is primarily intended for use with WebSphere Application Server.

#### **ssid**

Specifies the name of the local DB2 for z/OS subsystem to which a connection is established using IBM Data Server Driver for JDBC and SQLJ type 2 connectivity on DB2 for z/OS. The data type of this property is `String`.

The `ssid` property overrides the `db2.jcc.ssid` configuration property.

`ssid` can be the subsystem name for a local subsystem or a group attachment name or subgroup attachment name.

Specification of a single local subsystem name allows more than one subsystem on a single LPAR to be accessed as a local subsystem for connections that use IBM Data Server Driver for JDBC and SQLJ type 2 connectivity.

Specification of a group attachment name or subgroup attachment name allows failover processing to occur if a data sharing group member fails. If the DB2 subsystem to which an application is connected fails, the connection terminates. However, when new connections use that group attachment name or subgroup attachment name, DB2 for z/OS uses group or subgroup attachment processing to find an active DB2 subsystem to which to connect.

`ssid` applies only to IBM Data Server Driver for JDBC and SQLJ type 2 connectivity to DB2 for z/OS.

#### **useRowsetCursor**

Specifies whether the IBM Data Server Driver for JDBC and SQLJ always uses multiple-row `FETCH` for scrollable cursors if the data source supports multiple-row `FETCH`. The data type of this property is boolean.

This property applies only to IBM Data Server Driver for JDBC and SQLJ type 4 connectivity, or to IBM Data Server Driver for JDBC and SQLJ type 2 connectivity to DB2 for z/OS. If the `enableRowsetSupport` property is not set, the default for `useRowsetCursor` is `true`. If the `enableRowsetSupport` property is set, the `useRowsetCursor` property is not used.

Applications that use the JDBC 1 technique for performing positioned update or delete operations should set `useRowsetCursor` to `false`. Those applications do not operate properly if the IBM Data Server Driver for JDBC and SQLJ uses multiple-row `FETCH`.

## **IBM Data Server Driver for JDBC and SQLJ properties for IBM Informix**

Some of the IBM Data Server Driver for JDBC and SQLJ properties apply only to IBM Informix databases. Those properties correspond to IBM Informix environment variables.

Properties that are shown in uppercase characters in the following information must be specified in uppercase. For those properties, `getXXX` and `setXXX` methods are formed by prepending the uppercase property name with `get` or `set`. For example:

```
boolean dbDate = DB2BaseDataSource.getDBDATE();
```

The IBM Informix-specific properties are:

#### **DBANSIWARN**

Specifies whether the IBM Data Server Driver for JDBC and SQLJ instructs the

IBM Informix database to return an SQLWarning to the application if an SQL statement does not use ANSI-standard syntax. The data type of this property is boolean. Possible values are:

**false or 0**

Do not send a value to the IBM Informix database that instructs the database to return an SQLWarning to the application if an SQL statement does not use ANSI-standard syntax. This is the default.

**true or 1**

Send a value to the IBM Informix database that instructs the database to return an SQLWarning to the application if an SQL statement does not use ANSI-standard syntax.

You can use the DBANSIWARN IBM Data Server Driver for JDBC and SQLJ property to set the DBANSIWARN IBM Informix property, but you cannot use the DBANSIWARN IBM Data Server Driver for JDBC and SQLJ property to reset the DBANSIWARN IBM Informix property.

**DBDATE**

Specifies the end-user format of DATE values. The data type of this property is String. Possible values are in the description of the DBDATE environment variable in *IBM Informix Guide to SQL: Reference*.

The default value is "Y4MD-".

**DBPATH**

Specifies a colon-separated list of values that identify the database servers that contain databases. The data type of this property is String. Each value can be:

- A full path name
- A relative path name
- The server name of an IBM Informix database server
- A server name and full path name

The default is ".".

**DBSPACETEMP**

Specifies a comma-separated or colon-separated list of existing dbspaces in which temporary tables are placed. The data type of this property is String.

If this property is not set, no value is sent to the server. The value for the DBSPACETEMP environment variable is used.

**DBTEMP**

Specifies the full path name of an existing directory in which temporary files and temporary tables are placed. The data type of this property is String. The default is "/tmp".

**DBUPSPACE**

Specifies the maximum amount of system disk space and maximum amount of memory, in kilobytes, that the UPDATE STATISTICS statement can use when it constructs multiple column distributions simultaneously. The data type of this property is String.

The format of DBUPSPACE is "*maximum-disk-space:maximum-memory*".

If this property is not set, no value is sent to the server. The value for the DBUPSPACE environment variable is used.

**DB\_LOCALE**

Specifies the database locale, which the database server uses to process



locale-sensitive data. The data type of this property is String. Valid values are the same as valid values for the DB\_LOCALE environment variable. The default value is null.

#### **DELIMITIDENT**

Specifies whether delimited SQL identifiers can be used in an application. The data type of this property is boolean. Possible values are:

- false** The application cannot contain delimited SQL identifiers. Double quotation marks (") or single quotation marks (') delimit literal strings. This is the default.
- true** The application can contain delimited SQL identifiers. Delimited SQL identifiers must be enclosed in double quotation marks ("). Single quotation marks (') delimit literal strings.

#### **IFX\_DIRECTIVES**

Specifies whether the optimizer allows query optimization directives from within a query. The data type of this property is String. Possible values are:

**"1" or "ON"**  
Optimization directives are accepted.

**"0" or "OFF"**  
Optimization directives are not accepted.

If this property is not set, no value is sent to the server. The value for the IFX\_DIRECTIVES environment variable is used.

#### **IFX\_EXTDIRECTIVES**

Specifies whether the optimizer allows external query optimization directives from the sysdirectives system catalog table to be applied to queries in existing applications. Possible values are:

**"1" or "ON"**  
External query optimization directives are accepted.

**"0" or "OFF"**  
External query optimization are not accepted.

If this property is not set, no value is sent to the server. The value for the IFX\_EXTDIRECTIVES environment variable is used.

#### **IFX\_UPDESC**

Specifies whether a DESCRIBE of an UPDATE statement is permitted. The data type of this property is String.

Any non-null value indicates that a DESCRIBE of an UPDATE statement is permitted. The default is "1".

#### **IFX\_XASTDCOMPLIANCE\_XAEND**

Specifies whether global transactions are freed only after an explicit rollback, or after any rollback. The data type of this property is String. Possible values are:

**"0"** Global transactions are freed only after an explicit rollback. This behavior conforms to the X/Open XA standard.

**"1"** Global transactions are freed after any rollback.

If this property is not set, no value is sent to the server. The value for the IFX\_XASTDCOMPLIANCE\_XAEND environment variable is used.

#### **INFORMIXOPCACHE**

Specifies the size of the memory cache, in kilobytes, for the staging-area



blob space of the client application. The data type of this property is String. A value of "0" indicates that the cache is not used.

If this property is not set, no value is sent to the server. The value for the INFORMIXOPCACHE environment variable is used.

#### **INFORMIXSTACKSIZE**

Specifies the stack size, in kilobytes, that the database server uses for the primary thread of a client session. The data type of this property is String.

If this property is not set, no value is sent to the server. The value for the INFORMIXSTACKSIZE environment variable is used.

#### **NODEFDAC**

Specifies whether the database server prevents default table privileges (SELECT, INSERT, UPDATE, and DELETE) from being granted to PUBLIC when a new table is created during the current session, in a database that is not ANSI compliant. The data type of this property is String. Possible values are:

**"yes"** The database server prevents default table privileges from being granted to PUBLIC when a new table is created during the current session, in a database that is not ANSI compliant.

**"no"** The database server does not prevent default table privileges from being granted to PUBLIC when a new table is created during the current session, in a database that is not ANSI compliant. This is the default.

#### **OPTCOMPIND**

Specifies the preferred method for performing a join operation on an ordered pair of tables. The data type of this property is String. Possible values are:

**"0"** The optimizer chooses a nested-loop join, where possible, over a sort-merge join or a hash join.

**"1"** When the isolation level is repeatable read, the optimizer chooses a nested-loop join, where possible, over a sort-merge join or a hash join. When the isolation level is not repeatable read, the optimizer chooses a join method based on costs.

**"2"** The optimizer chooses a join method based on costs, regardless of the transaction isolation mode.

If this property is not set, no value is sent to the server. The value for the OPTCOMPIND environment variable is used.

#### **OPTOFC**

Specifies whether to enable optimize-OPEN-FETCH-CLOSE functionality. The data type of this property is String. Possible values are:

**"0"** Disable optimize-OPEN-FETCH-CLOSE functionality for all threads of applications.

**"1"** Enable optimize-OPEN-FETCH-CLOSE functionality for all cursors in all threads of applications.

If this property is not set, no value is sent to the server. The value for the OPTOFC environment variable is used.

#### **PDQPRIORITY**

Specifies the degree of parallelism that the database server uses. The

PDQPRIORITY value affects how the database server allocates resources, including memory, processors, and disk reads. The data type of this property is String. Possible values are:

**"HIGH"**

When the database server allocates resources among all users, it gives as many resources as possible to queries.

**"LOW" or "1"**

The database server fetches values from fragmented tables in parallel.

**"OFF" or "0"**

Parallel processing is disabled.

If this property is not set, no value is sent to the server. The value for the PDQPRIORITY environment variable is used.

**PSORT\_DBTEMP**

Specifies the full path name of a directory in which the database server writes temporary files that are used for a sort operation. The data type of this property is String.

If this property is not set, no value is sent to the server. The value for the PSORT\_DBTEMP environment variable is used.

**PSORT\_NPROCS**

Specifies the maximum number of threads that the database server can use to sort a query. The data type of this property is String. The maximum value of PSORT\_NPROCS is "10".

If this property is not set, no value is sent to the server. The value for the PSORT\_NPROCS environment variable is used.

**STMT\_CACHE**

Specifies whether the shared-statement cache is enabled. The data type of this property is String. Possible values are:

**"0"** The shared-statement cache is disabled.

**"1"** A 512 KB shared-statement cache is enabled.

If this property is not set, no value is sent to the server. The value for the STMT\_CACHE environment variable is used.

**dumpPool**

Specifies the types of statistics on global transport pool events that are written, in addition to summary statistics. The global transport pool is used for the connection concentrator and Sysplex workload balancing.

The data type of dumpPool is int. dumpPoolStatisticsOnSchedule and dumpPoolStatisticsOnScheduleFile must also be set for writing statistics before any statistics are written.

You can specify one or more of the following types of statistics with the db2.jcc.dumpPool property:

- DUMP\_REMOVE\_OBJECT (hexadecimal: X'01', decimal: 1)
- DUMP\_GET\_OBJECT (hexadecimal: X'02', decimal: 2)
- DUMP\_WAIT\_OBJECT (hexadecimal: X'04', decimal: 4)
- DUMP\_SET\_AVAILABLE\_OBJECT (hexadecimal: X'08', decimal: 8)
- DUMP\_CREATE\_OBJECT (hexadecimal: X'10', decimal: 16)
- DUMP\_SYSPLEX\_MSG (hexadecimal: X'20', decimal: 32)
- DUMP\_POOL\_ERROR (hexadecimal: X'80', decimal: 128)

To trace more than one type of event, add the values for the types of events that you want to trace. For example, suppose that you want to trace DUMP\_GET\_OBJECT and DUMP\_CREATE\_OBJECT events. The numeric equivalents of these values are 2 and 16, so you specify 18 for the dumpPool value.

The default is 0, which means that only summary statistics for the global transport pool are written.

This property does not have a setXXX or a getXXX method.

#### **dumpPoolStatisticsOnSchedule**

Specifies how often, in seconds, global transport pool statistics are written to the file that is specified by dumpPoolStatisticsOnScheduleFile. The global transport object pool is used for the connection concentrator and Sysplex workload balancing.

The default is -1. -1 means that global transport pool statistics are not written.

This property does not have a setXXX or a getXXX method.

#### **dumpPoolStatisticsOnScheduleFile**

Specifies the name of the file to which global transport pool statistics are written. The global transport pool is used for the connection concentrator and Sysplex workload balancing.

If dumpPoolStatisticsOnScheduleFile is not specified, global transport pool statistics are not written.

This property does not have a setXXX or a getXXX method.

#### **maxTransportObjectIdleTime**

Specifies the amount of time in seconds that an unused transport object stays in a global transport object pool before it can be deleted from the pool. Transport objects are used for the connection concentrator and Sysplex workload balancing.

The default value for maxTransportObjectIdleTime is 60. Setting maxTransportObjectIdleTime to a value less than 0 causes unused transport objects to be deleted from the pool immediately. Doing this is **not** recommended because it can cause severe performance degradation.

This property does not have a setXXX or a getXXX method.

#### **maxTransportObjectWaitTime**

Specifies the maximum amount of time in seconds that an application waits for a transport object if the maxTransportObjects value has been reached. Transport objects are used for the connection concentrator and Sysplex workload balancing. When an application waits for longer than the maxTransportObjectWaitTime value, the global transport object pool throws an SQLException.

The default value for maxTransportObjectWaitTime is -1. Any negative value means that applications wait forever.

This property does not have a setXXX or a getXXX method.

#### **minTransportObjects**

Specifies the lower limit for the number of transport objects in a global transport object pool for the connection concentrator and Sysplex workload balancing. When a JVM is created, there are no transport objects in the pool. Transport objects are added to the pool as they are needed. After the

minTransportObjects value is reached, the number of transport objects in the global transport object pool never goes below the minTransportObjects value for the lifetime of that JVM.

The default value for minTransportObjects is 0. Any value that is less than or equal to 0 means that the global transport object pool can become empty.

This property does not have a setXXX or a getXXX method.

## IBM Data Server Driver for JDBC and SQLJ configuration properties

The IBM Data Server Driver for JDBC and SQLJ configuration properties have driver-wide scope.

The following table summarizes the configuration properties and corresponding Connection or DataSource properties, if they exist.

*Table 58. Summary of Configuration properties and corresponding Connection and DataSource properties*

Configuration property name	Connection or DataSource property name: com.ibm.db2.jcc.DB2BaseDataSource. ...	Notes
db2.jcc.accountingInterval	accountingInterval	1 on page 376, 4 on page 376
db2.jcc.allowSqljDuplicateStaticQueries		4 on page 376
db2.jcc.alternateGroupDatabaseName	alternateGroupDatabaseName	1 on page 376, 4 on page 376, 6 on page 376
db2.jcc.alternateGroupPortNumber	alternateGroupPortNumber	1 on page 376, 4 on page 376, 6 on page 376
db2.jcc.alternateGroupServerName	alternateGroupServerName	1 on page 376, 4 on page 376, 6 on page 376
db2.jcc.charOutputSize	charOutputSize	1 on page 376, 4 on page 376
db2.jcc.currentSchema	currentSchema	1 on page 376, 4 on page 376, 6 on page 376
db2.jcc.override.currentSchema	currentSchema	2 on page 376, 4 on page 376, 6 on page 376
db2.jcc.currentSQLID	currentSQLID	1 on page 376, 4 on page 376
db2.jcc.override.currentSQLID	currentSQLID	2 on page 376, 4 on page 376
db2.jcc.decimalRoundingMode	decimalRoundingMode	1 on page 376, 4 on page 376, 6 on page 376
db2.jcc.override.decimalRoundingMode	decimalRoundingMode	2 on page 376, 4 on page 376, 6 on page 376
db2.jcc.defaultSQLState		4 on page 376
db2.jcc.disableSQLJProfileCaching		4 on page 376
db2.jcc.dumpPool	dumpPool	1 on page 376, 3 on page 376, 4 on page 376, 5 on page 376
db2.jcc.dumpPoolStatisticsOnSchedule	dumpPoolStatisticsOnSchedule	1 on page 376, 3 on page 376, 4 on page 376, 5 on page 376
db2.jcc.dumpPoolStatisticsOnScheduleFile	dumpPoolStatisticsOnScheduleFile	1 on page 376, 3 on page 376, 4 on page 376, 5 on page 376
db2.jcc.enableAlternateGroupSeamlessACR	enableAlternateGroupSeamlessACR	1 on page 376, 4 on page 376, 6 on page 376

*Table 58. Summary of Configuration properties and corresponding Connection and DataSource properties (continued)*

<b>Configuration property name</b>	<b>Connection or DataSource property name: com.ibm.db2.jcc.DB2BaseDataSource. ...</b>	<b>Notes</b>
db2.jcc.override.enableMultirowInsertSupport	enableMultirowInsertSupport	2 on page 376, 4 on page 376
db2.jcc.jmxEnabled		4 on page 376, 5 on page 376, 6 on page 376
db2.jcc.lobOutputSize		4 on page 376
db2.jcc.maxRefreshInterval		4 on page 376, 5 on page 376, 6 on page 376
db2.jcc.maxTransportObjectIdleTime		1 on page 376, 4 on page 376, 5 on page 376, 6 on page 376
db2.jcc.maxTransportObjectWaitTime		1 on page 376, 4 on page 376, 5 on page 376, 6 on page 376
db2.jcc.maxTransportObjects	maxTransportObjects	1 on page 376, 4 on page 376, 5 on page 376, 6 on page 376
db2.jcc.minTransportObjects		1 on page 376, 4 on page 376, 5 on page 376, 6 on page 376
db2.jcc.outputDirectory		6 on page 376
db2.jcc.pkList	pkList	1 on page 376, 4 on page 376
db2.jcc.planName	planName	1 on page 376, 4 on page 376
db2.jcc.progressiveStreaming	progressiveStreaming	1 on page 376, 4 on page 376, 5 on page 376, 6 on page 376
db2.jcc.override.progressiveStreaming	progressiveStreaming	2 on page 376, 4 on page 376, 5 on page 376, 6 on page 376
db2.jcc.rollbackOnShutdown		4 on page 376
db2.jcc.sendCharInputsUTF8	sendCharInputsUTF8	4 on page 376
db2.jcc.sqljToolsExitJVMOnCompletion		4 on page 376, 6 on page 376
db2.jcc.sqljUncustomizedWarningOrException		4 on page 376, 6 on page 376
db2.jcc.ssid	ssid	1 on page 376, 4 on page 376
db2.jcc.traceDirectory	traceDirectory	1 on page 376, 4 on page 376, 5 on page 376, 6 on page 376
db2.jcc.override.traceDirectory	traceDirectory	2 on page 376, 4 on page 376, 5 on page 376, 6 on page 376
db2.jcc.traceFile	traceFile	1 on page 376, 4 on page 376, 5 on page 376, 6 on page 376
db2.jcc.override.traceFile	traceFile	2 on page 376, 4 on page 376, 5 on page 376, 6 on page 376
db2.jcc.traceFileAppend	traceFileAppend	1 on page 376, 4 on page 376, 5 on page 376, 6 on page 376

Table 58. Summary of Configuration properties and corresponding Connection and DataSource properties (continued)

Configuration property name	Connection or DataSource property name: com.ibm.db2.jcc.DB2BaseDataSource. ...	Notes
db2.jcc.override.traceFileAppend	traceFileAppend	2, 4, 5, 6
db2.jcc.traceFileCount	traceFileCount	1, 4, 5, 6
db2.jcc.traceFileSize	traceFileSize	1, 4, 5, 6
db2.jcc.traceLevel	traceLevel	1, 4, 5, 6
db2.jcc.override.traceLevel	traceLevel	2, 4, 5, 6
db2.jcc.traceOption	traceOption	1, 4, 5, 6
db2.jcc.tracePolling		4, 5, 6
db2.jcc.tracePollingInterval		4, 5, 6
db2.jcc.t2zosTraceFile		4
db2.jcc.t2zosTraceBufferSize		4
db2.jcc.t2zosTraceWrap		4
db2.jcc.useCcsid420ShapedConverter		4

**Note:**

1. The Connection or DataSource property setting overrides the configuration property setting. The configuration property provides a default value for the Connection or DataSource property.
2. The configuration property setting overrides the Connection or DataSource property.
3. The corresponding Connection or DataSource property is defined only for IBM Informix.
4. The configuration property applies to DB2 for z/OS.
5. The configuration property applies to IBM Informix.
6. The configuration property applies to DB2 Database for Linux, UNIX, and Windows.

The meanings of the configuration properties are:

**db2.jcc.accountingInterval**

Specifies whether DB2 accounting records are produced at commit points or on termination of the physical connection to the data source. If the value of `db2.jcc.accountingInterval` is `COMMIT`, DB2 accounting records are produced at commit points. For example:

```
db2.jcc.accountingInterval=COMMIT
```

Otherwise, accounting records are produced on termination of the physical connection to the data source.

`db2.jcc.accountingInterval` applies only to IBM Data Server Driver for JDBC and SQLJ type 2 connectivity on DB2 for z/OS. `db2.jcc.accountingInterval` is not applicable to connections under CICS or IMS, or for Java stored procedures.

You can override `db2.jcc.accountingInterval` by setting the `accountingInterval` property for a Connection or DataSource object.

This configuration property applies only to DB2 for z/OS.

**db2.jcc.alternateGroupDatabaseName**

Specifies the database names for alternative data sharing groups to which an application can connect. A database name is the DB2 location name that is defined during DB2 for z/OS installation. If more than one database name is specified, the database names must be separated by commas.

**db2.jcc.alternateGroupPortNumber**

Specifies the port numbers for alternative data sharing groups to which an application can connect. A port number is the TCP/IP server port number that

is assigned to a data server. If more than one port number is specified, the port numbers must be separated by commas.

**db2.jcc.alternateGroupName**

Specifies the host names for alternative data sharing groups to which an application can connect. A host name is the domain name or IP address that is assigned to a data server. If more than one host name is specified, the host names must be separated by commas.

**db2.jcc.allowSqljDuplicateStaticQueries**

Specifies whether multiple open iterators on a single SELECT statement in an SQLJ application are allowed under IBM Data Server Driver for JDBC and SQLJ type 2 connectivity.

To enable this support, set `db2.jcc.allowSqljDuplicateStaticQueries` to YES or true.

**db2.jcc.charOutputSize**

Specifies the maximum number of bytes to use for INOUT or OUT stored procedure parameters that are registered as `Types.CHAR`.

Because DESCRIBE information for stored procedure INOUT and OUT parameters is not available at run time, by default, the IBM Data Server Driver for JDBC and SQLJ sets the maximum length of each character INOUT or OUT parameter to 32767. For stored procedures with many `Types.CHAR` parameters, this maximum setting can result in allocation of much more storage than is necessary.

To use storage more efficiently, set `db2.jcc.charOutputSize` to the largest expected length for any `Types.CHAR` INOUT or OUT parameter.

`db2.jcc.charOutputSize` has no effect on INOUT or OUT parameters that are registered as `Types.VARCHAR` or `Types.LONGVARCHAR`. The driver uses the default length of 32767 for `Types.VARCHAR` and `Types.LONGVARCHAR` parameters.

The value that you choose for `db2.jcc.charOutputSize` needs to take into account the possibility of expansion during character conversion. Because the IBM Data Server Driver for JDBC and SQLJ has no information about the server-side CCSID that is used for output parameter values, the driver requests the stored procedure output data in UTF-8 Unicode. The `db2.jcc.charOutputSize` value needs to be the maximum number of bytes that are needed after the parameter value is converted to UTF-8 Unicode. UTF-8 Unicode characters can require up to three bytes. (The euro symbol is an example of a three-byte UTF-8 character.) To ensure that the value of `db2.jcc.charOutputSize` is large enough, if you have no information about the output data, set `db2.jcc.charOutputSize` to three times the defined length of the largest CHAR parameter.

This configuration property applies only to DB2 for z/OS.

**db2.jcc.currentSchema or db2.jcc.override.currentSchema**

Specifies the default schema name that is used to qualify unqualified database objects in dynamically prepared SQL statements. This value of this property sets the value in the CURRENT SCHEMA special register on the database server. The schema name is case-sensitive, and must be specified in uppercase characters.

This configuration property applies only to DB2 for z/OS or DB2 Database for Linux, UNIX, and Windows.

**db2.jcc.currentSQLID or db2.jcc.override.currentSQLID**

Specifies:



- The authorization ID that is used for authorization checking on dynamically prepared CREATE, GRANT, and REVOKE SQL statements.
- The owner of a table space, database, storage group, or synonym that is created by a dynamically issued CREATE statement.
- The implicit qualifier of all table, view, alias, and index names specified in dynamic SQL statements.

currentSQLID sets the value in the CURRENT SQLID special register on a DB2 for z/OS server. If the currentSQLID property is not set, the default schema name is the value in the CURRENT SQLID special register.

This configuration property applies only to DB2 for z/OS.

**db2.jcc.decimalRoundingMode or db2.jcc.override.decimalRoundingMode**

Specifies the rounding mode for assignment to decimal floating-point variables or DECFLOAT columns on DB2 for z/OS or DB2 Database for Linux, UNIX, and Windows data servers.

Possible values are:

**com.ibm.db2.jcc.DB2BaseDataSource.ROUND\_DOWN (1)**

Rounds the value towards 0 (truncation). The discarded digits are ignored.

**com.ibm.db2.jcc.DB2BaseDataSource.ROUND\_CEILING (2)**

Rounds the value towards positive infinity. If all of the discarded digits are zero or if the sign is negative the result is unchanged other than the removal of the discarded digits. Otherwise, the result coefficient is incremented by 1.

**com.ibm.db2.jcc.DB2BaseDataSource.ROUND\_HALF\_EVEN (3)**

Rounds the value to the nearest value; if the values are equidistant, rounds the value so that the final digit is even. If the discarded digits represents greater than half (0.5) of the value of one in the next left position then the result coefficient is incremented by 1. If they represent less than half, then the result coefficient is not adjusted (that is, the discarded digits are ignored). Otherwise the result coefficient is unaltered if its rightmost digit is even, or is incremented by 1 if its rightmost digit is odd (to make an even digit).

**com.ibm.db2.jcc.DB2BaseDataSource.ROUND\_HALF\_UP (4)**

Rounds the value to the nearest value; if the values are equidistant, rounds the value away from zero. If the discarded digits represent greater than or equal to half (0.5) of the value of one in the next left position then the result coefficient is incremented by 1. Otherwise the discarded digits are ignored.

**com.ibm.db2.jcc.DB2BaseDataSource.ROUND\_FLOOR (6)**

Rounds the value towards negative infinity. If all of the discarded digits are zero or if the sign is positive the result is unchanged other than the removal of discarded digits. Otherwise, the sign is negative and the result coefficient is incremented by 1.

**com.ibm.db2.jcc.DB2BaseDataSource.ROUND\_UNSET (-2147483647)**

No rounding mode was explicitly set. The IBM Data Server Driver for JDBC and SQLJ does not use the decimalRoundingMode to set the rounding mode on the database server. The rounding mode is ROUND\_HALF\_EVEN.

If you explicitly set the `db2.jcc.decimalRoundingMode` or `db2.jcc.override.decimalRoundingMode` value, that value updates the CURRENT DECFLOAT ROUNDING MODE special register value on a DB2 for z/OS data server.

If you explicitly set the `db2.jcc.decimalRoundingMode` or `db2.jcc.override.decimalRoundingMode` value, that value does not update the CURRENT DECFLOAT ROUNDING MODE special register value on a DB2 Database for Linux, UNIX, and Windows data server. If the value to which you set `db2.jcc.decimalRoundingMode` or `db2.jcc.override.decimalRoundingMode` is not the same as the value of the CURRENT DECFLOAT ROUNDING MODE special register, an Exception is thrown. To change the data server value, you need to set that value with the `decflt_rounding` database configuration parameter.

`decimalRoundingMode` does not affect decimal value assignments. The IBM Data Server Driver for JDBC and SQLJ always rounds decimal values down.

#### **db2.jcc.defaultSQLState**

Specifies the SQLSTATE value that the IBM Data Server Driver for JDBC and SQLJ returns to the client for `SQLException` or `SQLWarning` objects that have null SQLSTATE values. This configuration property can be specified in the following ways:

##### **db2.jcc.defaultSQLState**

If `db2.jcc.defaultSQLState` is specified with no value, the IBM Data Server Driver for JDBC and SQLJ returns 'FFFFF'.

##### **db2.jcc.defaultSQLState=xxxxx**

`xxxxx` is the value that the IBM Data Server Driver for JDBC and SQLJ returns when the SQLSTATE value is null. If `xxxxx` is longer than five bytes, the driver truncates the value to five bytes. If `xxxxx` is shorter than five bytes, the driver pads `xxxxx` on the right with blanks.

If `db2.jcc.defaultSQLState` is not specified, the IBM Data Server Driver for JDBC and SQLJ returns a null SQLSTATE value.

This configuration property applies only to DB2 for z/OS.

#### **db2.jcc.disableSQLJProfileCaching**

Specifies whether serialized profiles are cached when the JVM under which their application is running is reset. `db2.jcc.disableSQLJProfileCaching` applies only to applications that run in a resettable JVM (applications that run in the CICS, IMS, or Java stored procedure environment), and use IBM Data Server Driver for JDBC and SQLJ type 2 connectivity on DB2 for z/OS. Possible values are:

- YES** SQLJ serialized profiles are not cached every time the JVM is reset, so that new versions of the serialized profiles are loaded when the JVM is reset. Use this option when an application is under development, and new versions of the application and its serialized profiles are produced frequently.
- NO** SQLJ serialized profiles are cached when the JVM is reset. NO is the default.

This configuration property applies only to DB2 for z/OS.

#### **db2.jcc.dumpPool**

Specifies the types of statistics on global transport pool events that are written, in addition to summary statistics. The global transport pool is used for the connection concentrator and Sysplex workload balancing.

db2.jcc.dumpPoolStatisticsOnSchedule and db2.jcc.dumpPoolStatisticsOnScheduleFile must also be set for writing statistics before any statistics are written.

You can specify one or more of the following types of statistics with the db2.jcc.dumpPool property:

- DUMP\_REMOVE\_OBJECT (hexadecimal: X'01', decimal: 1)
- DUMP\_GET\_OBJECT (hexadecimal: X'02', decimal: 2)
- DUMP\_WAIT\_OBJECT (hexadecimal: X'04', decimal: 4)
- DUMP\_SET\_AVAILABLE\_OBJECT (hexadecimal: X'08', decimal: 8)
- DUMP\_CREATE\_OBJECT (hexadecimal: X'10', decimal: 16)
- DUMP\_SYSPLEX\_MSG (hexadecimal: X'20', decimal: 32)
- DUMP\_POOL\_ERROR (hexadecimal: X'80', decimal: 128)

To trace more than one type of event, add the values for the types of events that you want to trace. For example, suppose that you want to trace DUMP\_GET\_OBJECT and DUMP\_CREATE\_OBJECT events. The numeric equivalents of these values are 2 and 16, so you specify 18 for the db2.jcc.dumpPool value.

The default is 0, which means that only summary statistics for the global transport pool are written.

This configuration property applies only to DB2 for z/OS or IBM Informix.

#### **db2.jcc.dumpPoolStatisticsOnSchedule**

Specifies how often, in seconds, global transport pool statistics are written to the file that is specified by db2.jcc.dumpPoolStatisticsOnScheduleFile. The global transport object pool is used for the connection concentrator and Sysplex workload balancing.

The default is -1. -1 means that global transport pool statistics are not written.

This configuration property applies only to DB2 for z/OS or IBM Informix.

#### **db2.jcc.dumpPoolStatisticsOnScheduleFile**

Specifies the name of the file to which global transport pool statistics are written. The global transport pool is used for the connection concentrator and Sysplex workload balancing.

If db2.jcc.dumpPoolStatisticsOnScheduleFile is not specified, global transport pool statistics are not written.

This configuration property applies only to DB2 for z/OS or IBM Informix.

#### **db2.jcc.enableAlternateGroupSeamlessACR**

Specifies whether failover to an alternate group is seamless or non-seamless. Possible values are:

**false** Failover is non-seamless. false is the default.

With non-seamless behavior, if an application that is currently connected to a primary group is executing a transaction, and the entire primary group goes down, the IBM Data Server Driver for JDBC and SQLJ fails over to alternate group. If failover is successful, the driver throws an SQLException with SQL error code -30108.

**true** Failover is seamless.

With seamless behavior, if an application that is currently connected to a primary group is executing a transaction, and the entire primary group goes down, the IBM Data Server Driver for JDBC and SQLJ fails

over to alternate group. If the transaction is eligible for seamless failover, the connection is retried. If the connection is successful, no `SQLException` is thrown.

For connections to DB2 for z/OS, only one value can be specified.

**db2.jcc.override.enableMultiRowInsertSupport**

Specifies whether the IBM Data Server Driver for JDBC and SQLJ uses multi-row INSERT for batched INSERT or MERGE operations, when the target data server is a DB2 for z/OS server that supports multi-row INSERT. The batch operations must be `PreparedStatement` calls with parameter markers. The default is `true`.

`db2.jcc.override.enableMultiRowInsertSupport` must be set to `false` if INSERT FROM SELECT statements are executed in a batch. Otherwise, the driver throws a `BatchUpdateException`.

Possible values are:

- true** Specifies that the IBM Data Server Driver for JDBC and SQLJ uses multi-row INSERT for batched INSERT or MERGE operations, when the target data server is a DB2 for z/OS server that supports multi-row INSERT. This is the default.
- false** Specifies that the IBM Data Server Driver for JDBC and SQLJ does not use multi-row INSERT for batched INSERT or MERGE operations, when the target data server is a DB2 for z/OS server that supports multi-row INSERT.

**db2.jcc.jmxEnabled**

Specifies whether the Java Management Extensions (JMX) is enabled for the IBM Data Server Driver for JDBC and SQLJ instance. JMX must be enabled before applications can use the remote trace controller.

Possible values are:

- true or yes**  
Indicates that JMX is enabled.
- Any other value**  
Indicates that JMX is disabled. This is the default.

**db2.jcc.lobOutputSize**

Specifies the number of bytes of storage that the IBM Data Server Driver for JDBC and SQLJ needs to allocate for output LOB values when the driver cannot determine the size of those LOBs. This situation occurs for LOB stored procedure output parameters. `db2.jcc.lobOutputSize` applies only to IBM Data Server Driver for JDBC and SQLJ type 2 connectivity on DB2 for z/OS.

The default value for `db2.jcc.lobOutputSize` is 1048576. For systems with storage limitations and smaller LOBs, set the `db2.jcc.lobOutputSize` value to a lower number.

For example, if you know that the output LOB size is at most 64000, set `db2.jcc.lobOutputSize` to 64000.

This configuration property applies only to DB2 for z/OS.

**db2.jcc.maxRefreshInterval**

For workload balancing, specifies the maximum amount of time in seconds between refreshes of the client copy of the server list. The minimum valid value is 1.

For version 3.63 or 4.13 or later of the IBM Data Server Driver for JDBC and SQLJ, the default is 10 seconds. For earlier versions of the driver, the default is 30 seconds.

#### **db2.jcc.maxTransportObjectIdleTime**

Specifies the amount of time in seconds that an unused transport object stays in a global transport object pool before it can be deleted from the pool. Transport objects are used for the connection concentrator and Sysplex workload balancing.

The default value for `db2.jcc.maxTransportObjectIdleTime` is 60. Setting `db2.jcc.maxTransportObjectIdleTime` to a value less than 0 causes unused transport objects to be deleted from the pool immediately. Doing this is **not** recommended because it can cause severe performance degradation.

#### **db2.jcc.maxTransportObjects**

Specifies the upper limit for the number of transport objects in a global transport object pool for the connection concentrator and Sysplex workload balancing. When the number of transport objects in the pool reaches the `db2.jcc.maxTransportObjects` value, transport objects that have not been used for longer than the `db2.jcc.maxTransportObjectIdleTime` value are deleted from the pool.

For version 3.63 or 4.13 or later of the IBM Data Server Driver for JDBC and SQLJ, the default is 1000. For earlier versions of the driver, the default is -1.

Any value that is less than or equal to 0 means that there is no limit to the number of transport objects in the global transport object pool.

#### **db2.jcc.maxTransportObjectWaitTime**

Specifies the maximum amount of time in seconds that an application waits for a transport object if the `db2.jcc.maxTransportObjects` value has been reached. Transport objects are used for the connection concentrator and Sysplex workload balancing. When an application waits for longer than the `db2.jcc.maxTransportObjectWaitTime` value, the global transport object pool throws an `SQLException`.

Any negative value means that applications wait forever.

For version 3.63 or 4.13 or later of the IBM Data Server Driver for JDBC and SQLJ, the default is 1 second. For earlier versions of the driver, the default is -1.

#### **db2.jcc.minTransportObjects**

Specifies the lower limit for the number of transport objects in a global transport object pool for the connection concentrator and Sysplex workload balancing. When a JVM is created, there are no transport objects in the pool. Transport objects are added to the pool as they are needed. After the `db2.jcc.minTransportObjects` value is reached, the number of transport objects in the global transport object pool never goes below the `db2.jcc.minTransportObjects` value for the lifetime of that JVM.

The default value for `db2.jcc.minTransportObjects` is 0. Any value that is less than or equal to 0 means that the global transport object pool can become empty.

#### **db2.jcc.outputDirectory**

Specifies where the IBM Data Server Driver for JDBC and SQLJ stores temporary log or cache files.

If this property is set, the IBM Data Server Driver for JDBC and SQLJ stores the following files in the specified directory:

### **jccServerListCache.bin**

Contains a copy of the primary and alternate server information for automatic client reroute in a DB2 pureScale environment.

This file applies only to IBM Data Server Driver for JDBC and SQLJ type 4 connectivity to DB2 Database for Linux, UNIX, and Windows.

If `db2.jcc.outputDirectory` is not specified, the IBM Data Server Driver for JDBC and SQLJ searches for a directory that is specified by the `java.io.tmpdir` system property. If the `java.io.tmpdir` system property is also not specified, the driver uses only the in-memory cache for the primary and alternate server information. If a directory is specified, but `jccServerListCache.bin` cannot be accessed, the driver uses only the in-memory cache for the server list.

### **jcctdiag.log**

Contains diagnostic information that is written by the IBM Data Server Driver for JDBC and SQLJ.

If `db2.jcc.outputDirectory` is not specified, the IBM Data Server Driver for JDBC and SQLJ searches for a directory that is specified by the `java.io.tmpdir` system property. If the `java.io.tmpdir` system property is also not specified, the driver does not write diagnostic information to `jcctdiag.log`. If a directory is specified, but `jcctdiag.log` cannot be accessed, the driver does not write diagnostic information to `jcctdiag.log`.

### **connlicj.bin**

Contains information about IBM Data Server Driver for JDBC and SQLJ license verification, for direct connections to DB2 for z/OS. The IBM Data Server Driver for JDBC and SQLJ writes this file when server license verification is performed successfully for a data server. When a copy of the license verification information is stored at the client, performance of license verification on subsequent connections can be improved.

If `db2.jcc.outputDirectory` is not specified, the IBM Data Server Driver for JDBC and SQLJ searches for a directory that is specified by the `java.io.tmpdir` system property. If the `java.io.tmpdir` system property is also not specified, the driver does not store a copy of server license verification information at the client. If a directory is specified, but `connlicj.bin` cannot be accessed, the driver does not store a copy of server license verification information at the client.

The IBM Data Server Driver for JDBC and SQLJ does not create the directory. You must create the directory and assign the required file permissions.

`db2.jcc.outputDirectory` can specify an absolute path or a relative path. However, an absolute path is recommended.

### **db2.jcc.pkList**

Specifies a package list that is used for the underlying RRSAA CREATE THREAD call when a JDBC or SQLJ connection to a data source is established. Specify this property if you do not bind plans for your SQLJ programs or for the JDBC driver. If you specify this property, **do not specify `db2.jcc.planName`**.

`db2.jcc.pkList` applies only to IBM Data Server Driver for JDBC and SQLJ type 2 connectivity on DB2 for z/OS. `db2.jcc.pkList` does not apply to applications that run under CICS or IMS, or to Java stored procedures. The JDBC driver ignores the `db2.jcc.pkList` setting in those cases.



**Recommendation:** Use `db2.jcc.pkList` instead of `db2.jcc.planName`.

The format of the package list is:



The default value of `db2.jcc.pkList` is `NULLID.*`.

If you specify the `-collection` parameter when you run `com.ibm.db2.jcc.DB2Binder`, the collection ID that you specify for IBM Data Server Driver for JDBC and SQLJ packages when you run `com.ibm.db2.jcc.DB2Binder` must also be in the package list for the `db2.jcc.pkList` property.

You can override `db2.jcc.pkList` by setting the `pkList` property for a `Connection` or `DataSource` object.

The following example specifies a package list for a IBM Data Server Driver for JDBC and SQLJ instance whose packages are in collection `JDBCCID`. SQLJ applications that are prepared under this driver instance are bound into collections `SQLJCID1`, `SQLJCID2`, or `SQLJCID3`.

```
db2.jcc.pkList=JDBCCID.*,SQLJCID1.*,SQLJCID2.*,SQLJCID3.*
```

This configuration property applies only to DB2 for z/OS.

#### **db2.jcc.planName**

Specifies a DB2 for z/OS plan name that is used for the underlying RRSF CREATE THREAD call when a JDBC or SQLJ connection to a data source is established. Specify this property if you bind plans for your SQLJ programs and for the JDBC driver packages. If you specify this property, **do not specify `db2.jcc.pkList`**.

`db2.jcc.planName` applies only to IBM Data Server Driver for JDBC and SQLJ type 2 connectivity on DB2 for z/OS. `db2.jcc.planName` does not apply to applications that run under CICS or IMS, or to Java stored procedures. The JDBC driver ignores the `db2.jcc.planName` setting in those cases.

If you do not specify this property or the `db2.jcc.pkList` property, the IBM Data Server Driver for JDBC and SQLJ uses the `db2.jcc.pkList` default value of `NULLID.*`.

If you specify `db2.jcc.planName`, you need to bind the packages that you produce when you run `com.ibm.db2.jcc.DB2Binder` into a plan whose name is the value of this property. You also need to bind all SQLJ packages into a plan whose name is the value of this property.

You can override `db2.jcc.planName` by setting the `planName` property for a `Connection` or `DataSource` object.

The following example specifies a plan name of `MYPLAN` for the IBM Data Server Driver for JDBC and SQLJ JDBC packages and SQLJ packages.

```
db2.jcc.planName=MYPLAN
```

This configuration property applies only to DB2 for z/OS.

#### **db2.jcc.progressiveStreaming or db2.jcc.override.progressiveStreaming**

Specifies whether the JDBC driver uses progressive streaming when progressive streaming is supported on the data source.



With progressive streaming, also known as dynamic data format, the data source dynamically determines the most efficient mode in which to return LOB or XML data, based on the size of the LOBs or XML objects.

Valid values are:

- 1 Use progressive streaming, if the data source supports it.
- 2 Do not use progressive streaming.

#### **db2.jcc.rollbackOnShutdown**

Specifies whether DB2 for z/OS forces a rollback operation and disables further operations on JDBC connections that are in a unit of work during processing of JVM shutdown hooks.

db2.jcc.rollbackOnShutdown applies to IBM Data Server Driver for JDBC and SQLJ type 2 connectivity only.

db2.jcc.rollbackOnShutdown does not apply to the CICS, IMS, stored procedure, or WebSphere Application Server environments.

Possible values are:

##### **yes or true**

The IBM Data Server Driver for JDBC and SQLJ directs DB2 for z/OS to force a rollback operation and disables further operations on JDBC connections that are in a unit of work during processing of JVM shutdown hooks.

##### **Any other value**

The IBM Data Server Driver for JDBC and SQLJ takes no action with respect to rollback processing during processing of JVM shutdown hooks. This is the default.

This configuration property applies only to DB2 for z/OS.

#### **db2.jcc.sendCharInputsUTF8**

Specifies whether the IBM Data Server Driver for JDBC and SQLJ converts character input data to the CCSID of the DB2 for z/OS database server, or sends the data in UTF-8 encoding for conversion by the database server. db2.jcc.sendCharInputsUTF8 applies to IBM Data Server Driver for JDBC and SQLJ type 2 connectivity to DB2 for z/OS database servers only. If this property is also set at the connection level, the connection-level setting overrides this value.

Possible values are:

##### **no, false, or 2**

Specifies that the IBM Data Server Driver for JDBC and SQLJ converts character input data to the target encoding before the data is sent to the DB2 for z/OS database server. This is the default.

##### **yes, true, or 1**

Specifies that the IBM Data Server Driver for JDBC and SQLJ sends character input data to the DB2 for z/OS database server in UTF-8 encoding. The data source converts the data from UTF-8 encoding to the target CCSID.

Specify yes, true, or 1 only if conversion to the target CCSID by the SDK for Java causes character conversion problems. The most common problem occurs when you use IBM Data Server Driver for JDBC and SQLJ type 2 connectivity to insert a Unicode line feed character (U+000A) into a table column that has CCSID 37, and then retrieve that

data from a non-z/OS client. If the SDK for Java does the conversion during insertion of the character into the column, the line feed character is converted to the EBCDIC new line character X'15'. However, during retrieval, some SDKs for Java on operating systems other than z/OS convert the X'15' character to the Unicode next line character (U+0085) instead of the line feed character (U+000A). The next line character causes unexpected behavior for some XML parsers. If you set `db2.jcc.sendCharInputsUTF8` to yes, the DB2 for z/OS database server converts the U+000A character to the EBCDIC line feed character X'25' during insertion into the column, so the character is always retrieved as a line feed character.

Conversion of data to the target CCSID on the data source might cause the IBM Data Server Driver for JDBC and SQLJ to use more memory than conversion by the driver. The driver allocates memory for conversion of character data from the source encoding to the encoding of the data that it sends to the data source. The amount of space that the driver allocates for character data that is sent to a table column is based on the maximum possible length of the data. UTF-8 data can require up to three bytes for each character. Therefore, if the driver sends UTF-8 data to the data source, the driver needs to allocate three times the maximum number of characters in the input data. If the driver does the conversion, and the target CCSID is a single-byte CCSID, the driver needs to allocate only the maximum number of characters in the input data.

For example, any of the following settings for `db2.jcc.sendCharInputsUTF8` causes the IBM Data Server Driver for JDBC and SQLJ to convert input character strings to UTF-8, rather than the target encoding, before sending the data to the data source:

```
db2.jcc.sendCharInputsUTF8=yes
db2.jcc.sendCharInputsUTF8=true
db2.jcc.sendCharInputsUTF8=1
```

This configuration property applies only to DB2 for z/OS.

#### **db2.jcc.sqljToolsExitJVMOnCompletion**

Specifies whether the Java programs that underlie SQLJ tools such as `db2sqljcustomize` and `db2sqljbind` issue the `System.exit` call on return to the calling programs.

Possible values are:

- true** Specifies that the Java programs that underlie SQLJ tools issue the `System.exit` call upon completion. `true` is the default.
- false** Specifies that the Java programs that underlie SQLJ tools do not issue the `System.exit` call.

#### **db2.jcc.sqljUncustomizedWarningOrException**

Specifies the action that the IBM Data Server Driver for JDBC and SQLJ takes when an uncustomized SQLJ application runs.

`db2.jcc.sqljUncustomizedWarningOrException` can have the following values:

- 0** The IBM Data Server Driver for JDBC and SQLJ does not throw a Warning or Exception when an uncustomized SQLJ application is run. This is the default.
- 1** The IBM Data Server Driver for JDBC and SQLJ throws a Warning when an uncustomized SQLJ application is run.

- 2 The IBM Data Server Driver for JDBC and SQLJ throws an Exception when an uncustomized SQLJ application is run.

This configuration property applies only to DB2 for z/OS or DB2 Database for Linux, UNIX, and Windows.

**db2.jcc.traceDirectory or db2.jcc.override.traceDirectory**

Enables the IBM Data Server Driver for JDBC and SQLJ trace for Java driver code, and specifies a directory into which trace information is written. When `db2.jcc.override.traceDirectory` is specified, trace information for multiple connections on the same `DataSource` is written to multiple files.

When `db2.jcc.override.traceDirectory` is specified, a connection is traced to a file named *file-name\_origin\_n*.

- *n* is the *n*th connection for a `DataSource`.
- If neither `db2.jcc.traceFileName` nor `db2.jcc.override.traceFileName` is specified, *file-name* is `traceFile`. If `db2.jcc.traceFileName` or `db2.jcc.override.traceFileName` is also specified, *file-name* is the value of `db2.jcc.traceFileName` or `db2.jcc.override.traceFileName`.
- *origin* indicates the origin of the log writer that is in use. Possible values of *origin* are:

**cpds** The log writer for a `DB2ConnectionPoolDataSource` object.

**driver** The log writer for a `DB2Driver` object.

**global** The log writer for a `DB2TraceManager` object.

**sds** The log writer for a `DB2SimpleDataSource` object.

**xads** The log writer for a `DB2XADataSource` object.

The `db2.jcc.override.traceDirectory` property overrides the `traceDirectory` property for a `Connection` or `DataSource` object.

For example, specifying the following setting for `db2.jcc.override.traceDirectory` enables tracing of the IBM Data Server Driver for JDBC and SQLJ Java code to files in a directory named `/SYSTEM/tmp`:

```
db2.jcc.override.traceDirectory=/SYSTEM/tmp
```

You should set the trace properties under the direction of IBM Software Support.

**db2.jcc.traceLevel or db2.jcc.override.traceLevel**

Specifies what to trace.

The `db2.jcc.override.traceLevel` property overrides the `traceLevel` property for a `Connection` or `DataSource` object.

You specify one or more trace levels by specifying a decimal value. The trace levels are the same as the trace levels that are defined for the `traceLevel` property on a `Connection` or `DataSource` object.

To specify more than one trace level, do an OR (|) operation on the values, and specify the result in decimal in the `db2.jcc.traceLevel` or `db2.jcc.override.traceLevel` specification.

For example, suppose that you want to specify `TRACE_DRDA_FLOWS` and `TRACE_CONNECTIONS` for `db2.jcc.override.traceLevel`. `TRACE_DRDA_FLOWS` has a hexadecimal value of `X'40'`. `TRACE_CONNECTION_CALLS` has a hexadecimal value of `X'01'`. To specify both traces, do a bitwise OR operation on the two values, which results in `X'41'`. The decimal equivalent is 65, so you specify:

```
db2.jcc.override.traceLevel=65
```

### **db2.jcc.ssid**

Specifies the DB2 for z/OS subsystem to which applications make connections with IBM Data Server Driver for JDBC and SQLJ type 2 connectivity on DB2 for z/OS.

The `db2.jcc.ssid` value can be the name of the local DB2 subsystem or a group attachment name or subgroup attachment name.

For example:

```
db2.jcc.ssid=DB2A
```

The `ssid` Connection and DataSource property overrides `db2.jcc.ssid`.

If you specify a group attachment name or subgroup attachment name, and the DB2 subsystem to which an application is connected fails, the connection terminates. However, when new connections use that group attachment name or subgroup attachment name, DB2 for z/OS uses group attachment or subgroup attachment processing to find an active DB2 subsystem to which to connect.

If you do not specify the `db2.jcc.ssid` property, the IBM Data Server Driver for JDBC and SQLJ uses the SSID value from the application defaults load module. When you install DB2 for z/OS, an application defaults load module is created in the `prefix.SDSNEXIT` data set and the `prefix.SDSNLOAD` data set. Other application defaults load modules might be created in other data sets for selected applications.

The IBM Data Server Driver for JDBC and SQLJ must load an application defaults load module before it can read the SSID value. z/OS searches data sets in the following places, and in the following order, for the application defaults load module:

1. Job pack area (JPA)
2. TASKLIB
3. STEPLIB or JOBLIB
4. LPA
5. Libraries in the link list

You need to ensure that if your system has more than one copy of the application defaults load module, z/OS finds the data set that contains the correct copy for the IBM Data Server Driver for JDBC and SQLJ first.

This configuration property applies only to DB2 for z/OS.

### **db2.jcc.traceFile or db2.jcc.override.traceFile**

Enables the IBM Data Server Driver for JDBC and SQLJ trace for Java driver code, and specifies the name on which the trace file names are based.

Specify a fully qualified z/OS UNIX System Services file name for the `db2.jcc.override.traceFile` property value.

The `db2.jcc.override.traceFile` property overrides the `traceFile` property for a Connection or DataSource object.

For example, specifying the following setting for `db2.jcc.override.traceFile` enables tracing of the IBM Data Server Driver for JDBC and SQLJ Java code to a file named `/SYSTEM/tmp/jdbctrace`:

```
db2.jcc.override.traceFile=/SYSTEM/tmp/jdbctrace
```

You should set the trace properties under the direction of IBM Software Support.

**db2.jcc.traceFileAppend or db2.jcc.override.traceFileAppend**

Specifies whether to append to or overwrite the file that is specified by the `db2.jcc.override.traceFile` property. Valid values are `true` or `false`. The default is `false`, which means that the file that is specified by the `traceFile` property is overwritten.

The `db2.jcc.override.traceFileAppend` property overrides the `traceFileAppend` property for a `Connection` or `DataSource` object.

For example, specifying the following setting for `db2.jcc.override.traceFileAppend` causes trace data to be added to the existing trace file:

```
db2.jcc.override.traceFileAppend=true
```

You should set the trace properties under the direction of IBM Software Support.

**db2.jcc.traceFileCount**

Specifies the maximum number of trace files for circular tracing. The IBM Data Server Driver for JDBC and SQLJ uses this property only when `db2.jcc.traceOption` is set to 1. The default value is 2.

This property does not apply to IBM Data Server Driver for JDBC and SQLJ type 2 connectivity on DB2 for z/OS.

You should set the trace properties under the direction of IBM Software Support.

**db2.jcc.traceFileSize**

Specifies the maximum size of each trace file, for circular tracing. The IBM Data Server Driver for JDBC and SQLJ uses this property only when `db2.jcc.traceOption` is set to 1. The default value is 10485760 (10 MB).

This property does not apply to IBM Data Server Driver for JDBC and SQLJ type 2 connectivity on DB2 for z/OS.

You should set the trace properties under the direction of IBM Software Support.

**db2.jcc.traceOption**

Specifies the way in which trace data is collected. The data type of this property is `int`. Possible values are:

- 0** Specifies that a single trace file is generated, and that there is no limit to the size of the file. This is the default.
- 1** Specifies that the IBM Data Server Driver for JDBC and SQLJ does circular tracing. Circular tracing is done as follows:
  1. When an application writes its first trace record, the driver creates a file.
  2. The driver writes trace data to the file.
  3. When the size of the file is equal to the value of property `db2.jcc.traceFileSize`, the driver creates another file.
  4. The driver repeats steps 2 and 3 until the number of files to which data has been written is equal to the value of property `db2.jcc.traceFileCount`.
  5. The driver writes data to the first trace file, overwriting the existing data.
  6. The driver repeats steps 3 through 5 until the application completes.

The file names for the trace files are the file names that are determined by the `db2.jcc.traceFile`, `db2.jcc.override.traceFile`, `db2.jcc.traceDirectory`, `db2.jcc.override.traceDirectory` property, appended with `.1` for the first file, `.2` for the second file, and so on.

This property does not apply to IBM Data Server Driver for JDBC and SQLJ type 2 connectivity on DB2 for z/OS.

You should set the trace properties under the direction of IBM Software Support.

#### **db2.jcc.tracePolling**

Indicates whether the IBM Data Server Driver for JDBC and SQLJ polls the global configuration file for changes in trace directives and modifies the trace behavior to match the new trace directives. Possible values are `true` or `false`. `false` is the default.

The IBM Data Server Driver for JDBC and SQLJ modifies the trace behavior at the beginning of the next polling interval after the configuration properties file is changed. If `db2.jcc.tracePolling` is set to `true` while an application is running, the trace is enabled, and information about all the `PreparedStatement` objects that were created by the application before the trace was enabled are dumped to the trace destination.

`db2.jcc.tracePolling` polls the following global configuration properties:

- `db2.jcc.override.traceLevel`
- `db2.jcc.override.traceFile`
- `db2.jcc.override.traceDirectory`
- `db2.jcc.override.traceFileAppend`

#### **db2.jcc.tracePollingInterval**

Specifies the interval, in seconds, for polling the IBM Data Server Driver for JDBC and SQLJ global configuration file for changes in trace directives. The property value is a positive integer. The default is 60. For the specified trace polling interval to be used, the `db2.jcc.tracePollingInterval` property must be set *before* the driver is loaded and initialized. Changes to `db2.jcc.tracePollingInterval` after the driver is loaded and initialized have no effect.

#### **db2.jcc.t2zosTraceFile**

Enables the IBM Data Server Driver for JDBC and SQLJ trace for C/C++ native driver code for IBM Data Server Driver for JDBC and SQLJ type 2 connectivity, and specifies the name on which the trace file names are based. This property is required for collecting trace data for C/C++ native driver code.

Specify a fully qualified z/OS UNIX System Services file name for the `db2.jcc.t2zosTraceFile` property value.

For example, specifying the following setting for `db2.jcc.t2zosTraceFile` enables tracing of the IBM Data Server Driver for JDBC and SQLJ C/C++ native code to a file named `/SYSTEM/tmp/jdbctraceNative`:

```
db2.jcc.t2zosTraceFile=/SYSTEM/tmp/jdbctraceNative
```

You should set the trace properties under the direction of IBM Software Support.

This configuration property applies only to DB2 for z/OS.

#### **db2.jcc.t2zosTraceBufferSize**

Specifies the size, in kilobytes, of a trace buffer in virtual storage that is used

for tracing the processing that is done by the C/C++ native driver code. This value is also the maximum amount of C/C++ native driver trace information that can be collected.

Specify an integer between 64 (64 KB) and 4096 (4096 KB). The default is 256 (256 KB).

The JDBC driver determines the trace buffer size as shown in the following table:

Specified value ( <i>n</i> )	Trace buffer size (KB)
<64	64
64<= <i>n</i> <128	64
128<= <i>n</i> <256	128
256<= <i>n</i> <512	256
512<= <i>n</i> <1024	512
1024<= <i>n</i> <2048	1024
2048<= <i>n</i> <4096	2048
<i>n</i> >=4096	4096

db2.jcc.t2zosTraceBufferSize is used only if the db2.jcc.t2zosTraceFile property is set.

**Recommendation:** To avoid a performance impact, specify a value of 1024 or less.

For example, to set a trace buffer size of 1024 KB, use this setting:

```
db2.jcc.t2zosTraceBufferSize=1024
```

You should set the trace properties under the direction of IBM Software Support.

This configuration property applies only to DB2 for z/OS.

#### **db2.jcc.t2zosTraceWrap**

Enables or disables wrapping of the SQLJ trace. db2.jcc.t2zosTraceWrap can have one of the following values:

- 1        Wrap the trace
- 0        Do not wrap the trace

The default is 1. This parameter is optional. For example:

```
DB2SQLJ_TRACE_WRAP=0
```

You should set db2.jcc.t2zosTraceWrap only under the direction of IBM Software Support.

This configuration property applies only to DB2 for z/OS.

#### **db2.jcc.useCcsid420ShapedConverter**

Specifies whether Arabic character data that is in EBCDIC CCSID 420 maps to Cp420S encoding.

db2.jcc.useCcsid420ShapedConverter applies only to connections to DB2 for z/OS database servers.



If the value of `db2.jcc.useCcsid420ShapedConverter` is `true`, CCSID 420 maps to Cp420S encoding. If the value of `db2.jcc.useCcsid420ShapedConverter` is `false`, CCSID 420 maps to Cp420 encoding. `false` is the default.

This configuration property applies only to DB2 for z/OS.

## Driver support for JDBC APIs

The JDBC drivers that are supported by DB2 and IBM Informix database systems have different levels of support for JDBC methods.

The following tables list the JDBC interfaces and indicate which drivers supports them. The drivers and their supported platforms are:

*Table 59. JDBC drivers for DB2 and IBM Informix database systems*

JDBC driver name	Associated data source
IBM Data Server Driver for JDBC and SQLJ	DB2 Database for Linux, UNIX, and Windows, DB2 for z/OS, or IBM Informix
IBM Informix JDBC Driver (IBM Informix JDBC Driver)	IBM Informix

If a method has JDBC 2.0 and JDBC 3.0 forms, the IBM Data Server Driver for JDBC and SQLJ supports all forms. The DB2 JDBC Type 2 Driver for Linux, UNIX and Windows supports only the JDBC 2.0 forms.

*Table 60. Support for `java.sql.Array` methods*

JDBC method	IBM Data Server Driver for JDBC and SQLJ1 support	IBM Informix JDBC Driver support
<code>free</code> <sup>2</sup>	Yes	No
<code>getArray</code>	Yes	Yes
<code>getBaseType</code>	Yes	Yes
<code>getBaseTypeName</code>	Yes	Yes
<code>getResultSet</code>	Yes	Yes

### Notes:

- Under the IBM Data Server Driver for JDBC and SQLJ, Array methods are supported for connections to DB2 Database for Linux, UNIX, and Windows data sources only.
- This is a JDBC 4.0 method.

*Table 61. Support for `java.sql.BatchUpdateException` methods*

JDBC method	IBM Data Server Driver for JDBC and SQLJ support	IBM Informix JDBC Driver support
Methods inherited from <code>java.lang.Exception</code>	Yes	Yes
<code>getUpdateCounts</code>	Yes	Yes

*Table 62. Support for `java.sql.Blob` methods*

JDBC method	IBM Data Server Driver for JDBC and SQLJ support	IBM Informix JDBC Driver support
<code>free</code> <sup>1</sup>	Yes	No
<code>getBinaryStream</code>	Yes <sup>2</sup>	Yes
<code>getBytes</code>	Yes	Yes
<code>length</code>	Yes	Yes

Table 62. Support for *java.sql.Blob* methods (continued)

JDBC method	IBM Data Server Driver for JDBC and SQLJ support	IBM Informix JDBC Driver support
position	Yes	Yes
setBinaryStream <sup>3</sup>	Yes	No
setBytes <sup>3</sup>	Yes	No
truncate <sup>3</sup>	Yes	No

**Notes:**

1. This is a JDBC 4.0 method.
2. Supported forms of this method include the following JDBC 4.0 form:  
`getBinaryStream(long pos, long length)`
3. For versions of the IBM Data Server Driver for JDBC and SQLJ before version 3.50, these methods cannot be used if a Blob is passed to a stored procedure as an IN or INOUT parameter, and the methods are used on the Blob in the stored procedure.

Table 63. Support for *java.sql.CallableStatement* methods

JDBC method	IBM Data Server Driver for JDBC and SQLJ support	IBM Informix JDBC Driver support
Methods inherited from <i>java.sql.Statement</i>	Yes	Yes
Methods inherited from <i>java.sql.PreparedStatement</i>	Yes <sup>1</sup>	Yes
getArray	No	No
getBigDecimal	Yes <sup>3</sup>	Yes
getBlob	Yes <sup>3</sup>	Yes
getBoolean	Yes <sup>3</sup>	Yes
getByte	Yes <sup>3</sup>	Yes
getBytes	Yes <sup>3</sup>	Yes
getClob	Yes <sup>3</sup>	Yes
getDate	Yes <sup>3,5</sup>	Yes
getDouble	Yes <sup>3</sup>	Yes
getFloat	Yes <sup>3</sup>	Yes
getInt	Yes <sup>3</sup>	Yes
getLong	Yes <sup>3</sup>	Yes
getObject	Yes <sup>3,4,6</sup>	Yes
getRef	No	No
getRowId <sup>2</sup>	Yes	No
getShort	Yes <sup>3</sup>	Yes
getString	Yes <sup>3</sup>	Yes
getTime	Yes <sup>3,5</sup>	Yes
getTimestamp	Yes <sup>3,5</sup>	Yes
getURL	Yes	No
registerOutParameter	Yes <sup>7</sup>	Yes <sup>7</sup>
setAsciiStream	Yes <sup>8</sup>	Yes
setBigDecimal	Yes <sup>8</sup>	Yes

Table 63. Support for *java.sql.CallableStatement* methods (continued)

JDBC method	IBM Data Server Driver for JDBC and SQLJ support	IBM Informix JDBC Driver support
<code>setBinaryStream</code>	Yes <sup>8</sup>	Yes
<code>setBoolean</code>	Yes <sup>8</sup>	Yes
<code>setByte</code>	Yes <sup>8</sup>	Yes
<code>setBytes</code>	Yes <sup>8</sup>	Yes
<code>setCharacterStream</code>	Yes <sup>8</sup>	Yes
<code>setDate</code>	Yes <sup>8</sup>	Yes
<code>setDouble</code>	Yes <sup>8</sup>	Yes
<code>setFloat</code>	Yes <sup>8</sup>	Yes
<code>setInt</code>	Yes <sup>8</sup>	Yes
<code>setLong</code>	Yes <sup>8</sup>	Yes
<code>setNull</code>	Yes <sup>8,9</sup>	Yes
<code>setObject</code>	Yes <sup>8</sup>	Yes
<code>setShort</code>	Yes <sup>8</sup>	Yes
<code>setString</code>	Yes <sup>8</sup>	Yes
<code>setTime</code>	Yes <sup>8</sup>	Yes
<code>setTimestamp</code>	Yes <sup>8</sup>	Yes
<code>setURL</code>	Yes	No
<code>wasNull</code>	Yes	Yes

**Notes:**

1. The inherited `getParameterMetaData` method is not supported if the data source is DB2 for z/OS.
2. This is a JDBC 4.0 method.
3. The following forms of `CallableStatement.getXXX` methods are not supported if the data source is DB2 for z/OS:  
`getXXX(String parameterName)`
4. The following JDBC 4.1 method is supported:  
`getObject(int parameterIndex, java.lang.Class<T> type)`  
`getObject(java.lang.String parameterName, java.lang.Class<T> type)`
5. The database server does no timezone adjustment for datetime values. The JDBC driver adjusts a value for the local timezone after retrieving the value from the server if you specify a form of the `getDate`, `getTime`, or `getTimestamp` method that includes a `java.util.Calendar` parameter.
6. The following form of the `getObject` method is not supported:  
`getObject(int parameterIndex, java.util.Map map)`
7. The following form of the `registerOutParameter` method is not supported:  
`registerOutParameter(int parameterIndex, int jdbcType, String typeName)`
8. The following forms of `CallableStatement.setXXX` methods are not supported if the data source is DB2 for z/OS:  
`setXXX(String parameterName,...)`
9. The following form of `setNull` is not supported:  
`setNull(int parameterIndex, int jdbcType, String typeName)`

Table 64. Support for *java.sql.Clob* methods

JDBC method	IBM Data Server Driver for JDBC and SQLJ support	IBM Informix JDBC Driver support
<code>free</code> <sup>1</sup>	Yes	No
<code>getAsciiStream</code>	Yes	Yes
<code>getCharacterStream</code>	Yes <sup>2</sup>	Yes
<code>getSubString</code>	Yes	Yes
<code>length</code>	Yes	Yes
<code>position</code>	Yes	Yes
<code>setAsciiStream</code> <sup>3</sup>	Yes	Yes
<code>setCharacterStream</code> <sup>3</sup>	Yes	Yes
<code>setString</code> <sup>3</sup>	Yes	Yes
<code>truncate</code> <sup>3</sup>	Yes	Yes

**Notes:**

1. This is a JDBC 4.0 method.
2. Supported forms of this method include the following JDBC 4.0 form:  
`getCharacterStream(long pos, long length)`
3. For versions of the IBM Data Server Driver for JDBC and SQLJ before version 3.50, these methods cannot be used if a Clob is passed to a stored procedure as an IN or INOUT parameter, and the methods are used on the Clob in the stored procedure.

Table 65. Support for *javax.sql.CommonDataSource* methods

JDBC method	IBM Data Server Driver for JDBC and SQLJ support	IBM Informix JDBC Driver support
<code>getLoginTimeout</code>	Yes	Yes
<code>getLogWriter</code>	Yes	Yes
<code>getParentLogger1</code>	Yes	No
<code>setLoginTimeout</code>	Yes	Yes
<code>setLogWriter</code>	Yes	Yes

**Notes:**

1. This is a JDBC 4.1 method.

Table 66. Support for *java.sql.Connection* methods

JDBC method	IBM Data Server Driver for JDBC and SQLJ support	IBM Informix JDBC Driver support
<code>abort</code> <sup>1</sup>	Yes	No
<code>clearWarnings</code>	Yes	Yes
<code>close</code>	Yes	Yes
<code>commit</code>	Yes	Yes
<code>createArrayOf</code> <sup>2</sup>	Yes	No
<code>createBlob</code> <sup>2</sup>	Yes	No
<code>createClob</code> <sup>2</sup>	Yes	No
<code>createStatement</code>	Yes	Yes
<code>createStruct</code> <sup>2</sup>	Yes	No

Table 66. Support for *java.sql.Connection* methods (continued)

JDBC method	IBM Data Server Driver for JDBC and SQLJ support	IBM Informix JDBC Driver support
<code>getAutoCommit</code>	Yes	Yes
<code>getCatalog</code>	Yes	Yes
<code>getClientInfo</code> <sup>2</sup>	Yes	No
<code>getHoldability</code>	Yes	No
<code>getMetaData</code>	Yes	Yes
<code>getNetworkTimeout</code> <sup>1</sup>	Yes	No
<code>getSchema</code> <sup>1</sup>	Yes	No
<code>getTransactionIsolation</code>	Yes	Yes
<code>getTypeMap</code>	No	Yes
<code>getWarnings</code>	Yes	Yes
<code>isClosed</code>	Yes	Yes
<code>isReadOnly</code>	Yes	Yes
<code>isValid</code> <sup>2,3</sup>	Yes	No
<code>nativeSQL</code>	Yes	Yes
<code>prepareCall</code>	Yes <sup>4</sup>	Yes
<code>prepareStatement</code>	Yes	Yes
<code>releaseSavepoint</code>	Yes	No
<code>rollback</code>	Yes	Yes
<code>setAutoCommit</code>	Yes	Yes
<code>setCatalog</code>	Yes	No
<code>setClientInfo</code> <sup>2</sup>	Yes	No
<code>setNetworkTimeout</code> <sup>1</sup>	Yes	No
<code>setReadOnly</code>	Yes <sup>5</sup>	No
<code>setSavepoint</code>	Yes	No
<code>setSchema</code> <sup>1</sup>	Yes	No
<code>setTransactionIsolation</code>	Yes	Yes
<code>setTypeMap</code>	No	Yes

**Notes:**

1. This is a JDBC 4.1 method.
2. This is a JDBC 4.0 method.
3. Under IBM Data Server Driver for JDBC and SQLJ type 4 connectivity, an *SQLException* is thrown if the *timeout* parameter value is less than 0. Under IBM Data Server Driver for JDBC and SQLJ type 2 connectivity, an *SQLException* is thrown if the if the *timeout* parameter value is not 0.
4. If the stored procedure in the CALL statement is on DB2 for z/OS, the parameters of the CALL statement cannot be expressions.
5. The driver does not use the setting. For the IBM Data Server Driver for JDBC and SQLJ, a connection can be set as read-only through the `readOnly` property for a *Connection* or *DataSource* object.

Table 67. Support for *javax.sql.ConnectionEvent* methods

JDBC method	IBM Data Server Driver for JDBC and SQLJ support	IBM Informix JDBC Driver support
Methods inherited from <i>java.util.EventObject</i>	Yes	Yes
<i>getSQLException</i>	Yes	Yes

Table 68. Support for *javax.sql.ConnectionEventListener* methods

JDBC method	IBM Data Server Driver for JDBC and SQLJ support	IBM Informix JDBC Driver support
<i>connectionClosed</i>	Yes	Yes
<i>connectionErrorOccurred</i>	Yes	Yes

Table 69. Support for *javax.sql.ConnectionPoolDataSource* methods

JDBC method	IBM Data Server Driver for JDBC and SQLJ support	IBM Informix JDBC Driver support
<i>getLoginTimeout</i>	Yes	Yes
<i>getLogWriter</i>	Yes	Yes
<i>getPooledConnection</i>	Yes	Yes
<i>setLoginTimeout</i>	Yes <sup>1</sup>	Yes
<i>setLogWriter</i>	Yes	Yes

**Note:**

1. This method is not supported for IBM Data Server Driver for JDBC and SQLJ type 2 connectivity on DB2 for z/OS.

Table 70. Support for *java.sql.DatabaseMetaData* methods

JDBC method	IBM Data Server Driver for JDBC and SQLJ support	IBM Informix JDBC Driver support
<i>allProceduresAreCallable</i>	Yes	Yes
<i>allTablesAreSelectable</i>	Yes <sup>1</sup>	Yes <sup>1</sup>
<i>dataDefinitionCausesTransactionCommit</i>	Yes	Yes
<i>dataDefinitionIgnoredInTransactions</i>	Yes	Yes
<i>deletesAreDetected</i>	Yes	Yes
<i>doesMaxRowSizeIncludeBlobs</i>	Yes	Yes
<i>generatedKeyAlwaysReturned</i> <sup>2</sup>	Yes	No
<i>getAttributes</i>	Yes <sup>3</sup>	No
<i>getBestRowIdentifier</i>	Yes	Yes
<i>getCatalogs</i>	Yes	Yes
<i>getCatalogSeparator</i>	Yes	Yes
<i>getCatalogTerm</i>	Yes	Yes
<i>getClientInfoProperties</i> <sup>7</sup>	Yes	No
<i>getColumnPrivileges</i>	Yes	Yes
<i>getColumns</i>	Yes <sup>8</sup>	Yes <sup>11</sup>
<i>getConnection</i>	Yes	Yes

Table 70. Support for *java.sql.DatabaseMetaData* methods (continued)

JDBC method	IBM Data Server Driver for JDBC and SQLJ support	IBM Informix JDBC Driver support
<code>getCrossReference</code>	Yes	Yes
<code>getDatabaseMajorVersion</code>	Yes	No
<code>getDatabaseMinorVersion</code>	Yes	No
<code>getDatabaseProductName</code>	Yes	Yes
<code>getDatabaseProductVersion</code>	Yes	Yes
<code>getDefaultTransactionIsolation</code>	Yes	Yes
<code>getDriverMajorVersion</code>	Yes	Yes
<code>getDriverMinorVersion</code>	Yes	Yes
<code>getDriverName</code>	Yes <sup>9</sup>	Yes
<code>getDriverVersion</code>	Yes	Yes
<code>getExportedKeys</code>	Yes	Yes
<code>getFunctionColumns<sup>7</sup></code>	Yes	No
<code>getFunctions<sup>7</sup></code>	Yes	No
<code>getExtraNameCharacters</code>	Yes	Yes
<code>getIdentifierQuoteString</code>	Yes	Yes
<code>getImportedKeys</code>	Yes	Yes
<code>getIndexInfo</code>	Yes	Yes
<code>getJDBCMinorVersion</code>	Yes	No
<code>getJDBCMajorVersion</code>	Yes	No
<code>getMaxBinaryLiteralLength</code>	Yes	Yes
<code>getMaxCatalogNameLength</code>	Yes	Yes
<code>getMaxCharLiteralLength</code>	Yes	Yes
<code>getMaxColumnNameLength</code>	Yes	Yes
<code>getMaxColumnsInGroupBy</code>	Yes	Yes
<code>getMaxColumnsInIndex</code>	Yes	Yes
<code>getMaxColumnsInOrderBy</code>	Yes	Yes
<code>getMaxColumnsInSelect</code>	Yes	Yes
<code>getMaxColumnsInTable</code>	Yes	Yes
<code>getMaxConnections</code>	Yes	Yes
<code>getMaxCursorNameLength</code>	Yes	Yes
<code>getMaxIndexLength</code>	Yes	Yes
<code>getMaxProcedureNameLength</code>	Yes	Yes
<code>getMaxRowSize</code>	Yes	Yes
<code>getMaxSchemaNameLength</code>	Yes	Yes
<code>getMaxStatementLength</code>	Yes	Yes
<code>getMaxStatements</code>	Yes	Yes
<code>getMaxTableNameLength</code>	Yes	Yes
<code>getMaxTablesInSelect</code>	Yes	Yes



Table 70. Support for *java.sql.DatabaseMetaData* methods (continued)

JDBC method	IBM Data Server Driver for JDBC and SQLJ support	IBM Informix JDBC Driver support
<code>getMaxUserNameLength</code>	Yes	Yes
<code>getNumericFunctions</code>	Yes	Yes
<code>getPrimaryKeys</code>	Yes	Yes
<code>getProcedureColumns</code>	Yes <sup>8</sup> on page 402	Yes
<code>getProcedures</code>	Yes <sup>8</sup> on page 402	Yes
<code>getProcedureTerm</code>	Yes	Yes
<code>getPseudoColumns<sup>2</sup></code>	Yes	No
<code>getResultSetHoldability</code>	Yes	No
<code>getRowIdLifetime<sup>7</sup></code>	Yes	No
<code>getSchemas</code>	Yes <sup>10</sup> on page 402	Yes <sup>11</sup>
<code>getSchemaTerm</code>	Yes	Yes
<code>getSearchStringEscape</code>	Yes	Yes
<code>getSQLKeywords</code>	Yes	Yes
<code>getSQLStateType</code>	Yes	No
<code>getStringFunctions</code>	Yes	Yes
<code>getSuperTables</code>	Yes <sup>3</sup>	No
<code>getSuperTypes</code>	Yes <sup>3</sup>	No
<code>getSystemFunctions</code>	Yes	Yes
<code>getTablePrivileges</code>	Yes	Yes
<code>getTables</code>	Yes	Yes <sup>11</sup>
<code>getTableTypes</code>	Yes	Yes
<code>getTimeDateFunctions</code>	Yes	Yes
<code>getTypeInfo</code>	Yes	Yes
<code>getUDTs</code>	No	Yes <sup>12</sup>
<code>getURL</code>	Yes	Yes
<code>getUserName</code>	Yes	Yes
<code>getVersionColumns</code>	Yes	Yes
<code>insertsAreDetected</code>	Yes	Yes
<code>isCatalogAtStart</code>	Yes	Yes
<code>isReadOnly</code>	Yes	Yes
<code>locatorsUpdateCopy</code>	Yes <sup>4</sup>	Yes <sup>4</sup>
<code>nullPlusNonNullsIsNull</code>	Yes	Yes
<code>nullsAreSortedAtEnd</code>	Yes <sup>5</sup>	Yes <sup>5</sup>
<code>nullsAreSortedAtStart</code>	Yes	Yes
<code>nullsAreSortedHigh</code>	Yes <sup>6</sup>	Yes <sup>6</sup>
<code>nullsAreSortedLow</code>	Yes <sup>1</sup>	Yes <sup>1</sup>
<code>othersDeletesAreVisible</code>	Yes	Yes
<code>othersInsertsAreVisible</code>	Yes	Yes

Table 70. Support for *java.sql.DatabaseMetaData* methods (continued)

JDBC method	IBM Data Server Driver for JDBC and SQLJ support	IBM Informix JDBC Driver support
othersUpdatesAreVisible	Yes	Yes
ownDeletesAreVisible	Yes	Yes
ownInsertsAreVisible	Yes	Yes
ownUpdatesAreVisible	Yes	Yes
storesLowerCaseIdentifiers	Yes <sup>1</sup>	Yes <sup>1</sup>
storesLowerCaseQuotedIdentifiers	Yes <sup>5</sup>	Yes <sup>5</sup>
storesMixedCaseIdentifiers	Yes	Yes
storesMixedCaseQuotedIdentifiers	Yes	Yes
storesUpperCaseIdentifiers	Yes <sup>6</sup>	Yes <sup>6</sup>
storesUpperCaseQuotedIdentifiers	Yes	Yes
supportsAlterTableWithAddColumn	Yes	Yes
supportsAlterTableWithDropColumn	Yes <sup>1</sup>	Yes <sup>1</sup>
supportsANSI92EntryLevelSQL	Yes	Yes
supportsANSI92FullSQL	Yes	Yes
supportsANSI92IntermediateSQL	Yes	Yes
supportsBatchUpdates	Yes	Yes
supportsCatalogsInDataManipulation	Yes <sup>1</sup>	Yes <sup>1</sup>
supportsCatalogsInIndexDefinitions	Yes	Yes
supportsCatalogsInPrivilegeDefinitions	Yes	Yes
supportsCatalogsInProcedureCalls	Yes <sup>1</sup>	Yes <sup>1</sup>
supportsCatalogsInTableDefinitions	Yes	Yes
SupportsColumnAliasing	Yes	Yes
supportsConvert	Yes	Yes
supportsCoreSQLGrammar	Yes	Yes
supportsCorrelatedSubqueries	Yes	Yes
supportsDataDefinitionAndDataManipulationTransactions	Yes	Yes
supportsDataManipulationTransactionsOnly	Yes	Yes
supportsDifferentTableCorrelationNames	Yes <sup>5</sup>	Yes <sup>5</sup>
supportsExpressionsInOrderBy	Yes	Yes
supportsExtendedSQLGrammar	Yes	Yes
supportsFullOuterJoins	Yes <sup>4</sup>	Yes <sup>4</sup>
supportsGetGeneratedKeys	Yes	No
supportsGroupBy	Yes	Yes
supportsGroupByBeyondSelect	Yes	Yes
supportsGroupByUnrelated	Yes	Yes
supportsIntegrityEnhancementFacility	Yes	Yes
supportsLikeEscapeClause	Yes	Yes
supportsLimitedOuterJoins	Yes	Yes

Table 70. Support for *java.sql.DatabaseMetaData* methods (continued)

JDBC method	IBM Data Server Driver for JDBC and SQLJ support	IBM Informix JDBC Driver support
supportsMinimumSQLGrammar	Yes	Yes
supportsMixedCaseIdentifiers	Yes	Yes
supportsMixedCaseQuotedIdentifiers	Yes <sup>4</sup>	Yes <sup>4</sup>
supportsMultipleOpenResults	Yes <sup>6</sup>	Yes <sup>6</sup>
supportsMultipleResultSets	Yes <sup>6</sup>	Yes <sup>6</sup>
supportsMultipleTransactions	Yes	Yes
supportsNamedParameters	Yes	No
supportsNonNullableColumns	Yes	Yes
supportsOpenCursorsAcrossCommit	Yes <sup>4</sup>	Yes <sup>4</sup>
supportsOpenCursorsAcrossRollback	Yes	Yes
supportsOpenStatementsAcrossCommit	Yes <sup>4</sup>	Yes <sup>4</sup>
supportsOpenStatementsAcrossRollback	Yes <sup>4</sup>	Yes <sup>4</sup>
supportsOrderByUnrelated	Yes	Yes
supportsOuterJoins	Yes	Yes
supportsPositionedDelete	Yes	Yes
supportsPositionedUpdate	Yes	Yes
supportsResultSetConcurrency	Yes	Yes
supportsResultSetHoldability	Yes	No
supportsResultSetType	Yes	Yes
supportsSavepoints	Yes	Yes
supportsSchemasInDataManipulation	Yes	Yes
supportsSchemasInIndexDefinitions	Yes	Yes
supportsSchemasInPrivilegeDefinitions	Yes	Yes
supportsSchemasInProcedureCalls	Yes	Yes
supportsSchemasInTableDefinitions	Yes	Yes
supportsSelectForUpdate	Yes	Yes
supportsStoredProcedures	Yes	Yes
supportsSubqueriesInComparisons	Yes	Yes
supportsSubqueriesInExists	Yes	Yes
supportsSubqueriesInIns	Yes	Yes
supportsSubqueriesInQuantifieds	Yes	Yes
supportsSuperTables	Yes	No
supportsSuperTypes	Yes	No
supportsTableCorrelationNames	Yes	Yes
supportsTransactionIsolationLevel	Yes	Yes
supportsTransactions	Yes	Yes
supportsUnion	Yes	Yes
supportsUnionAll	Yes	Yes

Table 70. Support for *java.sql.DatabaseMetaData* methods (continued)

JDBC method	IBM Data Server Driver for JDBC and SQLJ support	IBM Informix JDBC Driver support
updatesAreDetected	Yes	Yes
usesLocalFilePerTable	Yes	Yes
usesLocalFiles	Yes	Yes

**Notes:**

1. DB2 data sources return false for this method. IBM Informix data sources return true.
2. This is a JDBC 4.1 method.
3. This method is supported for connections to DB2 Database for Linux, UNIX, and Windows and IBM Informix only.
4. Under the IBM Data Server Driver for JDBC and SQLJ, DB2 data sources and IBM Informix data sources return true for this method. Under the IBM Informix JDBC Driver, IBM Informix data sources return false.
5. Under the IBM Data Server Driver for JDBC and SQLJ, DB2 data sources and IBM Informix data sources return false for this method. Under the IBM Informix JDBC Driver, IBM Informix data sources return true.
6. DB2 data sources return true for this method. IBM Informix data sources return false.
7. This is a JDBC 4.0 method.
8. This method returns the additional column that is described by the JDBC 4.0 specification.
9. JDBC 3.0 and earlier implementations of the IBM Data Server Driver for JDBC and SQLJ return "IBM DB2 JDBC Universal Driver Architecture."  
The JDBC 4.0 implementation of the IBM Data Server Driver for JDBC and SQLJ returns "IBM Data Server Driver for JDBC and SQLJ."
10. The JDBC 4.0 form and previous forms of this method are supported.
11. The DB2 JDBC Type 2 Driver for Linux, UNIX and Windows does not support the JDBC 3.0 form of this method.
12. The method can be executed, but it returns an empty ResultSet.

Table 71. Support for *java.sql.DataSource* methods

JDBC method	IBM Data Server Driver for JDBC and SQLJ support	IBM Informix JDBC Driver support
getConnection	Yes	Yes
getLoginTimeout	Yes	Yes
getLogWriter	Yes	Yes
setLoginTimeout	Yes <sup>1</sup>	Yes
setLogWriter	Yes	Yes

**Notes:**

1. This method is not supported for IBM Data Server Driver for JDBC and SQLJ type 2 connectivity on DB2 for z/OS.

Table 72. Support for *java.sql.DataTruncation* methods

JDBC method	IBM Data Server Driver for JDBC and SQLJ support	IBM Informix JDBC Driver support
Methods inherited from <i>java.lang.Throwable</i>	Yes	Yes
Methods inherited from <i>java.sql.SQLException</i>	Yes	Yes
Methods inherited from <i>java.sql.SQLWarning</i>	Yes	Yes
getDataSize	Yes	Yes

Table 72. Support for *java.sql.DataTruncation* methods (continued)

JDBC method	IBM Data Server Driver for JDBC and SQLJ support	IBM Informix JDBC Driver support
<code>getIndex</code>	Yes	Yes
<code>getParameter</code>	Yes	Yes
<code>getRead</code>	Yes	Yes
<code>getTransferSize</code>	Yes	Yes

Table 73. Support for *java.sql.Driver* methods

JDBC method	IBM Data Server Driver for JDBC and SQLJ support	IBM Informix JDBC Driver support
<code>acceptsURL</code>	Yes	Yes
<code>connect</code>	Yes	Yes
<code>getMajorVersion</code>	Yes	Yes
<code>getMinorVersion</code>	Yes	Yes
<code>getParentLogger</code>	Yes	No
<code>getPropertyInfo</code>	Yes	Yes
<code>jdbcCompliant</code>	Yes	Yes

Table 74. Support for *java.sql.DriverManager* methods

JDBC method	IBM Data Server Driver for JDBC and SQLJ support	IBM Informix JDBC Driver support
<code>deregisterDriver</code>	Yes	Yes
<code>getConnection</code>	Yes	Yes
<code>getDriver</code>	Yes	Yes
<code>getDrivers</code>	Yes	Yes
<code>getLoginTimeout</code>	Yes	Yes
<code>getLogStream</code>	Yes	Yes
<code>getLogWriter</code>	Yes	Yes
<code>println</code>	Yes	Yes
<code>registerDriver</code>	Yes	Yes
<code>setLoginTimeout</code>	Yes <sup>1</sup>	Yes
<code>setLogStream</code>	Yes	Yes
<code>setLogWriter</code>	Yes	Yes

**Notes:**

1. This method is not supported for IBM Data Server Driver for JDBC and SQLJ type 2 connectivity on DB2 for z/OS.

Table 75. Support for *java.sql.ParameterMetaData* methods

JDBC method	IBM Data Server Driver for JDBC and SQLJ support	IBM Informix JDBC Driver support
<code>getParameterClassName</code>	No	No
<code>getParameterCount</code>	Yes	No
<code>getParameterMode</code>	Yes	No

Table 75. Support for *java.sql.ParameterMetaData* methods (continued)

JDBC method	IBM Data Server Driver for JDBC and SQLJ support	IBM Informix JDBC Driver support
<code>getParameterType</code>	Yes	No
<code>getParameterTypeName</code>	Yes	No
<code>getPrecision</code>	Yes	No
<code>getScale</code>	Yes	No
<code>isNullable</code>	Yes	No
<code>isSigned</code>	Yes	No

Table 76. Support for *javax.sql.PooledConnection* methods

JDBC method	IBM Data Server Driver for JDBC and SQLJ support	IBM Informix JDBC Driver support
<code>addConnectionEventListener</code>	Yes	Yes
<code>addStatementEventListener</code> <sup>1</sup>	Yes	No
<code>close</code>	Yes	Yes
<code>getConnection</code>	Yes	Yes
<code>removeConnectionEventListener</code>	Yes	Yes
<code>removeStatementEventListener</code> <sup>1</sup>	Yes	No

**Notes:**

1. This is a JDBC 4.0 method.

Table 77. Support for *java.sql.PreparedStatement* methods

JDBC method	IBM Data Server Driver for JDBC and SQLJ support	IBM Informix JDBC Driver support
Methods inherited from <code>java.sql.Statement</code>	Yes	Yes
<code>addBatch</code>	Yes	Yes
<code>clearParameters</code>	Yes	Yes
<code>execute</code>	Yes	Yes
<code>executeQuery</code>	Yes	Yes
<code>executeUpdate</code>	Yes	Yes
<code>getMetaData</code>	Yes	Yes
<code>getParameterMetaData</code>	Yes	Yes
<code>setArray</code>	No	No
<code>setAsciiStream</code>	Yes <sup>1,2</sup>	Yes
<code>setBigDecimal</code>	Yes	Yes
<code>setBinaryStream</code>	Yes <sup>1,3</sup>	Yes
<code>setBlob</code>	Yes <sup>4</sup>	Yes
<code>setBoolean</code>	Yes	Yes
<code>setByte</code>	Yes	Yes
<code>setBytes</code>	Yes	Yes
<code>setCharacterStream</code>	Yes <sup>1,5</sup>	Yes
<code>setClob</code>	Yes <sup>6</sup>	Yes

Table 77. Support for *java.sql.PreparedStatement* methods (continued)

JDBC method	IBM Data Server Driver for JDBC and SQLJ support	IBM Informix JDBC Driver support
setDate	Yes <sup>8</sup>	Yes <sup>8</sup>
setDouble	Yes	Yes
setFloat	Yes	Yes
setInt	Yes	Yes
setLong	Yes	Yes
setNull	Yes <sup>9</sup>	Yes <sup>9</sup>
setObject	Yes	Yes
setRef	No	No
setRowId <sup>7</sup>	Yes	No
setShort	Yes	Yes
setString	Yes <sup>10</sup>	Yes <sup>10</sup>
setTime	Yes <sup>8</sup>	Yes <sup>8</sup>
setTimestamp	Yes <sup>8</sup>	Yes <sup>8</sup>
setUnicodeStream	Yes	Yes
setURL	Yes	Yes

**Notes:**

1. If the value of the *length* parameter is -1, all of the data from the *InputStream* or *Reader* is read and sent to the data source.
2. Supported forms of this method include the following JDBC 4.0 forms:  
`setAsciiStream(int parameterIndex, InputStream x, long length)`  
`setAsciiStream(int parameterIndex, InputStream x)`
3. Supported forms of this method include the following JDBC 4.0 forms:  
`setBinaryStream(int parameterIndex, InputStream x, long length)`  
`setBinaryStream(int parameterIndex, InputStream x)`
4. Supported forms of this method include the following JDBC 4.0 form:  
`setBlob(int parameterIndex, InputStream inputStream, long length)`
5. Supported forms of this method include the following JDBC 4.0 forms:  
`setCharacterStream(int parameterIndex, Reader reader, long length)`  
`setCharacterStream(int parameterIndex, Reader reader)`
6. Supported forms of this method include the following JDBC 4.0 form:  
`setClob(int parameterIndex, Reader reader, long length)`
7. This is a JDBC 4.0 method.
8. The database server does no timezone adjustment for datetime values. The JDBC driver adjusts a value for the local timezone before sending the value to the server if you specify a form of the `setDate`, `setTime`, or `setTimestamp` method that includes a `java.util.Calendar` parameter.
9. The following form of `setNull` is not supported:  
`setNull(int parameterIndex, int jdbcType, String typeName)`
10. `setString` is not supported if the column has the FOR BIT DATA attribute or the data type is BLOB.

Table 78. Support for *java.sql.Ref* methods

JDBC method	IBM Data Server Driver for JDBC and SQLJ support	IBM Informix JDBC Driver support
get BaseTypeName	No	No



Table 79. Support for *java.sql.ResultSet* methods

JDBC method	IBM Data Server Driver for JDBC and SQLJ support	IBM Informix JDBC Driver support
absolute	Yes	Yes
afterLast	Yes	Yes
beforeFirst	Yes	Yes
cancelRowUpdates	Yes	No
clearWarnings	Yes	Yes
close	Yes	Yes
deleteRow	Yes	No
findColumn	Yes	Yes
first	Yes	Yes
getArray	No	No
getAsciiStream	Yes	Yes
getBigDecimal	Yes	Yes
getBinaryStream	Yes <sup>1</sup>	Yes
getBlob	Yes	Yes
getBoolean	Yes	Yes
getByte	Yes	Yes
getBytes	Yes	Yes
getCharacterStream	Yes	Yes
getClob	Yes	Yes
getConcurrency	Yes	Yes
getCursorName	Yes	Yes
getDate	Yes <sup>3</sup>	Yes <sup>3</sup>
getDouble	Yes	Yes
getFetchDirection	Yes	Yes
getFetchSize	Yes	Yes
getFloat	Yes	Yes
getInt	Yes	Yes
getLong	Yes	Yes
getMetaData	Yes	Yes
getObject	Yes <sup>4</sup>	Yes <sup>4</sup>
getRef	No	No
getRow	Yes	Yes
getRowId <sup>10</sup>	Yes	No
getShort	Yes	Yes
getStatement	Yes	Yes
getString	Yes	Yes
getTime	Yes <sup>3</sup>	Yes <sup>3</sup>
getTimestamp	Yes <sup>3</sup>	Yes <sup>3</sup>
getType	Yes	Yes

Table 79. Support for `java.sql.ResultSet` methods (continued)

JDBC method	IBM Data Server Driver for JDBC and SQLJ support	IBM Informix JDBC Driver support
<code>getUnicodeStream</code>	Yes	Yes
<code>getURL</code>	Yes	Yes
<code>getWarnings</code>	Yes	Yes
<code>insertRow</code>	Yes	No
<code>isAfterLast</code>	Yes	Yes
<code>isBeforeFirst</code>	Yes	Yes
<code>isFirst</code>	Yes	Yes
<code>isLast</code>	Yes	Yes
<code>last</code>	Yes	Yes
<code>moveToCurrentRow</code>	Yes	No
<code>moveToInsertRow</code>	Yes	No
<code>next</code>	Yes	Yes
<code>previous</code>	Yes	Yes
<code>refreshRow</code>	Yes	No
<code>relative</code>	Yes	Yes
<code>rowDeleted</code>	Yes	No
<code>rowInserted</code>	Yes	No
<code>rowUpdated</code>	Yes	No
<code>setFetchDirection</code>	Yes	Yes
<code>setFetchSize</code>	Yes	Yes
<code>updateArray</code>	No	No
<code>updateAsciiStream</code>	Yes <sup>5</sup>	No
<code>updateBigDecimal</code>	Yes	No
<code>updateBinaryStream</code>	Yes <sup>6</sup>	No
<code>updateBlob</code>	Yes <sup>7</sup>	No
<code>updateBoolean</code>	Yes	No
<code>updateByte</code>	Yes	No
<code>updateBytes</code>	Yes	No
<code>updateCharacterStream</code>	Yes <sup>8</sup>	No
<code>updateClob</code>	Yes <sup>9</sup>	No
<code>updateDate</code>	Yes	No
<code>updateDouble</code>	Yes	No
<code>updateFloat</code>	Yes	No
<code>updateInt</code>	Yes	No
<code>updateLong</code>	Yes	No
<code>updateNull</code>	Yes	No
<code>updateObject</code>	Yes	No
<code>updateRef</code>	No	No
<code>updateRow</code>	Yes	No

Table 79. Support for *java.sql.ResultSet* methods (continued)

JDBC method	IBM Data Server Driver for JDBC and SQLJ support	IBM Informix JDBC Driver support
<code>updateRowId</code> <sup>10</sup>	Yes	No
<code>updateShort</code>	Yes	No
<code>updateString</code>	Yes	No
<code>updateTime</code>	Yes	No
<code>updateTimestamp</code>	Yes	No
<code>wasNull</code>	Yes	Yes

**Notes:**

- `getBinaryStream` is not supported for CLOB columns.
- `getMetaData` pads the schema name, if the returned schema name is less than 8 characters, to fill 8 characters.
- The database server does no timezone adjustment for datetime values. The JDBC driver adjusts a value for the local timezone after retrieving the value from the server if you specify a form of the `getDate`, `getTime`, or `getTimestamp` method that includes a `java.util.Calendar` parameter.
- The following form of the `getObject` method is not supported:  
`getObject(int parameterIndex, java.util.Map map)`
- Supported forms of this method include the following JDBC 4.0 forms:  
`updateAsciiStream(int columnIndex, InputStream x)`  
`updateAsciiStream(String columnLabel, InputStream x)`  
`updateAsciiStream(int columnIndex, InputStream x, long length)`  
`updateAsciiStream(String columnLabel, InputStream x, long length)`
- Supported forms of this method include the following JDBC 4.0 forms:  
`updateBinaryStream(int columnIndex, InputStream x)`  
`updateBinaryStream(String columnLabel, InputStream x)`  
`updateBinaryStream(int columnIndex, InputStream x, long length)`  
`updateBinaryStream(String columnLabel, InputStream x, long length)`
- Supported forms of this method include the following JDBC 4.0 forms:  
`updateBlob(int columnIndex, InputStream x)`  
`updateBlob(String columnLabel, InputStream x)`  
`updateBlob(int columnIndex, InputStream x, long length)`  
`updateBlob(String columnLabel, InputStream x, long length)`
- Supported forms of this method include the following JDBC 4.0 forms:  
`updateCharacterStream(int columnIndex, Reader reader)`  
`updateCharacterStream(String columnLabel, Reader reader)`  
`updateCharacterStream(int columnIndex, Reader reader, long length)`  
`updateCharacterStream(String columnLabel, Reader reader, long length)`
- Supported forms of this method include the following JDBC 4.0 forms:  
`updateClob(int columnIndex, Reader reader)`  
`updateClob(String columnLabel, Reader reader)`  
`updateClob(int columnIndex, Reader reader, long length)`  
`updateClob(String columnLabel, Reader reader, long length)`
- This is a JDBC 4.0 method.

Table 80. Support for *java.sql.ResultSetMetaData* methods

JDBC method	IBM Data Server Driver for JDBC and SQLJ support	IBM Informix JDBC Driver support
<code>getCatalogName</code>	Yes	Yes
<code>getColumnClassName</code>	No	Yes
<code>getColumnCount</code>	Yes	Yes
<code>getColumnDisplaySize</code>	Yes	Yes

Table 80. Support for *java.sql.ResultSetMetaData* methods (continued)

JDBC method	IBM Data Server Driver for JDBC and SQLJ support	IBM Informix JDBC Driver support
<code>getColumnLabel</code>	Yes	Yes
<code>getColumnName</code>	Yes	Yes
<code>getColumnType</code>	Yes	Yes
<code>getColumnTypeName</code>	Yes	Yes
<code>getPrecision</code>	Yes	Yes
<code>getScale</code>	Yes	Yes
<code>getSchemaName</code>	Yes	Yes
<code>getTableName</code>	Yes <sup>1</sup>	Yes
<code>isAutoIncrement</code>	Yes	Yes
<code>isCaseSensitive</code>	Yes	Yes
<code>isCurrency</code>	Yes	Yes
<code>isDefinitelyWritable</code>	Yes	Yes
<code>isNullable</code>	Yes	Yes
<code>isReadOnly</code>	Yes	Yes
<code>isSearchable</code>	Yes	Yes
<code>isSigned</code>	Yes	Yes
<code>isWritable</code>	Yes	Yes

**Notes:**

1. For IBM Informix data sources, `getTableName` does not return a value.
2. `getSchemaName` pads the schema name, if the returned schema name is less than 8 characters, to fill 8 characters.

Table 81. Support for *java.sql.RowId* methods<sup>1</sup>

JDBC method	IBM Data Server Driver for JDBC and SQLJ support <sup>2</sup>	IBM Informix JDBC Driver support
<code>equals</code>	Yes	No
<code>getBytes</code>	Yes	No
<code>hashCode</code>	No	No
<code>toString</code>	Yes	No

**Notes:**

1. These methods are JDBC 4.0 methods.
2. These methods are supported for connections to DB2 for z/OS, DB2 for i, and IBM Informix data sources.

Table 82. Support for *java.sql.SQLClientInfoException* methods<sup>1</sup>

JDBC method	IBM Data Server Driver for JDBC and SQLJ support	IBM Informix JDBC Driver support
Methods inherited from <code>java.lang.Exception</code>	Yes	No
Methods inherited from <code>java.lang.Throwable</code>	Yes	No
Methods inherited from <code>java.lang.Object</code>	Yes	No
<code>getFailedProperties</code>	Yes	No

**Note:**

1. This is a JDBC 4.0 class.

Table 83. Support for *java.sql.SQLData* methods

JDBC method	IBM Data Server Driver for JDBC and SQLJ support	IBM Informix JDBC Driver support
getSQLTypeName	No	No
readSQL	No	No
writeSQL	No	No

Table 84. Support for *java.sql.SQLDataException* methods<sup>1</sup>

JDBC method	IBM Data Server Driver for JDBC and SQLJ support	IBM Informix JDBC Driver support
Methods inherited from <i>java.lang.Exception</i>	Yes	No
Methods inherited from <i>java.lang.Throwable</i>	Yes	No
Methods inherited from <i>java.lang.Object</i>	Yes	No

**Note:**

1. This is a JDBC 4.0 class.

Table 85. Support for *java.sql.SQLDataException* methods<sup>1</sup>

JDBC method	IBM Data Server Driver for JDBC and SQLJ support	IBM Informix JDBC Driver support
Methods inherited from <i>java.lang.Exception</i>	Yes	No
Methods inherited from <i>java.lang.Throwable</i>	Yes	No
Methods inherited from <i>java.lang.Object</i>	Yes	No

**Note:**

1. This is a JDBC 4.0 class.

Table 86. Support for *java.sql.SQLException* methods

JDBC method	IBM Data Server Driver for JDBC and SQLJ support	IBM Informix JDBC Driver support
Methods inherited from <i>java.lang.Exception</i>	Yes	Yes
getSQLState	Yes	Yes
getErrorCode	Yes	Yes
getNextException	Yes	Yes
setNextException	Yes	Yes

Table 87. Support for *java.sql.SQLFeatureNotSupportedException* methods<sup>1</sup>

JDBC method	IBM Data Server Driver for JDBC and SQLJ support	IBM Informix JDBC Driver support
Methods inherited from <i>java.lang.Exception</i>	Yes	No
Methods inherited from <i>java.lang.Throwable</i>	Yes	No
Methods inherited from <i>java.lang.Object</i>	Yes	No

**Note:**

1. This is a JDBC 4.0 class.

Table 88. Support for *java.sql.SQLInput* methods

JDBC method	IBM Data Server Driver for JDBC and SQLJ support	IBM Informix JDBC Driver support
readArray	No	No
readAsciiStream	No	No
readBigDecimal	No	No
readBinaryStream	No	No
readBlob	No	No
readBoolean	No	No
readByte	No	No
readBytes	No	No
readCharacterStream	No	No
readClob	No	No
readDate	No	No
readDouble	No	No
readFloat	No	No
readInt	No	No
readLong	No	No
readObject	No	No
readRef	No	No
readShort	No	No
readString	No	No
readTime	No	No
readTimestamp	No	No
wasNull	No	No

Table 89. Support for *java.sql.SQLIntegrityConstraintViolationException* methods<sup>1</sup>

JDBC method	IBM Data Server Driver for JDBC and SQLJ support	IBM Informix JDBC Driver support
Methods inherited from <i>java.lang.Exception</i>	Yes	No
Methods inherited from <i>java.lang.Throwable</i>	Yes	No
Methods inherited from <i>java.lang.Object</i>	Yes	No

**Note:**

1. This is a JDBC 4.0 class.

Table 90. Support for *java.sql.SQLInvalidAuthorizationSpecException* methods<sup>1</sup>

JDBC method	IBM Data Server Driver for JDBC and SQLJ support	IBM Informix JDBC Driver support
Methods inherited from <i>java.lang.Exception</i>	Yes	No
Methods inherited from <i>java.lang.Throwable</i>	Yes	No
Methods inherited from <i>java.lang.Object</i>	Yes	No

**Note:**

1. This is a JDBC 4.0 class.

Table 91. Support for *java.sql.SQLNonTransientConnectionException* methods<sup>1</sup>

JDBC method	IBM Data Server Driver for JDBC and SQLJ support	IBM Informix JDBC Driver support
Methods inherited from <i>java.lang.Exception</i>	Yes	No
Methods inherited from <i>java.lang.Throwable</i>	Yes	No
Methods inherited from <i>java.lang.Object</i>	Yes	No

**Note:**

1. This is a JDBC 4.0 class.

Table 92. Support for *java.sql.SQLNonTransientException* methods<sup>1</sup>

JDBC method	IBM Data Server Driver for JDBC and SQLJ support	IBM Informix JDBC Driver support
Methods inherited from <i>java.lang.Exception</i>	Yes	No
Methods inherited from <i>java.lang.Throwable</i>	Yes	No
Methods inherited from <i>java.lang.Object</i>	Yes	No

**Note:**

1. This is a JDBC 4.0 class.

Table 93. Support for *java.sql.SQLOutput* methods

JDBC method	IBM Data Server Driver for JDBC and SQLJ support	IBM Informix JDBC Driver support
<i>writeArray</i>	No	No
<i>writeAsciiStream</i>	No	No
<i>writeBigDecimal</i>	No	No
<i>writeBinaryStream</i>	No	No
<i>writeBlob</i>	No	No
<i>writeBoolean</i>	No	No
<i>writeByte</i>	No	No
<i>writeBytes</i>	No	No
<i>writeCharacterStream</i>	No	No
<i>writeClob</i>	No	No
<i>writeDate</i>	No	No
<i>writeDouble</i>	No	No
<i>writeFloat</i>	No	No
<i>writeInt</i>	No	No
<i>writeLong</i>	No	No
<i>writeObject</i>	No	No
<i>writeRef</i>	No	No
<i>writeShort</i>	No	No
<i>writeString</i>	No	No
<i>writeStruct</i>	No	No
<i>writeTime</i>	No	No
<i>writeTimestamp</i>	No	No



Table 94. Support for *java.sql.SQLRecoverableException* methods<sup>1</sup>

JDBC method	IBM Data Server Driver for JDBC and SQLJ support	IBM Informix JDBC Driver support
Methods inherited from <i>java.lang.Exception</i>	Yes	No
Methods inherited from <i>java.lang.Throwable</i>	Yes	No
Methods inherited from <i>java.lang.Object</i>	Yes	No

**Note:**

1. This is a JDBC 4.0 class.

Table 95. Support for *java.sql.SQLSyntaxErrorException* methods<sup>1</sup>

JDBC method	IBM Data Server Driver for JDBC and SQLJ support	IBM Informix JDBC Driver support
Methods inherited from <i>java.lang.Exception</i>	Yes	No
Methods inherited from <i>java.lang.Throwable</i>	Yes	No
Methods inherited from <i>java.lang.Object</i>	Yes	No

**Note:**

1. This is a JDBC 4.0 class.

Table 96. Support for *java.sql.SQLTimeoutException* methods<sup>1</sup>

JDBC method	IBM Data Server Driver for JDBC and SQLJ support	IBM Informix JDBC Driver support
Methods inherited from <i>java.lang.Exception</i>	Yes	No
Methods inherited from <i>java.lang.Throwable</i>	Yes	No
Methods inherited from <i>java.lang.Object</i>	Yes	No

**Note:**

1. This is a JDBC 4.0 class.

Table 97. Support for *java.sql.SQLTransientConnectionException* methods<sup>1</sup>

JDBC method	IBM Data Server Driver for JDBC and SQLJ support	IBM Informix JDBC Driver support
Methods inherited from <i>java.lang.Exception</i>	Yes	No
Methods inherited from <i>java.lang.Throwable</i>	Yes	No
Methods inherited from <i>java.lang.Object</i>	Yes	No

**Note:**

1. This is a JDBC 4.0 class.

Table 98. Support for *java.sql.SQLTransientException* methods<sup>1</sup>

JDBC method	IBM Data Server Driver for JDBC and SQLJ support	IBM Informix JDBC Driver support
Methods inherited from <i>java.lang.Exception</i>	Yes	No
Methods inherited from <i>java.lang.Throwable</i>	Yes	No
Methods inherited from <i>java.lang.Object</i>	Yes	No

**Note:**

1. This is a JDBC 4.0 class.

Table 99. Support for *java.sql.SQLTransientRollbackException* methods<sup>1</sup>

JDBC method	IBM Data Server Driver for JDBC and SQLJ support	IBM Informix JDBC Driver support
Methods inherited from <i>java.lang.Exception</i>	Yes	No
Methods inherited from <i>java.lang.Throwable</i>	Yes	No
Methods inherited from <i>java.lang.Object</i>	Yes	No

**Note:**

1. This is a JDBC 4.0 class.

Table 100. Support for *java.sql.SQLXML* methods<sup>1</sup>

JDBC method	IBM Data Server Driver for JDBC and SQLJ support	IBM Informix JDBC Driver support
<i>free</i>	Yes	No
<i>getBinaryStream</i>	Yes	No
<i>getCharacterStream</i>	Yes	No
<i>getSource</i>	Yes	No
<i>getString</i>	Yes	No
<i>setBinaryStream</i>	Yes	No
<i>setCharacterStream</i>	Yes	No
<i>setResult</i>	Yes	No
<i>setString</i>	Yes	No

**Notes:**

1. These are JDBC 4.0 methods. These methods are not supported for connections to IBM Informix servers.

Table 101. Support for *java.sql.Statement* methods

JDBC method	IBM Data Server Driver for JDBC and SQLJ support	IBM Informix JDBC Driver support
<i>abort</i> <sup>1</sup>	Yes	No
<i>addBatch</i>	Yes	Yes
<i>cancel</i>	Yes <sup>2</sup>	Yes
<i>clearBatch</i>	Yes	Yes
<i>clearWarnings</i>	Yes	Yes
<i>close</i>	Yes	Yes
<i>closeOnCompletion</i> <sup>1</sup>	Yes	No
<i>execute</i>	Yes	Yes
<i>executeBatch</i>	Yes	Yes
<i>executeQuery</i>	Yes	Yes
<i>executeUpdate</i>	Yes	Yes
<i>getConnection</i>	Yes	Yes
<i>getFetchDirection</i>	Yes	Yes
<i>getFetchSize</i>	Yes	Yes
<i>getGeneratedKeys</i>	Yes	No
<i>getMaxFieldSize</i>	Yes	Yes

Table 101. Support for `java.sql.Statement` methods (continued)

JDBC method	IBM Data Server Driver for JDBC and SQLJ support	IBM Informix JDBC Driver support
<code>getMaxRows</code>	Yes	Yes
<code>getMoreResults</code>	Yes	Yes
<code>getQueryTimeout</code>	Yes <sup>6,5</sup>	Yes
<code>getResultSet</code>	Yes	Yes
<code>getResultSetConcurrency</code>	Yes	Yes
<code>getResultSetHoldability</code>	Yes	No
<code>getResultSetType</code>	Yes	Yes
<code>getUpdateCount</code> <sup>3</sup>	Yes	Yes
<code>getWarnings</code>	Yes	Yes
<code>isCloseOnCompletion</code> <sup>1</sup>	Yes	No
<code>isClosed</code> <sup>7</sup>	Yes	No
<code>isPoolable</code> <sup>7</sup>	Yes	No
<code>setCursorName</code>	Yes	Yes
<code>setEscapeProcessing</code>	Yes	Yes
<code>setFetchDirection</code>	Yes	Yes
<code>setFetchSize</code>	Yes	Yes
<code>setMaxFieldSize</code>	Yes	Yes
<code>setMaxRows</code>	Yes	Yes
<code>setPoolable</code> <sup>7</sup>	Yes	No
<code>setQueryTimeout</code>	Yes <sup>4,6,5</sup>	Yes

Table 101. Support for *java.sql.Statement* methods (continued)

JDBC method	IBM Data Server Driver for JDBC and SQLJ support	IBM Informix JDBC Driver support
<b>Notes:</b>		
1. This is a JDBC 4.1 method.		
2. For the IBM Data Server Driver for JDBC and SQLJ, <code>Statement.cancel</code> is supported only in the following environments: <ul style="list-style-type: none"> <li>• Type 2 and type 4 connectivity from a Linux, UNIX, or Windows client to a DB2 Database for Linux, UNIX, and Windows server, Version 8 or later</li> <li>• Type 2 and type 4 connectivity from a Linux, UNIX, or Windows client to a DB2 for z/OS server, Version 9 or later</li> <li>• Type 4 connectivity from a z/OS client to a DB2 Database for Linux, UNIX, and Windows server, Version 8 or later</li> <li>• Type 4 connectivity from a z/OS client to a DB2 for z/OS server, Version 8 or later</li> </ul> The action that the IBM Data Server Driver for JDBC and SQLJ takes when the application executes <code>Statement.cancel</code> is also dependent on the setting of the <code>DB2BaseDataSource.interruptProcessingMode</code> property.		
3. Not supported for stored procedure ResultSets.		
4. For DB2 for i, this method is supported only for a <i>seconds</i> value of 0.		
5. For IBM Data Server Driver for JDBC and SQLJ type 2 connectivity on DB2 for z/OS, <code>Statement.setQueryTimeout</code> is supported only if <code>Connection</code> or <code>DataSource</code> property <code>queryTimeoutInterruptProcessingMode</code> is set to <code>INTERRUPT_PROCESSING_MODE_CLOSE_SOCKET</code> .		
6. For the IBM Data Server Driver for JDBC and SQLJ Version 4.0 and later, <code>Statement.setQueryTimeout</code> is supported for the following methods: <ul style="list-style-type: none"> <li>• <code>Statement.execute</code></li> <li>• <code>Statement.executeUpdate</code></li> <li>• <code>Statement.executeQuery</code></li> </ul> <code>Statement.setQueryTimeout</code> is not supported for the <code>Statement.executeBatch</code> method.		
7. This is a JDBC 4.0 method.		

Table 102. Support for *java.sql.Struct* methods

JDBC method	IBM Data Server Driver for JDBC and SQLJ support	IBM Informix JDBC Driver support
<code>getSQLTypeName</code>	No	No
<code>getAttributes</code>	No	No

Table 103. Support for *java.sql Wrapper* methods

JDBC method <sup>1</sup>	IBM Data Server Driver for JDBC and SQLJ support	IBM Informix JDBC Driver support
<code>isWrapperFor</code>	Yes	No
<code>unwrap</code>	Yes	No

**Notes:**

1. These are JDBC 4.0 methods.

Table 104. Support for *javax.sql.XAConnection* methods

JDBC method	IBM Data Server Driver for JDBC and SQLJ support <sup>1</sup>	IBM Informix JDBC Driver support
Methods inherited from <code>javax.sql.PooledConnection</code>	Yes	Yes
<code>getXAResource</code>	Yes	Yes

Table 104. Support for `javax.sql.XAConnection` methods (continued)

JDBC method	IBM Data Server Driver for JDBC and SQLJ support <sup>1</sup>	IBM Informix JDBC Driver support
<b>Notes:</b>		
1. These methods are supported for IBM Data Server Driver for JDBC and SQLJ type 2 connectivity to a DB2 Database for Linux, UNIX, and Windows server or IBM Data Server Driver for JDBC and SQLJ type 4 connectivity.		

Table 105. Support for `javax.sql.XADataSource` methods

JDBC method	IBM Data Server Driver for JDBC and SQLJ support	IBM Informix JDBC Driver support
<code>getLoginTimeout</code>	Yes	Yes
<code>getLogWriter</code>	Yes	Yes
<code>getXAConnection</code>	Yes	Yes
<code>setLoginTimeout</code>	Yes	Yes
<code>setLogWriter</code>	Yes	Yes

Table 106. Support for `javax.transaction.xa.XAResource` methods

JDBC method	IBM Data Server Driver for JDBC and SQLJ support	IBM Informix JDBC Driver support
<code>commit</code>	Yes <sup>1</sup>	Yes
<code>end</code>	Yes <sup>1, 2</sup>	Yes
<code>forget</code>	Yes <sup>1</sup>	Yes
<code>getTransactionTimeout</code>	Yes <sup>3</sup>	Yes
<code>isSameRM</code>	Yes <sup>1</sup>	Yes
<code>prepare</code>	Yes <sup>1</sup>	Yes
<code>recover</code>	Yes <sup>1</sup>	Yes
<code>rollback</code>	Yes <sup>1</sup>	Yes
<code>setTransactionTimeout</code>	Yes <sup>3</sup>	Yes
<code>start</code>	Yes <sup>1</sup>	Yes

**Notes:**

1. This method is supported for IBM Data Server Driver for JDBC and SQLJ type 2 connectivity to a DB2 Database for Linux, UNIX, and Windows server or IBM Data Server Driver for JDBC and SQLJ type 4 connectivity.
2. When the `end` method is called, the IBM Data Server Driver for JDBC and SQLJ closes the underlying cursor, even if the `TMSUSPEND` flag is specified.
3. This method is supported for IBM Data Server Driver for JDBC and SQLJ type 4 connectivity to DB2 Database for Linux, UNIX, and Windows Version 9.1 or later.

## IBM Data Server Driver for JDBC and SQLJ support for SQL escape syntax

The IBM Data Server Driver for JDBC and SQLJ supports SQL escape syntax, as described in the JDBC 1.0 specification.

This is the same syntax that is used in vendor escape clauses in ODBC and CLI applications.

SQL escape syntax is supported in JDBC and SQLJ applications.

---

## SQLJ statement reference information

SQLJ statements are used for transaction control and SQL statement execution.

### SQLJ clause

The SQL statements in an SQLJ program are in SQLJ clauses.

#### Syntax



#### Usage notes

Keywords in an SQLJ clause are case sensitive, unless those keywords are part of an SQL statement in an executable clause.

### SQLJ host-expression

A host expression is a Java variable or expression that is referenced by SQLJ clauses in an SQLJ application program.

#### Syntax



#### Description

- : Indicates that the variable or expression that follows is a host expression. The colon must immediately precede the variable or expression.

#### IN|OUT|INOUT

For a host expression that is used as a parameter in a stored procedure call, identifies whether the parameter provides data to the stored procedure (IN), retrieves data from the stored procedure (OUT), or does both (INOUT). The default is IN.

#### simple-variable

Specifies a Java unqualified identifier.

#### complex-expression

Specifies a Java expression that results in a single value.

#### INDICATOR :simple-variable or INDICATOR :(complex-expression)

Specifies the optional indicator variable for the corresponding Java host variable. The data type of the indicator variable must be the Java short type. The only valid values for :simple-variable or :(complex-expression) are:

For customized applications, and for input, only these values are valid:

Indicator value	Equivalent constant	Meaning of value
-1	sqlj.runtime.ExecutionContext.DBNull	Null
-2, -3, -4, -6		Null
-5	sqlj.runtime.ExecutionContext.DBDefault	Default
-7	sqlj.runtime.ExecutionContext.DBUnassigned	Unassigned
<i>short-value</i> >=0	sqlj.runtime.ExecutionContext.DBNonNull	Non-null

For uncustomized applications, and for input, only these values are valid:

Indicator value	Equivalent constant	Meaning of value
-1	sqlj.runtime.ExecutionContext.DBNull	Null
-7 <= <i>short-value</i> < -1		Null
0	sqlj.runtime.ExecutionContext.DBNonNull	Non-null
<i>short-value</i> >0		Non-null

For customized or uncustomized applications, and for output, SQLJ sets one of these values:

Indicator value	Equivalent constant	Meaning of value
-1	sqlj.runtime.ExecutionContext.DBNull	Retrieved value is SQL NULL
0		Retrieved value is not SQL NULL

## Usage notes

- A complex expression must be enclosed in parentheses.
- ANSI/ISO rules govern where a host expression can appear in a static SQL statement.
- Indicator variables are required in the following cases:
  - For input, when a Java primitive type is used to assign the NULL value to a table column.
  - For output, when a Java primitive type is used for a host variable, and the source column can return NULL values.

If an SQL NULL value is returned, and no indicator variable is defined, an `SQLException` is thrown.

Indicator variables are not required for input or output of a Java null value as an SQL NULL, if the data type of the host variable is:

- The data type of a Java class
- A custom database type that the driver supports
- , ... *variable-n*
- For output, indicator variables are valid in the following types of statements:
  - CALL statement with OUT or INOUT parameters
  - FETCH *positioned-iterator* INTO *variable-1*, ... *variable-n*
  - SELECT *column-1*, ... *column-n* INTO *variable-1*, ... *variable-n*

## SQLJ implements-clause

The implements clause derives one or more classes from a Java interface.

## Syntax



### interface-element:



## Description

### interface-element

Specifies a user-defined Java interface, the SQLJ interface `sqlj.runtime.ForUpdate` or the SQLJ interface `sqlj.runtime.Scrollable`.

You need to implement `sqlj.runtime.ForUpdate` when you declare an iterator for a positioned UPDATE or positioned DELETE operation. See "Perform positioned UPDATE and DELETE operations in an SQLJ application" for information on performing a positioned UPDATE or positioned DELETE operation in SQLJ.

You need to implement `sqlj.runtime.Scrollable` when you declare a scrollable iterator. See "Use scrollable iterators in an SQLJ application" for information on scrollable iterators.

## SQLJ with-clause

The with clause specifies a set of one or more attributes for an iterator or a connection context.

## Syntax



### with-element:

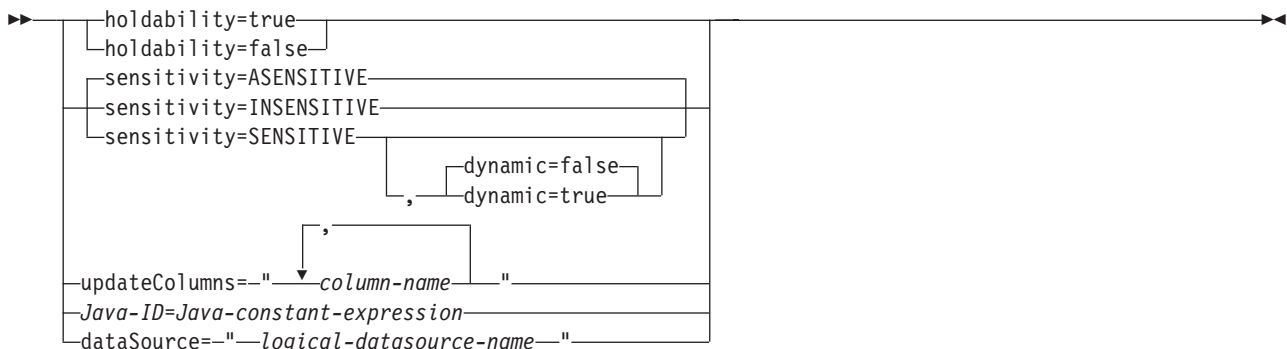



## Description

### **holdability**

For an iterator, specifies whether an iterator keeps its position in a table after a COMMIT is executed. The value for holdability must be true or false.

### **sensitivity**

For an iterator, specifies whether changes that are made to the underlying table can be visible to the iterator after it is opened. The value must be INSENSITIVE, SENSITIVE, or ASENSITIVE. The default is ASENSITIVE.

For connections to IBM Informix, only INSENSITIVE is supported.

### **dynamic**

For an iterator that is defined with sensitivity=SENSITIVE, specifies whether the following cases are true:

- When the application executes positioned UPDATE and DELETE statements with the iterator, those changes are visible to the iterator.
- When the application executes INSERT, UPDATE, and DELETE statements within the application but outside the iterator, those changes are visible to the iterator.

The value for dynamic must be true or false. The default is false.

DB2 Database for Linux, UNIX, and Windows servers do not support dynamic scrollable cursors. Specify true only if your application accesses data on DB2 for z/OS servers, at Version 9 or later.

For connections to IBM Informix, only false is supported. IBM Informix does not support dynamic cursors.

### **updateColumns**

For an iterator, specifies the columns that are to be modified when the iterator is used for a positioned UPDATE statement. The value for updateColumns must be a literal string that contains the column names, separated by commas.

### **column-name**

For an iterator, specifies a column of the result table that is to be updated using the iterator.

### **Java-ID**

For an iterator or connection context, specifies a Java variable that identifies a user-defined attribute of the iterator or connection context. The value of *Java-constant-expression* is also user-defined.

### **dataSource**

For a connection context, specifies the logical name of a separately-created DataSource object that represents the data source to which the application will connect. This option is available only for the IBM Data Server Driver for JDBC and SQLJ.

## Usage notes

- The value on the left side of a with element must be unique within its with clause.
- If you specify updateColumns in a with element of an iterator declaration clause, the iterator declaration clause must also contain an implements clause that specifies the sqlj.runtime.ForUpdate interface.
- If you do not customize your SQLJ program, the JDBC driver ignores the value of holdability that is in the with clause. Instead, the driver uses the JDBC driver setting for holdability.

## SQLJ connection-declaration-clause

The connection declaration clause declares a connection to a data source in an SQLJ application program.

### Syntax

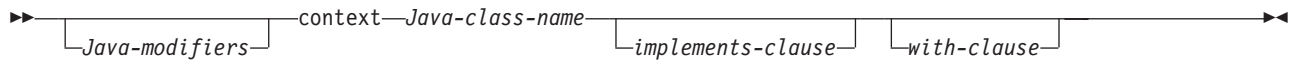

### Description

#### Java-modifiers

Specifies modifiers that are valid for Java class declarations, such as static, public, private, or protected.

#### Java-class-name

Specifies a valid Java identifier. During the program preparation process, SQLJ generates a connection context class whose name is this identifier.

#### implements-clause

See "SQLJ implements-clause" for a description of this clause. In a connection declaration clause, the interface class to which the implements clause refers must be a user-defined interface class.

#### with-clause

See "SQLJ with-clause" for a description of this clause.

### Usage notes

- SQLJ generates a connection class declaration for each connection declaration clause you specify. SQLJ data source connections are objects of those generated connection classes.
- You can specify a connection declaration clause anywhere that a Java class definition can appear in a Java program.

## SQLJ iterator-declaration-clause

An iterator declaration clause declares a positioned iterator class or a named iterator class in an SQLJ application program.

An iterator contains the result table from a query. SQLJ generates an iterator class for each iterator declaration clause you specify. An iterator is an object of an iterator class.

An iterator declaration clause has a form for a positioned iterator and a form for a named iterator. The two kinds of iterators are distinct and incompatible Java types that are implemented with different interfaces.

### Syntax

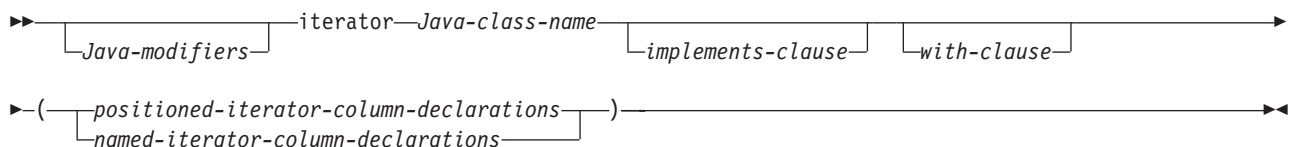

#### positioned-iterator-column declarations:



#### **named-iterator-column-declarations:**



## **Description**

### **Java-modifiers**

Any modifiers that are valid for Java class declarations, such as static, public, private, or protected.

### **Java-class-name**

Any valid Java identifier. During the program preparation process, SQLJ generates an iterator class whose name is this identifier.

### **implements-clause**

See "SQLJ implements-clause" for a description of this clause. For an iterator declaration clause that declares an iterator for a positioned UPDATE or positioned DELETE operation, the implements clause must specify interface `sqlj.runtime.ForUpdate`. For an iterator declaration clause that declares a scrollable iterator, the implements clause must specify interface `sqlj.runtime.Scrollable`.

### **with-clause**

See "SQLJ with-clause" for a description of this clause.

### **positioned-iterator-column-declarations**

Specifies a list of Java data types, which are the data types of the columns in the positioned iterator. The data types in the list must be separated by commas. The order of the data types in the positioned iterator declaration is the same as the order of the columns in the result table. For online checking during serialized profile customization to succeed, the data types of the columns in the iterator must be compatible with the data types of the columns in the result table. See "Java, JDBC, and SQL data types" for a list of compatible data types.

### **named-iterator-column-declarations**

Specifies a list of Java data types and Java identifiers, which are the data types and names of the columns in the named iterator. Pairs of data types and names must be separated by commas. The name of a column in the iterator must match, except for case, the name of a column in the result table. For online checking during serialized profile customization to succeed, the data types of the columns in the iterator must be compatible with the data types of the columns in the result table. See "Java, JDBC, and SQL data types" for a list of compatible data types.

## **Usage notes**

- An iterator declaration clause can appear anywhere in a Java program that a Java class declaration can appear.
- When a named iterator declaration contains more than one pair of Java data types and Java IDs, all Java IDs within the list must be unique. Two Java IDs are not unique if they differ only in case.

## SQLJ executable-clause

An executable clause contains an SQL statement or an assignment statement. An assignment statement assigns the result of an SQL operation to a Java variable.

This topic describes the general form of an executable clause.

### Syntax



### Usage notes

- An executable clause can appear anywhere in a Java program that a Java statement can appear.
- SQLJ reports negative SQL codes from executable clauses through class `java.sql.SQLException`.  
If SQLJ raises a run-time exception during the execution of an executable clause, the value of any host expression of type OUT or INOUT is undefined.

## SQLJ context-clause

A context clause specifies a connection context, an execution context, or both. You use a connection context to connect to a data source. You use an execution context to monitor and modify SQL statement execution.

### Syntax

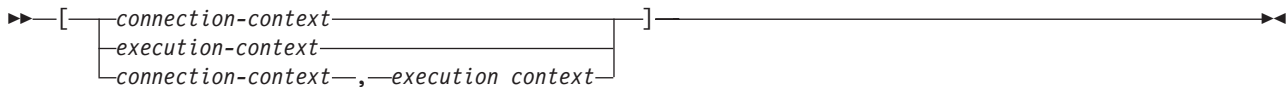

### Description

#### connection-context

Specifies a valid Java identifier that is declared earlier in the SQLJ program. That identifier must be declared as an instance of the connection context class that SQLJ generates for a connection declaration clause.

#### execution-context

Specifies a valid Java identifier that is declared earlier in the SQLJ program. That identifier must be declared as an instance of class `sqlj.runtime.ExecutionContext`.

### Usage notes

- If you do not specify a connection context in an executable clause, SQLJ uses the default connection context.
- If you do not specify an execution context, SQLJ obtains the execution context from the connection context of the statement.

## SQLJ statement-clause

A statement clause contains an SQL statement or a SET TRANSACTION clause.

## Syntax

→ { *SQL-statement* | *SET-TRANSACTION-clause* } →

### Description

#### SQL-statement

You can include SQL statements in Table 107 in a statement clause.

#### SET-TRANSACTION-clause

Sets the isolation level for SQL statements in the program and the access mode for the connection. The SET TRANSACTION clause is equivalent to the SET TRANSACTION statement, which is described in the ANSI/ISO SQL standard of 1992 and is supported in some implementations of SQL.

Table 107. Valid SQL statements in an SQLJ statement clause

Statement	Applicable data sources
ALTER DATABASE	1 on page 427, 2 on page 427
ALTER FUNCTION	1 on page 427, 2 on page 427, 3 on page 427
ALTER INDEX	1 on page 427, 2 on page 427, 3 on page 427
ALTER PROCEDURE	1 on page 427, 2 on page 427, 3 on page 427
ALTER STOGROUP	1 on page 427, 2 on page 427
ALTER TABLE	1 on page 427, 2 on page 427, 3 on page 427
ALTER TABLESPACE	1 on page 427, 2 on page 427
CALL	1 on page 427, 2 on page 427, 3 on page 427
COMMENT ON	1 on page 427, 2 on page 427
COMMIT	1 on page 427, 2 on page 427, 3 on page 427
Compound SQL (BEGIN ATOMIC...END)	2 on page 427
CREATE ALIAS	1 on page 427, 2 on page 427
CREATE DATABASE	1 on page 427, 2 on page 427, 3a on page 427
CREATE DISTINCT TYPE	1 on page 427, 2 on page 427, 3 on page 427
CREATE FUNCTION	1 on page 427, 2 on page 427, 3 on page 427
CREATE GLOBAL TEMPORARY TABLE	1 on page 427, 2 on page 427
CREATE TEMP TABLE	3 on page 427
CREATE INDEX	1 on page 427, 2 on page 427, 3 on page 427
CREATE PROCEDURE	1 on page 427, 2 on page 427, 3 on page 427
CREATE STOGROUP	1 on page 427, 2 on page 427
CREATE SYNONYM	1 on page 427, 2 on page 427, 3 on page 427
CREATE TABLE	1 on page 427, 2 on page 427, 3 on page 427
CREATE TABLESPACE	1 on page 427, 2 on page 427
CREATE TYPE (cursor)	2 on page 427
CREATE TRIGGER	1 on page 427, 2 on page 427, 3 on page 427
CREATE VIEW	1 on page 427, 2 on page 427, 3 on page 427
DECLARE GLOBAL TEMPORARY TABLE	1 on page 427, 2 on page 427
DELETE	1 on page 427, 2 on page 427, 3 on page 427

Table 107. Valid SQL statements in an SQLJ statement clause (continued)

Statement	Applicable data sources
DROP ALIAS	1 on page 427, 2 on page 427
DROP DATABASE	1 on page 427, 2 on page 427, 3a on page 427
DROP DISTINCT TYPE	1 on page 427, 2 on page 427
DROP TYPE	3 on page 427
DROP FUNCTION	1 on page 427, 2 on page 427, 3 on page 427
DROP INDEX	1 on page 427, 2 on page 427, 3 on page 427
DROP PACKAGE	1 on page 427, 2 on page 427
DROP PROCEDURE	1 on page 427, 2 on page 427, 3 on page 427
DROP STOGROUP	1 on page 427, 2 on page 427
DROP SYNONYM	1 on page 427, 2 on page 427, 3 on page 427
DROP TABLE	1 on page 427, 2 on page 427, 3 on page 427
DROP TABLESPACE	1 on page 427, 2 on page 427
DROP TRIGGER	1 on page 427, 2 on page 427, 3 on page 427
DROP VIEW	1 on page 427, 2 on page 427, 3 on page 427
FETCH	1 on page 427, 2 on page 427, 3 on page 427
GRANT	1 on page 427, 2 on page 427, 3 on page 427
INSERT	1 on page 427, 2 on page 427, 3 on page 427
LOCK TABLE	1 on page 427, 2 on page 427, 3 on page 427
MERGE	1 on page 427, 2 on page 427
REVOKE	1 on page 427, 2 on page 427, 3 on page 427
ROLLBACK	1 on page 427, 2 on page 427, 3 on page 427
SAVEPOINT	1 on page 427, 2 on page 427, 3 on page 427
SELECT INTO	1 on page 427, 2 on page 427, 3 on page 427
SET CURRENT APPLICATION ENCODING SCHEME	1 on page 427
SET CURRENT DEBUG MODE	1 on page 427
SET CURRENT DEFAULT TRANSFORM GROUP	2 on page 427
SET CURRENT DEGREE	1 on page 427, 2 on page 427
SET CURRENT EXPLAIN MODE	2 on page 427
SET CURRENT EXPLAIN SNAPSHOT	2 on page 427
SET CURRENT ISOLATION	1 on page 427, 2 on page 427
SET CURRENT LOCALE LC_CTYPE	1 on page 427
SET CURRENT MAINTAINED TABLE TYPES FOR OPTIMIZATION	1 on page 427, 2 on page 427
SET CURRENT OPTIMIZATION HINT	1 on page 427, 2 on page 427
SET CURRENT PACKAGE PATH	1 on page 427
SET CURRENT PACKAGESET (USER is not supported)	1 on page 427, 2 on page 427
SET CURRENT PRECISION	1 on page 427, 2 on page 427
SET CURRENT QUERY ACCELERATION	1 on page 427
SET CURRENT QUERY OPTIMIZATION	2 on page 427
SET CURRENT REFRESH AGE	1 on page 427, 2 on page 427

Table 107. Valid SQL statements in an SQLJ statement clause (continued)

Statement	Applicable data sources
SET CURRENT ROUTINE VERSION	1
SET CURRENT RULES	1
SET CURRENT SCHEMA	2
SET CURRENT SQLID	1
SET PATH	1, 2
TRUNCATE	1
UPDATE	1, 2, 3

**Note:** The SQL statement applies to connections to the following data sources:

1. DB2 for z/OS
2. DB2 Database for Linux, UNIX, and Windows
3. IBM Informix
  - a. IBM Informix, for the SYSMASTER database only.

### Usage notes

- SQLJ supports both positioned and searched DELETE and UPDATE operations.
- For a FETCH statement, a positioned DELETE statement, or a positioned UPDATE statement, you must use an iterator to refer to rows in a result table.

## SQLJ SET-TRANSACTION-clause

The SET TRANSACTION clause sets the isolation level for the current unit of work.

### Syntax

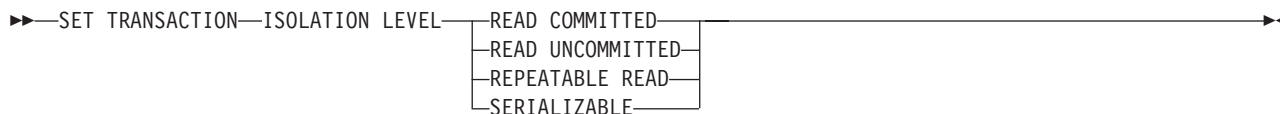

### Description

#### ISOLATION LEVEL

Specifies one of the following isolation levels:

#### READ COMMITTED

Specifies that the current DB2 isolation level is cursor stability.

#### READ UNCOMMITTED

Specifies that the current DB2 isolation level is uncommitted read.

#### REPEATABLE READ

Specifies that the current DB2 isolation level is read stability.

#### SERIALIZABLE

Specifies that the current DB2 isolation level is repeatable read.

### Usage notes

You can execute SET TRANSACTION only at the beginning of a transaction.

## SQLJ assignment-clause

The assignment clause assigns the result of an SQL operation to a Java variable.

### Syntax

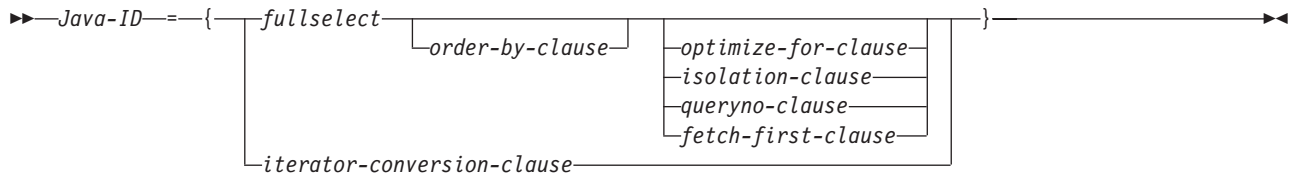

### Description

#### Java-ID

Identifies an iterator that was declared previously as an instance of an iterator class.

#### fullselect

Generates a result table.

#### iterator-conversion-clause

See "SQLJ iterator-conversion-clause" for a description of this clause.

### Usage notes

- If the object that is identified by *Java-ID* is a positioned iterator, the number of columns in the result set must match the number of columns in the iterator. In addition, the data type of each column in the result set must be compatible with the data type of the corresponding column in the iterator. See "Java, JDBC, and SQL data types" for a list of compatible Java and SQL data types.
- If the object that is identified by *Java-ID* is a named iterator, the name of each accessor method must match, except for case, the name of a column in the result set. In addition, the data type of the object that an accessor method returns must be compatible with the data type of the corresponding column in the result set.
- You can put an assignment clause anywhere in a Java program that a Java assignment statement can appear. However, you cannot put an assignment clause where a Java assignment expression can appear. For example, you cannot specify an assignment clause in the control list of a for statement.

## SQLJ iterator-conversion-clause

The iterator conversion clause converts a JDBC ResultSet to an iterator.

### Syntax



### Description

#### host-expression

Identifies the JDBC ResultSet that is to be converted to an SQLJ iterator.

### Usage notes

- If the iterator to which the JDBC ResultSet is to be converted is a positioned iterator, the number of columns in the ResultSet must match the number of



columns in the iterator. In addition, the data type of each column in the `ResultSet` must be compatible with the data type of the corresponding column in the iterator.

- If the iterator is a named iterator, the name of each accessor method must match, except for case, the name of a column in the `ResultSet`. In addition, the data type of the object that an accessor method returns must be compatible with the data type of the corresponding column in the `ResultSet`.
- When an iterator that is generated through the iterator conversion clause is closed, the `ResultSet` from which the iterator is generated is also closed.

---

## Interfaces and classes in the `sqlj.runtime` package

The `sqlj.runtime` package defines the run-time classes and interfaces that are used directly or indirectly by the SQLJ programmer.

Classes such as `AsciiStream` are used directly by the SQLJ programmer. Interfaces such as `ResultSetIterator` are implemented as part of generated class declarations.

### `sqlj.runtime` interfaces

The following table summarizes the interfaces in `sqlj.runtime`.

*Table 108. Summary of `sqlj.runtime` interfaces*

Interface name	Purpose
<code>ConnectionContext</code>	Manages the SQL operations that are performed during a connection to a data source.
<code>ForUpdate</code>	Implemented by iterators that are used in a positioned <code>UPDATE</code> or <code>DELETE</code> statement.
<code>NamedIterator</code>	Implemented by iterators that are declared as named iterators.
<code>PositionedIterator</code>	Implemented by iterators that are declared as positioned iterators.
<code>ResultSetIterator</code>	Implemented by all iterators to allow query results to be processed using a JDBC <code>ResultSet</code> .
<code>Scrollable</code>	Provides a set of methods for manipulating scrollable iterators.

### `sqlj.runtime` classes

The following table summarizes the classes in `sqlj.runtime`.

*Table 109. Summary of `sqlj.runtime` classes*

Class name	Purpose
<code>AsciiStream</code>	A class for handling an input stream whose bytes should be interpreted as ASCII.
<code>BinaryStream</code>	A class for handling an input stream whose bytes should be interpreted as binary.
<code>CharacterStream</code>	A class for handling an input stream whose bytes should be interpreted as <code>Character</code> .
<code>DefaultRuntime</code>	Implemented by SQLJ to satisfy the expected runtime behavior of SQLJ for most JVM environments. This class is for internal use only and is not described in this documentation.
<code>ExecutionContext</code>	Implemented when an SQLJ execution context is declared, to control the execution of SQL operations.
<code>Indicator</code>	Defines constants for indicator variable values.

Table 109. Summary of `sqlj.runtime` classes (continued)

Class name	Purpose
<code>RuntimeContext</code>	Defines system-specific services that are provided by the runtime environment. This class is for internal use only and is not described in this documentation.
<code>SQLException</code>	Derived from the <code>java.sql.SQLException</code> class. An <code>sqlj.runtime.SQLException</code> is thrown when an SQL NULL value is fetched into a host identifier with a Java primitive type.
<code>StreamWrapper</code>	Wraps a <code>java.io.InputStream</code> instance.
<code>UnicodeStream</code>	A class for handling an input stream whose bytes should be interpreted as Unicode.

## `sqlj.runtime.ConnectionContext` interface

The `sqlj.runtime.ConnectionContext` interface provides a set of methods that manage SQL operations that are performed during a session with a specific data source.

Translation of an SQLJ connection declaration clause causes SQLJ to create a connection context class. A connection context object maintains a JDBC Connection object on which dynamic SQL operations can be performed. A connection context object also maintains a default `ExecutionContext` object.

### Variables

#### `CLOSE_CONNECTION`

Format:

```
public static final boolean CLOSE_CONNECTION=true;
```

A constant that can be passed to the `close` method. It indicates that the underlying JDBC Connection object should be closed.

#### `KEEP_CONNECTION`

Format:

```
public static final boolean KEEP_CONNECTION=false;
```

A constant that can be passed to the `close` method. It indicates that the underlying JDBC Connection object should not be closed.

### Methods

#### `close()`

Format:

```
public abstract void close() throws SQLException
```

Performs the following functions:

- Releases all resources that are used by the given connection context object
- Closes any open `ConnectedProfile` objects
- Closes the underlying JDBC Connection object

`close()` is equivalent to `close(CLOSE_CONNECTION)`.

#### `close(boolean)`

Format:

```
public abstract void close (boolean close-connection)  
    throws SQLException
```

Performs the following functions:

- Releases all resources that are used by the given connection context object
- Closes any open `ConnectedProfile` objects
- Closes the underlying JDBC Connection object, depending on the value of the `close-connection` parameter

Parameters:

*close-connection*

Specifies whether the underlying JDBC Connection object is closed when a connection context object is closed:

**CLOSE\_CONNECTION**

Closes the underlying JDBC Connection object.

**KEEP\_CONNECTION**

Does not close the underlying JDBC Connection object.

### **getConnectionProfile**

Format:

```
public abstract ConnectedProfile getConnectionProfile(Object profileKey)
    throws SQLException
```

This method is used by code that is generated by the SQLJ translator. It is not intended for direct use by application programs.

### **getConnection**

Format:

```
public abstract Connection getConnection()
```

Returns the underlying JDBC Connection object for the given connection context object.

### **getExecutionContext**

Format:

```
public abstract ExecutionContext getExecutionContext()
```

Returns the default `ExecutionContext` object that is associated with the given connection context object.

### **isClosed**

Format:

```
public abstract boolean isClosed()
```

Returns true if the given connection context object has been closed. Returns false if the connection context object has not been closed.

## **Constructors**

The following constructors are defined in a concrete implementation of the `ConnectionContext` interface that results from translation of the statement `#sql context Ctx;`:

### **Ctx(String, boolean)**

Format:

```
public Ctx(String url, boolean autocommit)
    throws SQLException
```

Parameters:

*url*

The representation of a data source, as specified in the JDBC `getConnection` method.

*autocommit*

Whether autocommit is enabled for the connection. A value of `true` means that autocommit is enabled. A value of `false` means that autocommit is disabled.

### **Ctx(String, String, String, boolean)**

Format:

```
public Ctx(String url, String user, String password,  
           boolean autocommit)  
           throws SQLException
```

Parameters:

*url*

The representation of a data source, as specified in the JDBC `getConnection` method.

*user*

The user ID under which the connection to the data source is made.

*password*

The password for the user ID under which the connection to the data source is made.

*autocommit*

Whether autocommit is enabled for the connection. A value of `true` means that autocommit is enabled. A value of `false` means that autocommit is disabled.

### **Ctx(String, Properties, boolean)**

Format:

```
public Ctx(String url, Properties info, boolean autocommit)  
           throws SQLException
```

Parameters:

*url*

The representation of a data source, as specified in the JDBC `getConnection` method.

*info*

An object that contains a set of driver properties for the connection. Any of the IBM Data Server Driver for JDBC and SQLJ properties can be specified.

*autocommit*

Whether autocommit is enabled for the connection. A value of `true` means that autocommit is enabled. A value of `false` means that autocommit is disabled.

### **Ctx(Connection)**

Format:

```
public Ctx(java.sql.Connection JDBC-connection-object)  
           throws SQLException
```

Parameters:

*JDBC-connection-object*

A previously created JDBC Connection object.

If the constructor call throws an `SQLException`, the JDBC Connection object remains open.

#### **Ctx(ConnectionContext)**

Format:

```
public Ctx(sqlj.runtime.ConnectionContext SQLJ-connection-context-object)
    throws SQLException
```

Parameters:

*SQLJ-connection-context-object*

A previously created SQLJ ConnectionContext object.

The following constructors are defined in a concrete implementation of the ConnectionContext interface that results from translation of the statement `#sql context Ctx with (dataSource = "jdbc/TestDS");`:

#### **Ctx()**

Format:

```
public Ctx()
    throws SQLException
```

#### **Ctx(String, String)**

Format:

```
public Ctx(String user, String password,
)
    throws SQLException
```

Parameters:

*user*

The user ID under which the connection to the data source is made.

*password*

The password for the user ID under which the connection to the data source is made.

#### **Ctx(Connection)**

Format:

```
public Ctx(java.sql.Connection JDBC-connection-object)
    throws SQLException
```

Parameters:

*JDBC-connection-object*

A previously created JDBC Connection object.

If the constructor call throws an `SQLException`, the JDBC Connection object remains open.

#### **Ctx(ConnectionContext)**

Format:

```
public Ctx(sqlj.runtime.ConnectionContext SQLJ-connection-context-object)
    throws SQLException
```

Parameters:

*SQLJ-connection-context-object*

A previously created SQLJ ConnectionContext object.

## Methods

The following additional methods are generated in a concrete implementation of the `ConnectionContext` interface that results from translation of the statement `#sql context Ctx;`:

### **getDefaultContext**

Format:

```
public static Ctx getDefaultContext()
```

Returns the default connection context object for the `Ctx` class.

### **getProfileKey**

Format:

```
public static Object getProfileKey(sqlj.runtime.profile.Loader loader,  
String profileName) throws SQLException
```

This method is used by code that is generated by the SQLJ translator. It is not intended for direct use by application programs.

### **getProfile**

Format:

```
public static sqlj.runtime.profile.Profile getProfile(Object key)
```

This method is used by code that is generated by the SQLJ translator. It is not intended for direct use by application programs.

### **getTypeMap**

Format:

```
public static java.util.Map getTypeMap()
```

Returns an instance of a class that implements `java.util.Map`, which is the user-defined type map that is associated with the `ConnectionContext`. If there is no associated type map, `Java null` is returned.

This method is used by code that is generated by the SQLJ translator for executable clauses and iterator declaration clauses, but it can also be invoked in an SQLJ application for direct use in JDBC statements.

### **setDefaultContext**

Format:

```
public static void Ctx setDefaultContext(Ctx default-context)
```

Sets the default connection context object for the `Ctx` class.

**Recommendation:** Do not use this method for multithreaded applications. Instead, use explicit contexts.

## sqlj.runtime.ForUpdate interface

SQLJ implements the `sqlj.runtime.ForUpdate` interface in SQLJ programs that contain an iterator declaration clause with `implements sqlj.runtime.ForUpdate`.

An SQLJ program that does positioned `UPDATE` or `DELETE` operations (`UPDATE...WHERE CURRENT OF` or `DELETE...WHERE CURRENT OF`) must include an iterator declaration clause with `implements sqlj.runtime.ForUpdate`.

## Methods

### **getCursorName**

Format:

```
public abstract String getCursorName() throws SQLException
```

This method is used by code that is generated by the SQLJ translator. It is not intended for direct use by application programs.

## **sqlj.runtime.NamedIterator interface**

The `sqlj.runtime.NamedIterator` interface is implemented when an SQLJ application executes an iterator declaration clause for a named iterator.

A named iterator includes result table column names, and the order of the columns in the iterator is not important.

An implementation of the `sqlj.runtime.NamedIterator` interface includes an accessor method for each column in the result table. An accessor method returns the data from its column of the result table. The name of an accessor method matches the name of the corresponding column in the named iterator.

### **Methods (inherited from the ResultSetIterator interface)**

#### **close**

Format:

```
public abstract void close() throws SQLException
```

Releases database resources that the iterator uses.

#### **isClosed**

Format:

```
public abstract boolean isClosed() throws SQLException
```

Returns a value of `true` if the `close` method has been invoked. Returns `false` if the `close` method has not been invoked.

#### **next**

Format:

```
public abstract boolean next() throws SQLException
```

Advances the iterator to the next row. Before an instance of the `next` method is invoked for the first time, the iterator is positioned before the first row of the result table. `next` returns a value of `true` when a next row is available and `false` when all rows have been retrieved.

## **sqlj.runtime.PositionedIterator interface**

The `sqlj.runtime.PositionedIterator` interface is implemented when an SQLJ application executes an iterator declaration clause for a positioned iterator.

The order of columns in a positioned iterator must be the same as the order of columns in the result table, and a positioned iterator does not include result table column names.

## Methods

sqlj.runtime.PositionedIterator inherits all **ResultSetIterator** methods, and includes the following additional method:

### endFetch

Format:

```
public abstract boolean endFetch() throws SQLException
```

Returns a value of true if the iterator is not positioned on a row. Returns a value of false if the iterator is positioned on a row.

## sqlj.runtime.ResultSetIterator interface

The sqlj.runtime.ResultSetIterator interface is implemented by SQLJ for all iterator declaration clauses.

An untyped iterator can be generated by declaring an instance of the sqlj.runtime.ResultSetIterator interface directly. In general, use of untyped iterators is not recommended.

## Variables

### ASENSITIVE

Format:

```
public static final int ASENSITIVE
```

A constant that can be returned by the getSensitivity method. It indicates that the iterator is defined as ASENSITIVE.

This value is not returned by IBM Informix.

### FETCH\_FORWARD

Format:

```
public static final int FETCH_FORWARD
```

A constant that can be used by the following methods:

- Set by sqlj.runtime.Scrollable.setFetchDirection and sqlj.runtime.ExecutionContext.setFetchDirection
- Returned by sqlj.runtime.ExecutionContext.getFetchDirection

It indicates that the iterator fetches rows in a result table in the forward direction, from first to last.

### FETCH\_REVERSE

Format:

```
public static final int FETCH_REVERSE
```

A constant that can be used by the following methods:

- Set by sqlj.runtime.Scrollable.setFetchDirection and sqlj.runtime.ExecutionContext.setFetchDirection
- Returned by sqlj.runtime.ExecutionContext.getFetchDirection

It indicates that the iterator fetches rows in a result table in the backward direction, from last to first.

This value is not returned by IBM Informix.

### FETCH\_UNKNOWN

Format:



```
public static final int FETCH_UNKNOWN
```

A constant that can be used by the following methods:

- Set by `sqlj.runtime.Scrollable.setFetchDirection` and `sqlj.runtime.ExecutionContext.setFetchDirection`
- Returned by `sqlj.runtime.ExecutionContext.getFetchDirection`

It indicates that the iterator fetches rows in a result table in an unknown order.

This value is not returned by IBM Informix.

### **INSENSITIVE**

Format:

```
public static final int INSENSITIVE
```

A constant that can be returned by the `getSensitivity` method. It indicates that the iterator is defined as `INSENSITIVE`.

### **SENSITIVE**

Format:

```
public static final int SENSITIVE
```

A constant that can be returned by the `getSensitivity` method. It indicates that the iterator is defined as `SENSITIVE`.

This value is not returned by IBM Informix.

## **Methods**

### **clearWarnings**

Format:

```
public abstract void clearWarnings() throws SQLException
```

After `clearWarnings` is called, `getWarnings` returns null until a new warning is reported for the iterator.

### **close**

Format:

```
public abstract void close() throws SQLException
```

Closes the iterator and releases underlying database resources.

### **getFetchSize**

Format:

```
synchronized public int getFetchSize() throws SQLException
```

Returns the number of rows that should be fetched by SQLJ when more rows are needed. The returned value is the value that was set by the `setFetchSize` method, or 0 if no value was set by `setFetchSize`.

### **getResultSet**

Format:

```
public abstract ResultSet getResultSet() throws SQLException
```

Returns the JDBC `ResultSet` object that is associated with the iterator.

### **getRow**

Format:

```
synchronized public int getRow() throws SQLException
```

Returns the current row number. The first row is number 1, the second is number 2, and so on. If the iterator is not positioned on a row, 0 is returned.

#### **getSensitivity**

Format:

```
synchronized public int getSensitivity() throws SQLException
```

Returns the sensitivity of the iterator. The sensitivity is determined by the sensitivity value that was specified or defaulted in the with clause of the iterator declaration clause.

#### **getWarnings**

Format:

```
public abstract SQLWarning getWarnings() throws SQLException
```

Returns the first warning that is reported by calls on the iterator. Subsequent iterator warnings are be chained to this SQLWarning. The warning chain is automatically cleared each time the iterator moves to a new row.

#### **isClosed**

Format:

```
public abstract boolean isClosed() throws SQLException
```

Returns a value of true if the iterator is closed. Returns false otherwise.

#### **next**

Format:

```
public abstract boolean next() throws SQLException
```

Advances the iterator to the next row. Before next is invoked for the first time, the iterator is positioned before the first row of the result table. next returns a value of true when a next row is available and false when all rows have been retrieved.

#### **setFetchSize**

Format:

```
synchronized public void setFetchSize(int number-of-rows) throws SQLException
```

Gives SQLJ a hint as to the number of rows that should be fetched when more rows are needed.

Parameters:

*number-of-rows*

The expected number of rows that SQLJ should fetch for the iterator that is associated with the given execution context.

If *number-of-rows* is less than 0 or greater than the maximum number of rows that can be fetched, an SQLException is thrown.

## **sqlj.runtime.Scrollable interface**

sqlj.runtime.Scrollable provides methods to move around in the result table and to check the position in the result table.

sqlj.runtime.Scrollable is implemented when a scrollable iterator is declared.

## Methods

### **absolute(int)**

Format:

```
public abstract boolean absolute (int n) throws SQLException
```

Moves the iterator to a specified row.

If  $n > 0$ , positions the iterator on row  $n$  of the result table. If  $n < 0$ , and  $m$  is the number of rows in the result table, positions the iterator on row  $m+n+1$  of the result table.

If the absolute value of  $n$  is greater than the number of rows in the result table, positions the cursor after the last row if  $n$  is positive, or before the first row if  $n$  is negative.

`absolute(0)` is the same as `beforeFirst()`. `absolute(1)` is the same as `first()`.

`absolute(-1)` is the same as `last()`.

Returns true if the iterator is on a row. Otherwise, returns false.

### **afterLast()**

Format:

```
public abstract void afterLast() throws SQLException
```

Moves the iterator after the last row of the result table.

### **beforeFirst()**

Format:

```
public abstract void beforeFirst() throws SQLException
```

Moves the iterator before the first row of the result table.

### **first()**

Format:

```
public abstract boolean first() throws SQLException
```

Moves the iterator to the first row of the result table.

Returns true if the iterator is on a row. Otherwise, returns false.

### **getFetchDirection()**

Format:

```
public abstract int getFetchDirection() throws SQLException
```

Returns the fetch direction of the iterator. Possible values are:

#### **sqlj.runtime.ResultSetIterator.FETCH\_FORWARD**

Rows are processed in a forward direction, from first to last.

#### **sqlj.runtime.ResultSetIterator.FETCH\_REVERSE**

Rows are processed in a backward direction, from last to first.

#### **sqlj.runtime.ResultSetIterator.FETCH\_UNKNOWN**

The order of processing is not known.

### **isAfterLast()**

Format:

```
public abstract boolean isAfterLast() throws SQLException
```

Returns true if the iterator is positioned after the last row of the result table. Otherwise, returns false.

**isBeforeFirst()**

Format:

```
public abstract boolean isBeforeFirst() throws SQLException
```

Returns true if the iterator is positioned before the first row of the result table. Otherwise, returns false.

**isFirst()**

Format:

```
public abstract boolean isFirst() throws SQLException
```

Returns true if the iterator is positioned on the first row of the result table. Otherwise, returns false.

**isLast()**

Format:

```
public abstract boolean isLast() throws SQLException
```

Returns true if the iterator is positioned on the last row of the result table. Otherwise, returns false.

**last()**

Format:

```
public abstract boolean last() throws SQLException
```

Moves the iterator to the last row of the result table.

Returns true if the iterator is on a row. Otherwise, returns false.

**previous()**

Format:

```
public abstract boolean previous() throws SQLException
```

Moves the iterator to the previous row of the result table.

Returns true if the iterator is on a row. Otherwise, returns false.

**relative(int)**

Format:

```
public abstract boolean relative(int n) throws SQLException
```

If  $n > 0$ , positions the iterator on the row that is  $n$  rows after the current row. If  $n < 0$ , positions the iterator on the row that is  $n$  rows before the current row. If  $n = 0$ , positions the iterator on the current row.

The cursor must be on a valid row of the result table before you can use this method. If the cursor is before the first row or after the last row, the method throws an SQLException.

Suppose that  $m$  is the number of rows in the result table and  $x$  is the current row number in the result table. If  $n > 0$  and  $x + n > m$ , the iterator is positioned after the last row. If  $n < 0$  and  $x + n < 1$ , the iterator is positioned before the first row.

Returns true if the iterator is on a row. Otherwise, returns false.

**setFetchDirection(int)**

Format:

```
public abstract void setFetchDirection (int) throws SQLException
```

Gives the SQLJ runtime environment a hint as to the direction in which rows of this iterator object are processed. Possible values are:

**sqlj.runtime.ResultSetIterator.FETCH\_FORWARD**

Rows are processed in a forward direction, from first to last.

**sqlj.runtime.ResultSetIterator.FETCH\_REVERSE**

Rows are processed in a backward direction, from last to first.

**sqlj.runtime.ResultSetIterator.FETCH\_UNKNOWN**

The order of processing is not known.

## sqlj.runtime.AsciiStream class

The `sqlj.runtime.AsciiStream` class is for an input stream of ASCII data with a specified length.

The `sqlj.runtime.AsciiStream` class is derived from the `java.io.InputStream` class, and extends the `sqlj.runtime.StreamWrapper` class. SQLJ interprets the bytes in an `sqlj.runtime.AsciiStream` object as ASCII characters. An `InputStream` object with ASCII characters needs to be passed as a `sqlj.runtime.AsciiStream` object.

### Constructors

#### **AsciiStream(InputStream)**

Format:

```
public AsciiStream(java.io.InputStream input-stream)
```

Creates an ASCII `java.io.InputStream` object with an unspecified length.

Parameters:

*input-stream*

The `InputStream` object that SQLJ interprets as an `AsciiStream` object.

#### **AsciiStream(InputStream, int)**

Format:

```
public AsciiStream(java.io.InputStream input-stream, int length)
```

Creates an ASCII `java.io.InputStream` object with a specified length.

Parameters:

*input-stream*

The `InputStream` object that SQLJ interprets as an `AsciiStream` object.

*length*

The length of the `InputStream` object that SQLJ interprets as an `AsciiStream` object.

## sqlj.runtime.BinaryStream class

The `sqlj.runtime.BinaryStream` class is for an input stream of binary data with a specified length.

The `sqlj.runtime.BinaryStream` class is derived from the `java.io.InputStream` class, and extends the `sqlj.runtime.StreamWrapper` class. SQLJ interprets the bytes in an `sqlj.runtime.BinaryStream` object are interpreted as Binary characters. An `InputStream` object with Binary characters needs to be passed as a `sqlj.runtime.BinaryStream` object.

## Constructors

### BinaryStream(InputStream)

Format:

```
public BinaryStream(java.io.InputStream input-stream)
```

Creates an Binary java.io.InputStream object with an unspecified length.

Parameters:

*input-stream*

The InputStream object that SQLJ interprets as an BinaryStream object.

### BinaryStream(InputStream, int)

Format:

```
public BinaryStream(java.io.InputStream input-stream, int length)
```

Creates an Binary java.io.InputStream object with a specified length.

Parameters:

*input-stream*

The InputStream object that SQLJ interprets as an BinaryStream object.

*length*

The length of the InputStream object that SQLJ interprets as an BinaryStream object.

## sqlj.runtime.CharacterStream class

The sqlj.runtime.CharacterStream class is for an input stream of character data with a specified length.

The sqlj.runtime.CharacterStream class is derived from the java.io.Reader class, and extends the java.io.FilterReader class. SQLJ interprets the bytes in an sqlj.runtime.CharacterStream object are interpreted as Unicode data. A Reader object with Unicode data needs to be passed as a sqlj.runtime.CharacterStream object.

## Constructors

### CharacterStream(InputStream)

Format:

```
public CharacterStream(java.io.Reader input-stream)
```

Creates a character java.io.Reader object with an unspecified length.

Parameters:

*input-stream*

The Reader object that SQLJ interprets as an CharacterStream object.

### CharacterStream(InputStream, int)

Format:

```
public CharacterStream(java.io.Reader input-stream, int length)
```

Creates a character java.io.Reader object with a specified length.

Parameters:

*input-stream*

The Reader object that SQLJ interprets as an CharacterStream object.

*length*

The length of the Reader object that SQLJ interprets as an `CharacterStream` object.

## Methods

### **getReader**

Format:

```
public Reader getReader()
```

Returns the underlying Reader object that is wrapped by the `CharacterStream` object.

### **getLength**

Format:

```
public void getLength()
```

Returns the length in characters of the wrapped Reader object, as specified by the constructor or in the last call to `setLength`.

### **setLength**

Format:

```
public void setLength (int length)
```

Sets the number of characters that are read from the Reader object when the object is passed as an input argument to an SQL operation.

Parameters:

*length*

The number of characters that are read from the Reader object.

## sqlj.runtime.ExecutionContext class

The `sqlj.runtime.ExecutionContext` class is defined for execution contexts. An execution context is used to control the execution of SQL statements.

## Variables

### **ADD\_BATCH\_COUNT**

Format:

```
public static final int ADD_BATCH_COUNT
```

A constant that can be returned by the `getUpdateCount` method. It indicates that the previous statement was not executed but was added to the existing statement batch.

### **AUTO\_BATCH**

Format:

```
public static final int AUTO_BATCH
```

A constant that can be passed to the `setBatchLimit` method. It indicates that implicit batch execution should be performed, and that SQLJ should determine the batch size.

### **DBDefault**

Format:

```
public static final short DBDefault=-5;
```

A constant that can be assigned to an indicator variable. It specifies that the corresponding host variable value that is passed to the data server is the default value.

#### **DBNonNull**

Format:

```
public static final short DBNonNull=0;
```

A constant that can be assigned to an indicator variable. It specifies that the corresponding host variable value that is passed to the data server is a non-null value.

#### **DBNull**

Format:

```
public static final short DBNull=-1;
```

A constant that can be assigned to an indicator variable. It specifies that the corresponding host variable value that is passed to the data server is the SQL NULL value.

#### **DBUnassigned**

Format:

```
public static final short DBUnassigned=-7;
```

A constant that can be assigned to an indicator variable. It specifies that no value for the corresponding host variable is passed to the data server.

#### **EXEC\_BATCH\_COUNT**

Format:

```
public static final int EXEC_BATCH_COUNT
```

A constant that can be returned from the `getUpdateCount` method. It indicates that a statement batch was just executed.

#### **EXCEPTION\_COUNT**

Format:

```
public static final int EXCEPTION_COUNT
```

A constant that can be returned from the `getUpdateCount` method. It indicates that an exception was thrown before the previous execution completed, or that no operation has been performed on the execution context object.

#### **NEW\_BATCH\_COUNT**

Format:

```
public static final int NEW_BATCH_COUNT
```

A constant that can be returned from the `getUpdateCount` method. It indicates that the previous statement was not executed, but was added to a new statement batch.

#### **QUERY\_COUNT**

Format:

```
public static final int QUERY_COUNT
```

A constant that can be passed to the `setBatchLimit` method. It indicates that the previous execution produced a result set.

#### **UNLIMITED\_BATCH**

Format:



```
public static final int UNLIMITED_BATCH
```

A constant that can be returned from the `getUpdateCount` method. It indicates that statements should continue to be added to a statement batch, regardless of the batch size.

Constructors:

### **ExecutionContext**

Format:

```
public ExecutionContext()
```

Creates an `ExecutionContext` instance.

## **Methods**

### **cancel**

Format:

```
public void cancel() throws SQLException
```

Cancels an SQL operation that is currently being executed by a thread that uses the execution context object. If there is a pending statement batch on the execution context object, the statement batch is canceled and cleared.

The `cancel` method throws an `SQLException` if the statement cannot be canceled.

### **execute**

Format:

```
public boolean execute ( ) throws SQLException
```

This method is used by code that is generated by the SQLJ translator. It is not intended for direct use by application programs.

### **executeBatch**

Format:

```
public synchronized int[] executeBatch() throws SQLException
```

Executes the pending statement batch and returns an array of update counts. If no pending statement batch exists, null is returned. When this method is called, the statement batch is cleared, even if the call results in an exception.

Each element in the returned array can be one of the following values:

- 2 This value indicates that the SQL statement executed successfully, but the number of rows that were updated could not be determined.
- 3 This value indicates that the SQL statement failed.

*Other integer*

This value is the number of rows that were updated by the statement.

The `executeBatch` method throws an `SQLException` if a database error occurs while the statement batch executes.

### **executeQuery**

Format:

```
public ResultSet executeQuery ( ) throws SQLException
```

This method is used by code that is generated by the SQLJ translator. It is not intended for direct use by application programs.

**executeUpdate**

Format:

```
public int executeUpdate() throws SQLException
```

This method is used by code that is generated by the SQLJ translator. It is not intended for direct use by application programs.

**getBatchLimit**

Format:

```
synchronized public int getBatchLimit()
```

Returns the number of statements that are added to a batch before the batch is implicitly executed.

The returned value is one of the following values:

**UNLIMITED\_BATCH**

This value indicates that the batch size is unlimited.

**AUTO\_BATCH**

This value indicates that the batch size is finite but unknown.

*Other integer*

The current batch limit.

**getBatchUpdateCounts**

Format:

```
public synchronized int[] getBatchUpdateCounts()
```

Returns an array that contains the number of rows that were updated by each statement that successfully executed in a batch. The order of elements in the array corresponds to the order in which statements were inserted into the batch. Returns null if no statements in the batch completed successfully.

Each element in the returned array can be one of the following values:

-2 This value indicates that the SQL statement executed successfully, but the number of rows that were updated could not be determined.

-3 This value indicates that the SQL statement failed.

*Other integer*

This value is the number of rows that were updated by the statement.

**getFetchDirection**

Format:

```
synchronized public int getFetchDirection() throws SQLException
```

Returns the current fetch direction for scrollable iterator objects that were generated from the given execution context. If a fetch direction was not set for the execution context, `sqlj.runtime.ResultSetIterator.FETCH_FORWARD` is returned.

**getFetchSize**

Format:

```
synchronized public int getFetchSize() throws SQLException
```

Returns the number of rows that should be fetched by SQLJ when more rows are needed. This value applies only to iterator objects that were generated from the given execution context. The returned value is the value that was set by the `setFetchSize` method, or 0 if no value was set by `setFetchSize`.

### **getMaxFieldSize**

Format:

```
public synchronized int getMaxFieldSize()
```

Returns the maximum number of bytes that are returned for any string (character, graphic, or varying-length binary) column in queries that use the given execution context. If this limit is exceeded, SQLJ discards the remaining bytes. A value of 0 means that the maximum number of bytes is unlimited.

### **getMaxRows**

Format:

```
public synchronized int getMaxRows()
```

Returns the maximum number of rows that are returned for any query that uses the given execution context. If this limit is exceeded, SQLJ discards the remaining rows. A value of 0 means that the maximum number of rows is unlimited.

### **getNextResultSet()**

Format:

```
public ResultSet getNextResultSet() throws SQLException
```

After a stored procedure call, returns a result set from the stored procedure.

A null value is returned if any of the following conditions are true:

- There are no more result sets to be returned.
- The stored procedure call did not produce any result sets.
- A stored procedure call has not been executed under the execution context.

When you invoke `getNextResultSet()`, SQLJ closes the currently-open result set and advances to the next result set.

If an error occurs during a call to `getNextResultSet`, resources for the current JDBC `ResultSet` object are released, and an `SQLException` is thrown. Subsequent calls to `getNextResultSet` return null.

### **getNextResultSet(int)**

Formats:

```
public ResultSet getNextResultSet(int current)
```

After a stored procedure call, returns a result set from the stored procedure.

A null value is returned if any of the following conditions are true:

- There are no more result sets to be returned.
- The stored procedure call did not produce any result sets.
- A stored procedure call has not been executed under the execution context.

If an error occurs during a call to `getNextResultSet`, resources for the current JDBC `ResultSet` object are released, and an `SQLException` is thrown. Subsequent calls to `getNextResultSet` return null.

Parameters:

*current*

Indicates what SQLJ does with the currently open result set before it advances to the next result set:

**java.sql.Statement.CLOSE\_CURRENT\_RESULT**

Specifies that the current ResultSet object is closed when the next ResultSet object is returned.

**java.sql.Statement.KEEP\_CURRENT\_RESULT**

Specifies that the current ResultSet object stays open when the next ResultSet object is returned.

**java.sql.Statement.CLOSE\_ALL\_RESULTS**

Specifies that all open ResultSet objects are closed when the next ResultSet object is returned.

**getQueryTimeout**

Format:

```
public synchronized int getQueryTimeout()
```

Returns the maximum number of seconds that SQL operations that use the given execution context object can execute. If an SQL operation exceeds the limit, an SQLException is thrown. The returned value is the value that was set by the setQueryTimeout method, or 0 if no value was set by setQueryTimeout. 0 means that execution time is unlimited.

**getUpdateCount**

Format:

```
public abstract int getUpdateCount() throws SQLException
```

Returns:

**ExecutionContext.ADD\_BATCH\_COUNT**

If the statement was added to an existing batch.

**ExecutionContext.NEW\_BATCH\_COUNT**

If the statement was the first statement in a new batch.

**ExecutionContext.EXCEPTION\_COUNT**

If the previous statement generated an SQLException, or no previous statement was executed.

**ExecutionContext.EXEC\_BATCH\_COUNT**

If the statement was part of a batch, and the batch was executed.

**ExecutionContext.QUERY\_COUNT**

If the previous statement created an iterator object or JDBC ResultSet.

*Other integer*

If the statement was executed rather than added to a batch. This value is the number of rows that were updated by the statement.

**getWarnings**

Format:

```
public synchronized SQLWarning getWarnings()
```

Returns the first warning that was reported by the last SQL operation that was executed using the given execution context. Subsequent warnings are chained to the first warning. If no warnings occurred, null is returned.

getWarnings is used to retrieve positive SQLCODEs.

**isBatching**

Format:

```
public synchronized boolean isBatching()
```

Returns true if batching is enabled for the execution context. Returns false if batching is disabled.

### **registerStatement**

Format:

```
public RTStatement registerStatement(ConnectionContext connCtx,  
    Object profileKey, int stmtNdx)  
    throws SQLException
```

This method is used by code that is generated by the SQLJ translator. It is not intended for direct use by application programs.

### **releaseStatement**

Format:

```
public void releaseStatement() throws SQLException
```

This method is used by code that is generated by the SQLJ translator. It is not intended for direct use by application programs.

### **setBatching**

Format:

```
public synchronized void setBatching(boolean batching)
```

Parameters:

*batching*

Indicates whether batchable statements that are registered with the given execution context can be added to a statement batch:

**true**

Statements can be added to a statement batch.

**false**

Statements are executed individually.

`setBatching` affects only statements that occur in the program after `setBatching` is called. It does not affect previous statements or an existing statement batch.

### **setBatchLimit**

Format:

```
public synchronized void setBatchLimit(int batch-size)
```

Sets the maximum number of statements that are added to a batch before the batch is implicitly executed.

Parameters:

*batch-size*

One of the following values:

**ExecutionContext.UNLIMITED\_BATCH**

Indicates that implicit execution occurs only when SQLJ encounters a statement that is batchable but incompatible, or not batchable. Setting this value is the same as not invoking `setBatchLimit`.

**ExecutionContext.AUTO\_BATCH**

Indicates that implicit execution occurs when the number of statements in the batch reaches a number that is set by SQLJ.

*Positive integer*

The number of statements that are added to the batch before SQLJ executes the batch implicitly. The batch might be executed before this

many statements have been added if SQLJ encounters a statement that is batchable but incompatible, or not batchable.

`setBatchLimit` affects only statements that occur in the program after `setBatchLimit` is called. It does not affect an existing statement batch.

#### **setFetchDirection**

Format:

```
public synchronized void setFetchDirection(int direction) throws SQLException
```

Gives SQLJ a hint as to the current fetch direction for scrollable iterator objects that were generated from the given execution context.

Parameters:

*direction*

One of the following values:

**sqlj.runtime.ResultSetIterator.FETCH\_FORWARD**

Rows are fetched in a forward direction. This is the default.

**sqlj.runtime.ResultSetIterator.FETCH\_REVERSE**

Rows are fetched in a backward direction.

**sqlj.runtime.ResultSetIterator.FETCH\_UNKNOWN**

The order of fetching is unknown.

Any other input value results in an `SQLException`.

#### **setFetchSize**

Format:

```
synchronized public void setFetchSize(int number-of-rows) throws SQLException
```

Gives SQLJ a hint as to the number of rows that should be fetched when more rows are needed.

Parameters:

*number-of-rows*

The expected number of rows that SQLJ should fetch for the iterator that is associated with the given execution context.

If *number-of-rows* is less than 0 or greater than the maximum number of rows that can be fetched, an `SQLException` is thrown.

#### **setMaxFieldSize**

Format:

```
public void setMaxFieldSize(int max-bytes)
```

Specifies the maximum number of bytes that are returned for any string (character, graphic, or varying-length binary) column in queries that use the given execution context. If this limit is exceeded, SQLJ discards the remaining bytes.

Parameters:

*max-bytes*

The maximum number of bytes that SQLJ should return from a `BINARY`, `VARBINARY`, `CHAR`, `VARCHAR`, `GRAPHIC`, or `VARGRAPHIC` column. A value of 0 means that the number of bytes is unlimited. 0 is the default.

### **setMaxRows**

Format:

```
public synchronized void setMaxRows(int max-rows)
```

Specifies the maximum number of rows that are returned for any query that uses the given execution context. If this limit is exceeded, SQLJ discards the remaining rows.

When setMaxRows is invoked at run time on a statically executed SELECT statement, setMaxRows limits the maximum number of rows in the result table through IBM Data Server Driver for JDBC and SQLJ processing only. Data server optimization that limits the number of rows in the result table does not occur unless the FETCH FIRST *n* ROWS ONLY clause is also added to the SELECT statement. If FETCH FIRST *n* rows ONLY is added to the SELECT statement, and setMaxRows(*m*) is called, the maximum number of rows is the smaller of *n* and *m*. The driver discards the rest of the rows.

Parameters:

*max-rows*

The maximum number of rows that SQLJ should return for a query that uses the given execution context. A value of 0 means that the number of rows is unlimited. 0 is the default.

### **setQueryTimeout**

Format:

```
public synchronized void setQueryTimeout(int timeout-value)
```

Specifies the maximum number of seconds that SQL operations that use the given execution context object can execute. If an SQL operation exceeds the limit, an SQLException is thrown.

For IBM Data Server Driver for JDBC and SQLJ type 2 connectivity on DB2 for z/OS data servers, setQueryTimeout is supported only if Connection or DataSource property queryTimeoutInterruptProcessingMode is set to INTERRUPT\_PROCESSING\_MODE\_CLOSE\_SOCKET.

Parameters:

*timeout-value*

The maximum number of seconds that SQL operations that use the given execution context object can execute. 0 means that execution time is unlimited. 0 is the default.

## **sqlj.runtime.SQLNullException class**

The sqlj.runtime.SQLNullException class is derived from the java.sql.SQLException class.

An sqlj.runtime.SQLNullException is thrown when an SQL NULL value is fetched into a host identifier with a Java primitive type. The SQLSTATE value for an instance of SQLNullException is '22002'.

## **sqlj.runtime.StreamWrapper class**

The sqlj.runtime.StreamWrapper class wraps a java.io.InputStream instance and extends the java.io.InputStream class.

The sqlj.runtime.AsciiStream, sqlj.runtime.BinaryStream, and sqlj.runtime.UnicodeStream classes extend sqlj.runtime.StreamWrapper.

sqlj.runtime.StreamWrapper supports methods for specifying the length of sqlj.runtime.AsciiStream, sqlj.runtime.BinaryStream, and sqlj.runtime.UnicodeStream objects.

## Constructors

### StreamWrapper(InputStream)

Format:

```
protected StreamWrapper(InputStream input-stream)
```

Creates an sqlj.runtime.StreamWrapper object with an unspecified length.

Parameters:

*input-stream*

The InputStream object that the sqlj.runtime.StreamWrapper object wraps.

### StreamWrapper(InputStream, int)

Format:

```
protected StreamWrapper(java.io.InputStream input-stream, int length)
```

Creates an sqlj.runtime.StreamWrapper object with a specified length.

Parameters:

*input-stream*

The InputStream object that the sqlj.runtime.StreamWrapper object wraps.

*length*

The length of the InputStream object in bytes.

## Methods

### getInputStream

Format:

```
public InputStream getInputStream()
```

Returns the underlying InputStream object that is wrapped by the StreamWrapper object.

### getLength

Format:

```
public void getLength()
```

Returns the length in bytes of the wrapped InputStream object, as specified by the constructor or in the last call to setLength.

### setLength

Format:

```
public void setLength (int length)
```

Sets the number of bytes that are read from the wrapped InputStream object when the object is passed as an input argument to an SQL operation.

Parameters:

*length*

The number of bytes that are read from the wrapped InputStream object.



## sqlj.runtime.UnicodeStream class

The `sqlj.runtime.UnicodeStream` class is for an input stream of Unicode data with a specified length.

The `sqlj.runtime.UnicodeStream` class is derived from the `java.io.InputStream` class, and extends the `sqlj.runtime.StreamWrapper` class. SQLJ interprets the bytes in an `sqlj.runtime.UnicodeStream` object as Unicode characters. An `InputStream` object with Unicode characters needs to be passed as a `sqlj.runtime.UnicodeStream` object.

### Constructors

#### **UnicodeStream(InputStream)**

Format:

```
public UnicodeStream(java.io.InputStream input-stream)
```

Creates a Unicode `java.io.InputStream` object with an unspecified length.

Parameters:

*input-stream*

The `InputStream` object that SQLJ interprets as an `UnicodeStream` object.

#### **UnicodeStream(InputStream, int)**

Format:

```
public UnicodeStream(java.io.InputStream input-stream, int length)
```

Creates a Unicode `java.io.InputStream` object with a specified length.

Parameters:

*input-stream*

The `InputStream` object that SQLJ interprets as an `UnicodeStream` object.

*length*

The length of the `InputStream` object that SQLJ interprets as an `UnicodeStream` object.

---

## IBM Data Server Driver for JDBC and SQLJ extensions to JDBC

The IBM Data Server Driver for JDBC and SQLJ provides a set of extensions to the support that is provided by the JDBC specification.

To use IBM Data Server Driver for JDBC and SQLJ-only methods in classes that have corresponding, standard classes, cast an instance of the related, standard JDBC class to an instance of the IBM Data Server Driver for JDBC and SQLJ-only class. For example:

```
javax.sql.DataSource ds =  
    new com.ibm.db2.jcc.DB2SimpleDataSource();  
((com.ibm.db2.jcc.DB2BaseDataSource) ds).setServerName("sysmvs1.st1.ibm.com");
```

Table 110 summarizes the IBM Data Server Driver for JDBC and SQLJ-only interfaces.

Table 110. Summary of IBM Data Server Driver for JDBC and SQLJ-only interfaces provided by the IBM Data Server Driver for JDBC and SQLJ

Interface name	Applicable data sources	Purpose
DB2CallableStatement	1 on page 454, 2 on page 454	Extends the <code>java.sql.CallableStatement</code> and the <code>com.ibm.db2.jcc.DB2PreparedStatement</code> interfaces.

Table 110. Summary of IBM Data Server Driver for JDBC and SQLJ-only interfaces provided by the IBM Data Server Driver for JDBC and SQLJ (continued)

Interface name	Applicable data sources	Purpose
DB2Connection	1, 2, 3	Extends the java.sql.Connection interface.
DB2DatabaseMetaData	1, 2, 3	Extends the java.sql.DatabaseMetaData interface.
DB2Diagnosable	1, 2, 3	Provides a mechanism for getting DB2 diagnostics from a DB2 SQLException.
DB2ParameterMetaData	2	Extends the java.sql.ParameterMetaData interface.
DB2PreparedStatement	1, 2, 3	Extends the com.ibm.db2.jcc.DB2Statement and java.sql.PreparedStatement interfaces.
DB2ResultSet	1, 2, 3	Extends the java.sql.ResultSet interface.
DB2RowID	1, 2	Used for declaring Java objects for use with the ROWID data type.
DB2Statement	1, 2, 3	Extends the java.sql.Statement interface.
DB2Struct	2	Provides methods for working with java.sql.Struct objects.
DB2SystemMonitor	1, 2, 3	Used for collecting system monitoring data for a connection.
DB2TraceManagerMBean	1, 2, 3	Provides the MBean interface for the remote trace controller.
DB2Xml	1, 2	Used for updating data in XML columns and retrieving data from XML columns.
DBBatchUpdateException	1, 2, 3	Used for retrieving error information about batch execution of statements that return automatically generated keys.

**Note:** The interface applies to connections to the following data sources:

1. DB2 for z/OS
2. DB2 Database for Linux, UNIX, and Windows
3. IBM Informix

Table 111 summarizes the IBM Data Server Driver for JDBC and SQLJ-only classes.

Table 111. Summary of IBM Data Server Driver for JDBC and SQLJ-only classes provided by the IBM Data Server Driver for JDBC and SQLJ

Class name	Applicable data sources	Purpose
DB2Administrator (DB2 Database for Linux, UNIX, and Windows only)	2 on page 455	Instances of the DB2Administrator class are used to retrieve DB2CataloguedDatabase objects.
DB2BaseDataSource	1 on page 455, 2 on page 455, 3 on page 455	The abstract data source parent class for all IBM Data Server Driver for JDBC and SQLJ-specific implementations of javax.sql.DataSource, javax.sql.ConnectionPoolDataSource, and javax.sql.XADataSource.
DB2CataloguedDatabase	2 on page 455	Contains methods that retrieve information about a local DB2 Database for Linux, UNIX, and Windows database.
DB2ClientRerouteServerList	1 on page 455, 2 on page 455	Implements the java.io.Serializable and javax.naming.Referenceable interfaces.

Table 111. Summary of IBM Data Server Driver for JDBC and SQLJ-only classes provided by the IBM Data Server Driver for JDBC and SQLJ (continued)

Class name	Applicable data sources	Purpose
DB2ConnectionPoolDataSource	1, 2, 3	A factory for PooledConnection objects.
DB2Driver	1, 2, 3	Extends the java.sql.Driver interface.
DB2ExceptionFormatter	1, 2, 3	Contains methods for printing diagnostic information to a stream.
DB2JCCPlugin	2	The abstract class for implementation of JDBC security plug-ins.
DB2PooledConnection	1, 2, 3	Provides methods that an application server can use to switch users on a preexisting trusted connection.
DB2PoolMonitor	1, 2	Provides methods for monitoring the global transport objects pool for the connection concentrator and Sysplex workload balancing.
DB2SimpleDataSource	1, 2, 3	Extends the DataBaseDataSource class. Does not support connection pooling or distributed transactions.
DB2Sqlca	1, 2, 3	An encapsulation of the DB2 SQLCA.
DB2TraceManager	1, 2, 3	Controls the global log writer.
DB2Types	1 on page 454	Defines data type constants.
DB2XADataSource	1, 2, 3	A factory for XADataSource objects. An object that implements this interface is registered with a naming service that is based on the Java Naming and Directory Interface (JNDI).
DBTimestamp	1, 2, 3	A subclass of Timestamp that handles timestamp values with extra precision or time zone information.

**Note:** The class applies to connections to the following data sources:

1. DB2 for z/OS
2. DB2 Database for Linux, UNIX, and Windows
3. IBM Informix

## DBBatchUpdateException interface

The com.ibm.db2.jcc.DBBatchUpdateException interface is used for retrieving error information about batch execution of statements that return automatically generated keys.

### DBBatchUpdateException methods

The following methods are defined only for the IBM Data Server Driver for JDBC and SQLJ.

#### getDBGeneratedKeys

Format:

```
public java.sql.ResultSet[] getDBGeneratedKeys()
    throws java.sql.SQLException
```

Retrieves automatically generated keys that were created when INSERT statements were executed in a batch. Each ResultSet object that is returned

contains the automatically generated keys for a single statement in the batch. ResultSet objects that are null correspond to failed statements.

## DB2Administrator class

Instances of the `com.ibm.db2.jcc.DB2Administrator` class are used to retrieve DB2CataloguedDatabase objects. DB2Administrator applies to DB2 Database for Linux, UNIX, and Windows databases only.

### DB2Administrator methods

#### getInstance

Format:

```
public static DB2Administrator getInstance()
```

Returns an instance of the DB2Administrator class.

#### getCataloguedDatabases

Format:

```
public DB2CataloguedDatabase[] getCataloguedDatabases()  
    throws java.sql.SQLException
```

Retrieves an array that contains a DB2CataloguedDatabase object for each local database in the local database directory.

If a local DB2 system is available, and the catalog contains no databases, an array with length zero is returned. If no local DB2 system is available, null is returned. If the local system is not a DB2 Database for Linux, UNIX, and Windows system, an SQLException is thrown.

## DB2BaseDataSource class

The `com.ibm.db2.jcc.DB2BaseDataSource` class is the abstract data source parent class for all IBM Data Server Driver for JDBC and SQLJ-specific implementations of `javax.sql.DataSource`, `javax.sql.ConnectionPoolDataSource`, and `javax.sql.XADataSource`.

DB2BaseDataSource implements the `java.sql.Wrapper` interface.

### DB2BaseDataSource properties

The following properties are defined only for the IBM Data Server Driver for JDBC and SQLJ.

You can set all properties on a DataSource or in the `url` parameter in a `DriverManager.getConnection` call.

All properties **except** the following properties have a `setXXX` method to set the value of the property and a `getXXX` method to retrieve the value:

- `dumpPool`
- `dumpPoolStatisticsOnSchedule`
- `dumpPoolStatisticsOnScheduleFile`
- `maxTransportObjectIdleTime`
- `maxTransportObjectWaitTime`
- `minTransportObjects`

A `setXXX` method has this form:

```
void setProperty-name(data-type property-value)
```

A getXXX method has this form:

```
data-type getProperty-name()
```

*Property-name* is the unqualified property name. For properties that are not specific to IBM Informix, the first character of the property name is capitalized. For properties that are used only by IBM Informix, all characters of the property name are capitalized.

The following table lists the IBM Data Server Driver for JDBC and SQLJ properties and their data types.

Table 112. DB2BaseDataSource properties and their data types

Property name	Applicable data sources	Data type
com.ibm.db2.jcc.DB2BaseDataSource.accountingInterval	1 on page 463	String
com.ibm.db2.jcc.DB2BaseDataSource.alternateGroupDatabaseName	1 on page 463, 2 on page 463	String
com.ibm.db2.jcc.DB2BaseDataSource.alternateGroupPortNumber	1 on page 463, 2 on page 463	String
com.ibm.db2.jcc.DB2BaseDataSource.alternateGroupServerName	1 on page 463, 2 on page 463	String
com.ibm.db2.jcc.DB2BaseDataSource.affinityFailbackInterval	1 on page 463, 2 on page 463, 3 on page 463	int
com.ibm.db2.jcc.DB2BaseDataSource.allowNextOnExhaustedResultSet	1 on page 463, 2 on page 463, 3 on page 463	int
com.ibm.db2.jcc.DB2BaseDataSource.allowNullResultSetForExecuteQuery	1 on page 463, 2 on page 463, 3 on page 463	int
com.ibm.db2.jcc.DB2BaseDataSource.atomicMultiRowInsert	1 on page 463, 2 on page 463, 3 on page 463	int
com.ibm.db2.jcc.DB2BaseDataSource.blockingReadConnectionTimeout	1 on page 463, 2 on page 463, 3 on page 463	int
com.ibm.db2.jcc.DB2BaseDataSource.charOutputSize	1 on page 463	short
com.ibm.db2.jcc.DB2BaseDataSource.clientAccountingInformation	1 on page 463, 2 on page 463	String
com.ibm.db2.jcc.DB2BaseDataSource.clientApplicationInformation	1 on page 463, 2 on page 463	String
com.ibm.db2.jcc.DB2BaseDataSource.clientDebugInfo (IBM Data Server Driver for JDBC and SQLJ type 4 connectivity)	1 on page 463, 2 on page 463	String
com.ibm.db2.jcc.DB2BaseDataSource.clientProgramId	1 on page 463, 2 on page 463	String
com.ibm.db2.jcc.DB2BaseDataSource.clientProgramName (IBM Data Server Driver for JDBC and SQLJ type 4 connectivity)	1 on page 463, 2 on page 463	String
com.ibm.db2.jcc.DB2BaseDataSource.clientRerouteAlternateServerName	1 on page 463, 2 on page 463, 3 on page 463	String
com.ibm.db2.jcc.DB2BaseDataSource.clientRerouteAlternatePortNumber	1 on page 463, 2 on page 463, 3 on page 463	String
com.ibm.db2.jcc.DB2BaseDataSource.clientRerouteServerListJNDIContext	1 on page 463, 2 on page 463, 3 on page 463	javax.naming.Context

Table 112. DB2BaseDataSource properties and their data types (continued)

Property name	Applicable data sources	Data type
com.ibm.db2.jcc.DB2BaseDataSource.clientRerouteServerListJNDIName	1 on page 463, 2 on page 463, 3 on page 463	String
com.ibm.db2.jcc.DB2BaseDataSource.clientUser (IBM Data Server Driver for JDBC and SQLJ type 2 connectivity on DB2 for z/OS only)	1 on page 463	String
com.ibm.db2.jcc.DB2BaseDataSource.clientWorkstation (IBM Data Server Driver for JDBC and SQLJ type 2 connectivity on DB2 for z/OS only)	1 on page 463	String
com.ibm.db2.jcc.DB2BaseDataSource.connectionCloseWithInFlightTransaction	1 on page 463, 2 on page 463, 3 on page 463	String
com.ibm.db2.jcc.DB2BaseDataSource.concurrentAccessResolution	1 on page 463, 2 on page 463	int
com.ibm.db2.jcc.DB2BaseDataSource.connectNode	2 on page 463	int
com.ibm.db2.jcc.DB2BaseDataSource.currentDegree	1 on page 463, 2 on page 463	String
com.ibm.db2.jcc.DB2BaseDataSource.currentExplainMode	1 on page 463, 2 on page 463	String
com.ibm.db2.jcc.DB2BaseDataSource.currentExplainSnapshot	2 on page 463	String
com.ibm.db2.jcc.DB2BaseDataSource.currentFunctionPath	1 on page 463, 2 on page 463	String
com.ibm.db2.jcc.DB2BaseDataSource.currentLockTimeout	2 on page 463, 3 on page 463	int
com.ibm.db2.jcc.DB2BaseDataSource.currentMaintainedTableTypesForOptimization	1 on page 463, 2 on page 463	String
com.ibm.db2.jcc.DB2BaseDataSource.currentPackagePath	1 on page 463, 2 on page 463	String
com.ibm.db2.jcc.DB2BaseDataSource.currentPackageSet	1 on page 463, 2 on page 463	String
com.ibm.db2.jcc.DB2BaseDataSource.currentQueryOptimization	2 on page 463	int
com.ibm.db2.jcc.DB2BaseDataSource.currentRefreshAge	1 on page 463, 2 on page 463	long
com.ibm.db2.jcc.DB2BaseDataSource.currentSchema	1 on page 463, 2 on page 463	String
com.ibm.db2.jcc.DB2BaseDataSource.cursorSensitivity	1 on page 463, 2 on page 463	int
com.ibm.db2.jcc.DB2BaseDataSource.currentSQLID	1 on page 463	String
com.ibm.db2.jcc.DB2BaseDataSource.databaseName	1 on page 463, 2 on page 463, 3 on page 463	String
com.ibm.db2.jcc.DB2BaseDataSource.dateFormat	1 on page 463, 2 on page 463	int
com.ibm.db2.jcc.DB2BaseDataSource.decimalRoundingMode	1 on page 463, 2 on page 463	int
com.ibm.db2.jcc.DB2BaseDataSource.decimalSeparator	1 on page 463, 2 on page 463, 3 on page 463	int
com.ibm.db2.jcc.DB2BaseDataSource.decimalStringFormat	1 on page 463, 2 on page 463, 3 on page 463	int
com.ibm.db2.jcc.DB2BaseDataSource.defaultIsolationLevel	1 on page 463, 2 on page 463, 3 on page 463	int

Table 112. DB2BaseDataSource properties and their data types (continued)

Property name	Applicable data sources	Data type
com.ibm.db2.jcc.DB2BaseDataSource.deferPrepares	1 on page 463, 2 on page 463, 3 on page 463	boolean
com.ibm.db2.jcc.DB2BaseDataSource.description	1 on page 463, 2 on page 463, 3 on page 463	String
com.ibm.db2.jcc.DB2BaseDataSource.downgradeHoldCursorsUnderXa	1 on page 463, 2 on page 463, 3 on page 463	boolean
com.ibm.db2.jcc.DB2BaseDataSource.driverType	1 on page 463, 2 on page 463, 3 on page 463	int
com.ibm.db2.jcc.DB2BaseDataSource.dumpPool	3 on page 463	int
com.ibm.db2.jcc.DB2BaseDataSource.dumpPoolStatisticsOnSchedule	3 on page 463	int
com.ibm.db2.jcc.DB2BaseDataSource.dumpPoolStatisticsOnScheduleFile	3 on page 463	String
com.ibm.db2.jcc.DB2BaseDataSource.enableAlternateGroupSeamlessACR	1 on page 463, 2 on page 463	boolean
com.ibm.db2.jcc.DB2BaseDataSource.enableClientAffinitiesList	1 on page 463, 2 on page 463, 3 on page 463	int
com.ibm.db2.jcc.DB2BaseDataSource.enableExtendedIndicators	1 on page 463, 2 on page 463	int
com.ibm.db2.jcc.DB2BaseDataSource.enableNamedParameterMarkers	1 on page 463, 2 on page 463, 3 on page 463	int
com.ibm.db2.jcc.DB2BaseDataSource.enableConnectionConcentrator (IBM Data Server Driver for JDBC and SQLJ type 4 connectivity)	1 on page 463, 3 on page 463	boolean
com.ibm.db2.jcc.DB2BaseDataSource.enableMultiRowInsertSupport	1 on page 463	boolean
com.ibm.db2.jcc.DB2BaseDataSource.enableRowsetSupport	1 on page 463, 2 on page 463	int
com.ibm.db2.jcc.DB2BaseDataSource.enableSeamlessFailover	1 on page 463, 2 on page 463, 3 on page 463	int
com.ibm.db2.jcc.DB2BaseDataSource.enableSysplexWLB (IBM Data Server Driver for JDBC and SQLJ type 4 connectivity)	1 on page 463, 2 on page 463, 3 on page 463	boolean
com.ibm.db2.jcc.DB2BaseDataSource.encryptionAlgorithm	1 on page 463, 2 on page 463	int
com.ibm.db2.jcc.DB2BaseDataSource.fetchSize	1 on page 463, 2 on page 463, 3 on page 463	int
com.ibm.db2.jcc.DB2BaseDataSource.floatingPointStringFormat	1 on page 463, 2 on page 463, 3 on page 463	int
com.ibm.db2.jcc.DB2BaseDataSource.fullyMaterializeInputStreams	1 on page 463, 2 on page 463	boolean
com.ibm.db2.jcc.DB2BaseDataSource.fullyMaterializeLobData	1 on page 463, 2 on page 463, 3 on page 463	boolean
com.ibm.db2.jcc.DB2BaseDataSource.gssCredential	1 on page 463, 2 on page 463	Object
com.ibm.db2.jcc.DB2BaseDataSource.interruptProcessingMode (IBM Data Server Driver for JDBC and SQLJ type 4 connectivity)	1 on page 463, 2 on page 463, 3 on page 463	int

Table 112. DB2BaseDataSource properties and their data types (continued)

Property name	Applicable data sources	Data type
com.ibm.db2.jcc.DB2BaseDataSource.jdbcCollection	1 on page 463	String
com.ibm.db2.jcc.DB2BaseDataSource.keepDynamic	1 on page 463, 3 on page 463	int
com.ibm.db2.jcc.DB2BaseDataSource.kerberosServerPrincipal	1 on page 463, 2 on page 463	String
com.ibm.db2.jcc.DB2BaseDataSource.loginTimeout (not supported for IBM Data Server Driver for JDBC and SQLJ type 2 connectivity on DB2 for z/OS)	1 on page 463, 2 on page 463, 3 on page 463	int
com.ibm.db2.jcc.DB2BaseDataSource.logWriter	1 on page 463, 2 on page 463, 3 on page 463	PrintWriter
com.ibm.db2.jcc.DB2BaseDataSource.maxRetriesForClientReroute	1 on page 463, 2 on page 463, 3 on page 463	int
com.ibm.db2.jcc.DB2BaseDataSource.maxStatements	1 on page 463, 2 on page 463, 3 on page 463	int
com.ibm.db2.jcc.DB2BaseDataSource.maxRowsetSize (IBM Data Server Driver for JDBC and SQLJ type 2 connectivity on DB2 for z/OS only)	1 on page 463	int
com.ibm.db2.jcc.DB2BaseDataSource.maxTransportObjectIdleTime	3 on page 463	int
com.ibm.db2.jcc.DB2BaseDataSource.maxTransportObjectWaitTime	3 on page 463	int
com.ibm.db2.jcc.DB2BaseDataSource.maxTransportObjects	1 on page 463, 3 on page 463	int
com.ibm.db2.jcc.DB2BaseDataSource.minTransportObjects	3 on page 463	int
com.ibm.db2.jcc.DB2BaseDataSource.optimizationProfile	2 on page 463	String
com.ibm.db2.jcc.DB2BaseDataSource.optimizationProfileToFlush	2 on page 463	String
com.ibm.db2.jcc.DB2BaseDataSource.password	1 on page 463, 2 on page 463, 3 on page 463	String
com.ibm.db2.jcc.DB2BaseDataSource.pdqProperties	1 on page 463, 2 on page 463	String
com.ibm.db2.jcc.DB2BaseDataSource.pkList (IBM Data Server Driver for JDBC and SQLJ type 2 connectivity)	1 on page 463	String
com.ibm.db2.jcc.DB2BaseDataSource.planName (IBM Data Server Driver for JDBC and SQLJ type 2 connectivity only)	1 on page 463	String
com.ibm.db2.jcc.DB2BaseDataSource.plugin	2 on page 463	Object
com.ibm.db2.jcc.DB2BaseDataSource.pluginName	2 on page 463	String
com.ibm.db2.jcc.DB2BaseDataSource.portNumber	1 on page 463, 2 on page 463, 3 on page 463	int
com.ibm.db2.jcc.DB2BaseDataSource.progressiveStreaming	1 on page 463, 2 on page 463, 3 on page 463	int
com.ibm.db2.jcc.DB2BaseDataSource.queryCloseImplicit	1 on page 463, 2 on page 463, 3 on page 463	int
com.ibm.db2.jcc.DB2BaseDataSource.queryDataSize	1 on page 463, 2 on page 463, 3 on page 463	int
com.ibm.db2.jcc.DB2BaseDataSource.queryTimeoutInterruptProcessingMode	1 on page 463, 2 on page 463, 3 on page 463	int



Table 112. DB2BaseDataSource properties and their data types (continued)

Property name	Applicable data sources	Data type
com.ibm.db2.jcc.DB2BaseDataSource.readOnly	1 on page 463, 2 on page 463	boolean
com.ibm.db2.jcc.DB2BaseDataSource.reportLongTypes	1 on page 463	short
com.ibm.db2.jcc.DB2BaseDataSource.resultSetHoldability	1 on page 463, 2 on page 463, 3 on page 463	int
com.ibm.db2.jcc.DB2BaseDataSource.resultSetHoldabilityForCatalogQueries	1 on page 463, 2 on page 463	int
com.ibm.db2.jcc.DB2BaseDataSource.retrieveMessagesFromServerOnGetMessage	1 on page 463, 2 on page 463, 3 on page 463	boolean
com.ibm.db2.jcc.DB2BaseDataSource.retryIntervalForClientReroute	1 on page 463, 2 on page 463, 3 on page 463	int
com.ibm.db2.jcc.DB2BaseDataSource.retryWithAlternativeSecurityMechanism (IBM Data Server Driver for JDBC and SQLJ type 4 connectivity)	2 on page 463	int
com.ibm.db2.jcc.DB2BaseDataSource.returnAlias	1 on page 463, 2 on page 463	short
com.ibm.db2.jcc.DB2BaseDataSource.securityMechanism	1 on page 463, 2 on page 463, 3 on page 463	int
com.ibm.db2.jcc.DB2BaseDataSource.sendCharInputsUTF8	1 on page 463	int
com.ibm.db2.jcc.DB2BaseDataSource.sendDataAsIs	1 on page 463, 2 on page 463, 3 on page 463	boolean
com.ibm.db2.jcc.DB2BaseDataSource.serverName	1 on page 463, 2 on page 463, 3 on page 463	String
com.ibm.db2.jcc.DB2BaseDataSource.sessionTimeZone	1 on page 463	String
com.ibm.db2.jcc.DB2BaseDataSource.sqljEnableClassLoaderSpecificProfiles	1 on page 463	boolean
com.ibm.db2.jcc.DB2BaseDataSource.ssid (IBM Data Server Driver for JDBC and SQLJ type 2 connectivity on DB2 for z/OS only)	1 on page 463	String
com.ibm.db2.jcc.DB2BaseDataSource.sslConnection (IBM Data Server Driver for JDBC and SQLJ type 4 connectivity)	1 on page 463, 2 on page 463, 3 on page 463	boolean
com.ibm.db2.jcc.DB2BaseDataSource.sslTrustStoreLocation (IBM Data Server Driver for JDBC and SQLJ type 4 connectivity)	1 on page 463, 2 on page 463, 3 on page 463	String
com.ibm.db2.jcc.DB2BaseDataSource.sslTrustStorePassword (IBM Data Server Driver for JDBC and SQLJ type 4 connectivity)	1 on page 463, 2 on page 463, 3 on page 463	String
com.ibm.db2.jcc.DB2BaseDataSource.statementConcentrator	1 on page 463, 2 on page 463	int
com.ibm.db2.jcc.DB2BaseDataSource.streamBufferSize	1 on page 463, 2 on page 463	int
com.ibm.db2.jcc.DB2BaseDataSource.stripTrailingZerosForDecimalNumbers	1 on page 463, 2 on page 463, 3 on page 463	int
com.ibm.db2.jcc.DB2BaseDataSource.supportsAsynchronousXARollback	1 on page 463, 2 on page 463	int
com.ibm.db2.jcc.DB2BaseDataSource.sysSchema	1 on page 463, 2 on page 463	String

Table 112. DB2BaseDataSource properties and their data types (continued)

Property name	Applicable data sources	Data type
com.ibm.db2.jcc.DB2BaseDataSource.timerLevelForQueryTimeOut	1 on page 463, 2 on page 463, 3 on page 463	int
com.ibm.db2.jcc.DB2BaseDataSource.timeFormat	1 on page 463, 2 on page 463	int
com.ibm.db2.jcc.DB2BaseDataSource.timestampFormat	1 on page 463, 2 on page 463, 3 on page 463	int
com.ibm.db2.jcc.DB2BaseDataSource.timestampOutputType	1 on page 463	int
com.ibm.db2.jcc.DB2BaseDataSource.timestampPrecisionReporting	1 on page 463, 2 on page 463, 3 on page 463	int
com.ibm.db2.jcc.DB2BaseDataSource.traceDirectory	1 on page 463, 2 on page 463, 3 on page 463	String
com.ibm.db2.jcc.DB2BaseDataSource.traceFile	1 on page 463, 2 on page 463, 3 on page 463	String
com.ibm.db2.jcc.DB2BaseDataSource.traceFileAppend	1 on page 463, 2 on page 463, 3 on page 463	boolean
com.ibm.db2.jcc.DB2BaseDataSource.traceFileCount	1 on page 463, 2 on page 463, 3 on page 463	int
com.ibm.db2.jcc.DB2BaseDataSource.traceFileSize	1 on page 463, 2 on page 463, 3 on page 463	int
com.ibm.db2.jcc.DB2BaseDataSource.traceLevel	1 on page 463, 2 on page 463, 3 on page 463	int
com.ibm.db2.jcc.DB2BaseDataSource.traceOption	1 on page 463, 2 on page 463, 3 on page 463	int
com.ibm.db2.jcc.DB2BaseDataSource.useCachedCursor	1 on page 463, 2 on page 463	boolean
com.ibm.db2.jcc.DB2BaseDataSource.useJDBC4ColumnNameAndLabelSemantics	1 on page 463, 2 on page 463	int
com.ibm.db2.jcc.DB2BaseDataSource.useJDBC41DefinitionForGetColumns	1 on page 463, 2 on page 463, 3 on page 463	int
com.ibm.db2.jcc.DB2BaseDataSource.user	1 on page 463, 2 on page 463, 3 on page 463	String
com.ibm.db2.jcc.DB2BaseDataSource.useIdentityValLocalForAutoGeneratedKeys	1 on page 463, 2 on page 463	boolean
com.ibm.db2.jcc.DB2BaseDataSource.useRowsetCursor	1 on page 463	boolean
com.ibm.db2.jcc.DB2BaseDataSource.useTransactionRedirect	2 on page 463	boolean
com.ibm.db2.jcc.DB2BaseDataSource.xaNetworkOptimization	1 on page 463, 2 on page 463, 3 on page 463	boolean
com.ibm.db2.jcc.DB2BaseDataSource.xmlFormat	1 on page 463, 2 on page 463	int
com.ibm.db2.jcc.DB2BaseDataSource.DBANSIWARN	3 on page 463	boolean
com.ibm.db2.jcc.DB2BaseDataSource.DBDATE	3 on page 463	String

Table 112. DB2BaseDataSource properties and their data types (continued)

Property name	Applicable data sources	Data type
com.ibm.db2.jcc.DB2BaseDataSource.DBPATH	3	String
com.ibm.db2.jcc.DB2BaseDataSource.DBSPACETEMP	3	String
com.ibm.db2.jcc.DB2BaseDataSource.DBTEMP	3	String
com.ibm.db2.jcc.DB2BaseDataSource.DBUPSPACE	3	String
com.ibm.db2.jcc.DB2BaseDataSource.DELIMIDENT	3	boolean
com.ibm.db2.jcc.DB2BaseDataSource.IFX_DIRECTIVES	3	String
com.ibm.db2.jcc.DB2BaseDataSource.IFX_EXTDIRECTIVES	3	String
com.ibm.db2.jcc.DB2BaseDataSource.IFX_UPDESC	3	String
com.ibm.db2.jcc.DB2BaseDataSource.IFX_XASTDCOMPLIANCE_XAEND	3	String
com.ibm.db2.jcc.DB2BaseDataSource.INFORMIXOPCACHE	3	String
com.ibm.db2.jcc.DB2BaseDataSource.INFORMIXSTACKSIZE	3	String
com.ibm.db2.jcc.DB2BaseDataSource.NODEFDAC	3	String
com.ibm.db2.jcc.DB2BaseDataSource.OPTCOMPIND	3	String
com.ibm.db2.jcc.DB2BaseDataSource.OPTOFC	3	String
com.ibm.db2.jcc.DB2BaseDataSource.PDQPRIORITY	3	String
com.ibm.db2.jcc.DB2BaseDataSource.PSORT_DBTEMP	3	String
com.ibm.db2.jcc.DB2BaseDataSource.PSORT_NPROCS	3	String
com.ibm.db2.jcc.DB2BaseDataSource.STMT_CACHE	3	String

**Note:** The property applies to connections to the following data sources:

1. DB2 for z/OS
2. DB2 Database for Linux, UNIX, and Windows
3. IBM Informix

## DB2BaseDataSource fields

The following constants are defined only for the IBM Data Server Driver for JDBC and SQLJ.

**public final static int INTERRUPT\_PROCESSING\_MODE\_DISABLED = 0**

A constant for the interruptProcessingMode property. This value indicates that interrupt processing is disabled.

**public final static int INTERRUPT\_PROCESSING\_MODE\_STATEMENT\_CANCEL = 1**

A constant for the interruptProcessingMode property. This value indicates that the IBM Data Server Driver for JDBC and SQLJ cancels the currently executing statement when an application executes Statement.cancel, if the data server supports interrupt processing.

**public final static int INTERRUPT\_PROCESSING\_MODE\_CLOSE\_SOCKET = 2**

A constant for the interruptProcessingMode property. This value indicates that the IBM Data Server Driver for JDBC and SQLJ drops the underlying socket and closes the connection when an application executes Statement.cancel.

**public final static int NOT\_SET = 0**

The default value for properties.

**public final static int YES = 1**

The YES value for properties.

**public final static int NO = 2**

The NO value for properties.

**public final static int QUERYTIMEOUT\_DISABLED = -1**

A constant for the `timerLevelForQueryTimeOut` property. This value indicates that Timer objects for waiting for queries to time out are not created.

**public final static int QUERYTIMEOUT\_STATEMENT\_LEVEL = 1**

A constant for the `timerLevelForQueryTimeOut` property. This value indicates that Timer objects for waiting for queries to time out are created at the Statement level.

**public final static int QUERYTIMEOUT\_CONNECTION\_LEVEL = 2**

A constant for the `timerLevelForQueryTimeOut` property. This value indicates that Timer objects for waiting for queries to time out are created at the Connection level.

**public final static int TRACE\_OPTION\_CIRCULAR = 1**

A constant for the `traceOption` property. This value indicates that the IBM Data Server Driver for JDBC and SQLJ uses circular tracing.

## DB2BaseDataSource methods

In addition to the `getXXX` and `setXXX` methods for the `DB2BaseDataSource` properties, the following methods are defined only for the IBM Data Server Driver for JDBC and SQLJ.

### getReference

Format:

```
public javax.naming.Reference getReference()
    throws javax.naming.NamingException
```

Retrieves the Reference of a `DataSource` object. For an explanation of a Reference, see the description of `javax.naming.Referenceable` in the Java Platform Standard Edition documentation.

## DB2CallableStatement interface

The `com.ibm.db2.jcc.DB2CallableStatement` interface extends the `java.sql.CallableStatement` and the `com.ibm.db2.jcc.DB2PreparedStatement` interfaces.

## DB2CallableStatement methods

The following methods are defined only for the IBM Data Server Driver for JDBC and SQLJ.

### getDBTimestamp

Formats:

```
public DBTimestamp getDBTimestamp(int parameterIndex)
    throws SQLException
public DBTimestamp getDBTimestamp(String parameterName)
    throws SQLException
```

Returns the value of a `TIMESTAMP OUT` or `INOUT` parameter as a `DBTimestamp` object. If the value of the parameter is `NULL`, the returned value is `null`.

Parameters:

*parameterIndex*

The number of the parameter whose value is being retrieved.

*parameterName*

The name of the parameter whose value is being retrieved.

This method is not supported for connections to IBM Informix.

#### **getJccArrayAtName**

Format:

```
public java.sql.Array getJccArrayAtName(String parameterMarkerName)
    throws java.sql.SQLException
```

Retrieves an ARRAY value that is designated by a named parameter marker as a java.sql.Array value.

This method can be called only if the enableNamedParameterMarkers property is set to DB2BaseDataSource.YES (1).

Parameters:

*parameterMarkerName*

The name of the parameter marker for which a value is retrieved.

#### **getJccBigDecimalAtName**

Format:

```
public java.math.BigDecimal getJccBigDecimalAtName(String parameterMarkerName)
    throws java.sql.SQLException
public java.math.BigDecimal getJccBigDecimalAtName(String parameterMarkerName,
    int scale)
    throws java.sql.SQLException
```

Retrieves a DECIMAL value that is designated by a named parameter marker as a java.math.BigDecimal value.

This method can be called only if the enableNamedParameterMarkers property is set to DB2BaseDataSource.YES (1).

Parameters:

*parameterMarkerName*

The name of the parameter marker for which a value is retrieved.

*scale*

The scale of the value that is retrieved.

#### **getJccBlobAtName**

Formats:

```
public java.sql.Blob getJccBlobAtName(String parameterMarkerName)
    throws java.sql.SQLException
```

Retrieves a BLOB value that is designated by a named parameter marker as a java.sql.Blob value.

This method can be called only if the enableNamedParameterMarkers property is set to DB2BaseDataSource.YES (1).

Parameters:

*parameterMarkerName*

The name of the parameter marker for which a value is retrieved.

#### **getJccBooleanAtName**

Format:

```
public boolean getJccBooleanAtName(String parameterMarkerName)
    throws java.sql.SQLException
```

Retrieves a BIT or BOOLEAN value that is designated by a named parameter marker as a boolean value.

This method can be called only if the `enableNamedParameterMarkers` property is set to `DB2BaseDataSource.YES` (1).

Parameters:

*parameterMarkerName*

The name of the parameter marker for which a value is retrieved.

#### **getJccByteAtName**

Format:

```
public byte getJccByteAtName(String parameterMarkerName)
    throws java.sql.SQLException
```

Retrieves a TINYINT value that is designated by a named parameter marker as a byte value.

This method can be called only if the `enableNamedParameterMarkers` property is set to `DB2BaseDataSource.YES` (1).

Parameters:

*parameterMarkerName*

The name of the parameter marker for which a value is retrieved.

#### **getJccBytesAtName**

Format:

```
public byte[] getJccBytesAtName(String parameterMarkerName)
    throws java.sql.SQLException
```

Retrieves a BINARY or VARBINARY value that is designated by a named parameter marker as an array of byte values.

This method can be called only if the `enableNamedParameterMarkers` property is set to `DB2BaseDataSource.YES` (1).

Parameters:

*parameterMarkerName*

The name of the parameter marker for which a value is retrieved.

#### **getJccClobAtName**

Format:

```
public java.sql.Blob getJccClobAtName(String parameterMarkerName)
    throws java.sql.SQLException
```

Retrieves a CLOB value that is designated by a named parameter marker as a `java.sql.Clob` value.

This method can be called only if the `enableNamedParameterMarkers` property is set to `DB2BaseDataSource.YES` (1).

Parameters:

*parameterMarkerName*

The name of the parameter marker for which a value is retrieved.

#### **getJccDateAtName**

Formats:

```

public java.sql.Date getJccDateAtName(String parameterMarkerName)
    throws java.sql.SQLException
public java.sql.Date getJccDateAtName(String parameterMarkerName,
    java.util.Calendar cal)
    throws java.sql.SQLException

```

Retrieves a DATE value that is designated by a named parameter marker as a java.sql.Date value.

This method can be called only if the enableNamedParameterMarkers property is set to DB2BaseDataSource.YES (1).

Parameters:

*parameterMarkerName*

The name of the parameter marker for which a value is retrieved.

*cal*

The java.util.Calendar object that the IBM Data Server Driver for JDBC and SQLJ uses to construct the date.

#### **getJccDoubleAtName**

Format:

```

public double getJccDoubleAtName(String parameterMarkerName)
    throws java.sql.SQLException

```

Retrieves a DOUBLE value that is designated by a named parameter marker as a double value.

This method can be called only if the enableNamedParameterMarkers property is set to DB2BaseDataSource.YES (1).

Parameters:

*parameterMarkerName*

The name of the parameter marker for which a value is retrieved.

#### **getJccFloatAtName**

Format:

```

public double getJccFloatAtName(String parameterMarkerName)
    throws java.sql.SQLException

```

Retrieves a FLOAT value that is designated by a named parameter marker as a double value.

This method can be called only if the enableNamedParameterMarkers property is set to DB2BaseDataSource.YES (1).

Parameters:

*parameterMarkerName*

The name of the parameter marker for which a value is retrieved.

#### **getJccIntAtName**

Format:

```

public int getJccIntAtName(String parameterMarkerName)
    throws java.sql.SQLException

```

Retrieves a INTEGER value that is designated by a named parameter marker as a int value.

This method can be called only if the enableNamedParameterMarkers property is set to DB2BaseDataSource.YES (1).

Parameters:

*parameterMarkerName*

The name of the parameter marker for which a value is retrieved.

#### **getJccLongAtName**

Format:

```
public long getJccLongAtName(String parameterMarkerName)
    throws java.sql.SQLException
```

Retrieves a BIGINT value that is designated by a named parameter marker as a long value.

This method can be called only if the `enableNamedParameterMarkers` property is set to `DB2BaseDataSource.YES (1)`.

Parameters:

*parameterMarkerName*

The name of the parameter marker for which a value is retrieved.

#### **getJccObjectAtName**

Formats:

```
public java.sql.Object getJccObjectAtName(String parameterMarkerName)
    throws java.sql.SQLException
public java.sql.Object getJccObjectAtName(String parameterMarkerName,
    Map map)
    throws java.sql.SQLException
```

Retrieves a value that is designated by a named parameter marker as a `java.sql.Object` value.

This method can be called only if the `enableNamedParameterMarkers` property is set to `DB2BaseDataSource.YES (1)`.

Parameters:

*parameterMarkerName*

The name of the parameter marker for which a value is retrieved.

*map*

The mapping from SQL type names to Java classes.

#### **getJccRowIdAtName**

Format:

```
public java.sql.RowId getJccRowIdAtName(String parameterMarkerName)
    throws java.sql.SQLException
```

Retrieves a ROWID value that is designated by a named parameter marker as a `java.sql.RowId` value.

This method can be called only if the `enableNamedParameterMarkers` property is set to `DB2BaseDataSource.YES (1)`.

This method requires the IBM Data Server Driver for JDBC and SQLJ Version 4.8 or later.

Parameters:

*parameterMarkerName*

The name of the parameter marker for which a value is retrieved.

#### **getJccShortAtName**

Format:



```
public short getJccShortAtName(String parameterMarkerName)
    throws java.sql.SQLException
```

Retrieves a SMALLINT value that is designated by a named parameter marker as a short value.

This method can be called only if the enableNamedParameterMarkers property is set to DB2BaseDataSource.YES (1).

Parameters:

*parameterMarkerName*

The name of the parameter marker for which a value is retrieved.

#### **getJccSQLXMLAtName**

Format:

```
public java.sql.SQLXML getJccSQLXMLAtName(String parameterMarkerName)
    throws java.sql.SQLException
```

Retrieves a SQLXML value that is designated by a named parameter marker as a java.sql.SQLXML value.

This method can be called only if the enableNamedParameterMarkers property is set to DB2BaseDataSource.YES (1).

This method requires the IBM Data Server Driver for JDBC and SQLJ Version 4.8 or later.

Parameters:

*parameterMarkerName*

The name of the parameter marker for which a value is retrieved.

#### **getJccStringAtName**

Format:

```
public java.lang.String getJccStringAtName(String parameterMarkerName)
    throws java.sql.SQLException
```

Retrieves a CHAR, VARCHAR, or LONGVARCHAR value that is designated by a named parameter marker as a java.lang.String value.

This method can be called only if the enableNamedParameterMarkers property is set to DB2BaseDataSource.YES (1).

Parameters:

*parameterMarkerName*

The name of the parameter marker for which a value is retrieved.

#### **getJccTimeAtName**

Formats:

```
public java.sql.Time getJccTimeAtName(String parameterMarkerName)
    throws java.sql.SQLException
public java.sql.Time getJccTimeAtName(String parameterMarkerName,
    java.util.Calendar cal)
    throws java.sql.SQLException
```

Retrieves a TIME value that is designated by a named parameter marker as a java.sql.Time value.

This method can be called only if the enableNamedParameterMarkers property is set to DB2BaseDataSource.YES (1).

Parameters:

*parameterMarkerName*

The name of the parameter marker for which a value is retrieved.

*cal*

The java.util.Calendar object that the IBM Data Server Driver for JDBC and SQLJ uses to construct the time.

#### **getJccTimestampAtName**

Formats:

```
public java.sql.Timestamp getJccTimestampAtName(String parameterMarkerName)
    throws java.sql.SQLException
public java.sql.Timestamp getJccTimestampAtName(String parameterMarkerName,
    java.util.Calendar cal)
    throws java.sql.SQLException
```

Retrieves a TIMESTAMP value that is designated by a named parameter marker as a java.sql.Timestamp value.

This method can be called only if the enableNamedParameterMarkers property is set to DB2BaseDataSource.YES (1).

Parameters:

*parameterMarkerName*

The name of the parameter marker for which a value is retrieved.

*cal*

The java.util.Calendar object that the IBM Data Server Driver for JDBC and SQLJ uses to construct the timestamp.

#### **registerJccOutParameterAtName**

Formats:

```
public void registerJccOutParameterAtName(String parameterMarkerName,
    int sqlType)
    throws java.sql.SQLException
public void registerJccOutParameterAtName(String parameterMarkerName,
    int sqlType,
    int scale)
    throws java.sql.SQLException
public void registerJccOutParameterAtName(String parameterMarkerName,
    int sqlType,
    String typeName)
    throws java.sql.SQLException
```

Registers an OUT parameter that is identified by *parameterMarkerName* as the JDBC type *sqlType*.

This method can be called only if the enableNamedParameterMarkers property is set to DB2BaseDataSource.YES (1).

Parameters:

*parameterMarkerName*

The name of the parameter marker for the parameter that is to be registered.

*sqlType*

The JDBC type code, as defined in java.sql.Types, of the parameter that is to be registered.

*scale*

The scale of the parameter that is to be registered. This parameter applies only to this case:

- If *sqlType* is `java.sql.Types.DECIMAL` or `java.sql.Types.NUMERIC`, *scale* is the number of digits to the right of the decimal point.

*typeName*

If *jdbcType* is `java.sql.Types.DISTINCT` or `java.sql.Types.REF`, the fully-qualified name of the SQL user-defined type of the parameter that is to be registered.

#### **setDBTimestamp**

Format:

```
public void setDBTimestamp(String parameterName,
    DBTimestamp timestamp)
    throws java.sql.SQLException
```

Assigns a DBTimestamp value to an IN or INOUT parameter.

Parameters:

*parameterName*

The name of the parameter to which a DBTimestamp variable value is assigned.

*timestamp*

The DBTimestamp value that is assigned to the parameter.

This method is not supported for connections to IBM Informix.

#### **setJccXXXAtName methods**

These methods are inherited from `DB2PreparedStatement`.

## **DB2CataloguedDatabase class**

The `com.ibm.db2.jcc.DB2CataloguedDatabase` class contains methods that retrieve information about a local DB2 Database for Linux, UNIX, and Windows database.

No database connection is needed for calling `DB2CataloguedDatabase` methods.

### **DB2CataloguedDatabase methods**

#### **getServerName**

Format:

```
public String getServerName()
```

Retrieves the name of the server on which the database resides.

#### **getPortNumber**

Format:

```
public int getPortNumber()
```

Retrieves the port number that is associated with the DB2 instance.

#### **getDatabaseName**

Format:

```
public String getDatabaseName()
```

Retrieves the database name.

#### **getDatabaseAlias**

Format:

```
public String getDatabaseAlias()
```

Retrieves the database alias.

## DB2ClientRerouteServerList class

The `com.ibm.db2.jcc.DB2ClientRerouteServerList` class implements the `java.io.Serializable` and `javax.naming.Referenceable` interfaces.

### DB2ClientRerouteServerList methods

#### **getAlternatePortNumber**

Format:

```
public int[] getAlternatePortNumber()
```

Retrieves the port numbers that are associated with the alternate servers.

#### **getAlternateServerName**

Format:

```
public String[] getAlternateServerName()
```

Retrieves an array that contains the names of the alternate servers. These values are IP addresses or DNS server names.

#### **getPrimaryPortNumber**

Format:

```
public int getPrimaryPortNumber()
```

Retrieves the port number that is associated with the primary server.

#### **getPrimaryServerName**

Format:

```
public String[] getPrimaryServerName()
```

Retrieves the name of the primary server. This value is an IP address or a DNS server name.

#### **setAlternatePortNumber**

Format:

```
public void setAlternatePortNumber(int[] alternatePortNumberList)
```

Sets the port numbers that are associated with the alternate servers.

#### **setAlternateServerName**

Format:

```
public void setAlternateServerName(String[] alternateServer)
```

Sets the alternate server names for servers. These values are IP addresses or DNS server names.

#### **setPrimaryPortNumber**

Format:

```
public void setPrimaryPortNumber(int primaryPortNumber)
```

Sets the port number that is associated with the primary server.

#### **setPrimaryServerName**

Format:

```
public void setPrimaryServerName(String primaryServer)
```

Sets the primary server name for a server. This value is an IP address or a DNS server name.

## DB2Connection interface

The `com.ibm.db2.jcc.DB2Connection` interface extends the `java.sql.Connection` interface.

`DB2Connection` implements the `java.sql.Wrapper` interface.

## DB2Connection methods

The following methods are defined only for the IBM Data Server Driver for JDBC and SQLJ.

### **alternateWasUsedOnConnect**

Format:

```
public boolean alternateWasUsedOnConnect()
    throws java.sql.SQLException
```

Returns true if the driver used alternate server information to obtain the connection. The alternate server information is available in the transient `clientRerouteServerList` information on the `DB2BaseDataSource`, which the database server updates as primary and alternate servers change.

### **changeDB2Password**

Format:

```
public abstract void changeDB2Password(String oldPassword,
    String newPassword)
    throws java.sql.SQLException
```

Changes the password for accessing the data source, for the user of the `Connection` object.

Parameter descriptions:

*oldPassword*

The original password for the `Connection`.

*newPassword*

The new password for the `Connection`.

### **createArrayOf**

Format:

```
Array createArrayOf(String typeName,
    Object[] elements)
    throws SQLException;
```

Creates a `java.sql.Array` object.

Parameter descriptions:

*typeName*

The SQL data type of the elements of the array map to. *typeName* can be a built-in data type or a distinct type.

*elements*

The elements that populate the `Array` object.

### **createStruct**

Format:

```
Struct createStruct(String typeName,  
    Object[] attributes)  
    throws SQLException;
```

Returns a `java.sql.Struct` object that maps to `typeName` and has the attributes that are specified by `attributes`.

Parameter descriptions:

*typeName*

The SQL data type of the SQL structured type that the `Struct` object maps to. `typeName` is the name of a user-defined type that has been defined on the data server.

*attributes*

The attributes that populate the returned `Struct` object.

### **deregisterDB2XmlObject**

Formats:

```
public void deregisterDB2XmlObject(String sqlIdSchema,  
    String sqlIdName)  
    throws SQLException
```

Removes a previously registered XML schema from the data source.

Parameter descriptions:

*sqlIdSchema*

The SQL schema name for the XML schema. `sqlIdSchema` is a `String` value with a maximum length of 128 bytes. The value of `sqlIdSchema` must conform to the naming rules for any SQL schema name. The name cannot begin with the string 'SYS'. If the value of `sqlIdSchema` is null, the database system uses the value in the CURRENT SCHEMA special register.

*sqlIdName*

The SQL name for the XML schema. `sqlIdName` is a `String` value with a maximum length of 128 bytes. The value of `sqlIdName` must conform to the rules for an SQL identifier. If the value of `sqlIdSchema` is null, the value of `sqlIdName` can be null. In that case, the database system generates the value for `sqlIdName`.

### **getDB2ClientAccountingInformation**

Format:

```
public String getDB2ClientAccountingInformation()  
    throws SQLException
```

Returns accounting information for the current client.

**Important:** `getDB2ClientAccountingInformation` is deprecated in the JDBC 4.0 implementation of the IBM Data Server Driver for JDBC and SQLJ. Use `java.sql.Connection.getClientInfo` instead.

### **getDB2ClientApplicationInformation**

Format:

```
public String getDB2ClientApplicationInformation()  
    throws java.sql.SQLException
```

Returns application information for the current client.

**Important:** `getDB2ClientApplicationInformation` is deprecated in the JDBC 4.0 implementation of the IBM Data Server Driver for JDBC and SQLJ. Use `java.sql.Connection.getClientInfo` instead.

### **getDB2ClientProgramId**

Format:

```
public String getDB2ClientProgramId()
    throws java.sql.SQLException
```

Returns the user-defined program identifier for the client. The program identifier can be used to identify the application at the data source.

getDB2ClientProgramId does not apply to DB2 Database for Linux, UNIX, and Windows data servers.

### **getDB2ClientUser**

Format:

```
public String getDB2ClientUser()
    throws java.sql.SQLException
```

Returns the current client user name for the connection. This name is not the user value for the JDBC connection.

**Important:** getDB2ClientUser is deprecated in the JDBC 4.0 implementation of the IBM Data Server Driver for JDBC and SQLJ. Use `java.sql.Connection.getClientInfo` instead.

### **getDB2ClientWorkstation**

Format:

```
public String getDB2ClientWorkstation()
    throws java.sql.SQLException
```

Returns current client workstation name for the current client.

**Important:** getDB2ClientWorkstation is deprecated in the JDBC 4.0 implementation of the IBM Data Server Driver for JDBC and SQLJ. Use `java.sql.Connection.getClientInfo` instead.

### **getDB2Correlator**

Format:

```
String getDB2Correlator()
    throws java.sql.SQLException
```

Returns the value of the `crtrkn` (correlation token) instance variable that DRDA sends with the ACCRDB command. The correlation token uniquely identifies a logical connection to a server.

### **getDB2CurrentPackagePath**

Format:

```
public String getDB2CurrentPackagePath()
    throws java.sql.SQLException
```

Returns the list of DB2 package collections that are searched for JDBC and SQLJ packages.

The `getDB2CurrentPackagePath` method applies only to connections to DB2 database systems.

### **getDB2CurrentPackageSet**

Format:

```
public String getDB2CurrentPackageSet()
    throws java.sql.SQLException
```

Returns the collection ID for the connection.

The `getDB2CurrentPackageSet` method applies only to connections to DB2 database systems.

#### **getDB2ProgressiveStreaming**

Format:

```
public int getDB2ProgressiveStreaming()  
    throws java.sql.SQLException
```

Returns the current progressive streaming setting for the connection.

The returned value depends on whether the data source supports progressive streaming, how the `progressiveStreaming` property is set, and whether `DB2Connection.setProgressiveStreaming` was called:

- If the data source does not support progressive streaming, 2 (NO) is always returned, regardless of the `progressiveStreaming` property setting.
- If the data source supports progressive streaming, and `DB2Connection.setProgressiveStreaming` was called, the returned value is the value that `DB2Connection.setProgressiveStreaming` set.
- If the data source supports progressive streaming, and `DB2Connection.setProgressiveStreaming` was not called, the returned value is 2 (NO) if `progressiveStreaming` was set to `DB2BaseDataSource.NO`. If `progressiveStreaming` was set to `DB2BaseDataSource.YES` or was not set, the returned value is 1 (YES).

#### **getDB2SecurityMechanism**

Format:

```
public int getDB2SecurityMechanism()  
    throws java.sql.SQLException
```

Returns the security mechanism that is in effect for the connection:

- 3 Clear text password security
- 4 User ID-only security
- 7 Encrypted password security
- 9 Encrypted user ID and password security
- 11 Kerberos security
- 12 Encrypted user ID and data security
- 13 Encrypted user ID, password, and data security
- 15 Plugin security
- 16 Encrypted user ID-only security

#### **getDB2SystemMonitor**

Format:

```
public abstract DB2SystemMonitor getDB2SystemMonitor()  
    throws java.sql.SQLException
```

Returns the system monitor object for the connection. Each IBM Data Server Driver for JDBC and SQLJ connection can have a single system monitor.

#### **getDBConcurrentAccessResolution**

Format:

```
public int getDBConcurrentAccessResolution()  
    throws java.sql.SQLException
```



Returns the concurrent access setting for the connection. The concurrent access setting is set by the `setDBConcurrentAccessResolution` method or by the `concurrentAccessResolution` property.

`getDBConcurrentAccessResolution` applies only to connections to DB2 for z/OS and DB2 Database for Linux, UNIX, and Windows.

#### **getDBProgressiveStreaming**

Format:

```
public int getDB2ProgressiveStreaming()  
    throws java.sql.SQLException
```

Returns the current progressive streaming setting for the connection.

The returned value depends on whether the data source supports progressive streaming, how the `progressiveStreaming` property is set, and whether `DB2Connection.setProgressiveStreaming` was called:

- If the data source does not support progressive streaming, 2 (NO) is always returned, regardless of the `progressiveStreaming` property setting.
- If the data source supports progressive streaming, and `DB2Connection.setProgressiveStreaming` was called, the returned value is the value that `DB2Connection.setProgressiveStreaming` set.
- If the data source supports progressive streaming, and `DB2Connection.setProgressiveStreaming` was not called, the returned value is 2 (NO) if `progressiveStreaming` was set to `DB2BaseDataSource.NO`. If `progressiveStreaming` was set to `DB2BaseDataSource.YES` or was not set, the returned value is 1 (YES).

#### **getDBStatementConcentrator**

Format:

```
public int getDBStatementConcentrator()  
    throws java.sql.SQLException
```

Returns the statement concentrator use setting for the connection. The statement concentrator use setting is set by the `setDBStatementConcentrator` method or by the `statementConcentrator` property.

#### **getJccLogWriter**

Format:

```
public PrintWriter getJccLogWriter()  
    throws java.sql.SQLException
```

Returns the current trace destination for the IBM Data Server Driver for JDBC and SQLJ trace.

#### **getJccSpecialRegisterProperties**

Format:

```
public java.util.Properties getJccSpecialRegisterProperties()  
    throws java.sql.SQLException
```

Returns a `java.util.Properties` object, in which the keys are the special registers that are supported at the target data source, and the key values are the current values of those special registers.

This method does not apply to connections to IBM Informix data sources.

#### **getSavePointUniqueOption**

Format:

```
public boolean getSavePointUniqueOption()
    throws java.sql.SQLException
```

Returns true if `setSavePointUniqueOption` was most recently called with a value of true. Returns false otherwise.

### **installDB2JavaStoredProcedure**

Format:

```
public void DB2Connection.installDB2JavaStoredProcedure(
    java.io.InputStream jarFile,
    int jarFileLength,
    String jarId)
    throws java.sql.SQLException
```

Invokes the `sqlj.install_jar` stored procedure on a DB2 Database for Linux, UNIX, and Windows server to create a new definition of a JAR file in the catalog for that server.

Parameter descriptions:

*jarFile*

The contents of the JAR file that is to be defined to the server.

*jarFileLength*

The length of the JAR file that is to be defined to the server.

*jarId*

The name of the JAR in the database, in the form *schema.JAR-id* or *JAR-id*. This is the name that you use when you refer to the JAR in SQL statements. If you omit *schema*, the database system uses the SQL authorization ID that is in the CURRENT SCHEMA special register. The owner of the JAR is the authorization ID in the CURRENT SQLID special register.

This method does not apply to connections to IBM Informix data sources.

### **isDB2Alive**

Format:

```
public boolean DB2Connection.isDB2Alive()
    throws java.sql.SQLException
```

Returns true if the socket for a connection to the data source is still active.

**Important:** `isDB2Alive` is deprecated in the JDBC 4.0 implementation of the IBM Data Server Driver for JDBC and SQLJ. Use `Connection.isValid` instead.

### **isDBValid**

Format:

```
public boolean DB2Connection.isDBValid(boolean throwException, int timeout)
    throws java.sql.SQLException
```

Returns true if the connection has not been closed and is still valid. Returns false otherwise.

Parameter descriptions:

*throwException*

Specifies whether `isDBValid` throws an `SQLException` if the connection is not valid. Possible values are:

**true** `isDBValid` throws an `SQLException` if the connection is not valid.

**false** isDBValid throws an SQLException only if the value of *timeout* is not valid.

*timeout*

The time in seconds to wait for completion of a database operation that the driver submits. The driver submits that database operation to the data source to validate the connection. If the timeout period expires before the database operation completes, isDBValid returns false. A value of 0 indicates that there is no timeout period for the database operation.

For IBM Data Server Driver for JDBC and SQLJ type 4 connectivity, isDBValid throws an SQLException if the value of *timeout* is less than 0.

For IBM Data Server Driver for JDBC and SQLJ type 2 connectivity, isDBValid throws an SQLException if the value of *timeout* is not equal to 0.

This method does not apply to connections to IBM Informix data sources.

**prepareDB2OptimisticLockingQuery**

Format:

```
public java.sql.PreparedStatement
    DB2Connection.prepareDB2OptimisticLockingQuery(String sql,
        int returnOptimisticLockingColumns)
    throws SQLException
```

Creates a PreparedStatement object that can request optimistic locking information.

Parameter descriptions:

*sql*

The SQL statement that is to be prepared.

*returnOptimisticLockingColumns*

Specifies whether optimistic locking columns are returned. Possible values are:

Table 113. Values for the returnOptimisticLockingColumns parameter

Value	Description
DB2Statement.RETURN_OPTLOCK_COLUMN_NONE (0)	Do not return optimistic locking columns.
DB2Statement.RETURN_OPTLOCK_COLUMN_ALWAYS (1)	Add row change columns to the result set even if they do not uniquely represent a single row. This setting is equivalent to the database prepare attribute WITH ROW CHANGE COLUMNS POSSIBLY DISTINCT.
DB2Statement.RETURN_OPTLOCK_COLUMN_NO_FALSE_NEGATIVES (2)	Add row change columns to the result set only if they uniquely represent a single row. This setting is equivalent to the database prepare attribute WITH ROW CHANGE COLUMNS ALWAYS DISTINCT.

**reconfigureDB2Connection**

Format:

```
public void reconfigureDB2Connection(java.util.Properties properties)
    throws SQLException
```

Reconfigures a connection with new settings. The connection does not need to be returned to a connection pool before it is reconfigured. This method can be called while a transaction is in progress, and can be used for trusted or untrusted connections.

Trusted connections are supported for:

- IBM Data Server Driver for JDBC and SQLJ type 4 connectivity to:
  - DB2 Database for Linux, UNIX, and Windows Version 9.5 or later
  - DB2 for z/OS Version 9.1 or later
  - IBM Informix Version 11.70 or later
- IBM Data Server Driver for JDBC and SQLJ type 2 connectivity on DB2 for z/OS Version 9.1 or later

Parameter descriptions:

*properties*

New properties for the connection. These properties override any properties that are already defined on the DB2Connection instance.

**registerDB2XmlSchema**

Formats:

```
public void registerDB2XmlSchema(String[] sqlIdSchema,
    String[] sqlIdName,
    String[] xmlSchemaLocations,
    InputStream[] xmlSchemaDocuments,
    int[] xmlSchemaDocumentsLengths,
    InputStream[] xmlSchemaDocumentsProperties,
    int[] xmlSchemaDocumentsPropertiesLengths,
    InputStream xmlSchemaProperties,
    int xmlSchemaPropertiesLength,
    boolean isUsedForShredding)
    throws SQLException
public void registerDB2XmlSchema(String[] sqlIdSchema,
    String[] sqlIdName,
    String[] xmlSchemaLocations,
    String[] xmlSchemaDocuments,
    String[] xmlSchemaDocumentsProperties,
    String xmlSchemaProperties,
    boolean isUsedForShredding)
    throws SQLException
```

Registers an XML schema with one or more XML schema documents. If multiple XML schema documents are processed with one call to registerDB2XmlSchema, those documents are processed as part of a single transaction.

The first form of registerDB2XmlSchema is for XML schema documents that are read from an input stream. The second form of registerDB2XmlSchema is for XML schema documents that are read from strings.

Parameter descriptions:

*sqlIdSchema*

The SQL schema name for the XML schema. Only the first element of the *sqlIdSchema* array is used. *sqlIdSchema* is a String value with a maximum length of 128 bytes. The value of *sqlIdSchema* must conform to the naming rules for any SQL schema name. The name cannot begin with the string 'SYS'. If the value of *sqlIdSchema* is null, the database system uses the value in the CURRENT SCHEMA special register.

*sqlIdName*

The SQL name for the XML schema. Only the first element of the *sqlIdName* array is used. *sqlIdName* is a String value with a maximum length of 128 bytes. The value of *sqlIdName* must conform to the rules for an SQL identifier. If the value of *sqlIdSchema* is null, the value of *sqlIdName* can be null, In that case, the database system generates the value for *sqlIdName*.

#### *xmlSchemaLocations*

XML schema locations for the primary XML schema documents of the schemas that are being registered. XML schema location values are normally in URI format. Each *xmlSchemaLocations* value is a String value with a maximum length of 1000 bytes. The value is used only to match the information that is specified in the XML schema document that references this document. The database system does no validation of the format, and no attempt is made to resolve the URI.

#### *xmlSchemaDocuments*

The content of the primary XML schema documents. Each *xmlSchemaDocuments* value is a String or InputStream value with a maximum length of 30 MB. The values must not be null.

#### *xmlSchemaDocumentsLengths*

The lengths of the XML schema documents in the *xmlSchemaDocuments* parameter, if the first form of registerDB2XmlSchema is used. Each *xmlSchemaDocumentsLengths* value is an int value.

#### *xmlSchemaDocumentsProperties*

Contains properties of the primary XML schema documents, such as properties that are used by an external XML schema versioning system. The database system does no validation of the contents of these values. They are stored in the XSR table for retrieval and used in other tools and XML schema repository implementations. Each *xmlSchemaDocumentsProperties* value is a String or InputStream value with a maximum length of 5 MB. A value is null if there are no properties to be passed.

#### *xmlSchemaDocumentsPropertiesLengths*

The lengths of the XML schema properties in the *xmlSchemaDocumentsProperties* parameter, if the first form of registerDB2XmlSchema is used. Each *xmlSchemaDocumentsPropertiesLengths* value is an int value.

#### *xmlSchemaProperties*

Contains properties of the entire XML schema, such as properties that are used by an external XML schema versioning system. The database system does no validation of the contents of this value. They are stored in the XSR table for retrieval and used in other tools and XML schema repository implementations. The *xmlSchemaProperties* value is a String or InputStream value with a maximum length of 5 MB. The value is null if there are no properties to be passed.

#### *xmlSchemaPropertiesLengths*

The length of the XML schema property in the *xmlSchemaProperties* parameter, if the first form of registerDB2XmlSchema is used. The *xmlSchemaPropertiesLengths* value is an int value.

#### *isUsedForShredding*

Indicates whether there are annotations in the schema that are to be used for XML decomposition. *isUsedForShredding* is a boolean value.

This method does not apply to connections to IBM Informix data sources.

#### **setDBConcurrentAccessResolution**

Format:

```
public void setDBConcurrentAccessResolution(int concurrentAccessResolution)
    throws java.sql.SQLException
```

Specifies whether the IBM Data Server Driver for JDBC and SQLJ requests that a read transaction can access a committed and consistent image of rows that are incompatibly locked by write transactions, if the data source supports accessing currently committed data, and the application isolation level is cursor stability (CS) or read stability (RS). This option has the same effect as the DB2 CONCURRENTACCESSRESOLUTION bind option.

setDBConcurrentAccessResolution affects only statements that are created after setDBConcurrentAccessResolution is executed.

setDBConcurrentAccessResolution applies only to connections to DB2 for z/OS and DB2 Database for Linux, UNIX, and Windows.

Parameter descriptions:

*concurrentAccessResolution*

One of the following integer values:

**DB2BaseDataSource.-**

**CONCURRENTACCESS\_USE\_CURRENTLY\_COMMITTED (1)**

The IBM Data Server Driver for JDBC and SQLJ requests that:

- Read transactions access the currently committed data when the data is being updated or deleted.
- Read transactions skip rows that are being inserted.

**DB2BaseDataSource.CONCURRENTACCESS\_WAIT\_FOR\_OUTCOME**

**(2)** The IBM Data Server Driver for JDBC and SQLJ requests that:

- Read transactions wait for a commit or rollback operation when they encounter data that is being updated or deleted.
- Read transactions do not skip rows that are being inserted.

**DB2BaseDataSource.CONCURRENTACCESS\_NOT\_SET (0)**

Enables the data server's default behavior for read transactions when lock contention occurs. This is the default value.

#### **setDBProgressiveStreaming**

Format:

```
public void setDB2ProgressiveStreaming(int newSetting)
    throws java.sql.SQLException
```

Sets the progressive streaming setting for all ResultSet objects that are created on the connection.

Parameter descriptions:

*newSetting*

The new progressive streaming setting. Possible values are:

**DB2BaseDataSource.YES (1)**

Enable progressive streaming. If the data source does not support progressive streaming, this setting has no effect.

**DB2BaseDataSource.NO (2)**

Disable progressive streaming.

#### **setDBStatementConcentrator**

Format:

```
public void setDBStatementConcentrator(int statementConcentratorUse)
    throws java.sql.SQLException
```

Specifies whether the IBM Data Server Driver for JDBC and SQLJ uses the data source's statement concentrator functionality. The statement concentrator is the ability to bypass preparation of a statement when it is the same as a statement in the dynamic statement cache, except for literal values. Statement concentrator functionality applies only to SQL statements that have literals but no parameter markers. `setDBStatementConcentrator` overrides the setting of the `statementConcentrator` Connection or DataSource property. `setDBStatementConcentrator` affects only statements that are created after `setDBStatementConcentrator` is executed.

Parameter descriptions:

*statementConcentratorUse*

One of the following integer values:

**DB2BaseDataSource.STATEMENT\_CONCENTRATOR\_OFF (1)**

The IBM Data Server Driver for JDBC and SQLJ does not use the data source's statement concentrator functionality.

**DB2BaseDataSource.STATEMENT\_CONCENTRATOR\_WITH\_LITERALS (2)**

The IBM Data Server Driver for JDBC and SQLJ uses the data source's statement concentrator functionality.

**DB2BaseDataSource.STATEMENT\_CONCENTRATOR\_NOT\_SET (0)**

Enables the data server's default behavior for statement concentrator functionality. This is the default value.

For DB2 Database for Linux, UNIX, and Windows data sources that support statement concentrator functionality, the functionality is used if the `STMT_CONC` configuration parameter is set to `ON` at the data source. Otherwise, statement concentrator functionality is not used.

For DB2 for z/OS data sources that support statement concentrator functionality, the functionality is not used if `statementConcentrator` is not set.

**removeDB2JavaStoredProcedure**

Format:

```
public void DB2Connection.removeDB2JavaStoredProcedure(  
    String jarId)  
    throws java.sql.SQLException
```

Invokes the `sqlj.remove_jar` stored procedure on a DB2 Database for Linux, UNIX, and Windows server to delete the definition of a JAR file from the catalog for that server.

Parameter descriptions:

*jarId*

The name of the JAR in the database, in the form *schema.JAR-id* or *JAR-id*. This is the name that you use when you refer to the JAR in SQL statements. If you omit *schema*, the database system uses the SQL authorization ID that is in the `CURRENT SCHEMA` special register.

This method does not apply to connections to IBM Informix data sources.

**replaceDB2JavaStoredProcedure**

Format:



```
public void DB2Connection.replaceDB2JavaStoredProcedure(
    java.io.InputStream jarFile,
    int jarFileLength,
    String jarId)
    throws java.sql.SQLException
```

Invokes the `sqlj.replace_jar` stored procedure on a DB2 Database for Linux, UNIX, and Windows server to replace the definition of a JAR file in the catalog for that server.

Parameter descriptions:

*jarFile*

The contents of the JAR file that is to be replaced on the server.

*jarFileLength*

The length of the JAR file that is to be replace on the server.

*jarId*

The name of the JAR in the database, in the form *schema.JAR-id* or *JAR-id*. This is the name that you use when you refer to the JAR in SQL statements. If you omit *schema*, the database system uses the SQL authorization ID that is in the CURRENT SCHEMA special register. The owner of the JAR is the authorization ID in the CURRENT SQLID special register.

This method does not apply to connections to IBM Informix data sources.

#### **reuseDB2Connection (trusted connection reuse)**

Formats:

```
public void reuseDB2Connection(byte[] cookie,
    String user,
    String password,
    String usernameRegistry,
    byte[] userSecToken,
    String originalUser,
    java.util.Properties properties)
    throws java.sql.SQLException
public void reuseDB2Connection(byte[] cookie,
    org.ietf.GSSCredential gssCredential,
    String usernameRegistry,
    byte[] userSecToken,
    String originalUser,
    java.util.Properties properties)
    throws java.sql.SQLException
```

Trusted connections are supported for:

- IBM Data Server Driver for JDBC and SQLJ type 4 connectivity to:
  - DB2 Database for Linux, UNIX, and Windows Version 9.5 or later
  - DB2 for z/OS Version 9.1 or later
  - IBM Informix Version 11.70 or later
- IBM Data Server Driver for JDBC and SQLJ type 2 connectivity on DB2 for z/OS Version 9.1 or later

The second of these forms of `reuseDB2Connection` does not apply to IBM Data Server Driver for JDBC and SQLJ type 2 connectivity on DB2 for z/OS.

These forms of `reuseDB2Connection` are used by a trusted application server to reuse a preexisting trusted connection on behalf of a new user. Properties that can be reset are passed, including the new user ID. The database server resets



the associated physical connection. If `reuseDB2Connection` executes successfully, the connection becomes available for immediate use, with different properties, by the new user.

Parameter descriptions:

*cookie*

A unique cookie that the JDBC driver generates for the `Connection` instance. The cookie is known only to the application server and the underlying JDBC driver that established the initial trusted connection. The application server passes the cookie that was created by the driver when the pooled connection instance was created. The JDBC driver checks that the supplied cookie matches the cookie of the underlying trusted physical connection to ensure that the request originated from the application server that established the trusted physical connection. If the cookies match, the connection becomes available for immediate use, with different properties, by the new user .

*user*

The client ID that the database system uses to establish the database authorization ID. If the user was not authenticated by the application server, the application server needs to pass a client ID that represents an unauthenticated user.

*password*

The password for *user*.

*gssCredential*

If the data source uses Kerberos security, specifies a delegated credential that is passed from another principal.

*userNameRegistry*

A name that identifies a mapping service that maps a workstation user ID to a z/OS RACF ID. An example of a mapping service is the Integrated Security Services Enterprise Identity Mapping (EIM). The mapping service is defined by a plugin. Valid values for *userNameRegistry* are defined by the plugin providers. If *userNameRegistry* is null, no mapping of *user* is done.

*userSecToken*

The client's security tokens. This value is traced as part of DB2 for z/OS accounting data. The content of *userSecToken* is described by the application server and is referred to by the database system as an application server security token.

*originalUser*

The original user ID that was used by the application server.

*properties*

Properties for the reused connection.

#### **reuseDB2Connection (untrusted reuse with reauthentication)**

Formats:

```
public void reuseDB2Connection(String user,
    String password,
    java.util.Properties properties)
    throws java.sql.SQLException
public void reuseDB2Connection(
    org.ietf.jgss.GSSCredential gssCredential,
    java.util.Properties properties)
    throws java.sql.SQLException
```

The first of these forms of `reuseDB2Connection` is not supported for IBM Data Server Driver for JDBC and SQLJ type 2 connectivity on DB2 for z/OS.

The second of these forms of `reuseDB2Connection` does not apply to IBM Data Server Driver for JDBC and SQLJ type 2 connectivity on DB2 for z/OS.

In a heterogeneous pooling environment, these forms of `reuseDB2Connection` reuse an existing Connection instance after reauthentication.

Parameter description:

*user*

The authorization ID that is used to establish the connection.

*password*

The password for the authorization ID that is used to establish the connection.

*gssCredential*

If the data source uses Kerberos security, specifies a delegated credential that is passed from another principal.

*properties*

Properties for the reused connection. These properties override any properties that are already defined on the `DB2Connection` instance.

#### **`reuseDB2Connection (untrusted or trusted reuse without reauthentication)`**

Formats:

```
public void reuseDB2Connection(java.util.Properties properties)
    throws java.sql.SQLException
```

Reuses an existing Connection instance without reauthentication. This method is intended for reuse of a Connection instance when the properties do not change.

Trusted connections are supported for:

- IBM Data Server Driver for JDBC and SQLJ type 4 connectivity to:
  - DB2 Database for Linux, UNIX, and Windows Version 9.5 or later
  - DB2 for z/OS Version 9.1 or later
  - IBM Informix Version 11.70 or later
- IBM Data Server Driver for JDBC and SQLJ type 2 connectivity on DB2 for z/OS Version 9.1 or later

This method is for *dirty reuse* of a connection. This means that the connection state is not reset when the object is reused from the pool. Special register settings and property settings remain in effect unless they are overridden by passed properties. Global temporary tables are not deleted. Properties that are not specified are not re-initialized. All JDBC standard transient properties, such as the isolation level, autocommit mode, and read-only mode are reset to their JDBC defaults. Certain properties, such as `user`, `password`, `databaseName`, `serverName`, `portNumber`, `planName`, and `pkList` remain unchanged.

Parameter description:

*properties*

Properties for the reused connection. These properties override any properties that are already defined on the `DB2Connection` instance.

#### **`setDB2ClientAccountingInformation`**

Format:

```
public void setDB2ClientAccountingInformation(String info)
    throws java.sql.SQLException
```

Specifies accounting information for the connection. This information is for client accounting purposes. This value can change during a connection.

Parameter description:

*info*

User-specified accounting information. The maximum length depends on the server. For a DB2 Database for Linux, UNIX, and Windows server, the maximum length is 255 bytes. For a DB2 for z/OS server, the maximum length is 22 bytes. A Java empty string ("") or a Java null value is valid for this parameter.

**Important:** `setDB2ClientAccountingInformation` is deprecated in the JDBC 4.0 implementation of the IBM Data Server Driver for JDBC and SQLJ. Use `java.sql.Connection.setClientInfo` instead.

### **setDB2ClientApplicationInformation**

Format:

```
public String setDB2ClientApplicationInformation(String info)
    throws java.sql.SQLException
```

Specifies application information for the current client.

**Important:** `setDB2ClientApplicationInformation` is deprecated in the JDBC 4.0 implementation of the IBM Data Server Driver for JDBC and SQLJ. Use `java.sql.Connection.setClientInfo` instead.

Parameter description:

*info*

User-specified application information. The maximum length depends on the server. For a DB2 Database for Linux, UNIX, and Windows server, the maximum length is 255 bytes. For a DB2 for z/OS server, the maximum length is 32 bytes. A Java empty string ("") or a Java null value is valid for this parameter.

### **setDB2ClientDebugInfo**

Formats:

```
public void setDB2ClientDebugInfo(String debugInfo)
    throws java.sql.SQLException
public void setDB2ClientDebugInfo(String mgrInfo,
    String traceInfo)
    throws java.sql.SQLException
```

Sets a value for the CLIENT DEBUGINFO connection attribute, to notify the database system that stored procedures and user-defined functions that are using the connection are running in debug mode. CLIENT DEBUGINFO is used by the DB2 Unified Debugger. Use the first form to set the entire CLIENT DEBUGINFO string. Use the second form to modify only the session manager and trace information in the CLIENT DEBUGINFO string.

Setting the CLIENT DEBUGINFO attribute to a string of length greater than zero requires one of the following privileges:

- The DEBUGSESSION privilege
- SYSADM authority

Parameter description:

### *debugInfo*

A string of up to 254 bytes, in the following form:

*Mip:port,Iip,Ppid,Ttid,Cid,Llvl*

The parts of the string are:

**Mip:port**

Session manager IP address and port number

**Iip** Client IP address

**Ppid** Client process ID

**Ttid** Client thread ID (optional)

**Cid** Data connection generated ID

**Llvl** Debug library diagnostic trace level

For example:

M9.72.133.89:8355,I9.72.133.89,P4552,T123,C1,L0

See the description of SET CLIENT DEBUGINFO for a detailed description of this string.

### *mgrInfo*

A string of the following form, which specifies the IP address and port number for the Unified Debugger session manager.

*Mip:port*

For example:

M9.72.133.89:8355

See the description of SET CLIENT DEBUGINFO for a detailed description of this string.

### *trcInfo*

A string of the following form, which specifies the debug library diagnostics trace level.

*Llvl*

For example:

L0

See the description of SET CLIENT DEBUGINFO for a detailed description of this string.

## **setDB2ClientProgramId**

Format:

```
public abstract void setDB2ClientProgramId(String program-ID)
    throws java.sql.SQLException
```

Sets a user-defined program identifier for the connection, on DB2 for z/OS servers. That program identifier is an 80-byte string that is used to identify the caller.

setDB2ClientProgramId does not apply to DB2 Database for Linux, UNIX, and Windows or IBM Informix data servers.

The DB2 for z/OS server places the string in IFCID 316 trace records along with other statistics, so that you can identify which program is associated with a particular SQL statement.

#### **setDB2ClientUser**

Format:

```
public void setDB2ClientUser(String user)
    throws java.sql.SQLException
```

Specifies the current client user name for the connection. This name is for client accounting purposes, and is not the user value for the JDBC connection. Unlike the user for the JDBC connection, the current client user name can change during a connection.

Parameter description:

*user*

The user ID for the current client. The maximum length depends on the server. For a DB2 Database for Linux, UNIX, and Windows server, the maximum length is 255 bytes. For a DB2 for z/OS server, the maximum length is 16 bytes. A Java empty string ("") or a Java null value is valid for this parameter.

**Important:** setDB2ClientUser is deprecated in the JDBC 4.0 implementation of the IBM Data Server Driver for JDBC and SQLJ. Use `java.sql.Connection.setClientInfo` instead.

#### **setDB2ClientWorkstation**

Format:

```
public void setDB2ClientWorkstation(String name)
    throws java.sql.SQLException
```

Specifies the current client workstation name for the connection. This name is for client accounting purposes. The current client workstation name can change during a connection.

Parameter description:

*name*

The workstation name for the current client. The maximum length depends on the server. For a DB2 Database for Linux, UNIX, and Windows server, the maximum length is 255 bytes. For a DB2 for z/OS server, the maximum length is 18 bytes. A Java empty string ("") or a Java null value is valid for this parameter.

**Important:** getDB2ClientWorkstation is deprecated in the JDBC 4.0 implementation of the IBM Data Server Driver for JDBC and SQLJ. Use `java.sql.Connection.getClientInfo` instead.

#### **setDB2CurrentPackagePath**

Format:

```
public void setDB2CurrentPackagePath(String packagePath)
    throws java.sql.SQLException
```

Specifies a list of collection IDs that the database system searches for JDBC and SQLJ packages.

The setDB2CurrentPackagePath method applies only to connections to DB2 database systems.

Parameter description:

*packagePath*

A comma-separated list of collection IDs.

#### **setDB2CurrentPackageSet**

Format:

```
public void setDB2CurrentPackageSet(String packageSet)
    throws java.sql.SQLException
```

Specifies the collection ID for the connection. When you set this value, you also set the collection ID of the IBM Data Server Driver for JDBC and SQLJ instance that is used for the connection.

The `setDB2CurrentPackageSet` method applies only to connections to DB2 database systems.

Parameter description:

*packageSet*

The collection ID for the connection. The maximum length for the *packageSet* value is 18 bytes. You can invoke this method as an alternative to executing the SQL SET CURRENT PACKAGESET statement in your program.

#### **setDB2ProgressiveStreaming**

Format:

```
public void setDB2ProgressiveStreaming(int newSetting)
    throws java.sql.SQLException
```

Sets the progressive streaming setting for all ResultSet objects that are created on the connection.

Parameter descriptions:

*newSetting*

The new progressive streaming setting. Possible values are:

##### **DB2BaseDataSource.YES (1)**

Enable progressive streaming. If the data source does not support progressive streaming, this setting has no effect.

##### **DB2BaseDataSource.NO (2)**

Disable progressive streaming.

#### **setJccLogWriter**

Formats:

```
public void setJccLogWriter(PrintWriter logWriter)
    throws java.sql.SQLException

public void setJccLogWriter(PrintWriter logWriter, int traceLevel)
    throws java.sql.SQLException
```

Enables or disables the IBM Data Server Driver for JDBC and SQLJ trace, or changes the trace destination during an active connection.

Parameter descriptions:

*logWriter*

An object of type `java.io.PrintWriter` to which the IBM Data Server Driver for JDBC and SQLJ writes trace output. To turn off the trace, set the value of *logWriter* to `null`.

*traceLevel*

Specifies the types of traces to collect. See the description of the *traceLevel* property in "Properties for the IBM Data Server Driver for JDBC and SQLJ" for valid values.

### **setSavePointUniqueOption**

Format:

```
public void setSavePointUniqueOption(boolean flag)
    throws java.sql.SQLException
```

Specifies whether an application can reuse a savepoint name within a unit of recovery. Possible values are:

**true** A `Connection.setSavepoint(savepoint-name)` method cannot specify the same value for *savepoint-name* more than once within the same unit of recovery.

**false** A `Connection.setSavepoint(savepoint-name)` method can specify the same value for *savepoint-name* more than once within the same unit of recovery.

When `false` is specified, if the `Connection.setSavepoint(savepoint-name)` method is executed, and a savepoint with the name *savepoint-name* already exists within the unit of recovery, the database manager destroys the existing savepoint, and creates a new savepoint with the name *savepoint-name*.

Reuse of a savepoint is not the same as executing `Connection.releaseSavepoint(savepoint-name)`.

`Connection.releaseSavepoint(savepoint-name)` releases *savepoint-name*, and any savepoints that were subsequently set.

### **updateDB2XmlSchema**

Format:

```
public void updateDB2XmlSchema(String[] targetSqlIdSchema,
    String[] targetSqlIdName,
    String[] sourceSqlIdSchema,
    String[] sourceSqlIdName,
    String[] xmlSchemaLocations,
    boolean dropSourceSchema)
    throws SQLException
```

Updates the contents of an XML schema with the contents of another XML schema in the XML schema repository, and optionally drops the source schema. The schema documents in the target XML schema are replaced with the schema documents from the source XML schema. Before `updateDB2XmlSchema` can be called, registration of the source and target XML schemas must be completed.

The SQL ALTERIN privilege is required for updating the target XML schema. The SQL DROPIN privilege is required for dropping the source XML schema.

Parameter descriptions:

*targetSqlIdSchema*

The SQL schema name for a registered XML schema that is to be updated. *targetSqlIdSchema* is a String value with a maximum length of 128 bytes.

*targetSqlIdName*

The name of the registered XML schema that is to be updated. *targetSqlIdName* is a String value with a maximum length of 128 bytes.

#### *sourceSqlIdSchema*

The SQL schema name for a registered XML schema that is used to update the target XML schema. *sourceSqlIdSchema* is a String value with a maximum length of 128 bytes.

#### *sourceSqlIdName*

The name of the registered XML schema that is used to update the target XML schema. *sourceSqlIdName* is a String value with a maximum length of 128 bytes.

#### *dropSourceSchema*

Indicates whether the source XML schema is to be dropped after the target XML schema is updated. *dropSourceSchema* is a boolean value. `false` is the default.

This method does not apply to connections to IBM Informix data sources.

## DB2ConnectionPoolDataSource class

DB2ConnectionPoolDataSource is a factory for PooledConnection objects. An object that implements this interface is registered with a naming service that is based on the Java Naming and Directory Interface (JNDI).

The `com.ibm.db2.jcc.DB2ConnectionPoolDataSource` class extends the `com.ibm.db2.jcc.DB2BaseDataSource` class, and implements the `javax.sql.ConnectionPoolDataSource`, `java.io.Serializable`, and `javax.naming.Referenceable` interfaces.

### DB2ConnectionPoolDataSource properties

These properties are defined only for the IBM Data Server Driver for JDBC and SQLJ. "Properties for the IBM Data Server Driver for JDBC and SQLJ" for explanations of these properties.

These properties have a `setXXX` method to set the value of the property and a `getXXX` method to retrieve the value. A `setXXX` method has this form:

```
void setProperty-name(data-type property-value)
```

A `getXXX` method has this form:

```
data-type getProperty-name()
```

*Property-name* is the unqualified property name, with the first character capitalized.

The following table lists the IBM Data Server Driver for JDBC and SQLJ properties and their data types.

Table 114. DB2ConnectionPoolDataSource properties and their data types

Property name	Data type
<code>com.ibm.db2.jcc.DB2ConnectionPoolDataSource.maxStatements</code>	<code>int</code>

### DB2ConnectionPoolDataSource methods

#### **getDB2PooledConnection**

Formats:

```
public DB2PooledConnection getDB2PooledConnection(String user,  
String password,  
java.util.Properties properties)
```



```

throws java.sql.SQLException
public DB2PooledConnection getDB2PooledConnection(
    org.ietf.jgss.GSSCredential gssCredential,
    java.util.Properties properties)
throws java.sql.SQLException

```

Establishes the initial untrusted connection in a heterogeneous pooling environment.

The first form of `getDB2PooledConnection` provides a user ID and password. The second form of `getDB2PooledConnection` is for connections that use Kerberos security.

Parameter descriptions:

**user**

The authorization ID that is used to establish the connection.

**password**

The password for the authorization ID that is used to establish the connection.

**gssCredential**

If the data source uses Kerberos security, specifies a delegated credential that is passed from another principal.

**properties**

Properties for the connection.

**getDB2TrustedPooledConnection**

Formats:

```

public Object[] getDB2TrustedPooledConnection(String user,
    String password,
    java.util.Properties properties)
throws java.sql.SQLException
public Object[] getDB2TrustedPooledConnection(
    java.util.Properties properties)
throws java.sql.SQLException
public Object[] getDB2TrustedPooledConnection(
    org.ietf.jgss.GSSCredential gssCredential,
    java.util.Properties properties)
throws java.sql.SQLException

```

An application server using a system authorization ID uses this method to establish a trusted connection.

Trusted connections are supported for:

- IBM Data Server Driver for JDBC and SQLJ type 4 connectivity to:
  - DB2 Database for Linux, UNIX, and Windows Version 9.5 or later
  - DB2 for z/OS Version 9.1 or later
  - IBM Informix Version 11.70 or later
- IBM Data Server Driver for JDBC and SQLJ type 2 connectivity on DB2 for z/OS Version 9.1 or later

The following elements are returned in `Object[]`:

- The first element is a trusted `DB2PooledConnection` instance.
- The second element is a unique cookie for the generated pooled connection instance.

The first form of `getDB2TrustedPooledConnection` provides a user ID and password, while the second form of `getDB2TrustedPooledConnection` uses the

user ID and password of the DB2ConnectionPoolDataSource object. The third form of getDB2TrustedPooledConnection is for connections that use Kerberos security.

Parameter descriptions:

**user**

The DB2 authorization ID that is used to establish the trusted connection to the database server.

**password**

The password for the authorization ID that is used to establish the trusted connection.

**gssCredential**

If the data source uses Kerberos security, specifies a delegated credential that is passed from another principal.

**properties**

Properties for the connection.

## DB2DatabaseMetaData interface

The com.ibm.db2.jcc.DB2DatabaseMetaData interface extends the java.sql.DatabaseMetaData interface.

### DB2DatabaseMetaData methods

The following methods are defined only for the IBM Data Server Driver for JDBC and SQLJ.

**getDBFunctionColumns**

Format:

```
public java.sql.ResultSet getDBFunctionColumns(  
    String catalog,  
    String schemaPattern,  
    String modulePattern,  
    String functionNamePattern,  
    String columnNamePattern)  
throws java.sql.SQLException
```

Returns a ResultSet object that describes parameters and return values for user-defined functions or built-in functions that are defined at a data source. The function parameters and return values for which information is returned match the catalog name, schema pattern, module pattern, function name pattern, and column name pattern that are specified by the input parameters. The ResultSet has the following columns:

Column number	Column name	Data type	Description
1	FUNCTION_CAT	String	Name of the catalog. The value is null if this function does not have catalogs.
2	FUNCTION_SCHEM	String	Name of the schema containing FUNCTION_NAME. This value can be null.
3	FUNCTION_NAME	String	Name of the function.
4	COLUMN_NAME	String	Name of the function parameter.

Column number	Column name	Data type	Description
5	COLUMN_TYPE	Short	Parameter type: <ul style="list-style-type: none"> <li>• functionColumnUnknown (0): unknown</li> <li>• functionColumnIn (1): input</li> <li>• functionColumnInOut (2): input or output</li> <li>• functionColumnResult (3): result set column</li> <li>• functionColumnOut (4): output</li> <li>• functionColumnReturn (5): returned value</li> </ul>
6	DATA_TYPE	int	SQL data type of the parameter that is identified by COLUMN_NAME.
7	TYPE_NAME	String	Character string representing the name of the data type corresponding to DATA_TYPE.
8	PRECISION	int	The precision of an exact numeric parameter.
9	LENGTH	int	The length of the parameter,
10	SCALE	short	The scale of an exact numeric parameter.
11	RADIX	short	10, 2, or null: <ul style="list-style-type: none"> <li>• If DATA_TYPE is an approximate numeric data type, this parameter contains the value 2.</li> <li>• If DATA_TYPE is an exact numeric data type, this parameter contains the value 10.</li> <li>• For data types where the radix is not applicable, this value is null.</li> </ul>
12	NULLABLE	short	Specifies whether the parameter can contain NULL values: <p><b>functionNoNulls (0)</b> The parameter cannot contains NULL values.</p> <p><b>functionNullable (1)</b> The parameter can contains NULL values.</p> <p><b>functionNullableUnknown (2)</b> The nullability of the parameter is unknown.</p>
13	REMARKS	String	Descriptive information about the parameter, or null.
14	CHAR_OCTET_LENGTH	int	For character data types, the maximum number of bytes in the parameter. For the XML type, zero is returned. For all other data types, this value is null.
15	ORDINAL_POSITION	int	The position of the parameter, starting at 1. This value is 0 if COLUMN_TYPE is 5 (return value).
16	IS_NULLABLE	String	Contains the string 'NO' if the parameter is known to be not nullable, 'YES' if the parameter is nullable, or an empty string if the nullability is unknown.
17	SPECIFIC_NAME	String	The name that uniquely identifies the function within its schema.
18	FUNCTION_MODULE	String	The name of the module that contains the function. This value can be null.

Parameter descriptions:

**catalog**

An empty string or '%'.

**schemaName**

Specifies the schema name (qualifier) of the objects for which information is to be returned.

The value can identify a single schema name, or it can identify more than one schema name by including the pattern-matching character percent (%).

#### **modulePattern**

Specifies the name of the module for which parameter information is to be returned.

The value can identify a single module name, or it can identify more than one module name by including the pattern-matching character percent (%).

#### **functionNamePattern**

Specifies the name of the function for which parameter information is to be returned.

The value can identify a single schema name, or it can identify more than one procedure name by including the pattern-matching character percent (%).

#### **columnNamePattern**

Specifies the parameters for which parameter information is to be returned.

The value can identify a single schema name, or it can identify more than one parameter name by including the pattern-matching character percent (%).

This method applies to connections to DB2 Database for Linux, UNIX, and Windows 9.7 or later data sources only. A `SqlFeatureNotSupportedException` is thrown if the data source is any other data source.

#### **getDBFunctions**

Format:

```
public java.sql.ResultSet getDBFunctions(  
    String catalog,  
    String schemaPattern,  
    String modulePattern,  
    String functionNamePattern)  
throws java.sql.SQLException
```

Returns a `ResultSet` object that describes user-defined functions or built-in functions that are defined at a data source. The functions for which information is returned match the catalog name, schema pattern, module pattern, and function name pattern that are specified by the input parameters. The `ResultSet` has the following columns:

Column number	Column name	Data type	Description
1	FUNCTION_CAT	String	Name of the catalog. The value is null if this function does not have catalogs.
2	FUNCTION_SCHEM	String	Name of the schema containing FUNCTION_NAME. This value can be null.
3	FUNCTION_NAME	String	Name of the function.
4	REMARKS	String	Descriptive information about the parameter, or null.
5	FUNCTION_TYPE	short	Function type. Possible values are: <ul style="list-style-type: none"><li>• <code>functionResultUnknown</code> (0): Whether a value or a table is returned is unknown.</li><li>• <code>functionNoTable</code> (1): A table is not returned.</li><li>• <code>functionReturnsTable</code> (2): A table is returned.</li></ul>

Column number	Column name	Data type	Description
6	SPECIFIC_NAME	String	The name that uniquely identifies the function within its schema.
7	FUNCTION_MODULE	String	The name of the module that contains the function. This value can be null.

Parameter descriptions:

**catalog**

An empty string or '%'.

**schemaName**

Specifies the schema name (qualifier) of the objects for which information is to be returned.

The value can identify a single schema name, or it can identify more than one schema name by including the pattern-matching character percent (%).

**modulePattern**

Specifies the name of the module for which parameter information is to be returned.

The value can identify a single module name, or it can identify more than one module name by including the pattern-matching character percent (%).

**functionNamePattern**

Specifies the name of the function for which parameter information is to be returned.

The value can identify a single schema name, or it can identify more than one function name by including the pattern-matching character percent (%).

This method applies to connections to DB2 Database for Linux, UNIX, and Windows 9.7 or later data sources only. A `SqlFeatureNotSupportedException` is thrown if the data source is any other data source.

**getDBProcedureColumns**

Format:

```
public java.sql.ResultSet getDBProcedureColumns(
    String catalog,
    String schemaPattern,
    String modulePattern,
    String procedureNamePattern,
    String columnNamePattern)
    throws java.sql.SQLException
```

Returns a `ResultSet` object that describes parameters and return values for stored procedures that are defined at a data source. The stored procedure parameters and return values for which information is returned match the catalog name, schema pattern, module pattern, procedure name pattern, and column name pattern that are specified by the input parameters. The `ResultSet` has the following columns:

Column number	Column name	Data type	Description
1	PROCEDURE_CAT	String	Name of the catalog. The value is null if this procedure does not have catalogs.

Column number	Column name	Data type	Description
2	PROCEDURE_SCHEM	String	Name of the schema containing PROCEDURE_NAME. This value can be null.
3	PROCEDURE_NAME	String	Name of the procedure.
4	COLUMN_NAME	String	Name of the procedure parameter.
5	COLUMN_TYPE	Short	Parameter type: <ul style="list-style-type: none"> <li>• procedureColumnUnknown (0): unknown</li> <li>• procedureColumnIn (1): input</li> <li>• procedureColumnInOut (2): input or output</li> <li>• procedureColumnResult (3): result set column</li> <li>• procedureColumnOut (4): output</li> <li>• procedureColumnReturn (5): returned value</li> </ul>
6	DATA_TYPE	int	SQL data type of the parameter that is identified by COLUMN_NAME.
7	TYPE_NAME	String	Character string representing the name of the data type corresponding to DATA_TYPE.
8	PRECISION	int	The precision of an exact numeric parameter.
9	LENGTH	int	The length of the parameter,
10	SCALE	short	The scale of an exact numeric parameter.
11	RADIX	short	10, 2, or null: <ul style="list-style-type: none"> <li>• If DATA_TYPE is an approximate numeric data type, this parameter contains the value 2.</li> <li>• If DATA_TYPE is an exact numeric data type, this parameter contains the value 10.</li> <li>• For data types where the radix is not applicable, this value is null.</li> </ul>
12	NULLABLE	short	Specifies whether the parameter can contain NULL values: <p><b>procedureNoNulls (0)</b> The parameter cannot contains NULL values.</p> <p><b>procedureNullable (1)</b> The parameter can contains NULL values.</p> <p><b>procedureNullableUnknown (2)</b> The nullability of the parameter is unknown.</p>
13	REMARKS	String	Descriptive information about the parameter, or null.
14	COLUMN_DEF	String	Default value for the parameter.
15	SQL_DATA_TYPE	int	The value of the SQL data type as it appears in the SQL_DESC_TYPE field of the descriptor.
16	SQL_DATETIME_SUB	int	The subtype code for datetime data types.
17	CHAR_OCTET_LENGTH	int	For character data types, the maximum number of bytes in the parameter. For the XML type, zero is returned. For all other data types, this value is null.
18	ORDINAL_POSITION	int	The position of the parameter, starting at 1. This value is 0 if COLUMN_TYPE is 5 (return value).
19	IS_NULLABLE	String	Contains the string 'NO' if the parameter is known to be not nullable, 'YES' if the parameter is nullable, or an empty string if the nullability is unknown.
20	SPECIFIC_NAME	String	The name that uniquely identifies the procedure within its schema.

Column number	Column name	Data type	Description
21	PROCEDURE_MODULE	String	The name of the module that contains the procedure. This value can be null.

Parameter descriptions:

**catalog**

An empty string or '%'.

**schemaName**

Specifies the schema name (qualifier) of the objects for which information is to be returned.

The value can identify a single schema name, or it can identify more than one schema name by including the pattern-matching character percent (%).

**modulePattern**

Specifies the name of the module for which parameter information is to be returned.

The value can identify a single module name, or it can identify more than one module name by including the pattern-matching character percent (%).

**procedureNamePattern**

Specifies the name of the procedure for which parameter information is to be returned.

The value can identify a single schema name, or it can identify more than one procedure name by including the pattern-matching character percent (%).

**columnNamePattern**

Specifies the parameters for which parameter information is to be returned.

The value can identify a single schema name, or it can identify more than one parameter name by including the pattern-matching character percent (%).

This method applies to connections to DB2 Database for Linux, UNIX, and Windows 9.7 or later data sources only. A `SqlFeatureNotSupportedException` is thrown if the data source is any other data source.

**getDBProcedures**

Format:

```
public java.sql.ResultSet getDBProcedures(
    String catalog,
    String schemaPattern,
    String modulePattern,
    String procedureNamePattern)
    throws java.sql.SQLException
```

Returns a `ResultSet` object that describes stored procedures that are defined at a data source. The stored procedures for which information is returned match the catalog name, schema pattern, module pattern, and procedure name pattern that are specified by the input parameters. The `ResultSet` has the following columns:

Column number	Column name	Data type	Description
1	PROCEDURE_CAT	String	Name of the catalog. The value is null if this procedure does not have catalogs.
2	PROCEDURE_SCHEM	String	Name of the schema containing PROCEDURE_NAME. This value can be null.
3	PROCEDURE_NAME	String	Name of the procedure.
4			Reserved.
5			Reserved.
6			Reserved.
7	REMARKS	String	Descriptive information about the parameter, or null.
8	PROCEDURE_TYPE	short	Procedure type. Possible values are: <ul style="list-style-type: none"> <li>• procedureResultUnknown (0): Whether a value is returned is unknown.</li> <li>• procedureNoResult (1): No value is returned.</li> <li>• procedureReturnsResult (2): A value is returned.</li> </ul>
9	SPECIFIC_NAME	String	The name that uniquely identifies the procedure within its schema.
10	PROCEDURE_MODULE	String	The name of the module that contains the procedure. This value can be null.

Parameter descriptions:

**catalog**

An empty string or '%'.

**schemaName**

Specifies the schema name (qualifier) of the objects for which information is to be returned.

The value can identify a single schema name, or it can identify more than one schema name by including the pattern-matching character percent (%).

**modulePattern**

Specifies the name of the module for which parameter information is to be returned.

The value can identify a single module name, or it can identify more than one module name by including the pattern-matching character percent (%).

**procedureNamePattern**

Specifies the name of the procedure for which parameter information is to be returned.

The value can identify a single schema name, or it can identify more than one procedure name by including the pattern-matching characters percent (%).

This method applies to connections to DB2 Database for Linux, UNIX, and Windows 9.7 or later data sources only. A `SqlFeatureNotSupportedException` is thrown if the data source is any other data source.

**getDBUDTs**

Format:

```
public java.sql.ResultSet getDBUDTs(
    String catalog,
    String schemaPattern,
```



```
String modulePattern,
String typeNamePattern,
int[] types)
throws java.sql.SQLException
```

Returns a `ResultSet` object that describes user-defined types that are defined at a data source. The user-defined types for which information is returned match the catalog name, schema pattern, module pattern, type name pattern and types that are specified by the input parameters. The `ResultSet` has the following columns:

Column number	Column name	Data type	Description
1	TYPE_CAT	String	Name of the catalog. The value is null if this user-defined type does not have catalogs.
2	TYPE_SCHEM	String	Name of the schema containing TYPE_NAME. This value can be null.
3	TYPE_NAME	String	Name of the user-defined type.
4	CLASS_NAME	String	The Java class name of the user-defined type.
5	DATA_TYPE	int	One of the following type values that is defined in <code>java.sql.Types</code> : <ul style="list-style-type: none"> <li>• <code>JAVA_OBJECT</code> (2000)</li> <li>• <code>DISTINCT</code> (2001)</li> <li>• <code>STRUCT</code> (2002)</li> </ul>
6	REMARKS	String	Descriptive information about the user-defined type, or null.
7	BASE_TYPE	short	If <code>DATA_TYPE</code> is <code>DISTINCT</code> , or <code>DATA_TYPE</code> is <code>STRUCT</code> and <code>REFERENCE_GENERATION</code> is <code>USER_DEFINED</code> , the type code from <code>java.sql.Types</code> of the data type on which the user-defined type is based. Otherwise, this value is null.
8	TYPE_MODULE	String	The name of the module that contains the user-defined type. This value can be null.

Parameter descriptions:

**catalog**

An empty string or '%'.

**schemaName**

Specifies the schema name (qualifier) of the objects for which information is to be returned.

The value can identify a single schema name, or it can identify more than one schema name by including the pattern-matching character percent (%).

**modulePattern**

Specifies the name of the module for which parameter information is to be returned.

The value can identify a single module name, or it can identify more than one module name by including the pattern-matching character percent (%).

**typeNamePattern**

Specifies the name of the user-defined type for which parameter information is to be returned.

The value can identify a single type name, or it can identify more than one procedure name by including the pattern-matching character percent (%).

### **types**

Specifies the types of user-defined types for which parameter information is to be returned. Each array entry can contain one of the following values:

- JAVA\_OBJECT (2000)
- DISTINCT (2001)
- STRUCT (2002)

If the array is null, information about all types is returned.

This method applies to connections to DB2 Database for Linux, UNIX, and Windows 9.7 or later data sources only. A `SqlFeatureNotSupportedException` is thrown if the data source is any other data source.

### **isIDSDatabaseAnsiCompliant**

Format:

```
public boolean isIDSDatabaseAnsiCompliant();
```

Returns true if the current active IBM Informix database is ANSI-compliant. Returns false otherwise.

An ANSI-compliant database is a database that was created with the WITH LOG MODE ANSI option.

This method applies to connections to IBM Informix data sources only. An `SQLException` is thrown if the data source is not an IBM Informix data source.

### **isIDSDatabaseLogging**

Format:

```
public boolean isIDSDatabaseLogging();
```

Returns true if the current active IBM Informix database supports logging. Returns false otherwise.

An IBM Informix database that supports logging is a database that was created with the WITH LOG MODE ANSI option, the WITH BUFFERED LOG, or the WITH LOG option.

This method applies to connections to IBM Informix data sources only. An `SQLException` is thrown if the data source is not an IBM Informix data source.

### **isResetRequiredForDB2eWLM**

Format:

```
public boolean isResetRequiredForDB2eWLM();
```

Returns true if the target database server requires clean reuse to support eWLM. Returns false otherwise.

### **supportsDB2ProgressiveStreaming**

Format:

```
public boolean supportsDB2ProgressiveStreaming();
```

Returns true if the target data source supports progressive streaming. Returns false otherwise.

## **DB2Diagnosable interface**

The `com.ibm.db2.jcc.DB2Diagnosable` interface provides a mechanism for getting DB2 diagnostics from an `SQLException`.

## DB2Diagnosable methods

The following methods are defined only for the IBM Data Server Driver for JDBC and SQLJ.

### getSqlca

Format:

```
public DB2Sqlca getSqlca();
```

Returns a DB2Sqlca object from a java.sql.Exception that is produced under a IBM Data Server Driver for JDBC and SQLJ.

### getThrowable

Format:

```
public Throwable getThrowable();
```

Returns a java.lang.Throwable object from a java.sql.Exception that is produced under a IBM Data Server Driver for JDBC and SQLJ.

### printTrace

Format:

```
static public void printTrace(java.io.PrintWriter printWriter,  
String header);
```

Prints diagnostic information after a java.sql.Exception is thrown under a IBM Data Server Driver for JDBC and SQLJ.

Parameter descriptions:

#### printWriter

The destination for the diagnostic information.

#### header

User-defined information that is printed at the beginning of the output.

## DB2Driver class

The com.ibm.db2.jcc.DB2Driver class extends the java.sql.Driver interface.

## DB2Driver methods

The following methods are defined only for the IBM Data Server Driver for JDBC and SQLJ.

### changeDB2Password

Format:

```
public static void changeDB2Password (String url,  
String userid,  
String oldPassword,  
String newPassword)  
throws java.sql.SQLException
```

Changes the password for accessing a data server that is specified by the url parameter, for the user that is specified by the userid parameter. This method can change an unexpired or expired password.

changeDB2Password is supported for IBM Data Server Driver for JDBC and SQLJ type 4 connectivity only.

changeDB2Password is not supported for connections to IBM Informix.

Parameter descriptions:

*url*

The URL for the data server for which a user's password is being changed. *url* has IBM Data Server Driver for JDBC and SQLJ type 4 connectivity URL syntax.

*userid*

The user whose password is being changed.

*oldPassword*

The original password for the user.

*newPassword*

The new password for the user.

## DB2ExceptionFormatter class

The `com.ibm.db2.jcc.DB2ExceptionFormatter` class contains methods for printing diagnostic information to a stream.

### DB2ExceptionFormatter methods

The following methods are defined only for the IBM Data Server Driver for JDBC and SQLJ.

#### **printTrace**

Formats:

```
static public void printTrace(java.sql.SQLException sqlException,  
    java.io.PrintWriter printWriter, String header)
```

```
static public void printTrace(DB2Sqlca sqlca,  
    java.io.PrintWriter printWriter, String header)
```

```
static public void printTrace(java.lang.Throwable throwable,  
    java.io.PrintWriter printWriter, String header)
```

Prints diagnostic information after an exception is thrown.

Parameter descriptions:

#### **sqlException|sqlca|throwable**

The exception that was thrown during a previous JDBC or Java operation.

#### **printWriter**

The destination for the diagnostic information.

#### **header**

User-defined information that is printed at the beginning of the output.

## DB2FileReference class

The `com.ibm.db2.jcc.DB2FileReference` class is an abstract class that defines methods that support insertion of data into tables from file reference variables. This class applies only to IBM Data Server Driver for JDBC and SQLJ type 2 connectivity to DB2 for z/OS Version 9 or later.

### DB2FileReference fields

The following constants define types codes only for the IBM Data Server Driver for JDBC and SQLJ.

```
public static final short MAX_FILE_NAME_LENGTH = 255
```

The maximum length of the file name for a file reference variable.

## DB2FileReference methods

The following methods are defined only for the IBM Data Server Driver for JDBC and SQLJ.

### **getDriverType**

Format:

```
public int getDriverType()
```

Returns the server data type of the file reference variable. This type is one of the values in `com.ibm.db2.jcc.DB2Types`.

### **getFileEncoding**

Format:

```
public String getFileEncoding()
```

Returns the encoding of the data in the file for a `DB2FileReference` object.

### **getFileName**

Format:

```
public String getFileName()
```

Returns the file name for a `DB2FileReference` object.

### **getFileCcsid**

Format:

```
public int getFileCcsid()
```

Returns the CCSID of the data in the file for a `DB2FileReference` object.

### **setFileName**

Format:

```
public String setFileName(String fileName)  
    throws java.sql.SQLException
```

Sets the file name in a `DB2FileReference` object.

Parameter descriptions:

#### **fileName**

The name of the input file for the file reference variable. The name must specify an existing HFS file.

## DB2JCCPlugin class

The `com.ibm.db2.jcc.DB2JCCPlugin` class is an abstract class that defines methods that can be implemented to provide DB2 Database for Linux, UNIX, and Windows plug-in support. This class applies only to DB2 Database for Linux, UNIX, and Windows.

## DB2JCCPlugin methods

The following methods are defined only for the IBM Data Server Driver for JDBC and SQLJ.

### **getTicket**

Format:

```
public abstract byte[] getTicket(String user,
    String password,
    byte[] returnedToken)
    throws org.ietf.jgss.GSSEException
```

Retrieves a Kerberos ticket for a user.

Parameter descriptions:

**user**

The user ID for which the Kerberos ticket is to be retrieved.

**password**

The password for *user*.

**returnedToken**

## DB2ParameterMetaData interface

The `com.ibm.db2.jcc.DB2ParameterMetaData` interface extends the `java.sql.ParameterMetaData` interface.

### DB2ParameterMetaData methods

The following methods are defined only for the IBM Data Server Driver for JDBC and SQLJ.

#### **getParameterMarkerNames**

Format:

```
public String[] getParameterMarkerNames()
    throws java.sql.SQLException
```

Returns a list of the parameter marker names that are used in an SQL statement.

This method returns null if the `enableNamedParameterMarkers` property is set `DB2BaseDataSource.NOT_SET` or `DB2BaseDataSource.NO`, or if there are no named parameter markers in the SQL statement.

#### **getProcedureParameterName**

Format:

```
public String getProcedureParameterName(int param)
    throws java.sql.SQLException
```

Returns the name in the CREATE PROCEDURE statement of a parameter in an SQL CALL statement. If the parameter has no name in the CREATE PROCEDURE statement, the ordinal position of the parameter in the CREATE PROCEDURE statement is returned.

Parameter descriptions:

**param**

The ordinal position of the parameter in the CALL statement.

This method applies to connections to DB2 Database for Linux, UNIX, and Windows 9.7 or later data servers only.

## DB2PooledConnection class

The `com.ibm.db2.jcc.DB2PooledConnection` class provides methods that an application server can use to switch users on a preexisting trusted connection.

Trusted connections are supported for:

- IBM Data Server Driver for JDBC and SQLJ type 4 connectivity to:
  - DB2 Database for Linux, UNIX, and Windows Version 9.5 or later
  - DB2 for z/OS Version 9.1 or later
  - IBM Informix Version 11.70 or later
- IBM Data Server Driver for JDBC and SQLJ type 2 connectivity on DB2 for z/OS Version 9.1 or later

## DB2PooledConnection methods

The following methods are defined only for the IBM Data Server Driver for JDBC and SQLJ.

### getConnection (untrusted or trusted reuse without reauthentication)

Format:

```
public DB2Connection getConnection()
    throws java.sql.SQLException
```

This method is for *dirty reuse* of a connection. This means that the connection state is not reset when the object is reused from the pool. Special register settings and property settings remain in effect unless they are overridden by passed properties. Global temporary tables are not deleted. Properties that are not specified are not re-initialized. All JDBC standard transient properties, such as the isolation level, autocommit mode, and read-only mode are reset to their JDBC defaults. Certain properties, such as user, password, databaseName, serverName, portNumber, planName, and pkList remain unchanged.

### getDB2Connection (trusted reuse)

Formats:

```
public DB2Connection getDB2Connection(byte[] cookie,
    String user,
    String password,
    String userRegistry,
    byte[] userSecToken,
    String originalUser,
    java.util.Properties properties)
    throws java.sql.SQLException
public Connection getDB2Connection(byte[] cookie,
    org.ietf.GSSCredential gssCredential,
    String usernameRegistry,
    byte[] userSecToken,
    String originalUser,
    java.util.Properties properties)
    throws java.sql.SQLException
```

Switches the user that is associated with a trusted connection without authentication.

The second form of getDB2Connection is supported only for IBM Data Server Driver for JDBC and SQLJ type 4 connectivity.

Parameter descriptions:

#### cookie

A unique cookie that the JDBC driver generates for the Connection instance. The cookie is known only to the application server and the underlying JDBC driver that established the initial trusted connection. The application server passes the cookie that was created by the driver when the pooled connection instance was created. The JDBC driver checks that the supplied cookie matches the cookie of the underlying trusted physical connection to ensure that the request originated from the application server

that established the trusted physical connection. If the cookies match, the connection can become available, with different properties, for immediate use by a new user .

**user**

The client identity that is used by the data source to establish the authorization ID for the database server. If the user was not authenticated by the application server, the application server must pass a user identity that represents an unauthenticated user.

**password**

The password for *user*.

**gssCredential**

If the data source uses Kerberos security, specifies a delegated credential that is passed from another principal.

**userNameRegistry**

A name that identifies a mapping service that maps a workstation user ID to a z/OS RACF ID. An example of a mapping service is the Integrated Security Services Enterprise Identity Mapping (EIM). The mapping service is defined by a plugin. Valid values for *userNameRegistry* are defined by the plugin providers. If *userNameRegistry* is null, the connection does not use a mapping service.

**userSecToken**

The client's security tokens. This value is traced as part of DB2 for z/OS accounting data. The content of *userSecToken* is described by the application server and is referred to by the data source as an application server security token.

**originalUser**

The client identity that sends the original request to the application server. *originalUser* is included in DB2 for z/OS accounting data as the original user ID that was used by the application server.

**properties**

Properties for the reused connection. These properties override any properties that are already defined on the *DB2PooledConnection* instance.

**getDB2Connection (untrusted reuse with reauthentication)**

Formats:

```
public DB2Connection getDB2Connection(  
    String user,  
    String password,  
    java.util.Properties properties)  
    throws java.sql.SQLException  
public DB2Connection getDB2Connection(org.ietf.jgss.GSSCredential gssCredential,  
    java.util.Properties properties)  
    throws java.sql.SQLException
```

Switches the user that is associated with a untrusted connection, with authentication.

The first form *getDB2Connection* provides a user ID and password. The second form of *getDB2Connection* is for connections that use Kerberos security.

Parameter descriptions:

**user**

The user ID that is used by the data source to establish the authorization ID for the database server.



**password**

The password for *user*.

**properties**

Properties for the reused connection. These properties override any properties that are already defined on the DB2PooledConnection instance.

**getDB2Connection (untrusted or trusted reuse without reauthentication)**

Formats:

```
public java.sql.Connection getDB2Connection(
    java.util.Properties properties)
    throws java.sql.SQLException
```

Reuses an untrusted connection, without reauthentication.

This method is for *dirty reuse* of a connection. This means that the connection state is not reset when the object is reused from the pool. Special register settings and property settings remain in effect unless they are overridden by passed properties. Global temporary tables are not deleted. Properties that are not specified are not re-initialized. All JDBC standard transient properties, such as the isolation level, autocommit mode, and read-only mode are reset to their JDBC defaults. Certain properties, such as user, password, databaseName, serverName, portNumber, planName, and pkList remain unchanged.

Parameter descriptions:

**properties**

Properties for the reused connection. These properties override any properties that are already defined on the DB2PooledConnection instance.

## DB2PoolMonitor class

The com.ibm.db2.jcc.DB2PoolMonitor class provides methods for monitoring the global transport objects pool that is used for the connection concentrator and Sysplex workload balancing.

### DB2PoolMonitor fields

The following fields are defined only for the IBM Data Server Driver for JDBC and SQLJ.

```
public static final int TRANSPORT_OBJECT = 1
```

This value is a parameter for the DB2PoolMonitor.getPoolMonitor method.

### DB2PoolMonitor methods

The following methods are defined only for the IBM Data Server Driver for JDBC and SQLJ.

**agedOutObjectCount**

Format:

```
public abstract int agedOutObjectCount()
```

Retrieves the number of objects that exceeded the idle time that was specified by db2.jcc.maxTransportObjectIdleTime and were deleted from the pool.

**createdObjectCount**

Format:

```
public abstract int createdObjectCount()
```

Retrieves the number of objects that the IBM Data Server Driver for JDBC and SQLJ created since the pool was created.

#### **getMonitorVersion**

Format:

```
public int getMonitorVersion()
```

Retrieves the version of the DB2PoolMonitor class that is shipped with the IBM Data Server Driver for JDBC and SQLJ.

#### **getPoolMonitor**

Format:

```
public static DB2PoolMonitor getPoolMonitor(int monitorType)
```

Retrieves an instance of the DB2PoolMonitor class.

Parameter descriptions:

##### **monitorType**

The monitor type. This value must be DB2PoolMonitor.TRANSPORT\_OBJECT.

#### **heavyWeightReusedObjectCount**

Format:

```
public abstract int heavyWeightReusedObjectCount()
```

Retrieves the number of objects that were reused from the pool.

#### **lightWeightReusedObjectCount**

Format:

```
public abstract int lightWeightReusedObjectCount()
```

Retrieves the number of objects that were reused but were not in the pool. This can happen if a Connection object releases a transport object at a transaction boundary. If the Connection object needs a transport object later, and the original transport object has not been used by any other Connection object, the Connection object can use that transport object.

#### **longestBlockedRequestTime**

Format:

```
public abstract long longestBlockedRequestTime()
```

Retrieves the longest amount of time that a request was blocked, in milliseconds.

#### **numberOfConnectionReleaseRefused**

Format:

```
public abstract int numberOfConnectionReleaseRefused()
```

Retrieves the number of times that the release of a connection was refused.

#### **numberOfRequestsBlocked**

Format:

```
public abstract int numberOfRequestsBlocked()
```

Retrieves the number of requests that the IBM Data Server Driver for JDBC and SQLJ made to the pool that the pool blocked because the pool reached its

maximum capacity. A blocked request might be successful if an object is returned to the pool before the `db2.jcc.maxTransportObjectWaitTime` is exceeded and an exception is thrown.

#### **numberOfRequestsBlockedDataSourceMax**

Format:

```
public abstract int numberOfRequestsBlockedDataSourceMax()
```

Retrieves the number of requests that the IBM Data Server Driver for JDBC and SQLJ made to the pool that the pool blocked because the pool reached the maximum for the `DataSource` object.

#### **numberOfRequestsBlockedPoolMax**

Format:

```
public abstract int numberOfRequestsBlockedPoolMax()
```

Retrieves the number of requests that the IBM Data Server Driver for JDBC and SQLJ made to the pool that the pool blocked because the maximum number for the pool was reached.

#### **removedObjectCount**

Format:

```
public abstract int removedObjectCount()
```

Retrieves the number of objects that have been deleted from the pool since the pool was created.

#### **shortestBlockedRequestTime**

Format:

```
public abstract long shortestBlockedRequestTime()
```

Retrieves the shortest amount of time that a request was blocked, in milliseconds.

#### **successfulRequestsFromPool**

Format:

```
public abstract int successfulRequestsFromPool()
```

Retrieves the number of successful requests that the IBM Data Server Driver for JDBC and SQLJ has made to the pool since the pool was created. A successful request means that the pool returned an object.

#### **totalPoolObjects**

Format:

```
public abstract int totalPoolObjects()
```

Retrieves the number of objects that are currently in the pool.

#### **totalRequestsToPool**

Format:

```
public abstract int totalRequestsToPool()
```

Retrieves the total number of requests that the IBM Data Server Driver for JDBC and SQLJ has made to the pool since the pool was created.

#### **totalTimeBlocked**

Format:

```
public abstract long totalTimeBlocked()
```

Retrieves the total time in milliseconds for requests that were blocked by the pool. This time can be much larger than the elapsed execution time of the application if the application uses multiple threads.

## DB2PreparedStatement interface

The `com.ibm.db2.jcc.DB2PreparedStatement` interface extends the `com.ibm.db2.jcc.DB2Statement` and `java.sql.PreparedStatement` interfaces.

### DB2PreparedStatement fields

The following constants are defined only for the IBM Data Server Driver for JDBC and SQLJ.

#### **public static DBIndicatorDefault DB\_PARAMETER\_DEFAULT**

This constant can be used with standard interfaces, such as `PreparedStatement.setObject` or `ResultSet.updateObject` to indicate that the default value is assigned to the associated parameter.

#### **public static DBIndicatorUnassigned DB\_PARAMETER\_UNASSIGNED**

This constant can be used with standard interfaces, such as `PreparedStatement.setObject` or `ResultSet.updateObject` to indicate that the associated parameter is unaassigned.

### DB2PreparedStatement methods

The following methods are defined only for the IBM Data Server Driver for JDBC and SQLJ.

#### **executeDB2QueryBatch**

Format:

```
public void executeDB2QueryBatch()
    throws java.sql.SQLException
```

Executes a statement batch that contains queries with parameters.

This method is not supported for connections to IBM Informix data sources.

#### **getDBGeneratedKeys**

Format:

```
public java.sql.ResultSet[] getDBGeneratedKeys()
    throws java.sql.SQLException
```

Retrieves automatically generated keys that were created when INSERT statements were executed in a batch. Each `ResultSet` object that is returned contains the automatically generated keys for a single statement in the batch.

`getDBGeneratedKeys` returns an array of length 0 under the following conditions:

- `getDBGeneratedKeys` is called out of sequence. For example, if `getDBGeneratedKeys` is called before `executeBatch`, an array of length 0 is returned.
- The `PreparedStatement` that is executed in a batch was not created using one of the following methods:

```
Connection.prepareStatement(String sql, int[] autoGeneratedKeys)
Connection.prepareStatement(String sql, String[] autoGeneratedColumnNames)
Connection.prepareStatement(String sql, Statement.RETURN_GENERATED_KEYS)
```

If `getDBGeneratedKeys` is called against a `PreparedStatement` that was created using one of the previously listed methods, and the `PreparedStatement` is not in a batch, a single `ResultSet` is returned.

#### **getEstimateCost**

Format:

```
public int getEstimateCost()  
    throws java.sql.SQLException
```

Returns the estimated cost of an SQL statement from the data server after the data server dynamically prepares the statement successfully. This value is the same as the fourth element in the `sqlerrd` array of the `SQLCA`.

If the `deferPrepares` property is set to `true`, calling `getEstimateCost` causes the data server to execute a dynamic prepare operation.

If the SQL statement cannot be prepared, or the data server does not return estimated cost information at prepare time, `getEstimateCost` returns -1.

#### **getEstimateRowCount**

Format:

```
public int getEstimateRowCount()  
    throws java.sql.SQLException
```

Returns the estimated row count for an SQL statement from the data server after the data server dynamically prepares the statement successfully. This value is the same as the third element in the `sqlerrd` array of the `SQLCA`.

If the `deferPrepares` property is set to `true`, calling `getEstimateRowCount` causes the data server to execute a dynamic prepare operation.

If the SQL statement cannot be prepared, or the data server does not return estimated row count information at prepare time, `getEstimateRowCount` returns -1.

#### **setDBTimestamp**

Format:

```
public void setDBTimestamp(int parameterIndex,  
    DBTimestamp timestamp)  
    throws java.sql.SQLException
```

Assigns a `DBTimestamp` value to a parameter.

Parameters:

*parameterIndex*

The index of the parameter marker to which a `DBTimestamp` variable value is assigned.

*timestamp*

The `DBTimestamp` value that is assigned to the parameter marker.

This method is not supported for connections to IBM Informix data sources.

#### **setJccArrayAtName**

Format:

```
public void setJccArrayAtName(String parameterMarkerName,  
    java.sql.Array x)  
    throws java.sql.SQLException
```

Assigns a `java.sql.Array` value to a named parameter marker.

This method can be called only if the `enableNamedParameterMarkers` property is set to `DB2BaseDataSource.YES` (1).

Parameters:

*parameterMarkerName*

The name of the parameter marker to which a value is assigned.

*x* The `java.sql.Array` value that is assigned to the named parameter marker.

#### **setJccAsciiStreamAtName**

Formats:

Supported by the IBM Data Server Driver for JDBC and SQLJ version 3.57 and later:

```
public void setJccAsciiStreamAtName(String parameterMarkerName,  
    java.io.InputStream x, int length)  
    throws java.sql.SQLException
```

Supported by the IBM Data Server Driver for JDBC and SQLJ version 4.7 and later:

```
public void setJccAsciiStreamAtName(String parameterMarkerName,  
    java.io.InputStream x)  
    throws java.sql.SQLException  
public void setJccAsciiStreamAtName(String parameterMarkerName,  
    java.io.InputStream x, long length)  
    throws java.sql.SQLException
```

Assigns an ASCII value in a `java.io.InputStream` to a named parameter marker.

This method can be called only if the `enableNamedParameterMarkers` property is set to `DB2BaseDataSource.YES` (1).

Parameters:

*parameterMarkerName*

The name of the parameter marker to which a value is assigned.

*x* The ASCII `java.io.InputStream` value that is assigned to the parameter marker.

*length*

The length in bytes of the `java.io.InputStream` value that is assigned to the named parameter marker.

#### **setJccBigDecimalAtName**

Format:

```
public void setJccBigDecimalAtName(String parameterMarkerName,  
    java.math.BigDecimal x)  
    throws java.sql.SQLException
```

Assigns a `java.math.BigDecimal` value to a named parameter marker.

This method can be called only if the `enableNamedParameterMarkers` property is set to `DB2BaseDataSource.YES` (1).

Parameters:

*parameterMarkerName*

The name of the parameter marker to which a value is assigned.

*x* The `java.math.BigDecimal` value that is assigned to the named parameter marker.

### **setJccBinaryStreamAtName**

Formats:

Supported by the IBM Data Server Driver for JDBC and SQLJ version 3.57 and later:

```
public void setJccBinaryStreamAtName(String parameterMarkerName,  
    java.io.InputStream x, int length)  
    throws java.sql.SQLException
```

Supported by the IBM Data Server Driver for JDBC and SQLJ version 4.7 and later:

```
public void setJccBinaryStreamAtName(String parameterMarkerName,  
    java.io.InputStream x)  
    throws java.sql.SQLException  
public void setJccBinaryStreamAtName(String parameterMarkerName,  
    java.io.InputStream x, long length)  
    throws java.sql.SQLException
```

Assigns a binary value in a `java.io.InputStream` to a named parameter marker.

This method can be called only if the `enableNamedParameterMarkers` property is set to `DB2BaseDataSource.YES (1)`.

Parameters:

*parameterMarkerName*

The name of the parameter marker to which a value is assigned.

*x* The binary `java.io.InputStream` value that is assigned to the parameter marker.

*length*

The number of bytes of the `java.io.InputStream` value that are assigned to the named parameter marker.

### **setJccBlobAtName**

Formats:

Supported by the IBM Data Server Driver for JDBC and SQLJ version 3.57 and later:

```
public void setJccBlobAtName(String parameterMarkerName,  
    java.sql.Blob x)  
    throws java.sql.SQLException
```

Supported by the IBM Data Server Driver for JDBC and SQLJ version 4.7 and later:

```
public void setJccBlobAtName(String parameterMarkerName,  
    java.io.InputStream x)  
    throws java.sql.SQLException  
public void setJccBlobAtName(String parameterMarkerName,  
    java.io.InputStream x, long length)  
    throws java.sql.SQLException
```

Assigns a BLOB value to a named parameter marker.

This method can be called only if the `enableNamedParameterMarkers` property is set to `DB2BaseDataSource.YES (1)`.

Parameters:

*parameterMarkerName*

The name of the parameter marker to which a value is assigned.

*x* The `java.sql.Blob` value or `java.io.InputStream` value that is assigned to the parameter marker.

*length*

The number of bytes of the `java.io.InputStream` value that are assigned to the named parameter marker.

#### **setJccBooleanAtName**

Format:

```
public void setJccBooleanAtName(String parameterMarkerName,
    boolean x)
    throws java.sql.SQLException
```

Assigns a boolean value to a named parameter marker.

This method can be called only if the `enableNamedParameterMarkers` property is set to `DB2BaseDataSource.YES (1)`.

Parameters:

*parameterMarkerName*

The name of the parameter marker to which a value is assigned.

*x* The boolean value that is assigned to the named parameter marker.

#### **setJccByteAtName**

Format:

```
public void setJccByteAtName(String parameterMarkerName,
    byte x)
    throws java.sql.SQLException
```

Assigns a byte value to a named parameter marker.

This method can be called only if the `enableNamedParameterMarkers` property is set to `DB2BaseDataSource.YES (1)`.

Parameters:

*parameterMarkerName*

The name of the parameter marker to which a value is assigned.

*x* The byte value that is assigned to the named parameter marker.

#### **setJccBytesAtName**

Format:

```
public void setJccBytesAtName(String parameterMarkerName,
    byte[] x)
    throws java.sql.SQLException
```

Assigns an array of byte values to a named parameter marker.

This method can be called only if the `enableNamedParameterMarkers` property is set to `DB2BaseDataSource.YES (1)`.

Parameters:

*parameterMarkerName*

The name of the parameter marker to which a value is assigned.

*x* The byte array that is assigned to the named parameter marker.

#### **setJccCharacterStreamAtName**

Formats:



Supported by the IBM Data Server Driver for JDBC and SQLJ version 3.57 and later:

```
public void setJccCharacterStreamAtName(String parameterMarkerName,  
    java.io.Reader x, int length)  
    throws java.sql.SQLException
```

Supported by the IBM Data Server Driver for JDBC and SQLJ version 4.7 and later:

```
public void setJccCharacterStreamAtName(String parameterMarkerName,  
    java.io.Reader x)  
    throws java.sql.SQLException  
public void setJccCharacterStreamAtName(String parameterMarkerName,  
    java.io.Reader x, long length)  
    throws java.sql.SQLException
```

Assigns a Unicode value in a `java.io.Reader` to a named parameter marker.

This method can be called only if the `enableNamedParameterMarkers` property is set to `DB2BaseDataSource.YES (1)`.

Parameters:

*parameterMarkerName*

The name of the parameter marker to which a value is assigned.

*x* The Unicode `java.io.Reader` value that is assigned to the named parameter marker.

*length*

The number of characters of the `java.io.InputStream` value that are assigned to the named parameter marker.

### **setJccClobAtName**

Formats:

Supported by the IBM Data Server Driver for JDBC and SQLJ version 3.57 and later:

```
public void setJccClobAtName(String parameterMarkerName,  
    java.sql.Clob x)  
    throws java.sql.SQLException
```

Supported by the IBM Data Server Driver for JDBC and SQLJ version 4.7 and later:

```
public void setJccClobAtName(String parameterMarkerName,  
    java.io.Reader x)  
    throws java.sql.SQLException  
public void setJccClobAtName(String parameterMarkerName,  
    java.io.Reader x, long length)  
    throws java.sql.SQLException
```

Assigns a CLOB value to a named parameter marker.

This method can be called only if the `enableNamedParameterMarkers` property is set to `DB2BaseDataSource.YES (1)`.

Parameters:

*parameterMarkerName*

The name of the parameter marker to which a value is assigned.

*x* The `java.sql.Clob` value or `java.io.Reader` value that is assigned to the named parameter marker.

*length*

The number of bytes of the `java.io.InputStream` value that are assigned to the named parameter marker.

#### **setJccDateAtName**

Formats:

```
public void setJccDateAtName(String parameterMarkerName,
    java.sql.Date x)
    throws java.sql.SQLException
public void setJccDateAtName(String parameterMarkerName,
    java.sql.Date x,
    java.util.Calendar cal)
    throws java.sql.SQLException
```

Assigns a `java.sql.Date` value to a named parameter marker.

This method can be called only if the `enableNamedParameterMarkers` property is set to `DB2BaseDataSource.YES (1)`.

Parameters:

*parameterMarkerName*

The name of the parameter marker to which a value is assigned.

*x* The `java.sql.Date` value that is assigned to the named parameter marker.

*cal*

The `java.util.Calendar` object that the IBM Data Server Driver for JDBC and SQLJ uses to construct the date.

#### **setJccDBTimestampAtName**

Format:

```
public void setJccDBTimestampAtName(String parameterMarkerName,
    DBTimestamp timestamp)
    throws java.sql.SQLException
```

Assigns a `DBTimestamp` value to a named parameter marker.

This method can be called only if the `enableNamedParameterMarkers` property is set to `DB2BaseDataSource.YES (1)`.

Parameters:

*parameterMarkerName*

The name of the parameter marker to which a `DBTimestamp` variable value is assigned.

*timestamp*

The `DBTimestamp` value that is assigned to the named parameter marker.

This method is not supported for connections to IBM Informix data sources.

#### **setJccDBDefaultAtName**

Formats:

```
public void setJccDBDefaultAtName(String parameterMarkerName)
    throws SQLException
```

Assigns the default value to a named parameter marker. Execution of `setJccDBDefaultAtName` produces the same results as using the literal `DEFAULT` in the SQL string, instead of the parameter marker name.

Parameters:

*parameterMarkerName*

The name of the parameter marker to which a value is assigned.

This method is not supported for connections to IBM Informix data sources.

This method can be called only if the `enableNamedParameterMarkers` property is set to `DB2BaseDataSource.YES` (1).

#### **setJccDBUnassignedAtName**

Formats:

```
public void setJccDBUnassignedAtName(String parameterMarkerName)
    throws SQLException
```

Does not assign a value to the specified named parameter. Execution of `setJccDBUnassignedAtName` produces the same result as if the specified parameter marker name had not appeared in the SQL string.

Parameters:

*parameterMarkerName*

The name of the parameter marker whose value is to be unassigned.

This method is not supported for connections to IBM Informix data sources.

This method can be called only if the `enableNamedParameterMarkers` property is set to `DB2BaseDataSource.YES` (1).

#### **setJccDoubleAtName**

Format:

```
public void setJccDoubleAtName(String parameterMarkerName,
    double x)
    throws java.sql.SQLException
```

Assigns a value of type `double` to a named parameter marker.

This method can be called only if the `enableNamedParameterMarkers` property is set to `DB2BaseDataSource.YES` (1).

Parameters:

*parameterMarkerName*

The name of the parameter marker to which a value is assigned.

*x* The value of type `double` that is assigned to the parameter marker.

#### **setJccFloatAtName**

Format:

```
public void setJccFloatAtName(String parameterMarkerName,
    float x)
    throws java.sql.SQLException
```

Assigns a value of type `float` to a named parameter marker.

This method can be called only if the `enableNamedParameterMarkers` property is set to `DB2BaseDataSource.YES` (1).

Parameters:

*parameterMarkerName*

The name of the parameter marker to which a value is assigned.

*x* The value of type `float` that is assigned to the parameter marker.

#### **setJccIntAtName**

Format:

```
public void setJccIntAtName(String parameterMarkerName,  
    int x)  
    throws java.sql.SQLException
```

Assigns a value of type int to a named parameter marker.

This method can be called only if the enableNamedParameterMarkers property is set to DB2BaseDataSource.YES (1).

Parameters:

*parameterMarkerName*

The name of the parameter marker to which a value is assigned.

*x* The value of type int that is assigned to the parameter marker.

#### **setJccLongAtName**

Format:

```
public void setJccLongAtName(String parameterMarkerName,  
    long x)  
    throws java.sql.SQLException
```

Assigns a value of type long to a named parameter marker.

This method can be called only if the enableNamedParameterMarkers property is set to DB2BaseDataSource.YES (1).

Parameters:

*parameterMarkerName*

The name of the parameter marker to which a value is assigned.

*x* The value of type long that is assigned to the parameter marker.

#### **setJccNullAtName**

Format:

```
public void setJccNullAtName(String parameterMarkerName,  
    int jdbcType)  
    throws java.sql.SQLException  
public void setJccNullAtName(String parameterMarkerName,  
    int jdbcType,  
    String typeName)  
    throws java.sql.SQLException
```

Assigns the SQL NULL value to a named parameter marker.

This method can be called only if the enableNamedParameterMarkers property is set to DB2BaseDataSource.YES (1).

Parameters:

*parameterMarkerName*

The name of the parameter marker to which a value is assigned.

*jdbcType*

The JDBC type code of the NULL value that is assigned to the parameter marker, as defined in java.sql.Types.

*typeName*

If *jdbcType* is java.sql.Types.DISTINCT or java.sql.Types.REF, the fully-qualified name of the SQL user-defined type of the NULL value that is assigned to the parameter marker.

#### **setJccObjectAtName**

Formats:

```

public void setJccObjectAtName(String parameterMarkerName,
    java.sql.Object x)
    throws java.sql.SQLException
public void setJccObjectAtName(String parameterMarkerName,
    java.sql.Object x,
    int targetJdbcType)
    throws java.sql.SQLException
public void setJccObjectAtName(String parameterMarkerName,
    java.sql.Object x,
    int targetJdbcType,
    int scale)
    throws java.sql.SQLException

```

Assigns a value with type `java.lang.Object` to a named parameter marker.

This method can be called only if the `enableNamedParameterMarkers` property is set to `DB2BaseDataSource.YES (1)`.

Parameters:

*parameterMarkerName*

The name of the parameter marker to which a value is assigned.

*x* The value with type `Object` that is assigned to the parameter marker.

*targetJdbcType*

The data type, as defined in `java.sql.Types`, that is assigned to the input value when it is sent to the data source.

*scale*

The scale of the value that is assigned to the parameter marker. This parameter applies only to these cases:

- If *targetJdbcType* is `java.sql.Types.DECIMAL` or `java.sql.Types.NUMERIC`, *scale* is the number of digits to the right of the decimal point.
- If *x* has type `java.io.InputStream` or `java.io.Reader`, *scale* is the length of the data in the `Stream` or `Reader` object.

### **setJccShortAtName**

Format:

```

public void setJccShortAtName(String parameterMarkerName,
    short x)
    throws java.sql.SQLException

```

Assigns a value of type `short` to a named parameter marker.

This method can be called only if the `enableNamedParameterMarkers` property is set to `DB2BaseDataSource.YES (1)`.

Parameters:

*parameterMarkerName*

The name of the parameter marker to which a value is assigned.

*x* The value of type `short` that is assigned to the parameter marker.

### **setJccSQLXMLAtName**

Format:

```

public void setJccSQLXMLAtName(String parameterMarkerName,
    java.sql.SQLXML x)
    throws java.sql.SQLException

```

Assigns a value of type `java.sql.SQLXML` to a named parameter marker.

This method can be called only if the `enableNamedParameterMarkers` property is set to `DB2BaseDataSource.YES` (1).

This method is supported only for connections to DB2 Database for Linux, UNIX, and Windows Version 9.1 or later or DB2 for z/OS Version 9 or later.

Parameters:

*parameterMarkerName*

The name of the parameter marker to which a value is assigned.

*x* The value of type `java.sql.SQLXML` that is assigned to the parameter marker.

### **setJccStringAtName**

Format:

```
public void setJccStringAtName(String parameterMarkerName,  
                               String x)  
    throws java.sql.SQLException
```

Assigns a value of type `String` to a named parameter marker.

This method can be called only if the `enableNamedParameterMarkers` property is set to `DB2BaseDataSource.YES` (1).

Parameters:

*parameterMarkerName*

The name of the parameter marker to which a value is assigned.

*x* The value of type `String` that is assigned to the parameter marker.

### **setJccTimeAtName**

Formats:

```
public void setJccTimeAtName(String parameterMarkerName,  
                              java.sql.Time x)  
    throws java.sql.SQLException  
public void setJccTimeAtName(String parameterMarkerName,  
                              java.sql.Time x,  
                              java.util.Calendar cal)  
    throws java.sql.SQLException
```

Assigns a `java.sql.Time` value to a named parameter marker.

This method can be called only if the `enableNamedParameterMarkers` property is set to `DB2BaseDataSource.YES` (1).

Parameters:

*parameterMarkerName*

The name of the parameter marker to which a value is assigned.

*x* The `java.sql.Time` value that is assigned to the parameter marker.

*cal*

The `java.util.Calendar` object that the IBM Data Server Driver for JDBC and SQLJ uses to construct the time.

### **setJccTimestampAtName**

Formats:

```
public void setJccTimestampAtName(String parameterMarkerName,  
                                   java.sql.Timestamp x)  
    throws java.sql.SQLException
```

```
public void setJccTimestampAtName(String parameterMarkerName,
    java.sql.Timestamp x,
    java.util.Calendar cal)
    throws java.sql.SQLException
```

Assigns a `java.sql.Timestamp` value to a named parameter marker.

This method can be called only if the `enableNamedParameterMarkers` property is set to `DB2BaseDataSource.YES` (1).

Parameters:

*parameterMarkerName*

The name of the parameter marker to which a value is assigned.

*x* The `java.sql.Timestamp` value that is assigned to the parameter marker.

*cal*

The `java.util.Calendar` object that the IBM Data Server Driver for JDBC and SQLJ uses to construct the timestamp.

### **setJccUnicodeStreamAtName**

Format:

```
public void setJccUnicodeStreamAtName(String parameterMarkerName,
    java.io.InputStream x, int length)
    throws java.sql.SQLException
```

Assigns a Unicode value in a `java.io.InputStream` to a named parameter marker.

This method can be called only if the `enableNamedParameterMarkers` property is set to `DB2BaseDataSource.YES` (1).

Parameters:

*parameterMarkerName*

The name of the parameter marker to which a value is assigned.

*x* The Unicode `java.io.InputStream` value that is assigned to the parameter marker.

*length*

The number of bytes of the `java.io.InputStream` value that are assigned to the parameter marker.

### **setDBDefault**

Formats:

```
public void setDBDefault(int parameterIndex)
    throws SQLException
```

Assigns the default value to the specified parameter. Execution of `setDBDefault` produces the same results as using the literal `DEFAULT` in the SQL string, instead of the parameter.

Parameters:

*parameterIndex*

The number of the parameter whose value is being updated.

This method is not supported for connections to IBM Informix data sources.

### **setDBUnassigned**

Formats:

```
public void setDBUnassigned(int parameterIndex)
    throws SQLException
```

Does not assign a value to the specified parameter. Execution of `setDBUnassigned` produces the same result as if the specified parameter had not appeared in the SQL string.

Parameters:

*parameterIndex*

The number of the parameter whose value is to be unassigned.

This method is not supported for connections to IBM Informix data sources.

## DB2ResultSet interface

The `com.ibm.db2.jcc.DB2ResultSet` interface is used to create objects from which IBM Data Server Driver for JDBC and SQLJ-only query information can be obtained.

`DB2ResultSet` implements the `java.sql.Wrapper` interface.

### DB2ResultSet methods

The following methods are defined only for the IBM Data Server Driver for JDBC and SQLJ.

#### **getDB2RowChangeToken**

Format:

```
public long DB2ResultSet.getDB2RowChangeToken()
    throws java.sql.SQLException
```

Returns the row change token for the current row, if it is available. Returns 0 if optimistic locking columns were not requested or are not available.

This method applies only to connections to DB2 Database for Linux, UNIX, and Windows.

#### **getDB2RID**

Format:

```
public Object DB2ResultSet.getDB2RID()
    throws java.sql.SQLException
```

Returns the RID for the current row, if it is available. The RID is available if optimistic locking columns were requested and are available. Returns null if optimistic locking columns were not requested or are not available.

This method applies only to connections to DB2 Database for Linux, UNIX, and Windows.

#### **getDB2RIDType**

Format:

```
public int DB2ResultSet.getDB2RIDType()
    throws java.sql.SQLException
```

Returns the data type of the RID column in a `DB2ResultSet`. The returned value maps to a `java.sql.Types` constant. If the `DB2ResultSet` does not contain a RID column, `java.sql.Types.NULL` is returned.

This method applies only to connections to DB2 Database for Linux, UNIX, and Windows.

#### **getDBTimestamp**

Formats:



```

public DBTimestamp getDBTimestamp(int parameterIndex)
    throws SQLException
public DBTimestamp getDBTimestamp(String parameterName)
    throws SQLException

```

Returns the value in the current row of a `TIMESTAMP` or `TIMESTAMP WITH TIME ZONE` column that is in a `DB2ResultSet` object as a `DBTimestamp` object. For a `TIMESTAMP` column, the returned value has the local time zone. If the value of the `DB2ResultSet` column is `NULL`, the returned value is null.

Parameters:

*parameterIndex*

The number of the column in the `DB2ResultSet` whose value is being retrieved.

*parameterName*

The name of the column in the `DB2ResultSet` whose value is being retrieved.

### **updateDBDefault**

Formats:

```

public void updateDBDefault(int parameterIndex)
    throws SQLException
public void updateDBDefault(String columnName)
    throws SQLException

```

Assigns the default value to the specified column in a `DB2ResultSet` object. This method does not update the underlying table.

Parameters:

*parameterIndex*

The number of the column in the `DB2ResultSet` whose value is being updated.

*columnName*

The name of the column in the `DB2ResultSet` whose value is being updated.

This method is not supported for connections to IBM Informix data sources.

## **DB2ResultSetMetaData interface**

The `com.ibm.db2.jcc.DB2ResultSetMetaData` interface provides methods that provide information about a `ResultSet` object.

Before a `com.ibm.db2.jcc.DB2ResultSetMetaData` method can be used, a `java.sql.ResultSetMetaData` object that is returned from a `java.sql.ResultSet.getMetaData` call needs to be cast to `com.ibm.db2.jcc.DB2ResultSetMetaData`.

### **DB2ResultSetMetaData methods:**

The following methods are defined only for the IBM Data Server Driver for JDBC and SQLJ.

#### **getDB2OptimisticLockingColumns**

Format:

```

public int getDB2OptimisticLockingColumns()
    throws java.sql.SQLException

```

Returns a value that indicates whether optimistic locking columns are available. Possible values are:

- 0 Optimistic locking columns are not available.
- 1 Optimistic locking columns are available, but the change token might not have the granularity to prevent false negatives.
- 2 Optimistic locking columns are available, and the change token has the granularity to prevent false negatives.

#### **isDB2ColumnNameDerived**

Format:

```
public boolean isDB2ColumnNameDerived (int column)
    throws java.sql.SQLException
```

Returns true if the name of a ResultSet column is in the SQL SELECT list that generated the ResultSet.

For example, suppose that a ResultSet is generated from the SQL statement SELECT EMPNAME, SUM(SALARY) FROM EMP. Column name EMPNAME is derived from the SQL SELECT list, but the name of the column in the ResultSet that corresponds to SUM(SALARY) is not derived from the SELECT list.

Parameter descriptions:

#### **column**

The ordinal position of a column in the ResultSet.

#### **getDBTemporalColumnType**

Format:

```
public int getDBTemporalColumnType (int column)
    throws java.sql.SQLException
```

Returns:

- 1 If *column* is not a ROW BEGIN, ROW END or TRANSACTION START ID column.
- 1 If *column* is a ROW BEGIN column.
- 2 If *column* is a ROW END column.
- 3 If *column* is a TRANSACTION START ID column.

Parameter descriptions:

#### **column**

The ordinal position of a column in the ResultSet.

## **DB2RowID interface**

The com.ibm.db2.jcc.DB2RowID interface is used for declaring Java objects for use with the SQL ROWID data type.

The com.ibm.db2.jcc.DB2RowID interface does not apply to connection to IBM Informix.

### **DB2RowID methods**

The following method is defined only for the IBM Data Server Driver for JDBC and SQLJ.

**getBytes**

Format:

```
public byte[] getBytes()
```

Converts a `com.ibm.jcc.DB2RowID` object to bytes.

## DB2SimpleDataSource class

The `com.ibm.db2.jcc.DB2SimpleDataSource` class extends the `DB2BaseDataSource` class.

A `DB2BaseDataSource` object does not support connection pooling or distributed transactions. It contains all of the properties and methods that the `DB2BaseDataSource` class contains. In addition, `DB2SimpleDataSource` contains the following IBM Data Server Driver for JDBC and SQLJ-only properties.

`DB2SimpleDataSource` implements the `java.sql.Wrapper` interface.

### DB2SimpleDataSource methods

The following method is defined only for the IBM Data Server Driver for JDBC and SQLJ.

**setPassword**

Format:

```
public synchronized void setPassword(String password)
```

Sets the password for the `DB2SimpleDataSource` object. There is no corresponding `getPassword` method. Therefore, the password cannot be encrypted because there is no way to retrieve the password so that you can decrypt it.

## DB2Sqlca class

The `com.ibm.db2.jcc.DB2Sqlca` class is an encapsulation of the SQLCA.

### DB2Sqlca methods

The following methods are defined only for the IBM Data Server Driver for JDBC and SQLJ.

**getMessage**

Format:

```
public abstract String getMessage()
```

Returns error message text.

**getSqlCode**

Format:

```
public abstract int getSqlCode()
```

Returns an SQL error code value.

**getSqlErrd**

Format:

```
public abstract int[] getSqlErrd()
```

Returns an array, each element of which contains an SQLCA SQLERRD.

**getSqlErrmc**

Format:

```
public abstract String getSqlErrmc()
```

Returns a string that contains the SQLCA SQLERRMC values, delimited with spaces.

**getSqlErrmcTokens**

Format:

```
public abstract String[] getSqlErrmcTokens()
```

Returns an array, each element of which contains an SQLCA SQLERRMC token.

**getSqlErrp**

Format:

```
public abstract String getSqlErrp()
```

Returns the SQLCA SQLERRP value.

**getSqlState**

Format:

```
public abstract String getSqlState()
```

Returns the SQLCA SQLSTATE value.

**getSqlWarn**

Format:

```
public abstract char[] getSqlWarn()
```

Returns an array, each element of which contains an SQLCA SQLWARN value.

## DB2Statement interface

The `com.ibm.db2.jcc.DB2Statement` interface extends the `java.sql.Statement` interface.

`DB2Statement` implements the `java.sql.Wrapper` interface.

### DB2Statement fields

The following fields are defined only for the IBM Data Server Driver for JDBC and SQLJ.

```
public static final int RETURN_OPTLOCK_COLUMN_NONE = 0
public static final int RETURN_OPTLOCK_COLUMN_ALWAYS = 1
public static final int RETURN_OPTLOCK_COLUMN_NO_FALSE_NEGATIVES = 2
```

These values are arguments for the `DB2Statement.executeDB2OptimisticLockingQuery` method.

### DB2Statement methods

The following methods are defined only for the IBM Data Server Driver for JDBC and SQLJ.

**executeDB2OptimisticLockingQuery**

Format:

```
public java.sql.ResultSet DB2Statement.executeDB2OptimisticLockingQuery(
    String sql,
    int returnOptLockingColumn)
    throws java.sql.SQLException
```

Executes an SQL query statement, and returns a `ResultSet` that contains optimistic locking information, if it is requested.

Parameter descriptions:

**sql**

An SQL `SELECT` statement that returns a single `ResultSet`.

**returnOptimisticLockingColumns**

Specifies whether optimistic locking columns are returned. Possible values are:

*Table 115. Values for the returnOptimisticLockingColumns parameter*

Value	Description
<code>DB2Statement.RETURN_OPTLOCK_COLUMN_NONE (0)</code>	Do not return optimistic locking columns.
<code>DB2Statement.RETURN_OPTLOCK_COLUMN_ALWAYS (1)</code>	Add row change columns to the result set even if they do not uniquely represent a single row. This setting is equivalent to the database prepare attribute <code>WITH ROW CHANGE COLUMNS POSSIBLY DISTINCT</code> .
<code>DB2Statement.RETURN_OPTLOCK_COLUMN_NO_FALSE_NEGATIVES (2)</code>	Add row change columns to the result set only if they uniquely represent a single row. This setting is equivalent to the database prepare attribute <code>WITH ROW CHANGE COLUMNS ALWAYS DISTINCT</code> .

**getDB2ClientProgramId**

Format:

```
public String getDB2ClientProgramId()
    throws java.sql.SQLException
```

Returns the user-defined client program identifier for the connection, which is stored on the data source.

`getDB2ClientProgramId` does not apply to DB2 Database for Linux, UNIX, and Windows data servers.

**setDB2ClientProgramId**

Format:

```
public abstract void setDB2ClientProgramId(String program-ID)
    throws java.sql.SQLException
```

Sets a user-defined program identifier for the connection on a data server. That program identifier is an 80-byte string that is used to identify the caller.

`setDB2ClientProgramId` does not apply to DB2 Database for Linux, UNIX, and Windows data servers.

The DB2 for z/OS server places the string in IFCID 316 trace records along with other statistics, so that you can identify which program is associated with a particular SQL statement.

**getIDSBigSerial**

Format:

```
public int getIDSBigSerial()
    throws java.sql.SQLException
```

Retrieves an automatically generated key from a BIGSERIAL column after the automatically generated key was inserted by a previously executed INSERT statement.

The following conditions must be true for `getIDSBigSerial` to execute successfully:

- The INSERT statement is the last SQL statement that is executed before this method is called.
- The table into which the row is inserted contains a BIGSERIAL column.
- The form of the JDBC Connection.`prepareStatement` method or `Statement.executeUpdate` method that prepares or executes the INSERT statement does not have parameters that request automatically generated keys.

This method applies only to connections to IBM Informix databases.

#### **getIDSSerial**

Format:

```
public int getIDSSerial()  
    throws java.sql.SQLException
```

Retrieves an automatically generated key from a SERIAL column after the automatically generated key was inserted by a previously executed INSERT statement.

The following conditions must be true for `getIDSSerial` to execute successfully:

- The INSERT statement is the last SQL statement that is executed before this method is called.
- The table into which the row is inserted contains a SERIAL column.
- The form of the JDBC Connection.`prepareStatement` method or `Statement.executeUpdate` method that prepares or executes the INSERT statement does not have parameters that request automatically generated keys.

This method applies only to connections to IBM Informix databases.

#### **getIDSSerial8**

Format:

```
public long getIDSSerial8()  
    throws java.sql.SQLException
```

Retrieves an automatically generated key from a SERIAL8 column after the automatically generated key was inserted by a previously executed INSERT statement.

The following conditions must be true for `getIDSSerial8` to execute successfully:

- The INSERT statement is the last SQL statement that is executed before this method is called.
- The table into which the row is inserted contains a SERIAL8 column.
- The form of the JDBC Connection.`prepareStatement` method or `Statement.executeUpdate` method that prepares or executes the INSERT statement does not have parameters that request automatically generated keys.

This method applies only to connections to IBM Informix data sources.

#### **getIDSSQLStatementOffset**

Format:

```
public int getIDSSQLStatementOffset()
    throws java.sql.SQLException
```

After an SQL statement executes on an IBM Informix data source, if the statement has a syntax error, `getIDSSQLStatementOffset` returns the offset into the statement text of the syntax error.

`getIDSSQLStatementOffset` returns:

- 0, if the statement does not have a syntax error.
- -1, if the data source is not IBM Informix.

This method applies only to connections to IBM Informix data sources.

## DB2SystemMonitor interface

The `com.ibm.db2.jcc.DB2SystemMonitor` interface is used for collecting system monitoring data for a connection. Each connection can have one `DB2SystemMonitor` instance.

### DB2SystemMonitor fields

The following fields are defined only for the IBM Data Server Driver for JDBC and SQLJ.

```
public final static int RESET_TIMES
```

```
public final static int ACCUMULATE_TIMES
```

These values are arguments for the `DB2SystemMonitor.start` method.

`RESET_TIMES` sets time counters to zero before monitoring starts.

`ACCUMULATE_TIMES` does not set time counters to zero.

### DB2SystemMonitor methods

The following methods are defined only for the IBM Data Server Driver for JDBC and SQLJ.

#### **enable**

Format:

```
public void enable(boolean on)
    throws java.sql.SQLException
```

Enables the system monitor that is associated with a connection. This method cannot be called during monitoring. All times are reset when `enable` is invoked.

#### **getApplicationTimeMillis**

Format:

```
public long getApplicationTimeMillis()
    throws java.sql.SQLException
```

Returns the sum of the application, JDBC driver, network I/O, and database server elapsed times. The time is in milliseconds.

A monitored elapsed time interval is the difference, in milliseconds, between these points in the JDBC driver processing:

#### **Interval beginning**

When `start` is called.

#### **Interval end**

When `stop` is called.

getApplicationTimeMillis returns 0 if system monitoring is disabled. Calling this method without first calling the stop method results in an SQLException.

#### **getCoreDriverTimeMicros**

Format:

```
public long getCoreDriverTimeMicros()  
    throws java.sql.SQLException
```

Returns the sum of elapsed monitored API times that were collected while system monitoring was enabled. The time is in microseconds.

A monitored API is a JDBC driver method for which processing time is collected. In general, elapsed times are monitored only for APIs that might result in network I/O or database server interaction. For example, PreparedStatement.setXXX methods and ResultSet.getXXX methods are not monitored.

Monitored API elapsed time includes the total time that is spent in the driver for a method call. This time includes any network I/O time and database server elapsed time.

A monitored API elapsed time interval is the difference, in microseconds, between these points in the JDBC driver processing:

##### **Interval beginning**

When a monitored API is called by the application.

##### **Interval end**

Immediately before the monitored API returns control to the application.

getCoreDriverTimeMicros returns 0 if system monitoring is disabled. Calling this method without first calling the stop method, or calling this method when the underlying JVM does not support reporting times in microseconds results in an SQLException.

#### **getNetworkIOTimeMicros**

Format:

```
public long getNetworkIOTimeMicros()  
    throws java.sql.SQLException
```

Returns the sum of elapsed network I/O times that were collected while system monitoring was enabled. The time is in microseconds.

Elapsed network I/O time includes the time to write and read DRDA data from network I/O streams. A network I/O elapsed time interval is the time interval to perform the following operations in the JDBC driver:

- Issue a TCP/IP command to send a DRDA message to the database server. This time interval is the difference, in microseconds, between points immediately before and after a write and flush to the network I/O stream is performed.
- Issue a TCP/IP command to receive DRDA reply messages from the database server. This time interval is the difference, in microseconds, between points immediately before and after a read on the network I/O stream is performed.

Network I/O time intervals are captured for all send and receive operations, including the sending of messages for commits and rollbacks.

The time spent waiting for network I/O might be impacted by delays in CPU dispatching at the database server for low-priority SQL requests.



getNetworkIOTimeMicros returns 0 if system monitoring is disabled. Calling this method without first calling the stop method, or calling this method when the underlying JVM does not support reporting times in microseconds results in an SQLException.

### **getServerTimeMicros**

Format:

```
public long getServerTimeMicros()  
    throws java.sql.SQLException
```

Returns the sum of all reported database server elapsed times that were collected while system monitoring was enabled. The time is in microseconds.

The database server reports elapsed times under these conditions:

- The database server supports returning elapsed time data to the client. DB2 Database for Linux, UNIX, and Windows Version 9.5 and later and DB2 for z/OS support this function.
- The database server performs operations that can be monitored. For example, database server elapsed time is not returned for commits or rollbacks.

*For IBM Data Server Driver for JDBC and SQLJ type 2 connectivity to DB2 Database for Linux, UNIX, and Windows, and IBM Data Server Driver for JDBC and SQLJ type 4 connectivity:* The database server elapsed time is defined as the elapsed time to parse the request data stream, process the command, and generate the reply data stream at the database server. Network time to receive or send the data stream is not included. The database server elapsed time interval is the difference, in microseconds, between these points in the database server processing:

#### **Interval beginning**

When the operating system dispatches the database server to process a TCP/IP message that is received from the JDBC driver.

#### **Interval end**

When the database server is ready to issue the TCP/IP command to return the reply message to the client.

*For IBM Data Server Driver for JDBC and SQLJ type 2 connectivity to DB2 for z/OS:* The database server elapsed time interval is the difference, in microseconds, between these points in the JDBC driver native processing:

#### **Interval beginning**

The z/OS Store Clock (STCK) value when a JDBC driver native method calls the RRS attachment facility to process an SQL request.

#### **Interval end**

The z/OS Store Clock (STCK) value when control returns to the JDBC driver native method following an RRS attachment facility call to process an SQL request.

getServerTimeMicros returns 0 if system monitoring is disabled. Calling this method without first calling the stop method results in an SQLException.

### **start**

Format:

```
public void start (int lapMode)  
    throws java.sql.SQLException
```

If the system monitor is enabled, start begins the collection of system monitoring data for a connection. Valid values for *lapMode* are RESET\_TIMES or ACCUMULATE\_TIMES.

Calling this method with system monitoring disabled does nothing. Calling this method more than once without an intervening stop call results in an SQLException.

#### **stop**

Format:

```
public void stop()
    throws java.sql.SQLException
```

If the system monitor is enabled, stop ends the collection of system monitoring data for a connection. After monitoring is stopped, monitored times can be obtained with the getXXX methods of DB2SystemMonitor.

Calling this method with system monitoring disabled does nothing. Calling this method without first calling start, or calling this method more than once without an intervening start call results in an SQLException.

## **DB2TraceManager class**

The com.ibm.db2.jcc.DB2TraceManager class controls the global log writer.

The global log writer is driver-wide, and applies to all connections. The global log writer overrides any other JDBC log writers. In addition to starting the global log writer, the DB2TraceManager class provides the ability to suspend and resume tracing of any type of log writer. That is, the suspend and resume methods of the DB2TraceManager class apply to all current and future DriverManager log writers, DataSource log writers, or IBM Data Server Driver for JDBC and SQLJ-only connection-level log writers.

### **DB2TraceManager methods**

#### **getTraceManager**

Format:

```
static public DB2TraceManager getTraceManager()
    throws java.sql.SQLException
```

Gets an instance of the global log writer.

#### **setLogWriter**

Formats:

```
public abstract void setLogWriter(String traceDirectory,
    String baseTraceFileName, int traceLevel)
    throws java.sql.SQLException
public abstract void setLogWriter(String traceFile,
    boolean fileAppend, int traceLevel)
    throws java.sql.SQLException
public abstract void setLogWriter(java.io.PrintWriter logWriter,
    int traceLevel)
    throws java.sql.SQLException
```

Enables a global trace. After setLogWriter is called, all calls for DataSource or Connection traces are discarded until DB2TraceManager.unsetLogWriter is called.

When setLogWriter is called, all future Connection or DataSource traces are redirected to a trace file or PrintWriter, depending on the form of setLogWriter

that you use. If the global trace is suspended when `setLogWriter` is called, the specified settings take effect when the trace is resumed.

Parameter descriptions:

#### **traceDirectory**

Specifies a directory into which global trace information is written. This setting overrides the settings of the `traceDirectory` and `logWriter` properties for a `DataSource` or `DriverManager` connection.

When the form of `setLogWriter` with the `traceDirectory` parameter is used, the JDBC driver sets the `traceFileAppend` property to `false` when `setLogWriter` is called, which means that the existing log files are overwritten. Each JDBC driver connection is traced to a different file in the specified directory. The naming convention for the files in that directory depends on whether a non-null value is specified for `baseTraceFileName`:

- If a null value is specified for `baseTraceFileName`, a connection is traced to a file named `traceFile_global_n`.  
*n* is the *n*th JDBC driver connection.
- If a non-null value is specified for `baseTraceFileName`, a connection is traced to a file named `baseTraceFileName_global_n`.  
*baseTraceFileName* is the value of the `baseTraceFileName` parameter.  
*n* is the *n*th JDBC driver connection.

#### **baseTraceFileName**

Specifies the stem for the names of the files into which global trace information is written. The combination of `baseTraceFileName` and `traceDirectory` determines the full path name for the global trace log files.

#### **traceFileName**

Specifies the file into which global trace information is written. This setting overrides the settings of the `traceFile` and `logWriter` properties for a `DataSource` or `DriverManager` connection.

When the form of `setLogWriter` with the `traceFileName` parameter is used, only one log file is written.

`traceFileName` can include a directory path.

#### **logWriter**

Specifies a character output stream to which all global log records are written.

This value overrides the `logWriter` property on a `DataSource` or `DriverManager` connection.

#### **traceLevel**

Specifies what to trace.

You can specify one or more of the following traces with the `traceLevel` parameter:

- `com.ibm.db2.jcc.DB2BaseDataSource.TRACE_NONE (X'00')`
- `com.ibm.db2.jcc.DB2BaseDataSource.TRACE_CONNECTION_CALLS (X'01')`
- `com.ibm.db2.jcc.DB2BaseDataSource.TRACE_STATEMENT_CALLS (X'02')`
- `com.ibm.db2.jcc.DB2BaseDataSource.TRACE_RESULT_SET_CALLS (X'04')`
- `com.ibm.db2.jcc.DB2BaseDataSource.TRACE_DRIVER_CONFIGURATION (X'10')`
- `com.ibm.db2.jcc.DB2BaseDataSource.TRACE_CONNECTS (X'20')`
- `com.ibm.db2.jcc.DB2BaseDataSource.TRACE_DRDA_FLOWS (X'40')`
- `com.ibm.db2.jcc.DB2BaseDataSource.TRACE_RESULT_SET_META_DATA (X'80')`
- `com.ibm.db2.jcc.DB2BaseDataSource.TRACE_PARAMETER_META_DATA (X'100')`

- `com.ibm.db2.jcc.DB2BaseDataSource.TRACE_DIAGNOSTICS (X'200')`
- `com.ibm.db2.jcc.DB2BaseDataSource.TRACE_SQLJ (X'400')`
- `com.ibm.db2.jcc.DB2BaseDataSource.TRACE_XA_CALLS` (IBM Data Server Driver for JDBC and SQLJ type 2 connectivity for DB2 Database for Linux, UNIX, and Windows only) (`X'800'`)
- `com.ibm.db2.jcc.DB2BaseDataSource.TRACE_META_CALLS (X'2000')`
- `com.ibm.db2.jcc.DB2BaseDataSource.TRACE_DATASOURCE_CALLS (X'4000')`
- `com.ibm.db2.jcc.DB2BaseDataSource.TRACE_LARGE_OBJECT_CALLS (X'8000')`
- `com.ibm.db2.jcc.DB2BaseDataSource.TRACE_SYSTEM_MONITOR (X'20000')`
- `com.ibm.db2.jcc.DB2BaseDataSource.TRACE_TRACEPOINTS () (X'40000')`
- `com.ibm.db2.jcc.DB2BaseDataSource.TRACE_ALL (X'FFFFFFFF')`

To specify more than one trace, use one of these techniques:

- Use bitwise OR (`|`) operators with two or more trace values. For example, to trace DRDA flows and connection calls, specify this value for `traceLevel`:  
`TRACE_DRDA_FLOWS|TRACE_CONNECTION_CALLS`
- Use a bitwise complement (tilde (`~`)) operator with a trace value to specify all except a certain trace. For example, to trace everything except DRDA flows, specify this value for `traceLevel`:  
`~TRACE_DRDA_FLOWS`

#### **fileAppend**

Specifies whether to append to or overwrite the file that is specified by the `traceFile` parameter. `true` means that the existing file is not overwritten.

#### **unsetLogWriter**

Format:

```
public abstract void unsetLogWriter()
    throws java.sql.SQLException
```

Disables the global log writer override for future connections.

#### **suspendTrace**

Format:

```
public void suspendTrace()
    throws java.sql.SQLException
```

Suspends all global, Connection-level, or DataSource-level traces for current and future connections. `suspendTrace` can be called when the global log writer is enabled or disabled.

#### **resumeTrace**

Format:

```
public void resumeTrace()
    throws java.sql.SQLException
```

Resumes all global, Connection-level, or DataSource-level traces for current and future connections. `resumeTrace` can be called when the global log writer is enabled or disabled. If the global log writer is disabled, `resumeTrace` resumes Connection-level or DataSource-level traces. If the global log writer is enabled, `resumeTrace` resumes the global trace.

#### **getLogWriter**

Format:

```
public abstract java.io.PrintWriter getLogWriter()
    throws java.sql.SQLException
```

Returns the `PrintWriter` for the global log writer, if it is set. Otherwise, `getLogWriter` returns null.

#### **getTraceFile**

Format:

```
public abstract String getTraceFile()
    throws java.sql.SQLException
```

Returns the name of the destination file for the global log writer, if it is set. Otherwise, `getTraceFile` returns null.

#### **getTraceDirectory**

Format:

```
public abstract String getTraceDirectory()
    throws java.sql.SQLException
```

Returns the name of the destination directory for global log writer files, if it is set. Otherwise, `getTraceDirectory` returns null.

#### **getTraceLevel**

Format:

```
public abstract int getTraceLevel()
    throws java.sql.SQLException
```

Returns the trace level for the global trace, if it is set. Otherwise, `getTraceLevel` returns -1 (`TRACE_ALL`).

#### **getTraceFileAppend**

Format:

```
public abstract boolean getTraceFileAppend()
    throws java.sql.SQLException
```

Returns true if the global trace records are appended to the trace file. Otherwise, `getTraceFileAppend` returns false.

## **DB2TraceManagerMXBean interface**

The `com.ibm.db2.jcc.mx.DB2TraceManagerMXBean` interface is the means by which an application makes `DB2TraceManager` available as an `MXBean` for the remote trace controller.

### **DB2TraceManagerMXBean methods**

#### **setTraceFile**

Format:

```
public void setTraceFile(String traceFile,
    boolean fileAppend, int traceLevel)
    throws java.sql.SQLException
```

Specifies the name of the file into which the remote trace manager writes trace information, and the type of information that is to be traced.

Parameter descriptions:

#### **traceFileName**

Specifies the file into which global trace information is written. This setting overrides the settings of the `traceFile` and `logWriter` properties for a `DataSource` or `DriverManager` connection.

When the form of `setLogWriter` with the `traceFileName` parameter is used, only one log file is written.

traceFileName can include a directory path.

### **fileAppend**

Specifies whether to append to or overwrite the file that is specified by the traceFile parameter. true means that the existing file is not overwritten.

### **traceLevel**

Specifies what to trace.

You can specify one or more of the following traces with the traceLevel parameter:

- com.ibm.db2.jcc.DB2BaseDataSource.TRACE\_NONE (X'00')
- com.ibm.db2.jcc.DB2BaseDataSource.TRACE\_CONNECTION\_CALLS (X'01')
- com.ibm.db2.jcc.DB2BaseDataSource.TRACE\_STATEMENT\_CALLS (X'02')
- com.ibm.db2.jcc.DB2BaseDataSource.TRACE\_RESULT\_SET\_CALLS (X'04')
- com.ibm.db2.jcc.DB2BaseDataSource.TRACE\_DRIVER\_CONFIGURATION (X'10')
- com.ibm.db2.jcc.DB2BaseDataSource.TRACE\_CONNECTS (X'20')
- com.ibm.db2.jcc.DB2BaseDataSource.TRACE\_DRDA\_FLOWS (X'40')
- com.ibm.db2.jcc.DB2BaseDataSource.TRACE\_RESULT\_SET\_META\_DATA (X'80')
- com.ibm.db2.jcc.DB2BaseDataSource.TRACE\_PARAMETER\_META\_DATA (X'100')
- com.ibm.db2.jcc.DB2BaseDataSource.TRACE\_DIAGNOSTICS (X'200')
- com.ibm.db2.jcc.DB2BaseDataSource.TRACE\_SQLJ (X'400')
- com.ibm.db2.jcc.DB2BaseDataSource.TRACE\_XA\_CALLS (IBM Data Server Driver for JDBC and SQLJ type 2 connectivity for DB2 Database for Linux, UNIX, and Windows only) (X'800')
- com.ibm.db2.jcc.DB2BaseDataSource.TRACE\_META\_CALLS (X'2000')
- com.ibm.db2.jcc.DB2BaseDataSource.TRACE\_DATASOURCE\_CALLS (X'4000')
- com.ibm.db2.jcc.DB2BaseDataSource.TRACE\_LARGE\_OBJECT\_CALLS (X'8000')
- com.ibm.db2.jcc.DB2BaseDataSource.TRACE\_SYSTEM\_MONITOR (X'20000')
- com.ibm.db2.jcc.DB2BaseDataSource.TRACE\_TRACEPOINTS () (X'40000')
- com.ibm.db2.jcc.DB2BaseDataSource.TRACE\_ALL (X'FFFFFFFF')

To specify more than one trace, use one of these techniques:

- Use bitwise OR (|) operators with two or more trace values. For example, to trace DRDA flows and connection calls, specify this value for traceLevel:  
TRACE\_DRDA\_FLOWS|TRACE\_CONNECTION\_CALLS
- Use a bitwise complement (tilde (~)) operator with a trace value to specify all except a certain trace. For example, to trace everything except DRDA flows, specify this value for traceLevel:  
~TRACE\_DRDA\_FLOWS

### **getTraceFile**

Format:

```
public void getTraceFile()  
    throws java.sql.SQLException
```

Returns the name of the destination file for the remote trace controller, if it is set. Otherwise, getTraceFile returns null.

### **setTraceDirectory**

Format:

```
public void setTraceDirectory(String traceDirectory,  
    String baseTraceFileName,  
    int traceLevel) throws java.sql.SQLException
```

Specifies the name of the directory into which the remote trace controller writes trace information, and the type of information that is to be traced.

Parameter descriptions:

### **traceDirectory**

Specifies a directory into which trace information is written. This setting overrides the settings of the `traceDirectory` and `logWriter` properties for a `DataSource` or `DriverManager` connection.

Each JDBC driver connection is traced to a different file in the specified directory. The naming convention for the files in that directory depends on whether a non-null value is specified for `baseTraceFileName`:

- If a null value is specified for `baseTraceFileName`, a connection is traced to a file named `traceFile_global_n`.  
*n* is the *n*th JDBC driver connection.
- If a non-null value is specified for `baseTraceFileName`, a connection is traced to a file named `baseTraceFileName_global_n`.  
*baseTraceFileName* is the value of the `baseTraceFileName` parameter.  
*n* is the *n*th JDBC driver connection.

### **baseTraceFileName**

Specifies the stem for the names of the files into which global trace information is written. The combination of `baseTraceFileName` and `traceDirectory` determines the full path name for the global trace log files.

### **traceLevel**

Specifies what to trace.

You can specify one or more of the following traces with the `traceLevel` parameter:

- `com.ibm.db2.jcc.DB2BaseDataSource.TRACE_NONE (X'00')`
- `com.ibm.db2.jcc.DB2BaseDataSource.TRACE_CONNECTION_CALLS (X'01')`
- `com.ibm.db2.jcc.DB2BaseDataSource.TRACE_STATEMENT_CALLS (X'02')`
- `com.ibm.db2.jcc.DB2BaseDataSource.TRACE_RESULT_SET_CALLS (X'04')`
- `com.ibm.db2.jcc.DB2BaseDataSource.TRACE_DRIVER_CONFIGURATION (X'10')`
- `com.ibm.db2.jcc.DB2BaseDataSource.TRACE_CONNECTS (X'20')`
- `com.ibm.db2.jcc.DB2BaseDataSource.TRACE_DRDA_FLOWS (X'40')`
- `com.ibm.db2.jcc.DB2BaseDataSource.TRACE_RESULT_SET_META_DATA (X'80')`
- `com.ibm.db2.jcc.DB2BaseDataSource.TRACE_PARAMETER_META_DATA (X'100')`
- `com.ibm.db2.jcc.DB2BaseDataSource.TRACE_DIAGNOSTICS (X'200')`
- `com.ibm.db2.jcc.DB2BaseDataSource.TRACE_SQLJ (X'400')`
- `com.ibm.db2.jcc.DB2BaseDataSource.TRACE_XA_CALLS (IBM Data Server Driver for JDBC and SQLJ type 2 connectivity for DB2 Database for Linux, UNIX, and Windows only) (X'800')`
- `com.ibm.db2.jcc.DB2BaseDataSource.TRACE_META_CALLS (X'2000')`
- `com.ibm.db2.jcc.DB2BaseDataSource.TRACE_DATASOURCE_CALLS (X'4000')`
- `com.ibm.db2.jcc.DB2BaseDataSource.TRACE_LARGE_OBJECT_CALLS (X'8000')`
- `com.ibm.db2.jcc.DB2BaseDataSource.TRACE_SYSTEM_MONITOR (X'20000')`
- `com.ibm.db2.jcc.DB2BaseDataSource.TRACE_TRACEPOINTS () (X'40000')`
- `com.ibm.db2.jcc.DB2BaseDataSource.TRACE_ALL (X'FFFFFFFF')`

To specify more than one trace, use one of these techniques:

- Use bitwise OR (`|`) operators with two or more trace values. For example, to trace DRDA flows and connection calls, specify this value for `traceLevel`:  
`TRACE_DRDA_FLOWS|TRACE_CONNECTION_CALLS`
- Use a bitwise complement (tilde (`~`)) operator with a trace value to specify all except a certain trace. For example, to trace everything except DRDA flows, specify this value for `traceLevel`:



~TRACE\_DRDA\_FLOWS

### **getTraceFileAppend**

Format:

```
public abstract boolean getTraceFileAppend()  
    throws java.sql.SQLException
```

Returns true if trace records that are generated by the trace controller are appended to the trace file. Otherwise, `getTraceFileAppend` returns false.

### **getTraceDirectory**

Format:

```
public void getTraceDirectory()  
    throws java.sql.SQLException
```

Returns the name of the destination directory for trace records that are generated by the trace controller, if it is set. Otherwise, `getTraceDirectory` returns null.

### **getTraceLevel**

Format:

```
public void getTraceLevel()  
    throws java.sql.SQLException
```

Returns the trace level for the trace records that are generated by the trace controller, if it is set. Otherwise, `getTraceLevel` returns -1 (`TRACE_ALL`).

### **unsetLogWriter**

Format:

```
public abstract void unsetLogWriter()  
    throws java.sql.SQLException
```

Disables the global log writer override for future connections.

### **suspendTrace**

Format:

```
public void suspendTrace()  
    throws java.sql.SQLException
```

Suspends all global, Connection-level, or DataSource-level traces for current and future connections. `suspendTrace` can be called when the global log writer is enabled or disabled.

### **resumeTrace**

Format:

```
public void resumeTrace()  
    throws java.sql.SQLException
```

Resumes all global, Connection-level, or DataSource-level traces for current and future connections. `resumeTrace` can be called when the global log writer is enabled or disabled. If the global log writer is disabled, `resumeTrace` resumes Connection-level or DataSource-level traces. If the global log writer is enabled, `resumeTrace` resumes the global trace.

## **DB2Struct interface**

The `com.ibm.db2.jcc.DB2Struct` interface provides IBM Data Server Driver for JDBC and SQLJ-only methods for working with Struct objects.



## DB2Struct methods

### getMetaData

Format:

```
java.sql.ResultSetMetaData getMetaData()  
throws SQLException
```

Returns metadata for a DB2Struct object.

## DB2Types class

The `com.ibm.db2.jcc.DB2Types` class provides fields that define IBM Data Server Driver for JDBC and SQLJ-only data types.

### DB2Types fields

The following constants define types codes only for the IBM Data Server Driver for JDBC and SQLJ.

- `public final static int BLOB_FILE = -100002`
- `public final static int CLOB_FILE = -100003`
- `public final static int CURSOR = -100008`
- `public final static int DECFLOAT = -100001`
- `public final static int XML_AS_BLOB_FILE = -100004`
- `public final static int XML_AS_CLOB_FILE = -100005`
- `public final static int TIMESTAMPTZ = -100010`

## DB2XADataSource class

DB2XADataSource is a factory for XADataSource objects. An object that implements this interface is registered with a naming service that is based on the Java Naming and Directory Interface (JNDI).

The `com.ibm.db2.jcc.DB2XADataSource` class extends the `com.ibm.db2.jcc.DB2BaseDataSource` class, and implements the `javax.sql.XADataSource`, `java.io.Serializable`, and `javax.naming.Referenceable` interfaces.

### DB2XADataSource methods

#### getDB2TrustedXAConnection

Formats:

```
public Object[] getDB2TrustedXAConnection(String user,  
String password,  
java.util.Properties properties)  
throws java.sql.SQLException  
public Object[] getDB2TrustedXAConnection(  
java.util.Properties properties)  
throws java.sql.SQLException  
public Object[] getDB2TrustedXAConnection(  
org.ietf.jgss.GSSCredential gssCredential,  
java.util.Properties properties)  
throws java.sql.SQLException
```

An application server using a system authorization ID uses this method to establish a trusted connection.

Trusted connections are supported for:

- IBM Data Server Driver for JDBC and SQLJ type 4 connectivity to:

- DB2 Database for Linux, UNIX, and Windows Version 9.5 or later
- DB2 for z/OS Version 9.1 or later
- IBM Informix Version 11.70 or later
- IBM Data Server Driver for JDBC and SQLJ type 2 connectivity on DB2 for z/OS Version 9.1 or later

The following elements are returned in Object[]:

- The first element is a DB2TrustedXAConnection instance.
- The second element is a unique cookie for the generated XA connection instance.

The first form of getDB2TrustedXAConnection provides a user ID and password. The second form of getDB2TrustedXAConnection uses the user ID and password of the DB2XADataSource object. The third form of getDB2TrustedXAConnection is for connections that use Kerberos security.

Parameter descriptions:

**user**

The authorization ID that is used to establish the trusted connection.

**password**

The password for the authorization ID that is used to establish the trusted connection.

**gssCredential**

If the data source uses Kerberos security, specifies a delegated credential that is passed from another principal.

**properties**

Properties for the connection.

**getDB2TrustedPooledConnection**

Format:

```
public Object[] getDB2TrustedPooledConnection(java.util.Properties properties)
    throws java.sql.SQLException
```

An application server using a system authorization ID uses this method to establish a trusted connection, using the user ID and password for the DB2XADataSource object.

Trusted connections are supported for:

- IBM Data Server Driver for JDBC and SQLJ type 4 connectivity to:
  - DB2 Database for Linux, UNIX, and Windows Version 9.5 or later
  - DB2 for z/OS Version 9.1 or later
  - IBM Informix Version 11.70 or later
- IBM Data Server Driver for JDBC and SQLJ type 2 connectivity on DB2 for z/OS Version 9.1 or later

The following elements are returned in Object[]:

- The first element is a trusted DB2TrustedPooledConnection instance.
- The second element is a unique cookie for the generated pooled connection instance.

Parameter descriptions:

**properties**

Properties for the connection.

### **getDB2XAConnection**

Formats:

```
public DB2XAConnection getDB2XAConnection(String user,
    String password,
    java.util.Properties properties)
    throws java.sql.SQLException
public DB2XAConnection getDB2XAConnection(
    org.ietf.jgss.GSSCredential gssCredential,
    java.util.Properties properties)
    throws java.sql.SQLException
```

Establishes the initial untrusted connection in a heterogeneous pooling environment.

The first form `getDB2PooledConnection` provides a user ID and password. The second form of `getDB2XAConnection` is for connections that use Kerberos security.

Parameter descriptions:

#### **user**

The authorization ID that is used to establish the connection.

#### **password**

The password for the authorization ID that is used to establish the connection.

#### **gssCredential**

If the data source uses Kerberos security, specifies a delegated credential that is passed from another principal.

#### **properties**

Properties for the connection.

## **DB2Xml interface**

The `com.ibm.db2.jcc.DB2Xml` interface is used for declaring Java objects for use with the DB2 XML data type.

### **DB2Xml methods**

The following method is defined only for the IBM Data Server Driver for JDBC and SQLJ.

#### **closeDB2Xml**

Format:

```
public void closeDB2Xml()
    throws SQLException
```

Releases the resources that are associated with a `com.ibm.jcc.DB2Xml` object.

#### **getDB2AsciiStream**

Format:

```
public java.io.InputStream getDB2AsciiStream()
    throws SQLException
```

Retrieves data from a `DB2Xml` object, and converts the data to US-ASCII encoding.

#### **getDB2BinaryStream**

Format:

```
public java.io.InputStream getDB2BinaryStream()  
    throws SQLException
```

Retrieves data from a DB2Xml object as a binary stream. The character encoding of the bytes in the binary stream is defined in the XML 1.0 specification.

#### **getDB2Bytes**

Format:

```
public byte[] getDB2Bytes()  
    throws SQLException
```

Retrieves data from a DB2Xml object as a byte array. The character encoding of the bytes is defined in the XML 1.0 specification.

#### **getDB2CharacterStream**

Format:

```
public java.io.Reader getDB2CharacterStream()  
    throws SQLException
```

Retrieves data from a DB2Xml object as a java.io.Reader object.

#### **getDB2String**

Format:

```
public String getDB2String()  
    throws SQLException
```

Retrieves data from a DB2Xml object as a String value.

#### **getDB2XmlAsciiStream**

Format:

```
public InputStream getDB2XmlAsciiStream()  
    throws SQLException
```

Retrieves data from a DB2Xml object, converts the data to US-ASCII encoding, and imbeds an XML declaration with an encoding specification for US-ASCII in the returned data.

#### **getDB2XmlBinaryStream**

Format:

```
public java.io.InputStream getDB2XmlBinaryStream(String targetEncoding)  
    throws SQLException
```

Retrieves data from a DB2Xml object as a binary stream, converts the data to *targetEncoding*, and imbeds an XML declaration with an encoding specification for *targetEncoding* in the returned data.

Parameter:

*targetEncoding*

A valid encoding name that is listed in the IANA Charset Registry. The encoding names that are supported by the DB2 server are listed in "Mappings of CCSIDs to encoding names for serialized XML output data".

#### **getDB2XmlBytes**

Format:

```
public byte[] getDB2XmlBytes(String targetEncoding)  
    throws SQLException
```

Retrieves data from a DB2Xml object as a byte array, converts the data to *targetEncoding*, and imbeds an XML declaration with an encoding specification for *targetEncoding* in the returned data.

Parameter:

*targetEncoding*

A valid encoding name that is listed in the IANA Charset Registry. The encoding names that are supported by the DB2 server are listed in "Mappings of CCSIDs to encoding names for serialized XML output data".

#### **getDB2XmlCharacterStream**

Format:

```
public java.io.Reader getDB2XmlCharacterStream()  
    throws SQLException
```

Retrieves data from a DB2Xml object as a java.io.Reader object, converts the data to ISO-10646-UCS-2 encoding, and imbeds an XML declaration with an encoding specification for ISO-10646-UCS-2 in the returned data.

#### **getDB2XmlString**

Format:

```
public String getDB2XmlString()  
    throws SQLException
```

Retrieves data from a DB2Xml object as a String object, converts the data to ISO-10646-UCS-2 encoding, and imbeds an XML declaration with an encoding specification for ISO-10646-UCS-2 in the returned data.

#### **isDB2XmlClosed**

Format:

```
public boolean isDB2XmlClosed()  
    throws SQLException
```

Indicates whether a com.ibm.jcc.DB2Xml object has been closed.

## **DBTimestamp class**

The com.ibm.db2.jcc.DBTimestamp class can be used to create timestamp objects with a precision of up to picoseconds and time zone information. This class is primarily for support of the SQL TIMESTAMP WITH TIME ZONE data type, which is supported only by DB2 for z/OS.

The com.ibm.db2.jcc.DBTimestamp class is a subclass of the java.sql.Timestamp class. Therefore, a com.ibm.db2.jcc.DBTimestamp object can be used with any methods that normally operate on a java.sql.Timestamp object, or take a java.sql.Timestamp object as an argument.

The IBM Data Server Driver for JDBC and SQLJ returns a DBTimestamp object for all JDBC methods that return timestamp information, such as ResultSet.getTimestamp or CallableStatement.getTimestamp.

### **DBTimestamp constructor**

The following constructor is defined only for the IBM Data Server Driver for JDBC and SQLJ.

#### **DBTimestamp**

Formats:

```

public DBTimestamp(long time,
    java.util.Calendar calendar)
    throws java.sql.SQLException
public DBTimestamp(long time, )
    throws java.sql.SQLException
public DBTimestamp(java.sql.Timestamp timestamp)
    throws java.sql.SQLException
public DBTimestamp(java.sql.Timestamp timestamp,
    java.util.Calendar calendar)
    throws java.sql.SQLException

```

Constructs a DBTimestamp object.

Parameter descriptions:

**time**

The number of milliseconds since January 1, 1970.

**timestamp**

A Timestamp value with a precision of up to picoseconds.

**calendar**

The Calendar value that provides the time zone.

## DBTimestamp methods

**getPicos**

Formats:

```
public long getPicos()
```

Returns the fractional seconds component of a DBTimestamp value.

**getTimeZone**

Formats:

```
public java.util.TimeZone getTimeZone()
```

Returns the time zone component of a DBTimestamp value.

**setPicos**

Format:

```
public void setPicos(long p)
    throws SQLException
```

Assigns the given value to the fractional seconds component of a DBTimestamp value.

Parameter descriptions:

**p** A value between 0 and 999999999999, inclusive, which is the fractional sections component of a DBTimestamp value.

**setTimeZone**

Format:

```
public void setTimeZone(java.util.TimeZone timeZone)
    throws SQLException
```

Assigns the given value to the time zone component of a DBTimestamp value.

Parameter descriptions:

**timeZone**

The time zone component of a DBTimestamp value.

### **valueOfDBString**

Format:

```
public static DBTimestamp valueOfDBString(String s)
    throws java.lang.IllegalArgumentException
```

Constructs a DBTimestamp value from the string representation of a timestamp value.

Parameter descriptions:

- s** The string representation of a timestamp value. The value must be in one of the following formats:

```
yyyy-mm-dd.hh.mm.ss[.ffffffffffff]-th:tm
yyyy-mm-dd hh:mm:ss[.ffffffffffff]-th:tm
yyyy-mm-dd.hh.mm.ss[.ffffffffffff]
yyyy-mm-dd hh:mm:ss[.ffffffffffff]
```

- *yyyy* is a year.
- *mm* is a month.
- *dd* is a day.
- *hh* is hours.
- *mm* is minutes.
- *ss* is seconds.
- *[.ffffffffffff]* is one to 12 optional fractions of seconds.
- *th* is the hours component of a time zone.
- *tm* is the minutes component of a time zone.

### **toDBString**

Format:

```
public String toDBString(boolean includeTimeZone)
```

Returns the string representation of a DBTimestamp object.

The returned value has one of the following formats:

```
yyyy-mm-dd.hh.mm.ss[.ffffffffffff]-th:tm
yyyy-mm-dd.hh.mm.ss[.ffffffffffff]
```

Parameter description:

#### **includeTimeZone**

Specifies whether to include the time zone (*-th:tm*) in the returned string.

---

## **JDBC differences between versions of the IBM Data Server Driver for JDBC and SQLJ**

Before you can upgrade your JDBC applications from older to newer versions of the IBM Data Server Driver for JDBC and SQLJ, you need to understand the differences between those drivers.

### **Supported methods**

For a list of methods that the IBM Data Server Driver for JDBC and SQLJ supports, see the information on driver support for JDBC APIs.

## Use of progressive streaming by the JDBC drivers

For IBM Data Server Driver for JDBC and SQLJ, Version 3.50 and later, progressive streaming, which is also known as dynamic data format, behavior is the default for LOB retrieval, for connections to DB2 Database for Linux, UNIX, and Windows Version 9.5 and later.

Progressive streaming is supported in the IBM Data Server Driver for JDBC and SQLJ Version 3.1 and later, but for IBM Data Server Driver for JDBC and SQLJ version 3.2 and later, progressive streaming behavior is the default for LOB and XML retrieval, for connections to DB2 for z/OS Version 9.1 and later.

Previous versions of the IBM Data Server Driver for JDBC and SQLJ did not support progressive streaming.

**Important:** With progressive streaming, when you retrieve a LOB or XML value from a `ResultSet` into an application variable, you can manipulate the contents of that application variable until you move the cursor or close the cursor on the `ResultSet`. After that, the contents of the application variable are no longer available to you. If you perform any actions on the LOB in the application variable, you receive an `SQLException`. For example, suppose that progressive streaming is enabled, and you execute statements like this:

```
...
ResultSet rs = stmt.executeQuery("SELECT CLOB COL FROM MY_TABLE");
rs.next(); // Retrieve the first row of the ResultSet
Clob clobFromRow1 = rs.getClob(1);
// Put the CLOB from the first column of
// the first row in an application variable
String substr1Clob = clobFromRow1.getSubString(1,50);
// Retrieve the first 50 bytes of the CLOB
rs.next(); // Move the cursor to the next row.
// clobFromRow1 is no longer available.
// String substr2Clob = clobFromRow1.getSubString(51,100);
// This statement would yield an SQLException
Clob clobFromRow2 = rs.getClob(1);
// Put the CLOB from the first column of
// the second row in an application variable
rs.close(); // Close the ResultSet.
// clobFromRow2 is also no longer available.
```

After you execute `rs.next()` to position the cursor at the second row of the `ResultSet`, the CLOB value in `clobFromRow1` is no longer available to you. Similarly, after you execute `rs.close()` to close the `ResultSet`, the values in `clobFromRow1` and `clobFromRow2` are no longer available.

To avoid errors that are due to this changed behavior, you need to take one of the following actions:

- Modify your applications.  
Applications that retrieve LOB data into application variables can manipulate the data in those application variables only until the cursors that were used to retrieve the data are moved or closed.
- Disable progressive streaming by setting the `progressiveStreaming` property to `DB2BaseDataSource.NO` (2).



## **ResultSetMetaData values for IBM Data Server Driver for JDBC and SQLJ version 4.0 and later**

For the IBM Data Server Driver for JDBC and SQLJ version 4.0 and later, the default behavior of `ResultSetMetaData.getColumnNames` and `ResultSetMetaData.getColumnLabels` differs from the default behavior for earlier JDBC drivers.

If you need to use IBM Data Server Driver for JDBC and SQLJ version 4.0 or later, but your applications need to return the `ResultSetMetaData.getColumnNames` and `ResultSetMetaData.getColumnLabels` values that were returned with older JDBC drivers, you can set the `useJDBC4ColumnNameAndLabelSemantics` Connection and `DataSource` property to `DB2BaseDataSource.NO` (2).

## **Batch updates with automatically generated keys have different results in different driver versions**

With the IBM Data Server Driver for JDBC and SQLJ version 3.52 or later, preparing an SQL statement for retrieval of automatically generated keys is supported.

With the IBM Data Server Driver for JDBC and SQLJ version 3.50 or version 3.51, preparing an SQL statement for retrieval of automatically generated keys and using the `PreparedStatement` object for batch updates causes an `SQLException`.

Versions of the IBM Data Server Driver for JDBC and SQLJ before Version 3.50 do not throw an `SQLException` when an application calls the `addBatch` or `executeBatch` method on a `PreparedStatement` object that is prepared to return automatically generated keys. However, the `PreparedStatement` object does not return automatically generated keys.

## **Batch updates of data on DB2 for z/OS servers have different results in different driver versions**

After you successfully invoke an `executeBatch` statement, the IBM Data Server Driver for JDBC and SQLJ returns an array. The purpose of the array is to indicate the number of rows that are affected by each SQL statement that is executed in the batch.

If the following conditions are true, the IBM Data Server Driver for JDBC and SQLJ returns `Statement.SUCCESS_NO_INFO` (-2) in the array elements:

- The application is connected to a subsystem that is in DB2 for z/OS Version 8 new-function mode, or later.
- The application is using Version 3.1 or later of the IBM Data Server Driver for JDBC and SQLJ.
- The IBM Data Server Driver for JDBC and SQLJ uses multi-row INSERT operations to execute batch updates.

This occurs because with multi-row INSERT, the database server executes the entire batch as a single operation, so it does not return results for individual SQL statements.

If you are using an earlier version of the IBM Data Server Driver for JDBC and SQLJ, or you are connected to a data source other than DB2 for z/OS Version 8 or

later, the array elements contain the number of rows that are affected by each SQL statement.

### **Batch updates and deletes of data on DB2 for z/OS servers have different size limitations in different driver versions**

Before IBM Data Server Driver for JDBC and SQLJ version 3.59 or 4.9, a `DisconnectException` with error code -4499 was thrown for IBM Data Server Driver for JDBC and SQLJ type 4 connectivity to DB2 for z/OS if the size of an update or delete batch was greater than 32KB. Starting with version 3.59 or 4.9, this restriction no longer exists, and the exception is no longer thrown.

### **Initial value of the CURRENT\_CLIENT\_ACCTNG special register**

For a JDBC or SQLJ application that runs under the IBM Data Server Driver for JDBC and SQLJ version 2.6 or later, using type 4 connectivity, the initial value for the DB2 for z/OS `CURRENT_CLIENT_ACCTNG` special register is the concatenation of the DB2 for z/OS version and the value of the `clientWorkStation` property. For any other JDBC driver, version, and connectivity, the initial value is not set.

### **Properties that control the use of multi-row FETCH**

Before version 3.7 and version 3.51 of the IBM Data Server Driver for JDBC and SQLJ, multi-row `FETCH` support was enabled and disabled through the `useRowsetCursor` property, and was available only for scrollable cursors, and for IBM Data Server Driver for JDBC and SQLJ type 4 connectivity to DB2 for z/OS. Starting with version 3.7 and 3.51:

- For IBM Data Server Driver for JDBC and SQLJ type 2 connectivity on DB2 for z/OS, the IBM Data Server Driver for JDBC and SQLJ uses only the `enableRowsetSupport` property to determine whether to use multi-row `FETCH` for scrollable or forward-only cursors.
- For IBM Data Server Driver for JDBC and SQLJ type 4 connectivity to DB2 for z/OS or DB2 Database for Linux, UNIX, and Windows, or IBM Data Server Driver for JDBC and SQLJ type 2 connectivity on DB2 Database for Linux, UNIX, and Windows, the IBM Data Server Driver for JDBC and SQLJ uses the `enableRowsetSupport` property to determine whether to use multi-row `FETCH` for scrollable cursors, if `enableRowsetSupport` is set. If `enableRowsetSupport` is not set, the driver uses the `useRowsetCursor` property to determine whether to use multi-row `FETCH`.

### **JDBC 1 positioned updates and deletes and multi-row FETCH**

Before version 3.7 and version 3.51 of the IBM Data Server Driver for JDBC and SQLJ, multi-row `FETCH` from DB2 for z/OS tables was controlled by the `useRowsetCursor` property. If an application contained JDBC 1 positioned update or delete operations, and multi-row `FETCH` support was enabled, the IBM Data Server Driver for JDBC and SQLJ permitted the update or delete operations, but unexpected updates or deletes might occur.

Starting with version 3.7 and 3.51 of the IBM Data Server Driver for JDBC and SQLJ, the `enableRowsetSupport` property enables or disables multi-row `FETCH` from DB2 for z/OS tables or DB2 Database for Linux, UNIX, and Windows tables. The `enableRowsetSupport` property overrides the `useRowsetCursor` property. If multi-row `FETCH` is enabled through the `enableRowsetSupport` property, and an

application contains a JDBC 1 positioned update or delete operation, the IBM Data Server Driver for JDBC and SQLJ throws an SQLException.

### **Valid forms of prepareStatement for retrieval of automatically generated keys from a DB2 for z/OS view**

Starting with version 3.57 or version 4.7 of the IBM Data Server Driver for JDBC and SQLJ, if you are inserting data into a view on a DB2 for z/OS data server, and you want to retrieve automatically generated keys, you need to use one of the following methods to prepare the SQL statement that inserts rows into the view:

```
Connection.prepareStatement(sql-statement, String [] columnNames);  
Connection.prepareStatement(sql-statement, int [] columnIndexes);  
Statement.executeUpdate(sql-statement, String [] columnNames);  
Statement.executeUpdate(sql-statement, int [] columnIndexes);
```

### **Data loss for TIMESTAMP(p) column updates using setString**

If you use a setString call to pass an input value to a TIMESTAMP(p) column, it is possible to send a value with a precision of greater than nine to the column.

Before version 3.59 or version 4.9 of the IBM Data Server Driver for JDBC and SQLJ, data loss could occur if the sendDataAsIs property was set to false, and the precision of the input value was greater than nine.

Starting with version 3.59 and version 4.9 of the IBM Data Server Driver for JDBC and SQLJ, data loss does not occur if the TIMESTAMP(p) column is large enough to accommodate the input value.

### **Change to result set column name for getColumnns**

In version 4.12 or earlier of the IBM Data Server Driver for JDBC and SQLJ, the DatabaseMetaData.getColumnns method returned a result set that contained a column named SCOPE\_CATLOG. In version 4.13 or later of the IBM Data Server Driver for JDBC and SQLJ, the name of that column is SCOPE\_CATALOG. If you want the IBM Data Server Driver for JDBC and SQLJ to continue to use the column name SCOPE\_CATLOG, set DataSource or Connection property useJDBC41DefinitionForGetColumns to DB2BaseDataSource.NO (2).

### **Change to result set column name for getColumnns**

In version 4.12 or earlier of the IBM Data Server Driver for JDBC and SQLJ, the DatabaseMetaData.getColumnns method returned a result set that contained a column named SCOPE\_CATLOG. In version 4.13 or later of the IBM Data Server Driver for JDBC and SQLJ, the name of that column is SCOPE\_CATALOG. If you want the IBM Data Server Driver for JDBC and SQLJ to continue to use the column name SCOPE\_CATLOG, set DataSource or Connection property useJDBC41DefinitionForGetColumns to DB2BaseDataSource.NO (2).

### **Changes to defaults for global configuration properties db2.jcc.maxRefreshInterval, db2.jcc.maxTransportObjects, and db2.jcc.maxTransportObjectWaitTime**

The default values for global configuration properties db2.jcc.maxRefreshInterval, db2.jcc.maxTransportObjects, and db2.jcc.maxTransportObjectWaitTime change in version 3.63 and 4.13 of the IBM Data Server Driver for JDBC and SQLJ. The following table lists the old and new defaults.

Configuration property	Default before versions 3.63 and 4.13	Default for versions 3.63 and 4.13 or later
db2.jcc.maxRefreshInterval	30 seconds	10 seconds
db2.jcc.maxTransportObjects	-1 (unlimited)	1000
db2.jcc.maxTransportObjectWaitTime	-1 (unlimited)	1 second

### Changes to default values for Connection and DataSource properties maxRetriesForClientReroute and retryIntervalForClientReroute

The default values for Connection and DataSource properties maxRetriesForClientReroute and retryIntervalForClientReroute change in version 3.63 and 4.13 of the IBM Data Server Driver for JDBC and SQLJ. The following table lists the old and new defaults.

Connection and DataSource property	Default value before versions 3.63 and 4.13	Default value for versions 3.63 and 4.13 or later
maxRetriesForClientReroute	If maxRetriesForClientReroute and retryIntervalForClientReroute are not set, the connection is retried for 10 minutes, with a wait time between retries that increases as the length of time from the first retry increases.	If maxRetriesForClientReroute and retryIntervalForClientReroute are not set, enableSysplexWLB property is set to true, and the data server is DB2 for z/OS, the default is 5. Otherwise, the default is the same as for previous driver versions.
retryIntervalForClientReroute	If maxRetriesForClientReroute and retryIntervalForClientReroute are not set, the connection is retried for 10 minutes, with a wait time between retries that increases as the length of time from the first retry increases.	If maxRetriesForClientReroute and retryIntervalForClientReroute are not set, enableSysplexWLB property is set to true, and the data server is DB2 for z/OS, the default is 0 seconds. Otherwise, the default is the same as for previous driver versions.

### Examples of ResultSetMetaData.getColumnNames and ResultSetMetaData.getColumnLabels values

For the IBM Data Server Driver for JDBC and SQLJ version 4.0 and later, the default behavior of ResultSetMetaData.getColumnNames and ResultSetMetaData.getColumnLabels differs from the default behavior for earlier JDBC drivers. You can use the useJDBC4ColumnNameAndLabelSemantics property to change this behavior.

The following examples show the values that are returned for IBM Data Server Driver for JDBC and SQLJ Version 4.0, and for previous JDBC drivers, when the useJDBC4ColumnNameAndLabelSemantics property is not set.

All queries use a table that is defined like this:

```
CREATE TABLE MYTABLE(INTCOL INT)
```

**Example:** The following query contains an AS CLAUSE, which defines a label for a column in the result set:

```
SELECT MYCOL AS MYLABEL FROM MYTABLE
```

The following table lists the `ResultSetMetaData.getColumnNames` and `ResultSetMetaData.getColumnLabels` values that are returned for the query:

Table 116. `ResultSetMetaData.getColumnNames` and `ResultSetMetaData.getColumnLabels` before and after IBM Data Server Driver for JDBC and SQLJ Version 4.0 for a query with an AS CLAUSE

Target data source	Behavior before IBM Data Server Driver for JDBC and SQLJ Version 4.0		Behavior for IBM Data Server Driver for JDBC and SQLJ Version 4.0 and later	
	<code>getColumnNames</code> value	<code>getColumnLabels</code> value	<code>getColumnNames</code> value	<code>getColumnLabels</code> value
DB2 Database for Linux, UNIX, and Windows	MYLABEL	MYLABEL	MYCOL	MYLABEL
IBM Informix	MYLABEL	MYLABEL	MYCOL	MYLABEL
DB2 for z/OS Version 8 or later, and DB2 UDB for iSeries V5R3 and later	MYLABEL	MYLABEL	MYCOL	MYLABEL
DB2 for z/OS Version 7, and DB2 UDB for iSeries V5R2	MYLABEL	MYLABEL	MYLABEL	MYLABEL

**Example:** The following query contains no AS clause:

```
SELECT MYCOL FROM MYTABLE
```

The `ResultSetMetaData.getColumnNames` and `ResultSetMetaData.getColumnLabels` methods on the query return MYCOL, regardless of the target data source.

**Example:** On a DB2 for z/OS or DB2 for i data source, a LABEL ON statement is used to define a label for a column:

```
LABEL ON COLUMN MYTABLE.MYCOL IS 'LABELONCOL'
```

The following query contains an AS CLAUSE, which defines a label for a column in the ResultSet:

```
SELECT MYCOL AS MYLABEL FROM MYTABLE
```

The following table lists the `ResultSetMetaData.getColumnNames` and `ResultSetMetaData.getColumnLabels` values that are returned for the query.

Table 117. *ResultSetMetaData.getColumnLabel* and *ResultSetMetaData.getColumnLabel* before and after IBM Data Server Driver for JDBC and SQLJ Version 4.0 for a table column with a LABEL ON statement in a query with an AS CLAUSE

Target data source	Behavior before IBM Data Server Driver for JDBC and SQLJ Version 4.0		Behavior for IBM Data Server Driver for JDBC and SQLJ Version 4.0 and later	
	getColumnLabel value	getColumnLabel value	getColumnLabel value	getColumnLabel value
DB2 for z/OS Version 8 or later, and DB2 UDB for iSeries V5R3 and later	MYLABEL	LABELONCOL	MYCOL	MYLABEL
DB2 for z/OS Version 7, and DB2 UDB for iSeries V5R2	MYLABEL	LABELONCOL	MYCOL	LABELONCOL

**Example:** On a DB2 for z/OS or DB2 for i data source, a LABEL ON statement is used to define a label for a column:

```
LABEL ON COLUMN MYTABLE.MYCOL IS 'LABELONCOL'
```

The following query contains no AS CLAUSE:

```
SELECT MYCOL FROM MYTABLE
```

The following table lists the *ResultSetMetaData.getColumnLabel* and *ResultSetMetaData.getColumnLabel* values that are returned for the query.

Table 118. *ResultSetMetaData.getColumnLabel* and *ResultSetMetaData.getColumnLabel* before and after IBM Data Server Driver for JDBC and SQLJ Version 4.0 for a table column with a LABEL ON statement in a query with no AS CLAUSE

Target data source	Behavior before IBM Data Server Driver for JDBC and SQLJ Version 4.0		Behavior for IBM Data Server Driver for JDBC and SQLJ Version 4.0	
	getColumnLabel value	getColumnLabel value	getColumnLabel value	getColumnLabel value
DB2 for z/OS Version 8 or later, and DB2 UDB for i5/OS V5R3 and later	MYCOL	LABELONCOL	MYCOL	MYCOL
DB2 for z/OS Version 7, and DB2 UDB for i5/OS V5R2	MYCOL	LABELONCOL	MYLABEL	LABELONCOL

## SDK for Java differences that affect the IBM Data Server Driver for JDBC and SQLJ

Differences in the behavior among versions of the SDK for Java can cause variations in the results that you receive when you run programs under the IBM Data Server Driver for JDBC and SQLJ.

### Retrieved values for DBCS substitution characters

When you retrieve a DBCS substitution character, such as X'FCFC' in code page Cp943, from a database table, the retrieved value differs, depending on whether you are using an IBM SDK for Java or an SDK for Java from Oracle.

For an SDK for Java from Oracle, the substitution character is retrieved as U+0000. For an IBM SDK for Java, the substitution character is retrieved as X'FFFD'.

## Supported code pages

IBM SDKs for Java support more DBCS code pages than SDKs for Java from Oracle. Therefore, if you get errors because of unsupported code pages with an SDK for Java from Oracle, try using an IBM SDK for Java.

## IBM SDK for Java requirement for encryption

The IBM SDKs for Java support 256-bit encryption, but the SDKs for Java from Oracle do not have this support. Therefore, if you use any of the IBM Data Server Driver for JDBC and SQLJ security mechanisms that include encryption, you need to use an IBM SDK for Java.

## Support for system monitoring

Support for system monitoring in the IBM Data Server Driver for JDBC and SQLJ includes collection of core driver time and network I/O time. Retrieval of this information requires capabilities that are in any SDK for Java Version 5 or later. However, the IBM SDK for Java Version 1.4.2 also has support that enables collection of core driver time and network I/O time. If you use the IBM SDK for Java Version 1.4.2, the core driver time and network I/O time are rounded to the nearest microsecond. If you use an SDK for Java Version 5 or later, the core driver time and network I/O time are rounded to the nearest nanosecond.

---

## Error codes issued by the IBM Data Server Driver for JDBC and SQLJ

Error codes in the ranges +4200 to +4299, +4450 to +4499, -4200 to -4299, and -4450 to -4499 are reserved for the IBM Data Server Driver for JDBC and SQLJ.

When you call the `SQLException.getMessage` method after a IBM Data Server Driver for JDBC and SQLJ error occurs, a string is returned that includes:

- Whether the connection is a type 2 or type 4 connection
- Diagnostic information for IBM Software Support
- The level of the driver
- An explanatory message
- The error code
- The SQLSTATE

For example:

```
[jcc][t4][20128][12071][3.50.54] Invalid queryBlockSize specified: 1,048,576,012.  
Using default query block size of 32,767.  ERRORCODE=0, SQLSTATE=
```

Currently, the IBM Data Server Driver for JDBC and SQLJ issues the following error codes:



Table 119. Error codes issued by the IBM Data Server Driver for JDBC and SQLJ

Error Code	Message text and explanation	SQLSTATE
+4204	Errors were encountered and tolerated as specified by the RETURN DATA UNTIL clause.  <b>Explanation:</b> Tolerated errors include federated connection, authentication, and authorization errors. This warning applies only to connections to DB2 Database for Linux, UNIX, and Windows servers. It is issued only when a cursor operation, such as a ResultSet.next or ResultSet.previous call, returns false.	02506
+4222	<i>text-from-getMessage</i>  <b>Explanation:</b> A warning condition occurred during connection to the data source.  <b>User response:</b> Call SQLException.getMessage to retrieve specific information about the problem.	
+4223	<i>text-from-getMessage</i>  <b>Explanation:</b> A warning condition occurred during initialization.  <b>User response:</b> Call SQLException.getMessage to retrieve specific information about the problem.	
+4225	<i>text-from-getMessage</i>  <b>Explanation:</b> A warning condition occurred when data was sent to a server or received from a server.  <b>User response:</b> Call SQLException.getMessage to retrieve specific information about the problem.	
+4226	<i>text-from-getMessage</i>  <b>Explanation:</b> A warning condition occurred during customization or bind.  <b>User response:</b> Call SQLException.getMessage to retrieve specific information about the problem.	
+4228	<i>text-from-getMessage</i>  <b>Explanation:</b> An warning condition occurred that does not fit in another category.  <b>User response:</b> Call SQLException.getMessage to retrieve specific information about the problem.	
+4450	Feature not supported: <i>feature-name</i>	
+4460	<i>text-from-getMessage</i>  <b>Explanation:</b> The specified value is not a valid option.  <b>User response:</b> Call SQLException.getMessage to retrieve specific information about the problem.	



Table 119. Error codes issued by the IBM Data Server Driver for JDBC and SQLJ (continued)

Error Code	Message text and explanation	SQLSTATE
+4461	<i>text-from-getMessage</i>  <b>Explanation:</b> The specified value is invalid or out of range.  <b>User response:</b> Call SQLException.getMessage to retrieve specific information about the problem.	
+4462	<i>text-from-getMessage</i>  <b>Explanation:</b> A required value is missing.  <b>User response:</b> Call SQLException.getMessage to retrieve specific information about the problem.	
+4470	<i>text-from-getMessage</i>  <b>Explanation:</b> The requested operation cannot be performed because the target resource is closed.  <b>User response:</b> Call SQLException.getMessage to retrieve specific information about the problem.	
+4471	<i>text-from-getMessage</i>  <b>Explanation:</b> The requested operation cannot be performed because the target resource is in use.  <b>User response:</b> Call SQLException.getMessage to retrieve specific information about the problem.	
+4472	<i>text-from-getMessage</i>  <b>Explanation:</b> The requested operation cannot be performed because the target resource is unavailable.  <b>User response:</b> Call SQLException.getMessage to retrieve specific information about the problem.	
+4474	<i>text-from-getMessage</i>  <b>Explanation:</b> The requested operation cannot be performed because the target resource cannot be changed.  <b>User response:</b> Call SQLException.getMessage to retrieve specific information about the problem.	
-4200	Invalid operation: An invalid COMMIT or ROLLBACK has been called in an XA environment during a Global Transaction.  <b>Explanation:</b> An application that was in a global transaction in an XA environment issued a commit or rollback. A commit or rollback operation in a global transaction is invalid.	2D521
-4201	Invalid operation: setAutoCommit(true) is not allowed during Global Transaction.  <b>Explanation:</b> An application that was in a global transaction in an XA environment executed the setAutoCommit(true) statement. Issuing setAutoCommit(true) in a global transaction is invalid.	2D521

Table 119. Error codes issued by the IBM Data Server Driver for JDBC and SQLJ (continued)

Error Code	Message text and explanation	SQLSTATE
-4203	<p>Error executing <i>function</i>. Server returned <i>rc</i>.</p> <p>: An error occurred on an XA connection during execution of an SQL statement.</p> <p>For network optimization, the IBM Data Server Driver for JDBC and SQLJ delays some XA flows until the next SQL statement is executed. If an error occurs in a delayed XA flow, that error is reported as part of the SQLException that is thrown by the current SQL statement.</p>	
-4210	Timeout getting a transport object from pool.	57033
-4211	Timeout getting an object from pool.	57033
-4212	Sysplex member unavailable.	
-4213	Timeout.	57033
-4214	<p><i>text-from-getMessage</i></p> <p><b>Explanation:</b> Authorization failed.</p> <p><b>User response:</b> Call SQLException.getMessage to retrieve specific information about the problem.</p>	28000
-4220	<p><i>text-from-getMessage</i></p> <p><b>Explanation:</b> An error occurred during character conversion.</p> <p><b>User response:</b> Call SQLException.getMessage to retrieve specific information about the problem.</p>	
-4221	<p><i>text-from-getMessage</i></p> <p><b>Explanation:</b> An error occurred during encryption or decryption.</p> <p><b>User response:</b> Call SQLException.getMessage to retrieve specific information about the problem.</p>	
-4222	<p><i>text-from-getMessage</i></p> <p><b>Explanation:</b> An error occurred during connection to the data source.</p> <p><b>User response:</b> Call SQLException.getMessage to retrieve specific information about the problem.</p>	
-4223	<p><i>text-from-getMessage</i></p> <p><b>Explanation:</b> An error occurred during initialization.</p> <p><b>User response:</b> Call SQLException.getMessage to retrieve specific information about the problem.</p>	
-4224	<p><i>text-from-getMessage</i></p> <p><b>Explanation:</b> An error occurred during resource cleanup.</p> <p><b>User response:</b> Call SQLException.getMessage to retrieve specific information about the problem.</p>	

Table 119. Error codes issued by the IBM Data Server Driver for JDBC and SQLJ (continued)

Error Code	Message text and explanation	SQLSTATE
-4225	<i>text-from-getMessage</i>  <b>Explanation:</b> An error occurred when data was sent to a server or received from a server.  <b>User response:</b> Call <code>SQLException.getMessage</code> to retrieve specific information about the problem.	
-4226	<i>text-from-getMessage</i>  <b>Explanation:</b> An error occurred during customization or bind.  <b>User response:</b> Call <code>SQLException.getMessage</code> to retrieve specific information about the problem.	
-4227	<i>text-from-getMessage</i>  <b>Explanation:</b> An error occurred during reset.  <b>User response:</b> Call <code>SQLException.getMessage</code> to retrieve specific information about the problem.	
-4228	<i>text-from-getMessage</i>  <b>Explanation:</b> An error occurred that does not fit in another category.  <b>User response:</b> Call <code>SQLException.getMessage</code> to retrieve specific information about the problem.	
-4229	<i>text-from-getMessage</i>  <b>Explanation:</b> An error occurred during a batch execution.  <b>User response:</b> Call <code>SQLException.getMessage</code> to retrieve specific information about the problem.	
-4231	An error occurred during the conversion of column <i>column-number</i> of type <i>sql-data-type</i> with value <i>value</i> to a value of type <code>java.math.BigDecimal</code> .	
-4450	Feature not supported: <i>feature-name</i>	0A504
-4460	<i>text-from-getMessage</i>  <b>Explanation:</b> The specified value is not a valid option.  <b>User response:</b> Call <code>SQLException.getMessage</code> to retrieve specific information about the problem.	
-4461	<i>text-from-getMessage</i>  <b>Explanation:</b> The specified value is invalid or out of range.  <b>User response:</b> Call <code>SQLException.getMessage</code> to retrieve specific information about the problem.	42815

Table 119. Error codes issued by the IBM Data Server Driver for JDBC and SQLJ (continued)

Error Code	Message text and explanation	SQLSTATE
-4462	<i>text-from-getMessage</i>  <b>Explanation:</b> A required value is missing.  <b>User response:</b> Call <code>SQLException.getMessage</code> to retrieve specific information about the problem.	
-4463	<i>text-from-getMessage</i>  <b>Explanation:</b> The specified value has a syntax error.  <b>User response:</b> Call <code>SQLException.getMessage</code> to retrieve specific information about the problem.	42601
-4470	<i>text-from-getMessage</i>  <b>Explanation:</b> The requested operation cannot be performed because the target resource is closed.  <b>User response:</b> Call <code>SQLException.getMessage</code> to retrieve specific information about the problem.	
-4471	<i>text-from-getMessage</i>  <b>Explanation:</b> The requested operation cannot be performed because the target resource is in use.  <b>User response:</b> Call <code>SQLException.getMessage</code> to retrieve specific information about the problem.	
-4472	<i>text-from-getMessage</i>  <b>Explanation:</b> The requested operation cannot be performed because the target resource is unavailable.  <b>User response:</b> Call <code>SQLException.getMessage</code> to retrieve specific information about the problem.	
-4473	<i>text-from-getMessage</i>  <b>Explanation:</b> The requested operation cannot be performed because the target resource is no longer available.  <b>User response:</b> Call <code>SQLException.getMessage</code> to retrieve specific information about the problem.	
-4474	<i>text-from-getMessage</i>  <b>Explanation:</b> The requested operation cannot be performed because the target resource cannot be changed.  <b>User response:</b> Call <code>SQLException.getMessage</code> to retrieve specific information about the problem.	
-4475	<i>text-from-getMessage</i>  <b>Explanation:</b> The requested operation cannot be performed because access to the target resource is restricted.  <b>User response:</b> Call <code>SQLException.getMessage</code> to retrieve specific information about the problem.	

Table 119. Error codes issued by the IBM Data Server Driver for JDBC and SQLJ (continued)

Error Code	Message text and explanation	SQLSTATE
-4476	<p><i>text-from-getMessage</i></p> <p><b>Explanation:</b> The requested operation cannot be performed because the operation is not allowed on the target resource.</p> <p><b>User response:</b> Call <code>SQLException.getMessage</code> to retrieve specific information about the problem.</p>	
-4496	An SQL OPEN for a held cursor was issued on an XA connection. The JDBC driver does not allow a held cursor to be opened on the database server for an XA connection.	
-4497	The application must issue a rollback. The unit of work has already been rolled back in the DB2 server, but other resource managers involved in the unit of work might not have rolled back their changes. To ensure integrity of the application, all SQL requests are rejected until the application issues a rollback.	
-4498	<p>A connection failed but has been reestablished. Host name or IP address: <i>host-name</i>, service name or port number: <i>port</i>, special register modification indicator: <i>rc</i>.</p> <p><b>Explanation:</b> <i>host-name</i> and <i>port</i> indicate the data source at which the connection is reestablished. <i>rc</i> indicates whether SQL statements that set special register values were executed again:</p> <ol style="list-style-type: none"> <li>1 SQL statements that set special register values were executed again.</li> <li>2 SQL statements that set special register values might not have been executed again.</li> </ol> <p>For client reroute against DB2 for z/OS servers, special register values that were set after the last commit point are not re-established.</p> <p>The application is rolled back to the previous commit point. The connection state and global resources such as global temporary tables and open held cursors might not be maintained.</p>	
-4499	<p><i>text-from-getMessage</i></p> <p><b>Explanation:</b> A fatal error occurred that resulted in a disconnect from the data source. The existing connection has become unusable.</p> <p><b>User response:</b> Call <code>SQLException.getMessage</code> to retrieve specific information about the problem.</p>	08001 or 58009
-30108	Client reroute exception for the Sysplex.	08506
-99999	The IBM Data Server Driver for JDBC and SQLJ issued an error that does not yet have an error code.	

## SQLSTATEs issued by the IBM Data Server Driver for JDBC and SQLJ

SQLSTATEs in the range 46600 to 466ZZ are reserved for the IBM Data Server Driver for JDBC and SQLJ.

The following table lists the SQLSTATEs that are generated or used by the IBM Data Server Driver for JDBC and SQLJ.

*Table 120. SQLSTATEs returned by the IBM Data Server Driver for JDBC and SQLJ*

SQLSTATE class	SQLSTATE	Description
01xxx		Warning
02xxx		No data
02xxx	02501	The cursor position is not valid for a FETCH of the current row.
02xxx	02506	Tolerable error
08xxx		Connection exception
08xxx	08001	The application requester is unable to establish the connection.
08xxx	08003	A connection does not exist
08xxx	08004	The application server rejected establishment of the connection
08xxx	08506	Client reroute exception
0Axxx		Feature not supported
0Axxx	0A502	The action or operation is not enabled for this database instance
0Axxx	0A504	The feature is not supported by the driver
22xxx		Data exception
22xxx	22007	The string representation of a datetime value is invalid
22xxx	22021	A character is not in the coded character set
23xxx		Constraint violation
23xxx	23502	A value that is inserted into a column or updates a column is null, but the column cannot contain null values.
24xxx		Invalid cursor state
24xxx	24501	The identified cursor is not open
28xxx		Authorization exception
28xxx	28000	Authorization name is invalid.
2Dxxx		Invalid transaction termination
2Dxxx	2D521	SQL COMMIT or ROLLBACK are invalid in the current operating environment.
34xxx		Invalid cursor name
34xxx	34000	Cursor name is invalid.
3Bxxx		Invalid savepoint
3Bxxx	3B503	A SAVEPOINT, RELEASE SAVEPOINT, or ROLLBACK TO SAVEPOINT statement is not allowed in a trigger or global transaction.
40xxx		Transaction rollback

Table 120. SQLSTATEs returned by the IBM Data Server Driver for JDBC and SQLJ (continued)

SQLSTATE class	SQLSTATE	Description
42xxx		Syntax error or access rule violation
42xxx	42601	A character, token, or clause is invalid or missing
42xxx	42734	A duplicate parameter name, SQL variable name, cursor name, condition name, or label was detected.
42xxx	42807	The INSERT, UPDATE, or DELETE is not permitted on this object
42xxx	42808	A column identified in the insert or update operation is not updateable
42xxx	42815	The data type, length, scale, value, or CCSID is invalid
42xxx	42820	A numeric constant is too long, or it has a value that is not within the range of its data type
42xxx	42968	The connection failed because there is no current software license.
57xxx		Resource not available or operator intervention
57xxx	57033	A deadlock or timeout occurred without automatic rollback
58xxx		System error
58xxx	58008	Execution failed due to a distribution protocol error that will not affect the successful execution of subsequent DDM commands or SQL statements
58xxx	58009	Execution failed due to a distribution protocol error that caused deallocation of the conversation
58xxx	58012	The bind process with the specified package name and consistency token is not active
58xxx	58014	The DDM command is not supported
58xxx	58015	The DDM object is not supported
58xxx	58016	The DDM parameter is not supported
58xxx	58017	The DDM parameter value is not supported

## How to find IBM Data Server Driver for JDBC and SQLJ version and environment information

To determine the version of the IBM Data Server Driver for JDBC and SQLJ, as well as information about the environment in which the driver is running, run the DB2Jcc utility on the command line.

### DB2Jcc syntax

```

▶▶ java -com.ibm.db2.jcc.DB2Jcc [__version] [__configuration] [__help]

```

## DB2Jcc option descriptions

### -version

Specifies that the IBM Data Server Driver for JDBC and SQLJ displays its name and version.

### -configuration

Specifies that the IBM Data Server Driver for JDBC and SQLJ displays its name and version, and information about its environment, such as information about the Java runtime environment, operating system, path information, and license restrictions.

### -help

Specifies that the DB2Jcc utility describes each of the options that it supports. If any other options are specified with -help, they are ignored.

---

## Commands for SQLJ program preparation

To prepare SQLJ programs for execution, you use commands to translate SQLJ source code into Java source code, compile the Java source code, create and customize SQLJ serialized profiles, and bind DB2 packages.

### sqlj - SQLJ translator

The sqlj command translates an SQLJ source file into a Java source file and zero or more SQLJ serialized profiles. By default, the sqlj command also compiles the Java source file.

#### Authorization

None

#### Command syntax

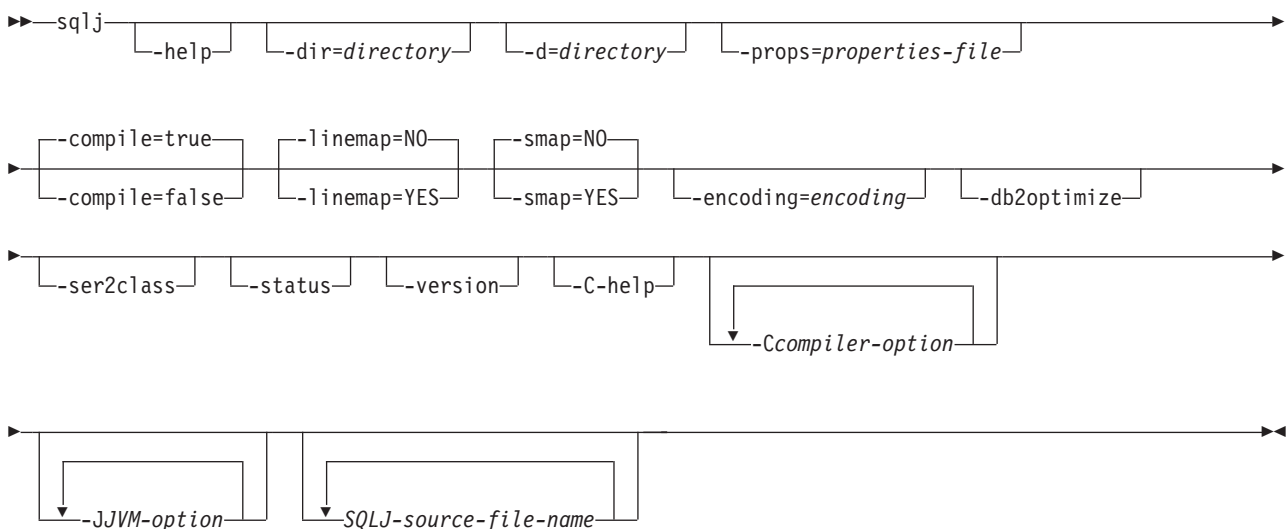



## Command parameters

### **-help**

Specifies that the SQLJ translator describes each of the options that the translator supports. If any other options are specified with `-help`, they are ignored.

### **-dir=directory**

Specifies the name of the directory into which SQLJ puts `.java` files that are generated by the translator and `.class` files that are generated by the compiler. The default is the directory that contains the SQLJ source files.

The translator uses the directory structure of the SQLJ source files when it puts the generated files in directories. For example, suppose that you want the translator to process two files:

- `file1.sqlj`, which is not in a Java package
- `file2.sqlj`, which is in Java package `sqlj.test`

Also suppose that you specify the parameter `-dir=/src` when you invoke the translator. The translator puts the Java source file for `file1.sqlj` in directory `/src` and puts the Java source file for `file2.sqlj` in directory `/src/sqlj/test`.

### **-d=directory**

Specifies the name of the directory into which SQLJ puts the binary files that are generated by the translator and compiler. These files include the `.ser` files, the `name_SJProfileKeys.class` files, and the `.class` files that are generated by the compiler.

The default is the directory that contains the SQLJ source files.

The translator uses the directory structure of the SQLJ source files when it puts the generated files in directories. For example, suppose that you want the translator to process two files:

- `file1.sqlj`, which is not in a Java package
- `file2.sqlj`, which is in Java package `sqlj.test`

Also suppose that you specify the parameter `-d=/src` when you invoke the translator. The translator puts the serialized profiles for `file1.sqlj` in directory `/src` and puts the serialized profiles for `file2.sqlj` in directory `/src/sqlj/test`.

### **-compile=true|false**

Specifies whether the SQLJ translator compiles the generated Java source into bytecodes.

#### **true**

The translator compiles the generated Java source code. This is the default.

#### **false**

The translator does not compile the generated Java source code.

### **-linemap=no|yes**

Specifies whether line numbers in Java exceptions match line numbers in the SQLJ source file (the `.sqlj` file), or line numbers in the Java source file that is generated by the SQLJ translator (the `.java` file).

**no** Line numbers in Java exceptions match line numbers in the Java source file. This is the default.

#### **yes**

Line numbers in Java exceptions match line numbers in the SQLJ source file.

**-smap=no|yes**

Specifies whether the SQLJ translator generates a source map (SMAP) file for each SQLJ source file. An SMAP file is used by some Java language debug tools. This file maps lines in the SQLJ source file to lines in the Java source file that is generated by the SQLJ translator. The file is in the Unicode UTF-8 encoding scheme. Its format is described by Original Java Specification Request (JSR) 45, which is available from this web site:

<http://www.jcp.org>

**no** Do not generated SMAP files. This is the default.

**yes**

Generate SMAP files. An SMAP file name is *SQLJ-source-file-name.java.smap*. The SQLJ translator places the SMAP file in the same directory as the generated Java source file.

**-encoding=encoding-name**

Specifies the encoding of the source file. Examples are JIS or EUC. If this option is not specified, the default converter for the operating system is used.

**-db2optimize**

Specifies that the SQLJ translator generates code that enables SQLJ context caching in a WebSphere Application Server environment for applications that run against DB2 data servers.

-db2optimize causes a user-defined context to extend a custom driver class, which enables context caching and connection caching in WebSphere Application Server.

Because context caching is enabled by using an instance of IBM Data Server Driver for JDBC and SQLJ class `sqlj.runtime.ref.DefaultContext`, `db2jcc.jar` must be in the CLASSPATH when you translate and compile the Java application.

You cannot use connection sharing in WebSphere Application Server if you use context caching.

**Important:** Context caching that is enabled by the -db2optimize option can provide performance benefits over connection pooling and statement pooling that is provided by WebSphere Application Server. However, context caching can result in significant resource consumption in the application server, and might have unintended side effects if it is not used correctly. For example, if two applications use an SQLJ profile with the same name, they might overwrite each other, because both use `sqlj.runtime.ref.DefaultContext`. Use context caching only if:

- The system is not storage-constrained.
- Cached statements are often reused on the same Connection.
- All applications have distinct names for their SQLJ profiles.

**-ser2class**

Specifies that the SQLJ translator converts .ser files to .class files.

**-status**

Specifies that the SQLJ translator displays status messages as it runs.

**-version**

Specifies that the SQLJ translator displays the version of the IBM Data Server Driver for JDBC and SQLJ. The information is in this form:

IBM SQLJ xxxx.xxxx.xx

**-C-help**

Specifies that the SQLJ translator displays help information for the Java compiler.

**-Ccompiler-option**

Specifies a valid Java compiler option that begins with a dash (-). Do not include spaces between -C and the compiler option. If you need to specify multiple compiler options, precede each compiler option with -C. For example:

```
-C-g -C-verbose
```

All options are passed to the Java compiler and are not used by the SQLJ translator, **except** for the following options:

**-classpath**

Specifies the user class path that is to be used by the SQLJ translator and the Java compiler. This value overrides the CLASSPATH environment variable.

**-sourcepath**

Specifies the source code path that the SQLJ translator and the Java compiler search for class or interface definitions. The SQLJ translator searches for .sqlj and .java files only in directories, not in JAR or zip files.

**-JVM-option**

Specifies an option that is to be passed to the Java virtual machine (JVM) in which the sqlj command runs. The option must be a valid JVM option that begins with a dash (-). Do not include spaces between -J and the JVM option. If you need to specify multiple JVM options, precede each compiler option with -J. For example:

```
-J-Xmx128m -J-Xmine2M
```

**SQLJ-source-file-name**

Specifies a list of SQLJ source files to be translated. This is a required parameter. All SQLJ source file names must have the extension .sqlj.

**Output**

For each source file, *program-name.sqlj*, the SQLJ translator produces the following files:

- The generated source program  
The generated source file is named *program-name.java*.
- A serialized profile file for each connection context class that is used in an SQLJ executable clause

A serialized profile name is of the following form:

```
program-name_SJProfileIDNumber.ser
```

- If the SQLJ translator invokes the Java compiler, the class files that the compiler generates.

**Examples**

```
sqlj -encoding=UTF8 -C-0 MyApp.sqlj
```

**db2sqljcustomize - SQLJ profile customizer**

db2sqljcustomize processes an SQLJ profile, which contains embedded SQL statements.

By default, db2sqljcustomize produces four DB2 packages: one for each isolation level. db2sqljcustomize augments the profile with DB2-specific information for use at run time.

## Authorization

The privilege set of the process must include one of the following authorities:

- DBADM authority
- If the package does not exist, the BINDADD privilege, and one of the following privileges:
  - CREATEIN privilege
  - IMPLICIT\_SCHEMA authority on the database if the schema name of the package does not exist
- If the package exists:
  - ALTERIN privilege on the schema
  - BIND privilege on the package

The user also needs all privileges that are required to compile any static SQL statements in the application. Privileges that are granted to groups are not used for authorization checking of static statements.

## Command syntax

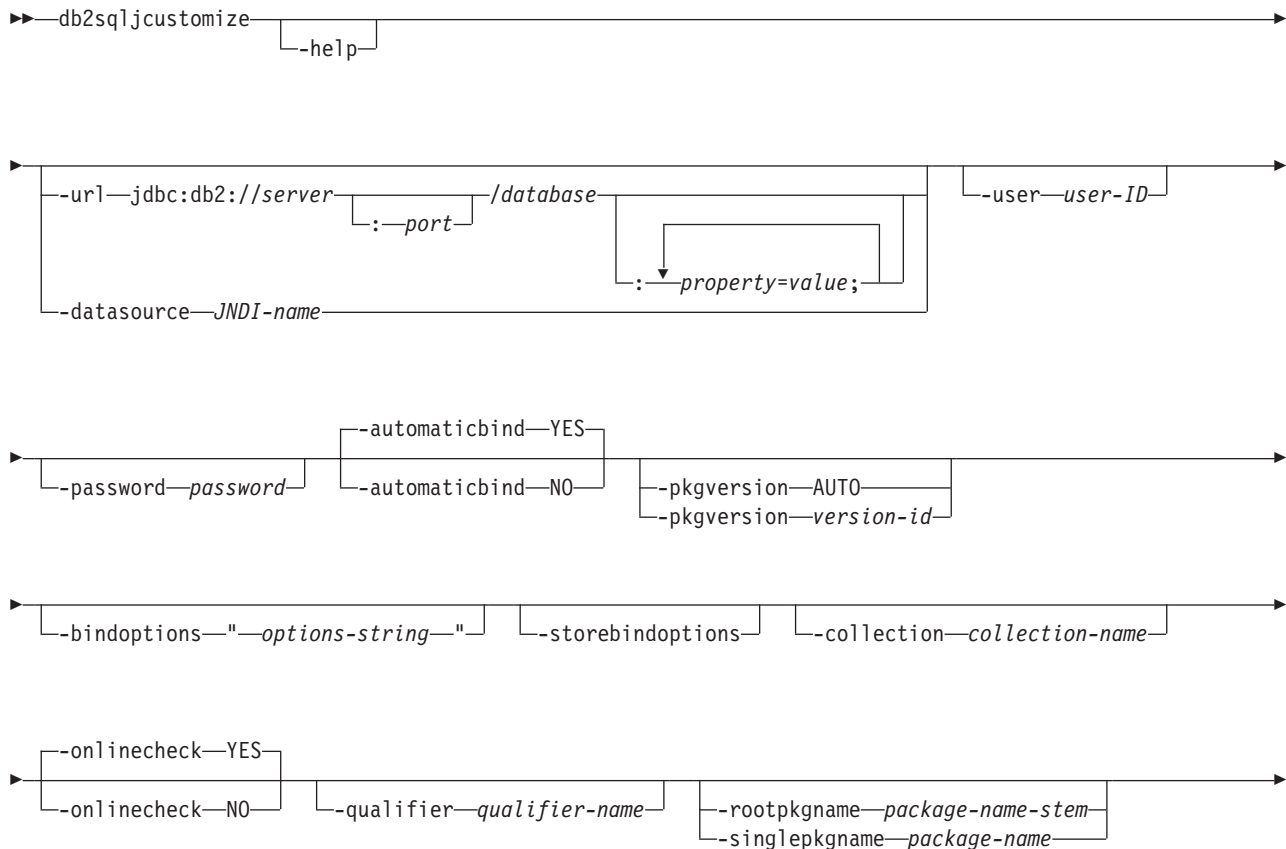

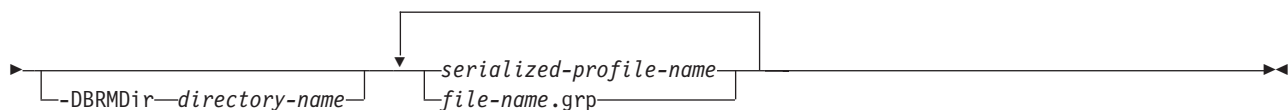
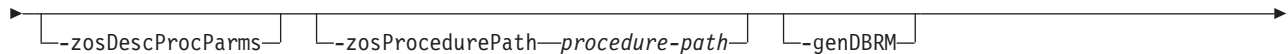
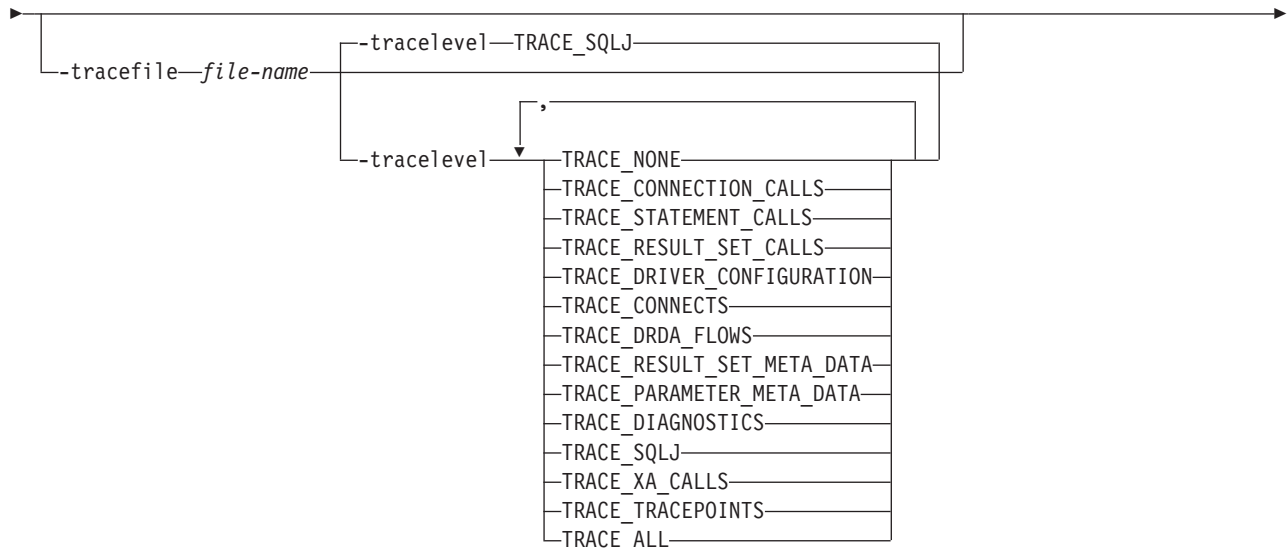

**options-string:**

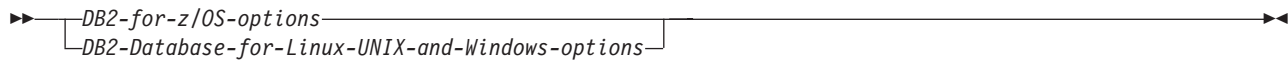

**DB2 for z/OS options:**

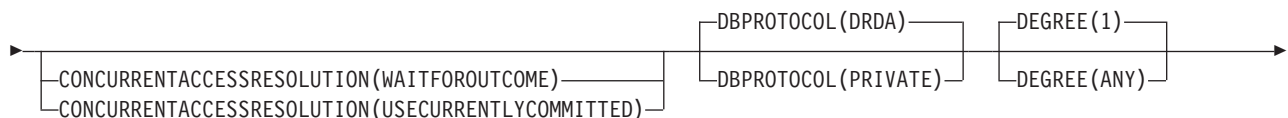
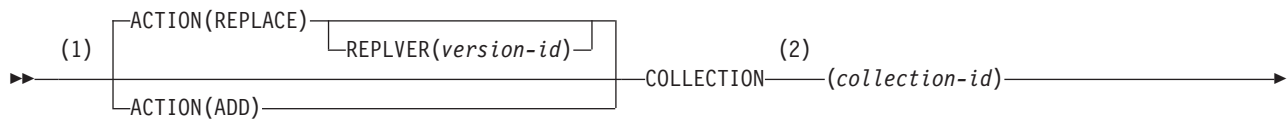

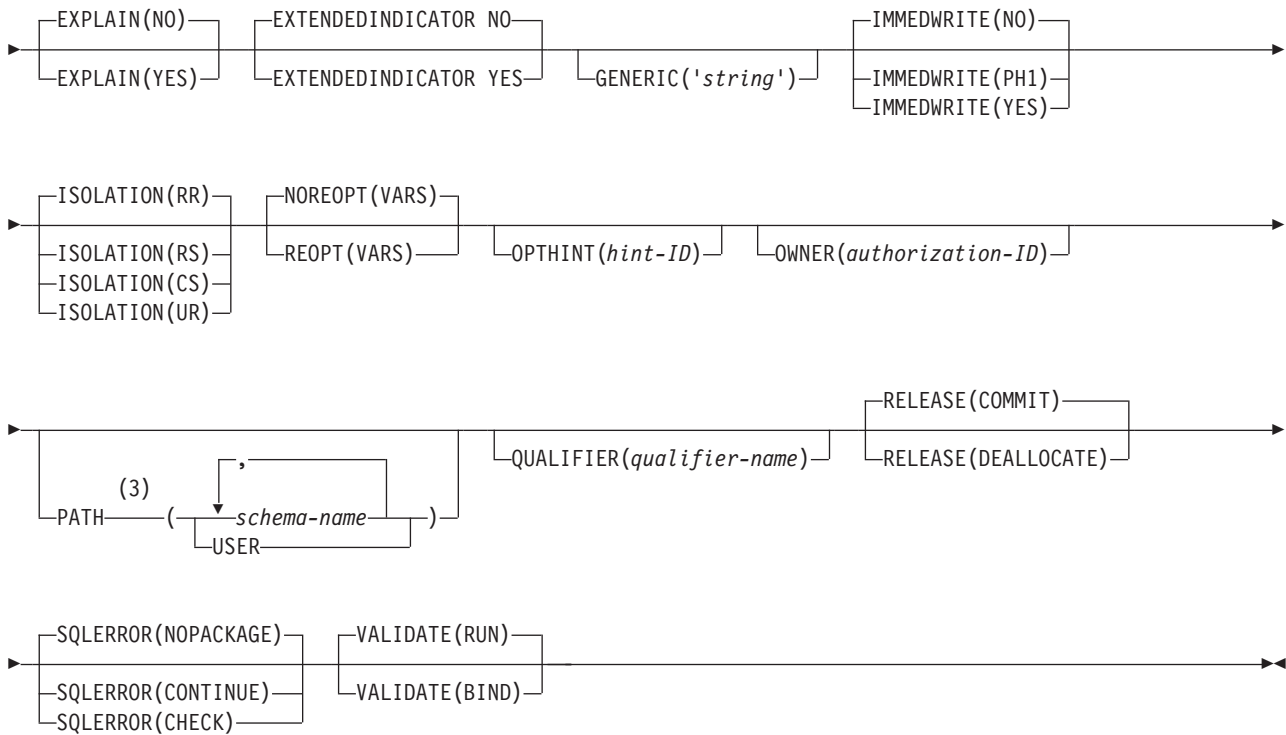

**Notes:**

- 1 These options can be specified in any order.
- 2 COLLECTION is not a valid BIND option for DB2 for z/OS. However, COLLECTION can be specified as a -bindoptions argument in db2sqljcustomize or db2sqljbind, to change the collection at bind time, or to bind the same serialized profile file into multiple collections.
- 3 FUNCPATH can be specified as an alias for PATH.

**DB2 Database for Linux, UNIX, and Windows options:**

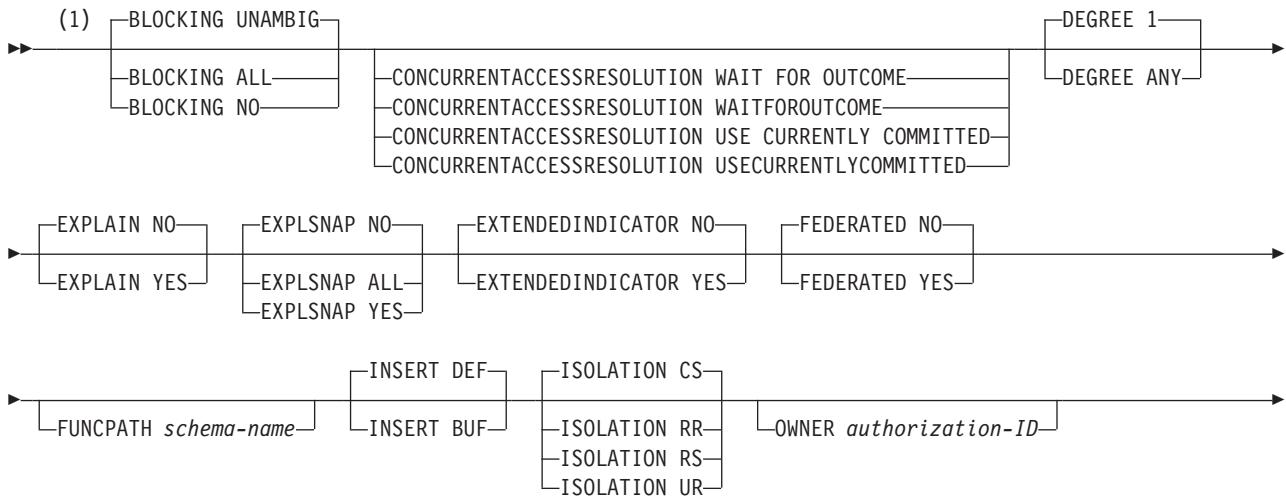

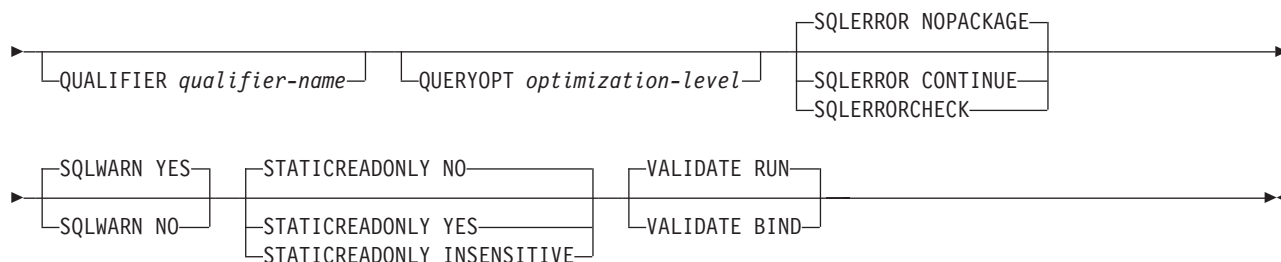

**Notes:**

- 1 These options can be specified in any order.

**Command parameters**

**-help**

Specifies that the SQLJ customizer describes each of the options that the customizer supports. If any other options are specified with `-help`, they are ignored.

**-url**

Specifies the URL for the data source for which the profile is to be customized. A connection is established to the data source that this URL represents if the `-automaticbind` or `-onlinecheck` option is specified as YES or defaults to YES. The variable parts of the `-url` value are:

**server**

The domain name or IP address of the z/OS system on which the DB2 subsystem resides.

**port**

The TCP/IP server port number that is assigned to the DB2 subsystem. The default is 446.

**-url**

Specifies the URL for the data source for which the profile is to be customized. A connection is established to the data source that this URL represents if the `-automaticbind` or `-onlinecheck` option is specified as YES or defaults to YES. The variable parts of the `-url` value are:

**server**

The domain name or IP address of the operating system on which the database server resides.

**port**

The TCP/IP server port number that is assigned to the database server. The default is 446.

**database**

A name for the database server for which the profile is to be customized.

If the connection is to a DB2 for z/OS server, *database* is the DB2 location name that is defined during installation. All characters in this value must be uppercase characters. You can determine the location name by executing the following SQL statement on the server:

```
SELECT CURRENT SERVER FROM SYSIBM.SYSDUMMY1;
```

If the connection is to a DB2 Database for Linux, UNIX, and Windows server, *database* is the database name that is defined during installation.

If the connection is to an IBM Cloudscape server, the *database* is the fully-qualified name of the file that contains the database. This name must be enclosed in double quotation marks (""). For example:

```
"c:/databases/testdb"
```

```
property=value;
```

A property for the JDBC connection.

```
property=value;
```

A property for the JDBC connection.

**-datasource** *JNDI-name*

Specifies the logical name of a DataSource object that was registered with JNDI. The DataSource object represents the data source for which the profile is to be customized. A connection is established to the data source if the `-automaticbind` or `-onlinecheck` option is specified as YES or defaults to YES. Specifying `-datasource` is an alternative to specifying `-url`. The DataSource object must represent a connection that uses IBM Data Server Driver for JDBC and SQLJ type 4 connectivity.

**-user** *user-ID*

Specifies the user ID to be used to connect to the data source for online checking or binding a package. You must specify `-user` if you specify `-url`. You must specify `-user` if you specify `-datasource`, and the DataSource object that *JNDI-name* represents does not contain a user ID.

**-password** *password*

Specifies the password to be used to connect to the data source for online checking or binding a package. You must specify `-password` if you specify `-url`. You must specify `-password` if you specify `-datasource`, and the DataSource object that *JNDI-name* represents does not contain a password.

**-automaticbind** YES|NO

Specifies whether the customizer binds DB2 packages at the data source that is specified by the `-url` parameter.

The default is YES.

The number of packages and the isolation levels of those packages are controlled by the `-rootpkgname` and `-singlepkgname` options.

Before the bind operation can work, the following conditions need to be met:

- TCP/IP and DRDA must be installed at the target data source.
- Valid `-url`, `-username`, and `-password` values must be specified.
- The `-username` value must have authorization to bind a package at the target data source.

**-pkgversion** AUTO|*version-id*

Specifies the package version that is to be used when packages are bound at the server for the serialized profile that is being customized. `db2sqljcustomize` stores the version ID in the serialized profile and in the DB2 package. Run-time version verification is based on the consistency token, not the version name. To automatically generate a version name that is based on the consistency token, specify `-pkgversion AUTO`.

The default is that there is no version.

**-bindoptions** *options-string*

Specifies a list of options, separated by spaces. These options have the same function as DB2 precompile and bind options with the same names. If you are preparing your program to run on a DB2 for z/OS system, specify DB2 for



z/OS options. If you are preparing your program to run on a DB2 Database for Linux, UNIX, and Windows system, specify DB2 Database for Linux, UNIX, and Windows options.

**Notes on bind options:**

- Specify ISOLATION only if you also specify the `-singlepkgname` option.
- The value for `STATICREADONLY` is YES for servers that support `STATICREADONLY`, and NO for other servers. When you specify `STATICREADONLY YES`, DB2 processes ambiguous cursors as if they were read-only cursors. For troubleshooting iterator declaration errors, you need to explicitly specify `STATICREADONLY NO`, or declare iterators so that they are unambiguous. For example, if you want an iterator to be unambiguously updatable, declare the iterator to implement `sqlj.runtime.ForUpdate`. If you want an iterator to be read-only, include the `FOR READ ONLY` clause in `SELECT` statements that use the iterator.

**Important:** Specify only those program preparation options that are appropriate for the data source at which you are binding a package. Some values and defaults for the IBM Data Server Driver for JDBC and SQLJ are different from the values and defaults for DB2.

**-storebindoptions**

Specifies that values for the `-bindoptions` and `-staticpositioned` parameters are stored in the serialized profile. If `db2sqljbind` is invoked without the `-bindoptions` or `-staticpositioned` parameter, the values that are stored in the serialized profile are used during the bind operation. When multiple serialized profiles are specified for one invocation of `db2sqljcustomize`, the parameter values are stored in each serialized profile. The stored values are displayed in the output from the `db2sqljprint` utility.

**-collection *collection-name***

The qualifier for the packages that `db2sqljcustomize` binds. `db2sqljcustomize` stores this value in the customized serialized profile, and it is used when the associated packages are bound. If you do not specify this parameter, `db2sqljcustomize` uses a collection ID of `NULLID`.

**-onlinecheck YES|NO**

Specifies whether online checking of data types in the SQLJ program is to be performed. The `-url` or `-datasource` option determines the data source that is to be used for online checking. The default is YES if the `-url` or `-datasource` parameter is specified. Otherwise, the default is NO.

**-qualifier *qualifier-name***

Specifies the qualifier that is to be used for unqualified objects in the SQLJ program during online checking. This value is not used as the qualifier when the packages are bound.

**-rootpkgname|-singlepkgname**

Specifies the names for the packages that are associated with the program. If `-automaticbind` is NO, these package names are used when `db2sqljbind` runs. The meanings of the parameters are:

**-rootpkgname *package-name-stem***

Specifies that the customizer creates four packages, one for each of the four DB2 isolation levels. The names for the four packages are:

*package-name-stem1*

For isolation level UR

*package-name-stem2*  
For isolation level CS

*package-name-stem3*  
For isolation level RS

*package-name-stem4*  
For isolation level RR

If `-longpkgnme` is not specified, *package-name-stem* must be an alphanumeric string of seven or fewer bytes.

If `-longpkgnme` is specified, *package-name-stem* must be an alphanumeric string of 127 or fewer bytes.

**-singlepkgnme** *package-name*

Specifies that the customizer creates one package, with the name *package-name*. If you specify this option, your program can run at only one isolation level. You specify the isolation level for the package by specifying the ISOLATION option in the `-bindoptions` options string.

If `-longpkgnme` is not specified, *package-name* must be an alphanumeric string of eight or fewer bytes.

If `-longpkgnme` is specified, *package-name* must be an alphanumeric string of 128 or fewer bytes.

Using the `-singlepkgnme` option is not recommended.

**Recommendation:** If the target data source is DB2 for z/OS, use uppercase characters for the *package-name-stem* or *package-name* value. DB2 for z/OS systems that are defined with certain CCSID values cannot tolerate lowercase characters in package names or collection names.

If you do not specify `-rootpkgnme` or `-singlepkgnme`, `db2sqljcustomize` generates four package names that are based on the serialized profile name. A serialized profile name is of the following form:

*program-name\_SJProfileIDNumber.ser*

The four generated package names are of the following form:

*Bytes-from-program-nameIDNumberPkgIsolation*

Table 121 shows the parts of a generated package name and the number of bytes for each part.

The maximum length of a package name is *maxlen*. *maxlen* is 8 if `-longpkgnme` is not specified. *maxlen* is 128 if `-longpkgnme` is specified.

Table 121. Parts of a package name that is generated by `db2sqljcustomize`

Package name part	Number of bytes	Value
<i>Bytes-from-program-name</i>	$m = \min(\text{Length}(\text{program-name}), \text{maxlen} - 1 - \text{Length}(\text{IDNumber}))$	First <i>m</i> bytes of <i>program-name</i> , in uppercase
<i>IDNumber</i>	$\text{Length}(\text{IDNumber})$	<i>IDNumber</i>
<i>PkgIsolation</i>	1	1, 2, 3, or 4. This value represents the transaction isolation level for the package. See Table 122 on page 575.

Table 122 on page 575 shows the values of the *PkgIsolation* portion of a package name that is generated by `db2sqljcustomize`.

Table 122. PkgIsolation values and associated isolation levels

PkgNumber value	Isolation level for package
1	Uncommitted read (UR)
2	Cursor stability (CS)
3	Read stability (RS)
4	Repeatable read (RR)

*Example:* Suppose that a profile name is ThisIsMyProg\_SJProfile111.ser. The db2sqljcustomize option -longpkgname is not specified. Therefore, *Bytes-from-program-name* is the first four bytes of ThisIsMyProg, translated to uppercase, or THIS. *IDNumber* is 111. The four package names are:

```
THIS1111
THIS1112
THIS1113
THIS1114
```

*Example:* Suppose that a profile name is ThisIsMyProg\_SJProfile111.ser. The db2sqljcustomize option -longpkgname is specified. Therefore, *Bytes-from-program-name* is ThisIsMyProg, translated to uppercase, or THISISMYPROG. *IDNumber* is 111. The four package names are:

```
THISISMYPROG1111
THISISMYPROG1112
THISISMYPROG1113
THISISMYPROG1114
```

*Example:* Suppose that a profile name is A\_SJProfile0.ser. *Bytes-from-program-name* is A. *IDNumber* is 0. Therefore, the four package names are:

```
A01
A02
A03
A04
```

Letting db2sqljcustomize generate package names is not recommended. If any generated package names are the same as the names of existing packages, db2sqljcustomize overwrites the existing packages. To ensure uniqueness of package names, specify -rootpkgname.

#### **-longpkgname**

Specifies that the names of the DB2 packages that db2sqljcustomize generates can be up to 128 bytes. Use this option only if you are binding packages at a server that supports long package names. If you specify -singlepkgname or -rootpkgname, you must also specify -longpkgname under the following conditions:

- The argument of -singlepkgname is longer than eight bytes.
- The argument of -rootpkgname is longer than seven bytes.

#### **-staticpositioned NO|YES**

For iterators that are declared in the same source file as positioned UPDATE statements that use the iterators, specifies whether the positioned UPDATES are executed as statically bound statements. The default is NO. NO means that the positioned UPDATES are executed as dynamically prepared statements.

#### **-zosDescProcParms**

Specifies that db2sqljcustomize queries the DB2 catalog at the target data source to determine the SQL parameter data types that correspond to the host variables in CALL statements.

`-zosDescProcParms` applies only to programs that run on DB2 for z/OS data servers.

If `-zosDescProcParms` is specified, and the authorization ID under which `db2sqljcustomize` runs does not have read access to the `SYSIBM.SYSROUTINES` catalog table, `db2sqljcustomize` returns an error and uses the host variable data types in the `CALL` statements to determine the SQL data types.

Specification of `-zosDescProcParms` can lead to more efficient storage usage at run time. If SQL data type information is available, SQLJ has information about the length and precision of `INOUT` and `OUT` parameters, so it allocates only the amount of memory that is needed for those parameters. Availability of SQL data type information can have the biggest impact on storage usage for character `INOUT` parameters, `LOB OUT` parameters, and decimal `OUT` parameters.

When `-zosDescProcParms` is specified, the DB2 data server uses the specified or default value of `-zosProcedurePath` to resolve unqualified names of stored procedures for which SQL data type information is requested.

If `-zosDescProcParms` is not specified, `db2sqljcustomize` uses the host variable data types in the `CALL` statements to determine the SQL data types. If `db2sqljcustomize` determines the wrong SQL data type, an SQL error might occur at run time. For example, if the Java host variable type is `String`, and the corresponding stored procedure parameter type is `VARCHAR FOR BIT DATA`, an SQL run-time error such as `-4220` might occur.

#### **-zosProcedurePath** *procedure-path*

Specifies a list of schema names that DB2 for z/OS uses to resolve unqualified stored procedure names during online checking of an SQLJ program.

`-zosProcedurePath` applies to programs that are to be run on DB2 for z/OS database servers only.

The list is a `String` value that is a comma-separated list of schema names that is enclosed in double quotation marks. The DB2 database server inserts that list into the SQL path for resolution of unqualified stored procedure names. The SQL path is:

```
SYSIBM, SYSFUN, SYSPROC, procedure-path, qualifier-name, user-ID
```

*qualifier-name* is the value of the `-qualifier` parameter, and *user-ID* is the value of the `-user` parameter.

The DB2 database server tries the schema names in the SQL path from left to right until it finds a match with the name of a stored procedure that exists on that database server. If the DB2 database server finds a match, it obtains the information about the parameters for that stored procedure from the DB2 catalog. If the DB2 database server does not find a match, SQLJ sets the parameter data without any DB2 catalog information.

If `-zosProcedurePath` is not specified, the DB2 database server uses this SQL path:

```
SYSIBM, SYSFUN, SYSPROC, qualifier-name, user-ID
```

If the `-qualifier` parameter is not specified, the SQL path does not include *qualifier-name*.

#### **-genDBRM**

Specifies that `db2sqljcustomize` generates database request modules (DBRMs). Those DBRMs can be used to create DB2 for z/OS packages.

-genDBRM applies to programs that are to be run on DB2 for z/OS database servers only.

If -genDBRM and -automaticbind NO are specified, db2sqljcustomize creates the DBRMs but does not bind them into DB2 packages. If -genDBRM and -automaticbind YES are specified, db2sqljcustomize creates the DBRMs and binds them into DB2 packages.

One DBRM is created for each DB2 isolation level. The naming convention for the generated DBRM files is the same as the naming convention for packages. For example, if -rootpkgname SQLJSA0 is specified, and -genDBRM is also specified, the names of the four DBRM files are:

- SQLJSA01
- SQLJSA02
- SQLJSA03
- SQLJSA04

**-DBRMDir** *directory-name*

When -genDBRM is specified, -DBRMDir specifies the local directory into which db2sqljcustomize puts the generated DBRM files. The default is the current directory.

-DBRMdir applies to programs that are to be run on DB2 for z/OS database servers only.

**-tracefile** *file-name*

Enables tracing and identifies the output file for trace information. This option should be specified only under the direction of IBM Software Support.

**-tracelevel**

If -tracefile is specified, indicates what to trace while db2sqljcustomize runs. The default is TRACE\_SQLJ. This option should be specified only under the direction of IBM Software Support.

*serialized-profile-name* | *file-name.grp*

Specifies the names of one or more serialized profiles that are to be customized. The specified serialized profile must be in a directory that is named in the CLASSPATH environment variable.

A serialized profile name is of the following form:

*program-name\_SJProfileIDNumber.ser*

You can specify the serialized profile name with or without the .ser extension.

*program-name* is the name of the SQLJ source program, without the extension .sqlj. *n* is an integer between 0 and *m-1*, where *m* is the number of serialized profiles that the SQLJ translator generated from the SQLJ source program.

You can specify serialized profile names in one of the following ways:

- List the names in the db2sqljcustomize command. Multiple serialized profile names must be separated by spaces.
- Specify the serialized profile names, one on each line, in a file with the name *file-name.grp*, and specify *file-name.grp* in the db2sqljcustomize command.

If you specify more than one serialized profile name, and if you specify or use the default value of -automaticbind YES, db2sqljcustomize binds a single DB2 package from the profiles. When you use db2sqljcustomize to create a single DB2 package from multiple serialized profiles, you must also specify the -rootpkgname or -singlepkgname option.

If you specify more than one serialized profile name, and you specify `-automaticbind NO`, if you want to bind the serialized profiles into a single DB2 package when you run `db2sqljbind`, you need to specify the same list of serialized profile names, in the same order, in `db2sqljcustomize` and `db2sqljbind`.

If you specify one or more *file-name.grp* files, and you specify `-automaticbind NO`, when you run `db2sqljbind`, you must specify that same list of files, and in the same order in which the files were customized.

You cannot run `db2sqljcustomize` on individual files, and then group those files when you run `db2sqljbind`.

## Output

When `db2sqljcustomize` runs, it creates a customized serialized profile. It also creates DB2 packages, if the `automaticbind` value is YES.

## Examples

```
db2sqljcustomize -user richler -password mordecai
  -url jdbc:db2:/server:50000/sample -collection duddy
  -bindoptions "EXPLAIN YES" pgmname_SJProfile0.ser
```

## Usage notes

**Online checking is always recommended:** It is highly recommended that you use online checking when you customize your serialized profiles. Online checking determines information about the data types and lengths of DB2 host variables, and is especially important for the following items:

- Predicates with `java.lang.String` host variables and CHAR columns  
Unlike character variables in other host languages, Java String host variables are not declared with a length attribute. To optimize a query properly that contains character host variables, DB2 needs the length of the host variables. For example, suppose that a query has a predicate in which a String host variable is compared to a CHAR column, and an index is defined on the CHAR column. If DB2 cannot determine the length of the host variable, it might do a table space scan instead of an index scan. Online checking avoids this problem by providing the lengths of the corresponding character columns.
- Predicates with `java.lang.String` host variables and GRAPHIC columns  
Without online checking, DB2 might issue a bind error (SQLCODE -134) when it encounters a predicate in which a String host variable is compared to a GRAPHIC column.
- Column names in the result table of an SQLJ SELECT statement at a remote server:  
Without online checking, the driver cannot determine the column names for the result table of a remote SELECT.

**Customizing multiple serialized profiles together:** Multiple serialized profiles can be customized together to create a single DB2 package. If you do this, and if you specify `-staticpositioned YES`, any positioned UPDATE or DELETE statement that references a cursor that is declared *earlier in the package* executes statically, even if the UPDATE or DELETE statement is in a different source file from the cursor declaration. If you want `-staticpositioned YES` behavior when your program consists of multiple source files, you need to order the profiles in the `db2sqljcustomize` command to cause cursor declarations to be ahead of positioned UPDATE or DELETE statements in the package. To do that, list profiles that



contain SELECT statements that assign result tables to iterators *before* profiles that contain the positioned UPDATE or DELETE statements that reference those iterators.

**Using a customized serialized profile at one data source that was customized at another data source:** You can run `db2sqljcustomize` to produce a customized serialized profile for an SQLJ program at one data source, and then use that profile at another data source. You do this by running `db2sqljbind` multiple times on customized serialized profiles that you created by running `db2sqljcustomize` once. When you run the programs at these data sources, the DB2 objects that the programs access must be identical at every data source. For example, tables at all data sources must have the same encoding schemes and the same columns with the same data types.

**Using the `-collection` parameter:** `db2sqljcustomize` stores the DB2 collection name in each customized serialized profile that it produces. When an SQLJ program is executed, the driver uses the collection name that is stored in the customized serialized profile to search for packages to execute. The name that is stored in the customized serialized profile is determined by the value of the `-collection` parameter. Only one collection ID can be stored in the serialized profile. However, you can bind the same serialized profile into multiple package collections by specifying the `COLLECTION` option in the `-bindoptions` parameter. To execute a package that is in a collection other than the collection that is specified in the serialized profile, include a `SET CURRENT PACKAGESET` statement in the program.

**Using the `VERSION` parameter:** Use the `VERSION` parameter to bind two or more versions of a package for the same SQLJ program into the same collection. You might do this if you have changed an SQLJ source program, and you want to run the old and new versions of the program.

To maintain two versions of a package, follow these steps:

1. Change the code in your source program.
2. Translate the source program to create a new serialized profile. Ensure that you do not overwrite your original serialized profile.
3. Run `db2sqljcustomize` to customize the serialized profile and create DB2 packages with the same package names and in the same collection as the original packages. Do this by using the same values for `-rootpkgname` and `-collection` when you bind the new packages that you used when you created the original packages. Specify the `VERSION` option in the `-bindoptions` parameter to put a version ID in the new customized serialized profile and in the new packages.

It is essential that you specify the `VERSION` option when you perform this step. If you do not, you overwrite your original packages.

When you run the old version of the program, DB2 loads the old versions of the packages. When you run the new version of the program, DB2 loads the new versions of the packages.

**Binding packages and plans on DB2 for z/OS:** You can use the `db2sqljcustomize -genDBRM` parameter to create DBRMs on your local system. You can then transfer those DBRMs to a DB2 for z/OS system, and bind them into packages there. If you plan to use this technique, you need to transfer the DBRM files to the z/OS system

as **binary** files, to a partitioned data set with record format FB and record length 80. When you bind the packages, you need to specify the following bind option values:

#### **ENCODING(EBCDIC)**

The IBM Data Server Driver for JDBC and SQLJ on DB2 for z/OS requires EBCDIC encoding for your packages.

#### **DYNAMICRULES(BIND)**

This option ensures consistent authorization rules when SQLJ uses dynamic SQL. SQLJ uses dynamic SQL for positioned UPDATE or DELETE operations that involve multiple SQLJ programs.

*EXTENDEDINDICATOR bind option behavior:* If the EXTENDEDINDICATOR bind option is not specified in the -bindoptions options string, and the target data server supports extended indicators, bind operations use EXTENDEDINDICATOR(YES). If EXTENDEDINDICATOR(NO) is explicitly specified, and the application contains extended indicator syntax, unexpected behavior can occur because the IBM Data Server Driver for JDBC and SQLJ treats extended indicators as NULL values.

## **db2sqljbind - SQLJ profile binder**

db2sqljbind binds DB2 packages for a serialized profile that was previously customized with the db2sqljcustomize command.

Applications that run with the IBM Data Server Driver for JDBC and SQLJ require packages but no plans. If the db2sqljcustomize -automaticbind option is specified as YES or defaults to YES, db2sqljcustomize binds packages for you at the data source that you specify in the -url parameter. However, if -automaticbind is NO, if a bind fails when db2sqljcustomize runs, or if you want to create identical packages at multiple locations for the same serialized profile, you can use the db2sqljbind command to bind packages.

### **Authorization**

The privilege set of the process must include one of the following authorities:

- DBADM authority
- If the package does not exist, the BINDADD privilege, and one of the following privileges:
  - CREATEIN privilege
  - IMPLICIT\_SCHEMA authority on the database if the schema name of the package does not exist
- If the package exists:
  - ALTERIN privilege on the schema
  - BIND privilege on the package

The user also needs all privileges that are required to compile any static SQL statements in the application. Privileges that are granted to groups are not used for authorization checking of static statements.

### **Command syntax**

►► db2sqljbind —————►  
└─help┘



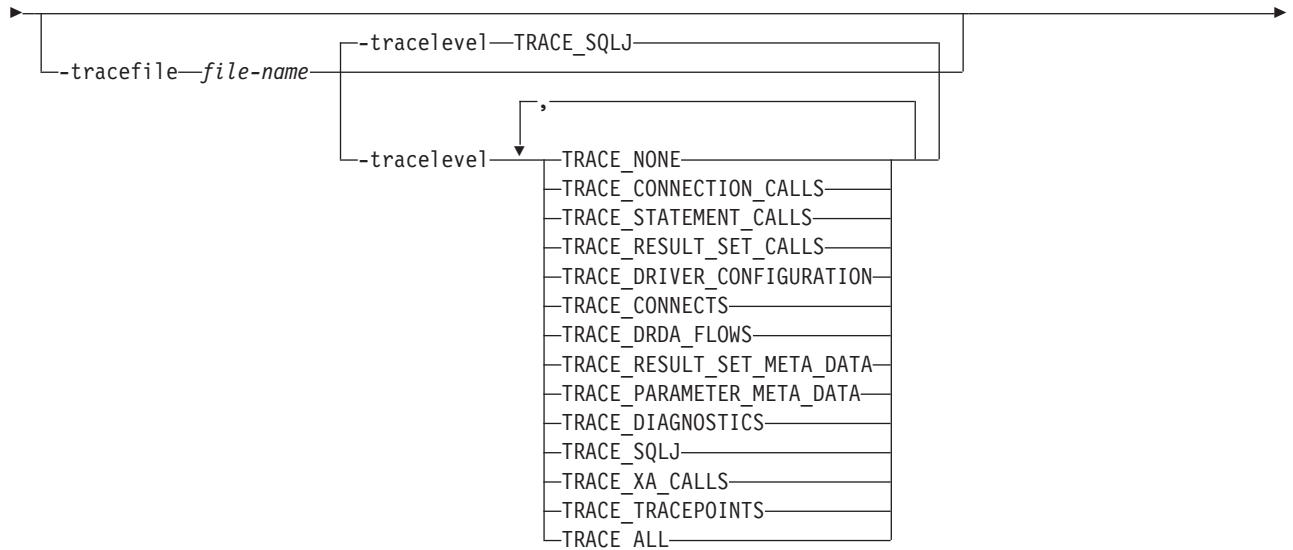
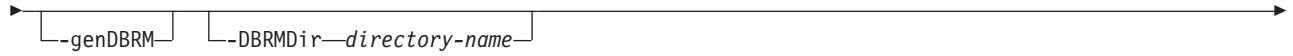
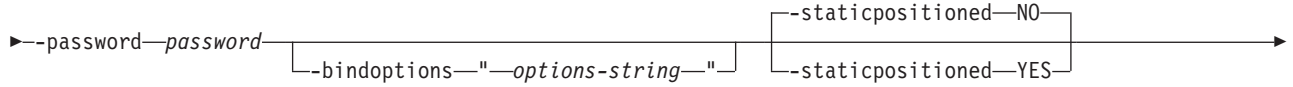
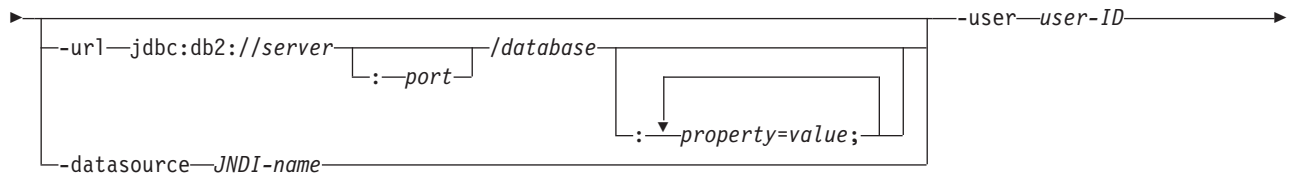

**options-string:**



**DB2 for z/OS options:**

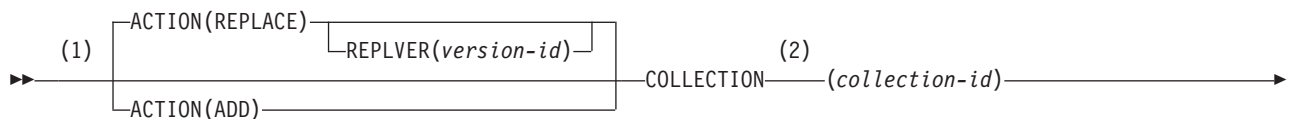

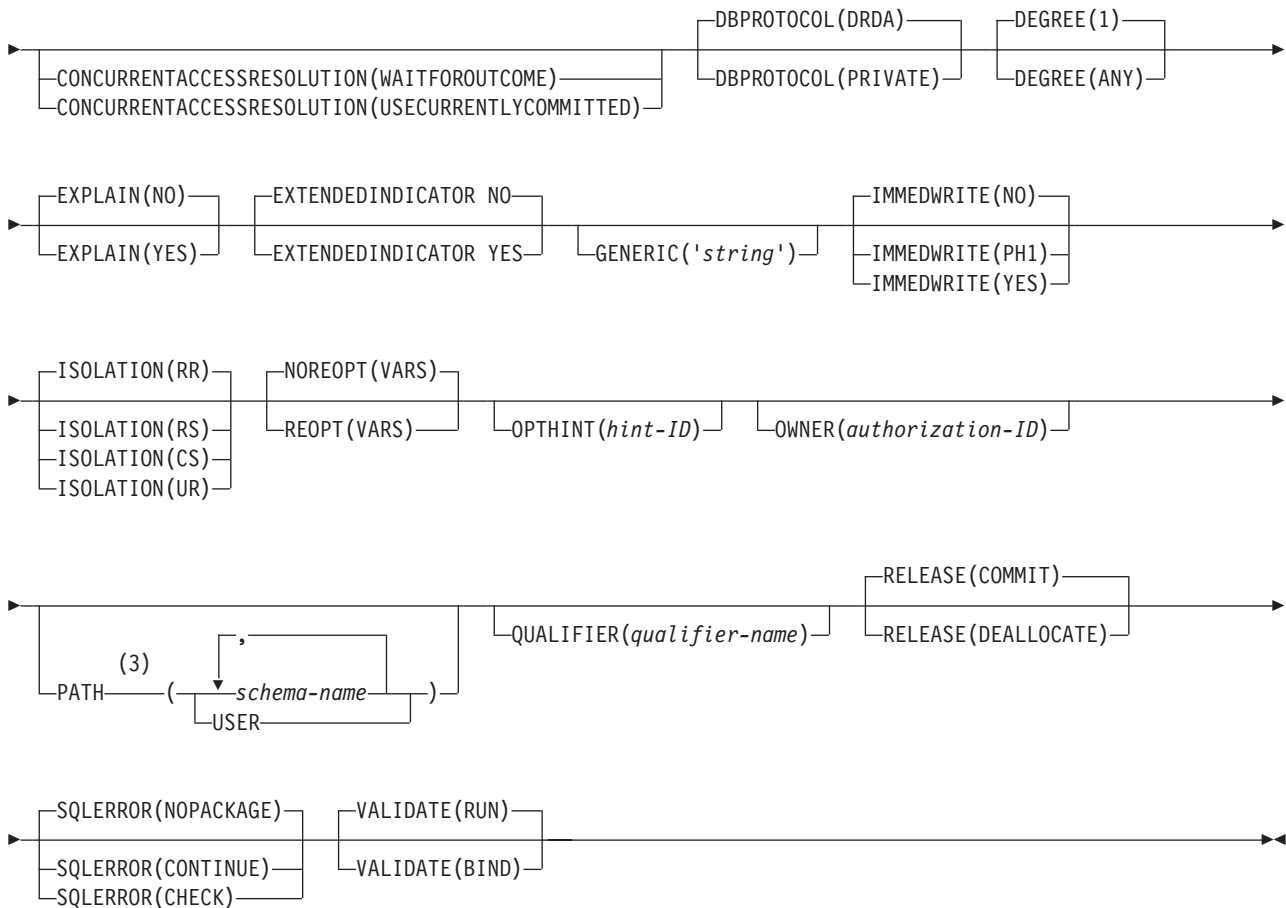

**Notes:**

- 1 These options can be specified in any order.
- 2 COLLECTION is not a valid BIND option for DB2 for z/OS. However, COLLECTION can be specified as a -bindoptions argument in db2sqljcustomize or db2sqljbind, to change the collection at bind time, or to bind the same serialized profile file into multiple collections.
- 3 FUNCPATH can be specified as an alias for PATH.

**DB2 Database for Linux, UNIX, and Windows options**

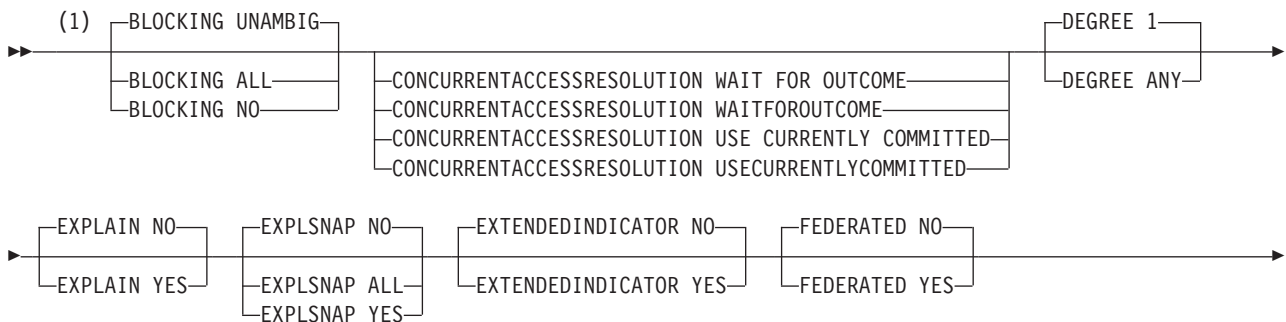

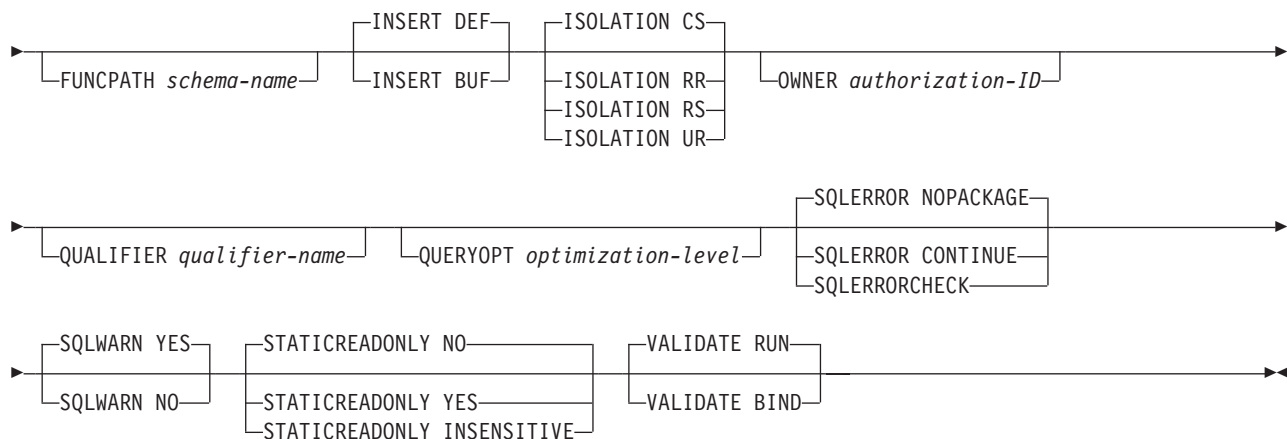

## Notes:

- 1 These options can be specified in any order.

## Command parameters

### -help

Specifies that db2sqljbind describes each of the options that it supports. If any other options are specified with -help, they are ignored.

### -url

Specifies the URL for the data source for which the profile is to be customized. A connection is established to the data source that this URL represents if the -automaticbind or -onlinecheck option is specified as YES or defaults to YES. The variable parts of the -url value are:

#### server

The domain name or IP address of the operating system on which the database server resides.

#### port

The TCP/IP server port number that is assigned to the database server. The default is 446.

#### database

A name for the database server for which the profile is to be customized.

If the connection is to a DB2 for z/OS server, *database* is the DB2 location name that is defined during installation. All characters in this value must be uppercase characters. You can determine the location name by executing the following SQL statement on the server:

```
SELECT CURRENT SERVER FROM SYSIBM.SYSDUMMY1;
```

If the connection is to a DB2 Database for Linux, UNIX, and Windows server, *database* is the database name that is defined during installation.

If the connection is to an IBM Cloudscape server, the *database* is the fully-qualified name of the file that contains the database. This name must be enclosed in double quotation marks ("). For example:

```
"c:/databases/testdb"
```

```
property=value;
```

A property for the JDBC connection.

### -datasource JNDI-name

Specifies the logical name of a DataSource object that was registered with

JNDI. The DataSource object represents the data source for which the profile is to be customized. A connection is established to the data source if the `-automaticbind` or `-onlinecheck` option is specified as YES or defaults to YES. Specifying `-datasource` is an alternative to specifying `-url`. The DataSource object must represent a connection that uses IBM Data Server Driver for JDBC and SQLJ type 4 connectivity.

**-user** *user-ID*

Specifies the user ID to be used to connect to the data source for binding the package.

**-password** *password*

Specifies the password to be used to connect to the data source for binding the package.

**-bindoptions** *options-string*

Specifies a list of options, separated by spaces. These options have the same function as DB2 precompile and bind options with the same names. If you are preparing your program to run on a DB2 for z/OS system, specify DB2 for z/OS options. If you are preparing your program to run on a DB2 Database for Linux, UNIX, and Windows system, specify DB2 Database for Linux, UNIX, and Windows options.

**Notes on bind options:**

- Specify VERSION only if the following conditions are true:
  - If you are binding a package at a DB2 Database for Linux, UNIX, and Windows system, the system is at Version 8 or later.
  - You rerun the translator on a program before you bind the associated package with a new VERSION value.
- The value for STATICREADONLY is YES for servers that support STATICREADONLY, and NO for other servers. When you specify STATICREADONLY YES, DB2 processes ambiguous cursors as if they were read-only cursors. For troubleshooting iterator declaration errors, you need to explicitly specify STATICREADONLY NO, or declare iterators so that they are unambiguous. For example, if you want an iterator to be unambiguously updatable, declare the iterator to implement `sqlj.runtime.ForUpdate`. If you want an iterator to be read-only, include the FOR READ ONLY clause in SELECT statements that use the iterator.

**Important:** Specify only those program preparation options that are appropriate for the data source at which you are binding a package. Some values and defaults for the IBM Data Server Driver for JDBC and SQLJ are different from the values and defaults for DB2.

**-staticpositioned** NO|YES

For iterators that are declared in the same source file as positioned UPDATE statements that use the iterators, specifies whether the positioned UPDATES are executed as statically bound statements. The default is NO. NO means that the positioned UPDATES are executed as dynamically prepared statements. This value must be the same as the `-staticpositioned` value for the previous `db2sqljcustomize` invocation for the serialized profile.

**-genDBRM**

Specifies that `db2sqljbind` generates database request modules (DBRMs) from the serialized profile, and that `db2sqljbind` does not perform remote bind operations.

`-genDBRM` applies to programs that are to be run on DB2 for z/OS database servers only.

**-DBRMDir** *directory-name*

When `-genDBRM` is specified, `-DBRMDir` specifies the local directory into which `db2sqljbind` puts the generated DBRM files. The default is the current directory.

`-DBRMDir` applies to programs that are to be run on DB2 for z/OS database servers only.

**-tracefile** *file-name*

Enables tracing and identifies the output file for trace information. This option should be specified only under the direction of IBM Software Support.

**-tracelevel**

If `-tracefile` is specified, indicates what to trace while `db2sqljcustomize` runs. The default is `TRACE_SQLJ`. This option should be specified only under the direction of IBM Software Support.

*serialized-profile-name* | *file-name*.grp

Specifies the names of one or more serialized profiles from which the package is bound. A serialized profile name is of the following form:

*program-name*\_SJProfileIDNumber.ser

*program-name* is the name of the SQLJ source program, without the extension `.sqlj`. *n* is an integer between 0 and *m*-1, where *m* is the number of serialized profiles that the SQLJ translator generated from the SQLJ source program.

You can specify serialized profile names in one of the following ways:

- List the names in the `db2sqljcustomize` command. Multiple serialized profile names must be separated by spaces.
- Specify the serialized profile names, one on each line, in a file with the name *file-name*.grp, and specify *file-name*.grp in the `db2sqljbind` command.

If you specify more than one serialized profile name to bind a single DB2 package from several serialized profiles, you must have specified the same serialized profile names, in the same order, when you ran `db2sqljcustomize`.

If you specify one or more *file-name*.grp files, you must have run `db2sqljcustomize` once with that same list of files. The order in which you specify the files in `db2sqljbind` must be the same as the order in `db2sqljcustomize`.

You cannot run `db2sqljcustomize` on individual files, and then group those files when you run `db2sqljbind`.

## Examples

```
db2sqljbind -user richler -password mordecai
  -url jdbc:db2://server:50000/sample -bindoptions "EXPLAIN YES"
  pgmname_SJProfile0.ser
```

## Usage notes

**Package names produced by `db2sqljbind`:** The names of the packages that are created by `db2sqljbind` are the names that you specified using the `-rootpkgname` or `-singlepkgname` parameter when you ran `db2sqljcustomize`. If you did not specify `-rootpkgname` or `-singlepkgname`, the package names are the first seven bytes of the profile name, appended with the isolation level character.

**DYNAMICRULES value for `db2sqljbind`:** The `DYNAMICRULES` bind option determines a number of run-time attributes for the DB2 package. Two of those

attributes are the authorization ID that is used to check authorization, and the qualifier that is used for unqualified objects. To ensure the correct authorization for dynamically executed positioned UPDATE and DELETE statements in SQLJ programs, db2sqljbind always binds the DB2 packages with the DYNAMICRULES(BIND) option. You cannot modify this option. The DYNAMICRULES(BIND) option causes the SET CURRENT SQLID statement and the SET CURRENT SCHEMA statement to have no impact on an SQLJ program, because those statements affect only dynamic statements that are bound with DYNAMICRULES values other than BIND.

With DYNAMICRULES(BIND), unqualified table, view, index, and alias names in dynamic SQL statements are implicitly qualified with value of the bind option QUALIFIER. If you do not specify QUALIFIER, DB2 uses the authorization ID of the package owner as the implicit qualifier. If this behavior is not suitable for your program, you can use one of the following techniques to set the correct qualifier:

- Force positioned UPDATE and DELETE statements to execute statically. You can use the -staticpositioned YES option of db2sqljcustomize or db2sqljbind to do this if the cursor (iterator) for a positioned UPDATE or DELETE statement is in the same package as the positioned UPDATE or DELETE statement.
- Fully qualify DB2 table names in positioned UPDATE and positioned DELETE statements.

**EXTENDEDINDICATOR bind option behavior:** If the EXTENDEDINDICATOR bind option is not specified in the -bindoptions options string, and the target data server supports extended indicators, bind operations use EXTENDEDINDICATOR(YES). If EXTENDEDINDICATOR(NO) is explicitly specified, and the application contains extended indicator syntax, unexpected behavior can occur because the IBM Data Server Driver for JDBC and SQLJ treats extended indicators as NULL values.

## db2sqljprint - SQLJ profile printer

db2sqljprint prints the contents of the customized version of a profile as plain text.

### Authorization

None

### Command syntax

▶▶—db2sqljprint—*profilename*—————▶▶

### Command parameters

*profilename*

Specifies the relative or absolute name of an SQLJ profile file. When an SQLJ file is translated into a Java source file, information about the SQL operations it contains is stored in SQLJ-generated resource files called profiles. Profiles are identified by the suffix \_SJProfileN (where N is an integer) following the name of the original input file. They have a .ser extension. Profile names can be specified with or without the .ser extension.

## Examples

```
db2sqljprint pgmname_SJProfile0.ser
```





---

## Appendix A. Overview of the DB2 technical information

DB2 technical information is available in multiple formats that can be accessed in multiple ways.

DB2 technical information is available through the following tools and methods:

- DB2 Information Center
  - Topics (Task, concept and reference topics)
  - Sample programs
  - Tutorials
- DB2 books
  - PDF files (downloadable)
  - PDF files (from the DB2 PDF DVD)
  - printed books
- Command-line help
  - Command help
  - Message help

**Note:** The DB2 Information Center topics are updated more frequently than either the PDF or the hardcopy books. To get the most current information, install the documentation updates as they become available, or refer to the DB2 Information Center at [ibm.com](http://ibm.com).

You can access additional DB2 technical information such as technotes, white papers, and IBM Redbooks® publications online at [ibm.com](http://ibm.com). Access the DB2 Information Management software library site at <http://www.ibm.com/software/data/sw-library/>.

### Documentation feedback

We value your feedback on the DB2 documentation. If you have suggestions for how to improve the DB2 documentation, send an e-mail to [db2docs@ca.ibm.com](mailto:db2docs@ca.ibm.com). The DB2 documentation team reads all of your feedback, but cannot respond to you directly. Provide specific examples wherever possible so that we can better understand your concerns. If you are providing feedback on a specific topic or help file, include the topic title and URL.

Do not use this email address to contact DB2 Customer Support. If you have a DB2 technical issue that the documentation does not resolve, contact your local IBM service center for assistance.

---

## Displaying SQL state help from the command line processor

DB2 products return an SQLSTATE value for conditions that can be the result of an SQL statement. SQLSTATE help explains the meanings of SQL states and SQL state class codes.

## Procedure

To start SQL state help, open the command line processor and enter:

```
? sqlstate or ? class code
```

where *sqlstate* represents a valid five-digit SQL state and *class code* represents the first two digits of the SQL state.

For example, ? 08003 displays help for the 08003 SQL state, and ? 08 displays help for the 08 class code.

---

## Accessing different versions of the DB2 Information Center

Documentation for other versions of DB2 products is found in separate information centers on [ibm.com](http://ibm.com)<sup>®</sup>.

### About this task

For DB2 Version 10.1 topics, the *DB2 Information Center* URL is <http://publib.boulder.ibm.com/infocenter/db2luw/v10r1>.

For DB2 Version 9.8 topics, the *DB2 Information Center* URL is <http://publib.boulder.ibm.com/infocenter/db2luw/v9r8/>.

For DB2 Version 9.7 topics, the *DB2 Information Center* URL is <http://publib.boulder.ibm.com/infocenter/db2luw/v9r7/>.

For DB2 Version 9.5 topics, the *DB2 Information Center* URL is <http://publib.boulder.ibm.com/infocenter/db2luw/v9r5>.

For DB2 Version 9.1 topics, the *DB2 Information Center* URL is <http://publib.boulder.ibm.com/infocenter/db2luw/v9/>.

For DB2 Version 8 topics, go to the *DB2 Information Center* URL at: <http://publib.boulder.ibm.com/infocenter/db2luw/v8/>.

---

## DB2 tutorials

The DB2 tutorials help you learn about various aspects of DB2 products. Lessons provide step-by-step instructions.

### Before you begin

You can view the XHTML version of the tutorial from the Information Center at <http://publib.boulder.ibm.com/infocenter/db2luw/v10r1/>.

Some lessons use sample data or code. See the tutorial for a description of any prerequisites for its specific tasks.

### DB2 tutorials

To view the tutorial, click the title.

*pureXML*<sup>®</sup>

Set up a DB2 database to store XML data and to perform basic operations with the native XML data store.

---

## DB2 troubleshooting information

A wide variety of troubleshooting and problem determination information is available to assist you in using DB2 database products.

### DB2 documentation

Troubleshooting information can be found in the *Troubleshooting and Tuning Database Performance* or the Database fundamentals section of the *DB2 Information Center*, which contains:

- Information about how to isolate and identify problems with DB2 diagnostic tools and utilities.
- Solutions to some of the most common problem.
- Advice to help solve other problems you might encounter with your DB2 database products.

### IBM Support Portal

See the IBM Support Portal if you are experiencing problems and want help finding possible causes and solutions. The Technical Support site has links to the latest DB2 publications, TechNotes, Authorized Program Analysis Reports (APARs or bug fixes), fix packs, and other resources. You can search through this knowledge base to find possible solutions to your problems.

Access the IBM Support Portal at [http://www.ibm.com/support/entry/portal/Overview/Software/Information\\_Management/DB2\\_for\\_Linux,\\_UNIX\\_and\\_Windows](http://www.ibm.com/support/entry/portal/Overview/Software/Information_Management/DB2_for_Linux,_UNIX_and_Windows)

---

## Terms and Conditions

Permissions for the use of these publications is granted subject to the following terms and conditions.

**Personal use:** You may reproduce these Publications for your personal, non commercial use provided that all proprietary notices are preserved. You may not distribute, display or make derivative work of these Publications, or any portion thereof, without the express consent of IBM.

**Commercial use:** You may reproduce, distribute and display these Publications solely within your enterprise provided that all proprietary notices are preserved. You may not make derivative works of these Publications, or reproduce, distribute or display these Publications or any portion thereof outside your enterprise, without the express consent of IBM.

Except as expressly granted in this permission, no other permissions, licenses or rights are granted, either express or implied, to the Publications or any information, data, software or other intellectual property contained therein.

IBM reserves the right to withdraw the permissions granted herein whenever, in its discretion, the use of the Publications is detrimental to its interest or, as determined by IBM, the instructions stated previously are not being properly followed.

You may not download, export or re-export this information except in full compliance with all applicable laws and regulations, including all United States export laws and regulations.

IBM MAKES NO GUARANTEE ABOUT THE CONTENT OF THESE PUBLICATIONS. THE PUBLICATIONS ARE PROVIDED "AS-IS" AND WITHOUT WARRANTY OF ANY KIND, EITHER EXPRESSED OR IMPLIED, INCLUDING BUT NOT LIMITED TO IMPLIED WARRANTIES OF MERCHANTABILITY, NON-INFRINGEMENT, AND FITNESS FOR A PARTICULAR PURPOSE.

---

## Appendix B. Notices

This information was developed for products and services offered in the U.S.A. Information about non-IBM products is based on information available at the time of first publication of this document and is subject to change.

IBM may not offer the products, services, or features discussed in this document in other countries. Consult your local IBM representative for information about the products and services currently available in your area. Any reference to an IBM product, program, or service is not intended to state or imply that only that IBM product, program, or service may be used. Any functionally equivalent product, program, or service that does not infringe any IBM intellectual property right may be used instead. However, it is the user's responsibility to evaluate and verify the operation of any non-IBM product, program, or service.

IBM may have patents or pending patent applications covering subject matter described in this document. The furnishing of this document does not grant you any license to these patents. You can send license inquiries, in writing, to:

IBM Director of Licensing  
IBM Corporation  
North Castle Drive  
Armonk, NY 10504-1785  
U.S.A.

For license inquiries regarding double-byte character set (DBCS) information, contact the IBM Intellectual Property Department in your country or send inquiries, in writing, to:

Intellectual Property Licensing  
Legal and Intellectual Property Law  
IBM Japan, Ltd.  
1623-14, Shimotsuruma, Yamato-shi  
Kanagawa 242-8502 Japan

**The following paragraph does not apply to the United Kingdom or any other country/region where such provisions are inconsistent with local law:**

INTERNATIONAL BUSINESS MACHINES CORPORATION PROVIDES THIS PUBLICATION "AS IS" WITHOUT WARRANTY OF ANY KIND, EITHER EXPRESS OR IMPLIED, INCLUDING, BUT NOT LIMITED TO, THE IMPLIED WARRANTIES OF NON-INFRINGEMENT, MERCHANTABILITY, OR FITNESS FOR A PARTICULAR PURPOSE. Some states do not allow disclaimer of express or implied warranties in certain transactions; therefore, this statement may not apply to you.

This information could include technical inaccuracies or typographical errors. Changes are periodically made to the information herein; these changes will be incorporated in new editions of the publication. IBM may make improvements, changes, or both in the product(s) and/or the program(s) described in this publication at any time without notice.

Any references in this information to websites not owned by IBM are provided for convenience only and do not in any manner serve as an endorsement of those

websites. The materials at those websites are not part of the materials for this IBM product and use of those websites is at your own risk.

IBM may use or distribute any of the information you supply in any way it believes appropriate without incurring any obligation to you.

Licenses of this program who wish to have information about it for the purpose of enabling: (i) the exchange of information between independently created programs and other programs (including this one) and (ii) the mutual use of the information that has been exchanged, should contact:

IBM Canada Limited  
U59/3600  
3600 Steeles Avenue East  
Markham, Ontario L3R 9Z7  
CANADA

Such information may be available, subject to appropriate terms and conditions, including, in some cases, payment of a fee.

The licensed program described in this document and all licensed material available for it are provided by IBM under terms of the IBM Customer Agreement, IBM International Program License Agreement, or any equivalent agreement between us.

Any performance data contained herein was determined in a controlled environment. Therefore, the results obtained in other operating environments may vary significantly. Some measurements may have been made on development-level systems, and there is no guarantee that these measurements will be the same on generally available systems. Furthermore, some measurements may have been estimated through extrapolation. Actual results may vary. Users of this document should verify the applicable data for their specific environment.

Information concerning non-IBM products was obtained from the suppliers of those products, their published announcements, or other publicly available sources. IBM has not tested those products and cannot confirm the accuracy of performance, compatibility, or any other claims related to non-IBM products. Questions on the capabilities of non-IBM products should be addressed to the suppliers of those products.

All statements regarding IBM's future direction or intent are subject to change or withdrawal without notice, and represent goals and objectives only.

This information may contain examples of data and reports used in daily business operations. To illustrate them as completely as possible, the examples include the names of individuals, companies, brands, and products. All of these names are fictitious, and any similarity to the names and addresses used by an actual business enterprise is entirely coincidental.

#### COPYRIGHT LICENSE:

This information contains sample application programs in source language, which illustrate programming techniques on various operating platforms. You may copy, modify, and distribute these sample programs in any form without payment to IBM, for the purposes of developing, using, marketing or distributing application programs conforming to the application programming interface for the operating

platform for which the sample programs are written. These examples have not been thoroughly tested under all conditions. IBM, therefore, cannot guarantee or imply reliability, serviceability, or function of these programs. The sample programs are provided "AS IS", without warranty of any kind. IBM shall not be liable for any damages arising out of your use of the sample programs.

Each copy or any portion of these sample programs or any derivative work must include a copyright notice as follows:

© (*your company name*) (*year*). Portions of this code are derived from IBM Corp. Sample Programs. © Copyright IBM Corp. *\_enter the year or years\_*. All rights reserved.

## Trademarks

IBM, the IBM logo, and [ibm.com](http://ibm.com) are trademarks or registered trademarks of International Business Machines Corp., registered in many jurisdictions worldwide. Other product and service names might be trademarks of IBM or other companies. A current list of IBM trademarks is available on the web at "Copyright and trademark information" at [www.ibm.com/legal/copytrade.shtml](http://www.ibm.com/legal/copytrade.shtml).

The following terms are trademarks or registered trademarks of other companies

- Linux is a registered trademark of Linus Torvalds in the United States, other countries, or both.
- Java and all Java-based trademarks and logos are trademarks or registered trademarks of Oracle, its affiliates, or both.
- UNIX is a registered trademark of The Open Group in the United States and other countries.
- Intel, Intel logo, Intel Inside, Intel Inside logo, Celeron, Intel SpeedStep, Itanium, and Pentium are trademarks or registered trademarks of Intel Corporation or its subsidiaries in the United States and other countries.
- Microsoft, Windows, Windows NT, and the Windows logo are trademarks of Microsoft Corporation in the United States, other countries, or both.

Other company, product, or service names may be trademarks or service marks of others.





---

# Index

## Special characters

- Infinity
    - retrieving in Java applications 325
  - only methods
    - DB2Administrator class 456
    - DB2CatalogedDatabase class 471
  - only properties
    - DB2Administrator class 456
    - DB2CatalogedDatabase class 471
- ## A
- alternate groups
    - DB2 for Linux, UNIX, and Windows 263
    - DB2 for z/OS 294
  - alternative security mechanism
    - IBM Data Server Driver for JDBC and SQLJ 213
  - applets
    - JDBC
      - building 223
    - SQLJ
      - building 225
    - usage 226
  - application development
    - high availability
      - connections to IBM Informix 281
      - direct connections to DB2 for z/OS servers 296
    - JDBC
      - application programming 25
    - SQLJ 139
  - application programming for high availability
    - connections to DB2 Database for Linux, UNIX, and Windows 267
  - applications
    - Java 2 Platform, Enterprise Edition 299
  - ARRAY of ROW parameter of CALL statement
    - JDBC 71
  - ARRAY parameters
    - invoking stored procedures from JDBC programs 95
    - invoking stored procedures from SQLJ programs 188
  - assignment-clause
    - SQLJ 428
  - auto-generated keys
    - retrieving for DELETE, JDBC application 100
    - retrieving for INSERT, JDBC application 98
    - retrieving for MERGE, JDBC application 100
    - retrieving for UPDATE, JDBC application 100
    - retrieving in JDBC application 98
  - autocommit modes
    - default JDBC 128
  - automatic client reroute
    - client applications 251
    - DB2 for z/OS 293
    - IBM Informix servers 276
  - automatic client reroute support, client operation 259
  - automatically generated keys
    - retrieving
      - DELETE statement, JDBC application 100
      - INSERT statement, JDBC application 98
      - JDBC applications 98

- automatically generated keys (*continued*)
  - retrieving (*continued*)
    - MERGE statement, JDBC application 100
    - UPDATE statement, JDBC application 100

## B

- batch queries
  - JDBC 53
- batch updates
  - JDBC 46
  - SQLJ 160
- BatchUpdateException exception
  - retrieving information 135

## C

- CallableStatement class 65
- client affinities
  - .NET 268, 282
  - CLI 268, 282
  - IBM Data Server Driver for JDBC and SQLJ 268, 269, 282
- client affinities, example of enabling
  - Java clients 269, 283
- client application
  - automatic client reroute 251
  - high availability 251
  - transaction-level load balancing 251
- client configuration, automatic client reroute support
  - DB2 Database for Linux, UNIX, and Windows 253
- client configuration, high-availability support
  - IBM Informix 272
- client configuration, Sysplex workload balancing
  - DB2 for z/OS 288
- client configuration, workload balancing support
  - DB2 Database for Linux, UNIX, and Windows 256
- client info properties
  - IBM Data Server Driver for JDBC and SQLJ 107, 108
- clients
  - alternate groups
    - connections to DB2 for Linux, UNIX, and Windows 263
    - connections to DB2 for z/OS 294
  - automatic client reroute
    - connections to DB2 for z/OS 293
    - connections to IBM Informix 276
- commands
  - db2sqljbind 580
  - db2sqljprint 586
  - sqlj 564
  - SQLJ 564
- comments
  - SQLJ applications 154
- commits
  - SQLJ transactions 198
- transactions
  - JDBC 127
- compound SQL
  - JDBC 116
  - SQLJ 116

- configuration
  - JDBC 19
  - SQLJ 19
- configuration properties
  - customizing 19
  - details 374
  - parameters 19
- connection context
  - class 141
  - closing 200
  - default 141
  - object 141
- connection declaration clause
  - SQLJ 422
- connection pooling
  - overview 309
- connections
  - closing
    - importance 137, 200
  - data sources using SQLJ 141
  - DataSource interface 33
  - existing 147
- containers
  - Java 2 Platform, Enterprise Edition 300
- context clause
  - SQLJ 424, 425
- cursor OUT parameter of CALL statement
  - JDBC 69
  - SQLJ 176

## D

- data
  - retrieving
    - JDBC 51
- data server connection
  - testing with DB2Jcc 231
- data sources
  - connecting to
    - DriverManager 29
    - JDBC 27
    - JDBC DataSource 33
- data type mappings
  - Java types to other types 313
- DatabaseMetaData
  - extensions for modules 40
- DatabaseMetaData methods 38
- databases
  - compatibility
    - IBM Data Server Driver for JDBC and SQLJ 3
- DataSource interface
  - SQLJ
    - connection technique 3 144
    - connection technique 4 146
- DataSource objects
  - creating 36
  - deploying 36
- date value adjustment
  - JDBC applications 320
  - SQLJ applications 320
- DB2 Database for Linux, UNIX, and Windows
  - client configuration, automatic client reroute support 253
  - client configuration, workload balancing support 256
  - high-availability support 252
  - workload balancing, operation 266
- DB2 Database for Linux, UNIX, and Windows high availability support, example of enabling
  - IBM Data Server Driver for JDBC and SQLJ 255
- DB2 Database for Linux, UNIX, and Windows workload balancing support, example of enabling
  - IBM Data Server Driver for JDBC and SQLJ 258
- DB2 Database for Linux, UNIX, and Windows, connections
  - application programming for high availability 267
- DB2 for Linux, UNIX, and Windows versions
  - associated IBM Data Server Driver for JDBC and SQLJ versions 4
- DB2 for z/OS
  - binding packages 568
  - client configuration, Sysplex workload balancing 288
  - direct connections 292, 296
  - server access from Java programs 20
  - Sysplex support
    - overview 285
- DB2 Information Center
  - versions 590
- DB2Administrator class 456
- DB2BaseDataSource class 456
- DB2Binder utility 11
- DB2CallableStatement interface 464
- DB2CataloguedDatabase class 471
- DB2ClientRerouteServerList class 472
- DB2Connection interface 473
- DB2ConnectionPoolDataSource class 492
- DB2DatabaseMetaData interface 494
- DB2Diagnosable class
  - retrieving the SQLCA 198
- DB2Diagnosable interface 503
- DB2Driver class 503
- DB2ExceptionFormatter class 504
- DB2FileReference class 504
- DB2Jcc utility
  - details 233
  - testing a data server connection 231
- DB2JCCPlugin interface 505
- DB2LobTableCreator utility 18
- DB2ParameterMetaData interface 506
- DB2ParameterMetaData methods 78
- DB2PooledConnection interface 506
- DB2PoolMonitor class 509
- DB2PreparedStatement interface 512
- DB2ResultSet interface 524
- DB2ResultSetMetaData interface 525
- DB2RowID interface 526
- DB2SimpleDataSource class
  - definition 36
  - details 527
- DB2Sqlca class 527
- db2sqljbind command 580
- db2sqljcustomize command 568
- db2sqljprint
  - formation JCC customized profile 233
- db2sqljprint command
  - details 586
  - formatting information about SQLJ customized profile 231
- DB2Statement interface 528
- DB2Struct interface 541
- DB2SystemMonitor interface 531
- DB2T4XAIndoubtUtil 21
- DB2TraceManager class 534
- DB2TraceManagerMXBean interface 537
- DB2Types class 541
- DB2XADatasource class 541

- DB2Xml interface 543
- DBBatchUpdateException interface 455
- DBTimestamp class 545
- DBTimestamp object
  - IBM Data Server Driver for JDBC and SQLJ 87
- default connection context 148
- deregisterDB2XMLObject method 125
- distinct types
  - JDBC applications 95
  - SQLJ applications 187
- distributed transactions
  - example 302
- documentation
  - overview 589
  - terms and conditions of use 591
- DriverManager interface
  - SQLJ
    - SQLJ connection technique 1 141
    - SQLJ connection technique 2 143
- drivers
  - determining IBM Data Server Driver for JDBC and SQLJ version 563
- dynamic data format 179

## E

- encryption
  - IBM Data Server Driver for JDBC and SQLJ 206
- Enterprise Java Beans
  - overview 307
- environment variables
  - JDBC 19
  - SQLJ 19
- errors
  - SQLJ 198
- escape syntax
  - IBM Data Server Driver for JDBC and SQLJ 417
- examples
  - deregisterDB2XMLObject 125
  - registerDB2XMLSchema 125
- exceptions
  - IBM Data Server Driver for JDBC and SQLJ 128
- executable clause 424
- executeUpdate methods 46
- extended client information 105
  - DB2PreparedStatement constants 111, 113
  - DB2PreparedStatement methods 111
  - DB2ResultSet methods 113
- extended parameter information
  - IBM Data Server Driver for JDBC and SQLJ 110

## G

- getCause method 128
- getDatabaseProductName method 39
- getDatabaseProductVersion method 39

## H

- help
  - SQL statements 590
- high availability
  - client application 251
  - IBM Informix 271
- high-availability support
  - DB2 Database for Linux, UNIX, and Windows 252

- host expressions
  - SQLJ 148, 150, 418

## I

- IBM data server clients
  - alternate groups
    - DB2 for Linux, UNIX, and Windows 263
    - DB2 for z/OS 294
  - automatic client reroute
    - DB2 for z/OS 293
    - IBM Informix 276
- IBM Data Server Driver for JDBC and SQLJ
  - client info properties 107
  - compatibility with databases 3
  - connecting to data sources 29
  - connection concentrator monitoring 240
  - DB2 for z/OS servers 20
  - DB2T4XAIndoubtUtil utility 21
  - diagnostic utility 233
  - errors 555
  - example of enabling DB2 Database for Linux, UNIX, and Windows high availability support 255
  - example of enabling DB2 Database for Linux, UNIX, and Windows workload balancing support 258
  - example of enabling IBM Informix high availability support 275
  - example of enabling Sysplex workload balancing 290
  - exceptions 128
  - extended client information 105
  - installing 7
  - JDBC extensions 453
  - Kerberos security 208
  - LOB support
    - JDBC 80, 82
    - SQLJ 179
  - properties 326
  - security
    - details 201
    - encrypted password 206
    - encrypted user ID 206
    - plug-ins 212
    - user ID and password 203
    - user ID-only 205
  - SQL escape syntax 417
  - SQLExceptions 131
  - SQLSTATES 562
  - trace program example 237
  - tracing with configuration parameters example 235
  - trusted context support 215
  - type 2 connectivity
    - overview 35
  - type 4 connectivity 35
  - version determination 563
  - warnings 128
  - XML support 190
- IBM Data Server Driver for JDBC and SQLJ versions
  - associated DB2 for Linux, UNIX, and Windows versions 4
- IBM Data Server Driver for JDBC and SQLJ-only fields
  - DB2Types class 541
- IBM Data Server Driver for JDBC and SQLJ-only methods
  - DB2BaseDataSource class 456
  - DB2CallableStatement interface 464
  - DB2ClientRerouteServerList class 472
  - DB2Connection interface 473
  - DB2ConnectionPoolDataSource class 492
  - DB2DatabaseMetaData interface 494

## IBM Data Server Driver for JDBC and SQLJ-only methods

(continued)

- DB2Diagnosable interface 503
  - DB2Driver class 503
  - DB2ExceptionFormatter class 504
  - DB2FileReference class 504
  - DB2JCCPlugin interface 505
  - DB2ParameterMetaData interface 506
  - DB2PooledConnection interface 506
  - DB2PoolMonitor class 509
  - DB2PreparedStatement interface 512
  - DB2ResultSet interface 524
  - DB2ResultSetMetaData interface 525
  - DB2RowID interface 526
  - DB2SimpleDataSource class 527
  - DB2sqlca class 527
  - DB2Statement interface 528
  - DB2Struct interface 541
  - DB2SystemMonitor interface 531
  - DB2TraceManager class 534
  - DB2TraceManagerMXBean interface 537
  - DB2XADataSource class 541
  - DB2Xml interface 543
  - DBBatchUpdateException interface 455
  - DBTimestamp class 545
- ## IBM Data Server Driver for JDBC and SQLJ-only properties
- DB2BaseDataSource class 456
  - DB2ClientRerouteServerList class 472
  - DB2ConnectionPoolDataSource class 492
  - DB2SimpleDataSource class 527
- ## IBM data server drivers
- alternate groups
    - DB2 for Linux, UNIX, and Windows 263
    - DB2 for z/OS 294
  - automatic client reroute
    - DB2 for z/OS 293
    - IBM Informix 276
- ## IBM Informix
- client configuration, high-availability support 272
  - high availability
    - application programming 281
    - cluster support 271
    - workload balancing 280
- ## IBM Informix high availability support, example of enabling
- IBM Data Server Driver for JDBC and SQLJ 275
- ## implements clause
- SQLJ 420
- ## Infinity
- retrieving in Java applications 325
- ## installation
- IBM Data Server Driver for JDBC and SQLJ 7
- ## internal statement cache
- IBM Data Server Driver for JDBC and SQLJ 311
- ## isolation levels
- JDBC 127
  - SQLJ 197
- ## iterator conversion clause
- SQLJ 428
- ## iterator declaration clause
- SQLJ 422
- ## iterators
- obtaining JDBC result sets from 181
  - positioned DELETE 155
  - positioned UPDATE 155

## J

### Java

- applets
    - building (JDBC) 223
    - building (SQLJ) 225
    - using 226
  - applications
    - accessing z/OS servers 20
    - building 223
    - building (JDBC) 223
    - building (overview) 223
    - building (SQLJ) 226
    - overview 1
  - distributed transactions 306
  - Enterprise Java Beans 307
  - environment
    - customization 19
  - routines
    - building (JDBC) 224
    - building (SQLJ) 228
- ## Java 2 Platform, Enterprise Edition
- application support 299
  - containers 300
  - database requirements 301
  - Enterprise Java Beans 307
  - overview 299
  - requirements 301
  - server 300
  - transaction management 301
- ## Java Naming and Directory Interface (JNDI)
- details 301
- ## Java Transaction API (JTA) 301
- ## Java Transaction Service (JTS) 301
- ## JDBC
- 4.0
    - getColumnLabel change 552
    - getColumnName change 552
  - accessing packages 37
  - APIs 392
  - applets
    - building 223
    - using 226
  - applications
    - 24 as hour value 320
    - building 223
    - data retrieval 51
    - example 25
    - invalid Gregorian date 320
    - programming overview 25
    - transaction control 127
    - variables 42
  - ARRAY of ROW parameter 71
  - batch errors 135
  - batch queries 53
  - batch updates 46
  - compound SQL 116
  - configuring 19
  - connections 36
  - cursor OUT parameter 69
  - data type mappings 313
  - DB2 for z/OS servers 20
  - drivers
    - details 2
    - differences 547
  - environment variables 19
  - executeUpdate methods 46
  - executing SQL 42

JDBC (*continued*)  
 extensions 453  
 IBM Data Server Driver for JDBC and SQLJ installation 7  
 isolation levels 127  
 named parameter markers 101, 102, 103  
 named parameters 67  
 objects  
   creating 43  
   modifying 43  
 optimistic locking 114  
 problem diagnosis 231  
 ResultSet holdability 57  
 ResultSets  
   delete holes 62  
   holdability 56  
   inserting row 63, 64  
 routines  
   building (procedure) 224  
 ROW parameter 70  
 ROW with nested ARRAY parameter 73  
 scrollable ResultSet 56, 57  
 SQLWarning 134  
 transactions  
   committing 127  
   default autocommit modes 128  
   rolling back 127  
   updatable ResultSet 56, 57  
 JNDI (Java Naming and Directory Interface)  
   details 301  
 JTA (Java Transaction API) 301  
 JTS (Java Transaction Service) 301

## K

Kerberos authentication protocol  
 IBM Data Server Driver for JDBC and SQLJ 208

## L

large objects (LOBs)  
 compatible Java data types  
   JDBC applications 83  
   SQLJ applications 179  
 IBM Data Server Driver for JDBC and SQLJ 80, 82, 179  
 locators  
   IBM Data Server Driver for JDBC and SQLJ 81, 82  
   SQLJ 179

## M

monitoring  
 system  
   IBM Data Server Driver for JDBC and SQLJ 243  
 multi-row operations 60  
 multiple result sets  
   retrieving from stored procedure in JDBC application  
     keeping result sets open 77  
     known number 75  
     overview 75  
     unknown number 76  
   retrieving from stored procedure in SQLJ application 178

## N

named iterators  
   passed as variables 158  
   result set iterator 165  
 named parameter markers  
   CallableStatement objects 103  
   JDBC 101  
   PreparedStatement objects 102  
 named parameters  
   CALL statement  
     JDBC 67  
     SQLJ 175  
 NaN  
   retrieving in Java applications 325  
 notices 593

## O

optimistic locking  
 JDBC applications 114

## P

packages  
   JDBC 37  
   SQLJ 148  
 ParameterMetaData methods 50  
 positioned deletes  
   SQLJ 155  
 positioned iterators  
   passed as variables 158  
   result set iterators 167  
 positioned updates  
   SQLJ 155  
 PreparedStatement methods  
   SQL statements with no parameter markers 44  
   SQL statements with parameter markers 44, 52  
 problem determination  
   information available 591  
   JDBC 231  
   SQLJ 231  
   tutorials 591  
 progressive streaming  
   IBM Data Server Driver for JDBC and SQLJ 80, 82  
   JDBC 179  
 properties  
   IBM Data Server Driver for JDBC and SQLJ  
     customizing 19  
     for all database products 326  
     for DB2 Database for Linux, UNIX, and Windows 360,  
       362  
     for DB2 for z/OS 364  
     for DB2 servers 348  
     for IBM Informix 360, 362, 368  
     overview 326

## R

reference information  
   Java 313  
 registerDB2XMLSchema method 125  
 remote trace controller  
   accessing 246  
   enabling 245  
   overview 245

- resources
  - releasing
    - closing connections 137, 200
- restrictions
  - SQLJ variable names 148, 150
- result set iterator
  - public declaration in separate file 182
- result set iterators
  - details 164
  - generating JDBC ResultSets from SQLJ iterators 181
  - named 165
  - positioned 167
  - retrieving data from JDBC result sets using SQLJ iterators 181
- ResultSet
  - holdability 56
  - inserting row 63
  - testing for delete hole 62
  - testing for inserted row 64
- ResultSet holdability
  - JDBC 57
- ResultSetMetaData methods
  - ResultSetMetaData.getColumnLabel change in value 552
  - ResultSetMetaData.getColumnName change in value 552
  - retrieving result set information 55
- retrieving data
  - JDBC
    - data source information 38
    - PreparedStatement.executeQuery method 52
    - result set information 55
    - tables 51
  - SQLJ 164, 169, 170
- retrieving parameter information
  - JDBC 50
- retrieving parameter names
  - JDBC 78
- retrieving SQLCA
  - DB2Diagnosable class 198
- return codes
  - IBM Data Server Driver for JDBC and SQLJ errors 555
- rollbacks
  - JDBC transactions 127
  - SQLJ transactions 198
- routines
  - invoking
    - XML parameters in Java applications 123
- ROW parameter of CALL statement
  - JDBC 70
- ROW with nested ARRAY parameter of CALL statement
  - JDBC 73
- ROWID 185

## S

- savepoints
  - JDBC applications 96
  - SQLJ applications 189
- scrollable iterators
  - SQLJ 171
- scrollable ResultSet
  - JDBC 57
- scrollable ResultSets
  - JDBC 56
- SDKs
  - differences 554
  - version 1.5 195

- security
  - IBM Data Server Driver for JDBC and SQLJ
    - encrypted security-sensitive data 206
    - encrypted user ID or encrypted password 206
    - Kerberos 208
    - security mechanisms 201
    - user ID and password 203
    - user ID only 205
  - plug-ins
    - JDBC support 212
    - SQLJ program preparation 221
  - SET TRANSACTION clause 427
  - setTransactionTimeout method 306
  - SQL statements
    - error handling
      - SQLJ applications 198
    - executing
      - JDBC interfaces 42
      - SQLJ applications 154, 184
    - help
      - displaying 590
  - SQLException
    - IBM Data Server Driver for JDBC and SQLJ 131
  - SQLJ
    - accessing packages for 148
    - applets
      - building 225
      - using 226
    - applications
      - 24 as hour value 320
      - building 226
      - compiler options (UNIX) 227
      - compiler options (Windows) 228
      - examples 139
      - invalid Gregorian date 320
      - programming 139
      - transaction control 197
    - assignment clause 428
    - batch updates 160
    - building routines 228
    - calling stored procedures 174
    - clauses 418
    - collecting trace data 231
    - comments 154
    - compound SQL 116
    - connecting to data source 141
    - connecting using default context 148
    - connection declaration clause 422
    - context clause 424, 425
    - cursor OUT parameter 176
    - DataSource interface 144, 146
    - DB2 tables
      - creating 154
      - modifying 154
    - DriverManager interface 141, 143
    - drivers 2
    - environment variables 19
    - error handling 198
    - executable clauses 424
    - executing SQL 154
    - execution context 184
    - execution control 184
    - existing connections 147
    - host expressions 148, 150, 418
    - implements clause 420
    - installing runtime environment 19
    - isolation levels 197



- SQLJ (*continued*)
  - iterator conversion clause 428
  - iterator declaration clause 422
  - multiple instances of iterator 170
  - multiple iterators on table 169
  - named parameters 175
  - problem diagnosis 231
  - Profile Binder command 580
  - Profile Printer command 586
  - program preparation 564
  - result set iterator 164
  - retrieving SQLCA 198
  - routines
    - compiler options (UNIX) 229
    - compiler options (Windows) 230
  - scrollable iterators 171
  - SDK for Java Version 5 functions 195
  - security 221
  - SET TRANSACTION clause 427
  - SQLWarning 199
  - statement reference 418
  - transactions 198
  - translator command 564
  - variable names 148, 150
  - with-clause 420
- sqlj command 564
- SQLJ variable names
  - restrictions 148, 150
- sqlj.runtime package 429
- sqlj.runtime.ASCIIStream 441, 451
- sqlj.runtime.BinaryStream 441
- sqlj.runtime.CharacterStream 442
- sqlj.runtime.ConnectionContext 430
- sqlj.runtime.ExecutionContext 443
- sqlj.runtime.ForUpdate 434
- sqlj.runtime.NamedIterator 435
- sqlj.runtime.PositionedIterator 435
- sqlj.runtime.ResultSetIterator 436
- sqlj.runtime.Scrollable 438
- sqlj.runtime.SQLNullException 451
- sqlj.runtime.UnicodeStream 453
- SQLSTATE
  - IBM Data Server Driver for JDBC and SQLJ errors 562
- SQLWarning
  - IBM Data Server Driver for JDBC and SQLJ 134
  - SQLJ applications 199
- SSID
  - IBM Data Server Driver for JDBC and SQLJ 374
- SSL
  - configuring
    - Java Runtime Environment 218
    - IBM Data Server Driver for JDBC and SQLJ 217
  - sslConnection property 218
- sslConnection property 218
- statement caching
  - IBM Data Server Driver for JDBC and SQLJ 311
- Statement.executeQuery 51
- stored procedures
  - calling
    - CallableStatement class 65
    - JDBC applications 95
    - SQLJ applications 174, 188
  - DB2 for z/OS 65
  - keeping result sets open in JDBC applications 77
  - retrieving result sets
    - known number (JDBC) 75
    - multiple (JDBC) 75

- stored procedures (*continued*)
  - retrieving result sets (*continued*)
    - multiple (SQLJ) 178
    - unknown number (JDBC) 76
- Sysplex
  - direct connections to DB2 for z/OS 292
  - support 285
- Sysplex support, example of enabling
  - IBM Data Server Driver for JDBC and SQLJ 290

## T

- terms and conditions
  - publications 591
- time stamps
  - data loss avoidance
    - JDBC applications 323
    - SQLJ applications 323
- time value adjustment
  - JDBC applications 320
  - SQLJ applications 320
- TIMESTAMP data type
  - data loss
    - JDBC applications 323
    - SQLJ applications 323
- TIMESTAMP WITH TIME ZONE
  - IBM Data Server Driver for JDBC and SQLJ 87, 186
- trace controller 245
- traces
  - IBM Data Server Driver for JDBC and SQLJ 231, 235, 237
- transaction control
  - JDBC 127
  - SQLJ 197
- transaction-level load balancing
  - client application 251
- troubleshooting
  - online information 591
  - tutorials 591
- trusted contexts
  - JDBC support 215
- tutorials
  - list 590
  - problem determination 591
  - troubleshooting 591
  - Visual Explain 590

## U

- UNIX
  - SQLJ applications 227
  - SQLJ routines 229
- updatable ResultSet
  - inserting row 63
  - JDBC 56, 57
  - testing for delete hole 62
  - testing for inserted row 64
- updates
  - data
    - PreparedStatement.executeQueryUpdate method 44
- URL format
  - DB2BaseDataSource class 30, 32
- user ID and password security
  - IBM Data Server Driver for JDBC and SQLJ 203
- user ID-only security
  - IBM Data Server Driver for JDBC and SQLJ 205

## W

- warnings
  - IBM Data Server Driver for JDBC and SQLJ 128
- Windows
  - SQLJ applications 228
  - SQLJ routines 230
- with clause
  - SQLJ 420
- workload balancing
  - IBM Informix
    - operation 280
- workload balancing, operation
  - connections to DB2 Database for Linux, UNIX, and Windows 266

## X

- XML
  - IBM Data Server Driver for JDBC and SQLJ 190
  - parameters
    - invoking routines from Java programs 123
- XML data
  - Java applications 117
  - updating
    - tables in Java applications 117, 191
- XML data retrieval
  - Java applications 120, 193
- XML schemas
  - registering 125
  - removing 125
- XMLCAST
  - SQLJ applications 195







Printed in USA

SC27-3875-00



Spine information:

IBM DB2 10.1 for Linux, UNIX, and Windows

Developing Java Applications

