

WAVV 2008



# SOA Concepts and z/VSE: Implementing SOA using Web Services and Tools

Wilhelm Mild  
z/VSE Solution Architect  
[zvse@de.ibm.com](mailto:zvse@de.ibm.com)

# Trademarks

The following are trademarks of the International Business Machines Corporation in the United States and / or other counties.

AIX*	IBM logo*	SQL/DS
CICS*	IMS	Virtual Image Facility
CICS/VSE*	Intelligent	VisualAge*
C/370	Language Environment*	VisualGen*
DB2*	Miner	VM/ESA*
DB2 Connect	MQSeries*	VSE/ESA
DB2 Universal Database	Multiprise*	VTAM*
DFSORT	MVS	WebSphere*
e-business logo*	OS/2*	xSeries*
eServer	OS/390*	z/Architecture
Enterprise Storage Server*	OS/400*	z/OS*
HiperSockets	Rational*	z/VM
IBM*	S/390*	z/VSE
	SNAP/SHOT*	zSeries*
		System z

\* Registered trademarks of IBM Corporation

The following are trademarks or registered trademarks of other companies.

LINUX is a registered trademark of Linus Torvalds in the United States, other countries, or both.

Tivoli is a trademark of Tivoli Systems Inc.

Java and all Java-related trademarks and logos are trademarks of Sun Microsystems, Inc., in the United States and other countries

UNIX is a registered trademark of The Open Group in the United States and other countries.

Microsoft, Windows the Windows 95 logo, and Windows NT, are registered trademarks of Microsoft Corporation.

SET and Secure Electronic Transaction are trademarks owned by SET Secure Electronic Transaction LLC.

Intel is a registered trademark of Intel Corporation.

Other company, product, and service names, may be trademarks or service marks of others.

## Customers & Analysts Agree:

*SOA Enables Rapid & Incremental Change Leading to Innovation*



### Innovation That Matters \*

*“The IBM and GenXus SOA-based solution has made our product **more innovative**, **expanded our market** and made us **more competitive**. It will let us grow our business significantly in the years to come.”*



*“SOA is the **heart of the next wave of innovation**. The leaders that do this well are able to **rapidly change** ...”*



*“SOA is critical for ... executing the on-demand vision and in preparing ... for the **incremental changes** ... over time. Companies ... make better decisions.”*



# HTML - Traditional Internet Technology

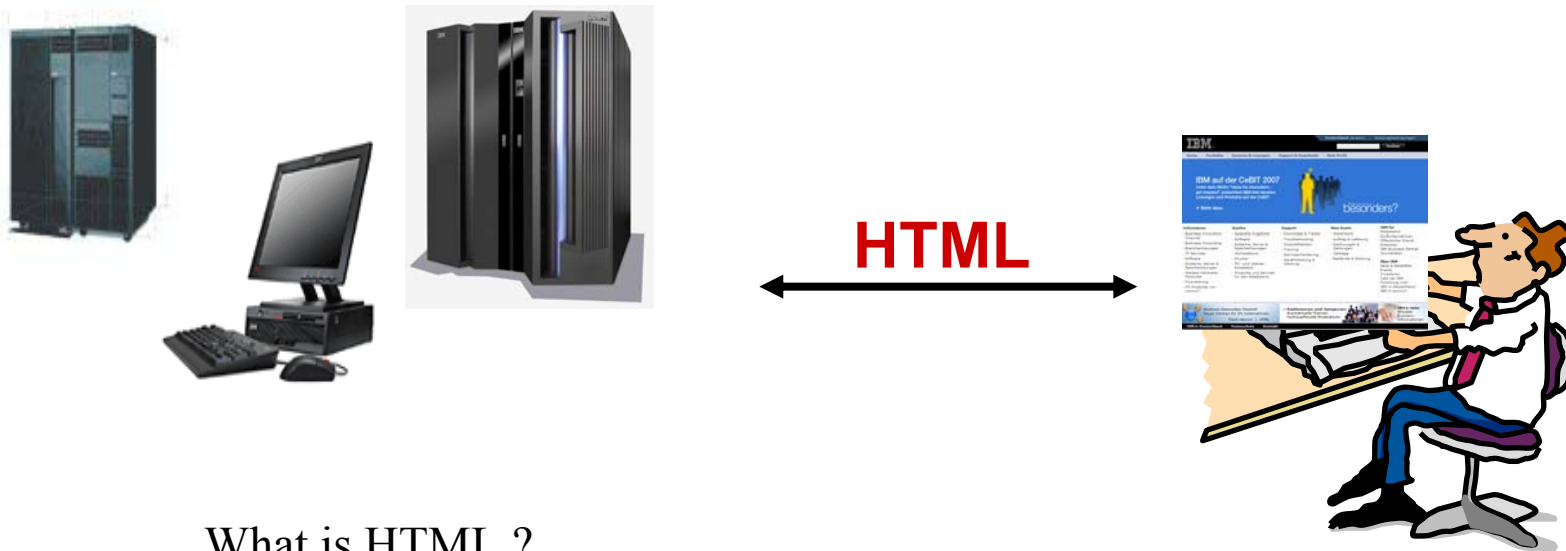

What is HTML ?

- the most successful markup language ever
- with the used tags, an HTML document can be seen on all platforms from Palmtops to mainframe
- extension interfaces like CGI (Common Gateway Interface) and Java (applets, servlets, EJB) allow access to backend systems
- **HTML was designed with humans in mind**

## XML - was designed for program communication

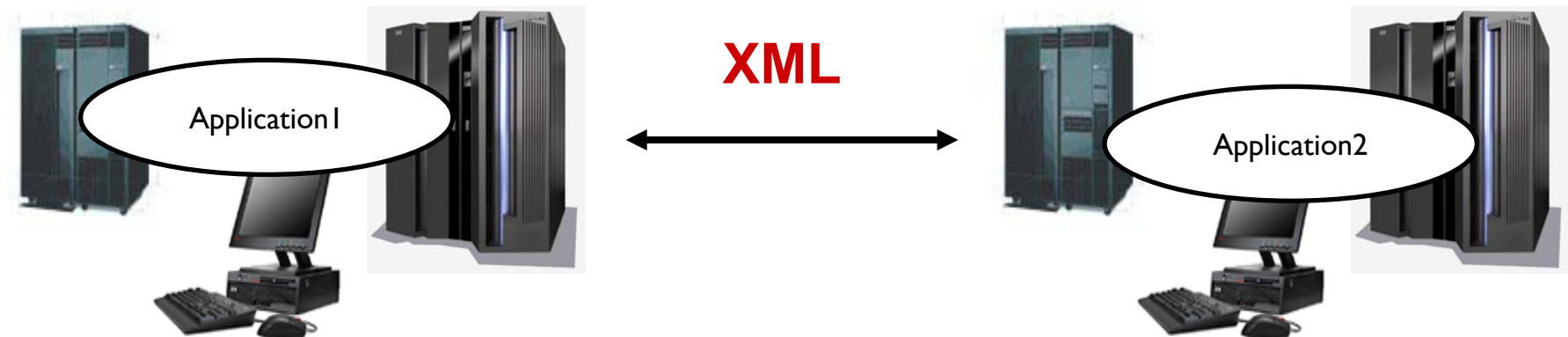

### Today's Requirements for flexible solutions:

- Enterprise wide integration of:
  - information
  - processes
- Reduction of Data Redundancy and complexity
- Standard Internet protocols,
- Application integration
  - Programming Language independent,
  - Platform independent,
  - Architecture independent,

# XML - eXtended Markup Language

## the platform independent data representations

- HTML - contains tags to tell a browser how to display information  
- but not WHAT that information is
- **XML was designed with applications in mind** (distributed application)
- XML has information about structure and content of information
- XML supports **attributes** that hold additional information about a **tag**
- HTML can be written within XML

### An address in HTML

```
<p>  
<b>Mrs. Mary Brown</b>  
<br>  
1401 MainStreet  
<br>  
Winston Salem, WN 34123  
</p>
```

### An address in XML

```
<address>  
  <title>Mrs.</title>  
  <firstname>Mary</firstname>  
  <lastname>Brown</lastname>  
  <street>1401 MainStreet</street>  
  <city state="WN">Winston Salem</city>  
  <postalcode type="int">34123</postalcode>  
</address>
```

# Typical VSE Customer Environment Data interchange

- VSAM data on VSE (some DB2 environments)
- Relational databases on distributed platforms (DB2, Oracle)
- Data interchange via FTP
- **Applications are platform specific**

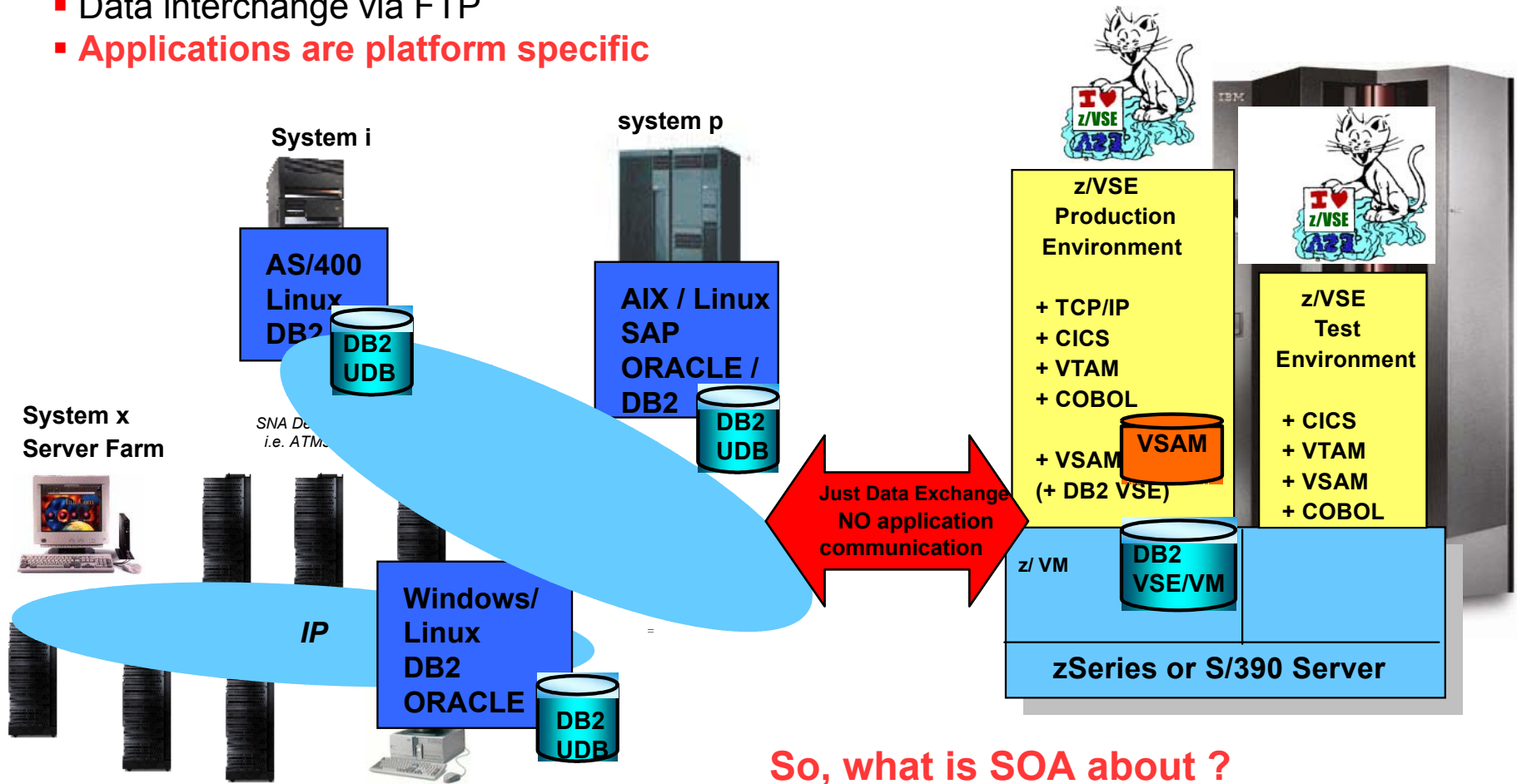

So, what is SOA about ?

## What is Service Oriented Architecture (SOA) ?

### (1) SOA is a Concept for IT Business Management

A Service-Oriented Architecture (SOA) is focused on developing technology to accomplish your business tasks.

- **eliminate technological constraints** that dictate the activities (i.e op. system and data organization constraints)
- it is **organized around actual activities, or business services**, rather than the different individual silos of information maintained by departments of the company to enable:
  - a greater alignment of business and IT
  - A network-based infrastructure, enabling geographically and technologically diverse resources to work together
  - On-demand, built-on-the-fly-applications
  - Greater code reuse
  - Better process standardization throughout the enterprise
  - Easier centralization of corporate control



“ While deploying technology is certainly key to a successful SOA integration, it is the maximizing of the people, process and information elements that are truly core to the SOA process.”

Judith Hurwitz  
President, Hurwitz & Assoc.

***SOA is more than just about technology, but technology's integration with business insight and thought leadership.***



## What is Service Oriented Architecture (SOA) ?

### (2) SOA is an new IT Architectural Concept

- SOA is represented in "loosely coupled" application components:
  - not tied to a particular database,
  - not tied to a particular infrastructure.
  - self-contained
  - with well-defined interfaces
- Services enable the combination of themselves:
  - to extend existing business logic
  - to create new applications.
- Services can be accessed over a network.
  - the network may exist within your corporate, or it may be geographically and technologically diverse
  - the access is as though they were all installed on your local desktop.
- It enables much greater code reuse,
- cutting your workload at the same time that it increases your capabilities.
- enables your business to adapt to changing conditions and requirements



*SOA is more than just doing the same thing a different way.*

## The SOA Architecture - Standards

- **Web Services**
  - defined Services
  
- **XML** (eXtended Markup Language)
  - platform independent data representation
  
- **SOAP** (Simple Object Access Protokol)
  - protocol for Web Services
  
- **UDDI** (Universal Description Discovery Integration)
  - catalog to register and find Web Services
  
- **WSDL** (Web Services Description Language)
  - language in which the Web Services describes
  
- **Enterprise Service Bus**
  - The Plug for the Services

# What are Web Services ?

„WebServices are self-contained, modular applications that can be described, published, located, and invoked over a network, generally, the World Wide Web.“ **IBM**

“A WebService is programmable application logic, accessible using standard Internet protocols“ **Microsoft**

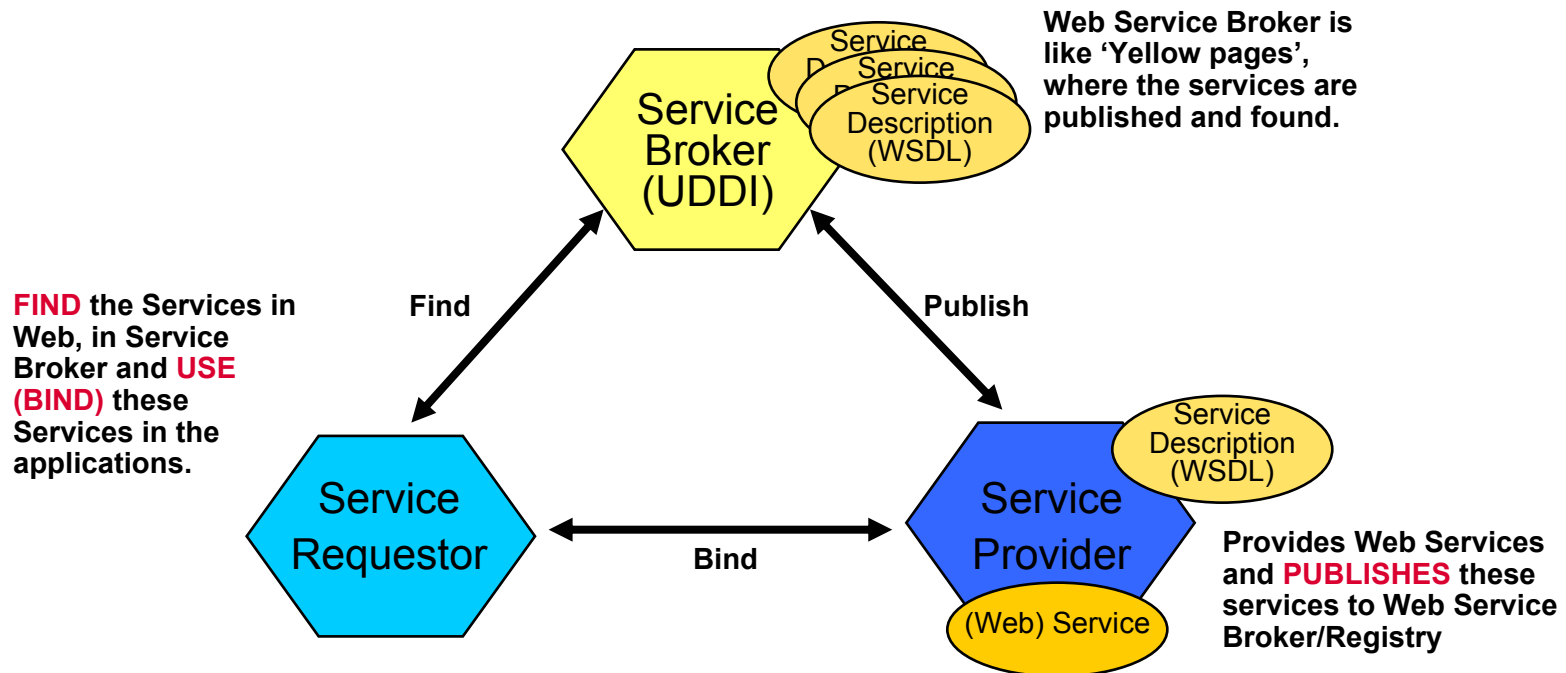

# What is XML ?

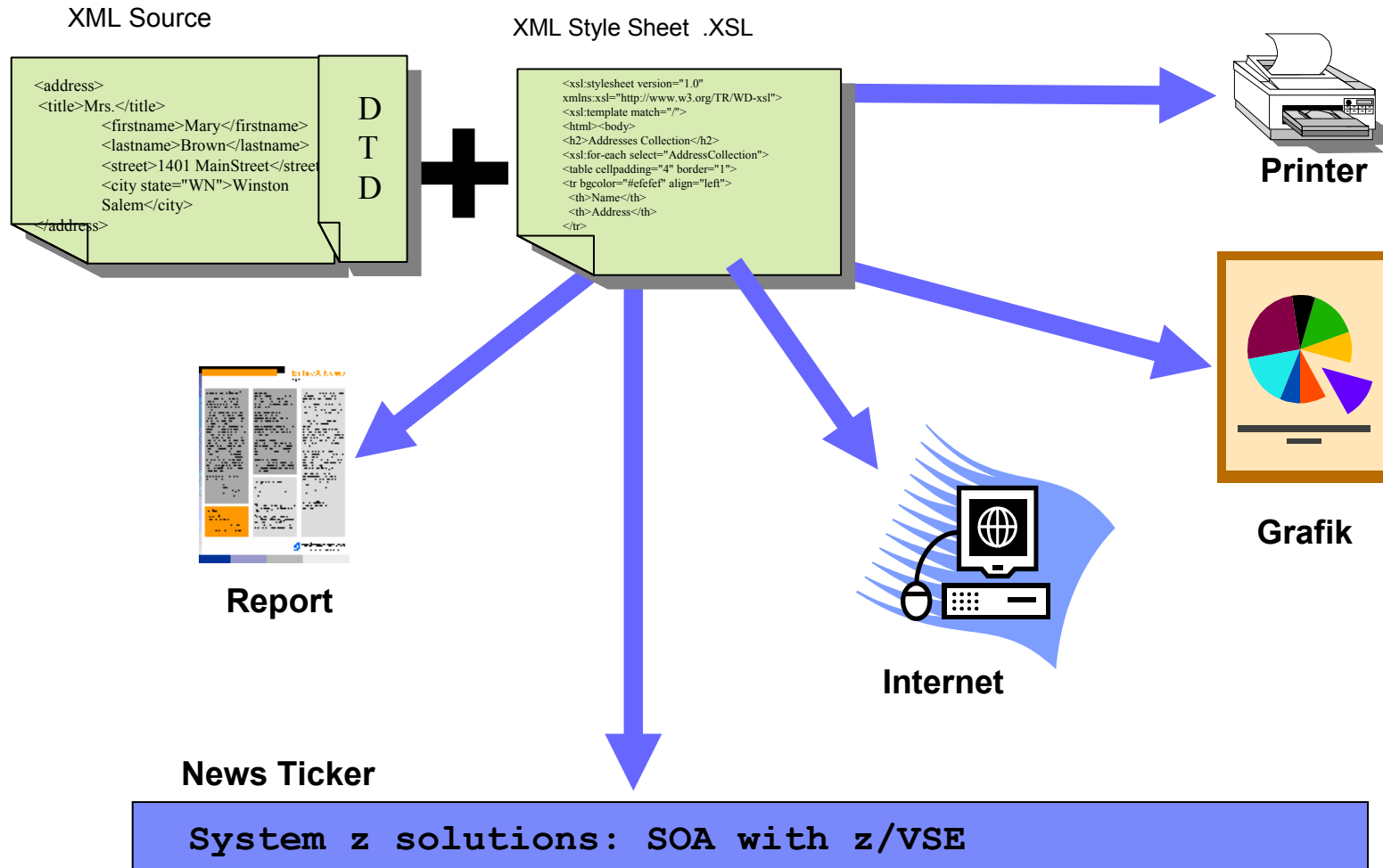

# XML parser Technology (DOM,SAX)

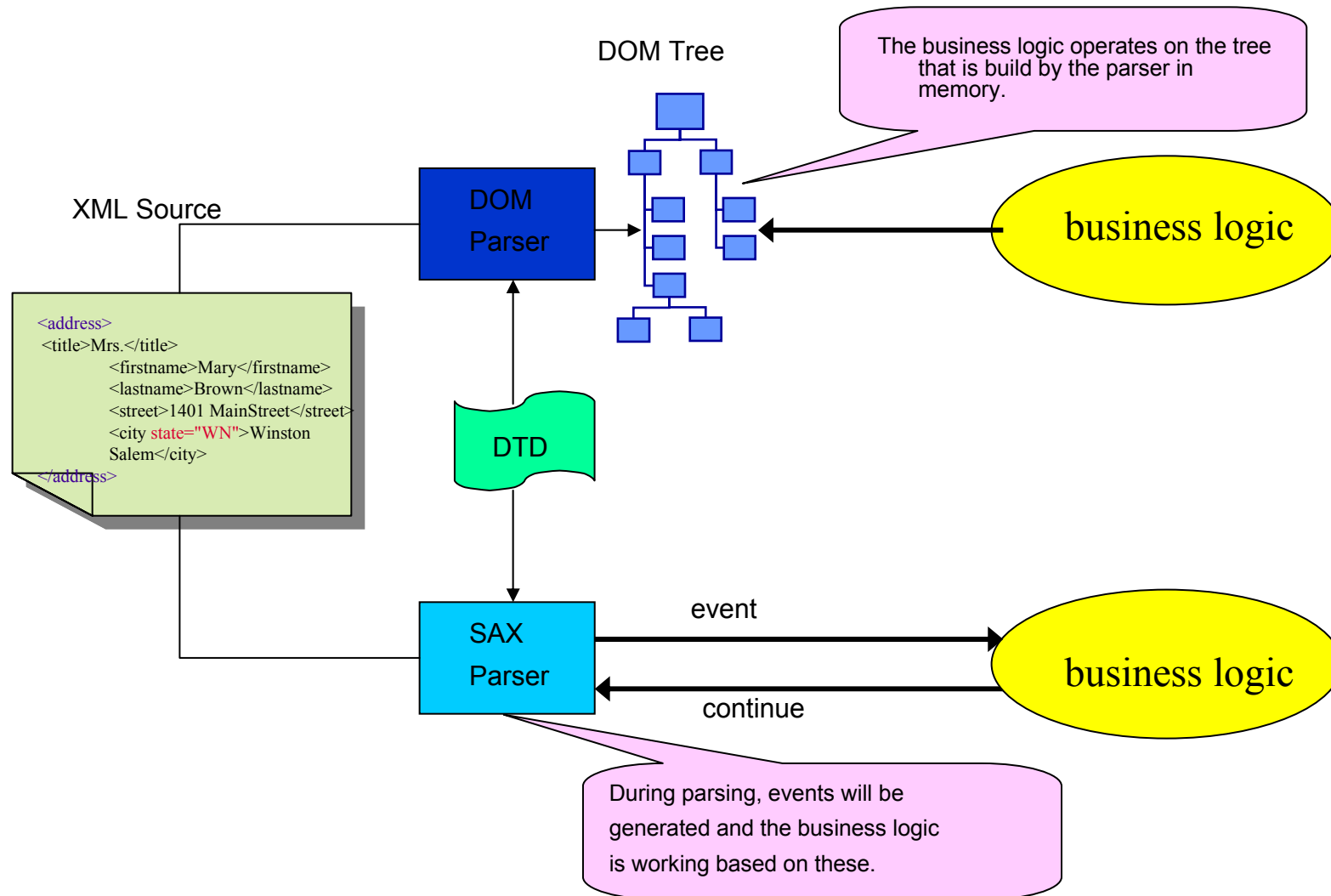

# What is SOAP?

- **Simple Object Access Protocol**
- **SOAP is an **XML** based protocol for communication between two remote applications:**
  - ▶ is based on RPC messaging
  - ▶ is language independent (de-couples interface from implementation)
  - ▶ represents remote procedure calls and responses
- **A SOAP message consists of:**

- ▶  **envelope**

- wraps the message itself
- defines rules for decoding the message

- ▶  **message**

- request
  - method to invoke on a remote object and parameters
- response
  - result of running the method and exceptions

## What is UDDI?



- **Universal Description, Discovery and Integration**
- **UDDI is a specification for publishing and discovery of businesses and the services they provide**
- **UDDI specifications define how to construct UDDI Business Registries**
- **UDDI specifications are based on XML and SOAP:**
  - ▶ **API to communicate with a UDDI Registry are SOAP based**
    - UDDI4J (UDDI for Java) - Open Source implementation in Java
    - JAXR (Java API for XML Registries) - Sun
  - ▶ **data structures that define Web Service in UDDI Registry are XML based**

# What is WSDL?

- **Web Services Description Language**
- **WSDL is an XML based vocabulary for defining a Web Service:**
  - ▶ interfaces
    - operation types (i.e. one-way, request-response, notification)
    - messages defining a Web Service interface
    - definition of data types (XML Schema)
  - ▶ access protocol (i.e. SOAP over HTTP)
  - ▶ contact endpoints (i.e. Web Service URL and URNs<sup>1</sup>)

(1URNs are location independent pointers to a file, or to different representations of the same content. In most ways they can be used like URLs)



- **A Web Service URL returning WSDL makes Web Services self-describing**
- **Similar in purpose to IDL (Interface Definition Language)**
  - From a WSDL file, wizards can generate:
    - proxy classes for calling Web Service
    - skeleton classes to implement a Web Service

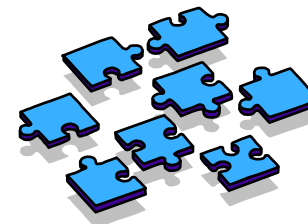



# What is an Enterprise Service Bus?

***An Enterprise Service Bus (ESB) is a flexible Infrastructure for services and application integration***

***An ESB reduces the number, size and complexity of your interfaces in a SOA solution.***

***An ESB realizes following tasks between requestor and service***

- **ROUTING** of messages between Services
- **CONVERTING** the transport protocol between requestor and service
- **TRANSFORMING** message formats between requestor and service
- **HANDLING** of business events between different types of services

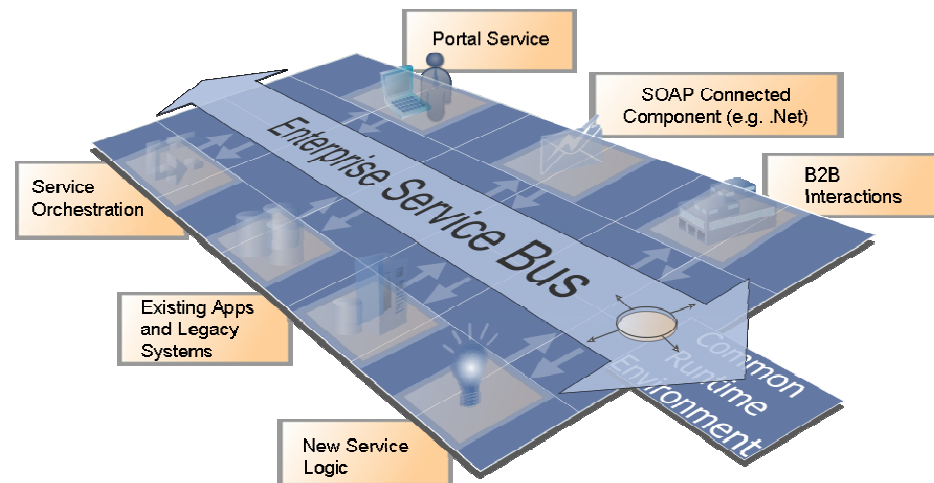

## Call a Web Services with Java or MS .Net

- **Call** an existing Web Service
  - Locate the Web Service Description (WSDL) for the Web Service you want to access
  - Use a tool like Rational Application Developer (RAD) or Microsoft Visual Studio and import the WSDL
    - Generate “proxy code” that implements all things needed to invoke the Web Service
    - Applications call a function of the proxy code as it would implement the service by itself

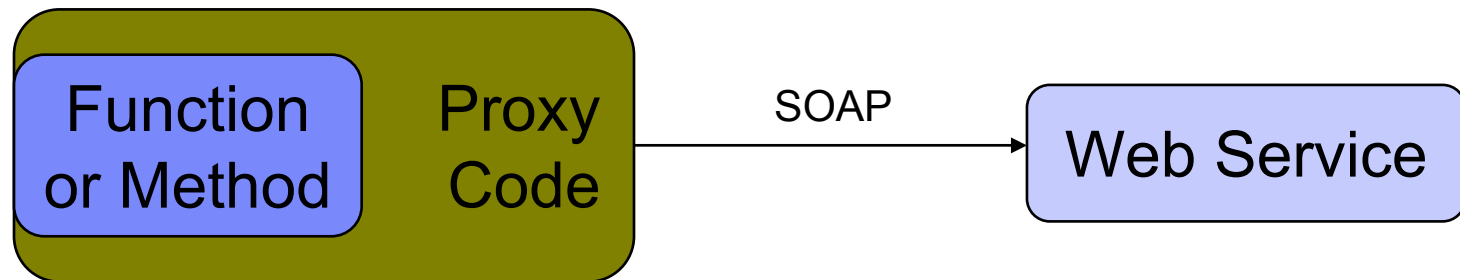

## Using Web Services with Java or MS .Net

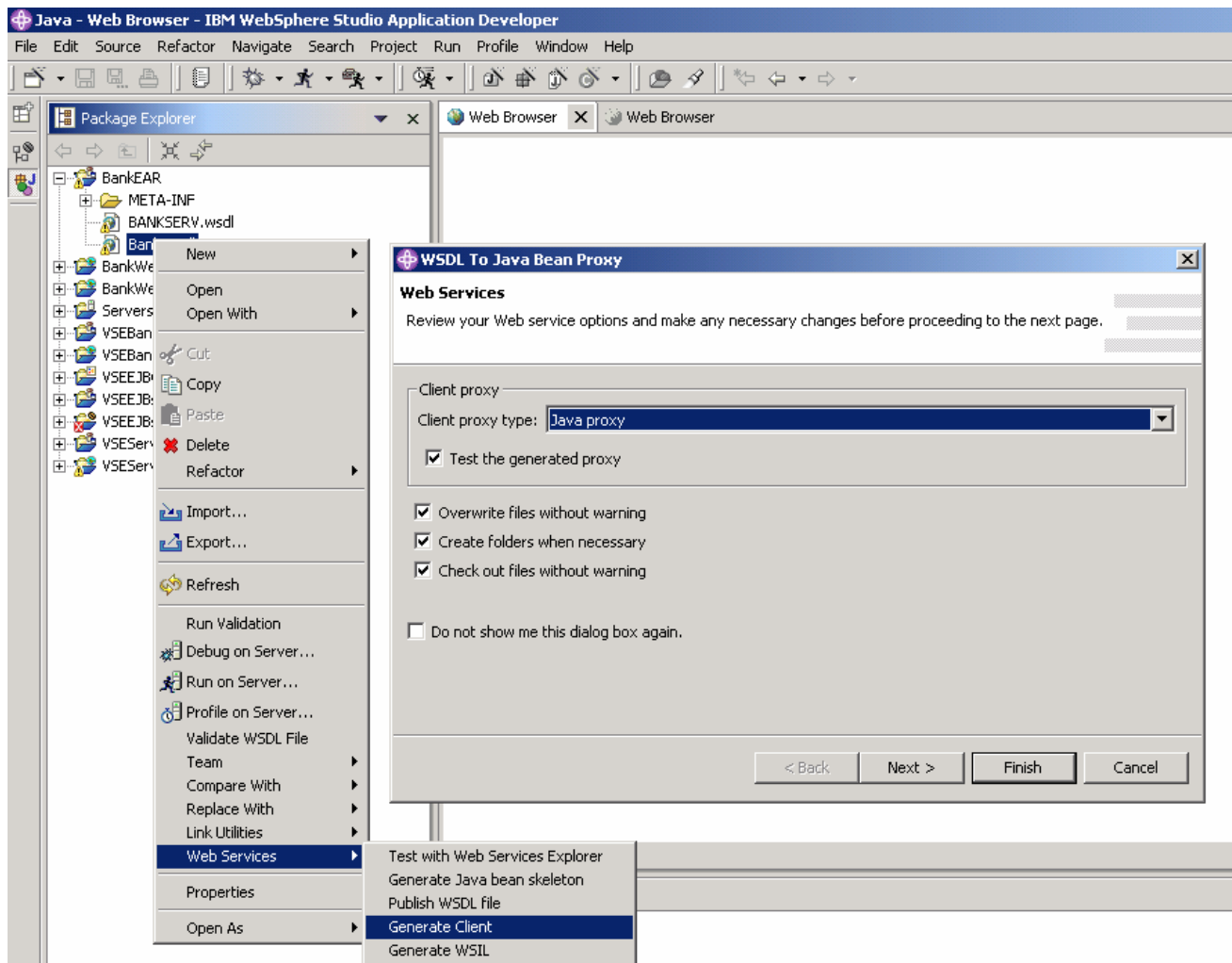

## Create a Web Services in Java or MS .Net

- **Create/provide** a new Web Service
  - You have a callable business logic that you want to transform into a Web Service
  - Use a tool like Rational Application Developer (RAD) or Microsoft Visual Studio to model a Web Service
    - Generate a Web Service Description (WSDL) and publish it
    - Generate “proxy code” that makes the function or method callable from outside as a Web Service via SOAP
    - Deploy it in an application server

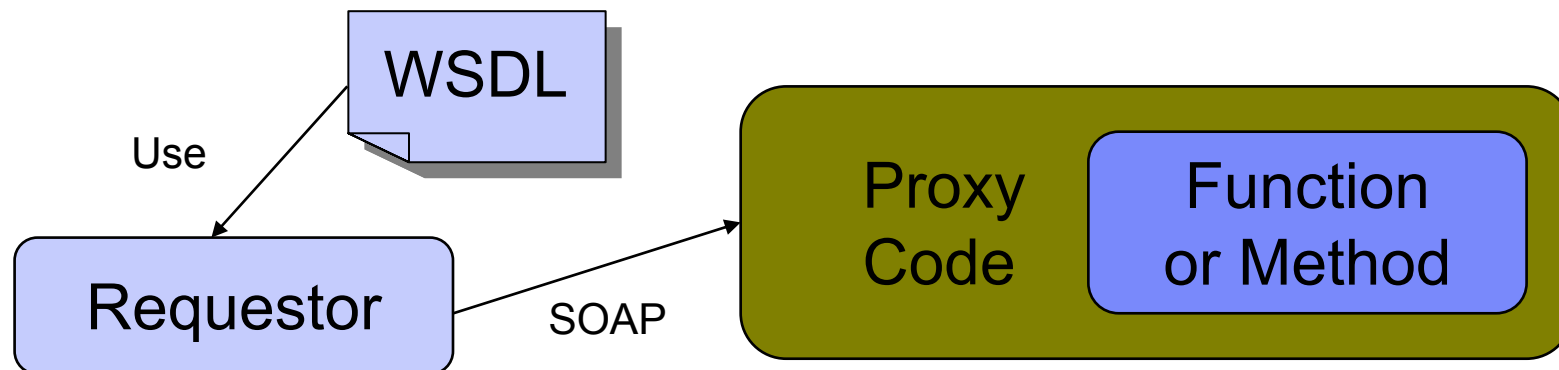

# Create a Web Services in Java or MS .Net

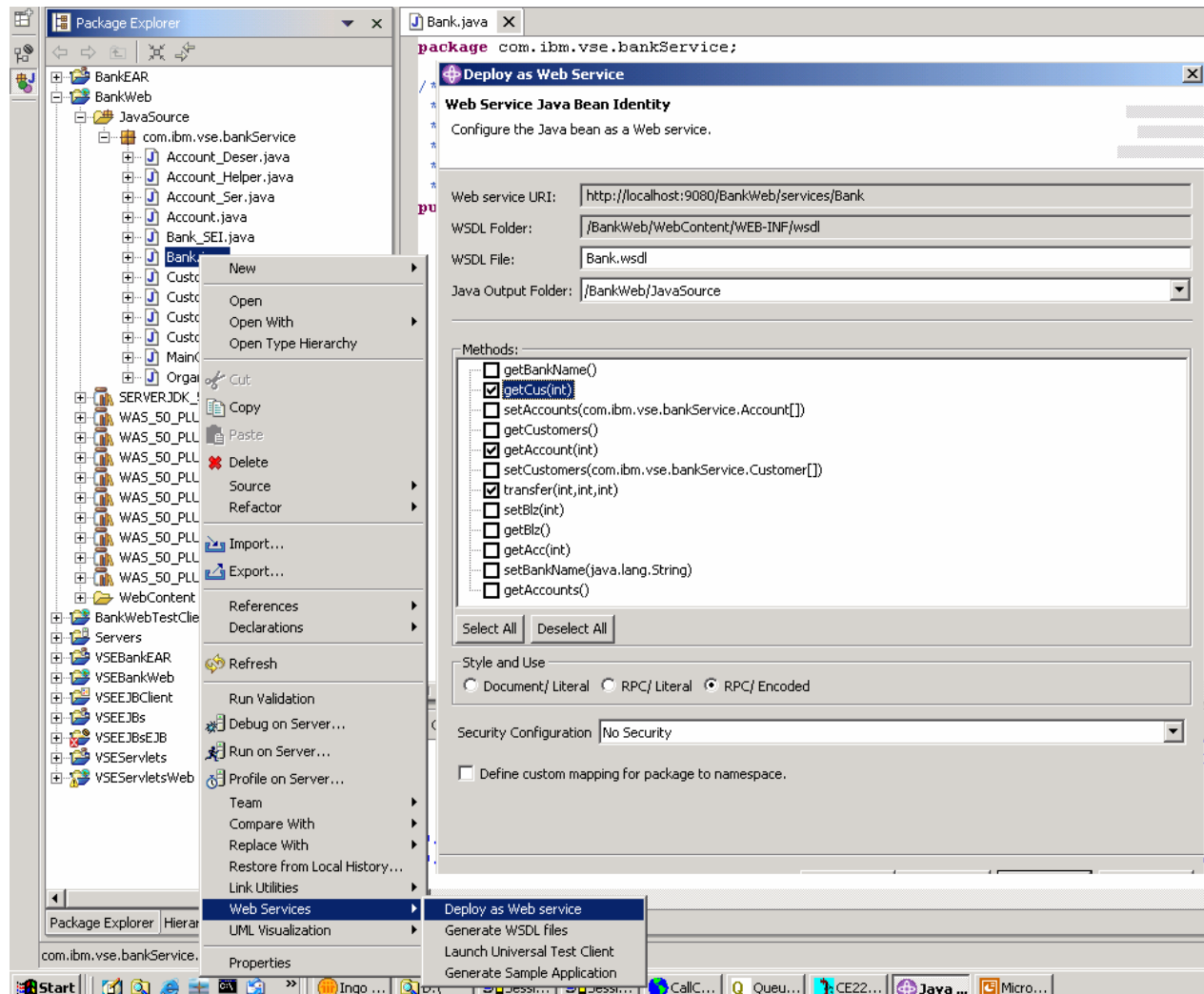

# Web Services in action

**XML Document + SOAP Protocol = Web Services**

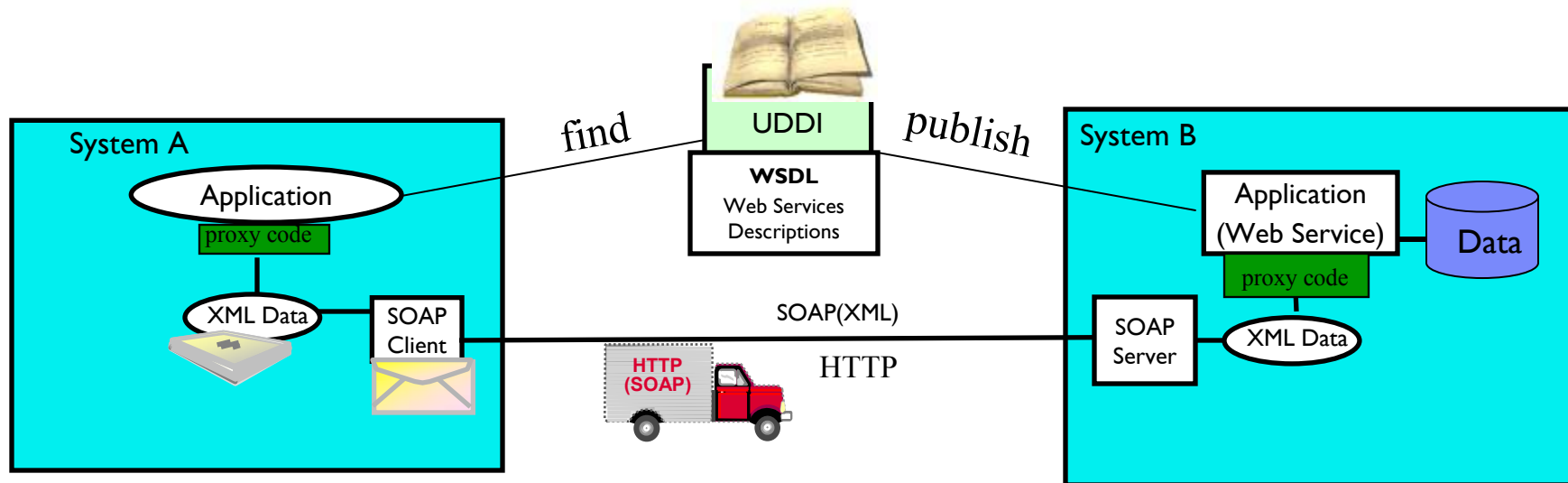

- XML -
- SOAP -
- HTTP - Carrier
- TCP/IP - Street
- UDDI - Yellow pages

## A web service

- ☞ is intended for application communication
- ☞ implements a business logic, application or system functionality
- ☞ is useable in internet, intranet, extranet
- ☞ is useable for browser-based solutions up to the integration between companies
- ☞ uses only standard internet technologies

## Why should VSE customers consider SOA?

- **SOA is modern (hype) and strategic**
  - It is mentioned in all IT journals and newspapers
- **Easy integration of existing VSE programs and processes**
  - Reducing the interface complexity
  - Reuse of existing application logic as services
  - Use of standard protocols (XML, SOAP, HTTP)
- **integration is platform independent**
  - independent of application programming language
  - independent of the data involved
- **Integration of VSE logic with a Microsoft .Net environment**
  - without the use of Java
  - the most incompatible environments can be integrated
- **SOA enables the extension of VSE applications**
  - to other platforms and architectures
  - to partners and open world

# VSE as SOAP server

## Web Services (SOAP)

SOAP - Simple Object Access Protocol  
(platform independent remote procedure call)

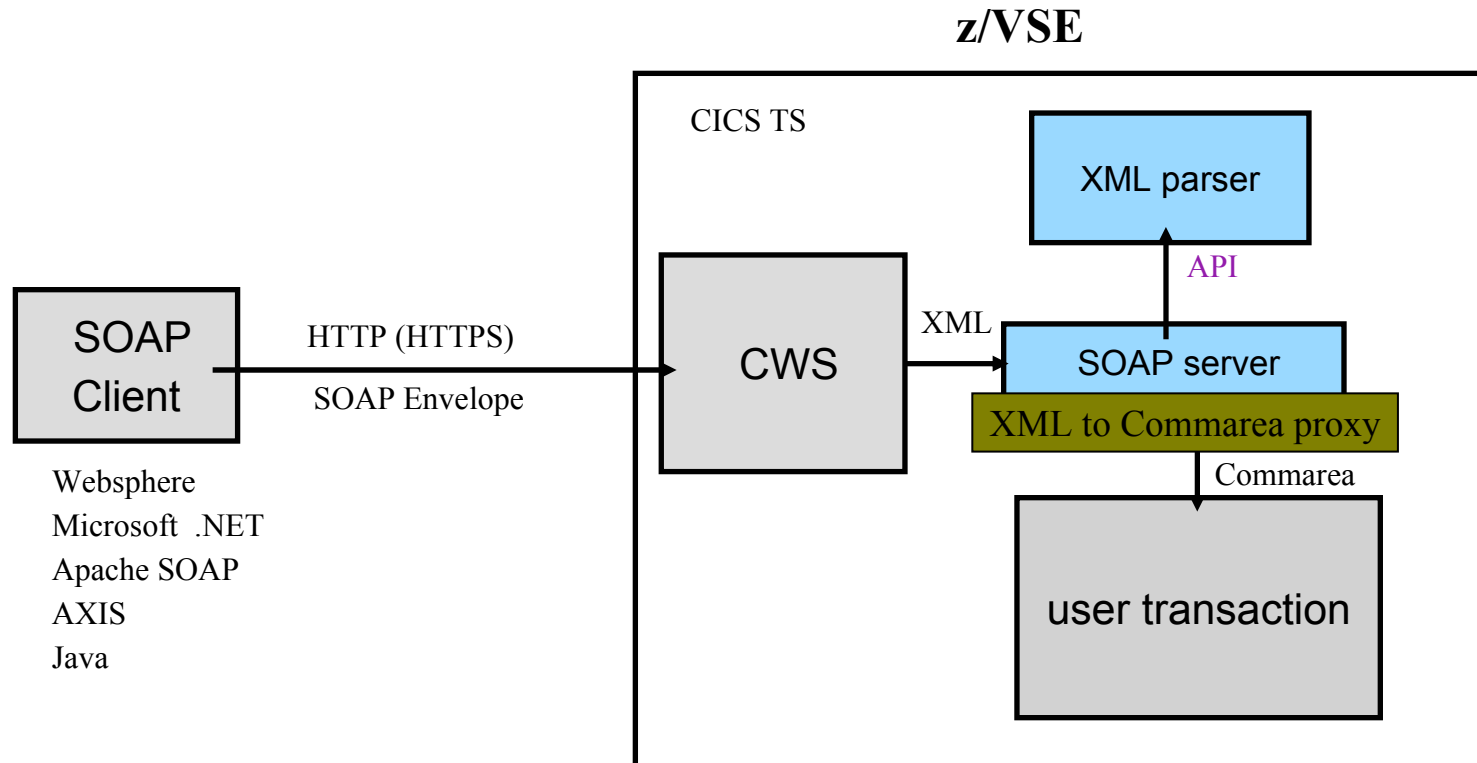



# VSE as SOAP client

## Web Services (SOAP)

SOAP - Simple Object Access Protocol  
(platform independent remote procedure call)

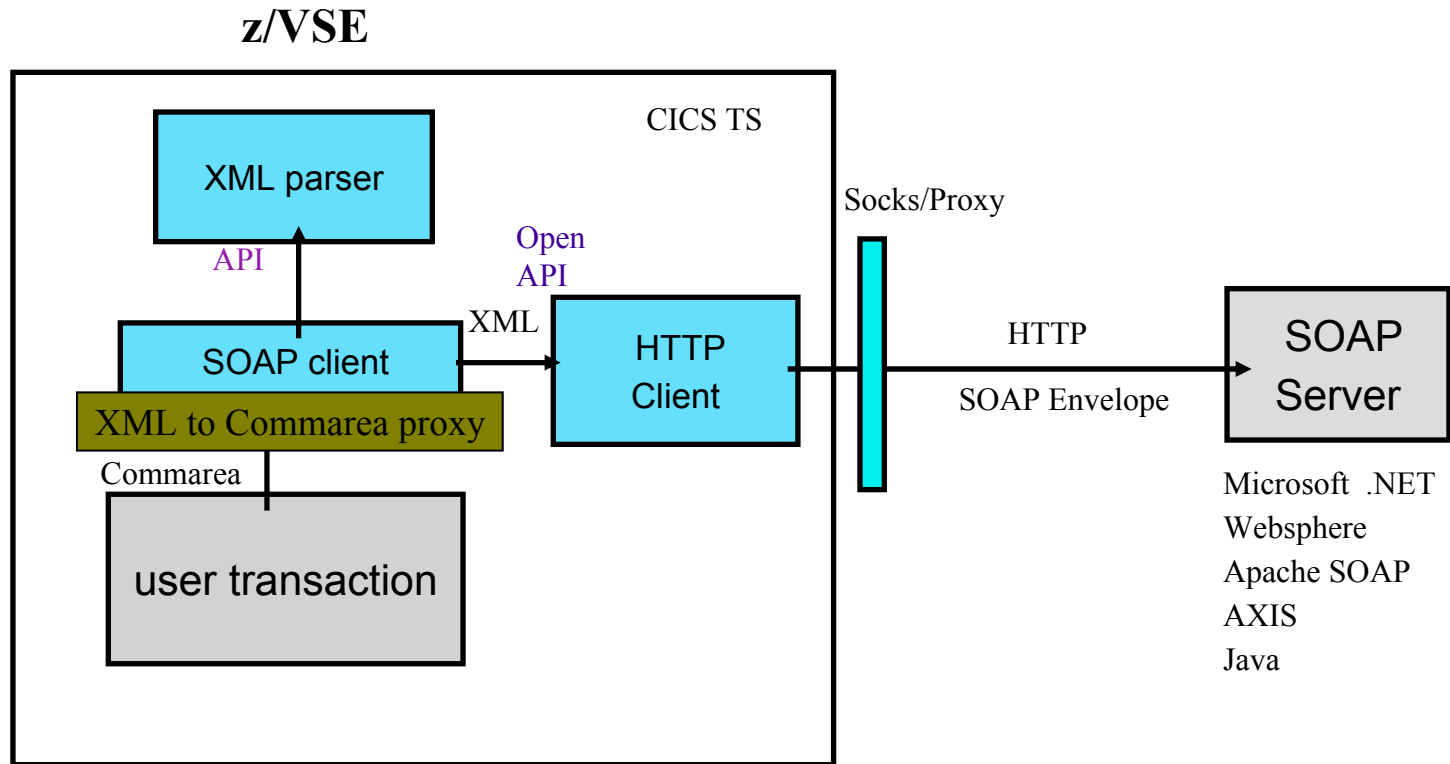

# Web Services in and with VSE

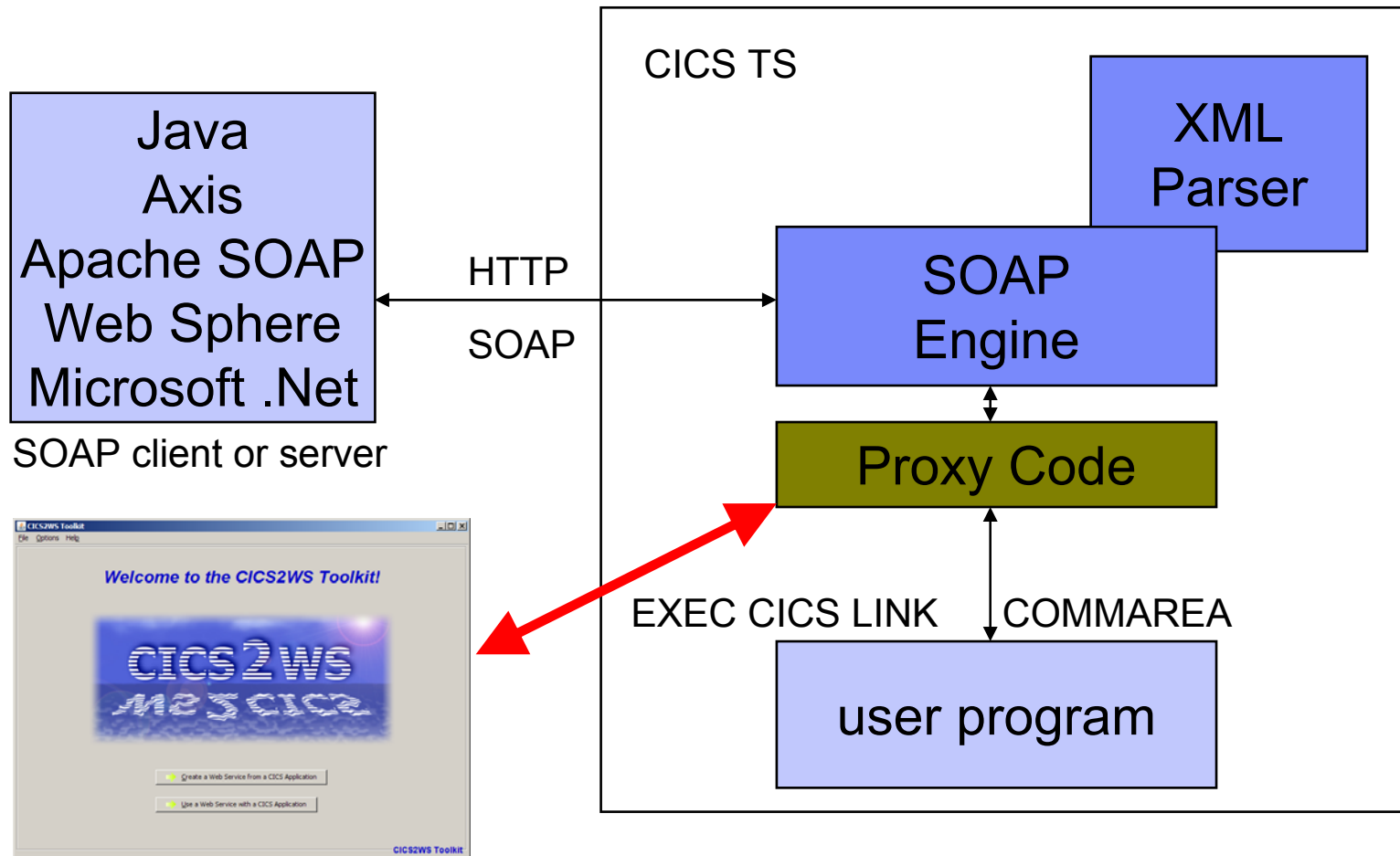

Tool to generate the Proxy code

## VSE as a SOAP server (service provider)

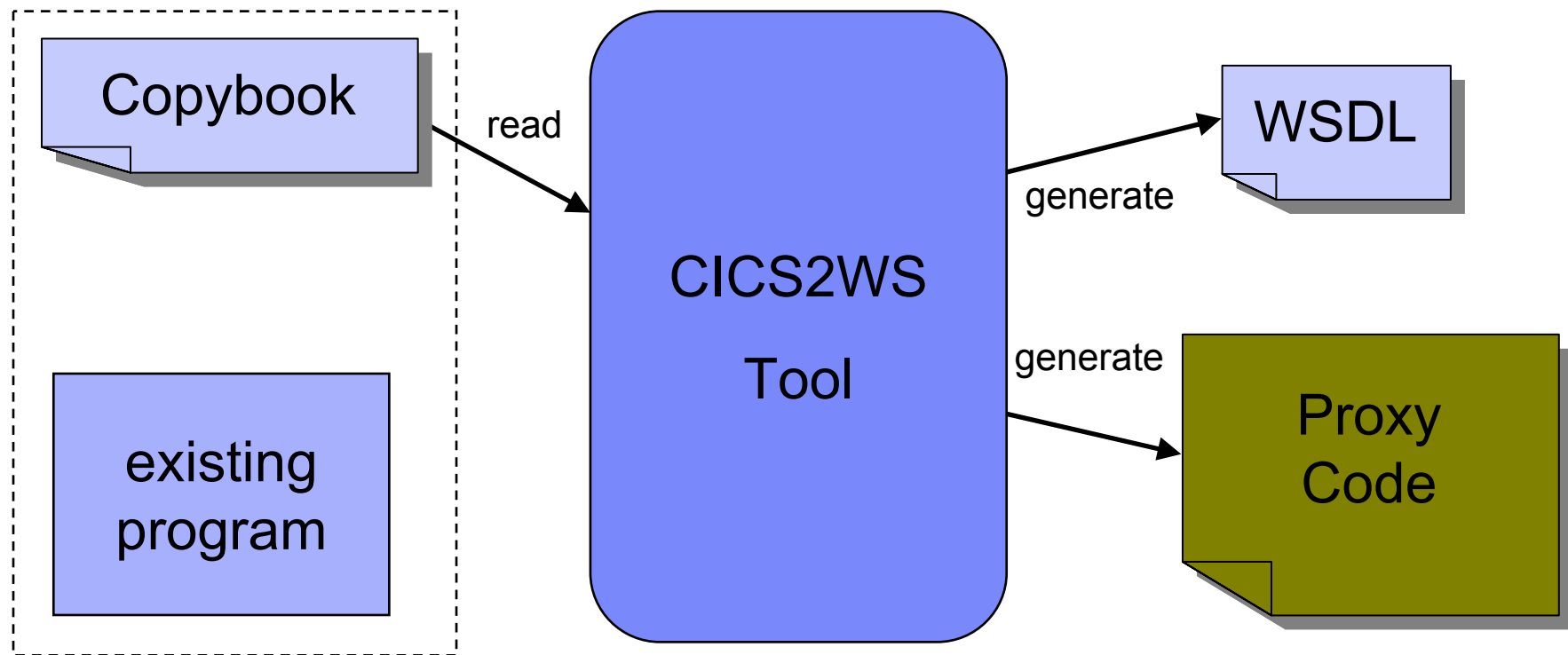

## VSE as a SOAP client (service requestor)

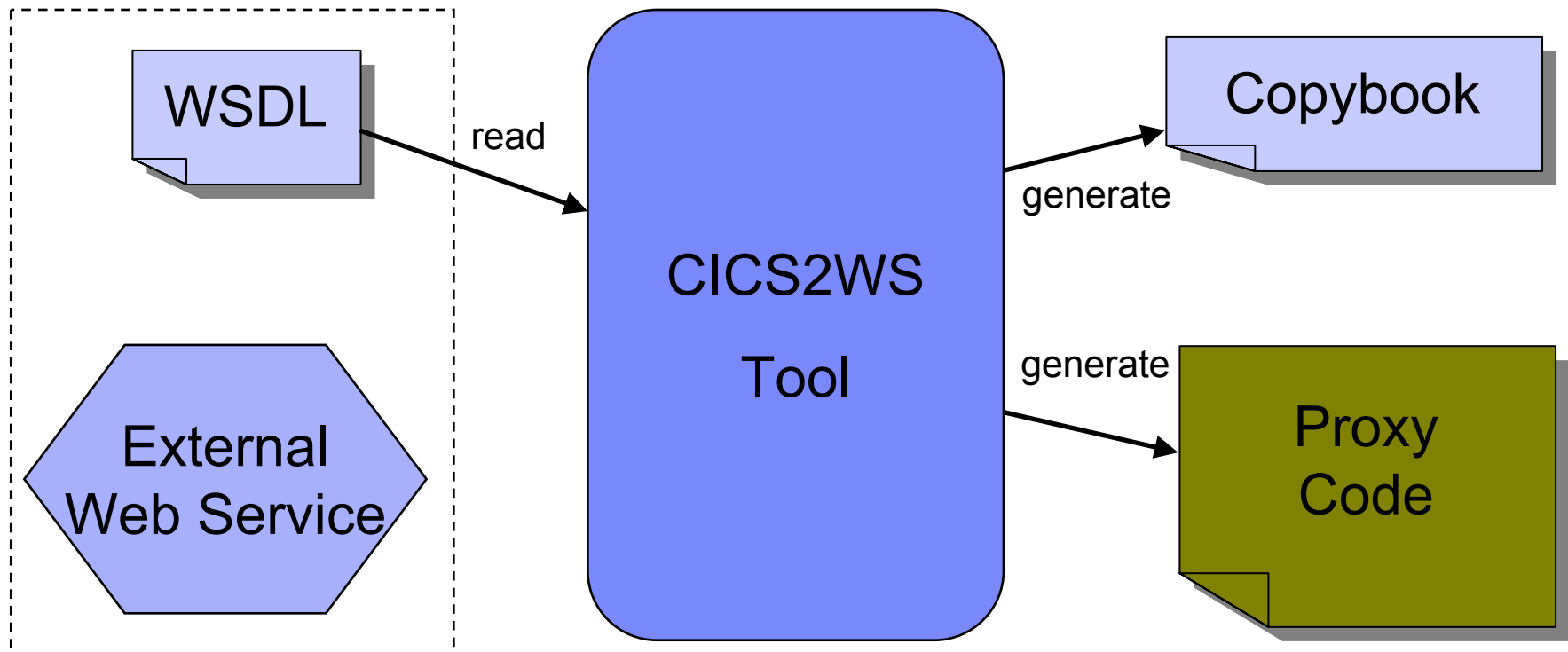

## Web Services with Middle tier and z/VSE

The Web Service is implemented on the middle tier – WebSphere Connector technology is used to access VSE logic

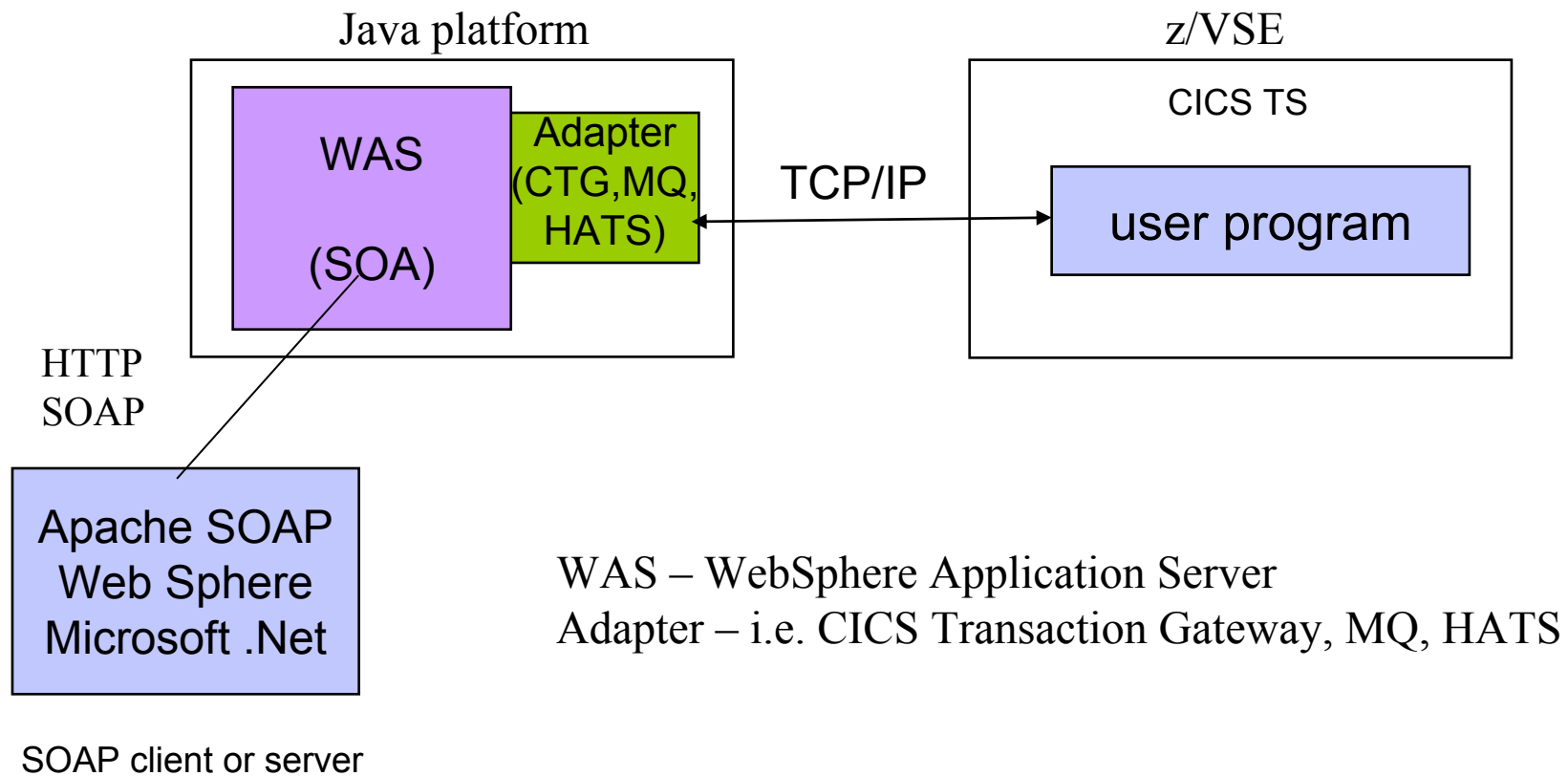

# Web Services with 3270 applications

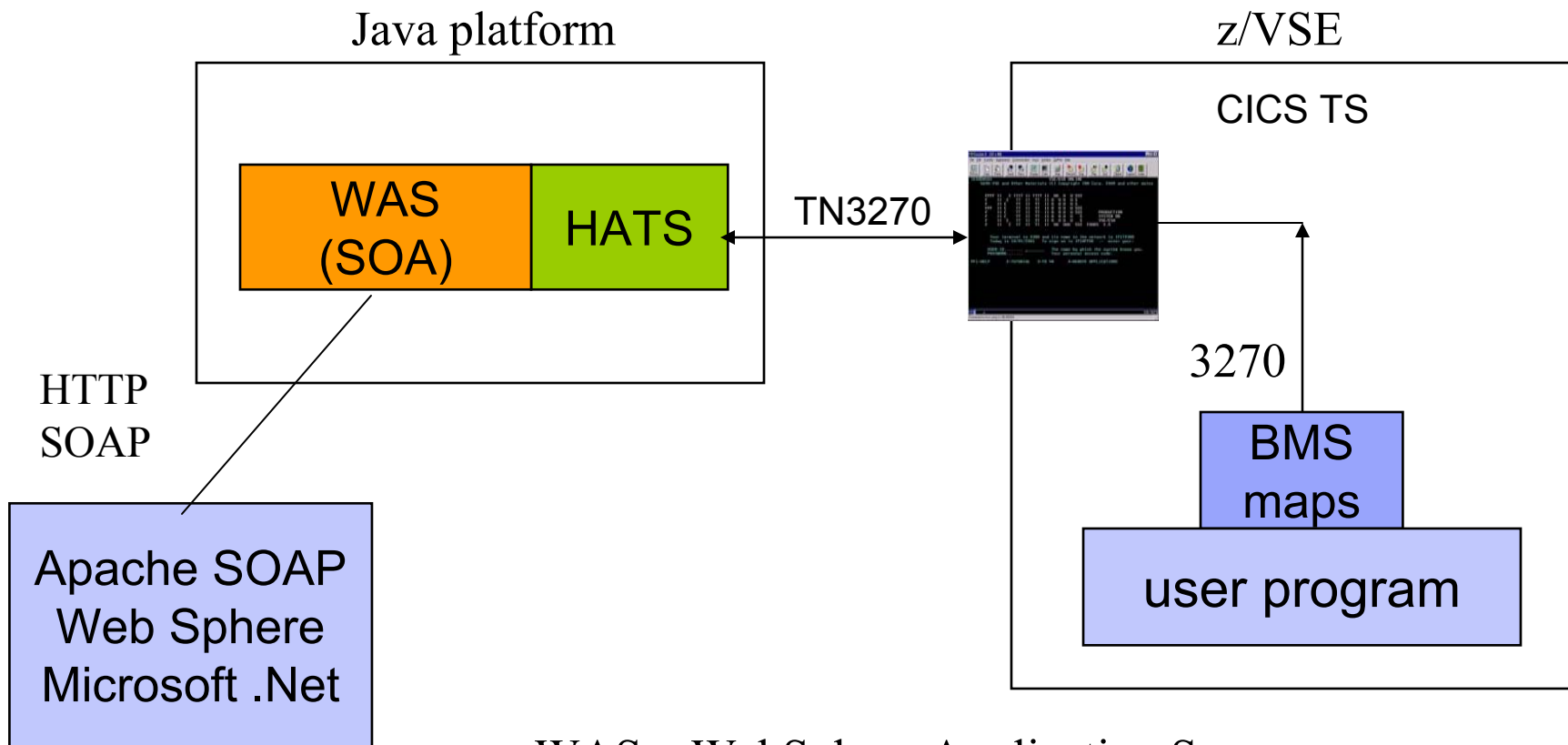

WAS – WebSphere Application Server  
 HATS – Host Access Transformation Server

# SOA – the way to New applications and processes

- Applications look the same for all users
  - Core applications can be enhanced (independent of their language, COBOL, ASM, PL/I)
  - New business logic can be built
- Increases business for the Company**

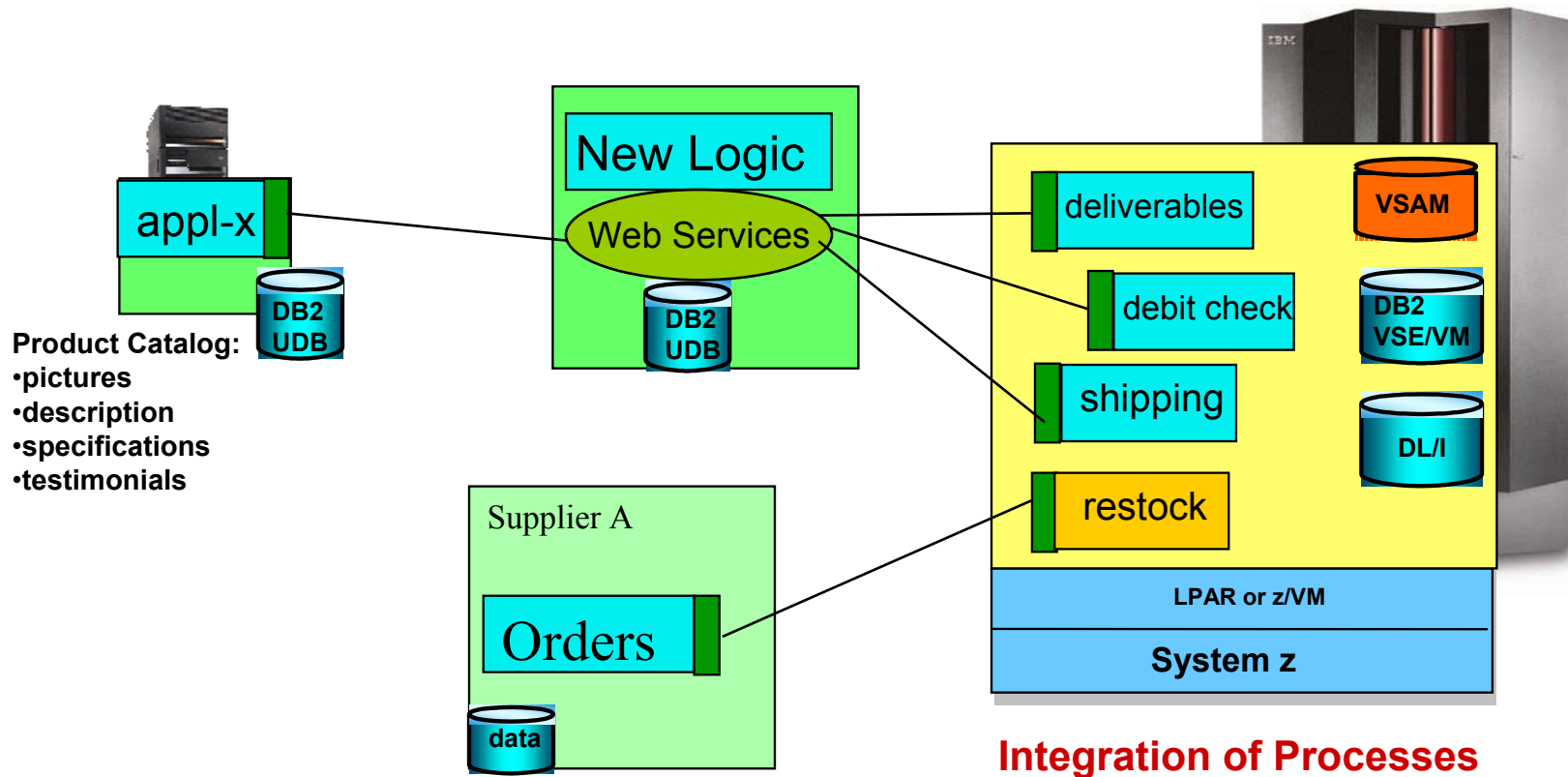

# Web Services Runtime View

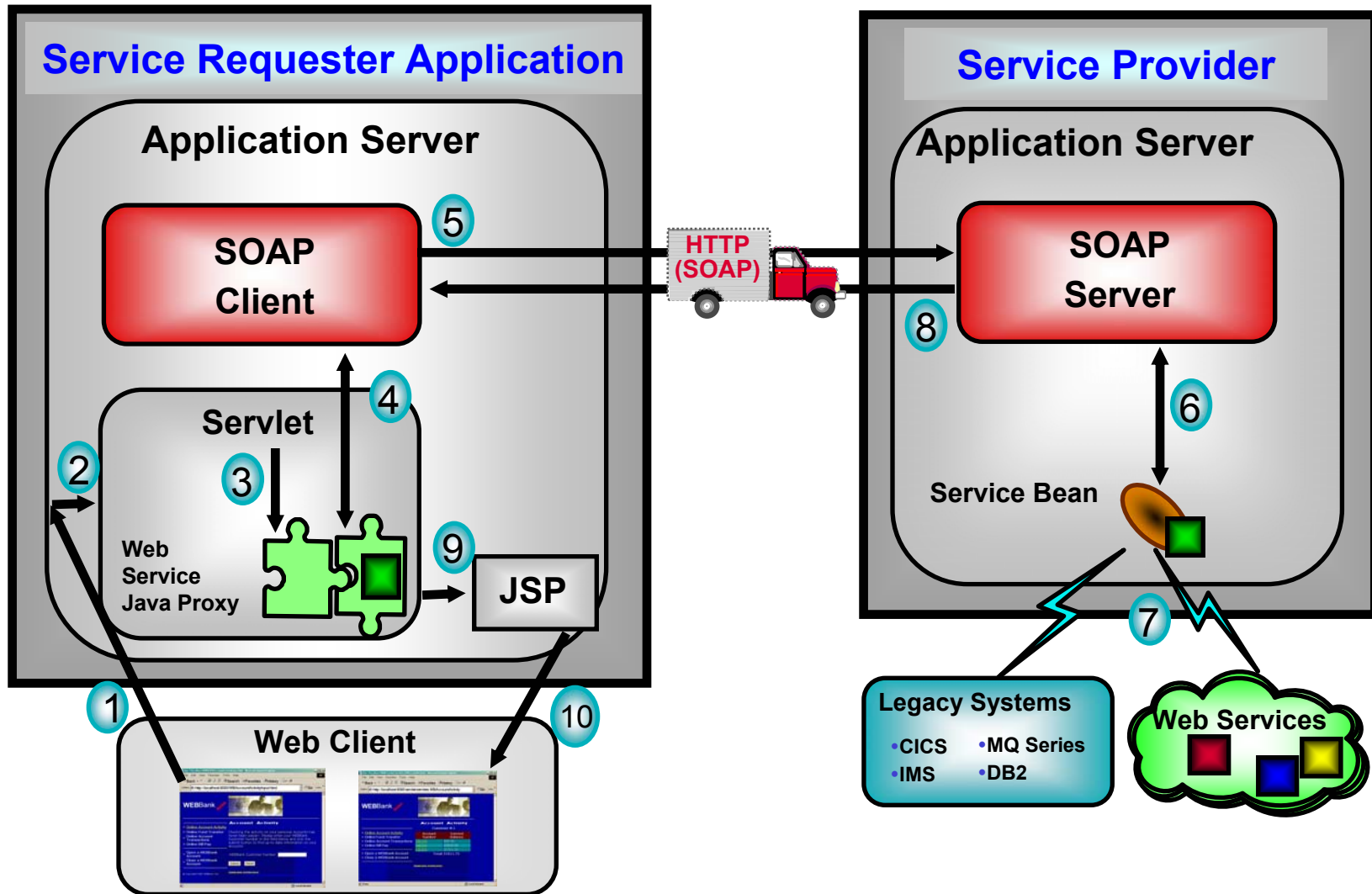



## Solutions where SOA is **not** the best architecture

- For high performance requirements
  - Communications using SOAP/XML are time consuming
  
- For the transfer of large amounts of data
  - XML data can get huge
  
- If transaction security is required
  - Two phase commit has to be implemented in the logic
  
- For real time direct access to data
  - SOAP is program to program communication

# Creating & Reusing Services - Greater Value through SOA

*Create Flexible, Service-based Business Applications*

## Value

- Flexibility and elimination of duplication for reduced cycle times
- Expanded access to core applications
- Consultant studies have found it 5X less expensive to re-use existing applications than to write new applications\*

## Start with

- What services are needed to run your business?
- Identify high-value existing IT assets and service-enable them for reuse
- Fill in gaps by creating new services for today's business needs and future reuse
- Registry/repository to facilitate centralized access and control of reusable services

*"With reuse, solving the next business problem can be done more quickly and efficiently."*

- Amy Wohl

\* Software Productivity Research (SPR)

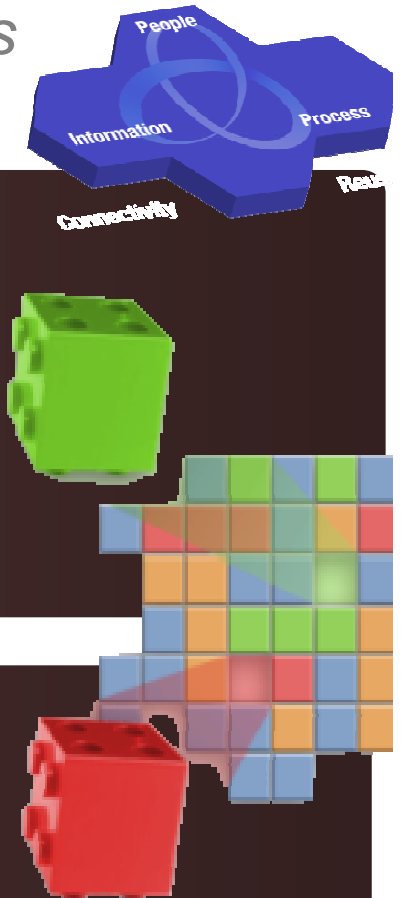

# Reusing Services

*Business Challenge: Leverage existing assets to improve business agility*

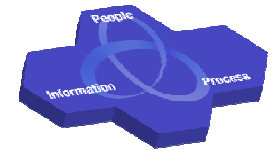

## Sysdat & Gautzsch



Reused existing RPG service based function to integrate with Amazon.de sales portal

Online in 3 weeks. **ROI in < 3 months.**

WebSphere Business Integration Express, Partner Gateway

## Acesita



Integrates mySAP and existing backend applications with **reusable service data**

**Real-time** views of critical cost and profit information for **better decisions**

IBM BCS, WebSphere MQ and Message Broker

## Mainsoft and Comtec



Reuse .NET applications in **open standards-based SOA** with IBM Business Partner Mainsoft Solutions

**5x faster** than rewriting the code from scratch

Mainsoft Visual MainWin, WebSphere Application Server

## Travel services

- One of the world's leading providers of electronic global distribution services (GDS) -- connecting more than 42,000 travel agency locations to 511 airlines, 37 car rental companies, 47,000 hotel properties, 350 tour operators and all major cruise lines in an electronic marketplace.
- Using web services
  - ▶ Offer travel services
  - ▶ Access travel suppliers

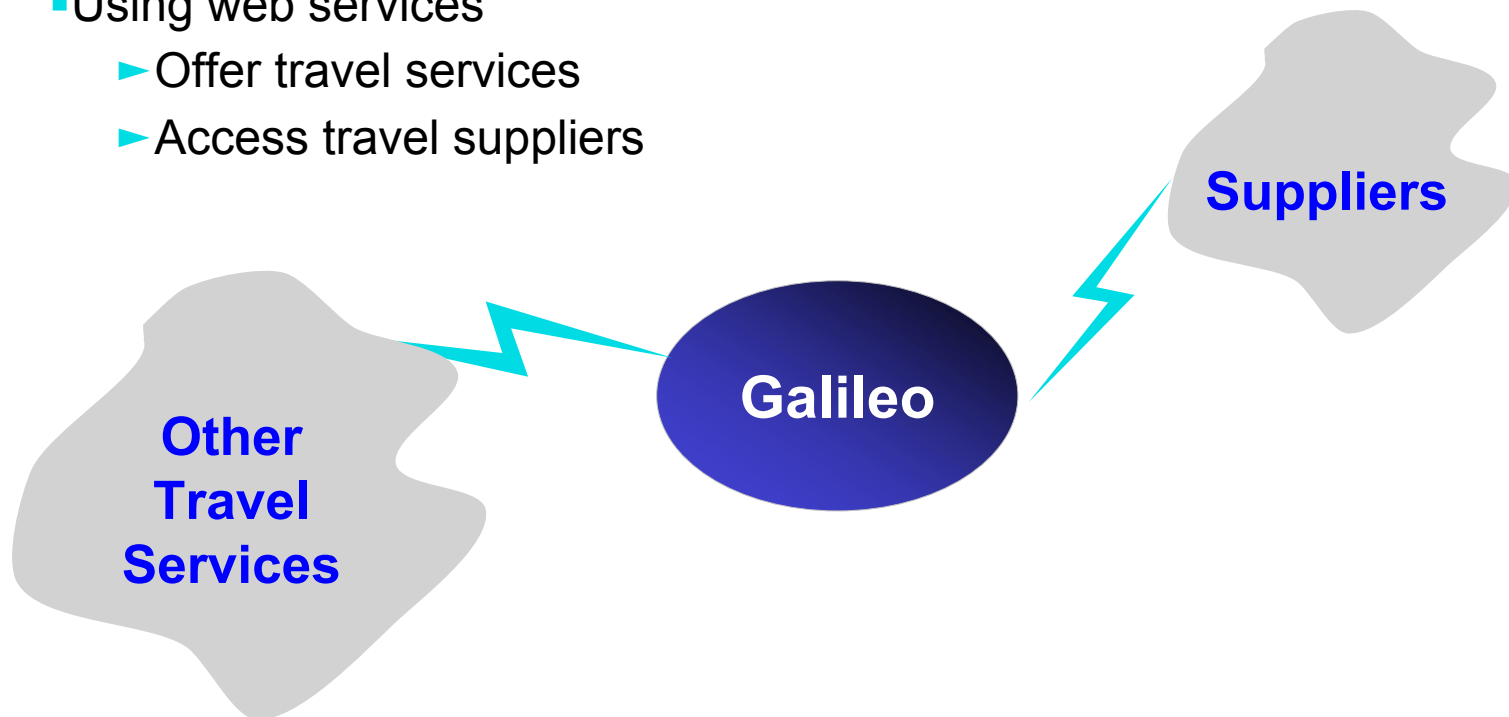

# Financial

- A Financial and insurance holding company
- 6,500 companies with approximately 390,000 employees
  - ▶ Manually synchronize the records of those employees such that individual coverage could be accurately calculated for each employee under a variety of insurance schemes.
- Replace the manual process with an automated web services process
  - ▶ Extract information directly from payroll systems and transmit via web services requests to Storebrand where it is entered into Storebrand's mainframe

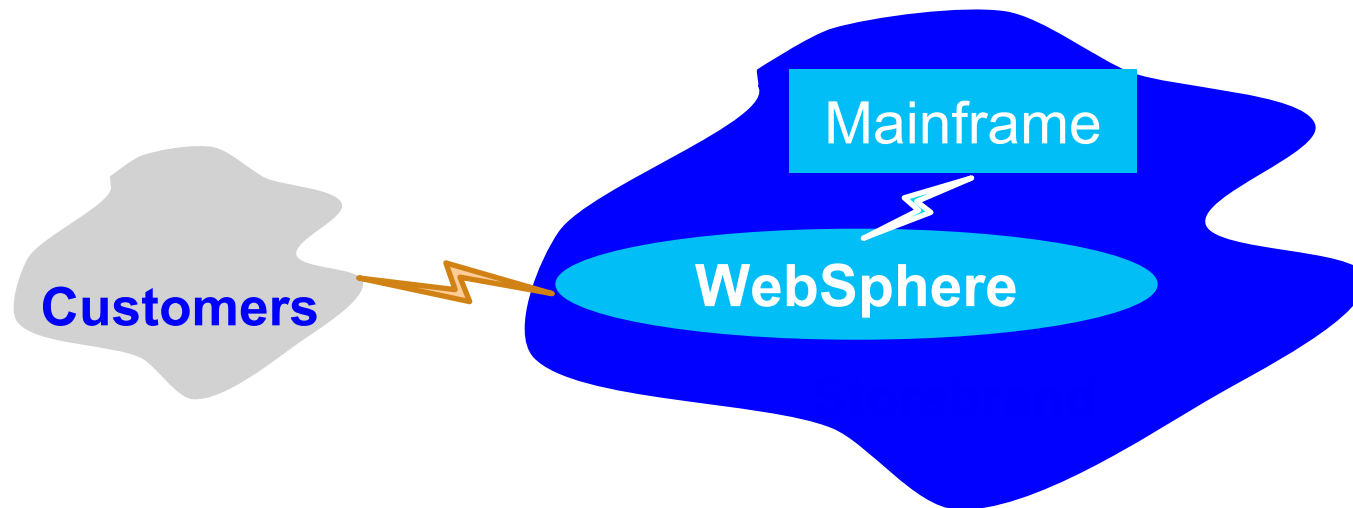

# WebSphere Application Server for VSE Customers

The possibility of application integration and Software Oriented Architecture (SOA)

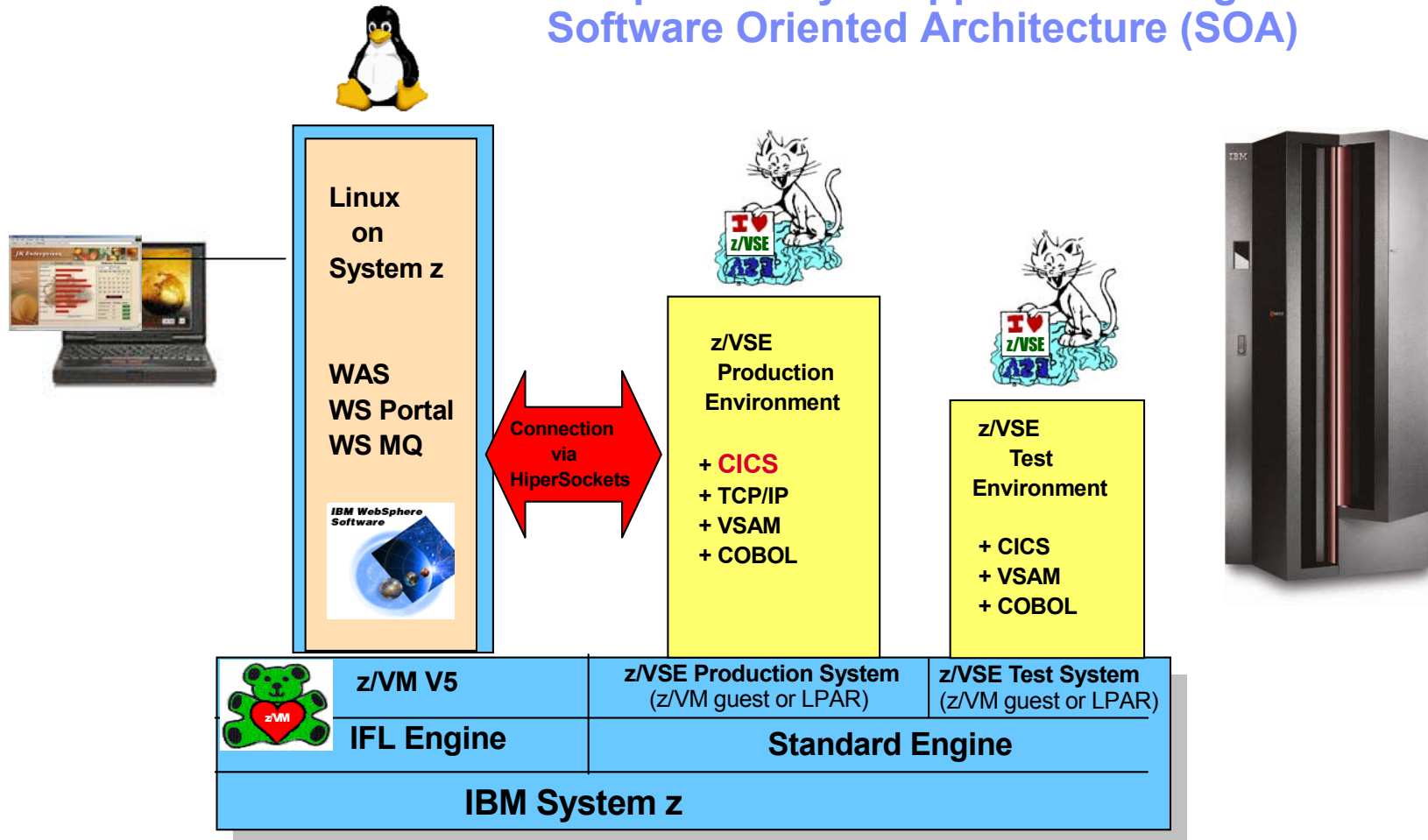

## Solutions on the new z/VSE homepage

Address <http://www.ibm.com/servers/eserver/zseries/zvse/>

Links [IBM Business Transformation Homepage](#)

Country/region [select] | Terms of use

IBM  Search

Home | Products | Services & solutions | Support & downloads | My account

Servers > Mainframe servers > Operating systems >

**z/VSE**

**About VSE**

**How to buy**

**News**

**Solutions**

**Products & components**

**Documentation**

**Service & support**

**Downloads**

**Education**

**Partners**

**FAQ**

**Contact VSE**

z/VSE is designed to help provide robust, cost-effective solutions for customers with a wide range of capacity needs, in most industries, worldwide. z/VSE is built on a heritage of ongoing refinement and innovation that spans four decades. It brings the value of innovative IBM eServer zSeries and IBM TotalStorage technology to VSE clients.

**Learn more**

- [About VSE](#)
- [News](#)
- [History of VSE](#)

**We're here to help**

Easy ways to get the answers you need.

E-mail us

**Mark your calendar**

**Guide Share Europe**  
April 18-20, 2005  
Berlin, Germany

Register

**WAVV World Alliance**  
WAVV conference  
May 20-24, 2005  
Colorado Springs, Colorado, USA

Catch the WAVV

**Spotlights**

- [IBM eServer zSeries](#)
- [Infrastructure simplification](#)
- [VSE Recommended Service Level](#)

**Middleware**

- [WebSphere software](#)
- [Information management software](#)

**Announcing z/VSE V3.1**

Built on a heritage of ongoing refinement and innovation that spans four decades.

**Redesigned z/VSE homepage**

You may have already noticed that the z/VSE home page has changed. We've redesigned this entire web site and included additional information. The objective is to provide you with a more useful business tool, as well as to offer you a more enjoyable experience. We encourage you to use, or to simply explore, the enhanced z/VSE web site. If you have questions, suggestions, or comments, please contact the [VSE team](#).

**z/VSE Version3 Release 1**

[z/VSE Version 3 Release 1](#) (z/VSE V3.1) is designed to support:

- [IBM eServer zSeries 890 and 990](#) (31-bit mode only)
- [SCSI disks attached to zSeries FCP channels](#)
- [OSA-Express2](#) and [FICON Express2](#) adapters
- [Crypto Express2](#) and CP Assist for Cryptographic Function (CPACF)
- [IBM TotalStorage 3494 Virtual Tape Server](#)
- improved support for [IBM 3494 Tape Library](#)
- [IBM TotalStorage DS8000 and DS6000 series Storage Servers](#)
- enhanced Advanced Copy support

z/VSE is designed to enable network integration and infrastructure

**Related links**

- [Linux on zSeries](#)
- [z/OS](#)
- [z/VM](#)
- [IBM Storage](#)
- [IBM Printing Systems](#)

<http://www.ibm.com/servers/eserver/zseries/zvse/>

## Documentation

- What is SOA?

- <http://www.ibm.com/developerworks/webservices/newto/>
- <http://webservices.xml.com/pub/a/ws/2003/09/30/soa.html>

- Web Services

- <http://www.ibm.com/servers/eserver/zseries/zvse/documentation/ebusiness.html#soap>

- *z/VSE e-business Connectors, User's Guide (SC33-8231)*

- <http://www-03.ibm.com/servers/eserver/zseries/zvse/>

- Web Services in VSE (zJournal.com )

- <http://www.zjournal.com/index.cfm?section=article&aid=281>
- <http://www.zjournal.com/index.cfm?section=article&aid=320>
- Includes COBOL sample code