



IBM Systems & Technology Group

## Bringing You Up To Date with zSeries Hardware: 2005

*What's new!*

**Mike Augustine**  
zSeries Offering Manager  
z890, z800  
[maugust@us.ibm.com](mailto:maugust@us.ibm.com)



**ON DEMAND BUSINESS™**

## Agenda

- What's New Since We Last Met
- Introduction
- Under the Covers and I/O
- Software Support and Pricing
- Migration Planning
- Reference Material

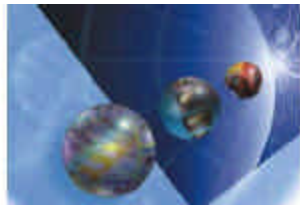

# What's Since We Last Met?

- **September 24, 2004**
  - ▶ GA for z/VM 5.1
  
- **December 31, 2004**
  - ▶ End of Service: 9662 (P/390), 9672-Rx2 & Rx3 (US letter # 903-118)
  
- **October 2004 & January 2005**
  - ▶ z890 - New Features
    - OSA-Express2, Crypto Express2, FICON Express2, EAL5 Certification, FIPS 140-2 Level 4
  - ▶ TotalStorage DS6000 and DS8000
  
- **March 4, 2005**
  - ▶ GA for z/VSE

# Introduction



## zSeries customers recognize highly differentiated value across the zSeries platform



- Extremely High Availability and Overall Reliability
- Massive end-to-end Scalability
- Capacity on Demand
- Rock Solid Security and Privacy
- Advanced Virtualization Capabilities
- Utilizes Open and Industry Standards
- World-class Integrated Support
- Higher Utilization and Balanced System Design

***zSeries Leadership: Now 40+ years in the making!***

**zSeries average system utilization often exceeds 80%, and zSeries servers are designed to handle sustained peak workload utilization of 100% without service level degradation to high priority workloads.**

## It is no longer unpopular to design or move applications to the Mainframe

- **"Basically, the market is moving toward the mainframe,"**  
said Jonathan Eunice, an analyst with tech consultant Illuminata.
- Don't look now, but the dinosaurs are making a comeback.
- Though pundits have long dismissed mainframe computers as throwbacks to a long-gone era, the big, brawny machines are very much alive. And in recent quarters, they've been reclaiming lost ground. IBM's z990, which in a bit of Big Blue humor it nicknamed "T-Rex," and the new z890 "Baby T-Rex" are biting into sales of midrange Unix (news - web sites) systems that once threatened mainframes with extinction.
- "A lot of people have them (mainframes), even if they don't talk about them,"  
said IDC analyst Jean Bozman. "It's very hard to run a large corporation without a (mainframe) of some kind."

## Marketplace Feedback...

**Meta Group, Will Cappelli**

*"...on average, approximately 15% of Global IT budgets are attributable to mainframe-related purchases, contracts, and activities, but, at the same time, 25-30% of the IT budget is recovered via billing for mainframe-resident services..."*

**Clipper Group, Mike Kahn**

*"... Betting against the mainframe goes against forty years of success. The last forty years are not just about the mainframe hardware. It's the whole mainframe offering, now including open-systems middleware, like WebSphere and MQseries, plus a strong heritage of customer support and service, that has moved the mainframe to its royal status."*

**Hewitt – Dan Kaberon, IT Systems**

*"To build a test Parallel Syplex would have normally required lots and lots of computers, lots and lots of cables.... a tremendous amount of complexity. Instead of doing that, what we decided to do was put up a logical partition with z/VM... It was completely done dynamically, which quite amazed our friends in distributed systems as well as delighted our business people."*

**Home Depot – Barbara Sanders, VP Engineering and Architecture**

*"The benefits I was looking for in the zSeries platform were the low cost-of-unit transaction volumes. The zSeries is a very compact footprint, and also a staffing footprint. So we were able to aggregate those critical resources into the zSeries and we feel that we were able to drive down our unit cost of processing."*

***"Fidelity Information Services is pleased to team with IBM as part of the on demand bank of the future. Fidelity provides the solution assets that will enable IBM and Fidelity to deliver the roadmap for on demand banking efficiencies for the financial services industry."***

## The newest member of the zSeries family

- The IBM eServer zSeries 990 was announced in May 2003
- IBM announced our Mainframe Charter framework in August 2003
- **z890 announced in April 2004 with enhancements delivered in October 2004 and January 2005**

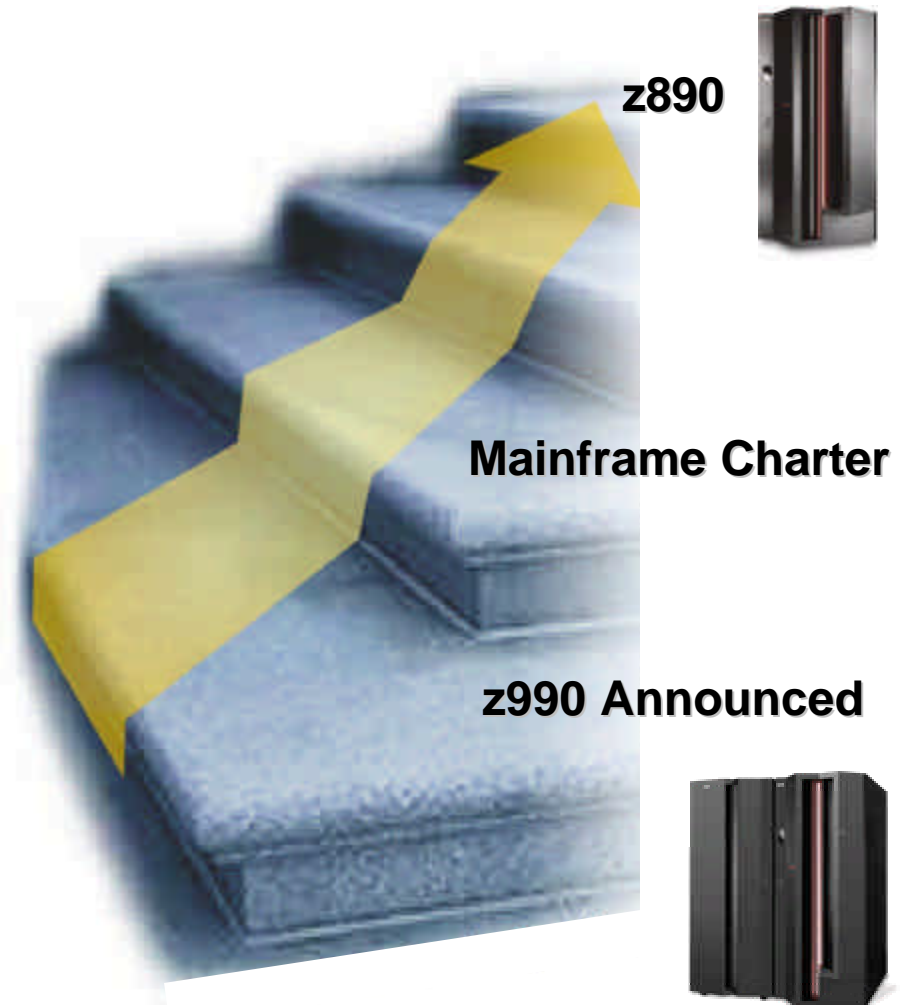



## z890 – Bringing latest generation zSeries on demand technology to a new audience!



### Processor -- 2086 Model A04

- ▶ 1 flexible model
- ▶ 64-bit z/Architecture
- ▶ Up to 5 PUs (in single book)
- ▶ up to 4 PUs characterizable
- ▶ Capacity Upgrade on Demand
- ▶ On/Off Capacity on Demand
  - for CPs, IFL, ICF, and zAAP
- ▶ Capacity Backup (CBU)
- ▶ Customer Initiated Upgrade (CIU)
- ▶ Air cooled

# z890 – Technology Features

- **Memory**
  - ▶ 8 GB Standard
  - ▶ 8 GB increments to 32 GB (8, 16, 24, 32 GB)
- **Support for up to 30 LPARs**
  - ▶ Except for Capacity setting 110 which supports up to 15 LPARs
- **Cryptographic coprocessor optional**
- **New packaging for I/O with Two Logical Channel SubSystems (LCSS)**
  - ▶ 28 slot I/O cage supports up to 420 ESCON® channels
    - z890 110 capacity setting only has 16 I/O slots available
  - ▶ OSA-Express2
    - Gigabit Ethernet, 10 Gigabit Ethernet
  - ▶ OSA-Express
    - 1000BASE-T Ethernet, Token-Ring, Integrated Console Controller
  - ▶ FICON® Express2
  - ▶ Open FCP
  - ▶ Quadrupled HiperSockets™ support over z800 to 16
- **Single frame**
  - ▶ One and three phase options
  - ▶ Raised floor recommended but not required
  - ▶ Internal Battery Option



Front View

## z890 on demand – A new way to think about granularity

- **Single Machine: 2086 and a single Model: A04**
- **A dramatic new way to consider upgrading**
- **One MCM with 5 Processor Units (PUs)**
  - ▶ Four PUs available for characterization
    - CPs, Integrated Facility for Linux (IFLs), Internal Coupling Facility (ICFs), or zSeries Application Assist Processor (zAAPs)
  - ▶ One PU standard as an SAP
- **Standard CPs**
  - ▶ Four full capacity processors **each** with 7 capacity settings
    - Entry point is approximately 32% less capacity than z800-0E1 and largest capacity setting is up to 123% more than z800-004
  - ▶ Upgrades can be horizontal, vertical, diagonal, to best fit your needs \*

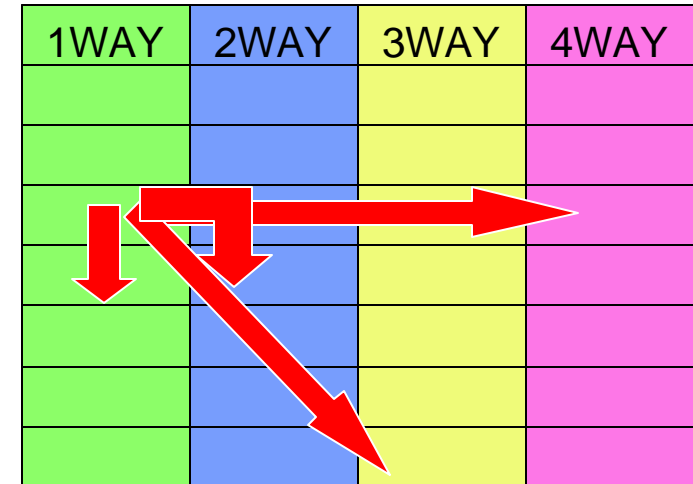

\* Note: No mixing of standard CP capacity sizes in multi-engine machines.

**Think of the possibilities:  
Order the server the way your On Demand business requires !**

## z890 PU Characterization

### ■ Processing Units (PUs) types that can be enabled / assigned include:

#### *f* Central Processors (CPs)

- Provides processing capacity for z/Architecture™ and ESA/390 instruction sets
- Runs z/VSE, z/VM, z/OS, TPF and Linux

#### *f* Integrated Facility for Linux (IFL)

- Provides additional processing capacity for Linux workloads
- Runs Linux or Linux under z/VM Version 4 and Version 5

#### *f* IBM eServer zSeries Application Assist Processor (zAAP)

- Under z/OS, the Java Virtual Machine (JVM) assists with Java processing to a zAAP

#### *f* System Assisted Processors (SAPs)

- SAPs manages the start and ending of I/O operations for all logical partitions and all attached I/O

#### *f* Internal Coupling Facility (ICF)

- Provides additional processing capacity for the execution of the Coupling Facility Control Code (CFCC) in a CF LPAR

**Note: Specialty Engines run at full uni speed**

# z890 Positioning

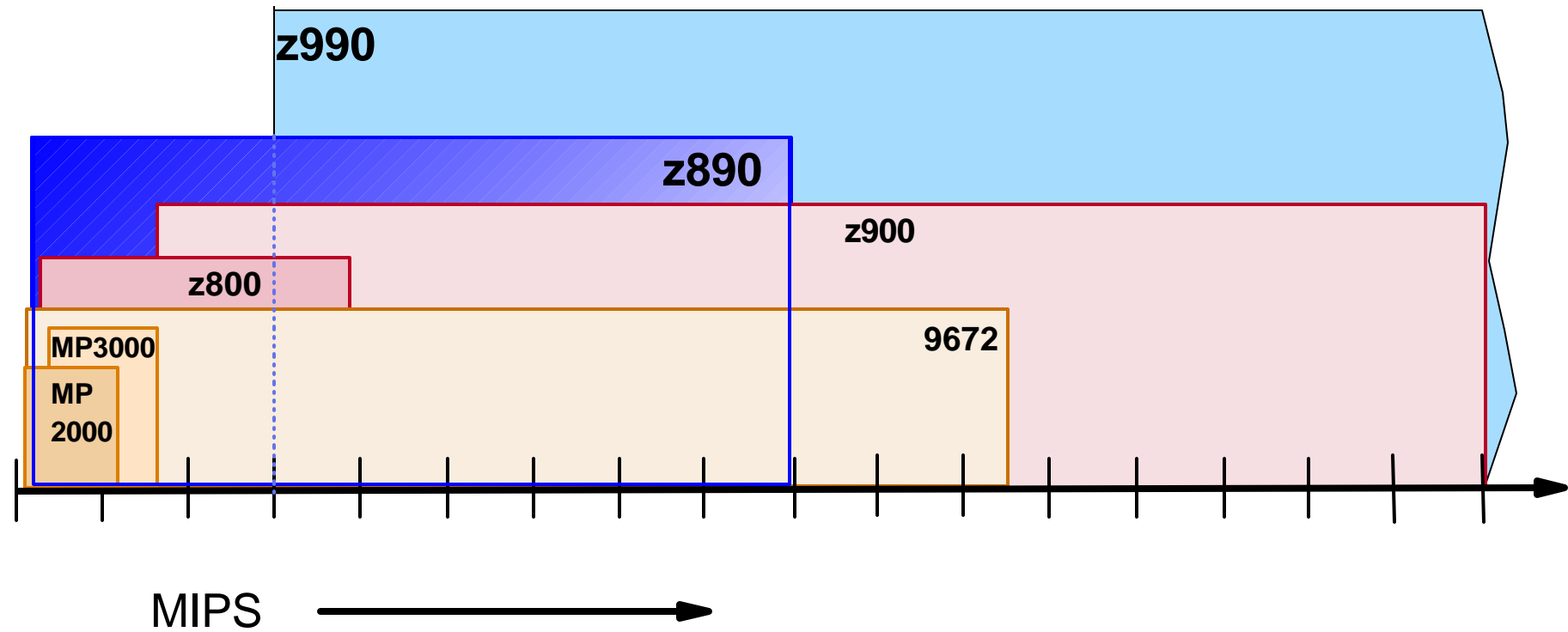

# z890 Performance Comparison

z890 Uni is 1.98 - 2.09 times the z800 Uni  
 z890 4-way is 2.19 - 2.28 times the z800 4-way  
 z890 entry is approximately 35% lower than z800

Capacity Settings\*

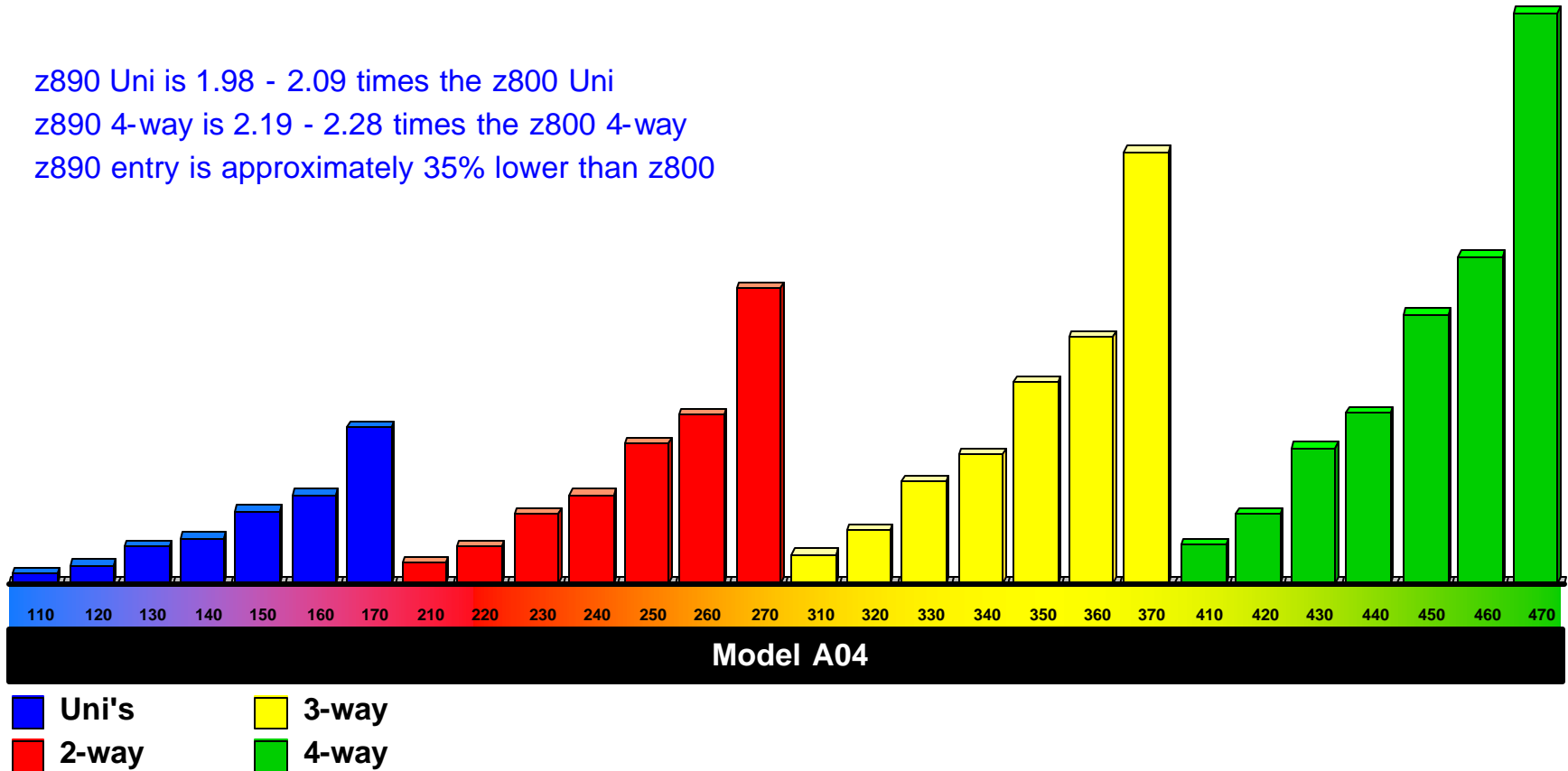

Note: For MSU values, refer to: [ibm.com/servers/eserver/zseries/library/swpriceinfo/](http://ibm.com/servers/eserver/zseries/library/swpriceinfo/)

\* Capacity setting refers to number of installed CPs and the capacity. Reported by STSI instruction.

## z890 Capacity Setting and MSUs

1-WAY	MSUs	2-WAY	MSUs	3-WAY	MSUs	4-WAY	MSUs
110	4	210	8	310	11	410	15
120	7	220	13	320	20	420	26
130	13	230	26	330	38	430	49
140	17	240	32	340	47	440	62
150	26	250	50	350	74	450	97
160	32	260	62	360	91	460	119
170 Full 1-way	56	270 Full 2-way	107	370 Full 3-way	158	470 Full 4-way	208

# z890 Upgrades/Downgrades

1-Way		2-Way		3-Way		4-Way	
Feature Code	Capacity Setting	Feature Code	Capacity Setting	Feature Code	Capacity Setting	Feature Code	Capacity Setting
6110	110	6210	210	6310	310	6410	410
6120	120	6220	220	6320	320	6420	420
6130	130	6230	230	6330	330	6430	430
6140	140	6240	240	6340	340	6440	440
6150	150	6250	250	6350	350	6450	450
6160	160	6260	260	6360	360	6460	460
6170	170	6270	270	6370	370	6470	470

Any horizontal upgrade is concurrent (i.e. 6140 to 6240)  
 Others (vertical or diagonal) may require an IPL (except z/VM)  
 6070 = zero CP's (ICF's or IFL's only)

**Capacity Setting "xy"** for software pricing  
 Preceded by a 6 (feature code) - **6xy0**  
 X indicates number of CPs (62**7**0)  
 Y indicates capacity setting (62**7**0)



## Capacity on demand (upgrades): permanent or temporary?

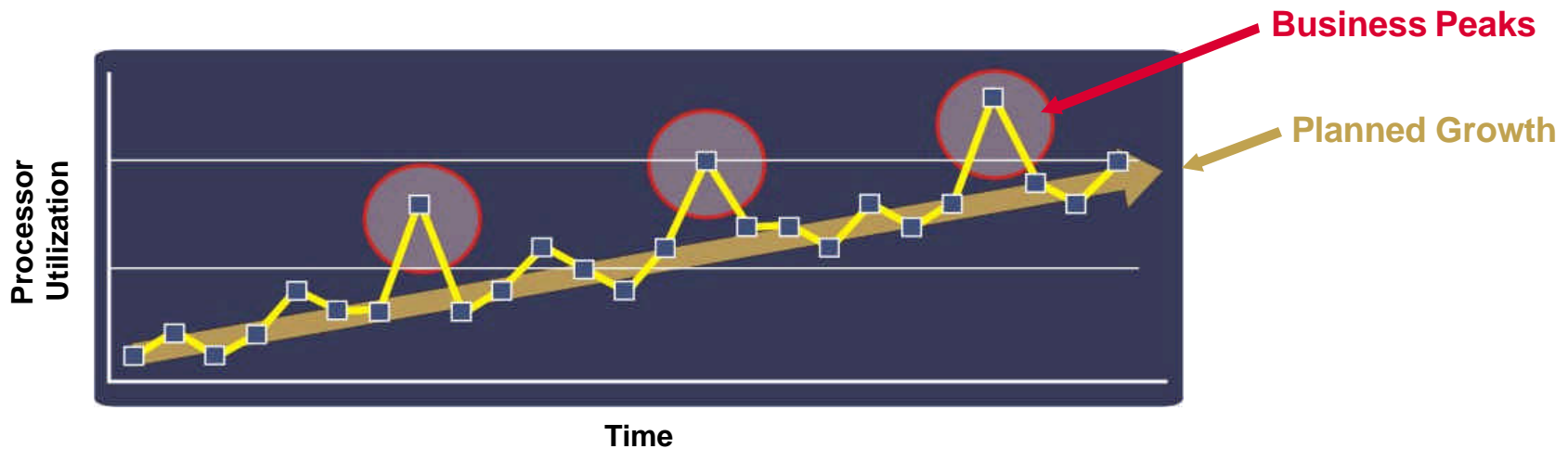

### Permanent Capacity Upgrade

Planned Growth (HW pay when purchased)

### Temporary Capacity Upgrade

Business peaks (HW pay after use on a daily basis)

Special Purpose: Seasonal spikes, new market offering or application rollouts

## zSeries Capacity on Demand Summary

Capacity Upgrade on Demand (CUoD) <sup>***</sup> (MES only)	Capacity Backup Upgrade (CBU) <sup>***</sup>	Customer Initiated Upgrade (CIU) <sup>***</sup>	On/Off Capacity on Demand (On/Off CoD) <sup>***</sup>
<b>Permanent</b> capacity upgrade; a standard zSeries feature that allows you to order extra capacity resources such as processors, memory*, and I/O	<b>Temporary</b> reserve backup PU capacity for specified duration; original config must be restored after test or disaster recovery	<b>Permanent</b> - Facility for ordering, configuring, pricing & installing capacity upgrade. Web-based solution avail via Resource Link	<b>Temporary</b> capacity upgrade (CP, ICF, IFL, zAAP) of unlimited duration; orderable through CIU; customer activates and deactivates.
Available on LIC enabled z800, z890, z900 and z990	Available on z800, z890, z900 and z990	Available on LIC enabled z800, z890, z900 and z990	Available only on z890/z990; orderable feature
Inherent capability of zSeries servers; spare processors, memory and/or I/O slots must be available	A CBU contract must be in place prior to implementation and reserve PUs available for test or disaster recovery	A CIU contract must be in place prior to implementation	A CIU contract with special On/Off CoD terms and conditions and right-to-use feature must be in place prior to implementation
Capacity upgrade Installed by customers or IBM Service representative	Capacity reserve installed by customer or IBM Service representative for predetermined period of use	CIU contract and registration required to use CIU application to order capacity	Feature ordered through IBM Sales; once enacted, customer orders temporary CP, ICF, IFL or zAAP upgrade through CIU
Customer or IBM planning required	Customer or IBM planning required	Customer planning required	Customer planning required
Nondisruptive** capacity activation (may require deactivation or activation of LPAR partition)	Nondisruptive** capacity activation z800, z890, z900 and z990	Ordering facility available with the z800, z890, z900 and z990	Nondisruptive temporary CP, ICF, IFL or zAAP upgrade; customer deactivates; mutually exclusive with CBU

\* Memory cannot be upgraded on z800 with CUoD. Limited option for z890

\*\* CUoD and CBU may need IPL for z800/z890 "sub" model upgrades with older levels of OS

\*\*\* Additional terms and conditions apply

## z890 – Capacity Setting 110 Overview

- **Built on same zSeries technology – but available in our smallest capacity setting**
- **Full zSeries Availability support**
- **Memory**
  - ▶ 8 GB Standard, with 8 GB increments to 32 GB (8, 16, 24, 32 GB)
- **Specially-designated Workload Processors for Coupling, Java and Linux workloads**
- **Single frame**
  - ▶ One and three-phase options
  - ▶ Raised floor recommended but not required
  - ▶ Internal Battery Option
- **New packaging for I/O with Two Logical Channel SubSystems (LCSS)**
  - ▶ I/O cage supports up to 240 ESCON channels and/or 32 FICON Express or 64 FICON Express2 channels (16 I/O slot max)
  - ▶ 24 OSA-Express or OSA-Expres2 ports available – 10 Gigabit Ethernet, Gigabit Ethernet, 1000BASE-T Ethernet, Token-Ring, Integrated Console Controller
  - ▶ Open FCP
  - ▶ HiperSockets support for 16 internal LANS
- **Support for up to 15 LPARS**
- **zSeries Entry License Charge™ (zELC) pricing on Capacity Setting 110 only**

## Channel/Slot Maximums

Channel Type	z890 FC6110	z890	z800	z990*
LPARs	15	30	15	30
I/O Slots	16	28	16	84
LCSS	2	2	1	4
Channels	256	512	256	1024
ESCON	240	420	240	1024
FICON Express	32	40	32	120
OSA-Express	24	40	24	48
HiperSockets	16	16	4	16
ISC-3	48	48	24	48
ICB-3	16	16	5 (6 on OCF)	16
ICB-4	8	8	0	16
IC	32	32	32	32
OSA ATM 155	0	0	24	0
Crypto - PCICC	0	0	16 engines	0
Crypto - PCICA	4 engines	4 engines	12 engines	12 engines
Crypto - PCIXCC	4	4	0	4
Crypto Express2	8	8	0	8

\* Model B16 and higher

## Under the Covers and I/O

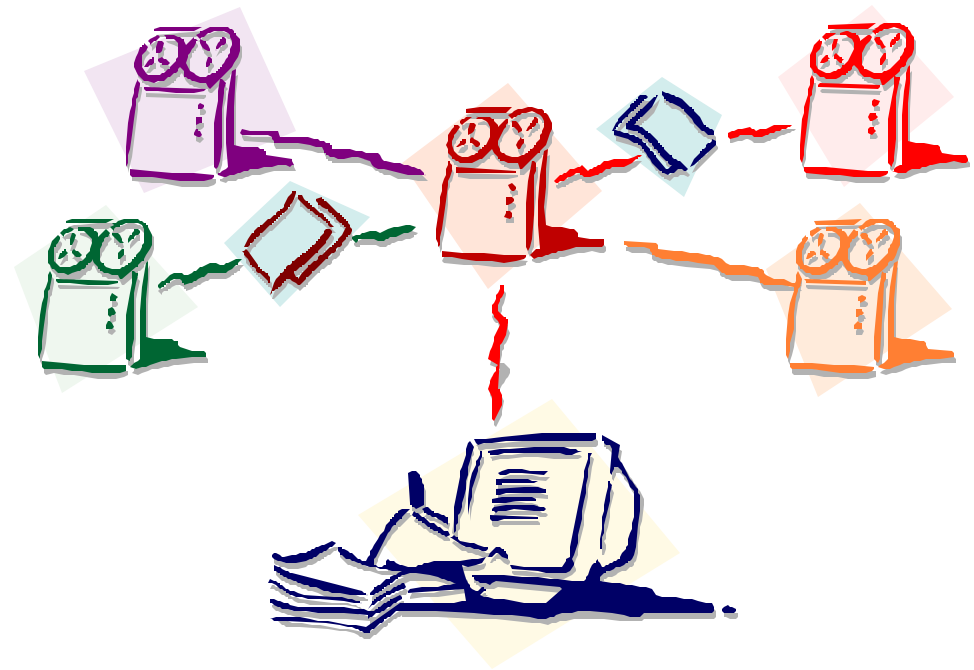
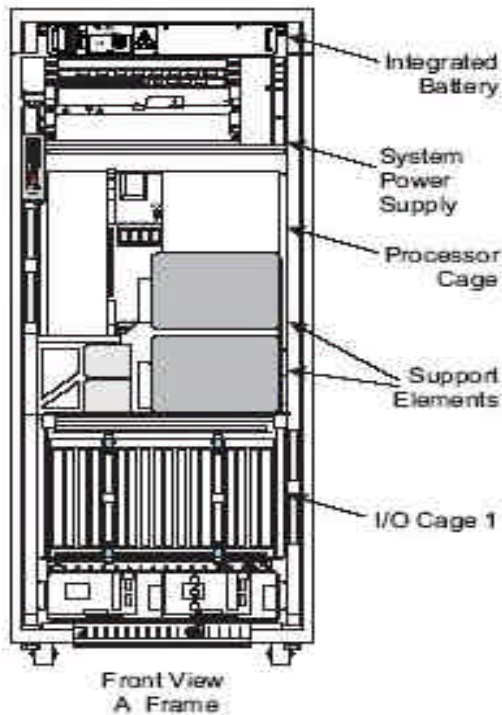

# z890 - Under the Covers

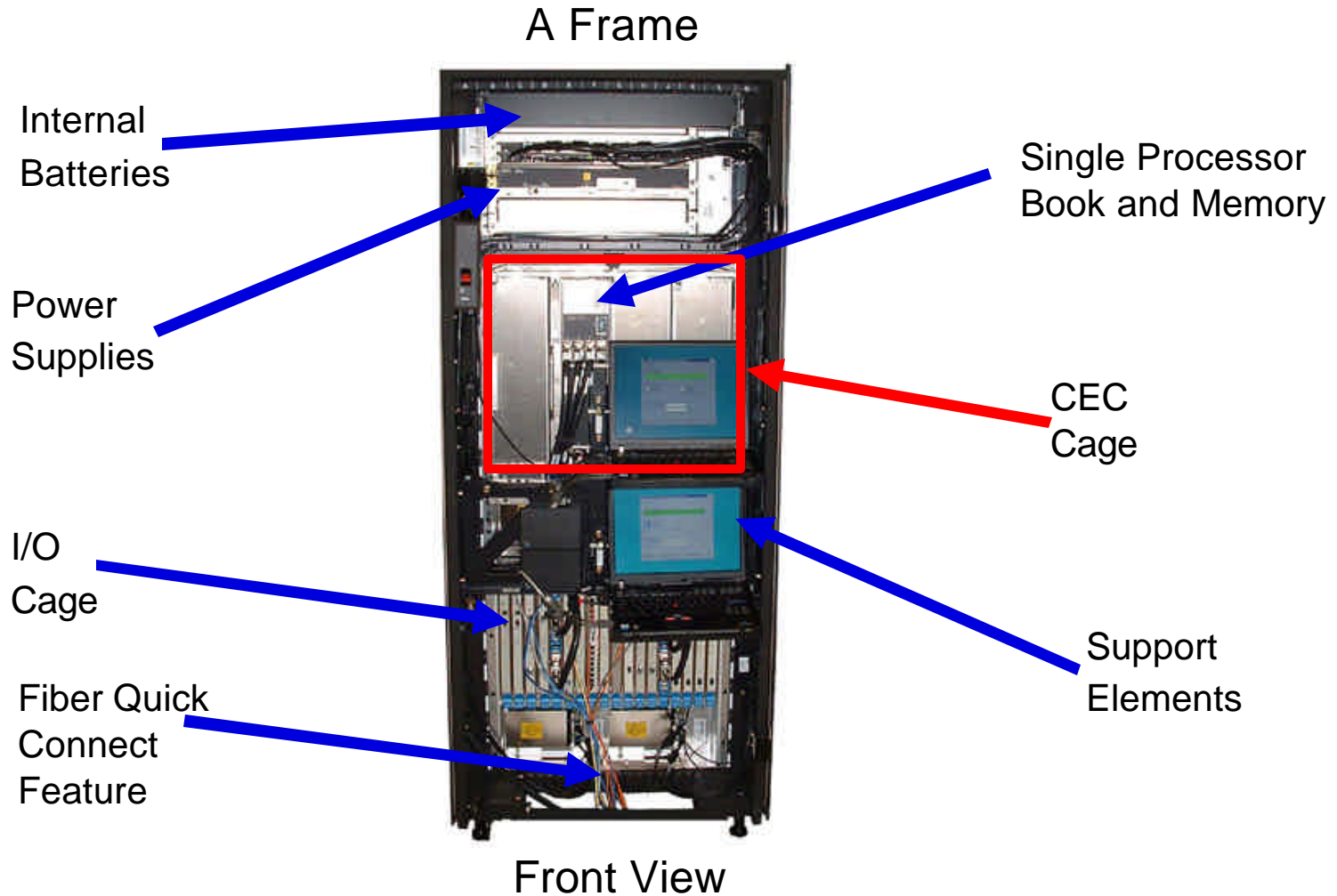

# Channel Spanning

## Share Channels among LPARs across LCSSs

- Internal spanned channels
  - HiperSockets and Internal Coupling links
- External spanned channels
  - FICON Express and FICON Express2 (FC and FCP CHPID types) **NEW!**
  - OSA-Express and OSA-Express2 **NEW!**
  - ISC-3, ICB-2, ICB-3, and ICB-4 **NEW!**

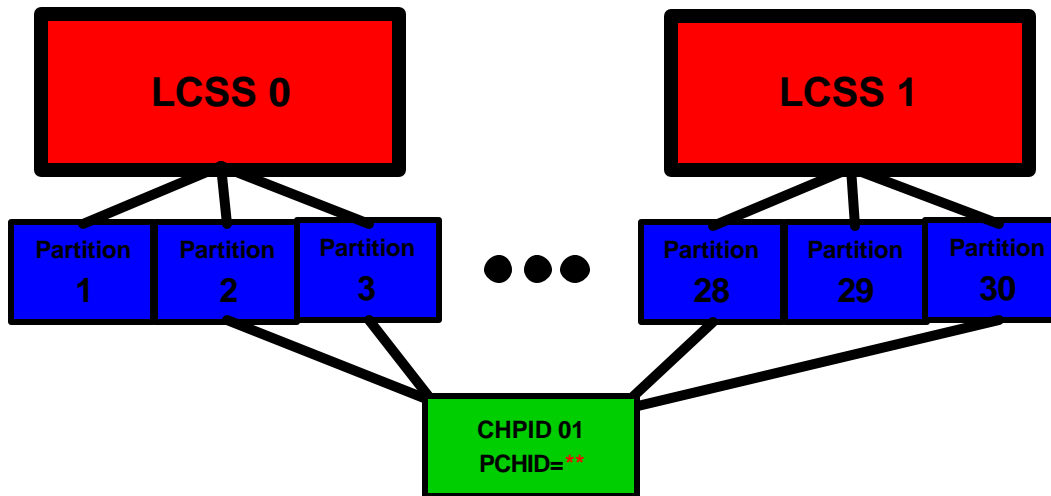

\*\* No PCHID for HiperSockets and Internal Coupling links. It is required for FICON/OSA/External Coupling Links

Spanning reduces the number of channels that can be defined for all LCSSs on CEC - worst case - 256 if all channels are spanned between all LCSSs  
 ESCON, DCM and FICON Bridge will not support spanning

## CHPID Mapping Tool

- **Ease of use tool to simplify mapping of CHPIDs to PCHIDs**
- **Availability and manual mapping functions**
- **Tool used with HCD/HCM for assigning PCHIDs to CHPIDs**
  - ▶ Requires changes to current HCD process
- **Supports channel MESs**
  - ▶ CHPID to PCHID mapping contained in IOCP
- **"Mandatory"**
- **Customer Responsibility!**

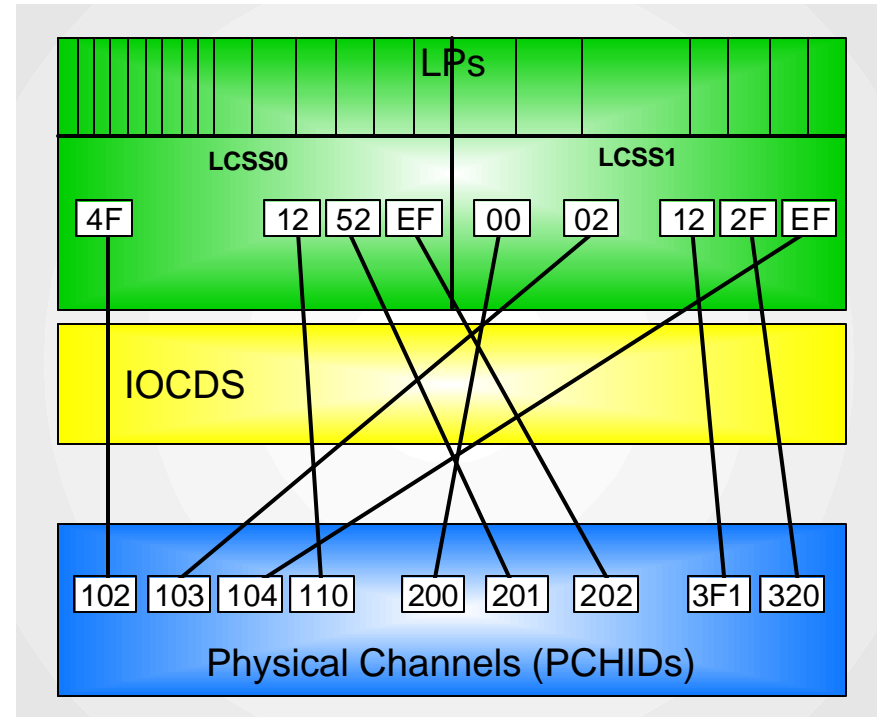

[www.ibm.com/servers/resourceink](http://www.ibm.com/servers/resourceink)



# The IBM TotalStorage DS Family

The industry's broadest range of disk storage systems



DS300/DS400      DS4000      DS6000      ESS      DS8000

Common management platform

Common suite of copy services

Virtualization

Compelling price points

Industry leading service and support

IBM TotalStorage DS Family innovations can help you:

**Simplify** the underlying IT infrastructure and its management to help lower cost and complexity while increasing your ability to respond to changing demands

Assure **business continuity**, security and data durability

Efficiently manage information **throughout its lifecycle**, relative to its business value

# IBM TotalStorage Disk: A Continuum of Enterprise Functionality

**New Standard in Pricing and Packaging**



**DS6000**

- A fraction of the price with all the capability of traditional enterprise products
- Easy to install, easy to service, modular packaging
- Great performance – on a par with ESS 800 in many metrics
- Can start small and grow up to 67TB physical capacity
- Up to 8 FC/FICON host ports, 4GB Cache
- **No ESCON connection**

- Supports all major types of servers including zSeries, UNIX, iSeries, Windows,...
- Outstanding copy services - compatible between DS6000, DS8000, ESS 800, 750
- Helps lower administrative costs with common management tools and interfaces
- Designed for enterprise class reliability to help support continuous operations
- 4-year warranty

**New Standard in Functionality, Performance, TCO**



**DS8000**

- Dramatic performance yields up to 6X ESS 800 throughput
- New levels of simplification with storage system LPARs
- First class storage consolidation platform with physical capacity up to 192TB, architected to scale 1 Petabyte
- Model to Model field upgrades help protect investment
- Up to 128 FC/FICON ports or 64 ESCON ports, up to 256GB Cache

# IBM TotalStorage Disk Positioning with eServer zSeries

Choose IBM TotalStorage DS8000 if need

Highest Performance / Scalability,  
ESCON or FICON/FC attach,  
Storage System LPAR Capability  
with DS8300

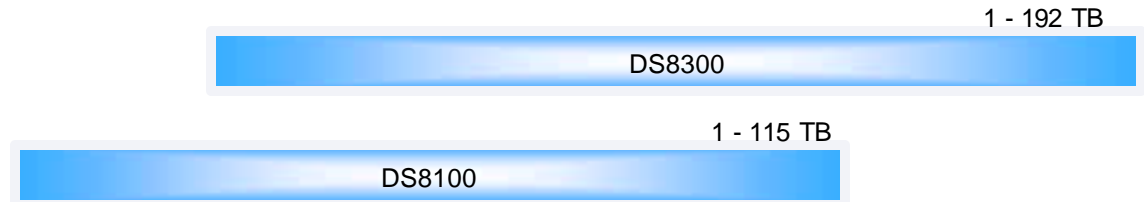

Choose IBM TotalStorage DS6800 if need

Lowest price,  
FICON/FC attach,  
Modular/small footprint,  
Easy install / serviceability



Previous Generation  
DASD

IBM TotalStorage ESS

ESCON or FICON/FC attachment,  
Many references showing wide  
customer acceptance

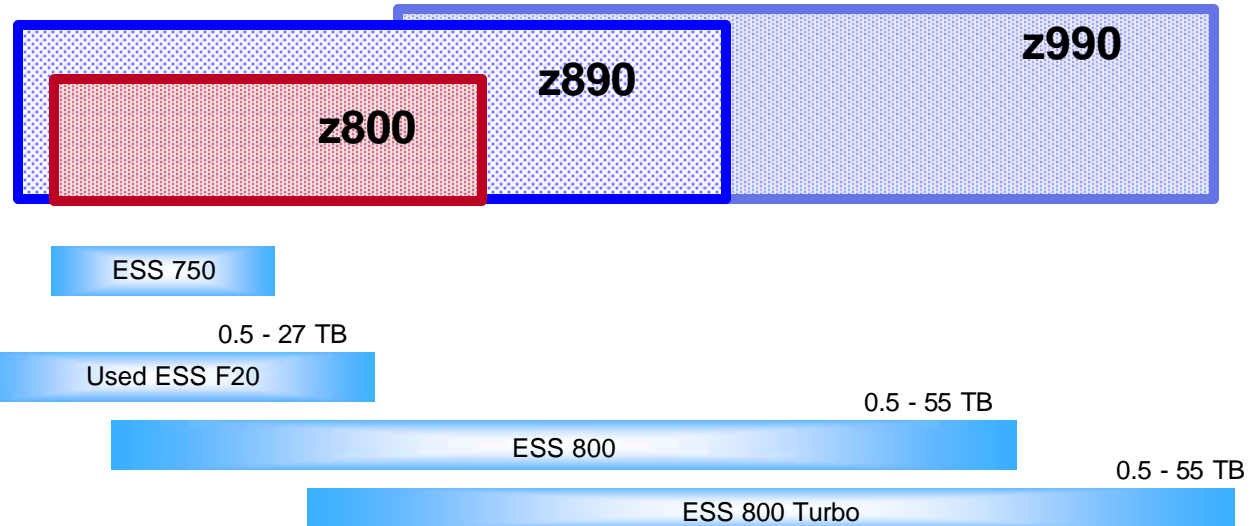

# zSeries 16-port Enterprise Systems Connection (ESCON) card

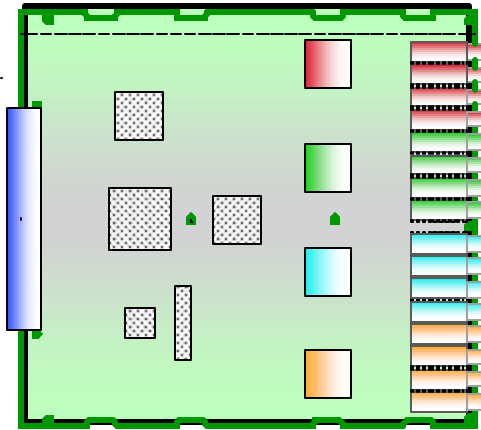

MTRJ MM

- **High density package**

- ƒ 16-port feature (FC 2323)

- Ordering increment, four channels (FC 2324)
    - eConfig selects feature quantity

- ƒ At least one spare channel port per card

- ƒ Active ports - LICCC controlled

- Active channels balanced across all installed features

- ƒ After the first pair, ESCON features are installed in increments of one

- **Small form factor MTRJ connector**

- ƒ 62.5 micron multimode fiber

- ƒ Conversion kit available from IGS for existing ESCON duplex fiber infrastructure

- **Fiber Quick Connect (FQC)**

- ƒ Factory installation of direct-attach fiber harness

- Supports all installed ESCON features in all installed I/O cages
      - New builds or conversions to z890
    - Enables attachment to fiber trunking

Number of Channels	Cards
4 - 28	2
32 - 44	3
48 - 60	4
...	...
244 - 268	18
...	...
420	28

Capacity Setting 110

Number of Channels	Cards
4 - 28	2
32 - 44	3
48 - 60	4
...	...
228 - 240	16



## zSeries Fibre Connection (FICON) Express2 Card

- **4 channels per feature**
- **Now up to 80 channels in the same amount of physical space (see following slide)**
- **Two CHPID types**
  - FC - native FICON and CTC
  - FCP - communicating with SCSI devices
- **Connectivity options for each channel**
  - 1 or 2 Gbps, auto-negotiated
  - Can be shared among LPARs
  - Can be defined as a spanned channel
  - Intermix of FC and FCP in the same director
  - Supports cascading - connecting directors in succession
- **Performance improvements**
  - Up to 50% in full duplex large sequential R/Ws\*
  - Up to 40% in start I/Os per second\*
- **Supported connectivity devices**
  - Refer to: <http://www.ibm.com/servers/eserver/zseries/connectivity/>

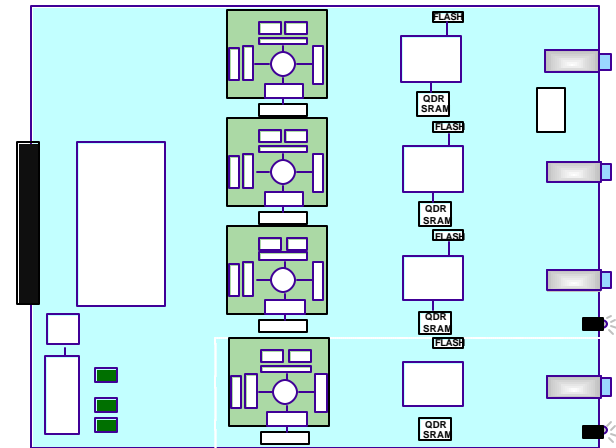

**LX = FC3319**

**SX = FC3320**

\*This performance data was measured in a controlled environment on a z990 running an I/O driver program under z/OS 1.6. The actual throughput or performance that any user will experience will vary depending upon considerations such as the amount of multiprogramming in the user's job stream, the I/O configuration, the storage configuration, and the workload processed.

# zSeries - FICON Express advantages over ESCON

## - FICON Express2 is faster

- **FICON Express provides up to a 10X improvement in distance solutions supporting disaster recovery applications**
- **FICON Express provides up to 10X the effective bandwidth per channel**
  - ƒ Maximum ESCON rate is 17 MB/s
  - ƒ Maximum FICON Express rate is 170 MB/s for either all reads or all writes and greater than 170 MB/sec for a combination of large sequential read and write operations
- **FICON Express supports up to 6X the I/O operations per second**
  - ƒ ESCON provides up to 1200 4K IOs/sec
  - ƒ FICON Express provides up to 7200 4K IOs/sec
- **FICON Express provides 16X as many devices**
  - ƒ ESCON supports 1K unit addresses per channel
  - ƒ FICON Express supports 16K unit addresses per channel
- **FICON Express uses fiber more efficiently**
  - ƒ ESCON has half duplex transfer data
  - ƒ FICON Express has **full duplex data transfer**
- **FICON Express provides relief for "channel constrained" systems**
  - ƒ 350% to 400% current ESCON channel utilization can be consolidated onto a single FICON Express channel for reasonable response times in a production workload environment

# zSeries SCSI IPL Feature

- **SCSI IPL is available as an optional, no-charge feature FC9904 for all zSeries**
  - ▶ FICON Express or FICON Express2 channel is required
- **FCP without SCSI IPL Feature**
  - ▶ Allows Linux, VM and z/VSE data to be stored on SCSI or FCP device
  - ▶ IPL to SCSI disk results in an error
    - An ECKD device is required
- **FCP with SCSI IPL Feature**
  - ▶ Allows Linux, VM and z/VSE data to be stored on SCSI or FCP device
  - ▶ Allows Linux, VM and z/VSE to install and load (IPL) on SCSI or FCP disk
    - IPL from both LPAR and/or z/VM guests
      - For z/VM guest IPL, z/VM 4.4 is required.
- **Linux LPARs can be started and run completely from SCSI or FCP disk**
  - ▶ z/VM continues to require ESCON or FICON attached disk or tape for its own IPL, storing of guest dumps, and other functions
    - Except for z/VM 5.1 (available 09/24/2004)
      - Emulates FBA 9336-20 on SCSI disk
- Standalone dump program can be loaded SCSI or FCP disk in order to dump the contents of a logical partition, and the dump data can be written to this same disk (except z/VSE).

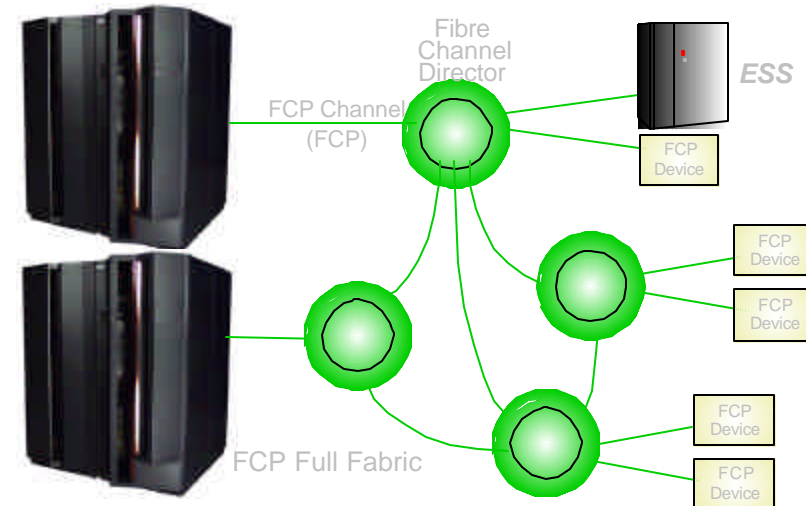

# OSA-Express2

- **Newest member - 10 Gigabit Ethernet LR (long reach)**
  - ▶ One port per feature
  - ▶ 9 micron single mode fiber, SC Duplex connector
- **New - Gigabit Ethernet features**
  - ▶ Gigabit Ethernet LX (Long wavelength)
    - 9 micron single mode fiber, LC Duplex connector
  - ▶ Gigabit Ethernet SX (Short wavelength)
    - 50 or 62.5 micron multimode fiber, LC Duplex connector
  - ▶ Designed to achieve line speed - 1 Gbps in each direction
- **Support offered by both 10 GbE and GbE:**
  - ▶ Queued Direct Input/Output (QDIO) for TCP/IP traffic only
    - Use TN3270 or Enterprise Extender for SNA traffic
  - ▶ **Layer 2 support** for flexible and efficient data transfer
  - ▶ **640 TCP/IP stacks** for improved virtualization
  - ▶ **Large send** for CPU efficiency
  - ▶ **Concurrent LIC update** to help minimize network traffic disruption
- **CHPID type for all features and functions listed is OSD**



10 Gigabit Ethernet  
Feature 3368

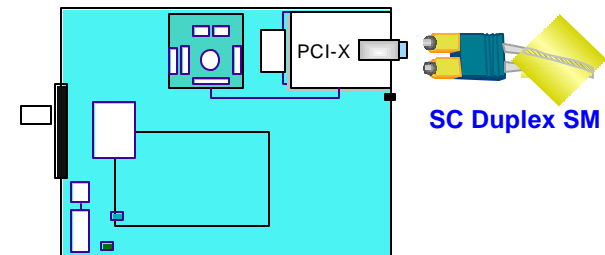

SC Duplex SM

Gigabit Ethernet  
Features 3364 (LX), 3365 (SX)

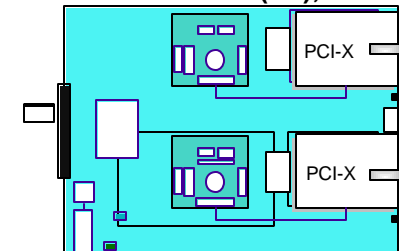

LC Duplex SM



LC Duplex MM



# OSA-Express2 & OSA-Express features

- **Up to 40 network connections - z890**
  - ▶ 24 on z890 capacity setting 110
- **Choose from 5 features**
  - ▶ OSA-Express2 10 GbE, GbE LX and SX
  - ▶ OSA-Express 1000BASE-T Ethernet
    - 10/100/1000 mbps
    - Same Cat 5 cable as Fast Ethernet
    - OSA ICC support
  - ▶ OSA-Express Token-Ring (4/16/100 Mbps)
    - Cat 5 copper cable
- **Modes of Operation for 1000BASE-T Ethernet, Token-Ring**
  - ▶ QDIO = TCP/IP traffic only
    - TN3270 or Enterprise Extender for SNA traffic
  - ▶ Non-QDIO = TCP/IP and/or SNA/APPN<sup>®</sup>/HPR
  - ▶ OSA-ICC for 1000BASE-T only
- **SOD** - z990/z890 are the last zSeries servers to support Token-Ring OSA - new build, upgrade, MES, or carry forward

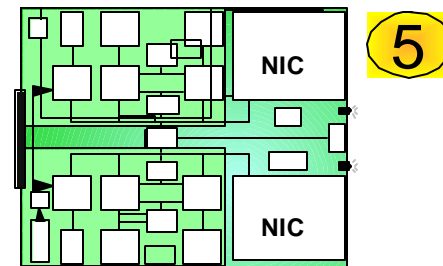
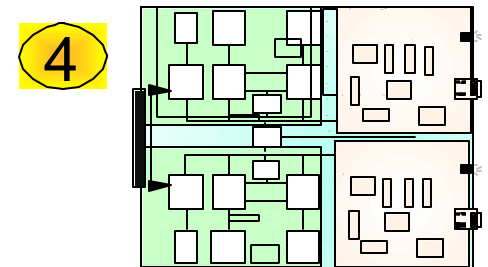
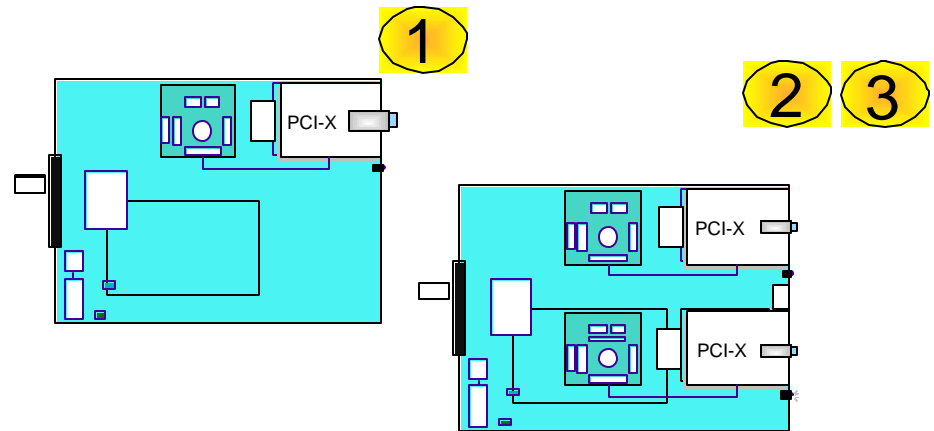

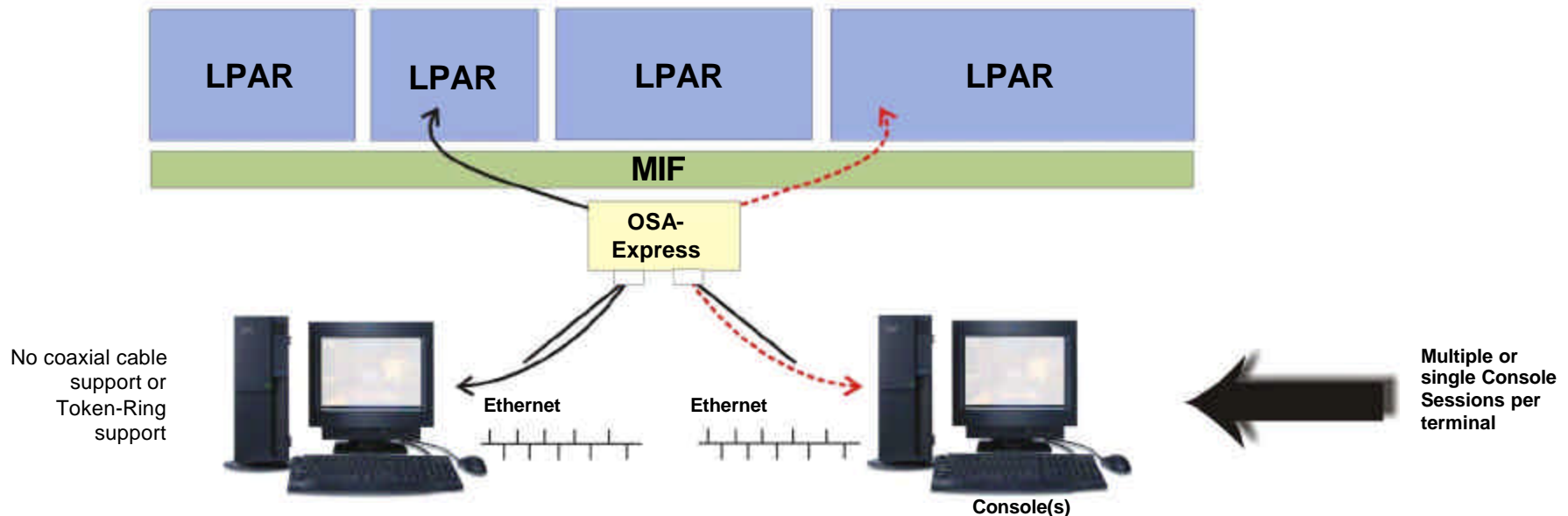

# OSA-Integrated Console Controller (OSA-ICC)

- **Console Controller for z890 and z990**
  - System Console (IPL) and operations support for multiple LPARs
- **Exclusive to OSA-Express 1000BASE-T Ethernet**
- **Minimum software:**
  - z/OS V1.3, z/VM V4.4, VSE/ESA™ V2.6, TPF 4.1
- **Supports Ethernet-attached TN3270E emulated sessions**
- **Can coexist in configurations using prior IBM 2074 models and older 3174 controllers**



**Enhanced multi-session LPAR control capability provides operational flexibility**

## z890 Security Options

- Common Criteria EAL5 Certification ← 
- Crypto Express2 feature ← 
  - ▶ Support high levels of security for demanding applications
  - ▶ Current applications expected to run without change
  - ▶ Fully programmable
  - ▶ Certified FIPS 140-2 level 4 ← 
  - ▶ Offers high-scale performance for SSL transactions
- Trusted Key Entry 4.2 workstation optional smart card reader
- CP Assist for Cryptographic Function (CPACF) delivers balanced support
  - ▶ Enabled via a no charge feature code
  - ▶ On every central processor (CP)



**zSeries continues to address the requirements for on demand security**

# z890/z990 Crypto Roadmap to Crypto Express2

## Integrated Cryptographic Service Facility (ICSF)

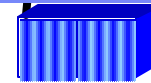

PU PU PU PU PU PU PU PU PU

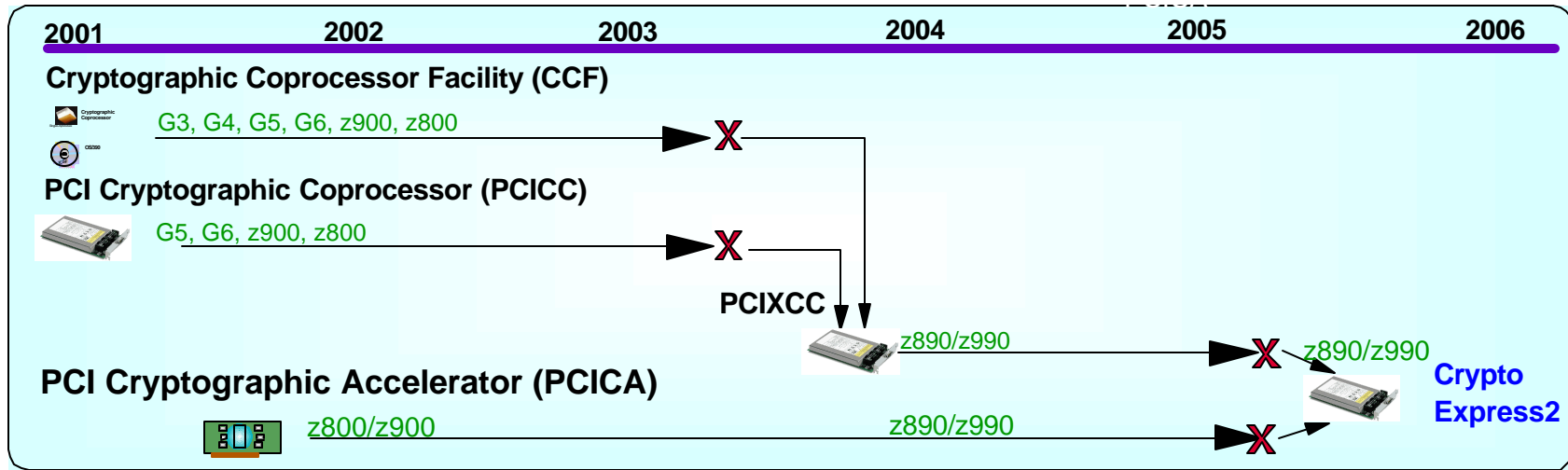

- z990/890 includes NO standard cryptographic function
- CP Assist for Cryptographic Function (message security assist) Feature #3863
- PCIXCC Feature – Supports “Secure key” cryptographic processing
- PCICA Feature – Supports “Public key” SSL cryptographic processing
- Crypto Express2 – Combines function and performance of PCICA and PCICC
- Migration to z990 when CCF, PCICC or PCICA is in use on an older machine usually requires Crypto Express2, PCIXCC and/or PCICA on z890/990.

# HiperSockets

- **Four times the connectivity of z800/z900**
  - ▶ From 4 to 16 HiperSockets
  - ▶ Connect four times more TCP/IP stacks
    - Increased number of communication queues (from 1,024 to 4,096)
  - ▶ Support for multiple LCSS
    - Single LP can connect to 16 HiperSockets
  
- **Support for spanned CHPIDs across multiple LCSS**
  - ▶ One HiperSocket can be shared by up to 30 Logical Partitions
  
- **Virtual LAN (IEEE 802.1q) support**
  
- **Broadcast for IPv4**

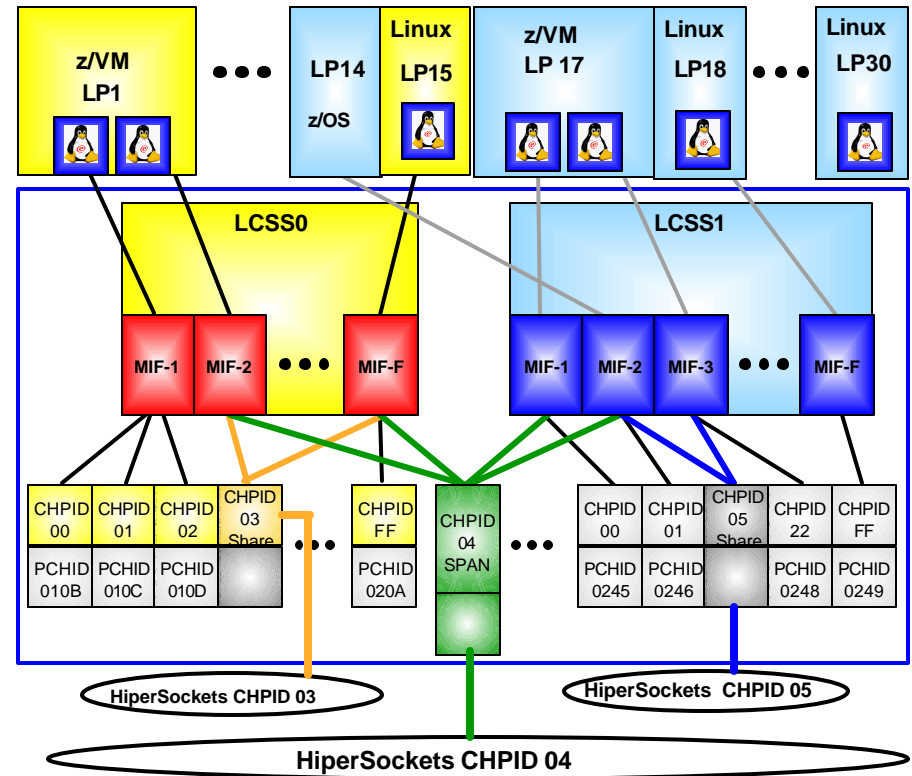

*Very High Speed Interconnection between programs running VSE/ESA, z/VM, z/OS or Linux®*

## z890 and z/VSE

- **Protect** existing client investments in VSE programs, data, equipment, IT skills, business processes, end user training, etc.
  - Modernize, Web-enable CICS® application
  - z890 servers, IBM storage and software
- **Integrate** VSE with the rest of your IT
  - VSE connectors and Web services
  - IBM middleware
- **Extend** with Linux on zSeries
  - New applications
  - Infrastructure simplification

### Why Not Think Inside the Box?

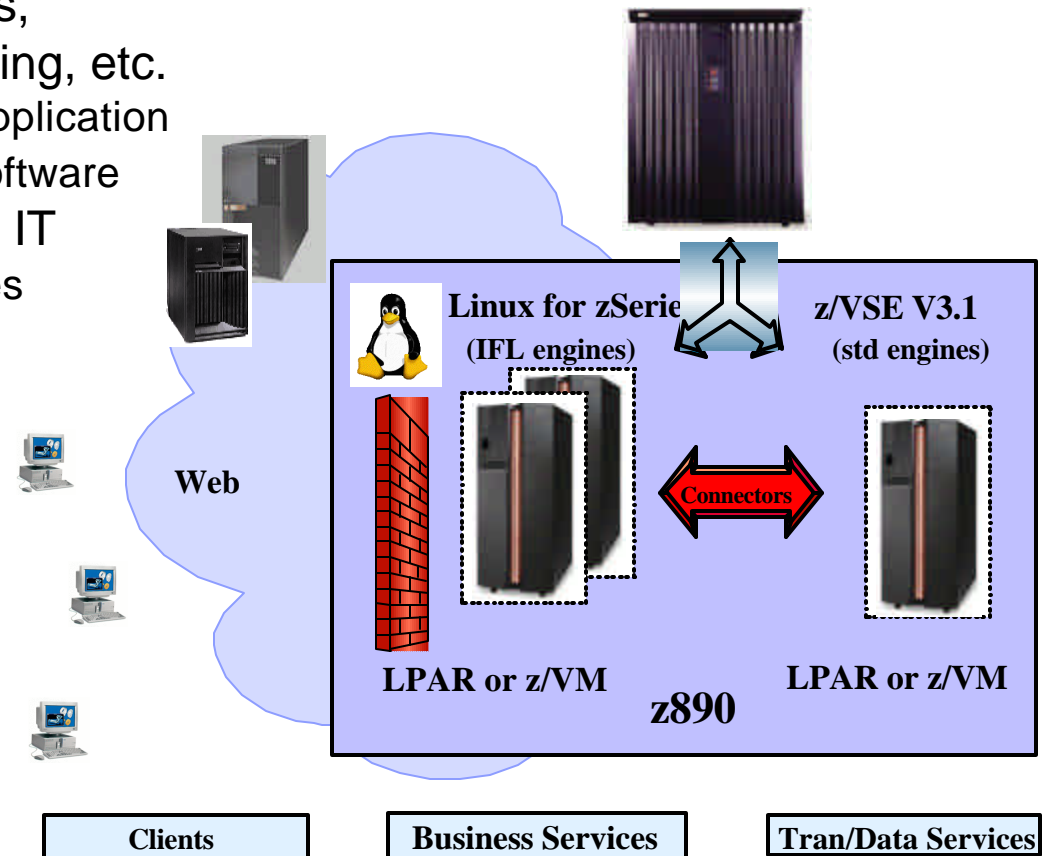

Note: z/VSE can execute in 31-bit mode only. It does not implement z/Architecture, and specifically does not implement 64-bit mode capabilities. z/VSE is designed to exploit selected features of IBM zSeries hardware.

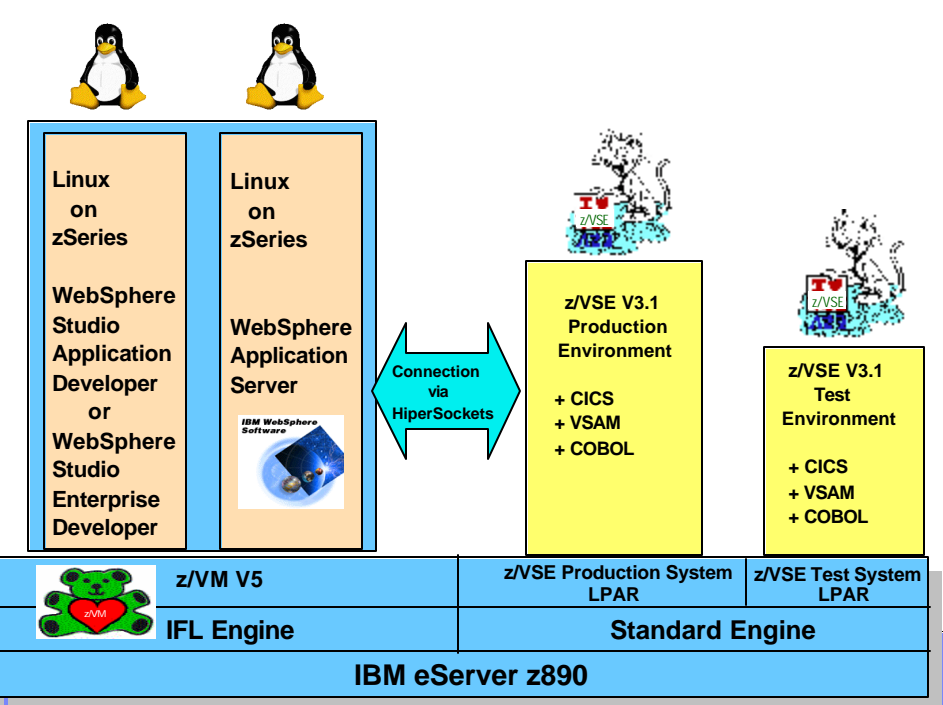
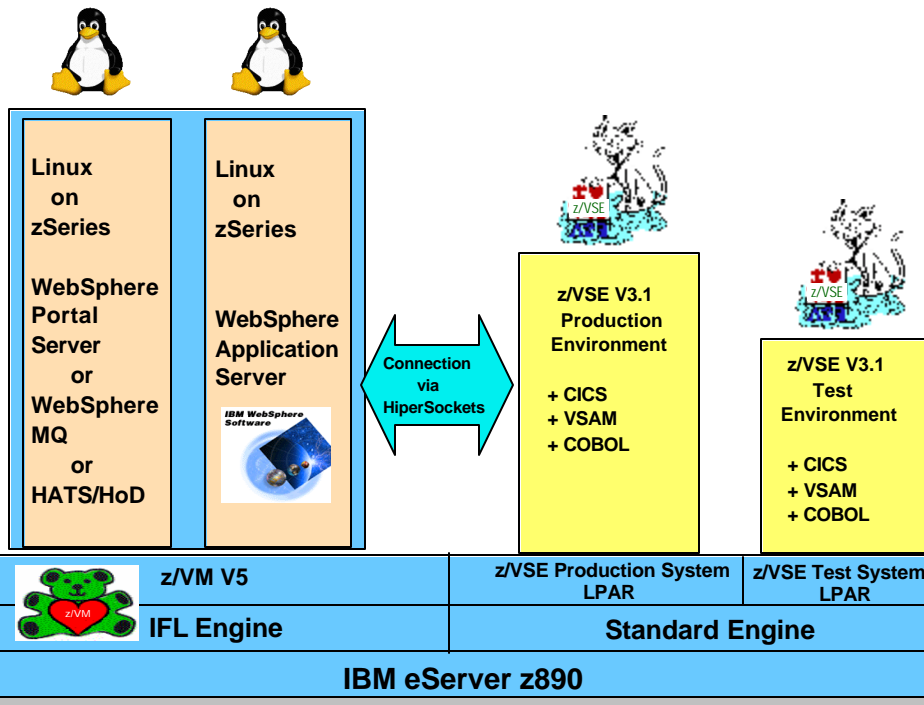
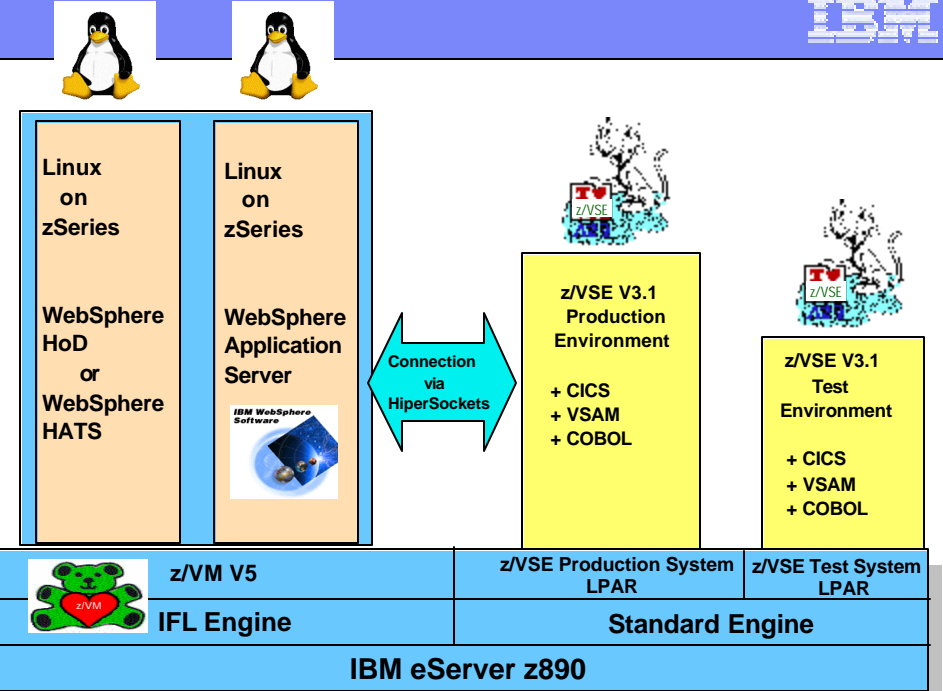
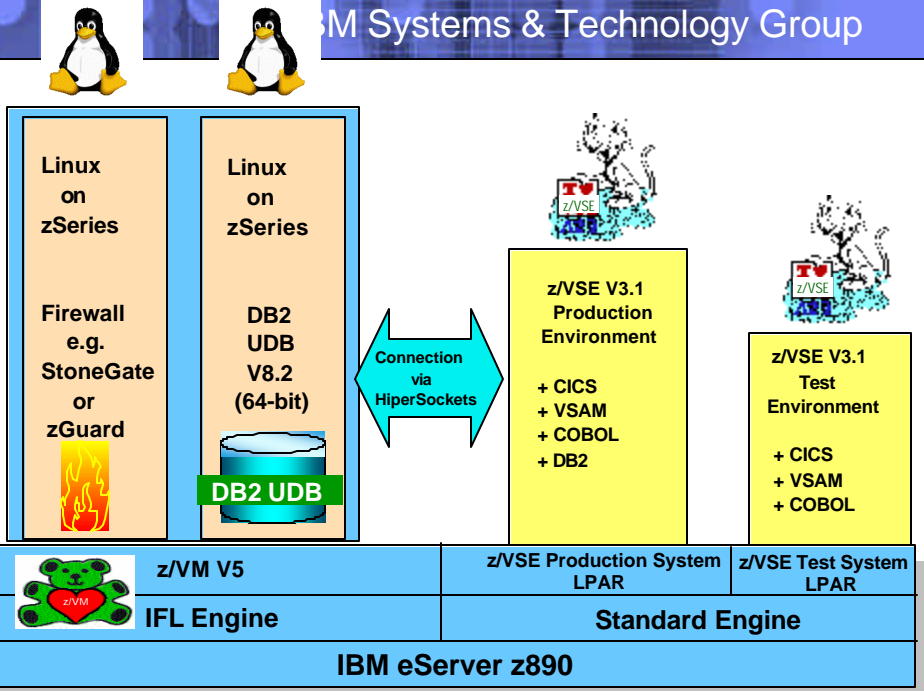

# Software Support and Pricing



## z890 Software Support Summary

Operating System	ESA/390 (31-bit)	z/Arch. (64-bit)	Compatibility	Exploitation
z/VSE Version 3 Release 1	Yes	No	Yes	Yes
VSE/ESA Version 2 Release 6 and 7	Yes	No	Yes	Yes
z/VM Version 5 Release 1	No	Yes	Included	Yes
z/VM Version 4 Release 4	Yes	Yes	Included	Yes
z/VM Version 4 Release 3	Yes	Yes	Yes	No
z/VM Version 3 Release 1	Yes	Yes	Yes	No
Linux on zSeries	No	Yes	Yes	Yes
Linux on S/390	Yes	No	Yes	Yes
z/OS and z/OS.e Version 1 Release 5, 6	No	Yes	Included	Included
z/OS and z/OS.e Version 1 Release 4	No	Yes	Yes	Yes
z/OS and z/OS.e Version 1 Release 3	No	Yes	Yes	No
z/OS Version 1 Release 2	No	Yes	Yes	No
OS/390 Version 2 Release 10	Yes	Yes	Yes	No
TPF Version 4 Release 1 (ESA mode only)	Yes	No	Yes	No

# z/VSE Version 3 Release 1 (GA 3/04/2005)

## z890 Support

- ▶ up to 30 LPARs, up to 2 LCSS (up to 4 on z990)
- ▶ FICON Express2
- ▶ OSA Express2 (incl GbE, 10GbE)
- ▶ OSA-ICC
- ▶ CryptoExpress2 (as PCICA)
- ▶ CPACF
- ▶ SCSI disk (CHPID=FCP)
- ▶ HiperSockets

## IBM TotalStorage Support

- ▶ Advanced Copy Services (FlashCopy, Remote Mirror)
- ▶ DS6000 and DS8000 disk storage
- ▶ 3494 Virtual Tape System, 3494 Tape Library, 3592 Tape

## Connectors

- ▶ IBM middleware (ie. CICS Tranaction Gateway, DB2 UDB/DB2 Connect, WebSphere MQ)
- ▶ VSE e-business connectors
- ▶ VSE/VSAM Redirector
- ▶ VSE VTape
- ▶ VSE Web Services (i.e. SOAP, XML)



[www.ibm.com/servers/eserver/zseries/zvse](http://www.ibm.com/servers/eserver/zseries/zvse)

Note: z/VSE can operate in 31-bit mode only. It does not implement z/Architecture and specifically does not implement 64-bit mode capabilities. z/VSE is designed to support selected features of IBM zSeries hardware

## z/V z/VM Version 5.1 Enhancements (GA 9/24/2004)

### New pricing model based on engine-based Value Units

- ▶ Provides a lower entry price and a decreasing price curve as more processor engines are purchased

### Virtualization enhancements for Linux and other guests

- ▶ Install, IPL, and operate from SCSI FCP disks
- ▶ Install of z/VM from a DVD to SCSI FCP disks and to 3390 DASD format
- ▶ Support for FCP LUN Access Control for added control of SCSI devices
- ▶ Support for new HyperSwap™ command
- ▶ PCIX Cryptographic Coprocessor (PCIXCC) and Crypto Express2 support
- ▶ Enhanced systems management APIs
- ▶ Dynamic virtual machine timeout

### Networking virtualization and security enhancements

- ▶ Virtual switch exploitation of OSA-Express and OSA-Express2 Layer 2
- ▶ Improved virtualization with more TCP/IP stacks with OSA-Express2
- ▶ OSA-Express TCP/IP stack utilization improvements
- ▶ Authorization enhanced for guest LANs and virtual switches

### Technology exploitation

- ▶ Support for Crypto Express2, FICON Express2, and OSA-Express2
- ▶ Capability to route IPv6 packets and develop IPv6 applications

### Systems management improvements

- ▶ Performance Toolkit for VM enhancements
- ▶ Service and installation enhancements



## VSE Pricing for zSeries 890

1-way	2-way	3-way	4-way
<b>110</b> (zELC)	<b>210</b> (EWLC Tier A)	<b>310</b> (EWLC Tier A)	<b>410</b> (EWLC Tier B)
<b>120</b> (EWLC Tier A)	<b>220</b> (EWLC Tier B)	<b>320</b> (EWLC Tier C)	<b>420</b> (EWLC Tier C)
<b>130</b> (EWLC Tier B)	<b>230</b> (EWLC Tier C)	<b>330</b> (EWLC Tier C)	<b>430</b> (EWLC Tier D)
<b>140</b> (EWLC Tier C)	<b>240</b> (EWLC Tier C)	<b>340</b> (EWLC Tier D)	<b>440</b> (EWLC Tier D)
<b>150</b> (EWLC Tier C)	<b>250</b> (EWLC Tier D)	<b>350</b> (EWLC Tier D)	<b>450</b> (EWLC Tier E)
<b>160</b> (EWLC Tier C)	<b>260</b> (EWLC Tier D)	<b>360</b> (EWLC Tier E)	<b>460</b> (EWLC Tier E)
<b>170</b> (EWLC Tier D)	<b>270</b> (EWLC Tier E)	<b>370</b> (EWLC Tier E)	<b>470</b> (EWLC Tier E)

Note: For z890, VSE is priced using EWLC – Tiered Price Structure. zELC prices are used for Capacity Setting 110 (only).

# Replace your Multiprise<sup>®</sup> 2000 running VSE with an IBM eServer zSeries 890 and Save!



## ▪ Innovation on IBM eServer<sup>™</sup> zSeries<sup>®</sup> 890

- ▶ High Capacity IFL
- ▶ OSA-Express, OSA-ICC
- ▶ On/Off Capacity on Demand
- ▶ PCI Crypto
- ▶ HiperSockets<sup>™</sup>

## ▪ Ongoing Savings help you offset the cost of your hardware investment.

### ▪ Savings driven by:

- f* Lower priced VSE/ESA<sup>™</sup> on the z890 with zELC or EWLC Tiered Price Structure versus Model Group software pricing

### Potential Annual Savings

**MP2000-107**

With Int Disk

**z890-110**

4% Growth & ext disk

**MP2000-107**

Without Int Disk

**z890-110**

4% Growth & no disk

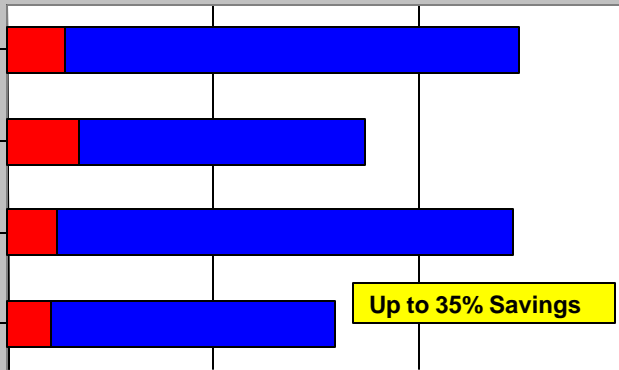

Up to 35% Savings

■ IBM Maintenance Cost ■ IBM S/W monthly license charges

### Potential Annual Savings

**MP2000-126**

With Int Disk

**z890-130**

29% Growth & ext disk

**MP2000-126**

Without Int Disk

**z890-130**

29% Growth & no disk

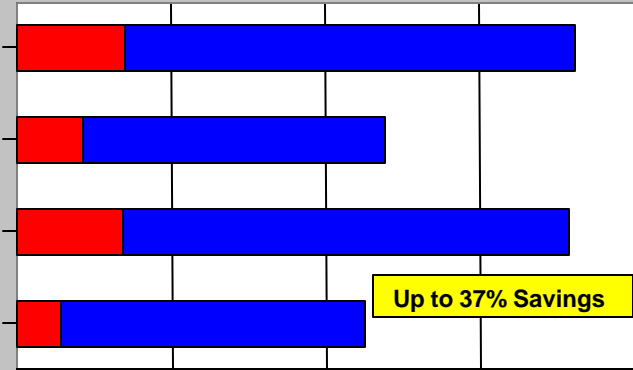

Up to 37% Savings

■ IBM Maintenance Cost ■ IBM S/W monthly license charges

\* Hardware configuration based on general purpose central processors only (no IFLs) and similarly configured for costing purposes. VSE software stack based on VSE/ESA, CICS, DITTO, SSP, VTAM, COBOL, LE and HLA.

# Too much capacity on your Multiprise 3000 running VSE today? Consider a z890 to bring new technology to your firm!

## ■ Innovation on z890

- ▶ High Capacity IFL
- ▶ OSA-Express, OSA-ICC
- ▶ On/Off Capacity on Demand
- ▶ PCI Crypto
- ▶ HiperSockets



### Potential Annual Savings

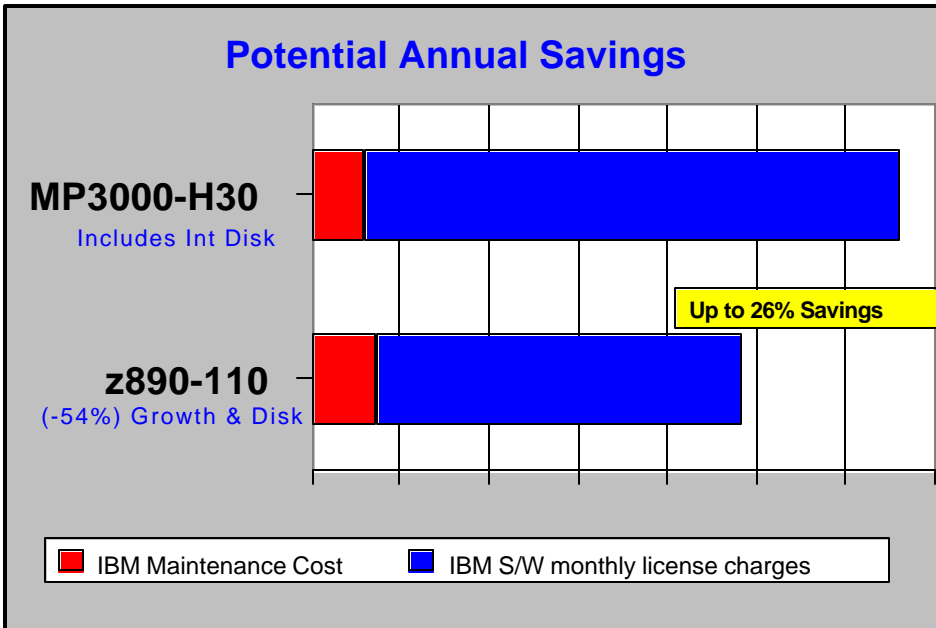

■ **Ongoing Savings help you offset the cost of your hardware investment.**

■ **Savings driven by:**

- f* Providing a solution with the granularity you need
- f* Lower priced VSE on the 110 with full capacity zELC versus GOLC software pricing

■ **Additional Value considerations:**

- f* IGF certified used ESS F20 – 420 GB capacity
- f* Granular upgradeability
- f* Temporary capacity available with On/Off Capacity on Demand

\* Hardware configuration based on general purpose central processors only (no IFLs) and similarly configured for costing purposes. VSE software stack based on VSE/ESA, CICS, DITTO, SSP, VTAM, COBOL, LE and HLA.

# Replace your 9672 G4 running VSE with a z890 and Save!



## ■ Innovation on z890

- ▶ High Capacity IFL
- ▶ OSA-Express, OSA-ICC
- ▶ On/Off Capacity on Demand
- ▶ PCI Crypto
- ▶ HiperSockets

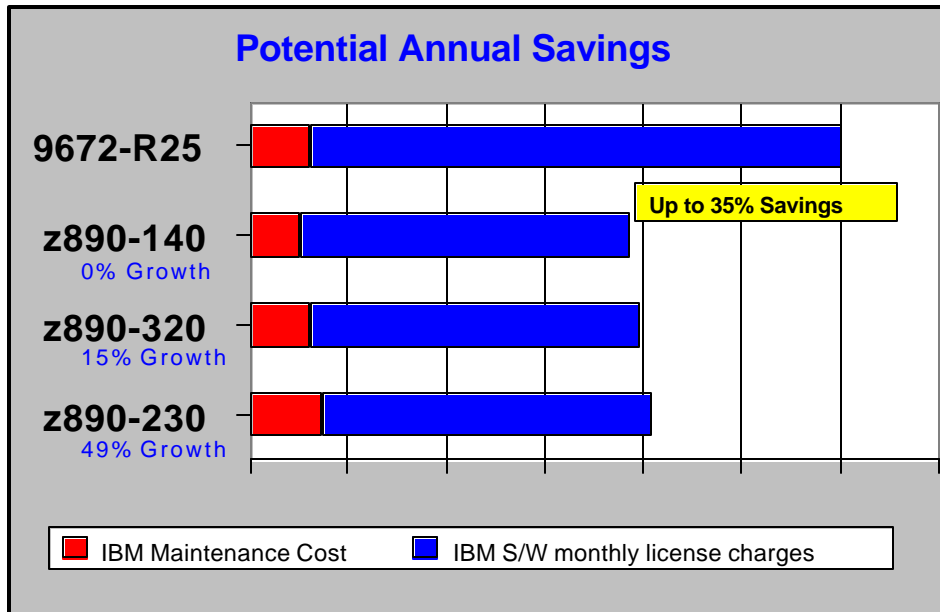

■ **Ongoing Savings help you offset the cost of your hardware investment.**

## ■ Savings driven by:

- f* Lower priced IBM hardware maintenance on z890-140
- f* Lower priced VSE on the 140, 320 and 230 with Tiered Price Structure versus Model Group software pricing

## ■ Additional Value considerations:

- f* Granular upgradeability
- f* Temporary capacity available with On/Off Capacity on Demand

\* Hardware configuration based on general purpose central processors only (no IFLs) and similarly configured for costing purposes. VSE software stack based on VSE/ESA, CICS, DITTO, SSP, VTAM, COBOL, LE and HLA.

# Migration Planning





# IBM Networking Services for zSeries fiber cabling

Short wave

FICON

ESCON

Jumper cables

Long wave

New connectors

LC Duplex MM



LC Duplex SM

Fibre Channel Protocol

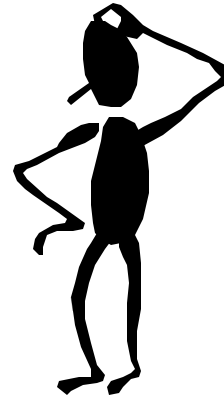

Trunking solutions

Small form factor connectors

Conversion kits

62.5 micron

50 micron

9 micron



Mode conditioning kits

*A seamless, comprehensive, integrated fiber cabling service*

## IBM Networking Services for zSeries fiber cabling

- Changing environments, protocols and products
  - ▶ System or enterprise-wide view
  - ▶ Multitude of choices
    - Connectors, cables, products
    - Tactical and strategic decisions
- Right-sized packaged offering
  - ▶ Contracted, fixed-price service
  - ▶ End-to-end service
    - Planning -> Consultation -> Cables -> Installation -> Connection report

Plan  
Procure  
Install  
Document



*A seamless, comprehensive, integrated fiber cabling service*

## Considerations

- No Internal-Disk
  - ▶ DS6000 or ESS 750 Shark
  - ▶ IGF certified used ESS F20 – 420 GB capacity
- LPAR mode only (no basic mode)
  - ▶ No I/O Assist for V=F or V=R guests
- Parallel channels
  - ▶ Same as z800
  - ▶ Use Optica ESCON® Converter or IBM 9034
- OSA-2 ATM or FDDI
  - ▶ Migrate to OSA-Express Ethernet or use multi-purpose switch

**Bill Bitner or  
Alan Altmark**

## z890 Summary



- **New IBM eServer zSeries 890 delivered with price/performance and technology-driven business value**
  - ▶ 28 capacity settings provide flexibility and granular growth
  - ▶ Specially designated workload processors available for Coupling, Linux and Java™ workloads
  - ▶ Entry point at 4 MSUs and 28 capacity settings can help you to better manage software costs
  - ▶ Up to 140% price/performance improvement for Linux IFLs over z800
  - ▶ Up to 10% price/performance improvement on Maintenance over z800
  - ▶ Entry Workload License Charge (EWLC) and EWLC Tiered Price Structure introduced for flat charged products
  - ▶ New cost effective z/VM V5.1 with engine-based pricing
  - ▶ New z/VSE
  - ▶ Linux for Infrastructure Simplification or application modernization
  - ▶ On/Off Capacity on Demand
  - ▶ OSA-Integrated Console Controller
  - ▶ New and Improved Networking and Connectivity Options

## Reference Material



## z890 Publications via ResourceLink

- |   |           |  |           |
|---|-----------|--|-----------|
| ▪ Agreement for Licensed Internal Code            | SC28-6822 |  |           |
| ▪ Application Programming Interfaces              | SB10-7030 |  |           |
| ▪ Capacity Backup User's Guide                    | SC28-6823 |  |           |
| ▪ CHPID Mapping Tool User's Guide                 | SC28-6825 |  |           |
| ▪ CF Channel I/O Interface Physical Layer         | SA23-0395 |  |           |
| ▪ ESCON and FICON Channel-to-Channel              | SB10-7034 |  |           |
| ▪ ESCON Physical Layer                            | SA23-0394 |  |           |
| ▪ FICON I/O Interface Physical Layer              | SA24-7172 |  |           |
| ▪ HW Management Console Operations Guide (V1.8.2) | SC28-6830 |  |           |
| ▪ Installation Manual for Physical Planning       | GC28-6828 |  |           |
| ▪ Installation Manual                             | GC28-6826 |  |           |
| ▪ IOCP User's Guide                               | SB10-7037 |  |           |
|   |           | ▪ Maintenance Information for Desktop Consoles                   | GC38-3115 |
|   |           | ▪ Maintenance Information for Fiber Optic Links                  | SY27-2597 |
|   |           | ▪ Maintenance Information for Thinkpad Consoles                  | GC38-3117 |
|   |           | ▪ Parts Catalog  | GC28-6829 |
|   |           | ▪ Planning for Fiber Optic Links                                 | GA23-0367 |
|   |           | ▪ PR/SM Planning Guide   | SB10-7036 |
|   |           | ▪ Safety Notices   | G229-9054 |
|   |           | ▪ Safety Inspection  | GC28-6833 |
|   |           | ▪ Service Guide  | GC28-6827 |
|   |           | ▪ Standalone IOCP User's Guide                                   | SB10-7040 |
|   |           | ▪ SCSI IPL - Machine Loader Messages                             | SC28-6839 |
|   |           | ▪ Support Element Operations Guide (Version 1.8.2)               | SC28-6831 |
|   |           |  |           |
|   |           | ▪ <a href="http://www.redbooks.ibm.com">www.redbooks.ibm.com</a> |           |
|   |           | ▪ z890 Technical Introduction                                    | SG24-6310 |
|   |           | ▪ zAAP Implementation  | SG24-6386 |
|   |           | ▪ z890 SAPR Guide  | SA04-002  |

End of Presentation

IBM

@server







© The History of IBM



1964



1972



1982



1999



2004

2005

*Thank you for your  
time and for doing  
business with IBM*

# Backup/Miscellaneous Material

## We have come a long way in 40 years!!!!

	<b>System/360 Model 50</b>	<b>z/890</b>
Introduction	April 7, 1964	April 7, 2004
Typical arithmetic operations per second	20 to 50,000	Billions
Machine cycle time	500 nanoseconds	1 nanosecond
Memory cycle time	2 microseconds	2 nanosecond
Registers	20 32-bit	Over 200 64-bit
On chip L1, off chip L2	Not invented	512KB/chip, 32MB/MCM
Storage Main Memory	64KB, 128K, 256K	8-32 GB
Channel attached storage	1-8 MB(Bulk core storage)	Terabytes (Disk)
Channel high speed	.8 MB/sec.	2 Gb/sec. (using FICON)
Performance	Under 1 MIPS (.13958)	Approx. 26-1365 MIPS
Price	\$ Millions	Starting <\$200K to +\$1M
Reliability	Days	Decades

## Key References for z990 and z890 Operating Systems

- Primary Operating System Web sites for z990 and z890
  - ▶ z/OS: [www.ibm.com/servers/eserver/zseries/zos/](http://www.ibm.com/servers/eserver/zseries/zos/)
    - Downloads: [www.ibm.com/servers/eserver/zseries/zos/downloads/](http://www.ibm.com/servers/eserver/zseries/zos/downloads/)
    - Migration:  
[www.ibm.com/servers/eserver/zseries/zos/bkserv/zos\\_migration\\_manuals.html](http://www.ibm.com/servers/eserver/zseries/zos/bkserv/zos_migration_manuals.html)
    - Library: [www.ibm.com/servers/eserver/zseries/zos/bkserv/](http://www.ibm.com/servers/eserver/zseries/zos/bkserv/)
  - ▶ z/VM: [www.vm.ibm.com/](http://www.vm.ibm.com/)
  - ▶ Linux on zSeries: [www.ibm.com/servers/eserver/zseries/os/linux/](http://www.ibm.com/servers/eserver/zseries/os/linux/)
  - ▶ VSE/ESA: [www.ibm.com/servers/eserver/zseries/os/vse/](http://www.ibm.com/servers/eserver/zseries/os/vse/)
- OS Preventative Service Planning (PSP) Buckets for z990 and z890
  - ▶ z/OS: Upgrade = 2084DEVICE, Subset = 2084/ZOS  
Upgrade = 2086DEVICE, Subset = 2086/ZOS
  - ▶ z/VM: Upgrade = 2084DEVICE, Subset = 2084Z/VM  
Upgrade = 2086DEVICE, Subset = 2086Z/VM
  - ▶ VSE/ESA: Upgrade = 2084DEVICE, Subset = 2084VSE/ESA  
Upgrade = 2086DEVICE, Subset = 2086VSE/ESA

# Where to Find More Information...

- zSeries Home Page
  - ▶ <http://www-1.ibm.com/servers/eserver/zseries/>
- eServer Home Page
  - ▶ <http://www.ibm.com/eserver>
- zSeries Announcement Landing Page
  - ▶ <http://www.ibm.com/servers/eserver/zseries/feature100704>
- IBM Scholars Program & IT Co-op Program
  - ▶ **Scholars zSeries Program & University Participants:** <http://ibm.com/university/zseries>
  - ▶ **Scholars zSeries & Co-op Program contact:** [univprg@us.ibm.com](mailto:univprg@us.ibm.com)
- IBM ITTS Offerings - shorten
  - ▶ **IBM ITTS zSeries Curriculum View:** <http://ibm.com/services/learning/us/catalog/zseries/zSeries>
  - ▶ **Roadmaps:** <http://ibm.com/services/learning/us/catalog/zseries/roadmaps/>
  - ▶ **Digital Video Library:** <http://ibm.com/services/learning/us/elearning/dvl>
  - ▶ **1-800-IBM-TEACH**
- IBM zSeries Technical Support
  - ▶ **IBM zSeries Technical Support:** <http://www-1.ibm.com/servers/eserver/support/zseries/>
- IBM zSeries Open Source Information
  - ▶ **See Open Source page earlier in package**
- Virtual Innovation Center for Enabling Solutions on zSeries
  - ▶ <http://www-1.ibm.com/servers/enable/z/index.html>
- IBMs Global Solutions Directory - thousands of applications, tools and services from IBM and IBM Business Partners
  - ▶ <http://www.developer.ibm.com/solutions/isv/igssg.nsf/LanguageSelector?OpenForm>
- Business Partner Search
  - ▶ <http://www.developer.ibm.com/bpconnections/bpcms.nsf/publicsearchGUI?OpenFrameset&NL=en>
- ISV Solution Link- **Automated Sales Channel Enablement for ISV and IBM Solutions**
  - ▶ <http://www-1.ibm.com/servers/solutions/finder/CSFServlet.wss>
- Consultant and Integrator info and activities  
[www.ibm.com/partner/consultants](http://www.ibm.com/partner/consultants) **click on your region, then Hardware/Servers, then zSeries**

# z/VM and VSE/ESA Support Summary Dates



		G3-G4	G5/G6 Multiprise 3000	z800	z890	z900	z990	End of Market	End of Service	Ship Date
VSE/ESA	2.5	x	x	x		x	x <sup>c</sup>	12/01	12/03	9/00
	2.6*	x	x	x	x <sup>c</sup>	x	x <sup>c</sup>	****	3/06**	12/01
	2.7*		x	x	x	x	x			3/03
z/VSE***	3.1		x	x	x	x	x			2005**
z/VM	3.1	x	x	x	x <sup>c</sup>	x	x <sup>c</sup>	8/04	12/05**	2/01
	4.1		x	x		x	x <sup>c</sup>	10/04	6/03	7/01
	4.2		x	x		x	x <sup>c</sup>	5/02	12/03	10/01
	4.3		x	x	x <sup>c</sup>	x	x <sup>c</sup>	8/03	5/05**	5/02
	4.4*		x	x	x	x	x		9/06**	8/03
	5.1*			x	x	x	x		9/07**	9/04

x<sup>c</sup> - Compatibility support  
 \* Releases currently orderable  
 \*\* Announced date

\*\*\* z/VSE 3.1 is designed to exploit some features of IBM zSeries processors but does not implement z/Architecture and does not implement 64-bit mode capabilities.  
 \*\*\*\* VSE/ESA 2.6 can be ordered only as a "Service Option" with VSE/ESA 2.7.

# z/OS Support



		G3-G4	G5/G6 Multiprise 3000	z800 z900	z890 z990	End of Service	Coexistence Migration Policy	Ship Date
OS/390	2.8	x	x	x		9/02	1.2	9/99
	2.9	x	x	x		9/03	1.3	3/00
	2.10	x	x	x	x <sup>c</sup>	9/04	1.4	9/00
z/OS	1.1		x	x		3/04	1.4	3/01
	1.2		x	x	x <sup>c</sup>	10/04	1.5	10/01
	1.3		x	x	x <sup>c</sup>	3/05*	1.6	3/02
	1.4		x	x	x	3/07*	1.7*	9/02
	1.5		x	x	x	3/07**	1.8*	3/04
	1.6			x	x	9/07**	1.8*	9/04

**Orderable: z/OS 1.6, z/OS 1.4 SystemPac until 3/2005\*, z/OS 1.4 exploitation feature until 12/2006\*.**

x<sup>c</sup> Compatibility support – does not exploit new z990 features. **Web download withdrawn 12/31/2004.**

Bimodal Accommodation Offering is available for z/OS 1.2, 1.3, and 1.4. It is not available for later releases.

\*Planned date or release



# FICON Express2 Performance (FC channel)

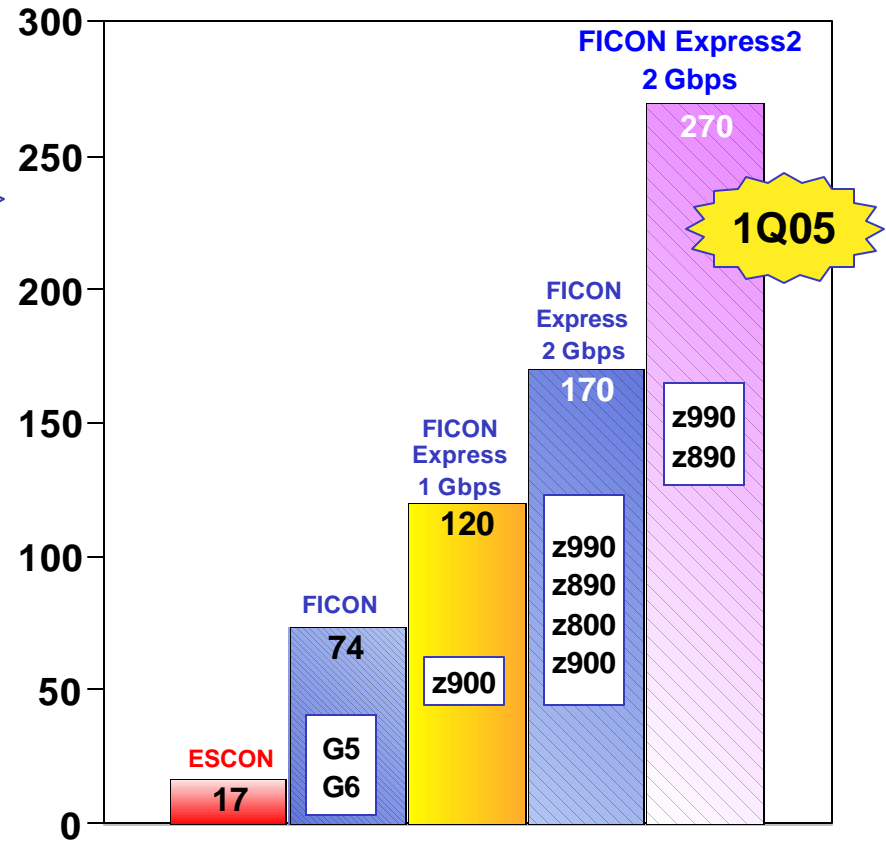
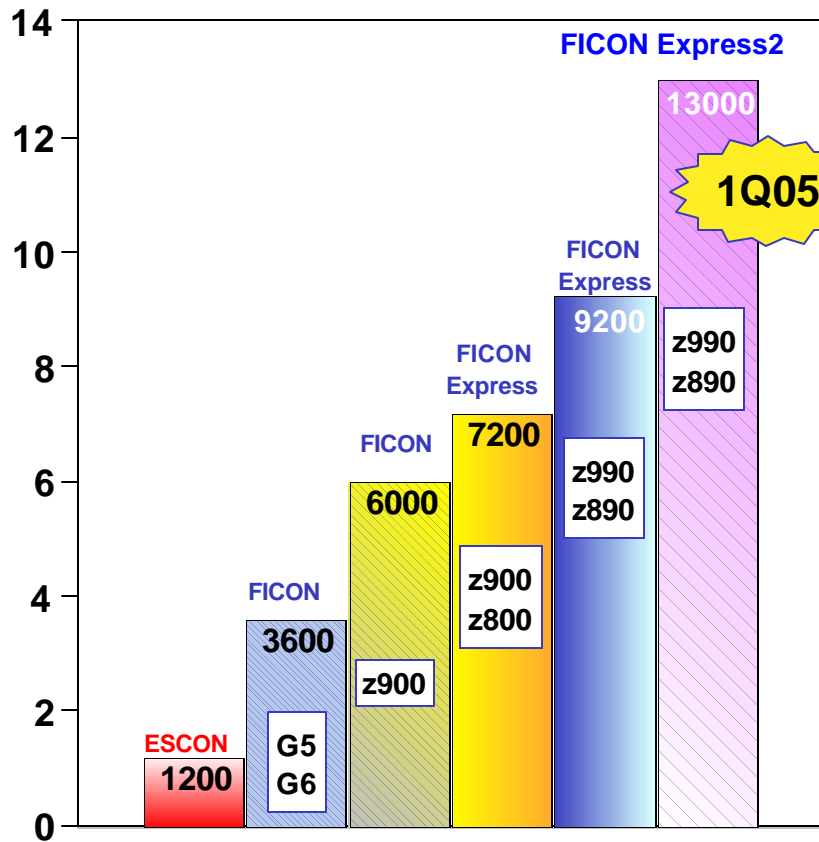



## I/O Features: Connectors / Cables

Feature Code	Feature Name	Connector Type	Cable Type
0219	ISC-3 link	LC Duplex	9 micron SM
6154	External Time Reference (ETR)	MTRJ	62.5 micron MM
2324	ESCON channel	MTRJ	62.5 micron MM
2319	FICON Express LX	LC Duplex	9 micron SM
2320	FICON Express SX	LC Duplex	50, 62.5 micron MM
3319	FICON Express2 LX	LC Duplex	9 micron SM
3320	FICON Express2 SX	LC Duplex	50, 62.5 micron MM
2364	OSA-Express GbE LX	SC Duplex	9 micron SM
2365	OSA-Express GbE SX	SC Duplex	50, 62.5 micron MM
2366	OSA-Express Fast Ethernet	RJ-45	Category 5 UTP
2367	OSA-Express Token-Ring	RJ-45	STP or UTP
1364	OSA-Express GbE LX	LC Duplex	9 micron SM
1365	OSA-Express GbE SX	LC Duplex	50, 62.5 micron MM
1366	OSA-Express 1000BASE-T Ethernet	RJ-45	Category 5 UTP
3364	OSA-Express2 GbE LX	LC Duplex	9 micron SM
3365	OSA-Express2 GbE SX	LC Duplex	50, 62.5 micron MM
3368	OSA-Express2 10 GbE LR	SC Duplex	9 micron SM

# Breaking the Barrier

## OSA-Express2 (OSA-E2), OSA-Express (OSA-E)

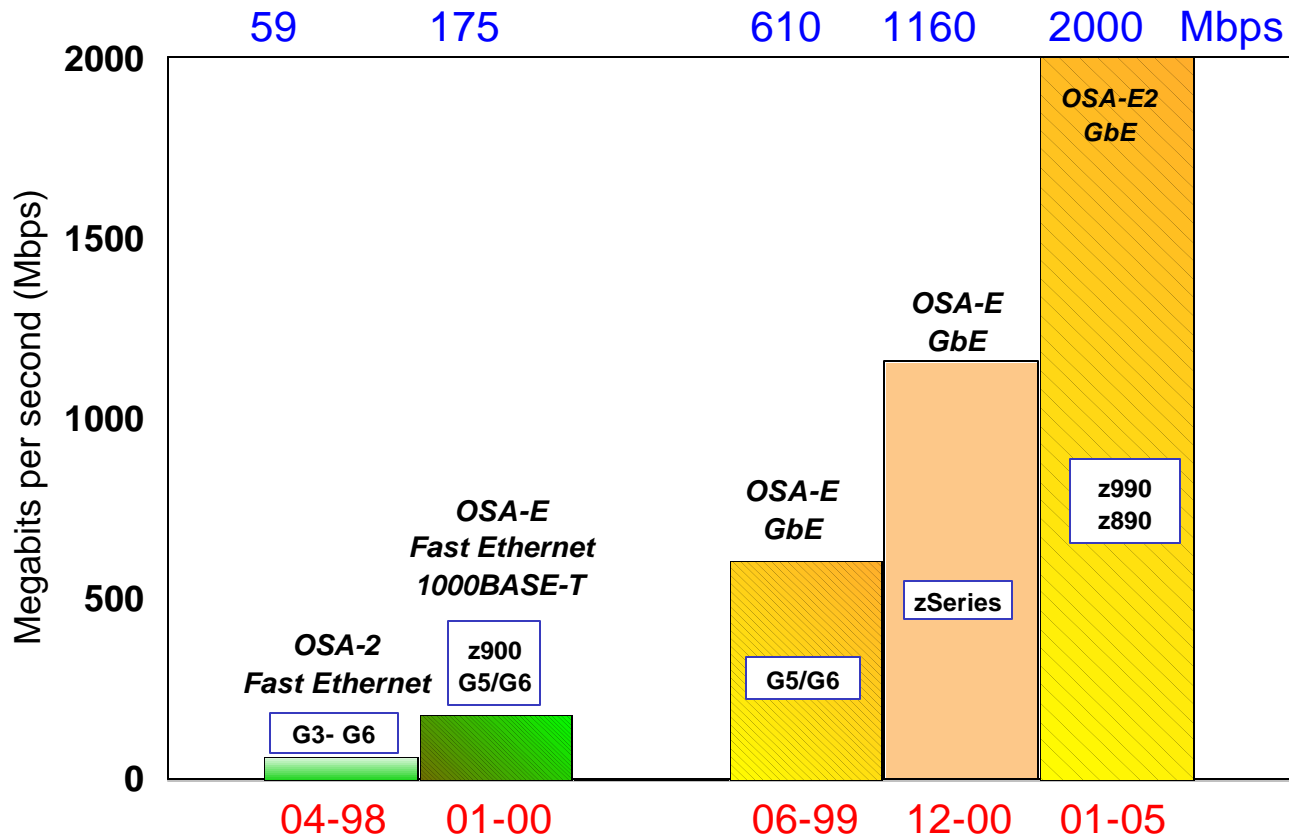

# OSA-Express2 – Third Generation OSA-Express

**Generation**

**Third . . . . .**

**Second . . . . .**

**First . . . . .**

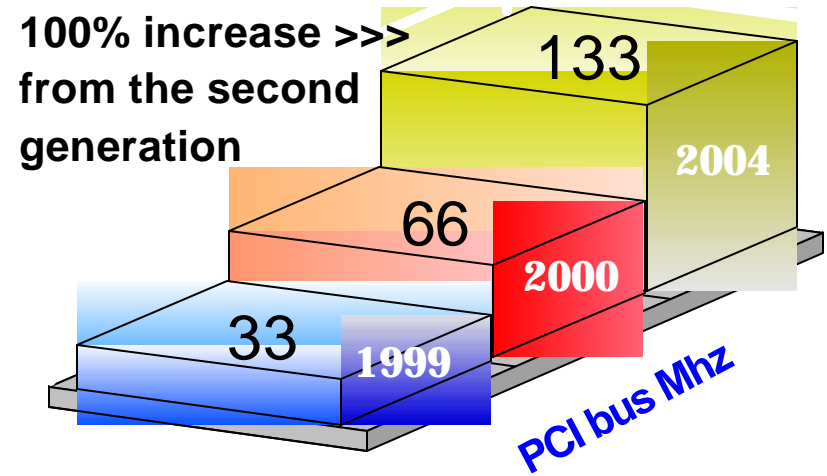
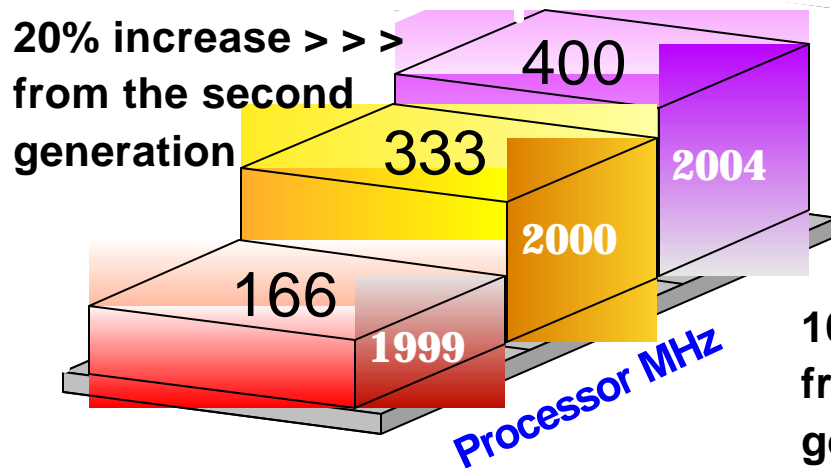

- OSA-Express2 is the 3rd generation of Ethernet technology to deliver the throughput needed to satisfy bandwidth-hungry applications
- OSA-Express2 GbE is designed to achieve line speed - 1 Gbps in each direction

# OSA-Express2 Large Send Support

- OSA-Express2 (GbE and 10 GbE)  
(Available January 28, 2005)
- Segmentation of IP packets done by OSA-Express2, not TCP/IP stack
  - ▶ **Offloads the TCP segmentation processing from CPs or IFLs**
  - ▶ Host code path length reduced
  - ▶ Sends 64 KB blocks to OSA-Express2
- Processing performed by OSA-Express2
  - ▶ TCP/IP checksum processing
  - ▶ TCP packet processing
  - ▶ Sends out 1.5 KB packets (1492 byte)
- QDIO mode only (CHPID type OSD)
  - ▶ For outbound traffic only
  - ▶ For IPv4, IPv6
  - ▶ For unicast datagrams
- Support planned:
  - ▶ **z/OS Communications Server with z/OS or z/OS.e 1.7** (1.6 with PTF) for TCP/IPv4 traffic only
  - ▶ **Linux® on zSeries** with code IBM intends to deliver Open Source in early 2005

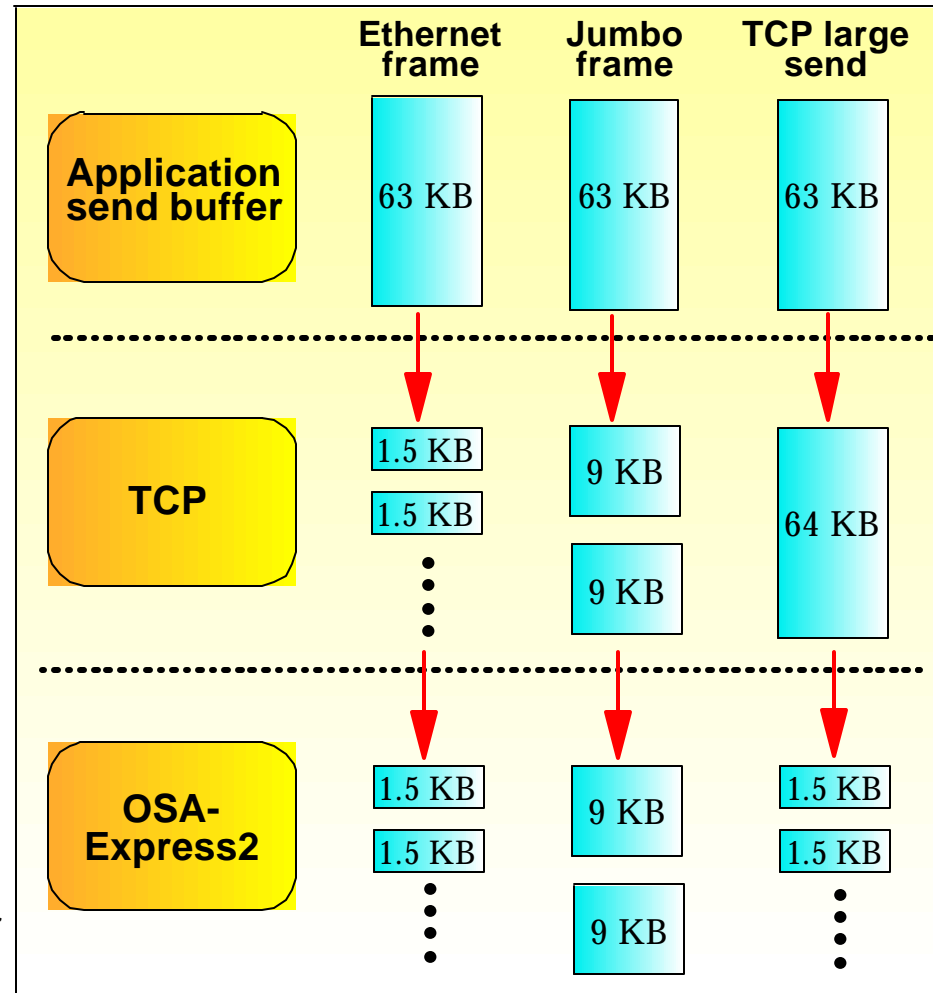



# Up to 640 TCP/IP stacks for improved virtualization

- Exclusive to OSA-Express2
  - 640 TCP/IP stacks per OSA-Express2 port/CHPID
- For hosting more images on zSeries
- Reduce the number of OSA features required to host multiple images
- Exclusive to OSA-Express2 (GbE, 10 GbE)
  - QDIO mode only (CHPID type OSD)
- Supported by
  - z/OS and z/OS.e V1.6 with PTF
  - z/VM V5.1
  - Linux on zSeries

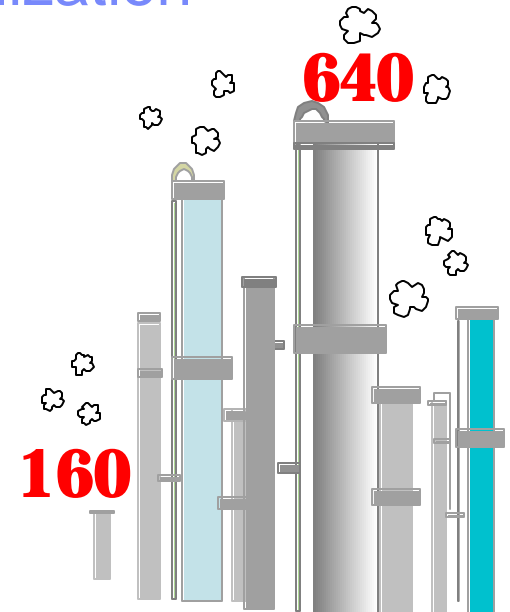

Limits	S/390 G5/G6	z900 Dec 00	z900 Oct 01	zSeries May 02	z990 June 03	z990,z890 Oct 04 OSA-E	z990,z890 Jan 05 OSA-E2
<b>OSD</b>							
Subchannels per stack	3	3	3	3	3	3	3
IP Stacks per port/CHPID on server	15	80	80	80	160	160	640 \$
Subchannels per port	240	240	240	240	480	480	1920 \$
IP stacks per LPAR	15	80	80	80	84	160	640 \$
Devices per LPAR	240	240	240	240	254	480	1920 \$
Maximum Control Units Supported	1	1	1	1	1	16	16

# On/Off Capacity on Demand Information

- On/Off Cod upgrades / downgrades - Resource Link knows the "from" and "to" throttle points (MIPS values) and calculates the billing accordingly
  - ▶ Downgrade will not be considered feature conversions and they will not be listed in the announcement doc
  - ▶ Horizontal On/Off CoD upgrades will be non-disruptive, all others may be disruptive :
    - **disruptive means Operating System IPL but does not require hardware Power-On-Reset.**
  - ▶ Temporary capacity must be greater than permanent capacity
  - ▶ Temporary capacity can not be more than double the capacity of permanent capacity
  - ▶ **Restriction: On/Off CoD can not decrease the number of engines on the machine**

Capacity Setting	O/O CoD Info
110	210, 120
120	210, 310, 130, 220
130	410, 140, 320, 230, 420, 150
140	320, 150, 420, 230, 160, 240
150	160, 240, 330, 340, 430, 250
160	330, 340, 430, 250, 170, 260, 440
170	260, 440, 350, 360, 450, 270
210	310, 220, 410
220	410, 320, 230, 150, 420
230	420, 240, 330, 340, 430, 250
240	330, 340, 430, 250, 260, 440
250	260, 440, 350, 360, 450
260	440, 350, 360, 450, 270, 460
270	460, 370, 470
	Capacity settings in blue have same engine size as from capacity setting

Capacity Setting	O/O CoD Info
310	410, 320
320	420, 330
330	340, 430, 440, 350
340	430, 440, 350, 360
350	360, 450, 460
360	450, 460, 370
370	470
410	420
420	430
430	440, 450
440	450, 460
450	460
460	470
470	N/A
	Capacity settings in blue have same engine size as from capacity setting

# Capacity Back Up

From	To
<b>110</b>	<b>270, 370, 470</b>
<b>120</b>	<b>270, 370, 470</b>
<b>130</b>	<b>270, 370, 470</b>
<b>140</b>	<b>270, 370, 470</b>
<b>150</b>	<b>270, 370, 470</b>
<b>160</b>	<b>270, 370, 470</b>
<b>170</b>	<b>270, 370, 470</b>
<b>210</b>	<b>370, 470</b>
<b>220</b>	<b>370, 470</b>
<b>230</b>	<b>370, 470</b>
<b>240</b>	<b>370, 470</b>
<b>250</b>	<b>370, 470</b>
<b>260</b>	<b>370, 470</b>
<b>270</b>	<b>370, 470</b>

From	To
<b>310</b>	<b>470</b>
<b>320</b>	<b>470</b>
<b>330</b>	<b>470</b>
<b>340</b>	<b>470</b>
<b>350</b>	<b>470</b>
<b>360</b>	<b>470</b>
<b>370</b>	<b>470</b>
<b>410</b>	<b>n/a</b>
<b>420</b>	<b>n/a</b>
<b>430</b>	<b>n/a</b>
<b>440</b>	<b>n/a</b>
<b>450</b>	<b>n/a</b>
<b>460</b>	<b>n/a</b>
<b>470</b>	<b>n/a</b>

# z890/z990 OSA-ICC Single System with Redundancy Configuration

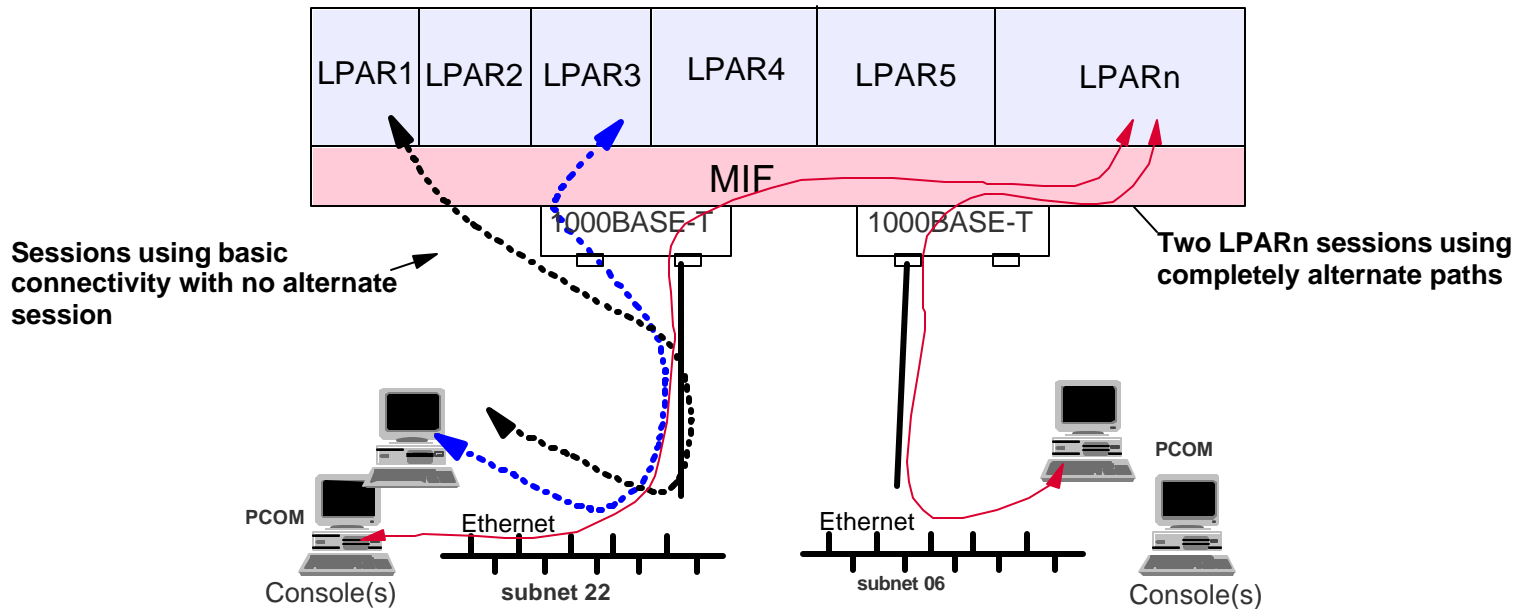

- Up to two hundred forty (240) sessions to multiple Logical Partitions on the CEC
- Session-level redundancy using different paths on ports, LANs, and consoles
  - Different console sessions from different LAN to same Logical Partitions for dual connectivity
  - Manual, disruptive console session switch possible for failed session
  - Individual session cannot be shared between Logical Partitions
  - LAN ports must attach to different subnets
- Loss of one port does not nondisruptively switch sessions to second port on same or different OSA-Express



# SAN



## FICON Express2

- Connectors - LC Duplex (same as FICON Express)
- LX - 9 micron single mode fiber
  - ▶ Maximum unrepeated distance 10 km (6.2 miles)
  - ▶ Maximum repeated distance 100 km (62 miles)
  - ▶ Supports MCP cables to reuse multimode infrastructure
    - Only at 1Gbps, not at 2 Gbps
    - Maximum unrepeated distance up to 550 meters
  - ▶ Receiving port must also be LX
- SX - 50 or 62.5 micron multimode fiber
  - ▶ Maximum unrepeated distance 120 to 500 meters depending on multimode fiber specification
  - ▶ MCP cables not applicable
  - ▶ Maximum repeated distance 100 km (62 miles)
  - ▶ Receiving port must also be SX
- Maximum number of features supported
  - ▶ z990 – 60 features, 20 per cage, 240 channels
    - 48 features, Model A08
  - ▶ z890 – 20 features, 80 channels
    - 16 features, 64 channels on z890 capacity setting 110

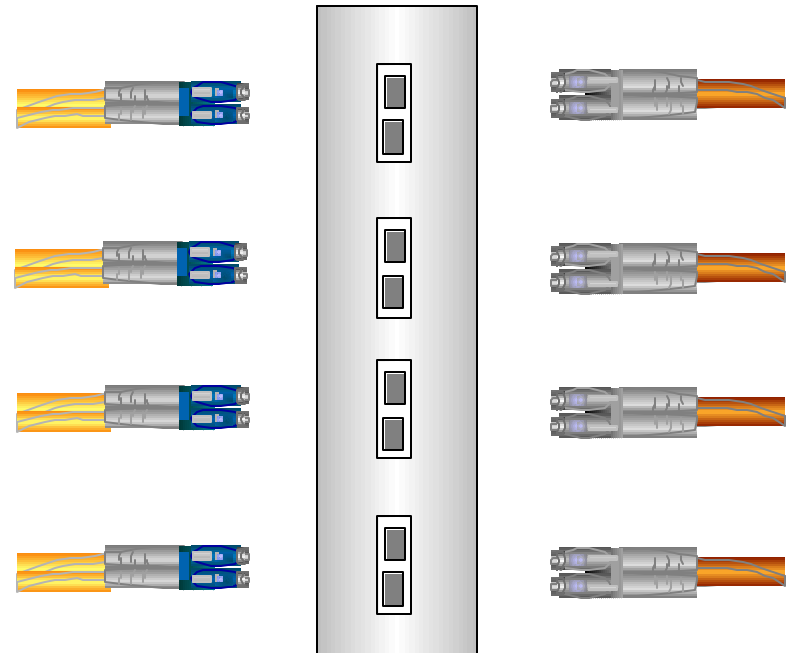

**#3319 – LX** or **#3320 - SX**

**All LX** or **All SX**



## FICON Express2 – minimum software

- FICON Express2 (CHPID Type FC), on z890 and z990 including Channel-To-Channel (CTC), requires at a minimum:
  - ▶ z/OS and z/OS.e 1.3, and later
    - HCD APAR OA09114
    - HCM (optional feature) APAR IR54497
    - For FICON purge path extended: z/OS and z/OS.e 1.4, and later, with PTFs for APAR OA06846 and EREP APAR IR51695.
  - ▶ z/VM 3.1, and 4.3, 4.4, 5.1 and later.
    - HCD APAR VM63610 is required
  - ▶ VSE/ESA 2.6, and later
  - ▶ TPF 4.1 at PUT 16 and later
  - ▶ Linux on zSeries
    - The currently available distributions: SUSE SLES 8 and SLES 9, Red Hat RHEL 3
- FICON Express2 (CHPID Type FCP) on z890 and z990 for support of SCSI disks requires at a minimum (refer to 2084 and 2086 PSP buckets for any required service):
  - ▶ z/VM 5.1 (for z/VM install, IPL, and operation from SCSI disks)
  - ▶ z/VM 4.4, 5.1 and later, for
    - Performance Assist for Adapter Interruptions
    - Performance Assist for V=V Guests
    - Guest IPL from SCSI devices
    - FCP LUN Access Control - APAR VM63328 is required
  - ▶ z/VM 4.3, 4.4, 5.1 and later for Linux as a guest under z/VM.
  - ▶ Linux on zSeries
    - The currently available distributions: SUSE SLES 8 and SLES 9, Red Hat RHEL 3
- For CHPID Mapping (optional), updated CHPID Mapping Tool from Resource Link

# Crypto

# zSeries Cryptographic Technology

- Focus on Secure Sockets Layer (SSL) encryption
- Continue to provide competitive symmetric performance in a security-rich environment
- Provide integration of Crypto features via ICSF
- Focus on required certifications and open standards



Linux 13,000 SSLs/sec\*

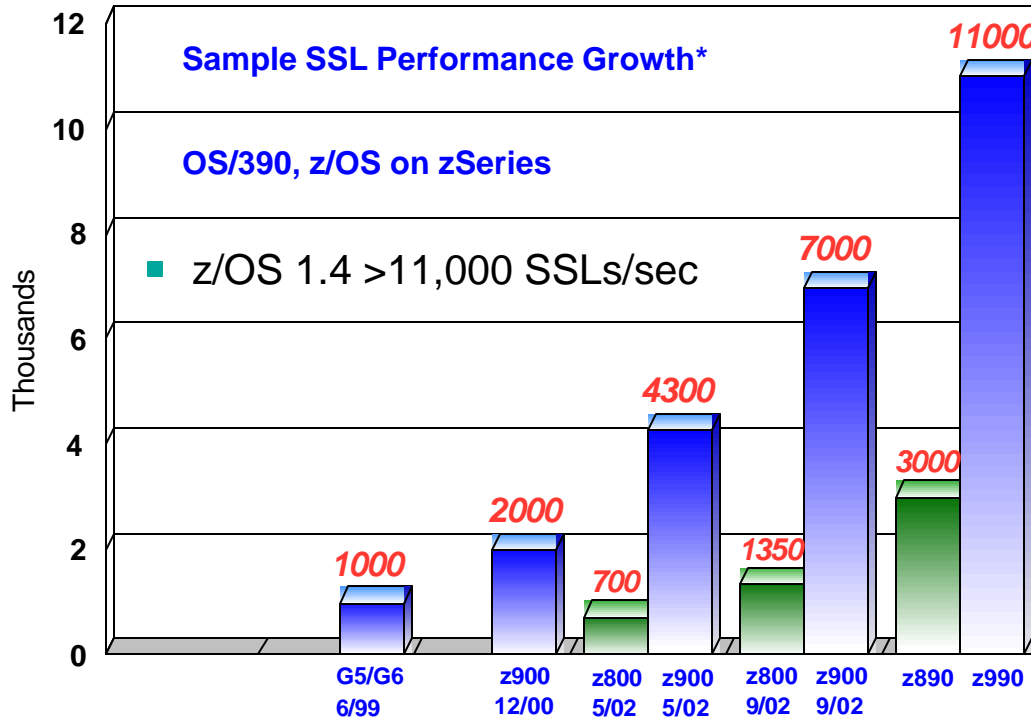

**z990/z890** – Jan.05  
Crypto Express2

**z890** - May, 2004  
PCIXCC/PCICA

**z990** - Sept., 2003  
PCIXCC

**z990** - June, 2003  
CPACF/PCICA

**z900/z800** - Dec, 2000/ May, 2002  
2 Chips on CEC Board - CMOS7s+ PCICC/PCICA (10/01)

**G6** - June, 1999  
2 Chips on Processor MCM - CMOS5x + PCICC (6/99)



**G5** - Sept., 1998  
2 Chips on Processor MCM - CMOS5x + PCICC (6/99)



**G4** - Sept., 1997  
SCMs on Planar Board - CMOS5x



**G3** - June, 1997  
SCMs on Planar Board - CMOS5x



\*These measurements are examples of the maximum transactions/second achieved in a lab environment with no other processing occurring and do not represent actual field measurements. Details available upon request.

## Crypto Express2 Support Requirements

- z890 or z990 hardware LIC support for GA2/4 (Planned January 28, 2005)
- z/OS 1.3 or z/OS.e 1.3 or later with Web Deliverable:
  - ▶ z990 and z890 Enhancements to Cryptographic Support
- z/VM 5.1 or later with service (Planned January 28, 2005)
  - ▶ Dedicated queue support for clear-key and secure-key functions for z/OS guests
  - ▶ Shared and dedicated queue support for clear-key functions for Linux on zSeries guests, with up to 256 dedicated queues
- VSE/ESA 2.7 and IBM TCP/IP for VSE/ESA 1.5
  - ▶ Clear-key functions only
- Linux on zSeries with IBM Open Source code:
  - ▶ Delivered in October 2004 for kernel 2.4
  - ▶ Planned for delivery early in 2005 for kernel 2.6
- See the 2084DEVICE or 2086DEVICE PSP for any additional service.

# Trademarks

**The following are trademarks of the International Business Machines Corporation in the United States and/or other countries.**

AIX*	IBM eServer	Resource Link	z/Architecture
APPN*	IBM logo*	S/390*	z/OS*
e-business logo*	Multiprise*	Sysplex Timer*	z/VM*
Enterprise Storage Server*	MVS	Tivoli*	zSeries*
ESCON*	On demand business logo	TotalStorage*	zSeries Entry License Charge
FICON*	OS/390*	VM/ESA*	
FlashCopy*	PR/SM	VSE/ESA	
GDPS*	pSeries	VTAM*	
HyperSwap	RACF*	WebSphere*	
IBM*	Redbook	xSeries*	

\* Registered trademarks of IBM Corporation

**The following are trademarks or registered trademarks of other companies.**

Intel is a registered trademark of the Intel Corporation in the United States, other countries, or both.

Java and all Java-related trademarks and logos are trademarks of Sun Microsystems, Inc., in the United States and other countries.

Linux is a trademark of Linus Torvalds in the United States, other countries, or both.

UNIX is a registered trademark of The Open Group in the United States and other countries.

Microsoft, Windows and Windows NT are registered trademarks of Microsoft Corporation in the United States, other countries or both.

SET and Secure Electronic Transaction are trademarks owned by SET Secure Electronic Transaction LLC.

\* All other products may be trademarks or registered trademarks of their respective companies.

**Notes:**

Performance is in Internal Throughput Rate (ITR) ratio based on measurements and projections using standard IBM benchmarks in a controlled environment. The actual throughput that any user will experience will vary depending upon considerations such as the amount of multiprogramming in the user's job stream, the I/O configuration, the storage configuration, and the workload processed. Therefore, no assurance can be given that an individual user will achieve throughput improvements equivalent to the performance ratios stated here.

IBM hardware products are manufactured from new parts, or new and serviceable used parts. Regardless, our warranty terms apply.

All customer examples cited or described in this presentation are presented as illustrations of the manner in which some customers have used IBM products and the results they may have achieved. Actual environmental costs and performance characteristics will vary depending on individual customer configurations and conditions.

This publication was produced in the United States. IBM may not offer the products, services or features discussed in this document in other countries, and the information may be subject to change without notice. Consult your local IBM business contact for information on the product or services available in your area.

All statements regarding IBM's future direction and intent are subject to change or withdrawal without notice, and represent goals and objectives only.

Information about non-IBM products is obtained from the manufacturers of those products or their published announcements. IBM has not tested those products and cannot confirm the performance, compatibility, or any other claims related to non-IBM products. Questions on the capabilities of non-IBM products should be addressed to the suppliers of those products.

Prices subject to change without notice. Contact your IBM representative or Business Partner for the most current pricing in your geography.

# DS6000 Highlights

***ESS reliability and host attachment features now available in an incredibly small, modular, affordable package***

## ■ DS6000

- ▶ 3U package for controllers and disk expansion units
- ▶ Open systems and mainframe support
- ▶ Advanced functions interoperate with DS8000, ESS
- ▶ High storage density footprint
  - 16 drives per 3U package, including controller
- ▶ Up to 13 expansion units
  - Scalable to 224 Disk Drives; 67.2TB

## ■ Differentiators

- ▶ zSeries and iSeries native attachment
  - Including Parallel Access Volumes support
- ▶ Same advanced software features as DS8000, ESS 800, ESS 750
- ▶ High availability features not generally found in midrange storage products





## Introducing IBM TotalStorage DS8000



- **Setting a “New Standard” in Cost Effectiveness**
  - ▶ **Balanced Performance** – Up to 6X ESS Model 800
  - ▶ **Model to Model upgradeability** – Up to 192TB
    - (designed for > 1PB)
  - ▶ **Integrated Solution Capability** – Storage System LPARs
  - ▶ **Flexibility** – Dramatic addressing enhancements
  - ▶ **Extendability** – Designed to add/adapt new technologies
  - ▶ **Storage Management** – All New Management Tools
  - ▶ **Availability** – Designed for 24X7 environments
  - ▶ **Resiliency** – Industry Leading Copy and Mirroring Capability
  - ▶ **Long Term Cost** – Four Year Warranty
  
- **Delivered through**
  - ▶ Server/Storage Integration – POWER5™ Technology
  - ▶ Exploitation of IBM Virtualization Engine™ Technology
  - ▶ Innovation by leveraging IBM technology leadership
  - ▶ Extension of a proven microcode base to offer stability but allow exploitation of new technologies
  - ▶ Timely integration of new technologies

# Trademarks

The following are trademarks of the International Business Machines Corporation in the United States and/or other countries.

AIX*	FlashCopy*	RACF*
CICS*	HiperSockets	S/390*
DB2*	IBM*	Tivoli*
DB2 Universal Database	IBM eServer	Tivoli Storage Manager
DFSMSrmm	IBM logo*	TotalStorage*
e-business logo*	IMS	VSE/ESA
e-business on demand	iSeries	WebSphere*
ECKD	Lotus*	z/Architecture
Enterprise Storage Server*	OS/390*	z/OS*
ESCON*	Parallel Sysplex*	z/VM*
FICON	Performance Toolkit for VM	zSeries*
FICON Express	PR/SM	zSeries Entry License Charge

\* Registered trademarks of IBM Corporation

The following are trademarks or registered trademarks of other companies.

Intel is a registered trademark of the Intel Corporation in the United States, other countries or both.

Java and all Java-related trademarks and logos are trademarks of Sun Microsystems, Inc., in the United States and other countries

UNIX is a registered trademark of The Open Group in the United States and other countries.

Microsoft, Windows and Windows NT are registered trademarks of Microsoft Corporation in the United States, other countries, or both.

\* All other products may be trademarks or registered trademarks of their respective companies.

## Notes:

Performance is in Internal Throughput Rate (ITR) ratio based on measurements and projections using standard IBM benchmarks in a controlled environment. The actual throughput that any user will experience will vary depending upon considerations such as the amount of multiprogramming in the user's job stream, the I/O configuration, the storage configuration, and the workload processed. Therefore, no assurance can be given that an individual user will achieve throughput improvements equivalent to the performance ratios stated here.

IBM hardware products are manufactured from new parts, or new and serviceable used parts. Regardless, our warranty terms apply.

All customer examples cited or described in this presentation are presented as illustrations of the manner in which some customers have used IBM products and the results they may have achieved. Actual environmental costs and performance characteristics will vary depending on individual customer configurations and conditions.

This publication was produced in the United States. IBM may not offer the products, services or features discussed in this document in other countries, and the information may be subject to change without notice. Consult your local IBM business contact for information on the product or services available in your area.

All statements regarding IBM's future direction and intent are subject to change or withdrawal without notice, and represent goals and objectives only.

Information about non-IBM products is obtained from the manufacturers of those products or their published announcements. IBM has not tested those products and cannot confirm the performance, compatibility, or any other claims related to non-IBM products. Questions on the capabilities of non-IBM products should be addressed to the suppliers of those products.

Prices subject to change without notice. Contact your IBM representative or Business Partner for the most current pricing in your geography.