



IBM zSeries 890

Bringing You Up To Date:
A New zSeries is here!
(IBM eServer zSeries 890)

Mike Augustine
zSeries Offering Manager
maugust@us.ibm.com



Trademarks

The following are trademarks of the International Business Machines Corporation in the United States and/or other countries.

AIX*	FlashCopy*	Resource Link
CICS*	HiperSockets	S/390*
DB2*	IBM*	Tivoli*
DB2 Universal Database	IBM eServer	Tivoli Storage Manager
DFSMSrmm	IBM logo*	TotalStorage*
e-business logo*	IMS	VSE/ESA
e-business on demand	iSeries	WebSphere*
ECKD	Lotus*	z/Architecture
Enterprise Storage Server*	Multiprise	z/OS*
ESCON*	OS/390*	z/VM*
FICON	Parallel Sysplex*	z/VSE
FICON Express	Performance Toolkit for VM	zSeries*
	PR/SM	zSeries Entry License Charge

* Registered trademarks of IBM Corporation

The following are trademarks or registered trademarks of other companies.

Intel is a registered trademark of the Intel Corporation in the United States, other countries or both.

Java and all Java-related trademarks and logos are trademarks of Sun Microsystems, Inc., in the United States and other countries

UNIX is a registered trademark of The Open Group in the United States and other countries.

Microsoft, Windows and Windows NT are registered trademarks of Microsoft Corporation in the United States, other countries, or both.

* All other products may be trademarks or registered trademarks of their respective companies.

Notes:

Performance is in Internal Throughput Rate (ITR) ratio based on measurements and projections using standard IBM benchmarks in a controlled environment. The actual throughput that any user will experience will vary depending upon considerations such as the amount of multiprogramming in the user's job stream, the I/O configuration, the storage configuration, and the workload processed. Therefore, no assurance can be given that an individual user will achieve throughput improvements equivalent to the performance ratios stated here.

IBM hardware products are manufactured from new parts, or new and serviceable used parts. Regardless, our warranty terms apply.

All customer examples cited or described in this presentation are presented as illustrations of the manner in which some customers have used IBM products and the results they may have achieved. Actual environmental costs and performance characteristics will vary depending on individual customer configurations and conditions.

This publication was produced in the United States. IBM may not offer the products, services or features discussed in this document in other countries, and the information may be subject to change without notice. Consult your local IBM business contact for information on the product or services available in your area.

All statements regarding IBM's future direction and intent are subject to change or withdrawal without notice, and represent goals and objectives only.

Information about non-IBM products is obtained from the manufacturers of those products or their published announcements. IBM has not tested those products and cannot confirm the performance, compatibility, or any other claims related to non-IBM products. Questions on the capabilities of non-IBM products should be addressed to the suppliers of those products.

Prices subject to change without notice. Contact your IBM representative or Business Partner for the most current pricing in your geography.

Terminology

- ATM - Asynchronous Transfer Mode
- CBP - Coupling Facility Peer Channel (copper)
- CBU - Capacity Backup
- CBY - ESCON Converter Channel (byte mode)
- CEC - Central Electronics Complex
- CF - Coupling Facility
- CFCC - Coupling Facility Control Code
- CFP - Coupling Facility Peer Channel (fiber)
- CFR - Coupling Facility Receiver Channel
- CFS - Coupling Facility Sender Channel
- CHPID - Channel Path Identifier
- CMOS - Complementary metal oxide semiconductor
- CNC - ESCON Channel
- CP - Central Processor
- CTC - Channel to channel

Terminology

- CU - Control Unit
- ESCON - Enterprise Systems CONNecTion
- FCP - Fibre Channel Protocol
- FDDI - Fiber Distributed Data Interface
- FENET - Fast Ethernet (100 bps)
- FICON - Fibre CONNecTion
- FIPS - Federal Information Processing Standard (USA)
- GbE - Gigabit Ethernet
- GUI - Graphical User Interface
- HCD - Hardware Configuration Definition
- IC - Internal Coupling
- ICB - Integrated Cluster Bus
- ICF - Internal Coupling Facility
- ICP - Internal Coupling Peer Channel
- ICSF - Integrated Cryptographic Service Facility

Terminology

- IFL - Integrated Facility for Linux
- IGS - IBM Global Services
- ISC - InterSystem Coupling
- LAN - Local Area Network
- LIC - Licensed Internal Code
- LICCC - Licensed Internal Code Configuration Code
- LPAR - Logically Partitioned mode
- LSPR - Large Systems Performance Reference
- LX - Long Wave Fiber (single mode fiber)
- MCM - Multiple Chip Module
- MCP - Mode Conditioning Patch
- MES - Miscellaneous Equipment Specification
- MPCIPA - Multipath Channel with IP Assist
- MTU - Maximum Transmission Unit
- OAT - OSA Address Table

Terminology

- OSA - Open Systems Adapter
- OSA/SF - OSA/Support Facility
- PCHID - Physical Channel Identifier
- PCI - Peripheral Component Interconnect
- PU - Physical Unit
- QDIO - Queued Direct Input and Output
- RPQ - Request for Price Quotation
- SAP - System Assist Processor
- SCSI - Small Computer System Interface
- SSL - Secure Sockets Layer
- STI - Self Timed Interconnect
- SX - Short Wave Fiber (multimode fiber)
- TDES - Triple Data Encryption Standard
- TR - Token Ring
- WAN - Wide Area Network

Agenda

- What's New Since We Last Met
- Introduction
- Under the Covers and I/O
- Software Support and Pricing
- Migration Planning
- Reference Material

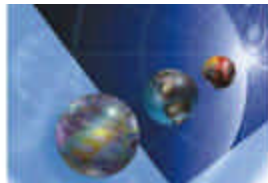

What's Since We Last Met?

- **June 30, 2003**
 - End of Service (EOS): 9021 and 9121
- **December 31, 2003**
 - EOS: 9221, 9672-Rx1 End of Service
 - WDFM: Multiprise 3000
- **December 31, 2004**
 - EOS: 3370, 3380, 3880, 3274, 9662, 9672-Rx2/3, US letter # 903-118)
- **April 7, 2004**
 - Announced z890, ESS 750, z/VSE 3.1 Preview, z/VM 5.1

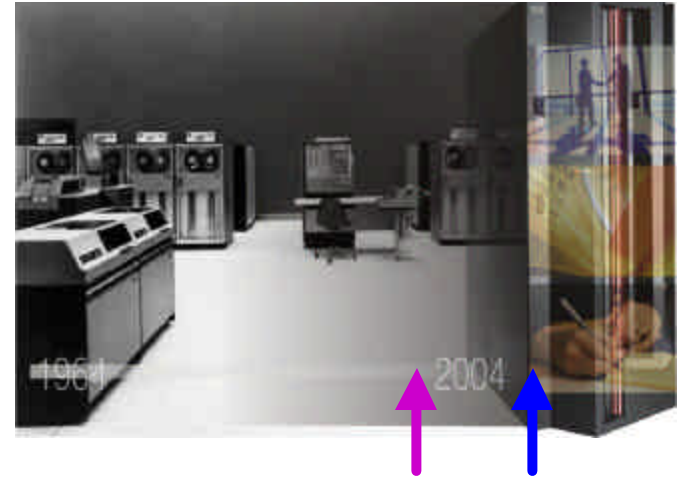

Introduction

Introducing the Newest Member of the zSeries Family

- The IBM eServer zSeries 990 was announced in May 2003
- IBM announced our Mainframe Charter framework in August 2003
- In October 2003 we announced Infrastructure Simplification
- The z890 announcement advances the innovation of the zSeries family and brings this value to be delivered to a wider audience

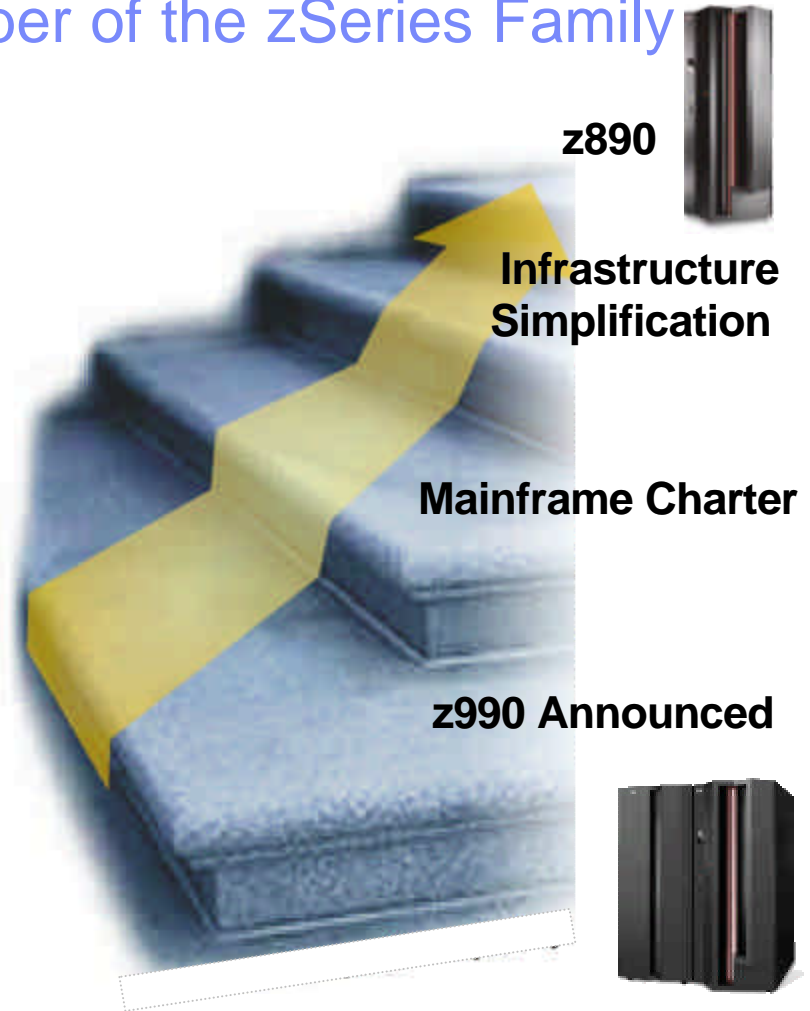

z890 Highlights



- **New IBM eServer zSeries 890 delivered with price/performance and technology-driven business value**
 - One model with 28 capacity settings provide flexibility and granular growth
 - Specially designated workload processors available for Coupling, Linux and Java™ workloads
 - Lower cost design points and granular capacity levels improve pricing flexibility
 - Entry point at 4 MSUs and 28 capacity settings can help you to better manage software costs
 - Up to 2X I/O throughput vs. IBM eServer zSeries 800 (z800)
 - New zSeries Application Assist Processor (zAAP) at same price as Integrated Facility for Linux and no additional capacity-based IBM software license charges
 - Up to 140% price/performance improvement for Linux IFLs over z800
 - Up to 10% price/performance improvement on Maintenance over z800
 - Entry Workload License Charge (EWLC) and EWLC Tiered Price Structure introduced for flat charged products
 - New cost effective z/VM V5.1 with engine-based pricing
 - On/Off Capacity on Demand
 - OSA-Integrated Console Controller
 - New and Improved Networking and Connectivity Options

z890 on demand – A new way to think about granularity

- Single Machine: 2086 and a single Model: A04
- A dramatic new way to consider upgrading
- One MCM with 5 Processor Units (PUs)
 - Four PUs available for characterization
 - CPs, Integrated Facility for Linux (IFLs), Internal Coupling Facility (ICFs), or zSeries Application Assist Processor (zAAPs)
 - One PU standard as an SAP
- Standard CPs –
 - Four full capacity processors **each** with 7 capacity settings
 - Entry point is approximately 32% less capacity than z800-0E1 and largest capacity setting is up to 123% more than z800-004
 - ▶ Upgrades can be horizontal, vertical, diagonal, to best fit your needs *

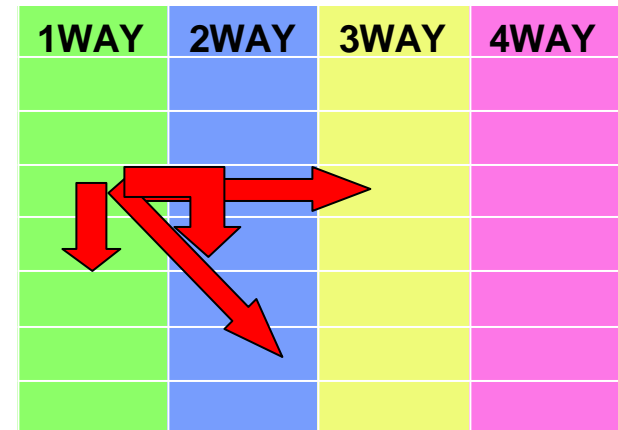

* Note: No mixing of standard CP capacity sizes in multi-engine machines, zAAPs cannot outnumber standard CPs in any machine.

**Think of the possibilities:
Define the processor the way your business requires !**

z890 PU Characterization

■ Processing Units (PUs) types that can be enabled / assigned include:

▶ Central Processors (CPs)

- Provides processing capacity for z/Architecture™ and ESA/390 instruction sets
- Runs VSE/ESA™, z/VM, z/OS, TPF and Linux under z/VM

▶ Integrated Facility for Linux (IFL)

- Provides additional processing capacity for Linux workloads
- Runs Linux or Linux under z/VM Version 4 and Version 5

▶ IBM eServer zSeries Application Assist Processor (zAAP)

- Under z/OS, the Java Virtual Machine (JVM) assists with Java processing to a zAAP

▶ System Assisted Processors (SAPs)

- SAPs manages the start and ending of I/O operations for all logical partitions and all attached I/O

▶ Internal Coupling Facility (ICF)

- Provides additional processing capacity for the execution of the Coupling Facility Control Code (CFCC) in a CF LPAR

z890 – Overview

- **Memory**
 - 8 GB Standard
 - 8 GB increments to 32 GB (8, 16, 24, 32 GB)
 - One concurrent memory upgrade path (24– 32 GB)
- **Support for up to 30 LPARS**
 - Except for Capacity setting 110 which supports 15 LPARS
- **Cryptographic coprocessor optional**
- **New packaging for I/O with Two Logical Channel SubSystems (LCSS)**
 - 28 slot I/O cage supports up to 420 ESCON® channels
 - z890 110 capacity setting only has 16 I/O slots available
 - OSA-Express – Gigabit Ethernet, 1000BASE-T Ethernet, Token-Ring, Integrated Console Controller
 - Open FCP
 - Quadrupled HiperSockets™ support over z800 to 16
- **Single frame**
 - One and three phase options
 - Raised floor recommended but not required
 - Internal Battery Option



z890 Positioning

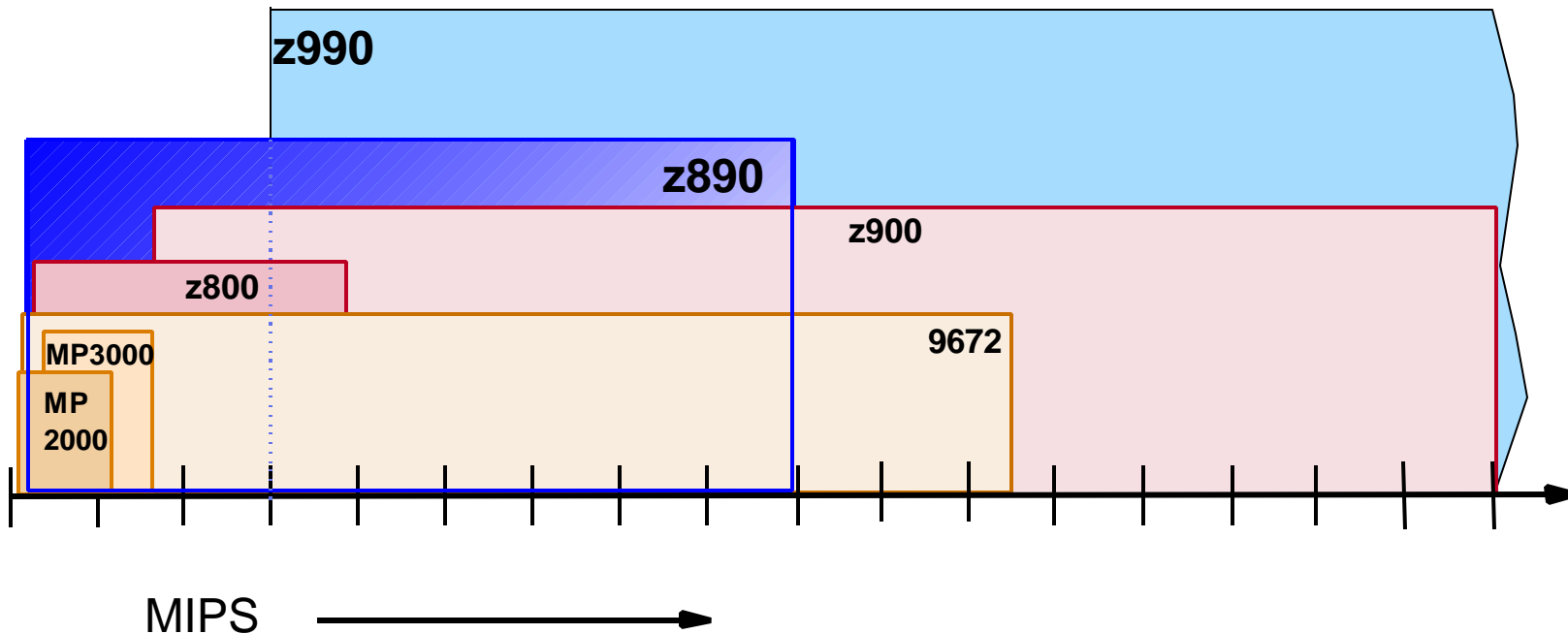

z890 Performance Comparison (28 levels of capacity)

z890 entry point is 32 % less capacity than the smallest z800

z890 Uni is 1.98 - 2.09 times the z800 Uni

z890 4-way is 2.19 - 2.28 times the z800 4-way

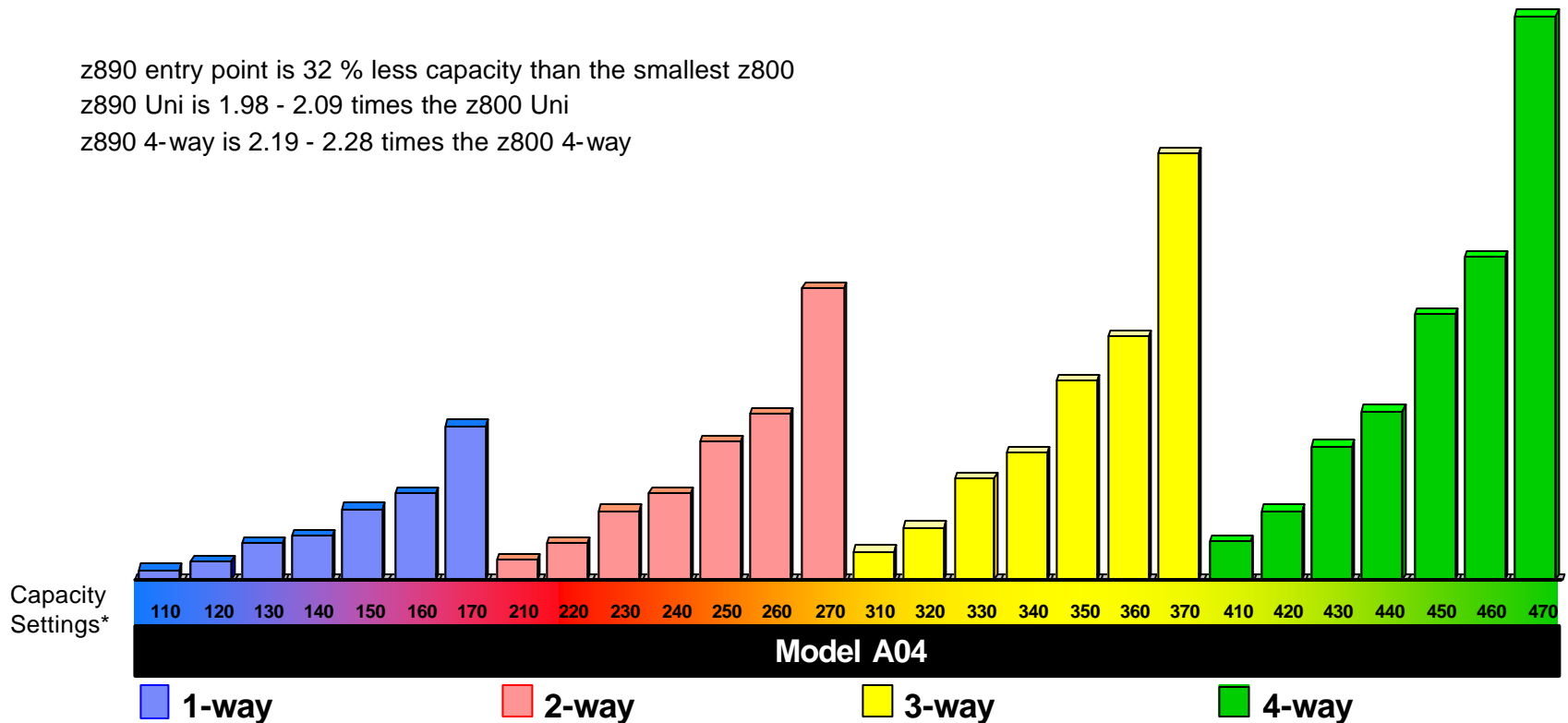

Note: For MSU values (4 – 208), refer to: ibm.com/servers/eserver/zseries/library/swpriceinfo/

* Capacity setting refers to number of installed CPs and the capacity. Reported by STSI instruction.

z890 Capacity Setting and MSUs

1-way		2-way		3-way		4-way	
Capacity Setting	MSUs	Capacity Setting	MSUs	Capacity Setting	MSUs	Capacity Setting	MSUs
110	4	210	8	310	11	410	15
120	7	220	13	320	20	420	26
130	13	230	26	330	38	430	49
140	17	240	32	340	47	440	62
150	26	250	50	350	74	450	97
160	32	260	62	360	91	460	119
170 - Full 1-way	56	270 - Full 2-way	107	370 - Full 3-way	158	470 - Full 4-way	208

z890 Upgrades/Downgrades

(any to any, available July 30, 2004)

1-Way		2-Way		3-Way		4-Way	
Feature Code	Capacity Setting	Feature Code	Capacity Setting	Feature Code	Capacity Setting	Feature Code	Capacity Setting
6110	110	6210	210	6310	310	6410	410
6120	120	6220	220	6320	320	6420	420
6130	130	6230	230	6330	330	6430	430
6140	140	6240	240	6340	340	6440	440
6150	150	6250	250	6350	350	6450	450
6160	160	6260	260	6360	360	6460	460
6170	170	6270	270	6370	370	6470	470

- Any horizontal upgrade is concurrent (i.e. 6140 to 6240)
- Others (vertical or diagonal) require an IPL (except z/VM)
- 6070 = zero CP's (ICF's or IFL's only)

- **Capacity Setting "xy"** for software pricing
 - ▶ Preceded by a 6 (feature code) - 6xy0
 - ▶ X indicates number of CPs (6**2**70)
 - ▶ Y indicates capacity setting (62**7**0)

z890 Upgrade Options

- **On/Off Capacity on Demand - Temporary upgrade (FC9898 & FC9896)**
 - Nondisruptive* temporary addition of CPs, IFLs, ICFs and zAAPs
 - "Right to use" feature - Orderable as MES or with new build to initiate contract and administrative setup
 - Customer orders and installs upgrade via Resource Link and IBM RSF
 - Nondisruptive removal when capacity is no longer wanted
- **CIU – Customer Initiated Upgrade - Express - Permanent upgrade (FC9898)**
 - Customer capability to order and install permanent upgrade
 - Any LICCC enabled engine
 - Memory increment from 24GB to 32GB
 - CIU feature - MES ordered to initiate contract and administrative setup
 - Customer orders and installs upgrade via Resource Link and IBM RSF
- **CBU – Capacity Backup - Temporary emergency capacity upgrade****
 - Nondisruptive temporary addition of CPs ONLY in an emergency situation
 - Not applicable to zAAPs, IFL's, ICF's
 - CBU contract required to order CBU features and CBU LIC CC
 - Customer activates upgrade for test or temporary emergency
 - Nondisruptive downgrade after test or recovery completed

* For z890 CPs only for horizontal upgrade. OS may require IPL for vertical or diagonal upgrades.

** For z890 - To FULL size engines only

On/Off Capacity on Demand Information

- On/Off CoD upgrades / downgrades- Resource Link knows the "from" and "to" throttle points (MIPS values) and calculates the billing accordingly

- Downgrade will not be considered feature conversions and they will not be listed in the announcement doc
- Horizontal On/Off CoD upgrades will be non-disruptive, all others are disruptive:

- **disruptive means Operating System IPL but does not require hardware Power-On-Reset.**

- Temporary capacity must be greater than permanent capacity
- Temporary capacity can not be more than double the capacity of permanent capacity
- Restriction: On/Off CoD can not decrease the number of engines on the machine

Capacity Setting	O/O CoD Info
110	210, 120
120	210, 310, 130, 220
130	410, 140, 320, 230, 420, 150
140	320, 150, 420, 230, 160, 240
150	160, 240, 330, 340, 430, 250
160	330, 340, 430, 250, 170, 260, 440
170	260, 440, 350, 360, 450, 270
210	310, 220, 410
220	410, 320, 230, 150, 420
230	420, 240, 330, 340, 430, 250
240	330, 340, 430, 250, 260, 440
250	260, 440, 350, 360, 450
260	440, 350, 360, 450, 270, 460
270	460, 370, 470
	Capacity settings in blue have same engine size as from capacity setting

Capacity Setting	O/O CoD Info
310	410, 320
320	420, 330
330	340, 430, 440, 350
340	430, 440, 350, 360
350	360, 450, 460
360	450, 460, 370
370	470
410	420
420	430
430	440, 450
440	450, 460
450	460
460	470
470	N/A
	Capacity settings in blue have same engine size as from capacity setting

z890 – Capacity Setting 110 Overview

- Built on same zSeries technology – but available in our smallest capacity setting
- Full zSeries Availability support
- Memory
 - 8 GB Standard, with 8 GB increments to 32 GB (8, 16, 24, 32 GB)
- Specially-designated Workload Processors for Coupling, Java and Linux workloads
- Single frame
 - One and three-phase options
 - Raised floor recommended but not required
 - Internal Battery Option
- ❖ New packaging for I/O with Two Logical Channel SubSystems (LCSS)
 - I/O cage supports up to 240 ESCON channels and/or 32 FICON channels (16 I/O slot max)
 - 24 OSA-Express ports available – Gigabit Ethernet, 1000BASE-T Ethernet, Token-Ring, Integrated Console Controller
 - Open FCP
 - HiperSockets support for 16 internal LANS
- ❖ Support for up to 15 LPARS
- ❖ zSeries Entry License Charge™ (zELC) pricing on Capacity Setting 110 only

Channel/Slot Maximums

Channel Type	z890 FC6110	z890	z800	z990*
LPARs	15	30	15	30
I/O Slots	16	28	16	84
LCSS	2	2	1	4
Channels	256	512	256	1024
ESCON	240	420	240	1024
FICON Express	32	40	32	120
OSA-Express	24	40	24	48
HiperSockets	16	16	4	16
ISC-3	48	48	24	48
ICB-3	16	16	5 (6 on OCF)	16
ICB-4	8	8	0	16
IC	32	32	32	32
OSA ATM 155	0	0	24	0
Crypto - PCICC	0	0	16 engines	0
Crypto - PCICA	4 engines	4 engines	12 engines	12 engines
Crypto - PCIXCC	4	4	0	4



Capacity Setting 110

* Model B16 and higher

Under the Covers and I/O

z890 - Under the Covers

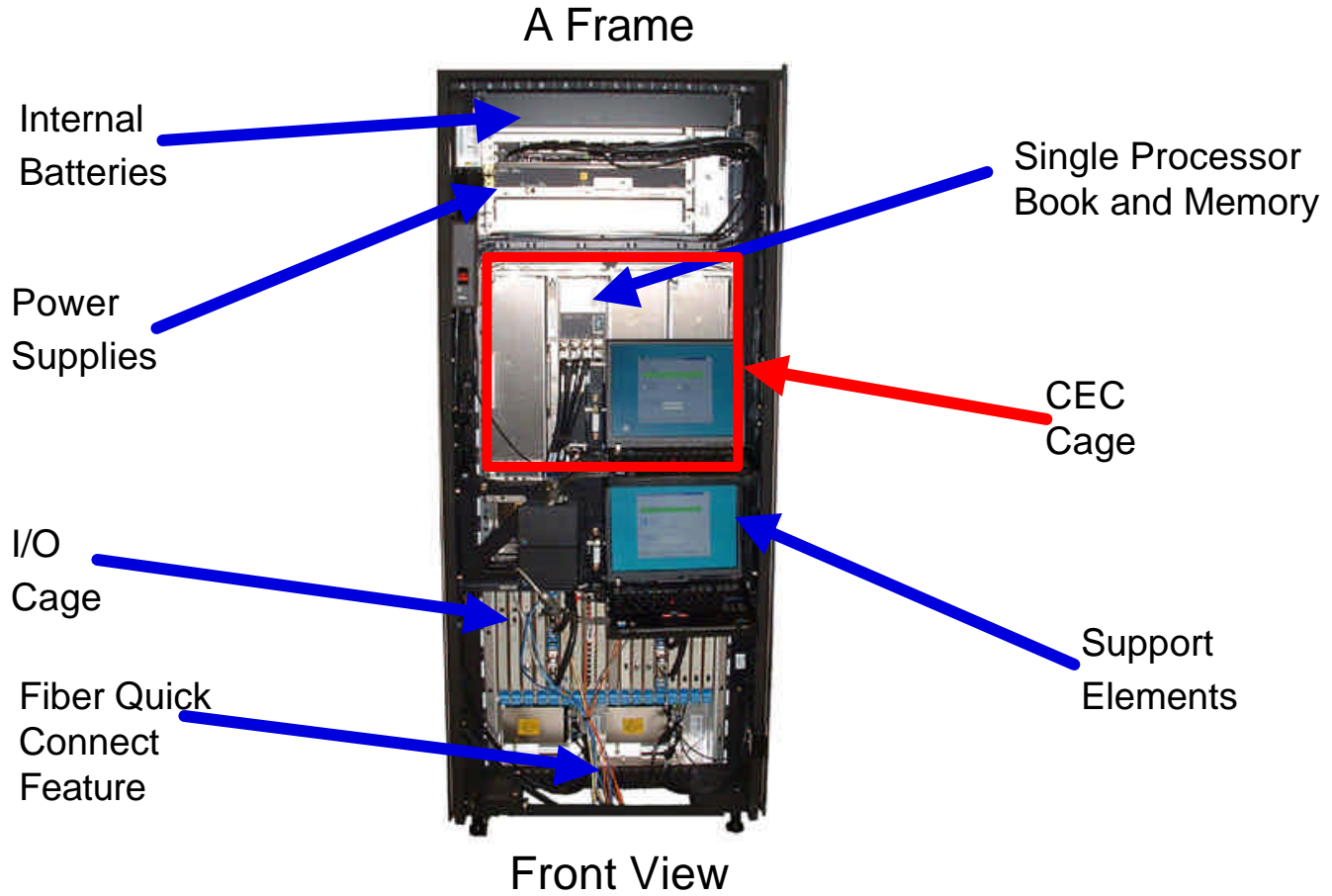

z890 Logical Channel SubSystems and Support for > 15 Logical Partitions

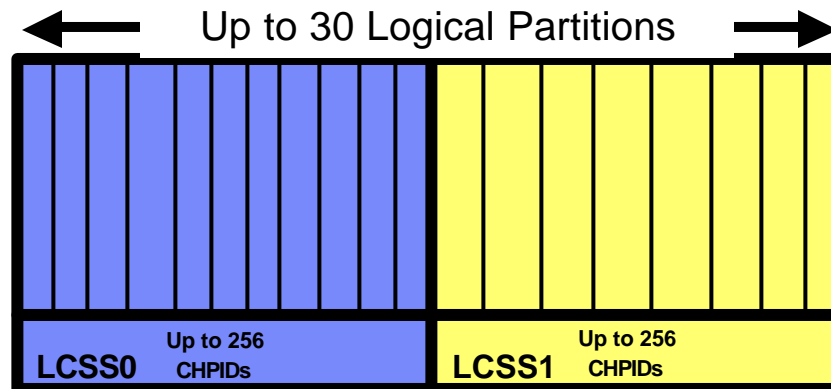

- 1 or 2 Logical Channel SubSystems (LCSSs)
- Up to 15 Logical Partitions per LCSS
 - ▶ not available on capacity setting 110
- A Logical Partition uses I/O from a single LCSS
- Channel 'spanning' across 2 LCSS

256 Channel limitation per OS image remains unchanged!

CHPID Mapping Tool

- **Ease of use tool to simplify mapping of CHPIDs to PCHIDs**
- **Availability and manual mapping functions**
- **Tool used with HCD/HCM for assigning PCHIDs to CHPIDs**
 - Requires changes to current HCD process
- **Supports channel MESs**
 - CHPID to PCHID mapping contained in IOCP
- **"Mandatory"**
- **Customer Responsibility!**

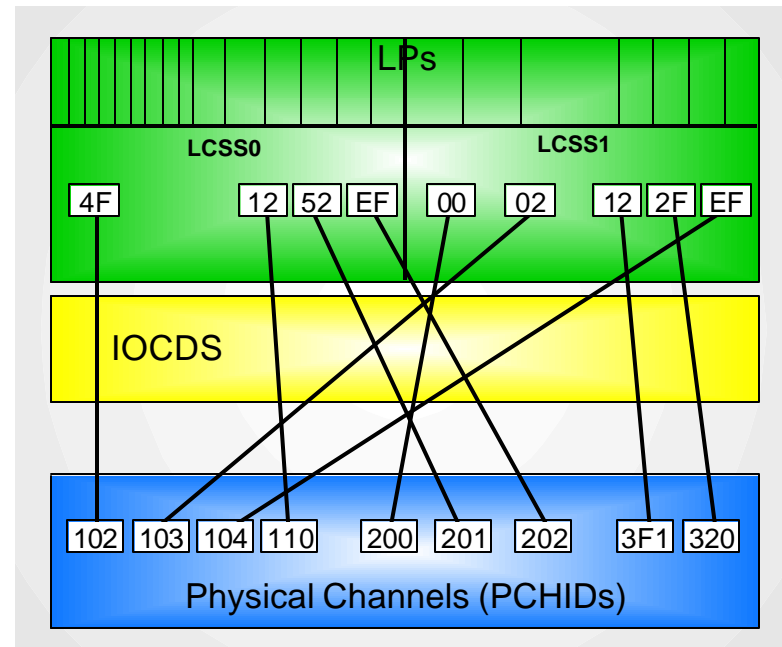

www.ibm.com/servers/resourceink

ESS Model 750 – Entry Capacity & Price

- An exciting new alternative to address today's "on demand" storage requirements, designed to offer lower TCO than ESS Model 800
- An excellent solution for modest physical disk capacity (up to 4.6 TB) environments that demand the highest availability and functionality, at entry prices
- Designed to meet the high availability requirements of mainframe and open environments
- Most of the same features and advanced function options offered by IBM TotalStorage® Enterprise Storage Server™ (ESS) Model 800 and supports the same large array of operating systems
- Comes standard with many popular ESS Management options and three year warranty to help provide outstanding TCO

Enterprise Disk Storage Complements
zSeries 890 and Open Systems Servers



zSeries 16-port Enterprise Systems Connection (ESCON) card

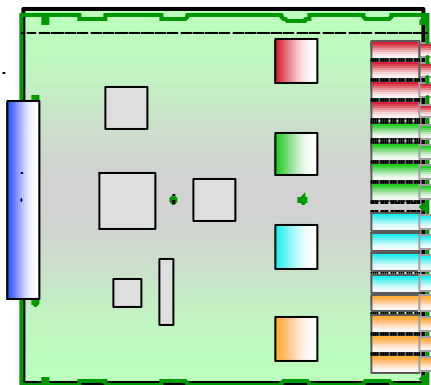

MTRJ MM

High density package

- ▶ 16-port feature (FC 2323)
 - Ordering increment, four channels (FC 2324)
 - eConfig selects feature quantity
- ▶ At least one spare channel port per card
- ▶ Active ports - LICCC controlled
 - Active channels balanced across all installed features
- ▶ After the first pair, ESCON features are installed in increments of one

Small form factor MTRJ connector

- ▶ 62.5 micron multimode fiber
- ▶ Conversion kit available from IGS for existing ESCON duplex fiber infrastructure

Fiber Quick Connect (FQC)

- ▶ Factory installation of direct-attach fiber harness
 - Supports all installed ESCON features in all installed I/O cages
 - New builds or conversions to z890
 - Enables attachment to fiber trunking

Number of Channels	Cards
4 - 28	2
32 - 44	3
48 - 60	4
...	...
244 - 268	18
...	...
420	28

Capacity Setting 110

Number of Channels	Cards
4 - 28	2
32 - 44	3
48 - 60	4
...	...
228 - 240	16

zSeries Fibre Connection (FICON) Express Card

- **FICON Express LX (long wavelength) - FC 2319**
 - ▶ Supports 9 micron single mode fiber
- **FICON Express SX (short wavelength) - FC 2320**
 - ▶ Can carry forward from z800
 - ▶ Supports 50 or 62.5 micron multimode fiber
 - ▶ Not Compatible with FICON Bridge (FICON Bridge is LX only)
- **Port capacity**
 - ▶ Maximum of 20 features / 40 ports on z890
 - ▶ All ports on each card identically configured (LX or SX)
- **Modes of Operation: applicable to each port**
 - ▶ FCV (FICON Bridge Converted); applicable to LX feature only
 - FICON to FICON Bridge on ESCON Director Model 5
 - ▶ FC (Fibre Channel)
 - Native FICON
 - FICON Channel-To-Channel
 - ▶ FCP (Fibre Channel Protocol)
 - Support of SCSI devices in Linux environments
- **Bandwidth**
 - ▶ 1 or 2 Gbps link data rate
 - Auto-negotiated with device
 - ▶ Maximum bandwidth potential = 170 MBps

FICON Express

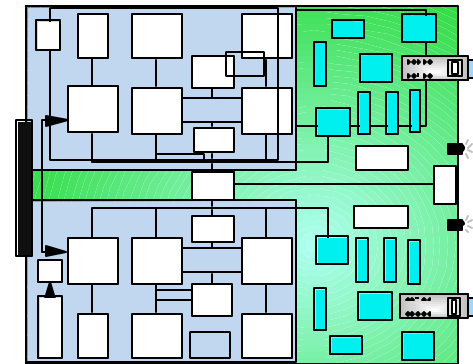

zSeries - FICON Express advantages over ESCON

- **FICON Express provides up to a 10X improvement in distance solutions supporting disaster recovery applications**
 - ESCON data drop starts at 9 km
 - FICON Express has negligible data drop up to 100 km
 - **Note: RPQ 8P2263 supports for FICON link distance greater than**
 - 10 Km and up to 20 Km for 1 Gb. unrepeated distance
 - 10 Km and up to 12 Km for 2 Gb. unrepeated distance
- **FICON Express provides up to 10X the effective bandwidth per channel**
 - Maximum ESCON rate is 17 MB/s
 - Maximum FICON Express rate is 170 MB/s for either all reads or all writes and greater than 170 MB/sec for a combination of large sequential read and write operations
- **FICON Express supports up to 6X the I/O operations per second**
 - ESCON provides up to 1200 4K IOs/sec
 - FICON Express provides up to 7200 4K IOs/sec
- **FICON Express provides 16X as many devices**
 - ESCON supports 1K unit addresses per channel
 - FICON Express supports 16K unit addresses per channel
- **FICON Express uses fiber more efficiently**
 - ESCON has half duplex transfer data
 - FICON Express has **full duplex data transfer**
- **FICON Express provides relief for "channel constrained" systems**
 - 350% to 400% current ESCON channel utilization can be consolidated onto a single FICON Express channel for reasonable response times in a production workload environment

zSeries - Additional benefits of FICON Express

- **Improve Performance**

- ▶ Faster backup/ recovery times, shorter batch windows, faster data access for large data queries

- **Channel consolidation**

- ▶ Fewer channels, CHPIDs, Director ports, fiber optic cabling

- **Advantages with FICON CTC**

- Greater bandwidth

- **Linux for zSeries FCP**

- ▶ zSeries support of Linux SCSI IPL

- **FICON and FCP intermix on FICON Directors**

zSeries SCSI IPL Feature

- **SCSI IPL is available as an optional, no-charge feature (FC 9904) for all zSeries**
 - Ficon Express channel is required
- **FCP without SCSI IPL Feature**
 - Allows Linux data to be stored on SCSI or FCP device
 - Linux IPL to SCSI disk results in an error, an ECKD device is required
- **FCP with SCSI IPL Feature**
 - Allows Linux data to be stored on SCSI or FCP device
 - Allows Linux to install and load (IPL) on SCSI or FCP disk
 - IPL from both LPAR and/or z/VM guests
 - For z/VM guest IPL, z/VM 4.4 is required
 - For z/VM native install and IPL, z/VM V5.1 is required
- **Linux LPARs can be started and run completely from SCSI or FCP disk**
 - z/VM continues to require ESCON or FICON attached disk or tape for its own IPL, storing of guest dumps, and other functions
 - UNTIL z/VM 5.1 (available 09/24/2004)
- Standalone dump program can be loaded SCSI or FCP disk in order to dump the contents of a logical partition, and the dump data can be written to this same disk.

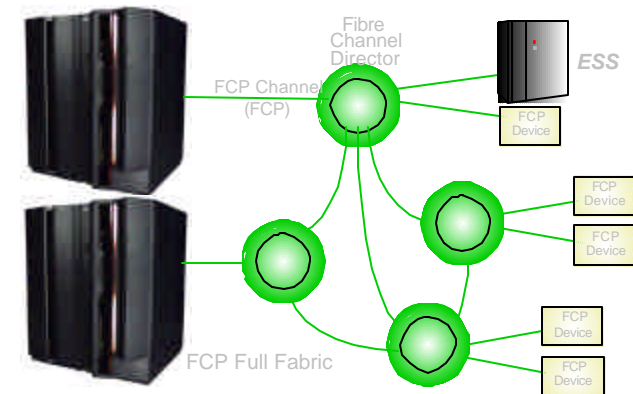

z890 OSA-Express Family of Features

- **Maximum of 20 features / 40 ports per system**
 - 12/24 on Capacity setting 110
- **New Gigabit Ethernet features with**
 - Intrusion detection
 - New connector type, LC Duplex
- **Gigabit Ethernet LX - FC 1364**
 - 9 micron single mode fiber
- **Gigabit Ethernet SX - FC 1365**
 - 50 or 62.5micron multimode fiber
 - GbE LX and SX capable of achieving 1.2 Gbps* using jumbo frames
- **New 1000BASE-T Ethernet (10/100/1000 Mbps) - FC 1366**
 - Capable of achieving line speed*
 - RJ45 connector, twisted pair, Category 5 copper
 - OSA-ICC Support 
 - Supports the following in QDIO mode when operating at 1000 Mbps (1 Gbps)
 - Jumbo frames
 - Intrusion detection
- **Token-Ring (4/16/100 Mbps) - FC 2367**
 - Capable of achieving line speed *
 - Carry forward from z800
 - Intrusion detection

New connectors

LC Duplex MM



LC Duplex SM

Gigabit Ethernet Features 1364, 1365

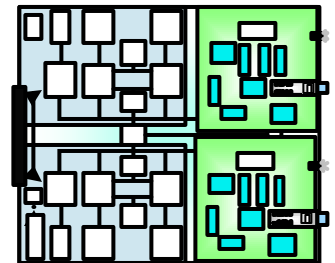

Ethernet (1000BASE-T) Feature 1366

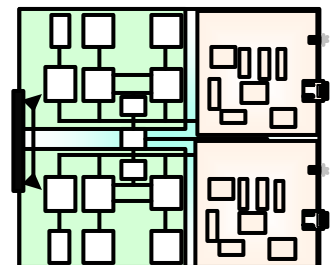

Note: The total quantity of FICON Express, OSA-Express, PCICA, and PCIXCC cannot exceed 20 features per server

OSA-ICC (OSA Integrated Console Controller)

- **Lower entry price for OS Console attachment**
 - Replace channel-attached 3274, 3174, 2074
- **OSA-Express 1000BASE-T (10/100/1000 mbps)**
 - Two ports per feature
 - Each port can be configured independently (OSA or OSA-ICC)
 - One port cannot perform both functions
- **Console emulation much like IBM 2074**
 - Managed from the Support Element(s)
 - TN3270E Ethernet (Dix and IEEE 802.3) TCP/IP - non-SNA 3270 Console
 - 120 terminals
 - Consider two features for redundancy
- **Minimum Software:**
 - VSE/ESA V2.6
 - z/VM 4.4 with PTF for APAR VM63405
 - z/OS.e 1.3 and z/OS 1.3 with PTF for APAR OA05738
 - TPF 4.1

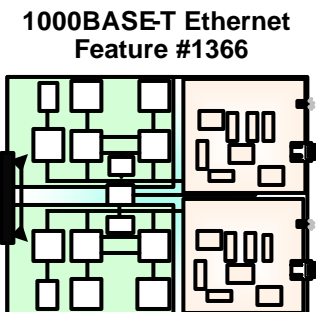

NOTE: No coaxial cable support or Token-Ring support;
Can coexist in configurations using prior IBM 2074 models and older 3174 controllers

z890/z990 OSA-ICC Single System with Alternate Sessions

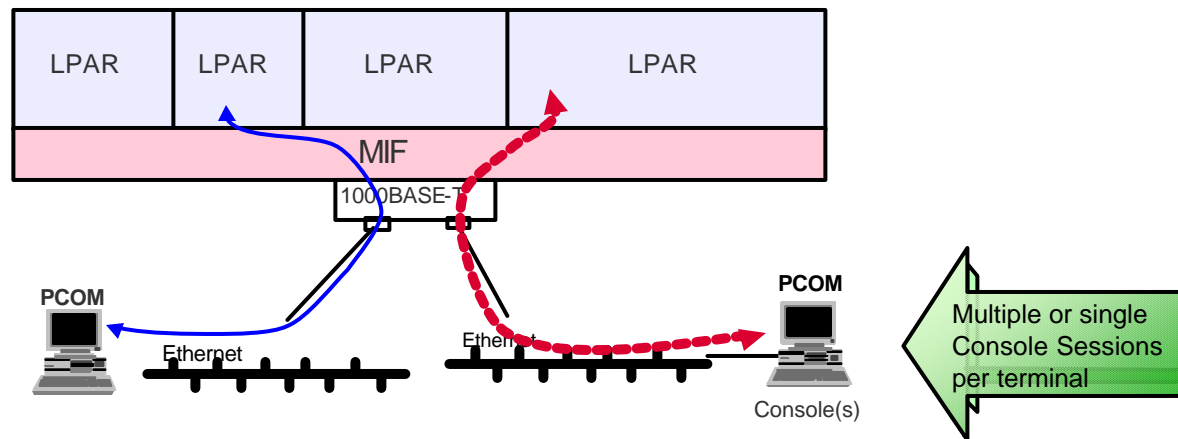

- **Up to one hundred twenty (120) sessions per port across multiple Logical Partitions**
 - ▶ MIF capable
 - ▶ Can run multiple sessions on a single workstation
- **For increased console session availability, plan for separate consoles, on separate LANs, on separate ports, on separate OSA-Express features**
 - ▶ Manual, disruptive console session switch possible
- **OSA-ICC – SA22-7990 – New Publication**

Cryptography



- **CP Crypto Assist for Cryptographic Functions (CP Assist)**
 - High performance clear key DES and SHA-1 engine in every CP

- **PCI Cryptographic Accelerator (PCICA) -- increments = 0, 1 or 2 features** **VSE 2.7, z/VM 5.1, Linux**
(2 engines per card)
 - High performance Public Key (SSL) Acceleration
 - Carried forward on z800 upgrades

- **PCIXCC Cryptographic Coprocessor -- increments = 0, 2, 3 or 4 features** **z/VM 4.1, Linux**
 - I/O Cage installable PCIXCC feature
 - Adds security rich functions previously found in CCF and PCICC

The total quantity of FICON Express, OSA-Express, PCICA, and PCIXCC cannot exceed 20 features per server

HiperSockets

- **Four times the connectivity of z800/z900**
 - From 4 to 16 HiperSockets
 - Connect four times more TCP/IP stacks
 - Increased number of communication queues (from 1,024 to 4,096)
 - Support for multiple LCSS
 - Single LP can connect to 16 HiperSockets

- **Support for spanned CHPIDs across multiple LCSS**
 - One HiperSocket can be shared by up to 30 Logical Partitions

- **Virtual LAN (IEEE 802.1q) support**

- **Broadcast for IPv4**

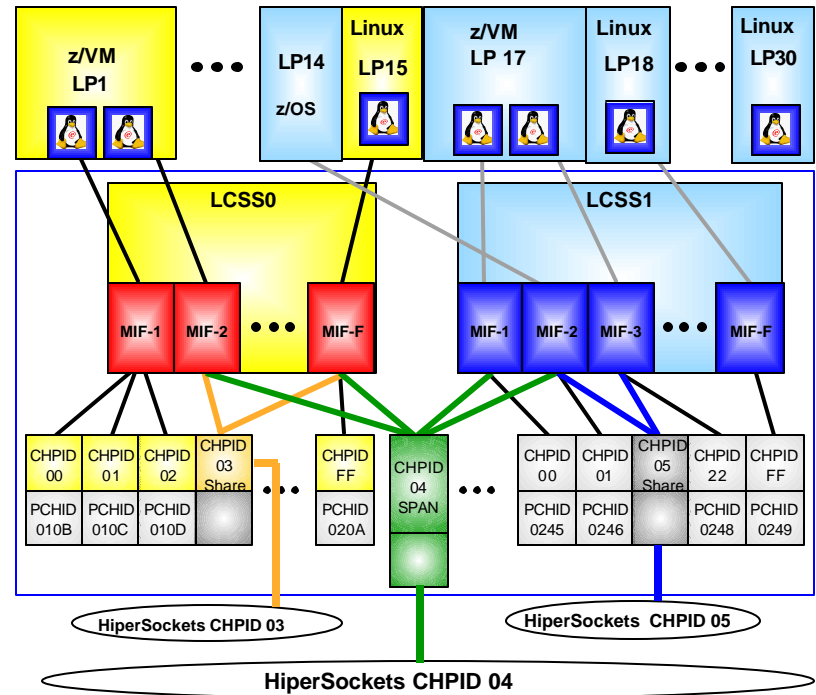

Very High Speed Interconnection between programs running VSE/ESA, z/VM, z/OS or Linux®

z890 and z/VSE

- **Protect** existing client investments in VSE programs, data, equipment, IT skills, business processes, end user training, etc.
 - Modernize, Web-enable CICS® application
 - z890 servers, IBM storage and software
- **Integrate** VSE with the rest of your IT
 - VSE connectors and Web services
 - IBM middleware
- **Extend** with Linux on zSeries
 - New applications
 - Infrastructure simplification

Why Not Think Inside the Box?

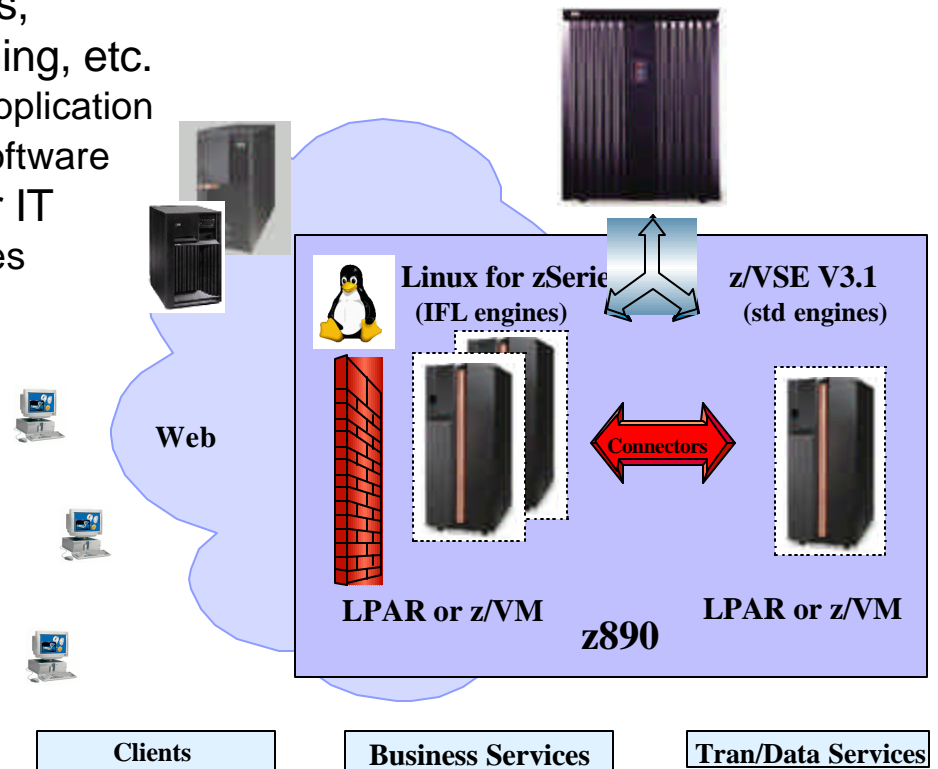

Note: z/VSE can execute in 31-bit mode only. It does not implement z/Architecture, and specifically does not implement 64-bit mode capabilities. z/VSE is designed to exploit selected features of IBM zSeries hardware.

Software Support and Pricing

z890 Supported Operating System Software

Operating System	ESA/390 (31-bit)	z/Arch (64-bit)	Notes
z/VSE** Version 3 Release 1	Yes	No	Preview
VSE/ESA Version 2 Release 6, 7	Yes	No	
z/VM Version 5	No	Yes	ALS
z/VM Version 4 Release 3, 4	Yes	Yes	4.4; exploitation
z/VM Version 3 Release 1	Yes	Yes	
Linux, 64-bit distribution	No	Yes	
Linux, 31-bit distribution	Yes	No	
z/OS Version 1 Release 2, 3, 4, 5	No*	Yes	
z/OS.e Version 1 Release 3, 4, 5	No	Yes	
OS/390® Version 2 Release 10	Yes	Yes	<i>9/04 End of Service</i>
TPF Version 4 Release 1 (ESA mode only)	Yes	No	

* IBM Bimodal Accommodation Offering (z/OS only) is available for z/OS 1.2, 1.3, and 1.4. This offering will not be provided for z/OS 1.5

** Note: z/VSE can execute in 31-bit mode only. It does not implement z/Architecture™, and specifically does not implement 64-bit mode capabilities. z/VSE is designed to exploit selected features of IBM zSeries hardware.

VSE Pricing for zSeries 890

1-way	2-way	3-way	4-way
110 (zELC)	210 (EWLC Tier A)	310 (EWLC Tier A)	410 (EWLC Tier B)
120 (EWLC Tier A)	220 (EWLC Tier B)	320 (EWLC Tier C)	420 (EWLC Tier C)
130 (EWLC Tier B)	230 (EWCL Tier C)	330 (EWLC Tier C)	430 (EWLC Tier D)
140 (EWLC Tier C)	240 (EWLC Tier C)	340 (EWLC Tier D)	440 (EWLC Tier D)
150 (EWLC Tier C)	250 (EWLC Tier D)	350 (EWLC Tier D)	450 (EWLC Tier E)
160 (EWLC Tier C)	260 (EWLC Tier D)	360 (EWLC Tier E)	460 (EWLC Tier E)
170 (EWLC Tier D)	270 (EWLC Tier E)	370 (EWLC Tier E)	470 (EWLC Tier E)

Note: For z890, VSE is priced using EWLC – Tiered Price Structure.
zELC prices are used for Capacity Setting 110 (only).

Replace your Multiprise[®] 2000 running VSE with an IBM eServer zSeries 890 and Save!



- **Innovation on IBM eServer™ zSeries® 890**
 - High Capacity IFL
 - OSA-Express, OSA-ICC
 - On/Off Capacity on Demand
 - PCI Crypto
 - HiperSockets™

- **Ongoing Savings help you offset the cost of your hardware investment.**
- **Savings driven by:**
 - ▶ Lower priced VSE/ESA™ on the z890 with zELC or EWLC Tiered Price Structure versus Model Group software pricing

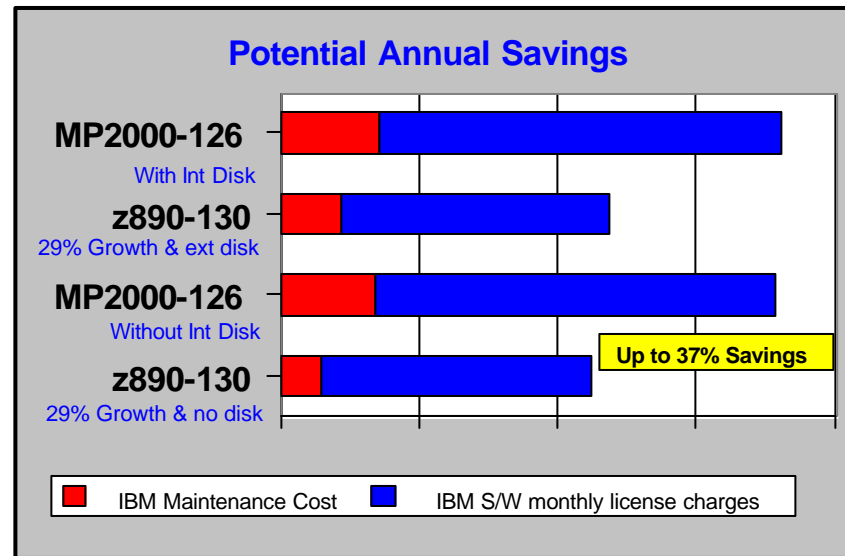
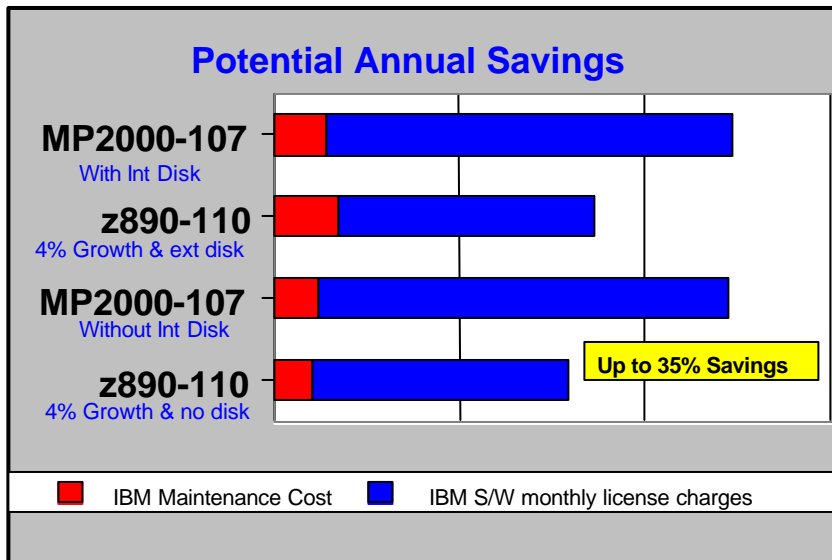

Too much capacity on your Multiprise 3000 running VSE today? Consider a z890 to bring new technology to your firm!

▪ Innovation on z890

- High Capacity IFL
- OSA-Express, OSA-ICC
- On/Off Capacity on Demand
- PCI Crypto
- HiperSockets

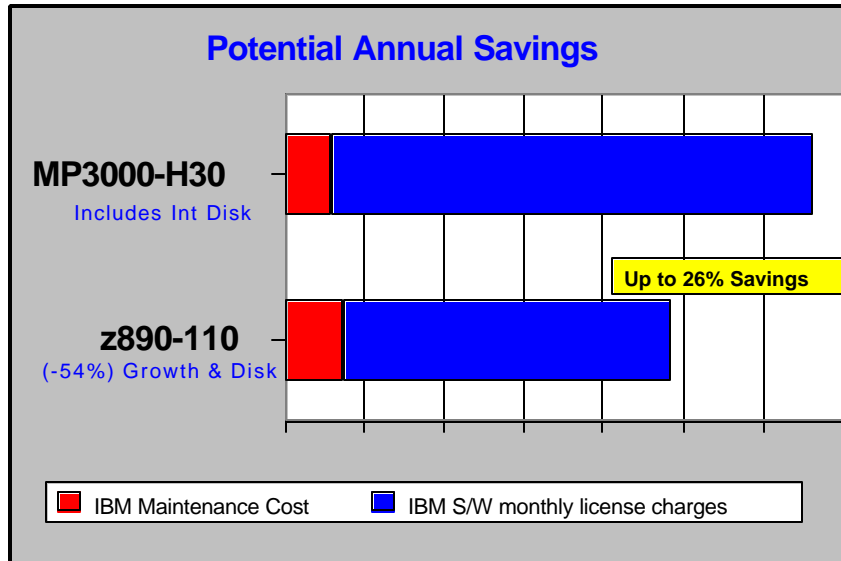

▪ Ongoing Savings help you offset the cost of your hardware investment.

▪ Savings driven by:

- ▶ Providing a solution with the granularity you need
- ▶ Lower priced VSE on the 110 with full capacity zELC versus GOLC software pricing

▪ Additional Value considerations:

- ▶ IGF certified used ESS F20 – 420 GB capacity
- ▶ Granular upgradeability
- ▶ Temporary capacity available with On/Off Capacity on Demand

* Hardware configuration based on general purpose central processors only (no IFLs) and similarly configured for costing purposes. VSE software stack based on VSE/ESA, CICS, DITTO, SSP, VTAM, COBOL, LE and HLA.

Replace your 9672 G4 running VSE with a z890 and Save!



▪ Innovation on z890

- High Capacity IFL
- OSA-Express, OSA-ICC
- On/Off Capacity on Demand
- PCI Crypto
- HiperSockets

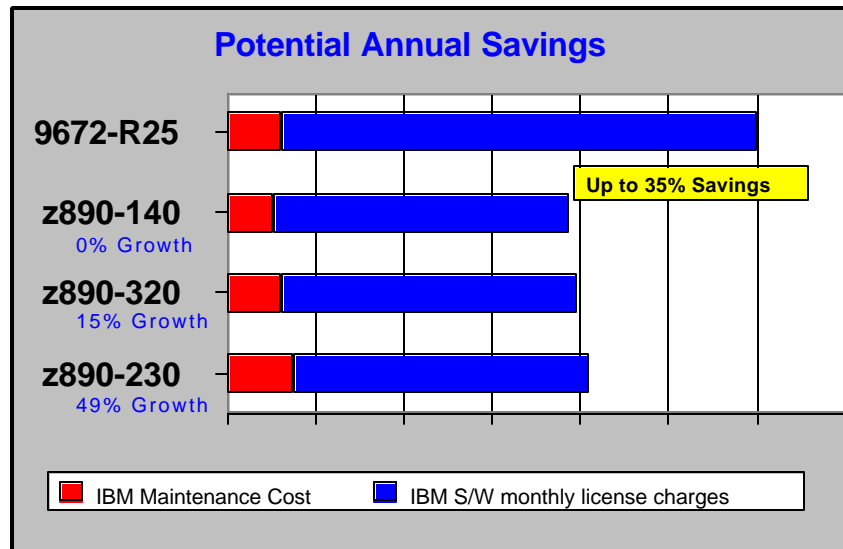

▪ **Ongoing Savings help you offset the cost of your hardware investment.**

▪ Savings driven by:

- ▶ Lower priced IBM hardware maintenance on z890-140
- ▶ Lower priced VSE on the 140, 320 and 230 with Tiered Price Structure versus Model Group software pricing

▪ Additional Value considerations:

- ▶ Granular upgradeability
- ▶ Temporary capacity available with On/Off Capacity on Demand

* Hardware configuration based on general purpose central processors only (no IFLs) and similarly configured for costing purposes. VSE software stack based on VSE/ESA, CICS, DITTO, SSP, VTAM, COBOL, LE and HLA.

Updated Engine-based Pricing for z/VM V5.1

- Lower entry price point than z/VM V4
- Decreasing price curve as more engines are added
 - Even across the enterprise
- Manage software costs better by using z/VM V5, Linux and IFLs to run new workload applications
- On/Off CoD -processor engine per-day basis
- z/VM V5 is able to aggregate licenses across machines within the enterprise



Planned GA September 24, 2004

Rapid Growth and Acceptance of Linux on zSeries

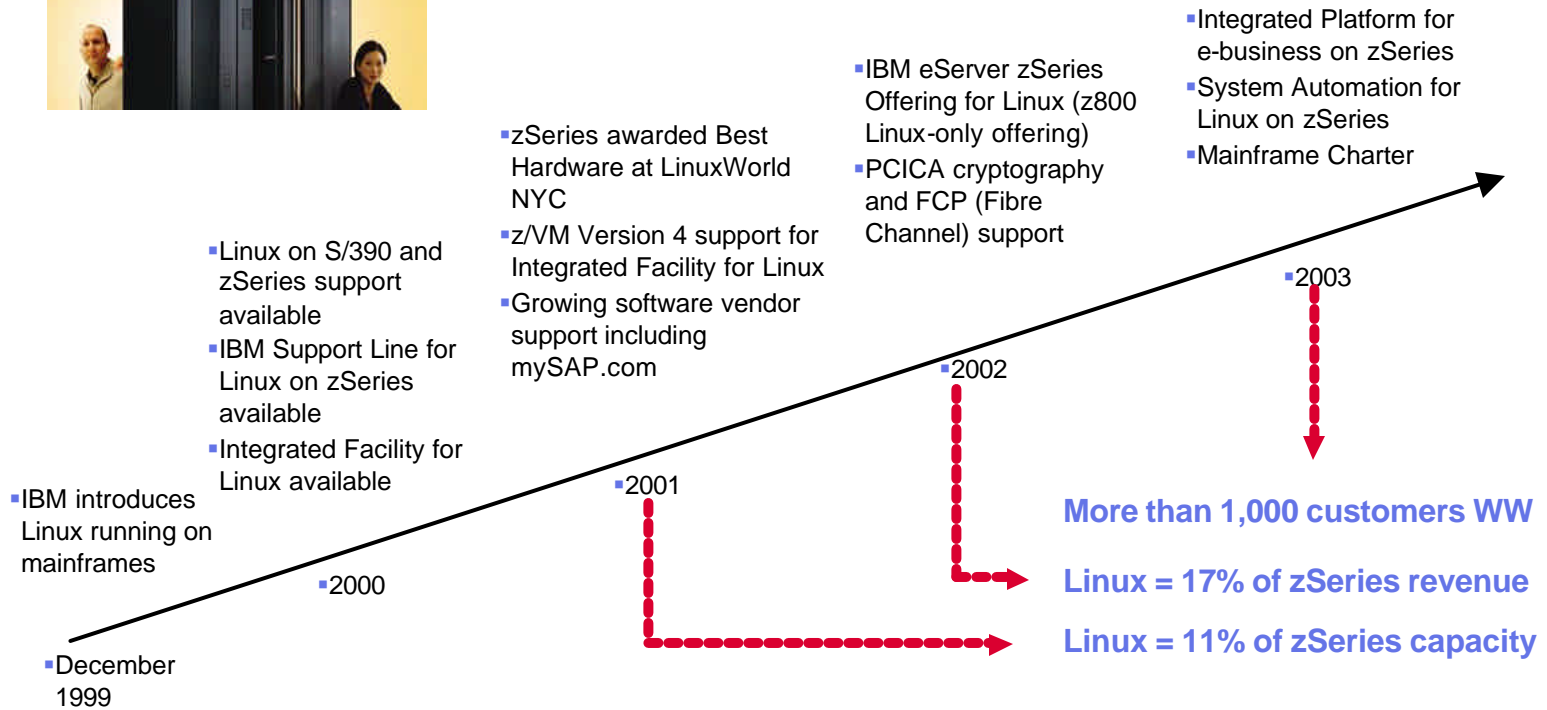

Over 30% of IBM mainframe customers have applications in production on Linux today!



Linux on IBM z890

- **Support for zSeries functions delivered as Open Source Contribution in June 2003 via -**
<http://www10.software.ibm.com/developerworks/opensource/linux390>

- **Currently available distributions**
 - SUSE SLES 7
 - SUSE SLES 8
 - Red Hat REHL 3.0
 - Turbolinux TLES 8
 - Conectiva CLEE

- **January 2004 – to Developerworks web site**
 - FCP SAN management - OSA Express 1000BASE-T Ethernet – New
 - PCI X Cryptographic Coprocessor (PCIXCC)
 - Linux kernel 2.2.16 and higher

Migration Planning

IBM Networking Services for zSeries fiber cabling

Short wave

FICON

ESCON

Jumper cables

Long wave

New connectors

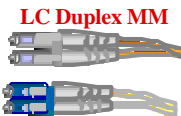

LC Duplex SM

Fibre Channel Protocol

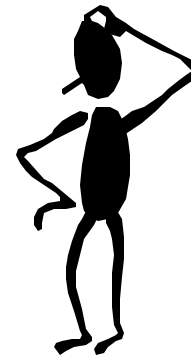

Trunking solutions

Small form factor connectors

Conversion kits

62.5 micron

50 micron

9 micron



Mode conditioning kits

A seamless, comprehensive, integrated fiber cabling service

IBM Networking Services for zSeries fiber cabling

- **Changing environments, protocols and products**
 - System or enterprise-wide view
 - Multitude of choices
 - Connectors, cables, products
 - Tactical and strategic decisions
- **Right-sized packaged offering**
 - Contracted, fixed-price service
 - End-to-end service
 - Planning -> Consultation -> Cables -> Installation -> Connection report



A seamless, comprehensive, integrated fiber cabling service

Considerations

- **No Internal-Disk**
 - ESS 750 Shark
 - IGF certified used ESS F20 – 420 GB capacity

- **LPAR mode only (no basic mode)**
 - No I/O Assist for V=F or V=R guests

- **Parallel channels**
 - Same as z800
 - Use Optica ESCON® Converter or IBM 9034

- **OSA-2 ATM or FDDI**
 - Migrate to OSA-Express Ethernet or use multi-purpose switch

- **PCICC cards**
 - No carry forward
 - Replaced by PCIXCC for most commonly used functions

z890 Summary



- **New IBM eServer zSeries 890 delivered with price/performance and technology-driven business value**
 - 28 capacity settings provide flexibility and granular growth
 - Specially designated workload processors available for Coupling, Linux and Java™ workloads
 - Entry point at 4 MSUs and 28 capacity settings can help you to better manage software costs
 - Up to 140% price/performance improvement for Linux IFLs over z800
 - Up to 10% price/performance improvement on Maintenance over z800
 - Entry Workload License Charge (EWLC) and EWLC Tiered Price Structure introduced for flat charged products
 - New cost effective z/VM V5.1 with engine-based pricing
 - New z/VSE
 - Linux for Infrastructure Simplification or application modernization
 - On/Off Capacity on Demand
 - OSA-Integrated Console Controller
 - New and Improved Networking and Connectivity Options



*Thank you for your
time and for doing
business with IBM*



© The History of IBM

1964



1972

1982



1999



2004



Reference Material

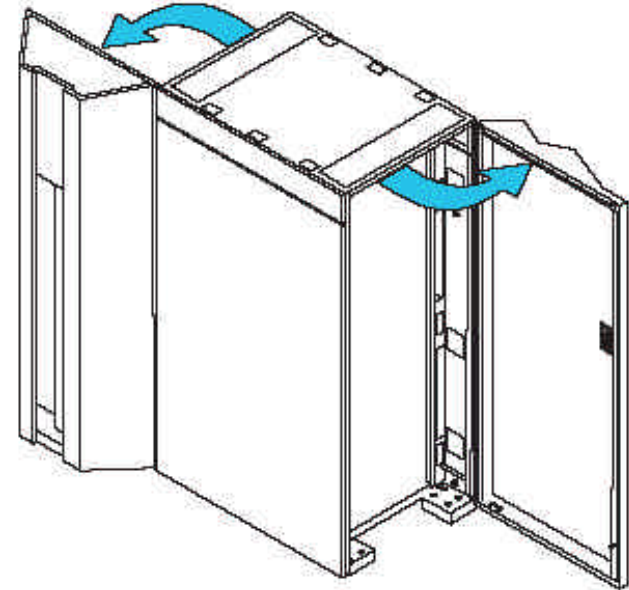

Physical Planning

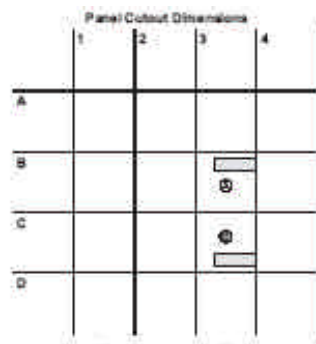
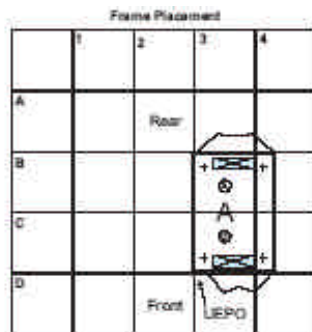

Physical Planning – IMPP (GC28-6828)

- **All systems are air cooled, one frame systems**
 - raised floor (recommended) or non-raised floor

- **Height reduction (FC9975 no charge)**
 - Accommodates door height restrictions
 - IBF batteries will come unplugged if height reduction is ordered

- **Optional Internal Battery Feature-IBF (FC3210 chargeable)**
 - Installed as a pair (top - front and back)
 - No width reductions are required
 - Can be added later via MES

- **Power - Dual power cables (Hubbell) 50/60Hz**
 - 3 Phase, 200V-480V
 - 1 Phase, 200V-415V
 - Cabled in upper CEC cage

- **Optional Power Sequence Control (PSC)- (FC6501 chargeable) installed as a pair**

Dimensions

Top section can be removed for shipping
but only if really necessary.

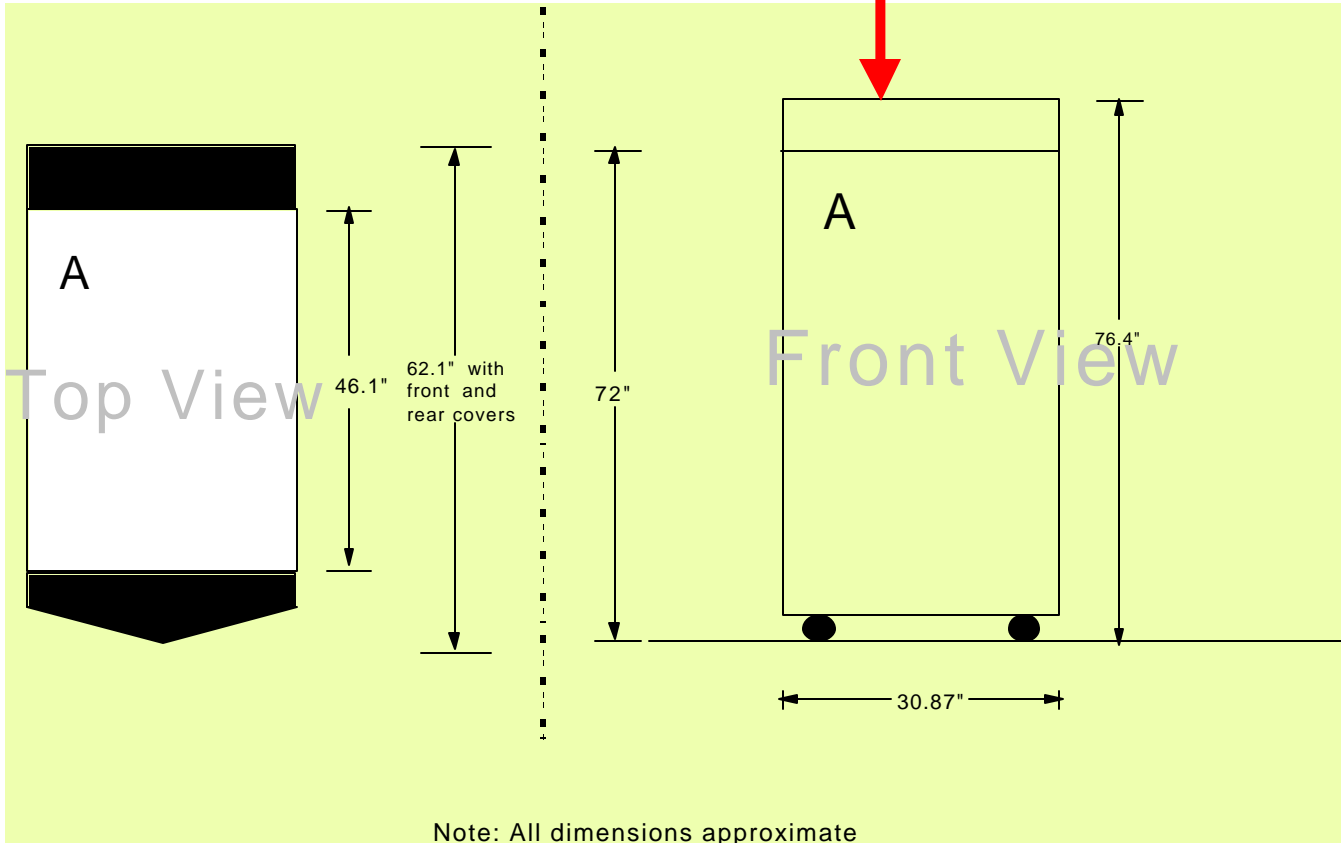

Heat Exchange

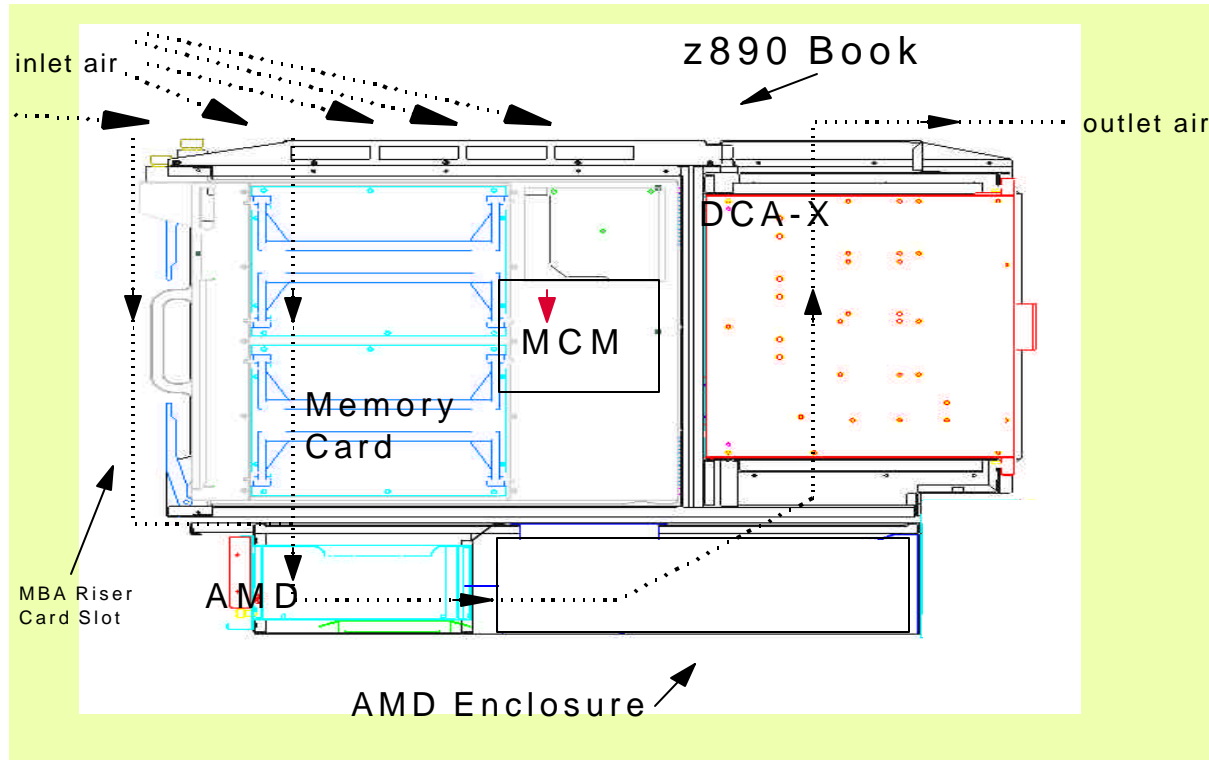

Cold air in the front.

Heated air out the back.

Compatibility versus Exploitation

■ **Compatibility**

- Can use HCD to create an IODF with multiple LCSSs
- Software ACTIVATE can be performed
 - Number of defined LCSSs is irrelevant
- Can only perform a hardware ACTIVATE if:
 - The changed/new resources are restricted to LCSS0
- POR is required for activating IODF:
 - with additional LCSSs
 - with new LPARs
 - with changed/new resources in LCSS1
- Sysplex Considerations

■ **Exploitation**

- Can perform full hardware ACTIVATE
 - With multiple LCSSs defined
- Run in LCSS 1
- > 15 LPARs
- Dynamic I/O changes in LCSS 1
- Extended Channel Measurement Block (ECMB) support

CBU Information

- Total number of CPs, SAPs, ICFs, zAAPs, spares, On/Off CoD engines, or CBU engines can not exceed 5 (total number of PUs available on z890)
- CBU applies to whole zSeries CP engine additions only and only to the largest capacity configurations (full engine)
- CBU is always a temporary capacity upgrade
- On/Off CoD activation is mutually exclusive with CBU activation. Both On/Off CoD and CBU can reside on the server, but only one can be activated at a time (can't have both on at the same time)

Capacity Setting	CBU Options
110	270,370,470
120	270,370,470
130	270,370,470
140	270,370,470
150	270,370,470
160	270,370,470
170	270,370,470
210	370, 470
220	370, 470
230	370, 470
240	370, 470
250	370, 470
260	370, 470
270	370, 470
310	470
320	470
330	470
340	470
350	470
360	470
370	470
	Capacity settings in blue have same engine size as from capacity set

G5/G6, MP3000, z800, z890 Physical Characteristics

	G5 / G6 Minimum 1 Frame System	G5 / G6 Maximum 2 Frame System	Multiprise 3000 1 Frame System Maximum	z800 Maximum	z890 Minimum	z890 Maximum
Power 50/60 Hz, kVA	0.6 / 1.0	5.5 / 5.5	1.32	2.95KW	1.5	4.7
Heat Output KBTU/hr	2.0 / 2.5	18.8 / 18.8	4.5	10.0	5.12	16.05
Air Flow CFM Air Flow m³/min	290 / 290 7.1 / 7.1	1400 / 1400 38.6 / 38.6		400 11.1	640 17.64	640 17.64
Floor Space - Sq. meters - Sq. feet	1.0 / 1.6 10.4 / 16.4	1.8 / 1.8 19.7 / 19.7		0.83 8.9	1.24 13.33	1.24 13.33
Including service clearance - Sq. meters - Sq. feet	2.5 / 2.5 27.4 / 27.4	4.8 / 4.8 51.9 / 51.9		6.0 64.5	3.03 32.61	3.03 32.61
Approximate weight - kg - lbs	612 / 612 1346 / 1346	938 / 938 2057 / 2057	236 520	545 1201	674 1482	785 1730
Approximate height - cm - inches	199.8 78.7	199.8 78.7	80 31.5	181.1 71.3	194.1 76.4	194.1 76.4

zSeries Application Assist Processor (zAAP or AAP)

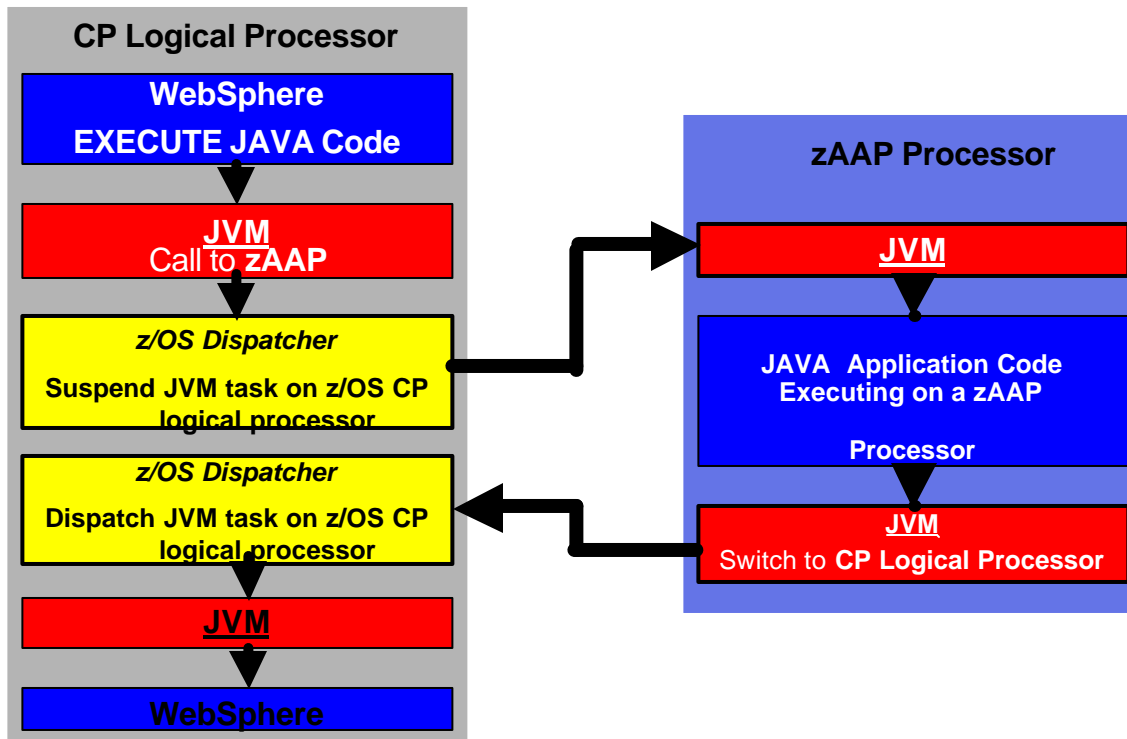

- A new zSeries Application Assist Processor for Java (zAAP)
 - ▶ zAAPs are designed exclusively for z/OS and z/OS.e Java code execution
 - ▶ z/OS & z/OS.e JVMs assists with the execution of Java code from CP's to zAAPs



- Provides a true Single Tier integrated application and database server

- The zAAP assists reduce the CP time needed to run WebSphere applications, freeing capacity for additional workloads

z/VM & VSE/ESA Support Summary Dates

								End of Mkt	End of Service	Planned Ship Date
		G3-G4	G5/G6 MP3000	z800	z890	z900	z990			
VSE/ESA	2.5	X	X	X		X	X ^c	12/01	12/03	9/00
	2.6	X	X	X	X ^c	X	X ^c	3/03		12/01
	2.7*		X	X	X	X	X			3/03
z/VSE	3.1		X	X	X	X	X			2005 ¹
z/VM	3.1*	X	X	X	X ^c	X	X ^c	8/04	tbd	02/01
	4.1		X	X	X ^c	X	X ^c	10/01	6/03	7/01
	4.2		X	X	X ^c	X	X ^c	5/02	12/03	10/01
	4.3		X	X	X ^c	X	X ^c	8/03	5/05	5/02
	4.4*		X	X	X	X	X	tbd	9/06	8/03
	5.1*			X	X	X	X	tbd	xx/07	3Q04 ¹

x^c - Compatibility support

¹ - Planned availability

*Releases currently orderable

OS/390 & z/OS Support Summary Dates



		G3-G4	G5/G6 Multiprise 3000	z800	z890	z900	z990	End of Service	Coexists with z/OS...	Planned Ship Date
OS/390	2.8	X	X	X		X		9/02	1.2	
	2.9	X	X	X		X		9/03	1.3	
	2.10	X	X	X	x ^c	X	x ^c	9/04	1.4	
z/OS	1.1		X	X		X		3/04	1.4	
	1.2		X	X	x ^c	X	x ^c	10/04	1.5	
	1.3		X	X	x ^c	X	x ^c	3/05	1.6	
	1.4		X	X	X	X	X	3/07	1.7	9/02
	1.5		X	X	X	X	X	3/07	TBD	3/04
	1.6			X	X	X	X	9/07	TBD	9/04

x^c - Compatibility support

IBM Bimodal Accommodation Offering is available for z/OS 1.2, 1.3, and 1.4. It will not be provided for z/OS 1.5

1.4 will remain orderable until Sept 9, 2004

1.5 will be orderable between March 13 through Sept. 9, 2004

z/OS.e V1R3/R4/R5/R6 will only run on a z800 and z890 server

z/VSE (1) V3.1 Exploitation of z890 & z990 Features

zSeries Functions	z/VSE V3.1	VSE/ESA V2.7	VSE/ESA V2.6
Fibre Channel Protocol (FCP for SCSI Disks)	Yes	No	No
HiperSockets™ (including spanned HiperSockets)	Yes	Yes	No
PCICA SSL encryption assist	Yes	Yes	No
Adapter interrupts for OSA-Express	Yes	Yes	No
OSA – Integrated Console Controller (OSA-ICC)	Yes	Yes	Yes
OSA – Express, incl Ethernet and Token-Ring	Yes	Yes	Yes
Up to 30 LPARs	Yes	Yes	Yes
Up to two LCSSs for z890 (up to 4 for z990)	Yes	Yes	Yes
FICON-Express™	Yes	Yes	Yes

Note 1: z/VSE can operate in 31-bit mode only. It does not implement z/Architecture and specifically does not implement 64-bit mode capabilities. z/VSE is designed to support selected features of IBM zSeries hardware

z/VM 4.4 - Exploitation of the z890 Server

- **Support for multiple Logical Channel SubSystems (LCSS)**
 - Allows the definition of more than one channel subsystem
 - Each channel-subsystem image can be configured with up to 256 channel paths
 - Each logical partition has access to one channel-subsystem image
 - Dynamic-I/O configuration support has been extended to allow channel paths, control units, and devices to be dynamically added, changed, and deleted
 - I/O configuration can be dynamically changed with:
 - CP suite of interactive dynamic-I/O-configuration commands
 - HCM and HCD - new configuration-management tools
- **Support for spanned channels**
 - Helps enable inter-process communication (IPC) among Linux guests
- **Extended Channel Measurement Data Support (ECMDS)**
 - Improved capacity planning and I/O performance measurement
- **Support for more than 15 Logical Partitions (LPARs)**
 - Handles I/O-configuration definition and dynamic-I/O configuration logical partitions
 - CP Monitor will allow performance data to be collected and recorded
- **z/VM V3.1, V4.2, and V4.3 support the z890 in compatibility mode**

OS/390 & z/OS Support for z890 Servers

- **z/OS and OS/390 supported levels for z890**
 - z/OS 1.6 and z/OS.e 1.6 (planned availability Sept. 24, 2004)
 - z/OS 1.5 and z/OS.e 1.5 (available March 26, 2004)
 - z/OS 1.4 **plus** exploitation support feature
 - Provides compatibility and exploitation support
 - z/OS V1R2/R3, z/OS.e V1R3 **plus** compatibility code
 - Provides compatibility support only
 - z/OS.e V1R4 **plus** coexistence update feature
 - Provides compatibility and exploitation support
 - OS/390 V2R10
 - Provides compatibility support only
- **Secure Cryptographic support is not integrated in the base operating system**
 - Separate web download
- **The software release will determine how to obtain the required software**
 - Orderable via feature
 - Web download



PTFs alone
do not
provide
support

z/OS V1R1 is not supported

z890 Linux Functions – cross reference

Function	SUSE		Red Hat	Turbolinu	Conectiv
	SLES 7	SLES 8	REHL 3.0	x TLES 8	a CLEE
30 LPARS	X	X	X	X	X
Greater than one Logical Channel Subsystems	X	X	X	X	X
Hipersockets	X	X	X	X	X
Dynamic I/O support	X	X	X	X	X
Internal and external spanned channels	X	X	X	X	X
VLAN (IEEE 802.1q)		X	X	X	X
Broadcast for IPv4packet		X	X	X	X
16-port ESCON feature	X	X	X	X	X
FICON Express (CHPID type FC)	X	X	X	X	X
FICON Express (CHPID type FCP)		X	X	X	X
SCSI IPL for FCP		X		X	X
Cascaded FICON Directors		X	X	X	X
OSA-Express Token Ring	X	X	X	X	X
OSA-Express Gigabit and 1000BASE-T Ethernet	X	X	X	X	X
CP Assist for Cryptographic function (CPACF)		X		X	X
PCI Cryptographic Accelerator (PCICA)	X	X	X	X	X
Intrusion Detection Services		X	X	X	X

TPF 4.1

- Protect investments in your core TPF assets – z890 support
 - OSA-Integrated Console Controller
 - FICON and FICON Express™
 - OSA-Express
 - Up to 30 LPARs (PJ29309 required)
 - Server Consolidation

- Integrate TPF with your datacenter
 - WebSphere™ MQ
 - Web Services/SOAP/XML/IIOP and more

- Leverage your TPF investments with Linux on zSeries



z890 Publications via ResourceLink

- | | | | |
|---|-----------|--|-----------|
| ▪ Agreement for Licensed Internal Code | SC28-6822 | ▪ Maintenance Information for Desktop Consoles | GC38-3115 |
| ▪ Application Programming Interfaces | SB10-7030 | ▪ Maintenance Information for Fiber Optic Links | SY27-2597 |
| ▪ Capacity Backup User's Guide | SC28-6823 | ▪ Maintenance Information for Thinkpad Consoles | GC38-3117 |
| ▪ CHPID Mapping Tool User's Guide | SC28-6825 | ▪ Parts Catalog | GC28-6829 |
| ▪ CF Channel I/O Interface Physical Layer | SA23-0395 | ▪ Planning for Fiber Optic Links | GA23-0367 |
| ▪ ESCON and FICON Channel-to-Channel | SB10-7034 | ▪ PR/SM Planning Guide | SB10-7036 |
| ▪ ESCON Physical Layer | SA23-0394 | ▪ Safety Notices | G229-9054 |
| ▪ FICON I/O Interface Physical Layer | SA24-7172 | ▪ Safety Inspection | GC28-6833 |
| ▪ Hardware Management Console Operations Guide (V1.8.2) | SC28-6830 | ▪ Service Guide | GC28-6827 |
| ▪ Installation Manual for Physical Planning | GC28-6828 | ▪ Standalone IOCP User's Guide | SB10-7040 |
| ▪ Installation Manual | GC28-6826 | ▪ SCSI IPL - Machine Loader Messages | SC28-6839 |
| ▪ IOCP User's Guide | SB10-7037 | ▪ Support Element Operations Guide (Version 1.8.2) | SC28-6831 |
| | | | |
| | | ▪ z890 Technical Introduction | SG24-6310 |
| | | www.redbooks.ibm.com | |
| | | ▪ z890 SAPR Guide | SA04-002 |