



# Linux on zSeries for VSE/ESA customer

WAVV 2002  
FT. Mitchell, KY April 12-16



Wilhelm Mild  
IBM Germany - Boeblingen Laboratory  
e-business ambassador  
e-mail: mildw@de.ibm.com

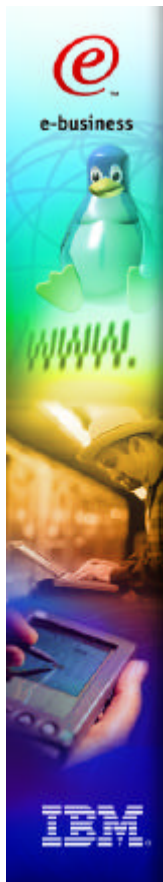

## Trademarks

The following are trademarks of the International Business Machines Corporation in the United States and/or other countries.

|                           |                       |                                  |                |
|---------------------------|-----------------------|----------------------------------|----------------|
| BookManager*              | IBM*                  | Parallel Sysplex*                | VMESA*         |
| DB2*                      | IBM logo*             | PR/SM                            | VSE/ESA        |
| DFSMS/MVS*                | Language Environment* | QMF                              | VTAM*          |
| DFSMS/VM*                 | Multiprise*           | RACF*                            | z/Architecture |
| e-business logo*          | MVS                   | RAMAC*                           | z/OS           |
| Enterprise Storage Server | NetRexx               | S/390*                           | z/VM           |
| ESCON*                    | OpenEdition*          | S/390 Parallel Enterprise Server | zSeries        |
| FICON                     | OpenExtensions        | VisualAge*                       |                |
| GDDM*                     | OS/390*               | VisualGen*                       |                |

\* Registered trademarks of IBM Corporation

The following are trademarks or registered trademarks of other companies.

Lotus, Notes, and Domino are trademarks or registered trademarks of Lotus Development Corporation; LINUX is a registered trademark of Linus Torvalds; Penguin (Tux) compliments of Larry Ewing; Tivoli is a trademark of Tivoli Systems Inc.; Java and all Java-related trademarks and logos are trademarks of Sun Microsystems, Inc., in the United States and other countries; UNIX is a registered trademark of The Open Group in the United States and other countries; Microsoft, Windows and Windows NT are registered trademarks of Microsoft Corporation; SET and Secure Electronic Transaction are trademarks owned by SET Secure Electronic Transaction LLC.

\* All other products may be trademarks or registered trademarks of their respective companies.

### Notes:

Performance is in Internal Throughput Rate (ITR) ratio based on measurements and projections using standard IBM benchmarks in a controlled environment. The actual throughput that any user will experience will vary depending upon considerations such as the amount of multiprogramming in the user's job stream, the I/O configuration, the storage configuration, and the workload processed. Therefore, no assurance can be given that an individual user will achieve throughput improvements equivalent to the performance ratios stated here. IBM hardware products are manufactured from new parts, or new and serviceable used parts. Regardless, our warranty terms apply. All customer examples cited or described in this presentation are presented as illustrations of the manner in which some customers have used IBM products and the results they may have achieved. Actual environmental costs and performance characteristics will vary depending on individual customer configurations and conditions. This publication was produced in the United States. IBM may not offer the products, services or features discussed in this document in other countries, and the information may be subject to change without notice. Consult your local IBM business contact for information on the product or services available in your area. All statements regarding IBM's future direction and intent are subject to change or withdrawal without notice, and represent goals and objectives only. Information about non-IBM products is obtained from the manufacturers of those products or their published announcements. IBM has not tested those products and cannot confirm the performance, compatibility, or any other claims related to non-IBM products. Questions on the capabilities of non-IBM products should be addressed to the suppliers of those products. Prices subject to change without notice. Contact your IBM representative or Business Partner for the most current pricing in your geography.

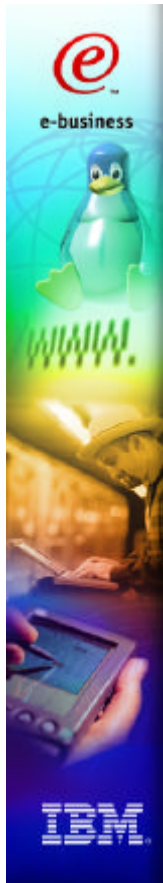

## Linux for S/390 and zSeries A new Option for VSE/ESA

- What is Linux ?
  - ▶ A popular UNIX system, developed by Linus Torvalds in 1991
  - ▶ Portable, with support for numerous hardware platforms
  - ▶ Available in source code, under GNU General Public License (GNU GPL)
  - ▶ A very stable operating system, developed and tested by 1000s of programmers world wide
  - ▶ Fast reaction to market requirements
  - ▶ Lots of different distributors, like Red Hat, SuSE, Caldera, Turbo Linux, Debian, and many others

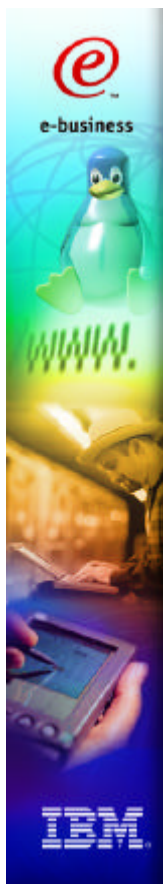

## UNIX Platform for VSE/ESA customers

### Requirements:

- ✓ a UNIX-like extension for VSE/ESA customer
- ✓ cost effective
- ✓ without prerequisites
- ✓ easy to integrate
- ✓ not proprietary

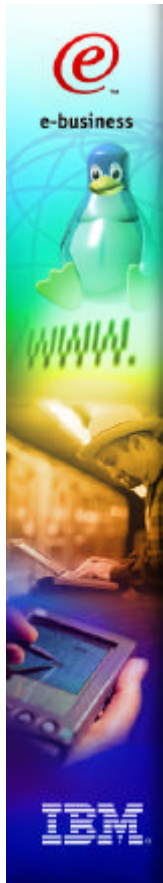

## Linux for S/390 and zSeries

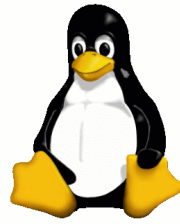

- ★ the UNIX Extension for VSE/ESA customer
- ★ born from within the VSE development team

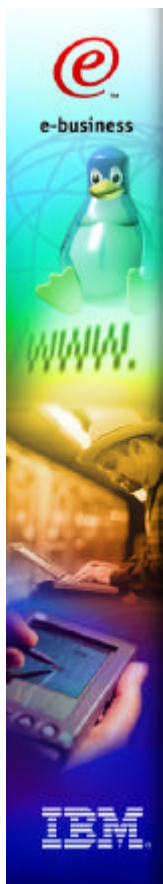

## Scenarios

- **Integrated Facility for Linux for zSeries**
- **zVM Version 4**
- **Traditional workload model extended with Linux for zSeries**

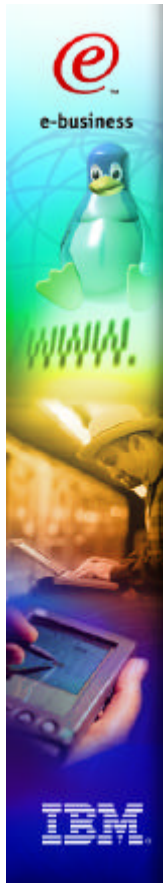

## The IBM Integrated Facility for Linux

- Additional processing capacity exclusively for Linux workloads
- Lower price than for standard engine
- Traditional S/390 software charges unaffected
- IFL is based on PR/SM LPAR technology
- IFL can be
  - ▶ Dedicated to a single logical partition or
  - ▶ Shared by multiple logical partitions
- S/390 reliability, availability, and serviceability for the exciting world of Linux

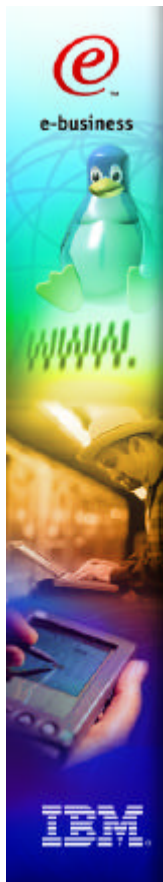

## Multiprise 3000 IFL Hardware Overview

- New IFL feature for H30 and H50

| Model | Processors                                 |
|-------|--|
| H30   | Uni + Uni (IFL)<br>(H30 + H50 performance) |
| H50   | Uni + Uni (IFL)<br>(H50 + H50 performance) |

- IFL has G5 processor design
- 4 Gbytes of processor storage total
- Upgrades of existing Multiprise 3000 models H30 and H50 also available



**Note:** The IBM Integrated Facility for Linux does not support any of the traditional operating systems ( VSE/ESA, z/VM Version 3, z/OS, OS/390, VM/ESA).

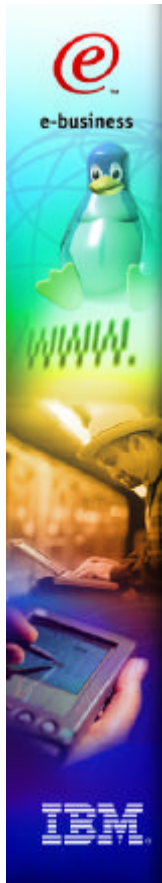

## Multiprise 3000 The cost effective way to get Linux

### 1. Business as usual

- ▶ Typical VSE/ESA environment on an H30
- ▶ Growth Opportunity License Charge (GOLC) for IBM software

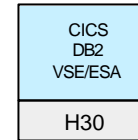

Example 1

### 2. + IBM Integrated Facility for Linux

- ▶ Traditional environment price remains the same
- ▶ Cost of IBM Integrated Facility for Linux and Linux distribution

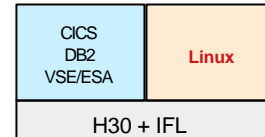

Example 2

### 3. + IBM software for Linux for S/390

- ▶ Traditional environment price remains the same
- ▶ Cost of IBM Integrated Facility for Linux, Linux distribution, z/VM, IBM Middleware
- ▶ Open Source products
- ▶ ISV Products

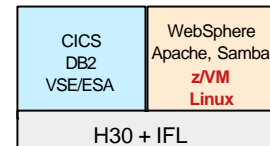

Example 3



## HiperSockets The network in the box

- **With VSE/ESA 2.7 (preannounced 02/2002)**
- **IP networking among virtual servers**
  - ▶ Improved response time due to low latency
    - High speed connectivity via memory bus
  - ▶ Highly secure
    - Data never flows outside the server
  - ▶ Highly available
    - Integrated zSeries hardware, no external parts
  - ▶ Cost savings
    - No external network, attachment, or cables
  - ▶ Flexible
    - Combinations of VSE/ESA, Linux, zOS and zVM
  - ▶ Simple to install, operate, maintain
    - Transparent to applications



## HiperSockets

The network in the box

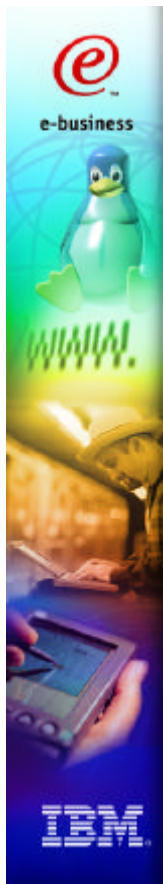
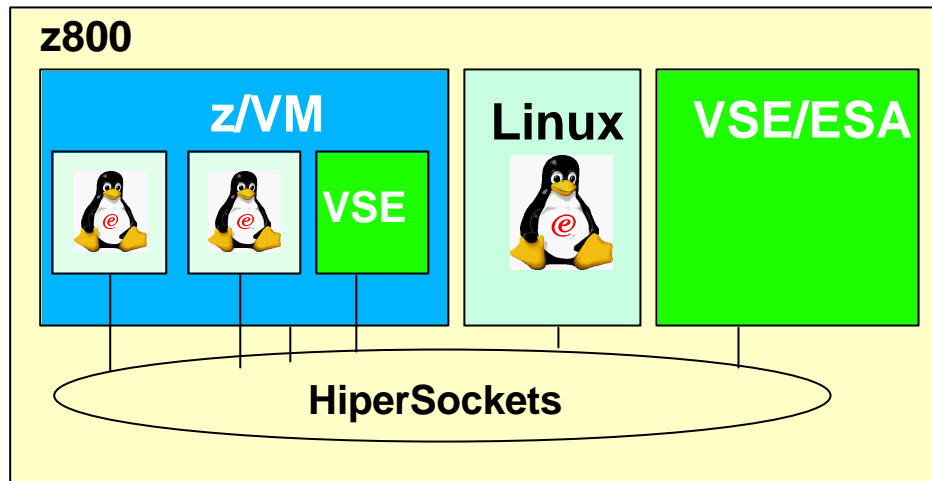

## Virtual Machine Technology Details

z/VM enhances a Linux environment in the following areas:

- ▶ Performance
- ▶ Productivity
- ▶ Operations



A *Virtual Machine* simulates the existence of a dedicated real machine, including processor functions, storage, and input/output resources.



# Linux for S/390 under z/VM

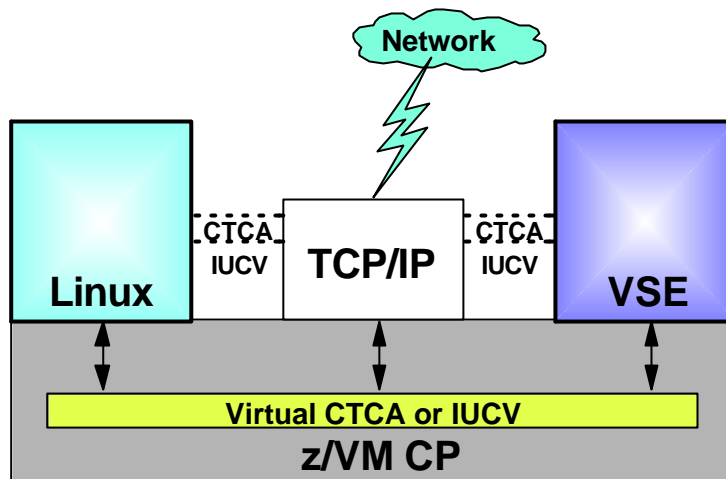

## Horizontal Growth with Linux on z/VM

"Just add another server" is cost effective with z/VM

Typical Linux (UNIX) environment

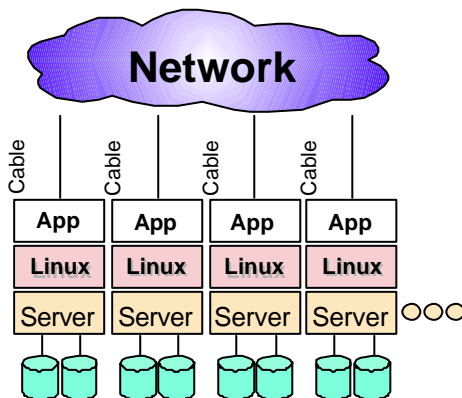

- ▶ One application per server is the norm
- ▶ Dedicated disks required
- ▶ Complex system management

Linux on z/VM

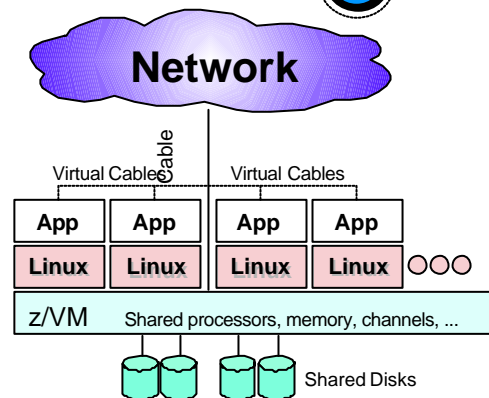

- ▶ Mixed applications per zSeries server
- ▶ Shared resources
- ▶ Less complex system management

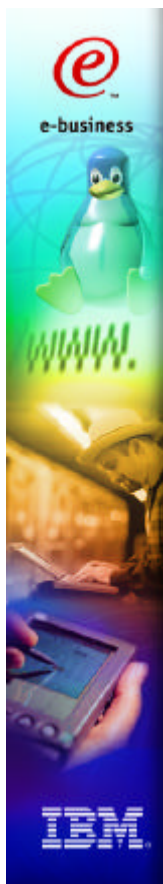

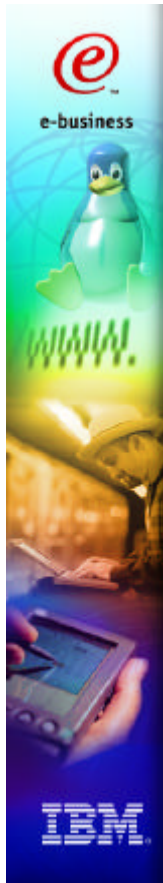

## 3-Tier Architecture on 2 Tiers of Hardware Data Servers and Application Servers on Single zSeries Processor

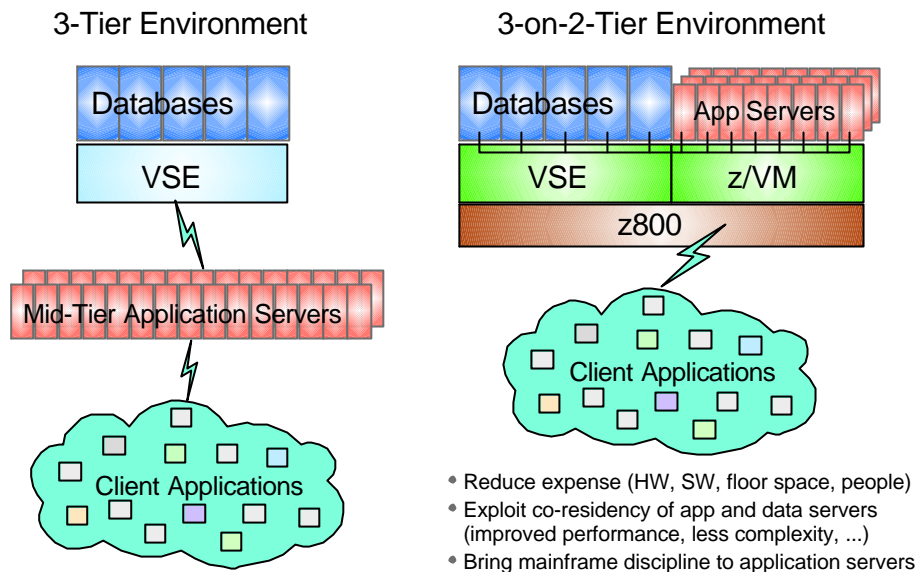

## The Value of z/VM for Linux and VSE

- **Increased performance, growth and scalability**
  - ▶ Server consolidation enables horizontal growth
  - ▶ Three-tier architecture on two tiers of hardware
  - ▶ Extensive support for sharing resources
  - ▶ Virtual networking
  - ▶ Complete isolation of Linux images if required
- **Increased productivity**
  - ▶ Development and testing
  - ▶ Production support
- **Improved operations**
  - ▶ Backup and recovery
  - ▶ Command and control

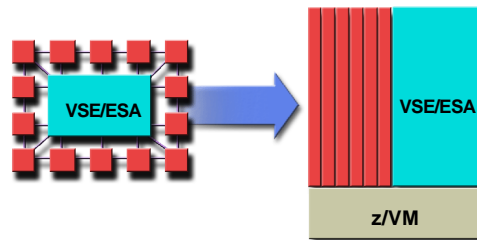





## How customers are using Linux for S/390 *Consolidation of servers*

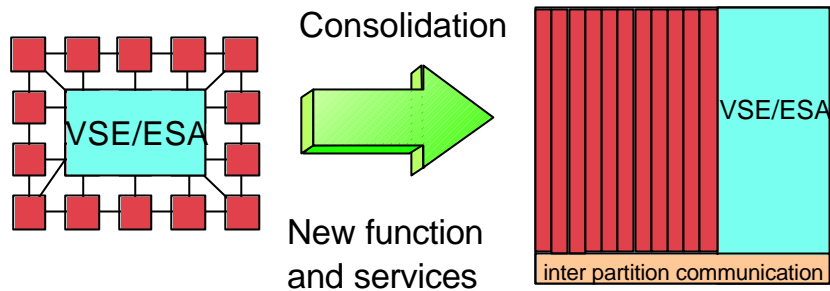

In VM and VSE environments, Linux provides:

- A wide range of applications not available on VM/ESA or VSE/ESA
- The ability to leverage existing applications and data in e-business scenarios

S/390 provides Linux with

- Fast connection to VSE/ESA managed data
- Reliability and availability
- An economical alternative to stand alone servers

## Consolidation with "Free" Middleware

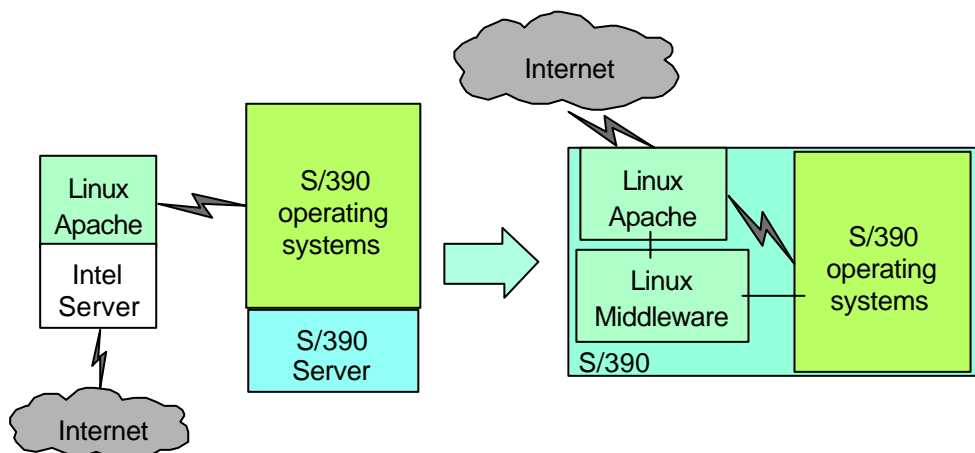

- Integrated e-commerce server
- High speed access to corporate data
- Classic strengths of S/390
- Integration of diverse workloads

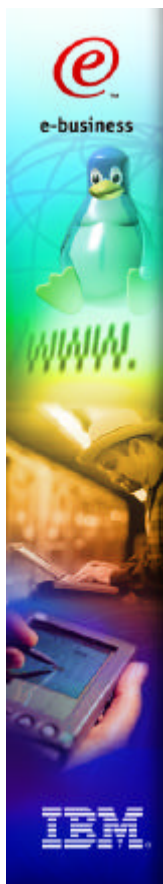



## "Free" Middleware ...

- **Development tools**
  - ▶ Editors (Emacs, vi, GNOME editor ...)
  - ▶ Documentation tools (tcl, LaTeX, postscript)
  - ▶ Compilers (gcc, gpp, Perl, Python, Regina REXX)
  - ▶ Diagnostic, test, performance tools
  - ▶ Debuggers, test coverage, monitors
  - ▶ Maintenance tools (configuration, release management)
- **Networking**
  - ▶ Apache webserver (including PHP3 scripting)
  - ▶ DHCP client/server
  - ▶ FTP
  - ▶ Telnet
  - ▶ NFS
  - ▶ openLDAP
  - ▶ Pluggable Authentication Methods (PAM)
  - ▶ openSSL



## "Free" Middleware

- **SAMBA - File/Print Serving**  
including web browser based administration

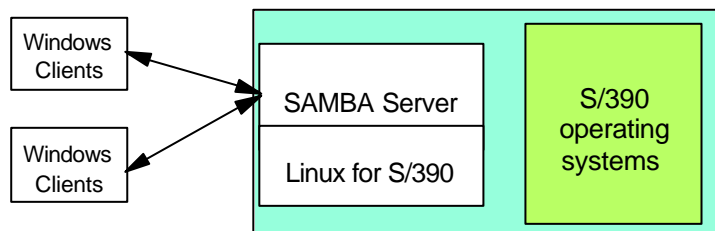

- **Electronic mail**
  - ▶ IMAP4, POP2, POP3 mail servers
  - ▶ Postfix mail program
  - ▶ Procmail
  - ▶ Sendmail



# Server Consolidation



web server,  
file/print servers

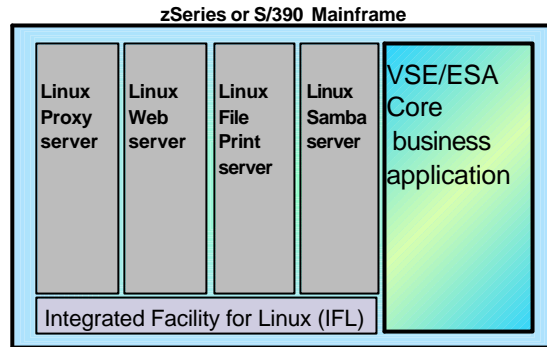
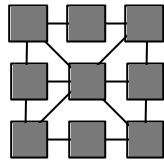

# How customers are using Linux for S/390 *Enhancing their S/390 investment*

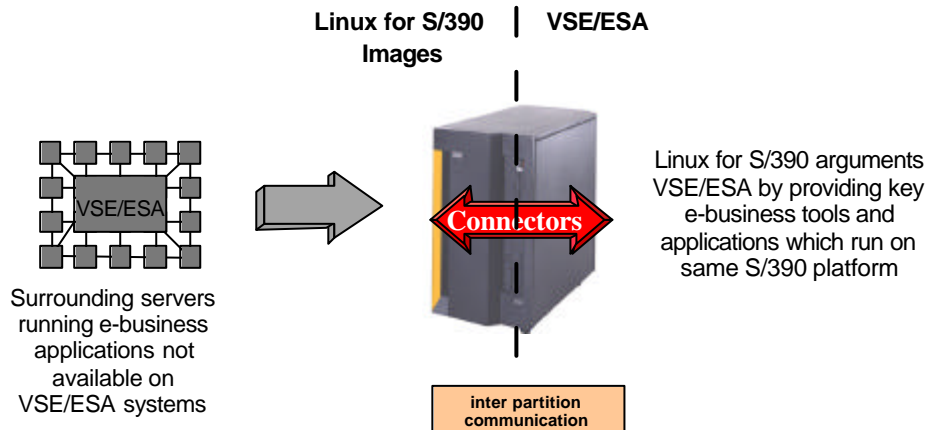

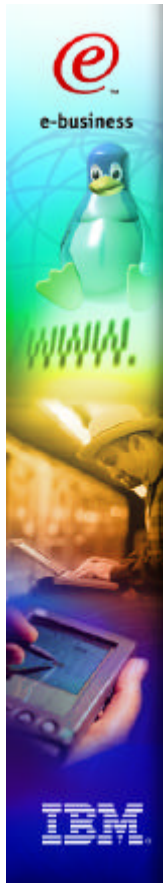

## VSE/ESA Hybrid Strategy

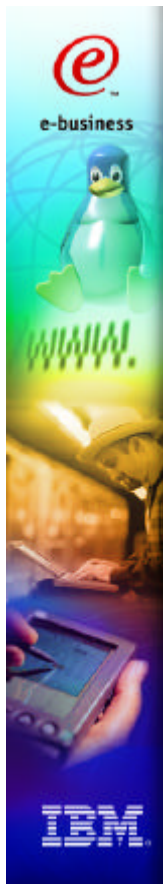
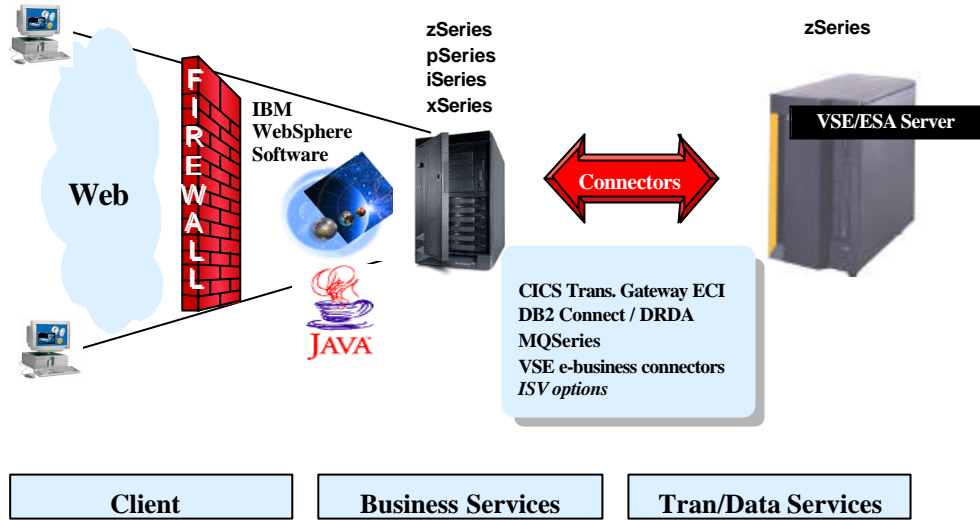

## Linux: 3-tier logical / 3-tier physical

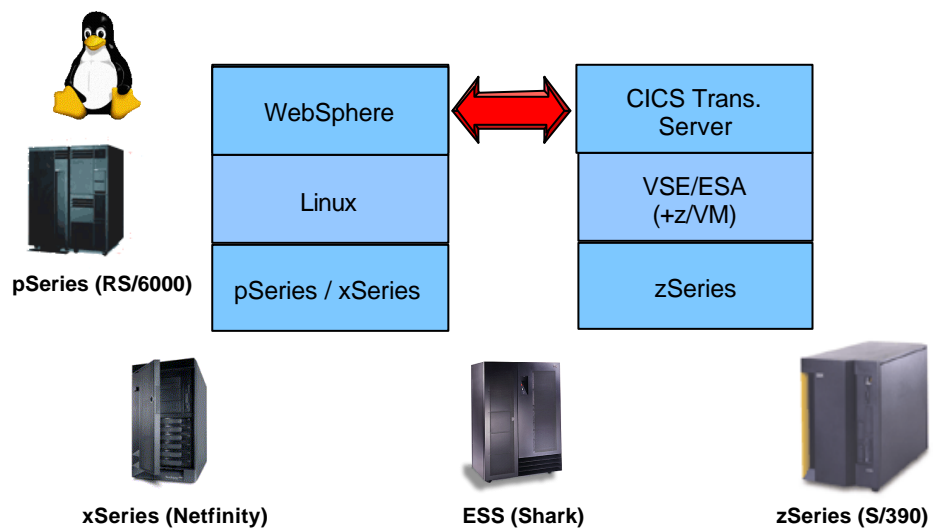



## Linux on zSeries: 3-tier logical / 2-tier physical

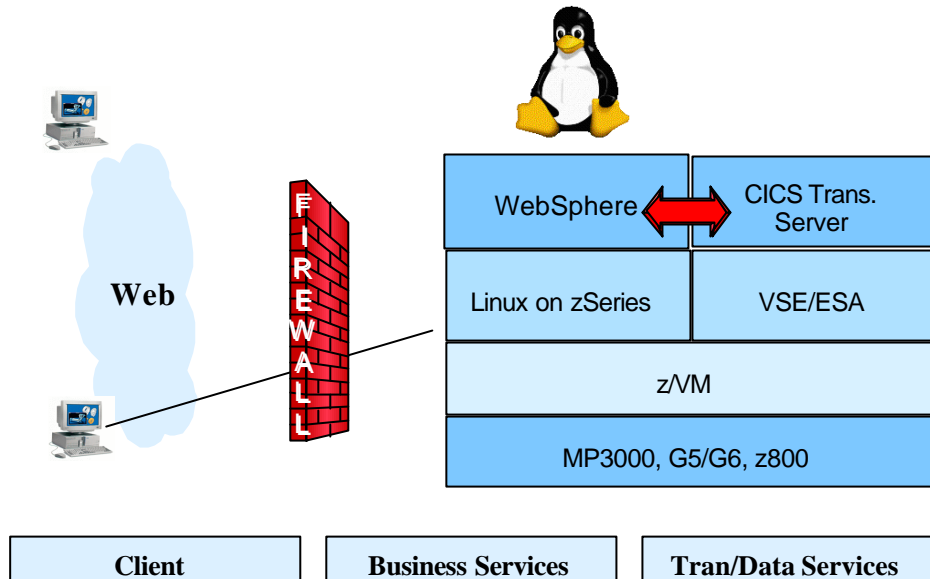

## Middleware for 3-tier logical Model

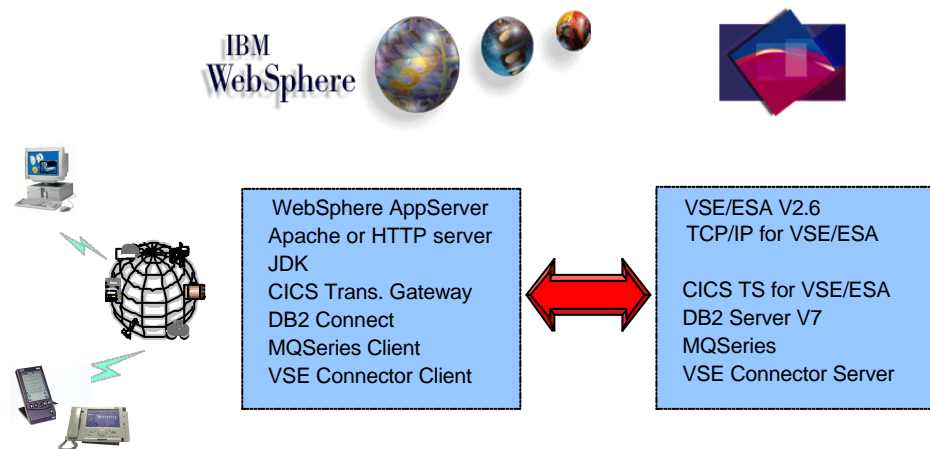



## IBM Middleware for Linux for zSeries

- **Connectors**
  - ▶ DB2 Connect, Version 7.1
  - ▶ MQSeries client, Version 5.2
  - ▶ CICS Transaction Gateway, Version 4.0
  - ▶ IMS Connect, Version 7
- **WebSphere Family**
  - ▶ WebSphere Application Server Advanced Edition, 4.0
  - ▶ WebSphere Personalization, Version 3.5
  - ▶ WebSphere Commerce Suite, Version 5.1
  - ▶ WebSphere Host on Demand, Version 5.0.3
- **Data Management**
  - ▶ DB2 Universal Database, Version 7.2
  - ▶ DB2 Intelligent Miner Scoring, Version 7.1
  - ▶ DB2 Net Search Extender, Version 7.2
- **Tivoli**
  - ▶ Storage Manager Client 4.2
  - ▶ Tivoli Enterprise Console 3.7.1
  - ▶ Tivoli Software Distribution 4.0
  - ▶ Tivoli Distributed Monitoring 4.1
  - ▶ Tivoli Workload Scheduler 8.1

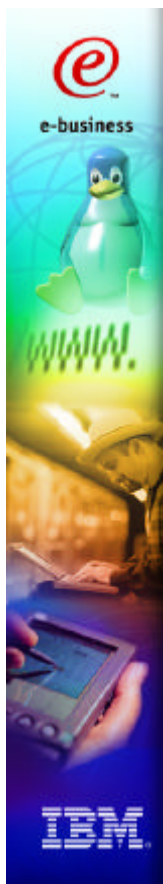

## Linux Middleware relations to VSE/ESA

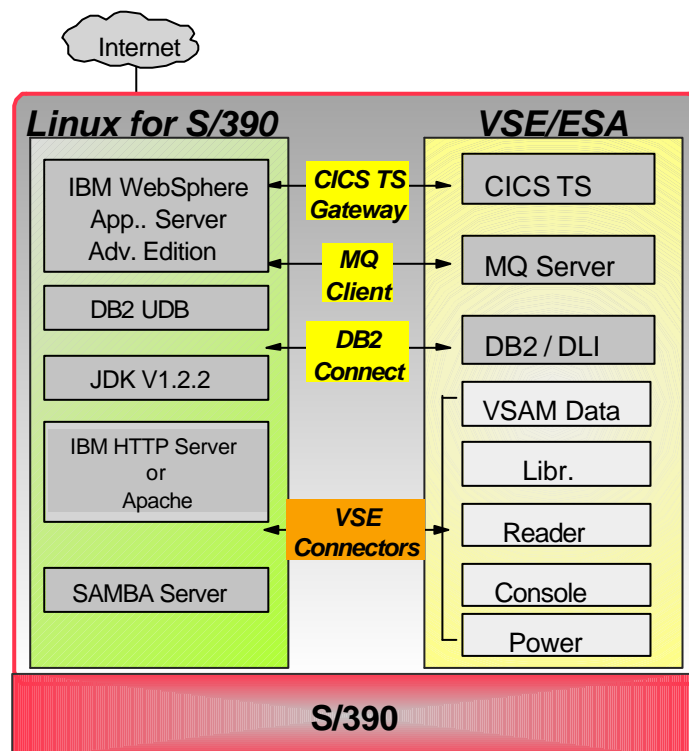



## VSE/ESA connectors

- **VSE/ESA V2.5/2.6 - VSE as server**
  - ▶ remote access to VSE data
    - e-business connectors
- **VSE/ESA V2.6 - VSE as a client**
  - ▶ **VSE initiates remote communications**
    - VSAM redirector
    - Virtual tape support
    - AUTOFTP (TCP/IP function)
    - AUTOEMAIL (TCP/IP function)

VSE/ESA V2.5/2.6

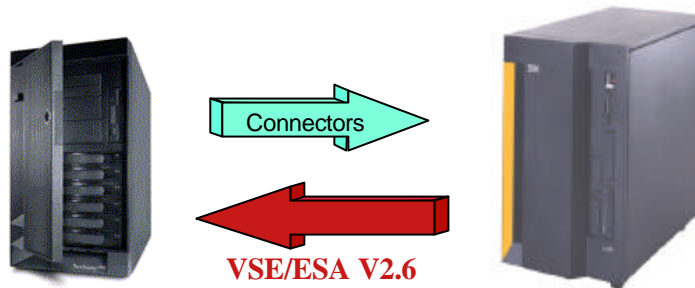

## VSE/ESA Connectors to Linux

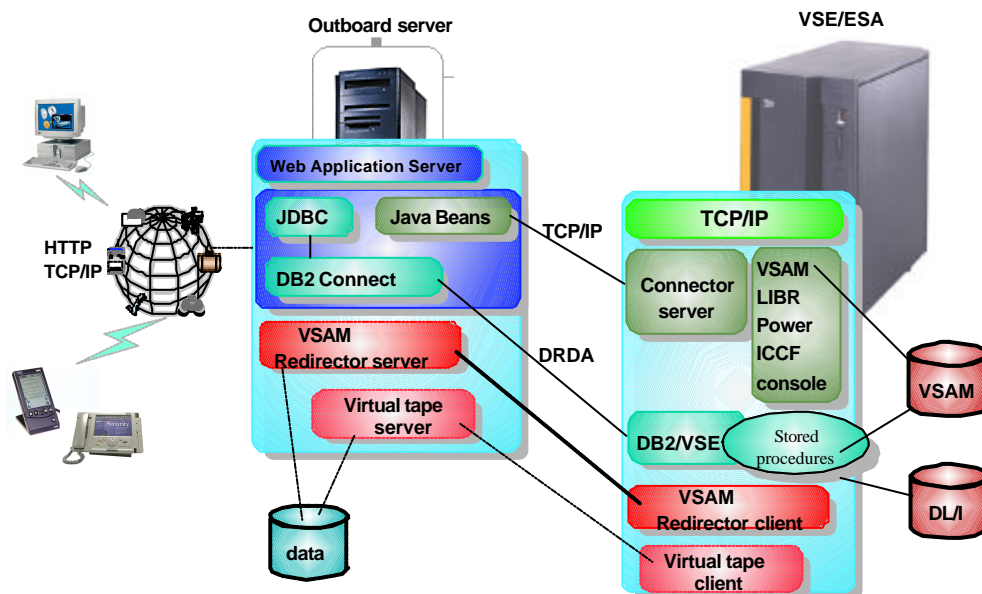

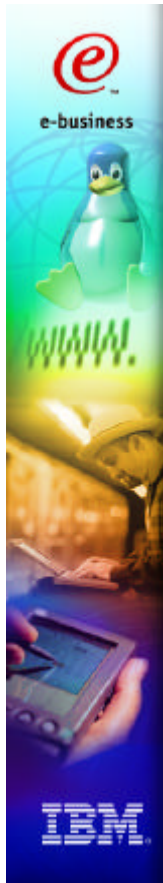

## IBM WebSphere Application Model

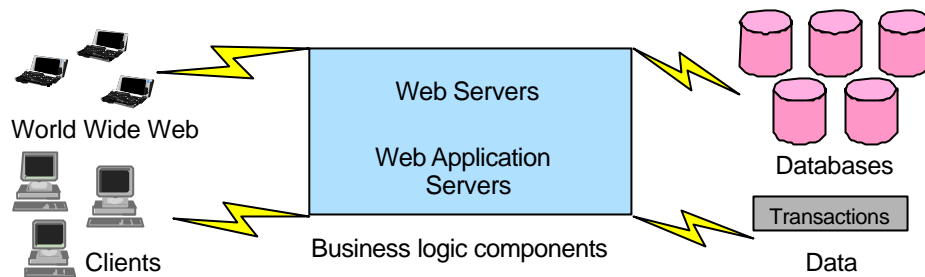

- **Web application server manages applications at 2nd tier of a 3-tier model**
- **Application deployment environment (Web standards)**
- **Tight enterprise integration and cooperation**
  - ▶ Use data from back-end systems (databases, transaction systems)
  - ▶ Provides output to Web browsers on a client
- **Infrastructure services (security, scalability, ...)**

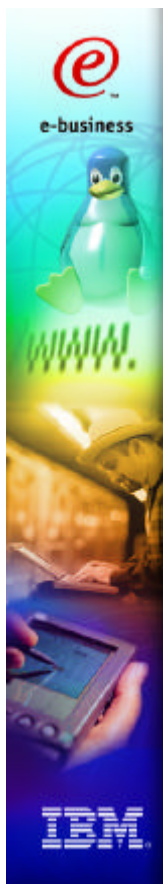

## VSE Integration Solutions with Linux

### ■ **Standard Connectors**

- ▶ **CICS Transaction Gateway**
  - integration of web transactions with VSE/ESA programs
  - Web Application Server interaction with CICS TS on VSE/ESA
  - Access to VSE data via CICS transactions
- ▶ **DB2 Connect**
  - integration of DB2 on Linux with DB2 VSE

**VSE is an excellent back-end system partner**



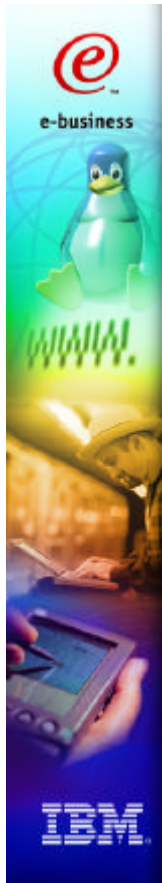

## VSE Integration Solutions with Linux

### VSE Connectors

- VSE Navigator - file manager for VSE resources
- Console automation with JConVSE (Java console interface for VSE)
- interaction with console - reaction on messages
- VSEPrint - automatic transformation/print of VSE LIST or PUNCH output
- dynamic job creation, submission and reaction on results or interpretation of job output
- real time access to VSE data (VSAM, Library) - no network inhibitor - HiperSockets
- JDBC driver for VSAM - full integration in WebSphere development and deployment tools
- **No Network inhibitor anymore - HiperSockets in VSE/ESA 2.7 (preannounced 02/2002)**

VSE is an excellent back-end system partner



## VSE Integration Solutions with Linux

- VSAM redirector - VSE programs generate automatic HTML output or transparently accesses DB2 UDB on Linux
- Virtual tape support, tape can be a Linux file and integrated in Tivoly recovery processes
- automatic e-mail generation based on a VSE event (POWER LIST or PUNCH entry)
- automatic FTP from VSE, to Linux

VSE is an excellent back-end system partner

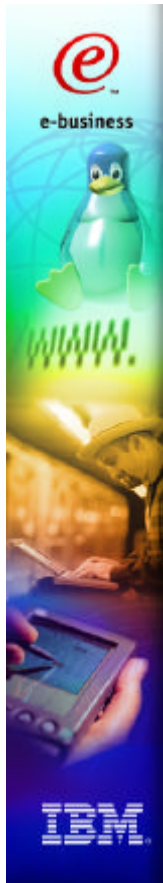

# VSE Navigator (100% pure Java application)

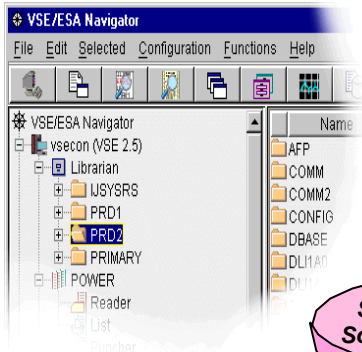

**JAVA**

- VSE Connector Client
- Java Runtime (JRE)
- VSE Navigator



**VSE/ESA**

- TCP/IP
- VSE Connector Server



- ☛ A VSE/ESA graphical user interface for VSE/ESA using the Java-Based Connectors
- ☛ remote monitoring and supervisor functions

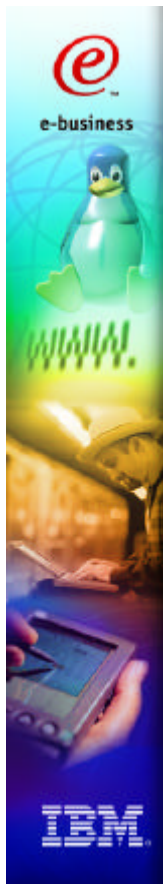

# Sample: JDataMig

*From VSE/ESA data to Front-end Tools*

user views

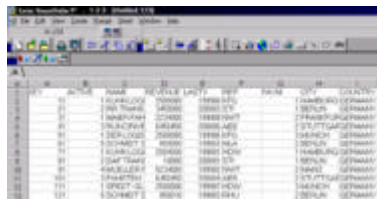

Lotus 1-2-3

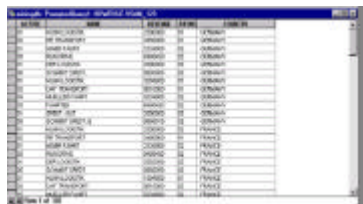

DB2 & QMF

**JAVA**

- DB2 UDB V7
- VSE Connector Client
- JDK 1.1.8
- JDataMig



**VSE/ESA**

- VSAM
- TCP/IP
- VSE Connector Server

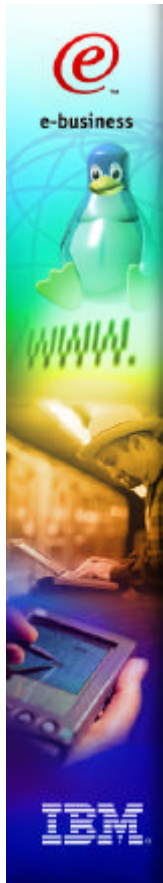

## Java-based Console support for VSE/ESA

The screenshot shows the JConVSE interface with the following data table:

| AR | 0015 | SPACE | AREA   | V-SIZE  | QRTVIS | V-ADDR  | UNUSED | NAME        |
|----|------|-------|--------|---------|--------|---------|--------|-------------|
| AR | 0015 | 5     | SUP    | 664K    |        | 0       |        | 11ASSUPX    |
| AR | 0015 | 3     | SVA-24 | 1684K   | 1748K  | AS000   |        | OK          |
| AR | 0015 | 0     | P6 V   | 1280K   | 4864K  | 400000  | 45056K |             |
| AR | 0015 | 1     | P1 V   | 1024K   | 1024K  | 400000  |        | OK P0MSTART |
| AR | 0015 | 2     | P2 V   | 2048K   | 49152K | 400000  |        | OK CICSICCF |
| AR | 0015 | 3     | P3 V   | 600K    | 14760K | 400000  |        | OK VTAMSTRT |
| AR | 0015 | 4     | P4 V   | 2048K   | 18432K | 400000  |        | OK DB2START |
| AR | 0015 | 5     | P5 V   | 768K    | 256K   | 400000  |        | OK          |
| AR | 0015 | 6     | P6 V   | 256K    | 256K   | 400000  |        | OK          |
| AR | 0015 | 7     | P7 V   | 1024K   | 10456K | 400000  |        | OK TCPSTART |
| AR | 0015 | 8     | P8 V   | 2048K   | 49152K | 400000  |        |             |
| AR | 0015 | 9     | P9 V   | 256K    | 256K   | 400000  |        |             |
| AR | 0015 | A     | PA V   | 256K    | 256K   | 400000  |        |             |
| AR | 0015 | B     | PB V   | 256K    | 256K   | 400000  |        |             |
| AR | 0015 | S     | SVA-31 | 7156K   | 7180K  | 3600000 |        |             |
| AR | 0015 |       | DYN-PA | 16384K  |        |         |        |             |
| AR | 0015 |       | DSPACE | 5472K   |        |         |        |             |
| AR | 0015 |       | SYSTEM | 1088K   |        |         |        |             |
| AR | 0015 |       | AVAIL  | 38976K  |        |         |        |             |
| AR | 0015 |       | TOTAL  | 270336K |        |         |        |             |
| AR | 0015 | 11401 | READY  |         |        |         |        |             |

## VSEPrint Tool using AUTOFTP and AUTOEMAIL functions

### VSE Print - Tool

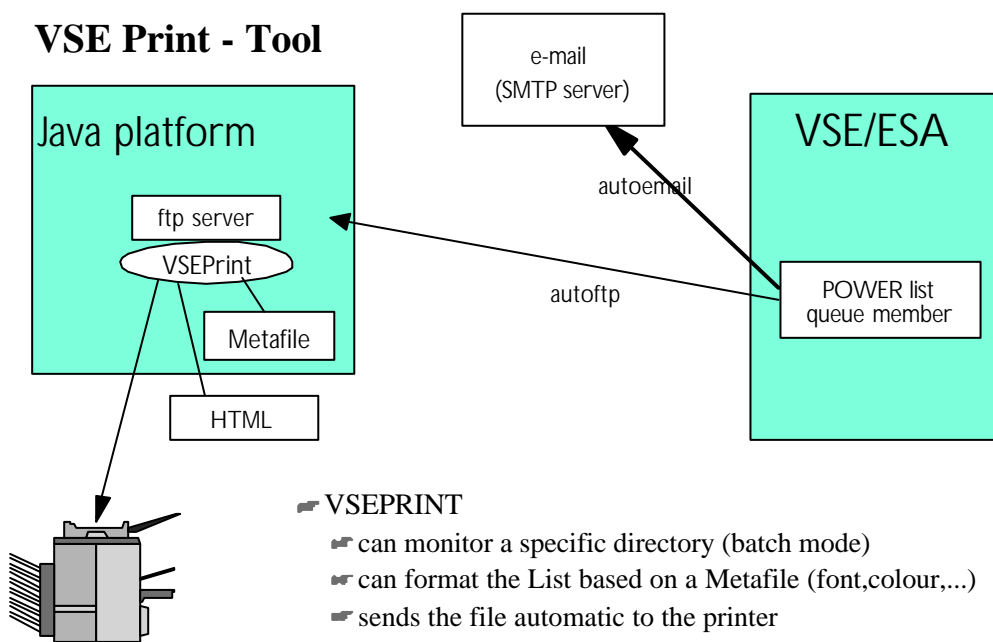

#### ☛ VSEPRINT

- ☛ can monitor a specific directory (batch mode)
- ☛ can format the List based on a Metafile (font, colour,...)
- ☛ sends the file automatic to the printer

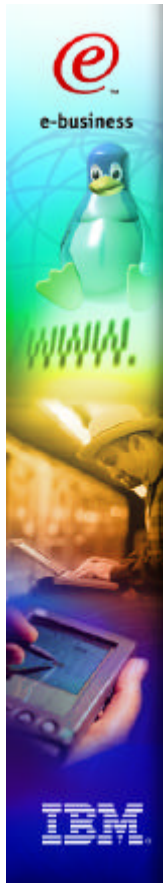

## Overview Components

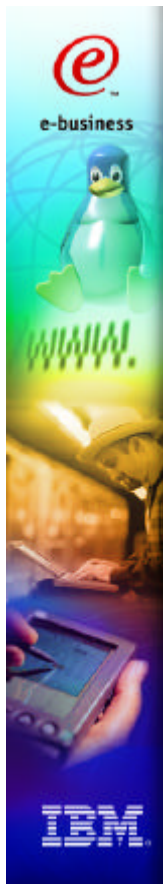
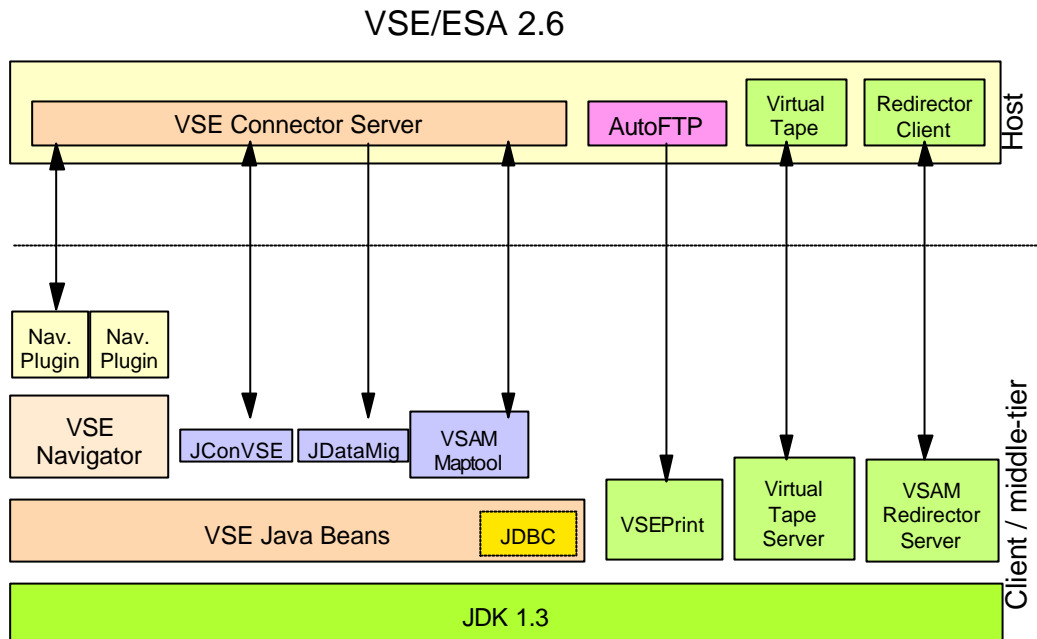

## ISV Software for Linux

- **ACTS**
  - ▶ Testing tools
- **Aeonware**
  - ▶ B2B/B2C
- **BMC Software**
  - ▶ Systems management
- **Bynari**
  - ▶ Mail and calendar server
- **Computer Associates**
  - ▶ Systems management
- **Compuware**
  - ▶ Systems management
- **Dignus**
  - ▶ Development tools
- **Intercope**
  - ▶ Fax server
- **Logics Software**
  - ▶ Development tools
- **Macro4**
  - ▶ Print server
- **Rational Software**
  - ▶ Development tools
- **Rogue Wave Software**
  - ▶ Development tools
- **RTS Realtime Systems**
  - ▶ Stock tracking
- **SAP**
  - ▶ ERP
- **Sendmail**
  - ▶ Mail server
- **Software AG**
  - ▶ XML Database

Note: This is only a partial list of ISV software available for Linux for S/390 and zSeries. For more information check [ibm.com/eserver/zseries/solutions/s390da/linuxproduct.html](http://ibm.com/eserver/zseries/solutions/s390da/linuxproduct.html)



## Customer Scenario 1

### Integration of CICS Transactions with the web

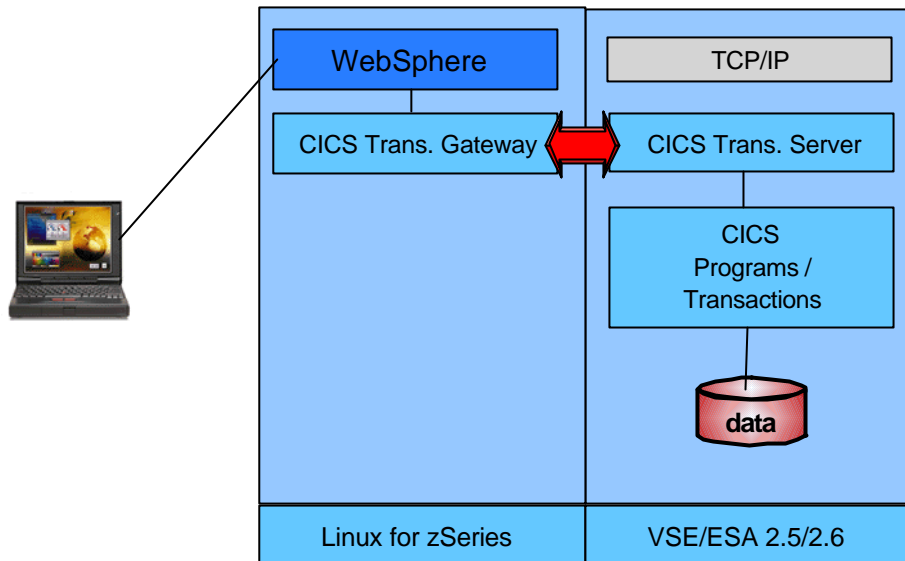

- Access to VSE CICS Programs and Transactions via Internet
- Transaction security
- high level of data integration to web pages (data - can be all accessible data via CICS, including DB2)
- high level integration in web transactions



## Customer Scenario 2

### Integration of VSAM data with the web

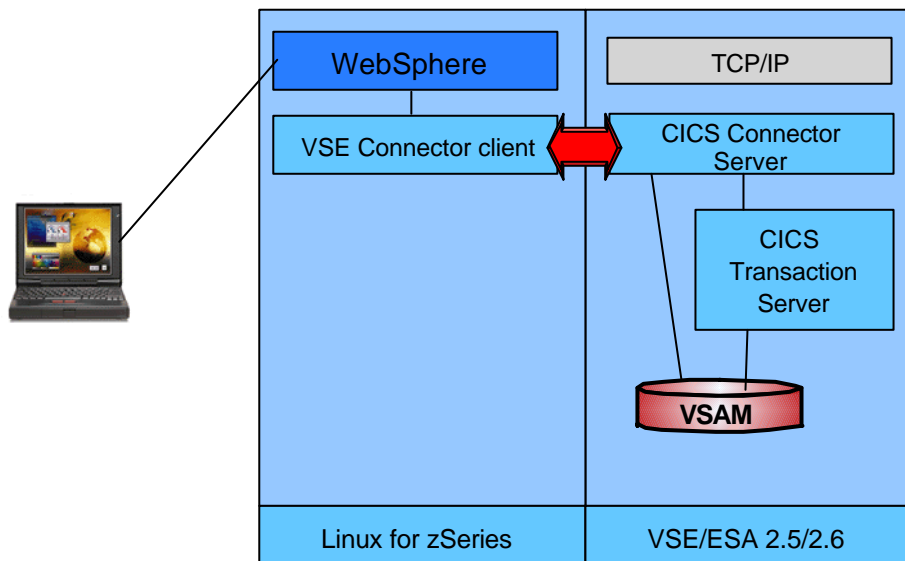

- Access to VSE VSAM data via Internet
- real time access from Internet via Websphere application server
- read in batch mode and update via CICS (avoid shareoption 4)
- high level of data integration



## Customer Scenario 3

### Integration of DB2 UDB with DB2 VSE

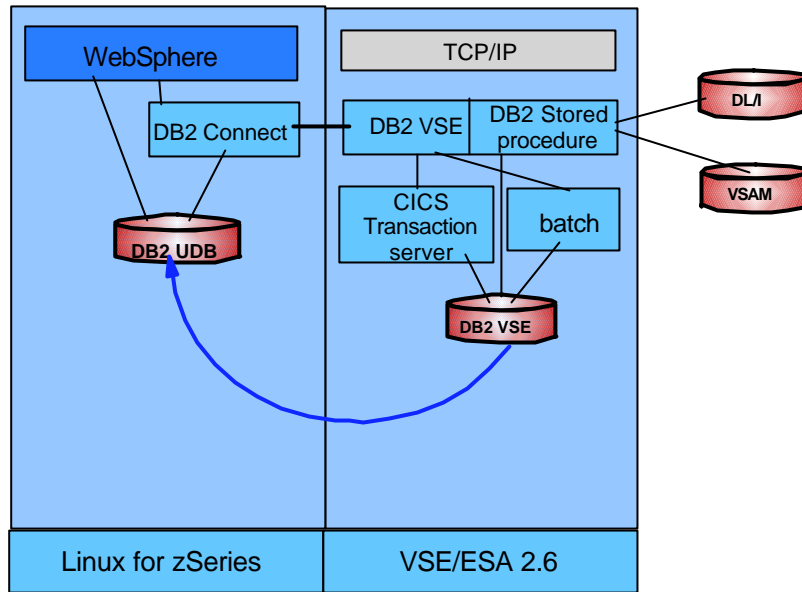

- ▶ access to DB2 VSE from internet via Websphere and DB2 Connect
- ▶ integrate non DB2 data into DB2 logic via Stored procedures
- ▶ access of DB2 UDB on Linux via DB2 VSE using DB2 client on VSE.



## Customer Scenario 4

### Integration of DB2 UDB with VSE programs

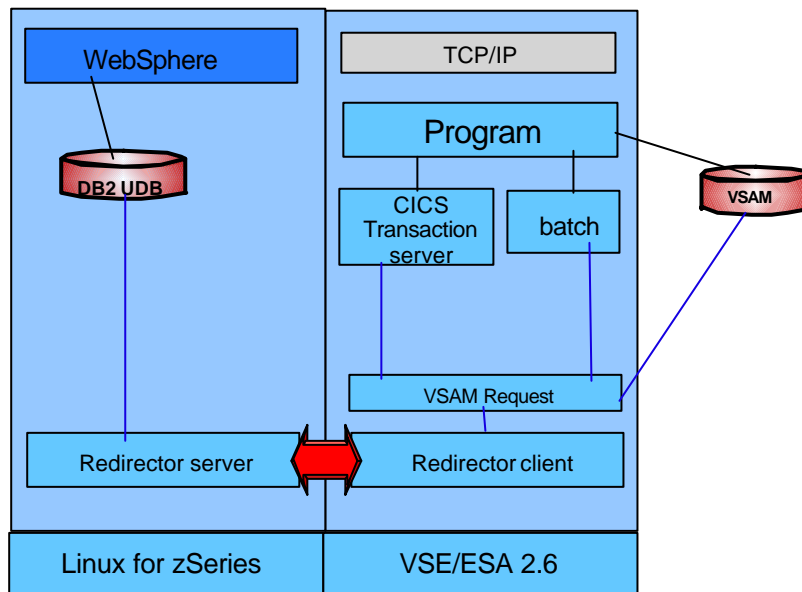

- ▶ access to DB2 VSE from internet via Websphere and DB2 Connect
- ▶ access of DB2 UDB on Linux via DB2 VSE
- ▶ synchronize DB2 UDB on Linux with VSAM data from VSE programs. Use of VSAM Redirector



## Customer Scenario 5 Integration of batch processes with the web

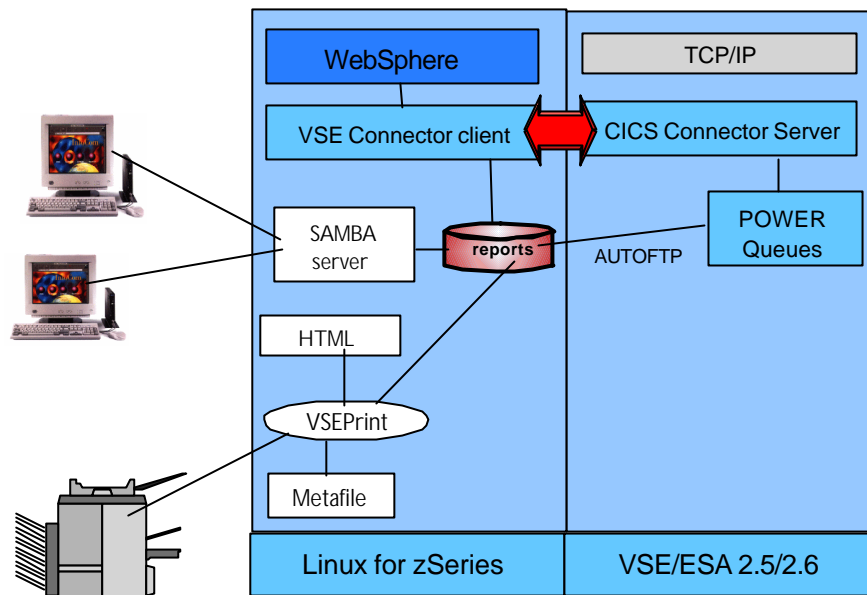

- access to VSE Power Queues via internet
- dynamic generated jobs via Websphere Technologies
- transfer of job output (reaction of job results)
- VSEPRINT- VSE tool for data formatting

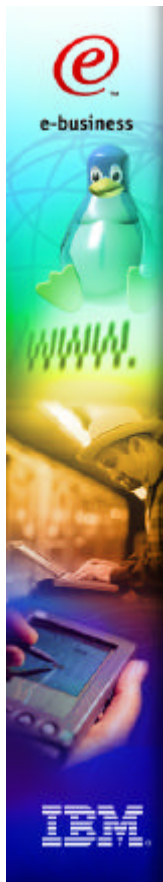

## Conclusions

### ■ Why run Linux on a S/390 ?

- **Reliability**
  - The most reliable hardware platform available. Period.
  - Over 35 years of constant improvements
- **Scalability**
  - 15 Linux images possible on native hardware (LPAR)
  - Virtually unlimited Linux images possible with VM/ESA
- **Manageability**
  - Centralized Linux systems easier to manage / duplicate
  - Use management functions from S/390 operating systems for Linux (e.g. backup, autostart, etc.)

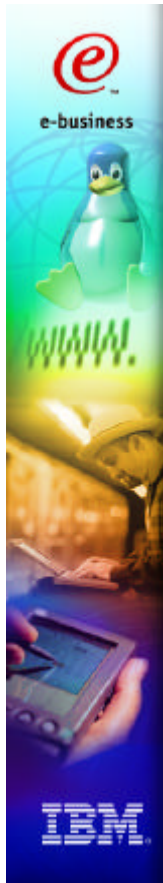

## Linux for S/390 and zSeries A new Option for VSE/ESA

- Value for VSE/ESA
  - ▶ 3-tier e-business model can be implemented in physical 2-tier
  - ▶ Easy access to new applications included in Linux distributions (e.g. Apache, Samba, Java, ...)
  - ▶ Access to a wide range of standard business solutions and their
  - ▶ integration with VSE/ESA data via [VSE e-business connectors](#)
  - ▶ Minimized network latency between Linux for S/390 and VSE/ESA

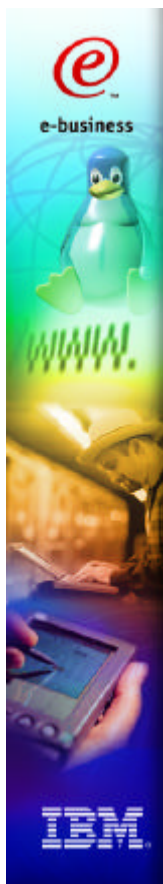

## Some Important Web Sites

|                                    |  |
|------------------------------------|--|
| IBM Linux                          | <a href="http://ibm.com/linux">ibm.com/linux</a>   |
| IBM zSeries                        | <a href="http://ibm.com/zseries">ibm.com/zseries</a>   |
| IBM Linux on zSeries               | <a href="http://ibm.com/eserver/zseries/linux">ibm.com/eserver/zseries/linux</a>                     |
| IBM VSE/ESA                        | <a href="http://ibm.com/eserver/zseries/os/vse/">ibm.com/eserver/zseries/os/vse/</a>                 |
| IBM z/VM                           | <a href="http://ibm.com/eserver/zseries/zvm">ibm.com/eserver/zseries/zvm</a>                         |
| Red Hat                            | <a href="http://www.redhat.com">www.redhat.com</a>   |
| SuSE                               | <a href="http://www.suse.com">www.suse.com</a>   |
| Turbolinux                         | <a href="http://www.turbolinux.com">www.turbolinux.com</a>   |
| Linux for zSeries discussion group | <a href="http://www.marist.edu/htbin/wlvindex?linux-390">www.marist.edu/htbin/wlvindex?linux-390</a> |



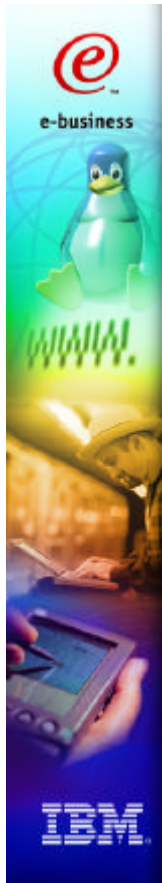

## IBM Redbooks

- *e-business Intelligence: Leveraging DB2 for Linux on S/390*, SG24-5687-00, Redbook published 2001-07-25
- *Linux for zSeries and S/390: Distributions*, SG24-6264-00, Redbook published on 2001-09-20
- *Linux for zSeries and S/390: ISP/ASP Solutions*, SG24-6299
- *CICS Transaction Server for VSE/ESA : CICS Web Support*, SG24-5997-00
- *e-business Connectivity for VSE/ESA*, SG24-5950-00
- *Getting Started with TCP/IP for VSE/ESA 1.4*, SG24-5626
- *e-business Solutions for VSE/ESA*, SG24-5662
- **For more information:** [ibm.com/redbooks](http://ibm.com/redbooks)



## References (*continued*)

- "An Introduction to Linux"
  - Neale Ferguson
  - <http://pucc.princeton.edu/~neale/index.htm>
- "Java, threads, and scheduling in Linux"
  - IBM
  - <http://www-4.ibm.com/software/developer/library/java2/index.html>
- "Linux on the System/390"
  - Adam Thornton
  - <http://www.linux390.com/>
- "Linux for Big Iron"
  - User community Linux/VM Project
  - <http://www.linuxvm.org/>

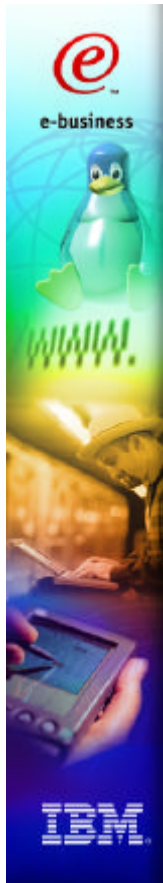

## References (*continued*)

- "Linux on Big Iron"
  - ▶ open source IT
  - ▶ [http://www.opensourceit.com/tools/000327\\_mainframe.html](http://www.opensourceit.com/tools/000327_mainframe.html)
  
- "IBM Unveils Way to Make Mainframes Act Like Hundreds of Smaller Servers"
  - ▶ Bloomberg (Technology News)
  - ▶ <http://www.bloomberg.com/bbn/technology.html>
  
- "IBM kicks off Linux developer program for its S/390 mainframes"
  - ▶ InfoWorld
  - ▶ <http://www.infoworld.com/articles/pi/xml/00/03/31/000331piibmlinux.xml>
  
- "Has the Linux 'dream machine' arrived?"
  - ▶ ZDNet News
  - ▶ <http://www.zdnet.com/zdnn/stories/news/0,4586,2491800,00.html>

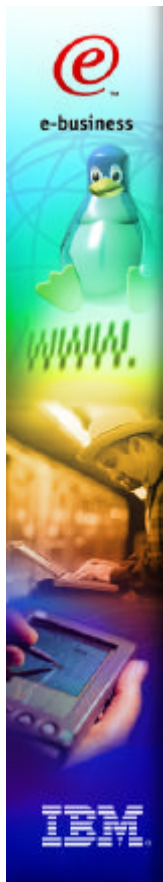

Have fun !

