



L51

IBM Middleware on IBM System z

Ingolf Salm

IBM
SYSTEM z9 AND zSERIES EXPO
October 9 - 13, 2006

Orlando, FL

Trademarks

The following are trademarks of the International Business Machines Corporation in the United States and / or other countries.

CICS*	IBM*	VSE/ESA
Cloudscape	IBM logo*	VTAM*
DB2*	Informix	WebSphere*
DB2 Connect	IMS	iSeries
DB2 Universal Database	Multiprise*	pSeries
e-business logo*	MQSeries*	xSeries
Enterprise Storage Server	OS/390*	IBM System z
HiperSockets	S/390*	z/Architecture
		z/OS
		z/VM
		z/VSE
		zSeries

* Registered trademarks of IBM Corporation

The following are trademarks or registered trademarks of other companies.

LINUX is a registered trademark of Linus Torvalds

Java and all Java-related trademarks and logos are trademarks of Sun Microsystems, Inc., in the United States and other countries

UNIX is a registered trademark of The Open Group in the United States and other countries.

Microsoft, Windows and Windows XP are registered trademarks of Microsoft Corporation.

SET and Secure Electronic Transaction are trademarks owned by SET Secure Electronic Transaction LLC.

Intel is a registered trademark of Intel Corporation.

Agenda

- Distributions
- IBM WebSphere Family
- Connectors
- IBM Databases
- IBM Domino Server
- IBM Communication Server
- IBM Tivoli System Management

Distributions

- Distributors provide 31 bit as well as 64 bit distributions
 - 2.4 kernel based distributions
 - SUSE Linux Enterprise Server 8 (SLES 8 – United Linux 1.0)
 - Latest level: SLES 8 SP 4
 - Red Hat Enterprise Linux Advanced Server 3 (RHEL AS 3)
 - Latest level: RHEL AS 3 Update 8
 - 2.6 kernel based distribution
 - SUSE Linux Enterprise Server 9 (SLES 9)
 - Latest level: SLES 9 SP 3
 - SUSE Linux Enterprise Server 10 (SLES 10)
 - Red Hat Enterprise Linux Advanced Server 4 (RHEL AS 4)
 - Latest Level: RHEL AS 4 Update 4

IBM WebSphere Family

- IBM WebSphere Application Server
- IBM WebSphere Commerce Suite
- IBM WebSphere Portal for Multiplatforms
- IBM WebSphere Host on Demand
- IBM WebSphere MQ

IBM Developer Kit for Linux (Java 2 Technology Edition)

- Provides Java development and runtime environment, including the Just-In-Time (JIT) compiler
- Most current levels (for 31 and 64 bit)
 - J2SE 1.3.1
 - J2SE 1.4.2
 - J2SE 5.0
- <http://www-128.ibm.com/developerworks/java/jdk/linux/tested.html>

IBM WebSphere Application Server

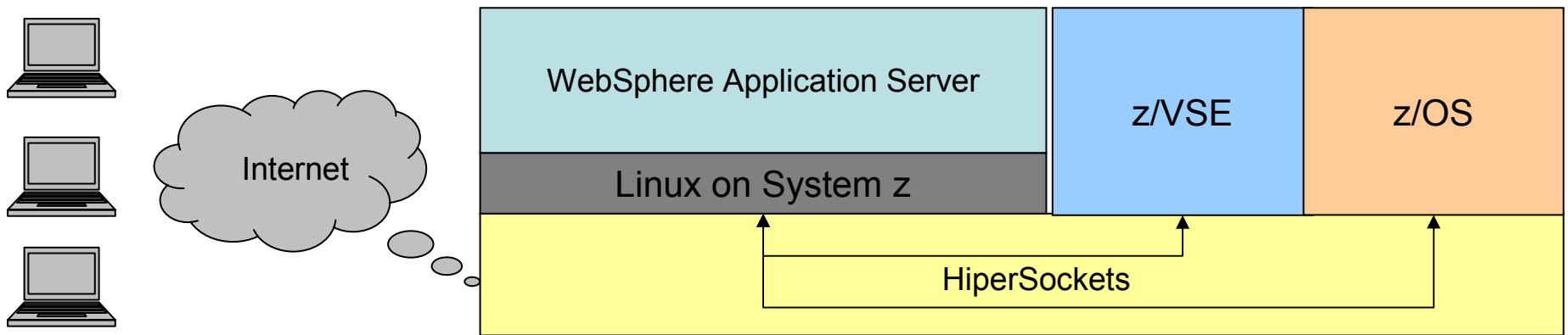

Web
Browsers /
Clients

- Web application servers
 - Manage applications at the 2nd tier of a 3-tier model
 - Based on web standards
 - Provide infrastructure services (security, scalability, ...)
 - Allow tight enterprise integration and cooperation
 - interacts with web browsers
 - use data from back-end systems (databases, transaction systems)

IBM WebSphere Application Server V6.1

- Multiple configurations (Network Deployment, ...)
- Offers a J2EE platform for e-business applications
- Supports the J2EE connector architecture to integrate back end servers
- Connection manager to manage connectors
- Support for Java Server Pages (JSP), servlets, XML server tools for dynamic e-business applications, web services
- Enterprise Java Bean (EJB) based connectivity
- Support of new web (service) standards
- www.ibm.com/software/webservers/appserv/was

IBM WebSphere Business Integration Server Foundation V5.1 for multiplatforms

- Builds on WebSphere Application Server (WAS) to provide J2EE and web services technology based platform for deploying web services solutions (within a service oriented architecture)
- Provides J2EE programming model extensions
- Provides common event infrastructure for exchange of network, system, business events
- Includes WAS Network Deployment and its functions such as
 - Enhanced workload and performance management
 - Provides load balancing and cluster capabilities across multiple servers
 - Reports and analyzes problems
 - Tight integration with IBM Tivoli Access Manager (centralized security)
- Includes IBM Directory Server, IBM WebSphere MQ, ...
- www.ibm.com/software/integration/wbisf/

IBM WebSphere Commerce Business Edition 5.6

- Provides services to deploy commerce applications and helps to build, maintain and manage stores to sell goods and services on the web
- WebSphere Application Server based (supports J2EE standards)
- Consists of commerce server, WAS, DB2 UDB, payment server, ...
- WebSphere Commerce provides
 - Guided selling (interactive product catalog)
 - Catalog management tooling
 - Order, payment management
 - Integration (e.g. via connectors)
 - Customer help / care
 - Analytics and business intelligence (data mining models)
 - Reporting (on sales, traffic)
 - System management (administrations, monitoring)
 - Web services for external systems
 - Business to business functionality
 - Business to business store model
 - Additional payment types
 - Advanced user management and access control
- www.ibm.com/software/webservers/commerce

IBM WebSphere Portal V6.0

- Provides single point of interaction with dynamic information, applications, processes and people for e-business environments
- Enables you to implement scalable portals that simplify and speed a user's access to personalized information and applications
- WebSphere Application Server based
- Portal Enable
 - Base offering with personalization, content publishing, document management, portal framework
- Portal Extend
 - Adds extended search and web analysis features
- www.ibm.com/software/genservers/portal/server/

IBM WebSphere Host on Demand V9

- Available as the IBM Host Access Client Package for Multiplatform
- Secure access to host applications and data from Java enabled web browsers
 - Secure access across the internet (SSL based)
- Access to zSeries applications and other platforms
- Centralized deployment and administration
- Allows access to multiple hosts concurrently
- Installs on Linux server simplifying, distribution and upgrades
- Requires no middle-tier servers, gives improved scalability
- www.ibm.com/software/webservers/hostondemand
- See also IBM WebSphere Host Access Transformation Services 6.0
 - 3270 and 5250 applications as HTML to web browsers
 - www.ibm.com/software/webservers/hats

IBM WebSphere MQ and related products

- IBM WebSphere MQ 6.0
 - Exchange information across different platforms
 - Supports most major platforms
 - For synchronous and asynchronous communication
 - Integrate existing business applications
 - Provides security options
 - Assures reliable delivery of messages
 - www.ibm.com/software/integration/wmq
- IBM WebSphere Business Integration Event Broker for Multiplatforms V5
 - Allows for the handling of high message volumes and large number of endpoints
 - Enables and controls the distribution of messages based on message topic or content
 - Separation of message routing logic from applications
 - www.ibm.com/software/integration/wbieventbroker/v5/multiplatforms.html
- IBM WebSphere MQ Everyplace 2.0
 - Provides messaging infrastructure to connect e-business applications with small / mobile devices
 - www.ibm.com/software/integration/wmqe

Connectors

- DB2 Connect
 - www.ibm.com/software/data/db2/db2connect
- CICS Transaction Gateway V6.0
 - www.ibm.com/software/http/cics/connectors
- IMS Connector for Java 2.1
 - www.ibm.com/software/data/db2imstools/imsjavcon.html
- Informix Connect
 - <http://www-306.ibm.com/software/data/informix/tools/connect/>

Connectors ...

- WebSphere MQ
 - www.ibm.com/software/integration/wmq
- WebSphere MQ Client for VSE
- WebSphere Service Bus V6.0.1
 - enables development of SOA
 - Connectivity infrastructure for integration of applications and services
- z/VSE e-business Connectors
 - www.ibm.com/vse/support/vseconn

z/VSE e-business Connectors

- Provide easy access to z/VSE resources from other systems
- z/VSE e-business connectors include
 - Server code running on z/VSE
 - Java beans, servlets and samples on Java capable clients
 - Access to VSAM, DL/I, POWER, ICCF, Librarian, VSE console
- TCP/IP based communication
- Advantages
 - Exploitation of non-VSE e-business infrastructure
 - Always newest e-business components
 - z/VSE resources can be easily integrated into new e-business applications
- www.ibm.com/vse/support/vseconn

Connectors ...

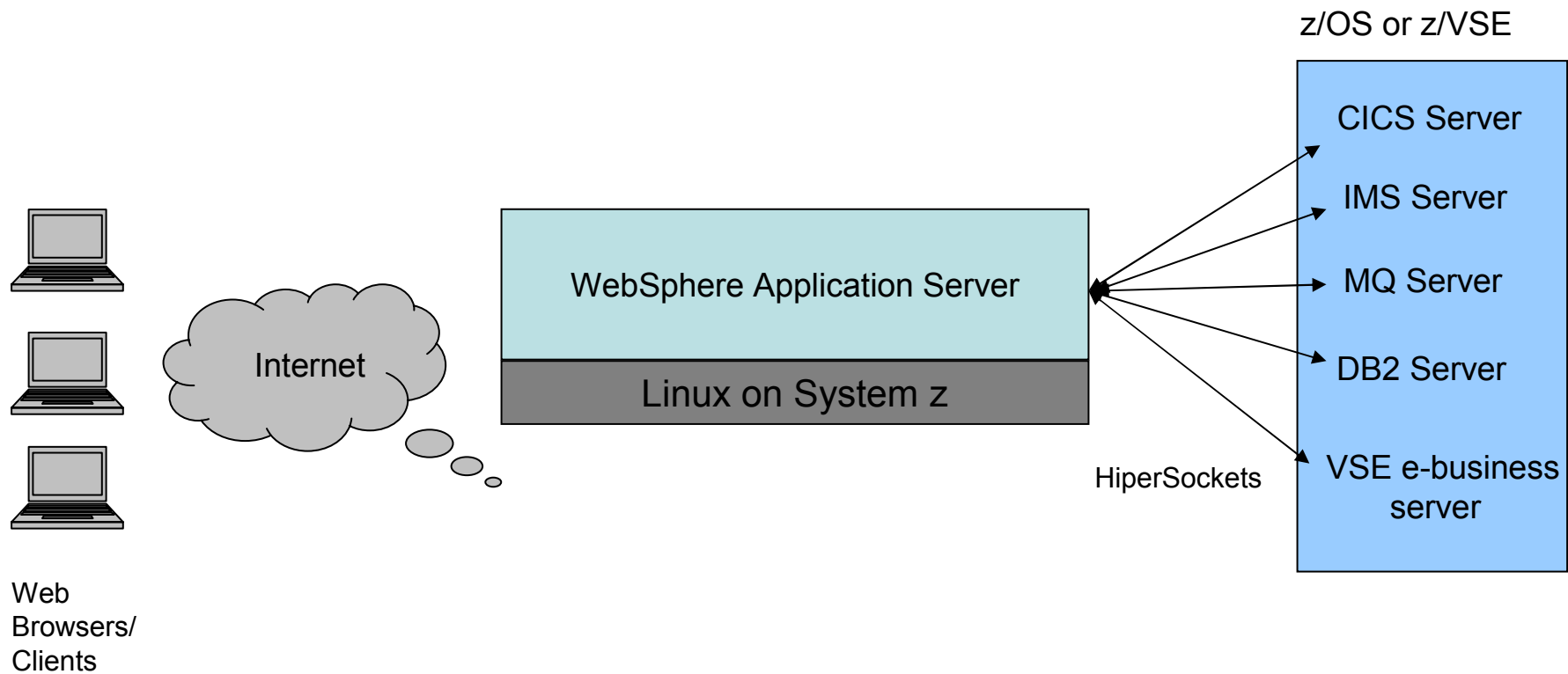

IBM Databases, Extenders and Tools

- IBM DB2 Universal Database (DB2 UDB) 8.2
 - 31 bit and 64 bit database
 - DB2 Connect 8.2
 - DB2 Intelligent Miner Modeling / Scoring
 - DB2 Net Search Extender
 - DB2 Spatial Extender
 - To store, manage and analyze spatial data
 - DB2 Net.data
 - Scripting language
 - DB2 Data Archive Expert for Multiplatform 2.1
 - DB2 Performance Expert for Multiplatforms 2.2
- IBM Informix Dynamic Server V10.0
 - 64 bit database
- IBM Cloudscape V10
 - Small database, can be imbedded into Java programs
 - www.ibm.com/software/data/cloudscape

DB2 Universal Database 8.2

- 31 bit and 64 bit database, 2.4 and 2.6 kernel support
- Supports open standards like SQL, Java, ODBC, ...
- Supports C, C++ programming languages for stored procedures, local and client/server applications
- Policy based administration and maintenance (backup)
- Backup command to backup disk
- DB2 Connect provides connectivity to non-local DB2 servers
 - Allows integration of backend data
- www.ibm.com/software/data/db2/linux

IBM DB2 Example

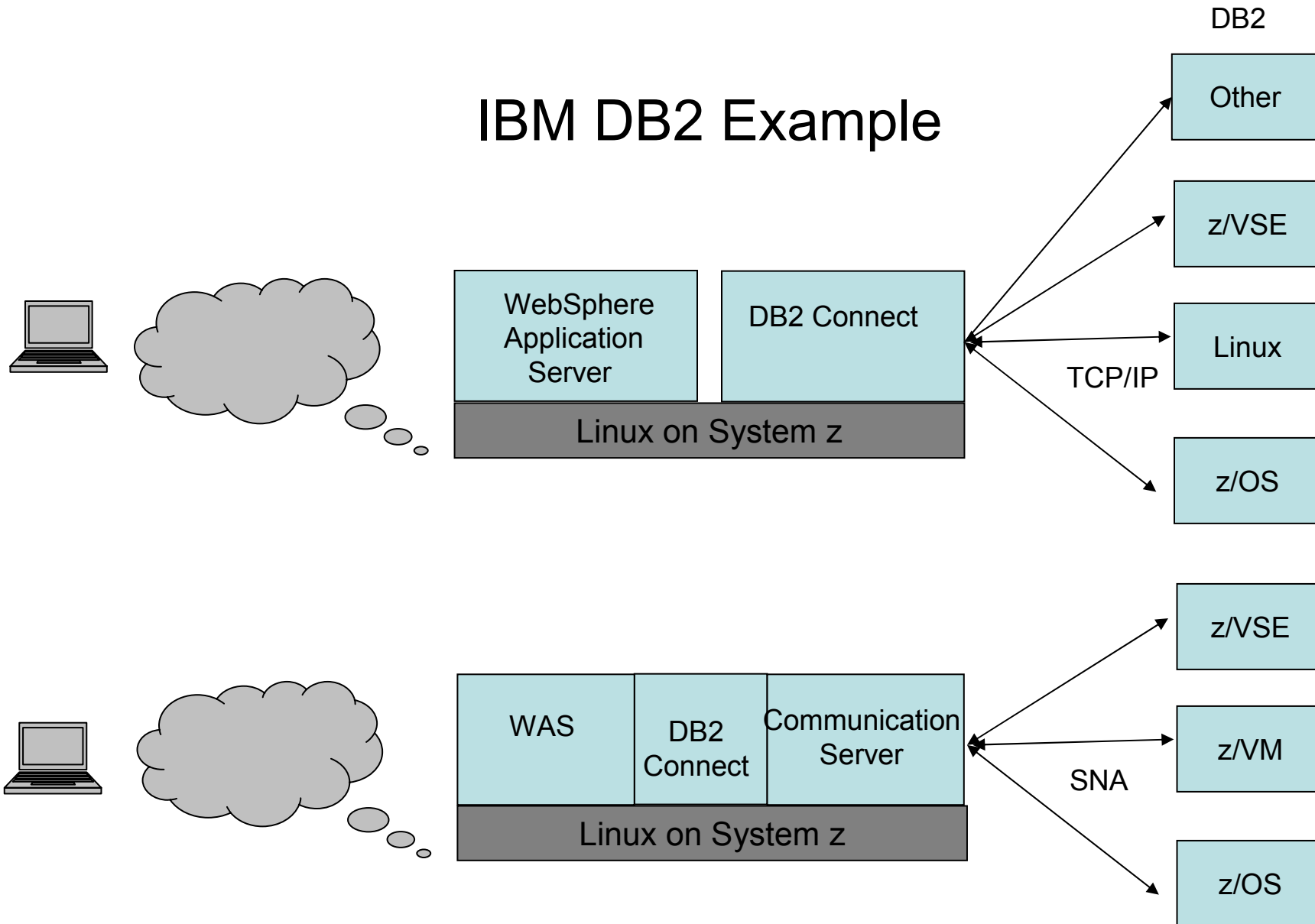

IBM DB2 Example

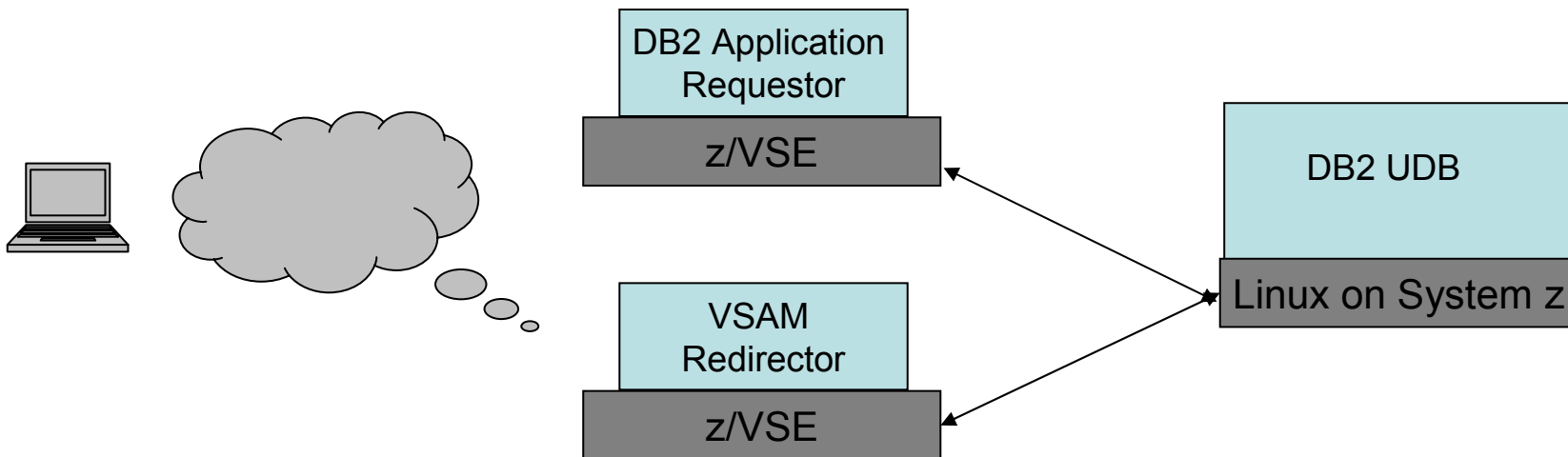

DB2 Intelligent Miner

- DB2 Intelligent Miner Scoring
 - Enables users to deploy data mining analytics in real time
 - Key functions:
 - Easy-to-use data mining tool
 - Provides infrastructure necessary to deploy data mining analytics in enterprise applications
 - Manages the promotion of data mining models
 - Provides XML based language for modeling
 - SQL used as programming interface
- DB2 Intelligent Miner Modeling
 - Discover hidden relationship between data without export to other platform
 - SQL extension to DB2 database
 - Enables modeling function for inclusion into applications
 - Supports development of data mining models
- DB2 Intelligent Miner Visualization
 - Java based results browser
 - To view and evaluate the results of the data mining modeling process
- www.ibm.com/software/data/iminer

DB2 Net Search Extender

- Fast full text retrieval to Java and DB2 command line or control center interface
- Key benefits:
 - Fast indexing of very large data volumes in DB2 or Informix IDS databases
 - Searching high speed with large number of concurrent users
 - Storing presorted table columns in main memory at indexing time to avoid expensive database access and paging at search time
- www.ibm.com/software/db2/extenders/netsearch

IBM DB2 Content Manager on Demand for Multiplatforms V8.3

- Solution for enterprise report management (ERM)
- Enables high volume capture of computer output and archiving of scanned documents
- Automatic distribution of selected reports and documents to authorized users
- Supports electronic bill and payment solutions
- <http://www-306.ibm.com/software/data/ondemand/mp/>

IBM Informix Dynamic Server V10.0

- 64 bit database
- Provides enhancements in
 - Availability and reliability enhancements
 - Query optimization, performance
 - Column level encryption
 - Administrative enhancements
 - Improved programmer productivity
 - Exploitation of Linux 2.6 kernel features
- Informix Connect for client applications to access Informix servers
- Available tools
 - Informix Server Administrator (ISA) 1.6
 - Browser based administration, HTML output
 - Monitors multiple servers from one web site
 - Informix Client Software Development Kit (CSDK) 2.9
 - Provides APIs for Informix applications
 - Supported language: Java, C, C++, ...
 - Informix 4GL
 - 4GL development tool, compiler, interactive debugger
 - Informix Java Database Connectivity (JDBC) V3.0
- www.ibm.com/software/data/informix/linux4zs

IBM Lotus Domino 7.0.1

- Provides messaging and collaboration services
- Web access or access from Notes client to server platform
- Policy based administration
- Security features included
- Failover and load balancing
- Logging, statistics, diagnostics, ...
- Anti-spam features
- IBM Lotus Domino Web Access: web client
- www.lotus.com/products/product4.nsf/wdocs/dominohomepage

Rational

- Rational ClearCase V6.0
 - Provides life cycle management and control of software development assets
 - Version control
 - Parallel development support
 - Build and release management
 - Local, remote, web interfaces
 - <http://www.ibm.com/software/awdtools/clearcase/index.html>
- VisualAge Generator EGL Plug-in for VSE
 - Plugin to generate programs using the Enterprise Generation Language (EGL) component of Rational Application Developer
 - To develop and generate COBOL applications for z/VSE
 - <http://www.ibm.com/software/awdtools/visgen/vse/index.html>

IBM Communication Server for Linux on System z V6.2.2

- Connects across diverse networks
- Supports multiple protocols (APPN, Enterprise Extender, HiperSockets)
- Secure access to SNA applications through TCP/IP clients
 - Supports SSL authentication and encryption
 - Secure TN3270 server
- Application programming support
- Common programming interface for communications
- Configuration, administration, installation options
- Problem determination system management
- www.ibm.com/software/network/commserver/z_lin

IBM Communication Server for Linux on System z V6.2.2

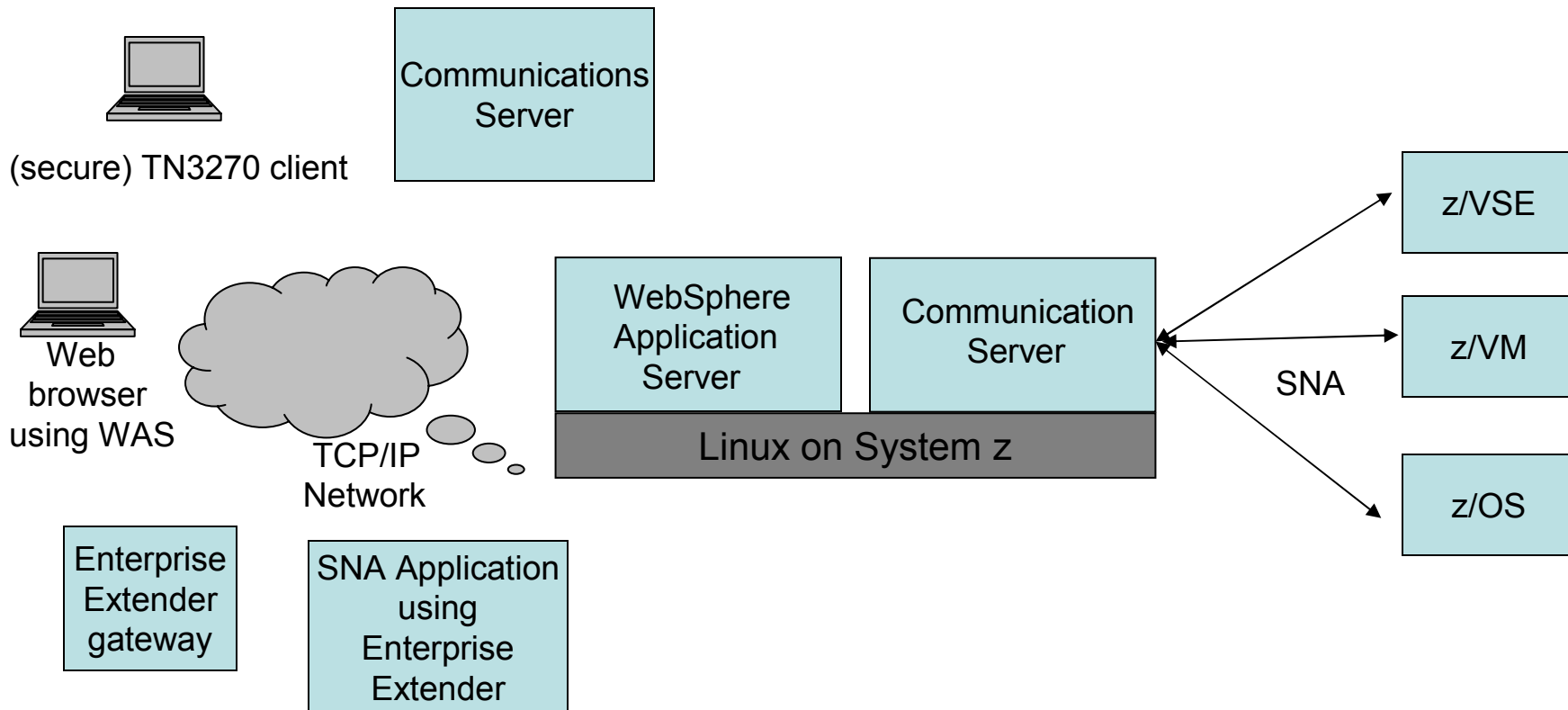

IBM Communication Controller for Linux on System z

- Consolidates function from 37xx communication controller (emulates 3745 comm. Controllers)
- Provides ease of migration of stable NCP software (NCP runs on top of that emulation)
- Supports consolidation of infrastructure to an IP-based on demand environment (allows to use SNA – but communicate via TCP/IP to the internet)

IBM Tivoli System Management

- Security management
 - www.ibm.com/software/tivoli/solutions/security
- Storage management
 - www.ibm.com/software/tivoli/solutions/storage
- Performance management
 - www.ibm.com/software/tivoli/solutions/pa
- Configuration and operation
 - www.ibm.com/software/tivoli/solutions/co

Security Management

- IBM Tivoli Directory Integrator 6.0
 - Synchronizes identity data between applications and directory sources
 - Manages data across repositories providing a directory infrastructure
 - Provides event handler, parser, connectors for protocols and access
 - New: usability enhancements, PKI security support, scalability / reliability enhancements
 - www.ibm.com/software/tivoli/products/directory-integrator
- IBM Tivoli Directory Server 6.0
 - Provides Lightweight Directory Access Protocol (LDAP) identity infrastructure for identity management applications and web services
 - Supports LDAP V3
 - Based on DB2 UDB
 - Web administration GUI
 - www.ibm.com/software/tivoli/products/directory-server

Security Management ...

- IBM Tivoli Access Manager for e-business 6.0
 - Policy based access control solution for e-business/enterprise applications and data
 - Single sign-on for authorized users
 - Provides security enhancements for J2EE conforming applications (e.g. running on WebSphere Applications Server)
 - Supports IBM Tivoli Directory Server
 - www.ibm.com/software/tivoli/products/access-mgr-e-bus
- IBM Tivoli Access Manager for operating systems 6.0
 - Security locks down business-critical applications, files and operating platforms to help prevent unauthorized access
 - Blocks insiders and outsiders
 - Provides security and auditing
 - Audit events can be analyzed by the IBM Tivoli Risk Manager
 - www.ibm.com/software/tivoli/products/access-mgr-operating-sys

IBM Tivoli Access Manager Example

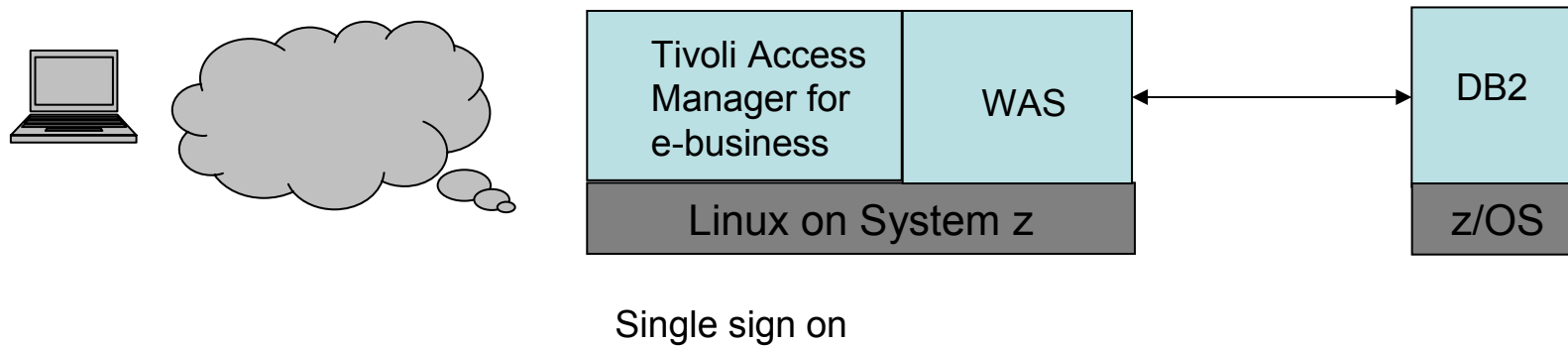
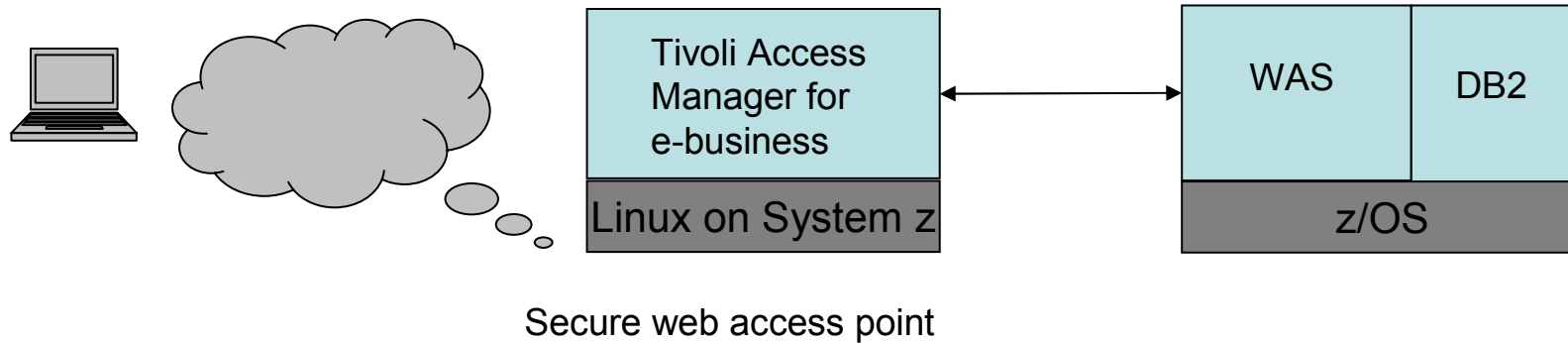

Security Management ...

- IBM Tivoli Identity Manager 2.1
 - Provides policy based identity for e-business/legacy environments
 - Web interface
 - Centralized user management
 - Supports internal audits
 - Interacts with users, identity sources and access control mechanisms
 - Simplified administration
 - www.ibm.com/software/tivoli/products/identity-mgr
- New: IBM Tivoli Federated Identity Manager 6.1
- IBM Tivoli Privacy Manager for e-business 1.2
 - Definition of new digital privacy policy, or converting an existing written policy to digital form
 - Deployment of the privacy policy to specific applications and IT systems
 - Monitor and enforce access according to the policy
 - Generates detailed audit logs
 - Generates reports automatically
 - Works with IBM Tivoli Access Manager for e-business
 - www.ibm.com/software/tivoli/products/privacy-mgr-e-bus

Security Management ...

- IBM Tivoli Risk Manager 4.2
 - Security event management product:
 - Web based application
 - Real-time Web browser-based event console, based on IBM Tivoli Enterprise Console (TEC) V3.9
 - Automated recommendations - ability to tie-in organizational security policies to specific security events
 - Enhancements to help improve performance and installation
 - Integration with IBM Tivoli Configuration Manager – ability to extract hardware and software information from the Tivoli Inventory database
 - www.ibm.com/software/tivoli/products/risk-mgr

Security Management ...

- IBM Tivoli Security Compliance Manager 5.1
 - Identifies security vulnerabilities and security policy violations
 - Helps to define consistent security policies and monitor compliance of these defined security policies
 - Centralized administration (of policy definitions)
 - Automation of security scans
 - Security vulnerability scans
 - Auditing and reporting mechanisms
 - www.ibm.com/software/tivoli/products/security-compliance-mgr

Storage Management

- IBM Tivoli Storage Manager 5.3
 - Provides services to backup / restore, archive / retrieve file servers
 - Client comes with command line and web interface
 - Provides API to access the server
 - Supports EXT2, EXT3, ReiserFS backup client (including ACLs)
 - LAN free backup
- IBM Tivoli Storage Manager for databases (e.g. DB2 UDB, Oracle)
- IBM Tivoli Storage Manager for applications
- IBM Tivoli Storage Manager for data retention
- IBM Tivoli Storage Manager for mail
- IBM Tivoli Storage Manager for Storage Area Networks
- www.ibm.com/software/tivoli/products/storage-mgr

TSM – LAN-free Backup

—→ Control flow
—→ Data flow

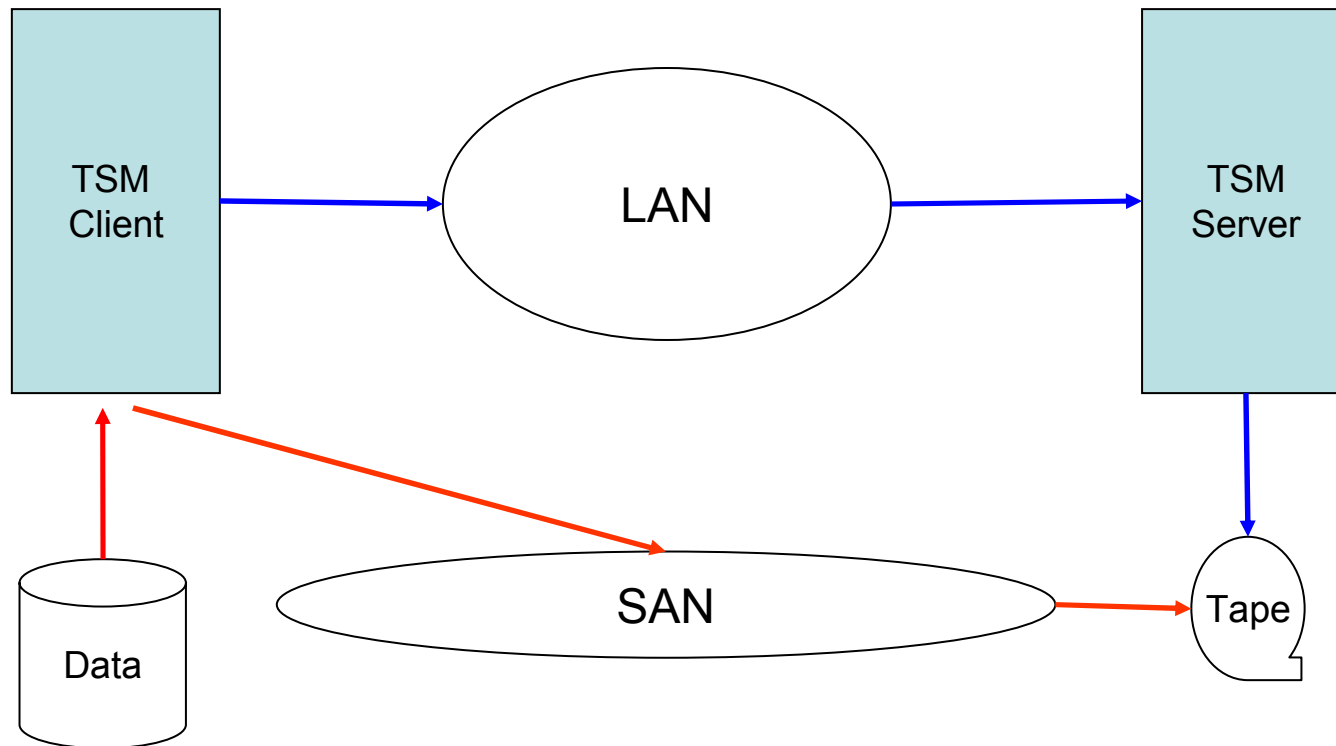

Performance and Availability Management

- IBM Tivoli Enterprise Console (TEC) 3.9
 - Automated problem diagnosis and resolution to improve system performance and reduce support cost
 - Event filtering, correlation and analysis
 - Event consolidation and display
 - www.ibm.com/software/tivoli/products/enterprise-console
- IBM Tivoli Netview 7.1.4
 - Discovers TCP/IP networks, displays network topologies, correlates and manages events and SNMP traps, monitors network health, and gathers performance data
 - Provides capabilities to manage mission-critical environments
 - Quickly identifies root cause of network failures
 - Reports on network trends and analysis
 - www.ibm.com/software/tivoli/products/monitor
- IBM Tivoli OMEGAMON XE for Linux on zSeries 1.2.0
- IBM Tivoli Switch Analyzer 1.3
 - For network management
 - Provides (layer 2) switching root cause management

Performance and Availability Management

- IBM Tivoli Monitoring 6.1
 - Provides monitoring for essential system resources
 - Detects bottlenecks and potential problems
 - Automatically recover from critical situations
 - www.ibm.com/software/tivoli/products/monitor

 - IBM Tivoli Monitoring for databases
 - IBM Tivoli Monitoring for applications
 - IBM Tivoli Monitoring for web infrastructure
 - IBM Tivoli Monitoring for transaction performance
 - IBM Tivoli Monitoring for business integration
 - IBM Tivoli Monitoring for Messaging and Collaboration: Domino
 - IBM Tivoli Monitoring for Messaging and Collaboration: Exchange

Performance and Availability Management

- IBM Tivoli System Automation for Multiplatforms 2.1
 - Manages availability of business applications by
 - Fast detection of outage through monitoring
 - Sophisticated knowledge about application components and their relationships
 - Quick and consistent recovery of failed resources and whole applications either in place or on another system in a Linux cluster
 - www.ibm.com/software/tivoli/products/sys-auto-linux

Configuration and Operation

- IBM Tivoli Configuration Manager 4.2.3
 - Provides software distribution
 - Provides hardware and software inventory capabilities in a multiplatform environment
 - Analyzes enterprise inventory
 - Automates and schedules software distribution and inventory operations
 - Monitors system and configuration changes
 - www.ibm.com/software/tivoli/products/config-mgr
- IBM Tivoli License Manager 2.1
 - Helps to achieve a total software asset management solution
 - Enables planning, management, optimization of enterprise wide software assets
 - Provides software inventory, usage monitoring, contract and reporting capabilities
 - helps organizations to efficiently manage the contractual and financial details of software contracts and agreements.
 - www.ibm.com/software/tivoli/products/license-mgr

Configuration and Operation ...

- IBM Tivoli Provisioning Manager 2.1
 - Provides provisioning and configuration support
 - Supports the cloning of manually installed Linux system images into automatically provisioned virtual machines under z/VM
 - Provides pre-build workflows for control and configuration
 - www.ibm.com/software/tivoli/products/prov-mgr
- IBM Tivoli Intelligent Orchestrator 2.1
 - Monitors applications under its control
 - Can sense degrading performance and determine why actions need to be taken
 - Can determine where a resource is needed and instruct the IBM Tivoli Provisioning Manager
 - To deploy a server, install the necessary software, ...
 - Can predict when resources will become available or needed
 - www.ibm.com/software/tivoli/products/intell-orch

Configuration and Operation ...

- IBM Tivoli Remote Control 3.8.1
 - Control (active state):
 - take control of the remote machine
 - execute commands and applications
 - Monitor (monitor state):
 - View the display of the remote workstation
 - monitor activities
 - www.ibm.com/software/tivoli/products/remote-control
- IBM Tivoli Workload Scheduler 8.2
 - Monitors and controls the flow of work
 - Remote and local

 - IBM Tivoli Workload Scheduler for applications
 - IBM Tivoli Workload Scheduler for On Demand
 - IBM Workload Scheduler for virtualized data centers
 - www.ibm.com/software/tivoli/products/scheduler

Configuration and Operation ...

- IBM Tivoli Service Level Advisor 2.1
 - Helps to create an end-to-end view of service levels
 - Automated evaluation of SLAs
 - Trend analysis
 - Alerts for SLA violations
- <http://www-306.ibm.com/software/tivoli/products/service-level-advisor/>

IBM Tivoli - Summary

- Availability
 - Ensure health and efficient functioning of IT environments
 - IBM Tivoli Monitoring
- Business service management
 - Align IT resources with critical business priorities
 - IBM Tivoli Enterprise Console, IBM Tivoli Netview, Tivoli Service Level Advisor
- Orchestration
 - Sense, trigger and respond to significant IT issues according to business goals
 - IBM Tivoli Intelligent Orchestrator
- Provisioning
 - Align the right processes with the right resources for the right people at the right time
 - IBM Tivoli Configuration Manager, IBM Tivoli License Manager, IBM Tivoli Provisioning Manager, IBM Tivoli System Automation for Multiplatforms

IBM Tivoli – Summary ...

- Security
 - Ensure confidentiality and data integrity
 - IBM Tivoli Access Manager, IBM Tivoli Directory, IBM Tivoli Directory Integrator, IBM Tivoli Identity Manager, IBM Tivoli Privacy Manager, IBM Tivoli Risk Manager, IBM Tivoli Security Compliance Manager
- Storage and optimization
 - Protect and maximize the utility and availability of data
 - IBM Tivoli Storage Manager, IBM Tivoli Workload Scheduler

More Information

- IBM software for Linux (link to IBM Linux software product matrix):
 - www.ibm.com/linux/software
- Linux at IBM: www.ibm.com/linux
- System z: www.ibm.com/zseries
- Linux on System z: www.ibm.com/zseries/linux
- z/VM: www.ibm.com/vm
- z/VSE: www.ibm.com/vse