

VSE/ESA

Navigator

z/VM, VSE, and Linux on zSeries Tech Conference
Miami Beach - Oct 7 - 10th



Wilhelm Mild

VSE/ESA Design and Development

@-business ambassador

IBM Boeblingen Laboratory



IBM @business servers. Technology. Innovation. Magic.



VSE/ESA Java-Based Connectors

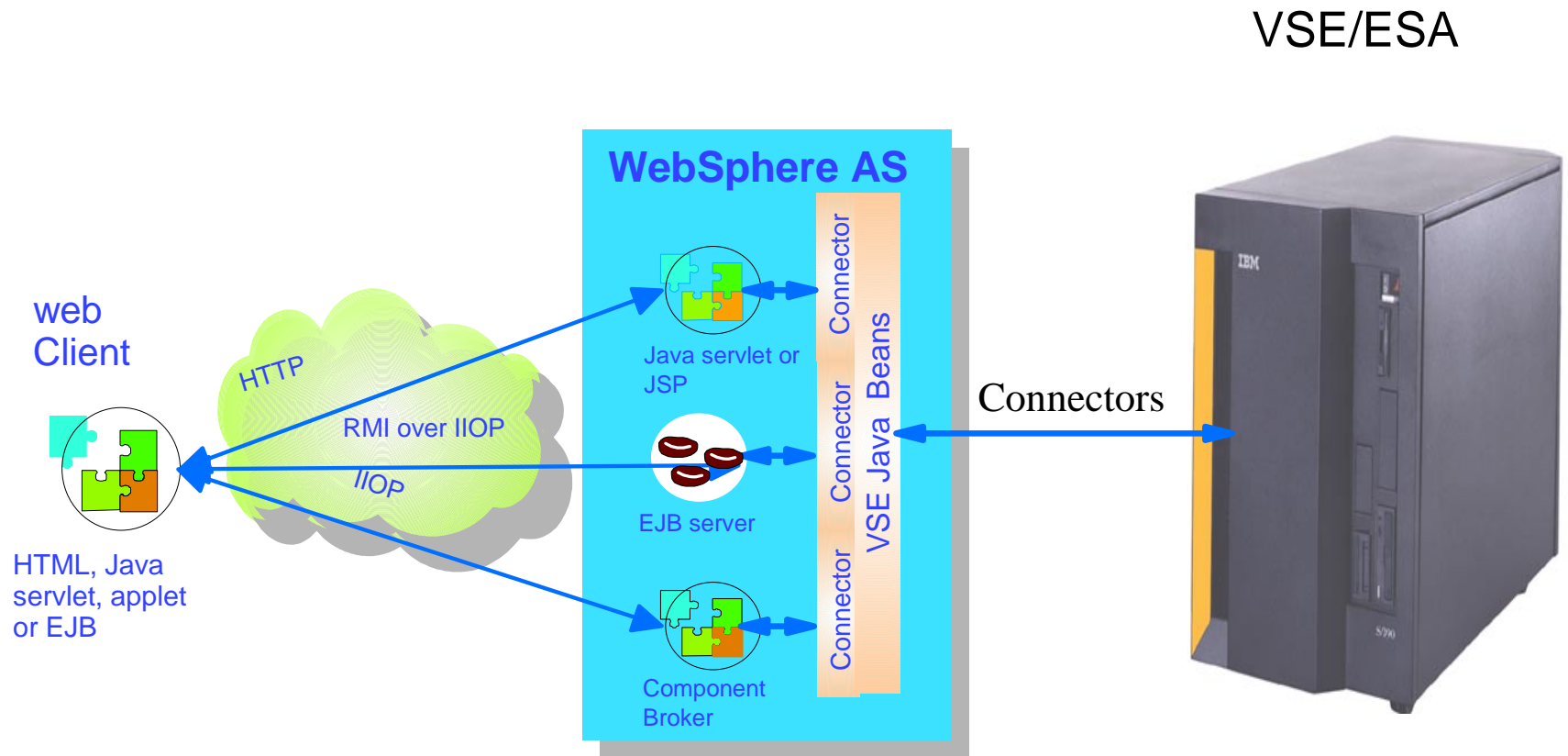

- ▶ Java access to VSE/ESA Resources.
- ▶ New possibilities for VSE/ESA.
- ▶ VSE/ESA Java beans are packaged in the **VSE/ESA 2.6 Connector client**
<http://www-1.ibm.com/servers/eserver/zseries/os/vse/support/vseconn/conmain.htm>

IBM @server. For the next generation of e-business.



Navigator uses VSE Connector client

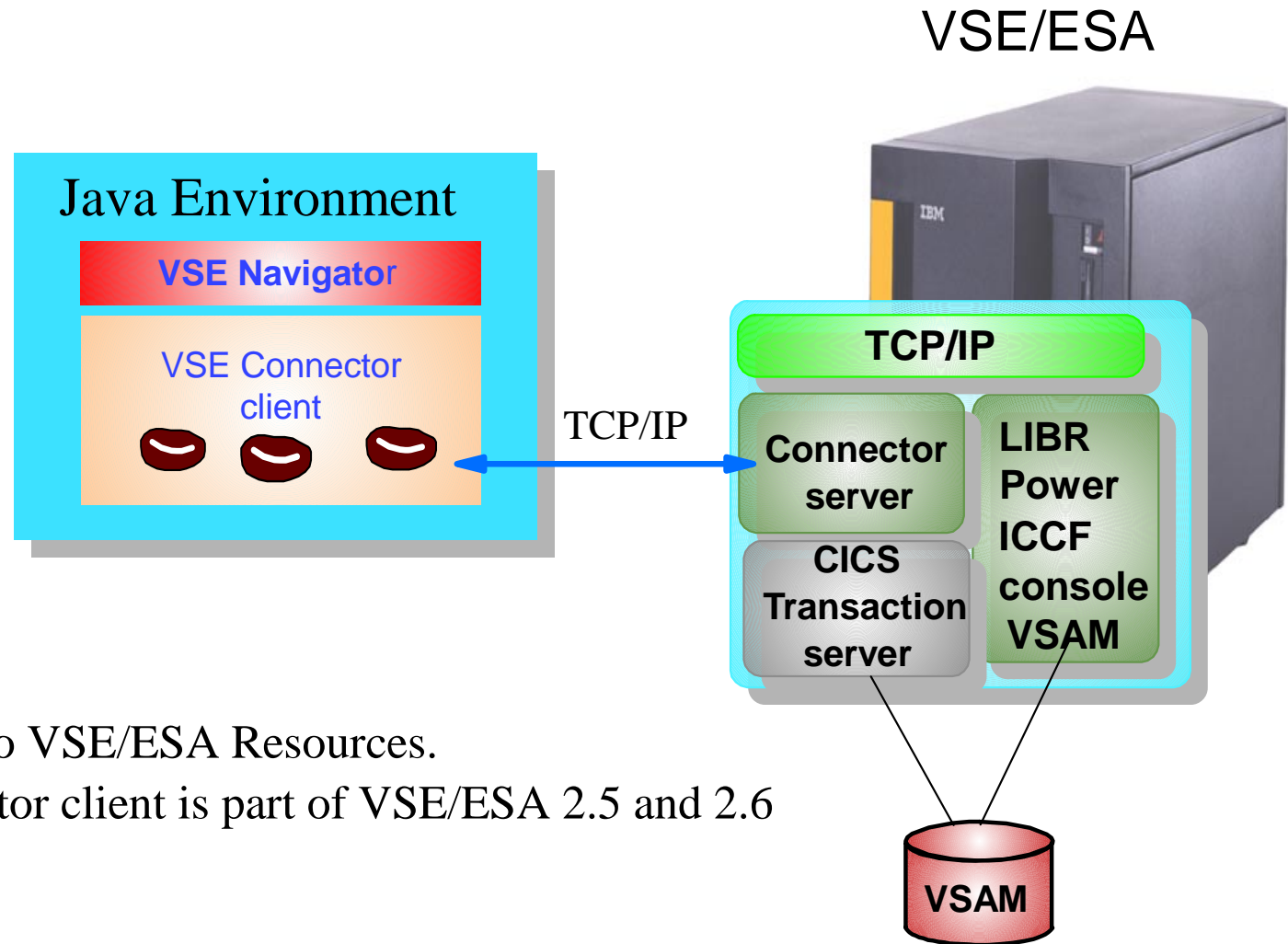

- ▶ Java access to VSE/ESA Resources.
- ▶ VSE Connector client is part of VSE/ESA 2.5 and 2.6



VSE Connector Server

Logon-mechanism

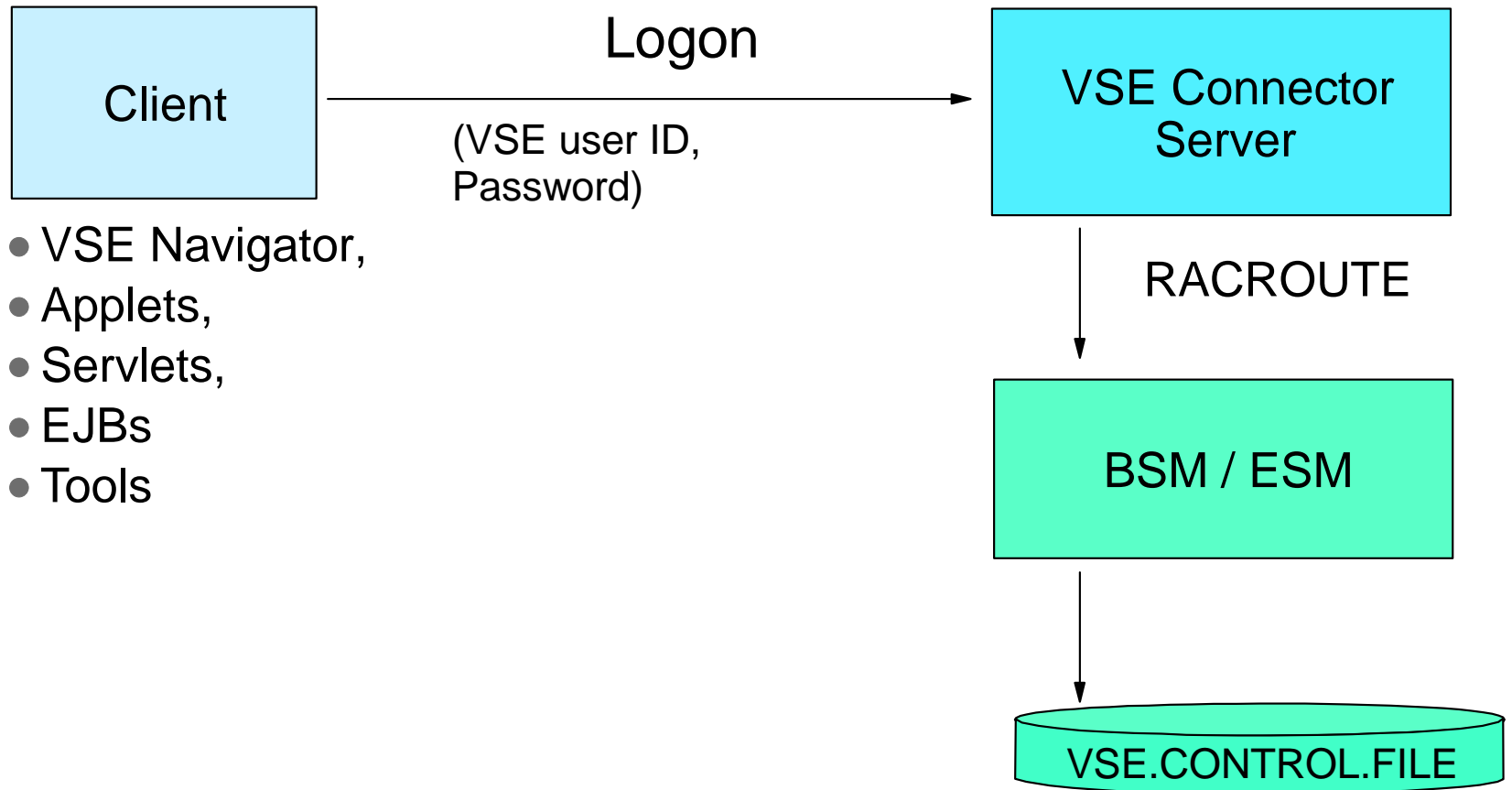



VSE Connector Server Configuration

Logon Security

Include and exclude list for userids
and IP addresses:

- Server configuration member **SKVCSUSR**
- Job-Skeleton in ICCF Lib.59

```
IP = 9.164.123.456, LOGON = DENIED  
IP = 9.165.*      , LOGON = DENIED  
IP = 10.0.0.*     , LOGON = ALLOWED
```

```
USER = SYS*,      LOGON = ALLOWED  
USER = PROG,     LOGON = DENIED
```



VSE Connector Server Configuration

SSL Security

Include and exclude list for userids
and IP addresses:

- Server configuration member **SKVCSSSL**
- Job-Skeleton in ICCF Lib.59

```
; *****  
;      SSL CONFIGURATION MEMBER FOR VSE CONNECTOR SERVER  
; *****  
  
; *****  
; SSLVERSION  SPECIFIES THE MINIMUM VERSION THAT IS TO BE USED  
;              POSSIBLE VALUES ARE:  SSL30 AND TLS31  
; *****  
SSLVERSION = SSL30  
  
; *****  
; CIPHERSUITES SPECIFIES A LIST OF CIPHER SUITES THAT ARE ALLOWED  
; *****  
CIPHERSUITES =      ; COMMA SEPARATED LIST OF NUMERIC VALUES  
                    01, ; RSA512_NULL_MD5  
                    02, ; RSA512_NULL_SHA  
                    08, ; RSA512_DES40CBC_SHA  
                    09, ; RSA1024_DESCBC_SHA  
                    0A, ; RSA1024_3DESCBC_SHA  
                    62  ; RSA1024_EXPORT_DESCBC_SHA
```



Navigator uses VSE Connector client

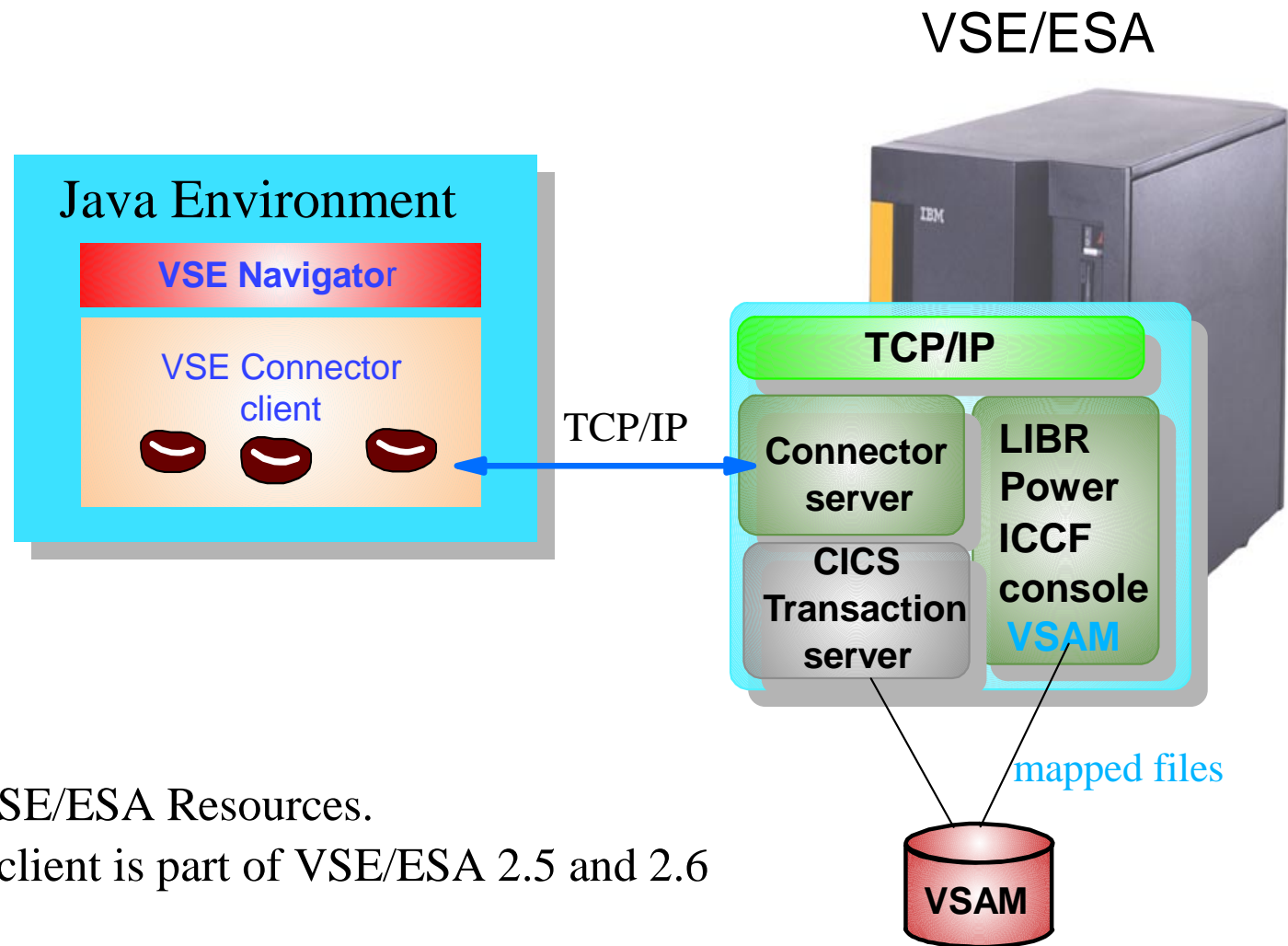

- ▶ Java access to VSE/ESA Resources.
- ▶ VSE Connector client is part of VSE/ESA 2.5 and 2.6

VSAM data in a relational View



VSE/VSAM Record structure from EMPPROG.COBOL

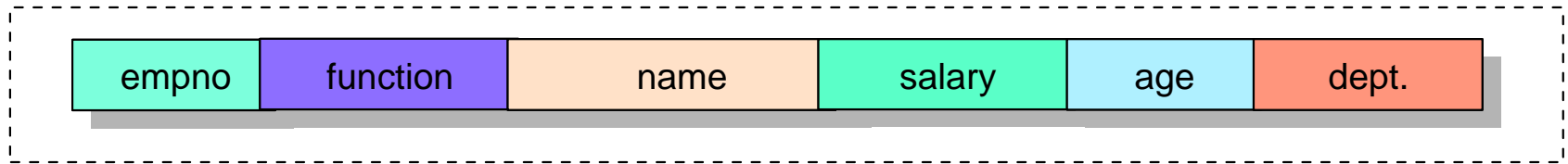

MY.USER.CATALOG / MY.VSAM.CLUSTER / EMPTABLE

empid	function	full_name	salary	age	dept.
4711	Manager	Mike Jonathan	8000 \$	42	1234
4712	Programmer	Jane Smith	6500 \$	35	1234
4713	Designer	Steve Miller	7000 \$	34	5678
4714	Secretary	Charly Brown	3500 \$	28	7256

- ▶ **Mapping can be done via:**
- ▶ **IDCAMS Utility RECMAP**
- ▶ **Java Beans (function included in VSE Navigator)**
- ▶ **MapTool to Generate/Transfer Maps and to generate XML format**

IBM server. For the next generation of e-business.



VSE Navigator (100% pure Java application)

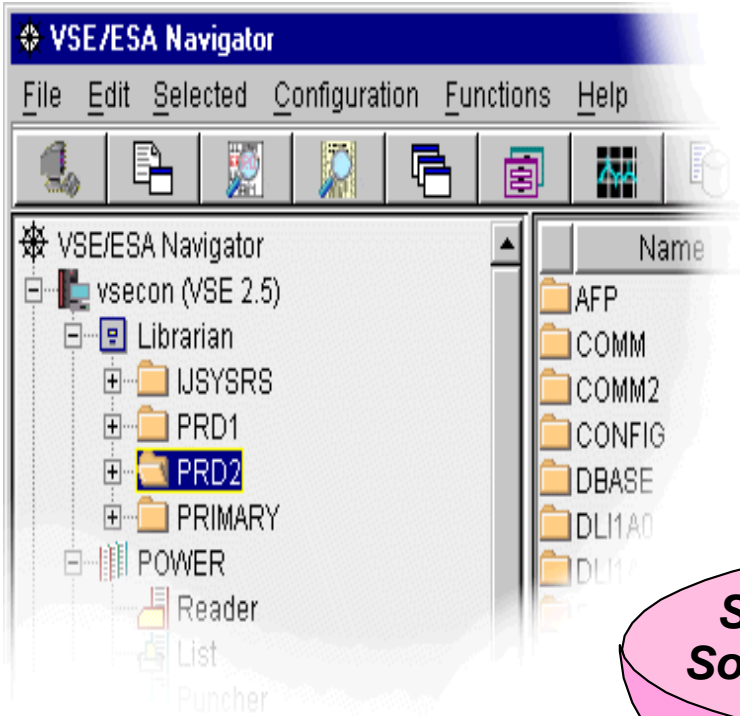

- VSE Connector Client
- Java Runtime (JRE)
- VSE Navigator



- TCP/IP
- VSE Connector Server

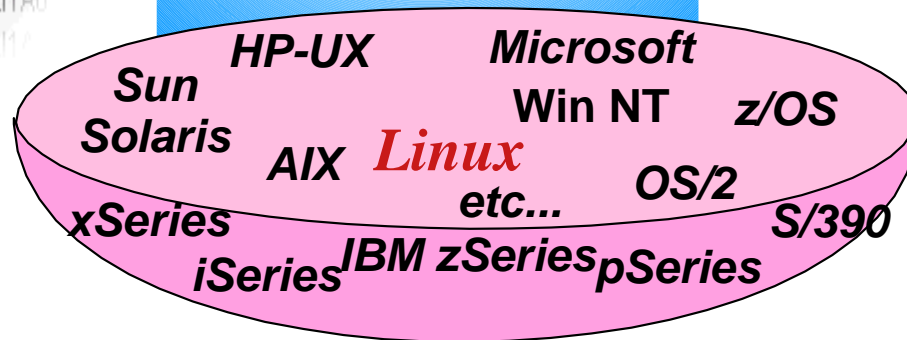

☛ A VSE/ESA graphical user interface using the Java-Based Connectors
(can be downloaded for free from VSE/ESA home page)

IBM @server. For the next generation of e-business.



VSE Navigator - Major Functions

★ Monitoring

★ VSAM Space

- ★ monitor VSAM Space

- ★ react on VSAM space shortage automatically with a local command (i.e. generate e-mail) or automatically release a JOB on VSE

★ System activity

- ★ supervise the partitions of your choice and save output to spreadsheet

- ★ analyse with PC tools the system activity

★ partition balancing



VSE Navigator - Major Functions

★ Data access

★ Librarian

- ★ Define/ delete sublibraries and members
- ★ Edit members with the editor of your choice
- ★ Copy Library members
- ★ Copy & Paste PC files to VSE Libraries
- ★ Copy and Paste members between VSE systems

★ Power Queues

- ★ Creation and Job submission
- ★ display contents of List/Punch queue entries
- ★ Edit/Release Reader Queue entries
- ★ View In Creation Queue entries
- ★ display ICCF Library members



VSE Navigator - Major Functions

★ Data access (continued)

★ VSAM

- ★ define VSAM files
- ★ define/modify MAPS/VIEWS for VSAM files
- ★ display contents VSAM records
- ★ add VSAM records using a map
- ★ update/modify VSAM data
- ★ Copy VSAM files (Repro) on same system
- ★ Backup/Restore VSAM files



VSE Navigator Functions

System Global Functions

- ★ **Configure TCP/IP**
- ★ **Search tool for VSE**
- ★ **Retrace Products**
- ★ **Display SVA utilization**
- ★ **Display Hardware Configuration**
- ★ **Console access**
- ★ **Message communication between Navigator users**
- ★ **Includes all local and Network drives**



VSE Navigator Functions

- ★ **These functions are available via the VSE e-business Connectors and can be included separately in java programs (applets,servlets, EJB's) to be integrated in solutions, based on the WebSphere Application Server.**



Steps for installation on a workstation

- ✓ install Java Runtime Environment (JRE) or
- ✓ Java Developer Kit (JDK)
 - ✓ free download from SUN or IBM
 - ✓ version 1.3.x

<http://www.ibm.com/java/jdk/download/index.html>

- ✓ download VSE Connector client

<http://www-1.ibm.com/servers/eserver/zseries/os/vse/support/vseconn/vse26/vsecon.htm>

- ✓ install VSE Connector client
 - ✓ at a command prompt hit: `java install`

- ✓ download VSE Navigator

<http://www-1.ibm.com/servers/eserver/zseries/os/vse/support/vseconn/vse26/vsenavi.htm>

- ✓ install VSE Navigator
 - ✓ at a command prompt hit: `java install`

IBM @server. For the next generation of e-business.



Setup Connector Server on VSE

Setup correct TCP/IP ID for VSE Connector server on VSE/ESA

✓ TCP/IP for VSE/ESA has been started with a **system ID** (default is **00**) specification in TCP/IP startup Job:

```
// EXEC IPNET,SIZE=IPNET,PARM='ID=00',INIT=.....
```

✓ To use the TCP/IP services from another partition this partition has to 'know' the system ID. This is specified as follows:

```
// OPTION SYSPARM='nn' - where nn is the system ID.
```

★ Recommendation: use the skeleton SKVCSSTJ in ICCF lib 59 to add this statement to startup job of connector server:

✓ Start connector server
r rdr,STARTVCS



Start and customize Navigator

- ✓ Start Navigator ([run.bat](#) or [run.sh](#))
First start will guide you through the settings:
 - ✓ Look and feel
 - ✓ Local directories
 - ✓ Local applications (i.e. Browser, file compare tool)

- ✓ setup a host system
[Configuration -> Hosts](#)

- ✓ Change the Configuration of Connector server
[Functions -> Display Server Status](#)
 - ✓ View Change the configuration files for:
 - ✓ Server
 - ✓ Librarian
 - ✓ Users
 - ✓ Plugins
 - ✓ SSL

Main Navigator Window



VSE/ESA Navigator

File Edit Selected Configuration Functions Help

VSE/ESA Navigator

- datajoin
- ffdemo
- Ingo
 - Librarian
 - POWER
 - VSAM
 - ICCF
 - Submitted Jobs
- vsewm
 - Librarian
 - POWER
 - VSAM
 - #VSAM.#CICS.DBDCICIS
 - VSAM.MASTER.CATALOG
 - VSESP.USER.CATALOG
 - ICCF
 - Submitted Jobs
- z800-Demo
- c:\
- d:\
- f:\
- f:\vselvsecon26\Download
- g:\
- h:\
- m:\
- s:\

Name	Description
Librarian	
POWER	
VSAM	
ICCF	
Submitted Jobs	

datajoin at 9.164.155.90



Additional Information



- ❖ VSE/ESA Home Page

<http://www.ibm.com/servers/eserver/zseries/os/vse/>

- ❖ e-business connectors tools

<http://www-1.ibm.com/servers/eserver/zseries/os/vse/support/vseconn/conmain.htm>

- ❖ e-business Connectors User's Guide SC33-6719

<http://www-1.ibm.com/servers/eserver/zseries/os/vse/pdf/ieswue10.pdf>

Redbooks:

- ❖ e-business Connectivity for VSE/ESA SG24-5950

- ❖ e-business Solutions for VSE/ESA SG24-5662

- ❖ Servlet and JSP Programming SG24-5755

We appreciate your comments at :

VSEESA@de.ibm.com

IBM server. For the next generation of e-business.

VSE/ESA 2.6

VS@™

e-business

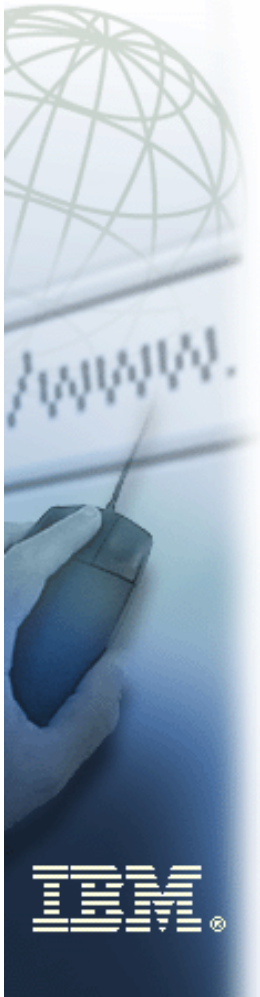

The next pages contain some screen shots from the VSE Navigator demo at **z/VM, VSE and Linux on zSeries Tech Conf - October 7 - 10th 2002, Miami Beach, FL**

Various data access possibilities and system functions are implemented in VSE Navigator. They are using the Java-based Connector shipped within VSE Connector Client, which is part of VSE/ESA 2.5 and VSE/ESA 2.6 and can be downloaded from:

<http://www-1.ibm.com/servers/eserver/zseries/os/vse/support/vseconn/conmain.htm>.

VSE/ESA 2.6 Connector Client



e-business

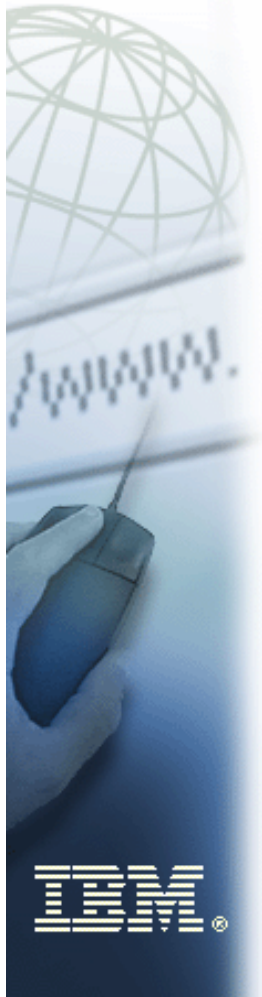

VSE/ESA e-business Connectors - Microsoft Internet Explorer

File Edit View Favorites Tools Help

Back Forward Stop Refresh Home Search Favorites History Mail Print Real.com

Address <F:\VSE\vsecon26\VSEConnectors.html> Go Links

VSE/ESA e-business Connectors

Overview

VSE/ESA provides a framework of connectors for accessing VSE data from various client platforms over TCP/IP. In the following we talk about

- **Connectors**, that are programs which allow client applications to connect to a VSE host. Information is provided for existing connectors, like MQSeries, CICS Transaction Gateway, and the DB2 family of products, and for a new Java-based connector. The new Java-based connector is given by the [VSE Connector Server](#) and the [VSE Connector Client](#).
- **Environments**, that reflect the way, how computers are connected. We will talk about 2-tier (Client/Server) environments and 3-tier environments, where a middle-tier platform serves as a gateway between clients and the VSE host.
- **Programming Concepts**, that reflect the programming model of your application. There are examples of Java applications, Java applets, Java Servlets, Java Server Pages (JSPs), Enterprise Java Beans (EJBs), and DB2 Stored Procedures.

If your browser supports frames, you will find corresponding links in the left frame. Otherwise, please refer to the links at the bottom of this page.

Done My Computer

Included in VSE/ESA 2.6 and contains:

- VSE Java Beans (java class library)
- Online Documentation (Reference and javadoc)
- Various Samples

VSE/ESA Navigator - Main window

VS@

e-business

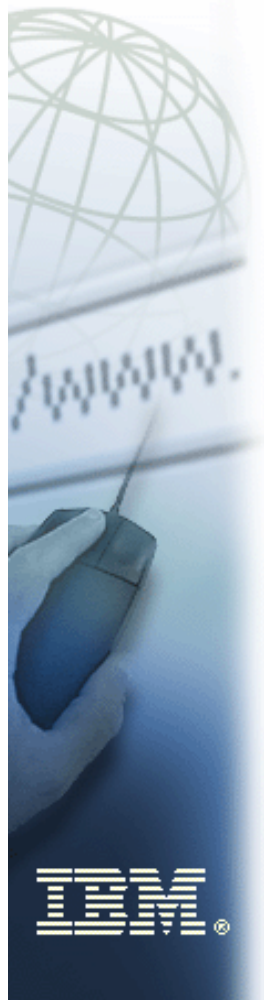

The screenshot shows the VSE/ESA Navigator main window. The title bar reads "VSE/ESA Navigator". The menu bar includes "File", "Edit", "Selected", "Configuration", "Functions", and "Help". The toolbar contains various icons for file operations and system functions. The main area is divided into two panes. The left pane shows a tree view of the system structure, with "ffdemo" selected. The right pane shows a list of objects with columns for "Name" and "Description".

Name	Description
Librarian	
POWER	
VSAM	
ICCF	
Submitted Jobs	

ffdemo at 9.164.155.33

Main Functions

VS@

e-business

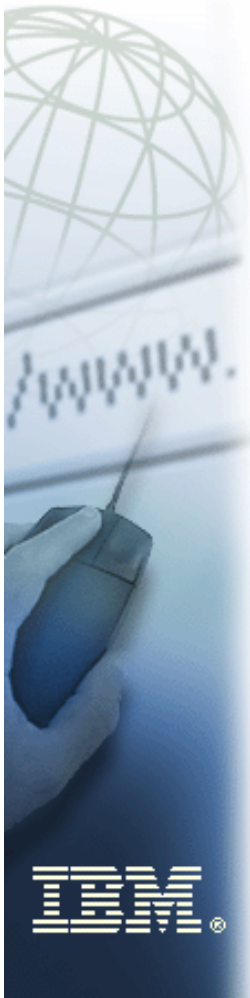

The screenshot shows the VSE/ESA Navigator application window. The title bar reads "VSE/ESA Navigator". The menu bar includes "File", "Edit", "Selected", "Configuration", "Functions", and "Help". The toolbar contains various icons for file operations and system management. The main interface is divided into three panes:

- Left Pane:** A tree view showing the system structure. The "FFDEM" node is selected, and a context menu is open over it. The menu items include: Disconnect, Cut, Copy, Paste, Delete, Send a message to users, Refresh, Compile Helper Plugin, Configure host, Display VSAM space..., Display VTOC, Display activity..., Download skeletons, Hardware Configuration, ICCF..., List SVA..., Monitor VSAM space..., Open Console, Retrace products..., Server Status, Standard labels..., and System tasks...
- Right Pane:** A table with two columns: "Name" and "Description". It lists several system components:

Name	Description
Librarian	
POWER	
VSAM	
ICCF	
Submitted Jobs	
- Bottom Pane:** A status bar showing "FFDEMO at 9.164.155.33".

Display Power Reader



e-business

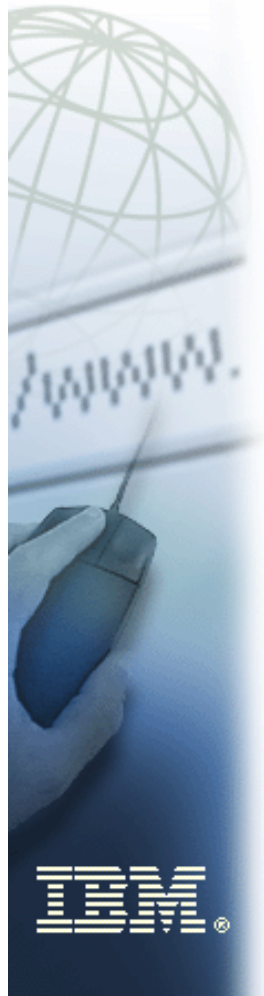

VSE/ESA Navigator

File Edit Selected Configuration Functions Help

Job	Disposition	Class	Priority	Records	From user	at node	To user
AUXTRAF2.84	L (leave)	0	3	20	SYSA		20
AUXTRAF8.85	L (leave)	0	3	20	SYSA		20
BASEREST.70	L (leave)	0	3	26	SYSA		20
CATAL.111	L (leave)	A	3	143			20
CICS2.106	L (leave)	8	3	62	SYSA		20
CICSBSX.54	L (leave)	2	3	55	SYSA		20
CICSBSX.92	L (leave)	2	3	57	SYSA		20
CICSBSX.93	L (leave)	2	3	57	SYSA		20
CICSCOF2.150	L (leave)	0	3	4	SYSA		20
CICSCOF8.89	L (leave)	0	3	4	SYSA		20
CICSDLI.152	L (leave)	8	3	62	MILD		20
CICSICCF.154	* (running)	2	3	66	SYSA		20
CLEANUP.78	L (leave)	0	3	27	SYSA		20
COMPCICS.100	L (leave)	4	3	34	MWEB		20
DFHAUXPR.86	L (leave)	0	3	21	MWEB		20
DUMPINIT.76	L (leave)	0	3	48	SYSA		20
HISTORY.83	L (leave)	0	3	405			20
HISTREST.65	L (leave)	0	3	22	SYSA		20
ICCFLOAD.69	L (leave)	0	3	16	SYSA		20
ICCFREST.68	L (leave)	0	3	241	SYSA		20
INSABEND.59	L (leave)	0	9	18	SYSA		20
INSTALL.113	L (leave)	1	3	24	SYSA		20
LEREST.72	L (leave)	0	3	32	SYSA		20
LFCBLINK.64	L (leave)	0	3	14	SYSA		20
LIBRDEFS.67	L (leave)	0	3	56	SYSA		20
MACREST.71	L (leave)	0	3	26	SYSA		20
MIGRAT.112	L (leave)	1	3	55	SYSA		20
NLICFRES.74	L (leave)	0	3	31	SYSA		20
NLLIBRES.73	L (leave)	0	3	26	SYSA		20
PAUSEBG.155	L (leave)	0	3	4	SYSA		20
PAUSEF1.91	L (leave)	1	3	4	SYSA		20
PAUSEF2.94	L (leave)	2	3	4	SYSA		20
PAUSEF3.98	L (leave)	3	3	4	SYSA		20
PAUSEF4.101	L (leave)	4	3	4	SYSA		20
PAUSEF5.102	L (leave)	5	3	4	SYSA		20

63 entries received | 3125 records | 4 active | sorted by Job | no filter

Access Library member



e-business

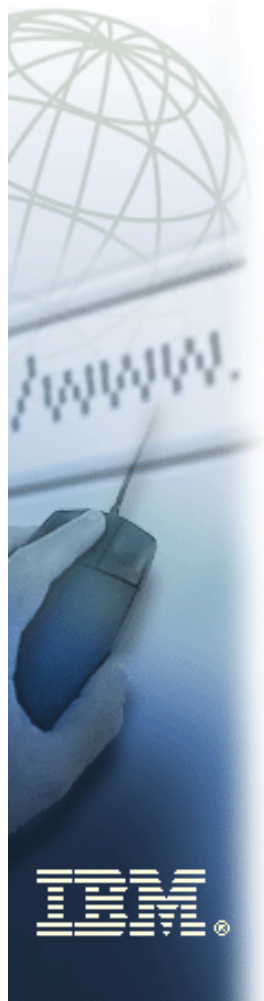

VSE/ESA Navigator

File Edit Selected Configuration Functions Help

Member	Description	Pa
CICSF00T.HTML	Hypertext Markup Language file	Librarian/DFHHTML.DF
DEMO.HTML	Hypertext Markup Language file	Librarian/DFHHTML.DF
EBERSETA.HTML	Hypertext Markup Language file	Librarian/DFHHTML.DF
EXTRCTF1.HTML	Hypertext Markup Language file	Librarian/DFHHTML.DF
EXTRCTF2.HTML	Hypertext Markup Language file	Librarian/DFHHTML.DF
EXTRCTF3.HTML	Hypertext Markup Language file	Librarian/DFHHTML.DF
EXTRCTF4.HTML	Hypertext Markup Language file	Librarian/DFHHTML.DF
EXTRCTH1.HTML	Hypertext Markup Language file	Librarian/DFHHTML.DF
EXTRCTH2.HTML	Hypertext Markup Language file	Librarian/DFHHTML.DF
EXTRCTH3.HTML	Hypertext Markup Language file	Librarian/DFHHTML.DF
EXTRCTH4.HTML	Hypertext Markup Language file	Librarian/DFHHTML.DF
FFSETA.HTML	Hypertext Markup Language file	Librarian/DFHHTML.DF
FFSETB.HTML	Hypertext Markup Language file	Librarian/DFHHTML.DF
INDEX.HTML	Hypertext Markup Language file	Librarian/DFHHTML.DF
SCOTLAND.JPG	JPG Image File	Librarian/DFHHTML.DF
VSAMBODY.HTML	Hypertext Markup Language file	Librarian/DFHHTML.DF
VSAMFOOT.HTML	Hypertext Markup Language file	Librarian/DFHHTML.DF
VSAMHEAD.HTML	Hypertext Markup Language file	Librarian/DFHHTML.DF
VSAMSURE.HTML	Hypertext Markup Language file	Librarian/DFHHTML.DF
VSAMUPDT.HTML	Hypertext Markup Language file	Librarian/DFHHTML.DF

20 member(s) 3578 record(s) 269 block(s) used 0 locked sorted by Member no filter

Edit host member on PC



e-business

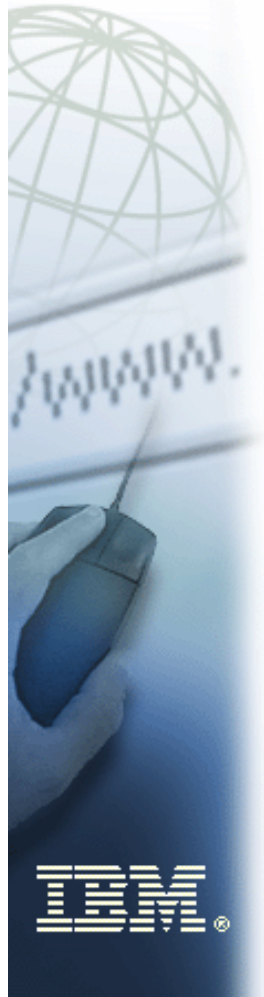

The screenshot shows the VSE/ESA Navigator application window. The left pane displays a tree view of the VSEWM1 environment, with the PRIMARY library and its sub-libraries expanded. The right pane shows a list of members with columns for Member, Description, and Path. A context menu is open over the member STP... in the list.

Member	Description	Path
ARICAXED.OBJ	Compiled OBJ file	Librarian/PRIMARY.WM
ARICAXLD.OBJ	Compiled OBJ file	Librarian/PRIMARY.WM
ARICDAPD.OBJ	Compiled OBJ file	Librarian/PRIMARY.WM
ARIPCB2D.OBJ	Compiled OBJ file	Librarian/PRIMARY.WM
ARIPCBND.OBJ	Compiled OBJ file	Librarian/PRIMARY.WM
ARIPPRSD.OBJ	Compiled OBJ file	Librarian/PRIMARY.WM
ARIRECID.OBJ	Compiled OBJ file	Librarian/PRIMARY.WM
ARIRENAD.OBJ	Compiled OBJ file	Librarian/PRIMARY.WM
ARIORMD.OBJ	Compiled OBJ file	Librarian/PRIMARY.WM
ARIRTRD.OBJ	Compiled OBJ file	Librarian/PRIMARY.WM
ARIRSYND.OBJ	Compiled OBJ file	Librarian/PRIMARY.WM
? ATCCON00.B	Unknown filetype	Librarian/PRIMARY.WM
? ATCSTR00.B	Unknown filetype	Librarian/PRIMARY.WM
CPUVAR1.PROC	POWER Proc	Librarian/PRIMARY.WM
DFHSIB1.OBJ	Compiled OBJ file	Librarian/PRIMARY.WM
DFHSIB1.PHASE	VSE executable file	Librarian/PRIMARY.WM
DFHZCT1.OBJ	Compiled OBJ file	Librarian/PRIMARY.WM
DFHZCT1.PHASE	VSE executable file	Librarian/PRIMARY.WM
? IP1BOC.B	Unknown filetype	Librarian/PRIMARY.WM
C STP...	C source file	Librarian/PRIMARY.WM
TES...	Compiled OBJ file	Librarian/PRIMARY.WM

Context menu options: Edit, View, View, Submit..., Cut

Status bar: 21 member(s) 2178 record(s) 207 block(s) used 0 loc

List of VSAM files in a catalog

VS@

e-business

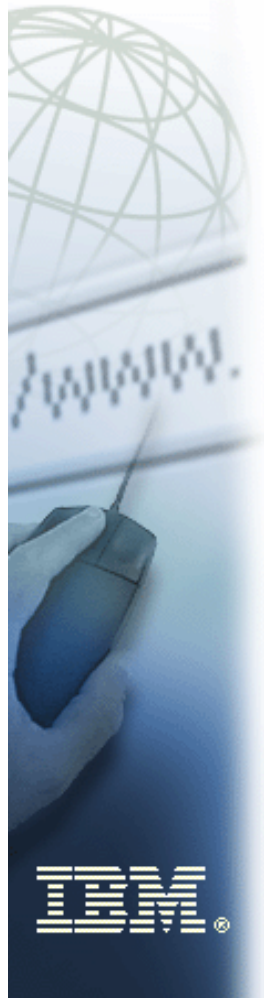

VSE/ESA Navigator

File Edit Selected Configuration Functions Help

File ID	Name	Type	K...	Key...	Max. re...	Creation c
CICS.TD.INTRA	DFHNTRA	ESDS	0	0	4089	28.10.2001
DEFAULT.MODEL.ESDS.SAM		SAM ESDS	0	0	2000	28.10.2001
DEMO.KSDS.CLUSTER	DEMOKS	KSDS	0	8	300	04.03.2002
DFHTEMP	DFHTEMP	ESDS	0	0	16377	28.10.2001
FLIGHT.ORDERING.FLIGHTS	TMP7875	KSDS	0	4	86	26.02.2002
PTF.FILE	IJSYSPF	SAM ESDS	0	0	10320	28.10.2001
REDIR.KSDS.CLUSTER	RDKSDS	KSDS	0	8	300	04.03.2002
VSAM.COMPRESS.CONTROL		KSDS	0	44	500	28.10.2001
VSAM.CONN.SAMPLE.DATA	TMP7B52	KSDS	0	4	120	03.03.2002
VSE.CICREX.FP01.DIR	RFSDIR1	KSDS	0	251	314	28.10.2001
VSE.CICREX.FP01.FILE01	RFSPOL1	KSDS	0	252	8185	28.10.2001
VSE.CICREX.FP02.DIR	RFSDIR2	KSDS	0	251	314	28.10.2001
VSE.CICREX.FP02.FILE01	RFSPOL2	KSDS	0	252	8185	28.10.2001
VSE.CONTROL.FILE	IESCNTL	KSDS	0	12	1000	28.10.2001
VSE.EZACICS.CACHE	EZACACH	KSDS	0	255	1000	28.10.2001
VSE.EZACICS.CONFIG	EZACONF	KSDS	0	16	150	28.10.2001
VSE.MESSAGE.ROUTING.FILE	IESROUT	KSDS	0	16	4080	28.10.2001
VSE.ONLINE.PROB.DET.FILE	IESPRB	KSDS	0	2	4089	28.10.2001
VSE.PRIMARY.LIBRARY	PRIMARY	SAM ESDS	0	0	4089	28.10.2001
VSE.TEXT.REPSTORY.FILE	IESTRFL	KSDS	0	12	4080	28.10.2001
VSE.VSAM.RECORD.MAPPING.DEFS	IESMAPD	KSDS	0	222	284	28.10.2001
VSESP.USER.CATALOG	VSESPUC	KSDS	0	44	505	28.10.2001

30 cluster(s) 0 RRDS 4 ESDS 21 KSDS sorted by File ID no filter

Display mapped VSAM data (1)

VS@

e-business

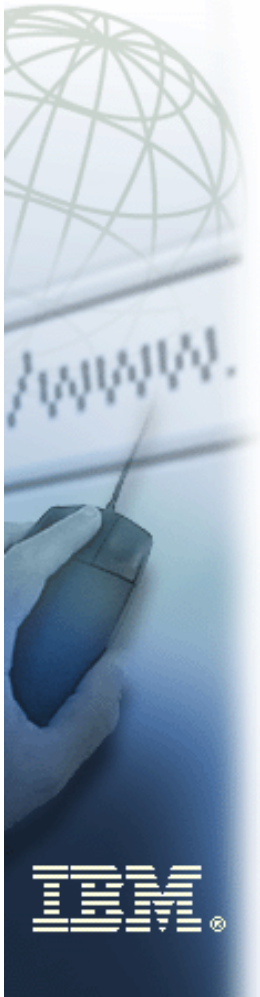

The screenshot shows the VSE/ESA Navigator interface. The main window displays a tree view of the system structure. The 'VSAM' folder is expanded, showing a list of VSAM datasets. A context menu is open over the 'FILE' dataset, with the option 'Display VSAM data' selected. A 'Display filter...' dialog box is overlaid on the right side of the screen. The dialog box contains the following fields and controls:

- Available columns:** A list box containing KEY2, NAME, STREET, ZIP, CITY, and COUNTRY.
- Value:** A text input field.
- Type:** A text input field.
- Operation:** A group box containing radio buttons for various comparison operators: +, ?; ==; >; <; >=; <=; <>.
- Filters:** A large empty text area for defining filter expressions.
- Buttons:** OK, Cancel, Help, Add, Delete, and Set.

Display mapped VSAM data (2)



e-business



VSE/ESA Navigator					
File Edit Selected Configuration Functions Help					
	KEY2	NAME	STREET	ZIP	CITY
Librarian	000102	HEINI MUSTERMANN	HAUPTSTR.22	66531	IRGENDWO
D21LIB	000103	Donald Duck	Hauptstr.	12345	Entenhausen
IJSYSRS	000104	PAULA MUSTERFRAU	NEBENSTR.23	66532	NIRGENDWO
PRD1	000106	FRIENDLY FOOD ZENT.	SACHERSTR.1	12345	WIEN
...	000111	A. SCHWARZENEGGER	SCHLUCHTENWEG1	23456	LINZ
PRIMARY	000762	TERRENCE HILL	BERGSTR.46	67890	INNSBRUCK
POWER	000983	H. L. L. CALL	WASHINMGTON.DC	34512	WASHINGTON
Reader	001222	J.R.REYNOLDS	STADTGRABENSTR. 10	71032	BOEBLINGEN
List	001781	HAROLD JAMES	WETTBACHSTR. 25	71067	SINDELFINGEN
Puncher	003214	HUBERT C HERBERT	MAINROAD 174	45670	SUNNY VALLEY,FL
Transmit	003890	PHILIPPE SMITH, JR	RUE DE LA MER 1	98673	NICE
VSAM	004004	STAN SMITH	SIDEWALK (LEFT)	11711	DUBLIN
DB2.USER.CATALOG	004445	IRMA LA DOUCE	RUE ST. DENIS	11110	PARIS
VSAM.MASTER.CATALOG	004878	JIM NOBODY	UNKNOWN	21213	NOWHERE,TX
VSESP.USER.CATALOG	005005	J. S. LAVERENCE	LAKE BLVD.107	00010	SAN FRANCISCO
CICS.AUXTRACE	005444	POPE PAUL	LATERAN	10001	ROME
CICS.CSD	005581	RENE CLOCHARD	LES HALLES	00001	PARIS
CICS.DBDCCICS.DFHDMFA	006016	DR.W. NEHRU	CENTER RD	99887	NEW DELHI
CICS.DBDCCICS.DFHDMFB	006670	ANDY BUSHMAN	BUSH 9	99999	CALAHARY
CICS.DUMPA	006968	D. CONRAD	WARROAD	46783	WARWICK
CICS.DUMPB	007007	BRIGITTE EICRN	KOENIGSTR. 43	70311	STUTTGART
CICS.GCD	007248	B. C. WILLIAMSON	CEDER 87	94863	REDWOOD CITY,CA
CICS.LCD	007779	MRS. W. WELCH	SILICON VALLEY	83874	SAN JOSE, CA
CICS.RSD	100000	G. NEADS	FALLS 8	72139	TORONTO,ONTARIO
CICS.TD.INTRA	111111	C. MEARS	RUE EST 6	64194	OTTAWA, ONTARIO
CICSTS11.SAMPLE.VSAMA	200000	A. BONFIELD	SOUTH ROAD	56789	GLASGOW,
DEFAULT.MODELESDS.SAM	222222	J. WIEBERS	FRESSGASSE 5	67653	FRANKFURT
DFHTEMP	300000	K. TRENCHARD	5TH. AVENUE	37892	NEW YORK
DOS.WORKFILE.SYS001.RECOVER	333333	D. MYRING	HARBOUR ROAD	24973	CARDIFF WALES
DOS.WORKFILE.SYS002.RECOVER	400000	W. TANNER	VIA VENEGRACE	12345	MILAN
FFDEMOVS.SAMPLE.ACCMI	444444	A. FISHER	LAKE BLVD.	98765	CALGARY
FFDEMOVS.SAMPLE.NCADD	500000	J. DENFORD	PRADO 5	85298	MADRID
FFDEMOVS.SAMPLE.PRODT	555555	C. JARDINE	FISHKILL ROAD	76653	KINGSTON, N.Y.
FFDEMOVS.SAMPLE.STORE	600000	F. HUGHES	CHURCH STR.8	66678	DUBLIN, IRELAND
JAVAFILE.SAMPLE.FILEA	700000	A. MACALLA	SOUTH FORK FARM	59991	DALLAS, TEXASUS
FILEAMA1	777777	D. PRYKE	MOUNTAIN STREET 6	46539	WILLIAMSBURG,VI
FILEAMA2					

40 row(s) received

Monitor VSAM space



e-business

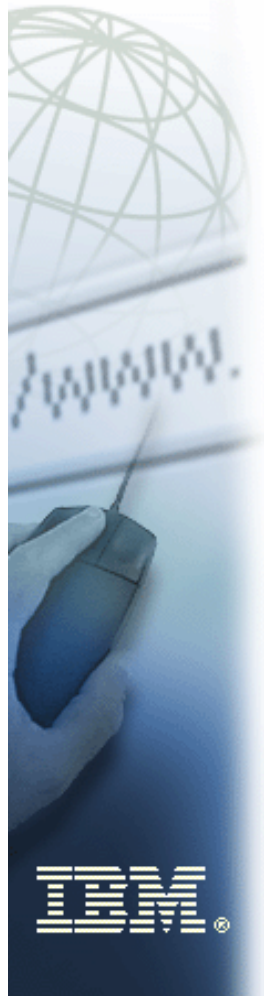

Monitor VSAM Space Usage - Host FFDEMO

Catalogs:
VSAM.MASTER.CATALOG
VSESP.USER.CATALOG
DB2.USER.CATALOG

Monitor all catalogs

Start Stop

Save to spreadsheet...

Time interval in minutes:

Critical free space value: %

Actions if critical value reached:

Local:

Submit:

Perform actions only once

Interval: 2
Total space: 102 MB
Used space: 88 MB
Free space: 13 %

Free space over time intervals:

Got max RC = 0 from LISTCAT.

Close Help

Display VTOC



e-business

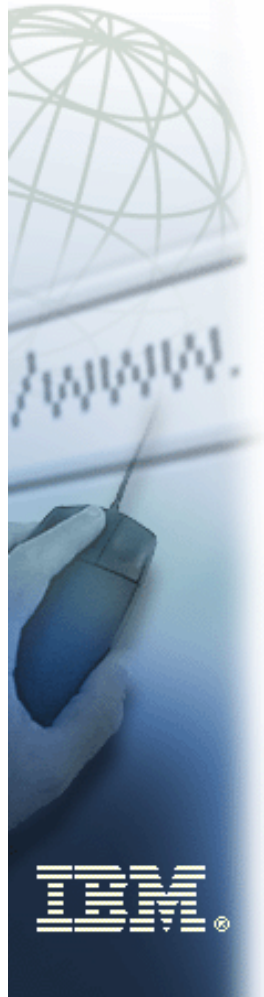

Display VTOC Utility

General Information | File Identifiers | Extent/VSAM | Free Space

Filename	Location
DOS.LABEL.FILE.FF0820009672.AREA1	C 210,T11,R 4
DOS.PAGING.FILE.FF0820009672	C 210,T11,R 5
VSE.POWER.QUEUE.FILE	C 210,T11,R 6
VSE.SYSRES.LIBRARY	C 210,T11,R 3
VSE.SYSTEM.HISTORY.FILE	C 210,T11,R 7
Z9999992.VSAMDSPC.TB184FF9.T35CE170	C 210,T11,R 9
Z9999992.VSAMDSPC.TB184FF9.T628B215	C 210,T11,R10
Z9999996.VSAMDSPC.TB184FF9.T25DB20B	C 210,T11,R 8

Details... Close Help

DOS.PAGING.FILE.FF0820009672 - Details

File details

Location: C 210,T11,R 5
Creation date: 09/07/1999
Expiration Date: Never
System ID: IBMDOSVS
Number of extents: 2
ISAM key length: -
ISAM block size: -
ISAM RCD: -

Extent Information

Sequence	Type	Low	High
0	PRIME	414 0	457 14
1	PRIME	458 0	841 14

OK Help

System Activity display

VS@

e-business

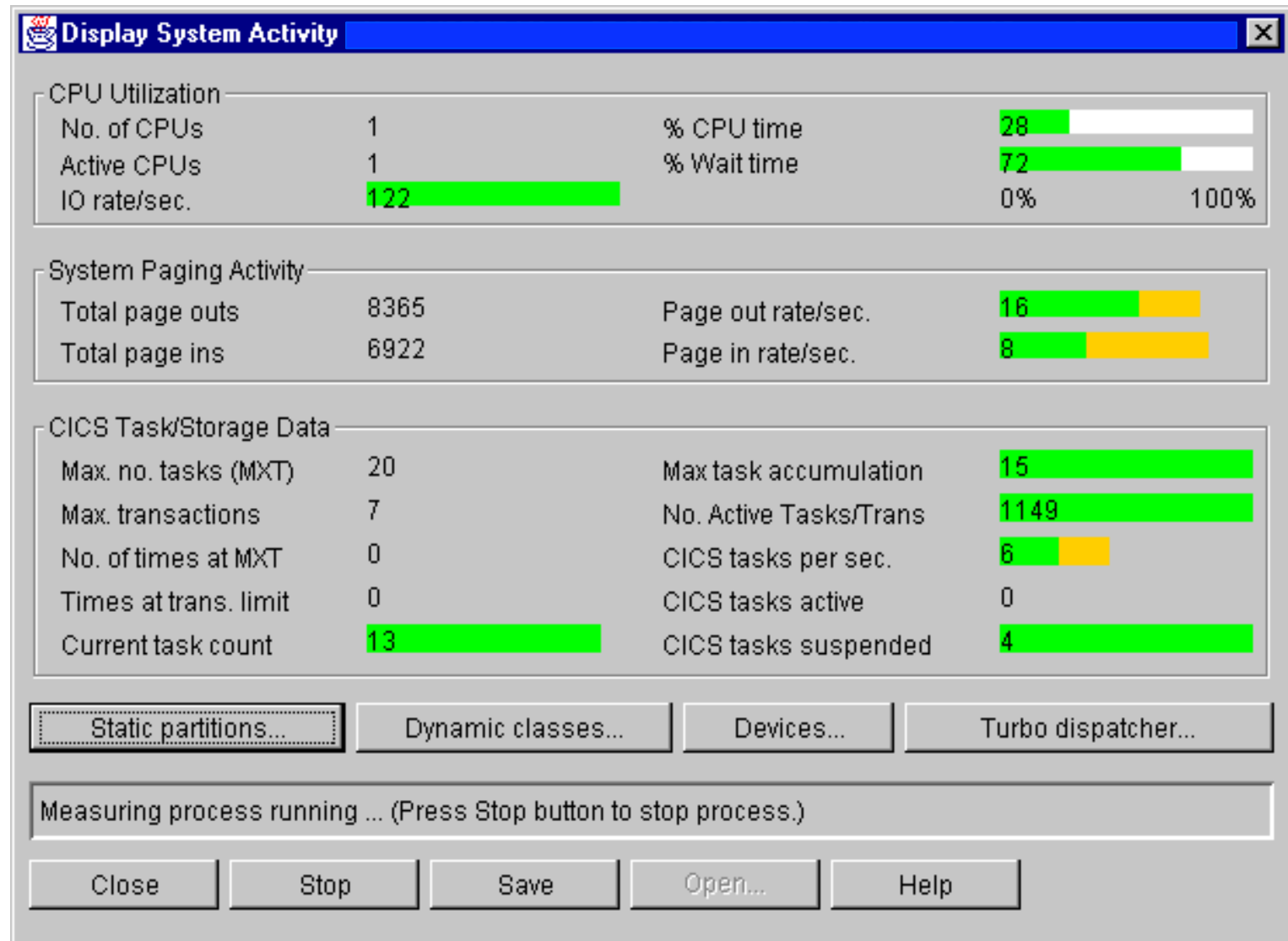
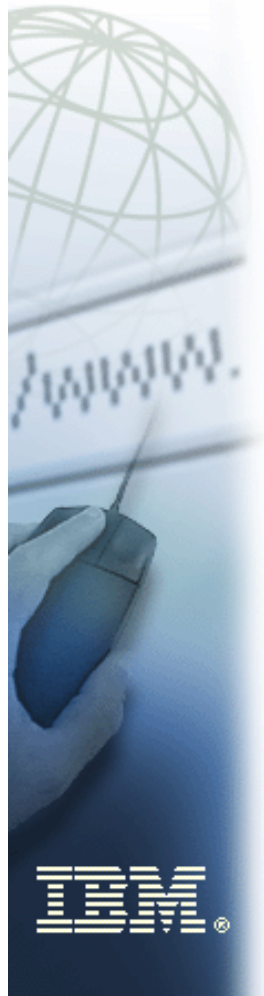

Display product service



e-business

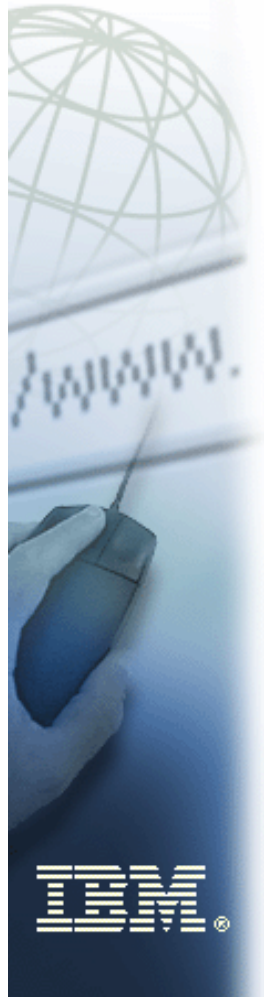

Retrace Products and PTFs

Customer information | **Products list** | PTF list

Product Number	Date	Product Name and Release
A041IP	07/07/99	VSE/ESA 2.
DS21G0	07/07/99	VSE/ESA 2.
054A0P	12/18/98	VSE/ESA 2.
054A0R	12/18/98	VSE/ESA 2.
065FE6	07/07/99	VSE/ESA 2.
0664G7	07/07/99	VSE/ESA 2.
06645C	07/07/99	VSE/ESA 2.
06645D	07/07/99	VSE/ESA 2.
06645G	07/07/99	VSE/ESA 2.
06645I	07/07/99	VSE/ESA 2.
06645J	08/30/99	VSE/ESA 2.
0941DS	07/07/99	VSE/ESA 2.

Details...

26 of 26 products

Data was retrieved from the host.

Close Refresh Help

Retrace Products and PTFs

Customer information | Products list | **PTF list**

PTF Number	Date	Component ID	Product Number
UQ29092	07/07/99	5686-09408-1F2	0941F2
UQ29093	07/07/99	5686-06601-45C	06645C
UQ29380	07/07/99	5686-06601-45C	06645C
UQ29634	07/07/99	5686-06601-45C	06645C
UQ29864	07/07/99	5686-06601-45C	06645C
UQ30758	07/08/99	5686-A0400-1IP	A041IP
UQ30925	08/09/99	5686-06601-45C	06645C
UQ31433	07/08/99	5686-09408-1F2	0941F2
UQ32704	07/26/99	5686-A0400-1IP	A041IP
UQ32767	07/26/99	5686-A0400-1IP	A041IP
UQ32767	07/26/99	5686-A0400-1IP	A041IP

Details...

630 of 630 PTFs

Filter by PTF

Lookup APAR

Lookup PTF

Lookup member

Filter by comp. ID

Close Refresh Help

VSE Standard Label



e-business

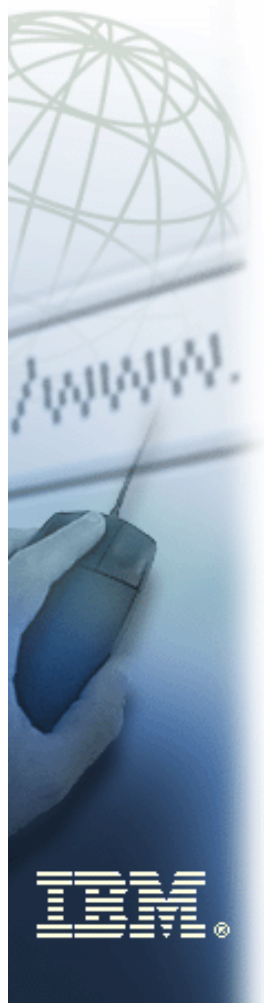

VSE/ESA Navigator - Standard Labels Display

- Labels
 - User labels
 - F2
 - IJSYS01
 - IJSYS02
 - F2
 - R1
 - USER LABELS
 - IJSYSCT
 - VSESPUC

Click on a label or use arrow keys to see details (if available):

FILE IDENTIFIER	VSESP.USER.CATALOG
FILE SERIAL NUMBER	OMITTED
VOLUME SEQUENCE NUMBER	01
CREATION DATE	OMITTED
RETENTION PERIOD (DAYS)	0000
FILE TYPE	VSAM FILE
CATALOG	VSESPUC
EXTENT INFORMATION	OMITTED

Search label

File Types

VS@

e-business



VSE/ESA Navigator

File Edit Selected Configuration Functions Help

Display Hardware Configuration...
Display SVA...
Display Server Status...
Display Standard Labels...
Display System Tasks...
Display User Info...
Display VTOC...
Job submission
Open Operator Console...
Compare files...
Create new Cluster...
Display System Activity...
Display VSAM Space...
Monitor VSAM Space...
Compile Helper Plugin...
Download Job Skeletons...
Retrace Products ...
Send A Message...

VSE/ESA Navigator
+ datajoin
+ ffdemo
+ VSEIF
- vsewm
+ Librarian
+ POWER
- VSAM
+ #VSAM.#CICS.DBDCCK
+ VSAM.MASTER.CATALO
+ VSESP.USER.CATALOC
+ ICCF
+ Submitted Jobs
- z800-Demo
+ Librarian
+ POWER
- VSAM
+ #VSAM.#CICS.DBDCCK
+ VSAM.MASTER.CATALO
+ VSESP.USER.CATALOC
+ ICCF
+ Submitted Jobs
+ c:\
+ d:\

Description

vsewm at 9.164.155.87

Server Status, Customization



e-business



Display Server Status...

Configuration | Active clients | Plugins loaded | VSAM Clusters opened

System release: 2.6.0
 System date: 23.10.2001

Max no. of clients: 256
 TCP/IP port: 2893
 SSL Status: No
 ASCII codepage: IBM-850
 EBCDIC codepage: IBM-1047
 Description text: VSE/ESA CONNECTOR SERVER ON <YOUR SYSTEM>
 Tracing level: 0x00000000
 Trace output file: DD:SYSLOG

Server config file: DD:PRD2.CONFIG(IESVCSRV.Z)
 Librarian config file: DD:PRD2.CONFIG(IESLIBDF.Z)
 Users config file: DD:PRD2.CONFIG(IESUSERS.Z)
 Plugins config file: DD:PRD2.CONFIG(IESPLGIN.Z)
 SSL config file: DD:PRD2.CONFIG(IESSSLCF.Z)

Display Server Status...

Configuration | Active clients | Plugins loaded | VSAM Clusters opened

Active clients

Client 0 (9.164.185.90)

Client ID: 0
 Client IP: 9.164.185.90
 Client name: milde.boeblingen.de.ibm.com
 Username: MILD
 Language: E
 Execution state: Running
 Actual Command: 0x80000005
 Undelivered messages: 0
 Bytes unreceived: 0
 POWER connection: Not connected, Not used

User Info



e-business



User information for vsewm

UserID	Logon	Catalog	...
\$SRV	IESERSUP	IJSYSCT	2
CICSUSER	DFLESEL	IJSYSCT	3
DBDCCICS	DUMMY	IJSYSCT	1
DEMO	IESEADM	IJSYSCT	1
FORSEC	IESEADM	IJSYSCT	1
MILD	IESEADM	IJSYSCT	1
OPER	IESEOPER	IJSYSCT	2
POST	IESA\$FST	IJSYSCT	1
PRODCICS	DUMMY	IJSYSCT	1
PROG	IESEPROG	IJSYSCT	2
SYSA	IESEADM	IJSYSCT	1
VCSRV	DUMMY	IJSYSCT	1

News
 Escape
 Primary sublibrary
 Submit to batch
 VSAM files
 VSAM catalogs
 Delete OLPD
 Console commands
 Console output
 Batch queues
 Maintain appl. profiles
 Maintain sel. panels
 Maintain user profile

Batchonly user
 Defined w/o ICCF

ResClass | ICCF | Statistics

Password valid until:

View: ICCF Non-ICCF AND Typ 1 Typ 2 Typ 3 LookUp:

Userinformation received from host.

Close Refresh Help TimeOut for host-access: seconds



Operator Console via Navigator



e-business

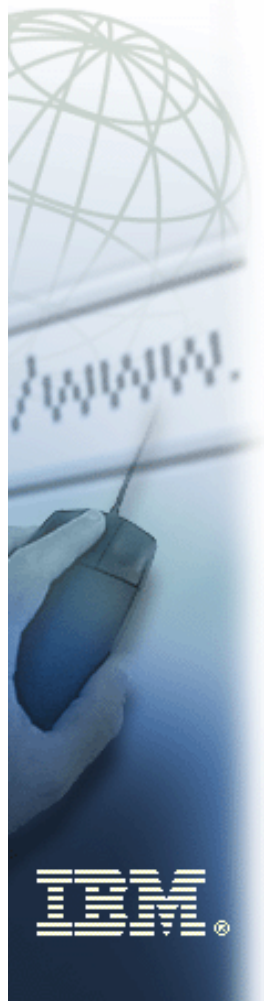

VSE/ESA Navigator - Console on VSEWM1

Console window | Console properties

```
map
AR 0015  SPACE AREA      V-SIZE  GETVIS  V-ADDR  UNUSED  NAME
AR 0015   S   SUP        680K      0          0      $$A$SUPX
AR 0015   S   SVA-24    1684K    1604K    AA000    128K
AR 0015   0   BG V      1280K    4864K    400000   24576K
AR 0015   1   F1 V       788K     812K    400000      OK POWSTART
AR 0015   2   F2 V     2048K   28672K   400000      OK CICSICCF
AR 0015   3   F3 V       600K    5544K   400000      OK VTAMSTRT
AR 0015   4   F4 V       768K     256K   400000      OK
AR 0015   5   F5 V       768K     256K   400000      OK
AR 0015   6   F6 V       256K     256K   400000      OK
AR 0015   7   F7 V     1024K   11264K   400000      OK TCPIP00
AR 0015   8   F8 V     3584K   27136K   400000      OK CICS2
AR 0015   9   F9 V     2560K   17920K   400000      OK ARIS61GD
AR 0015   A   FA V       256K     256K   400000      OK
AR 0015   B   FB V       256K     256K   400000      OK SECSERV
AR 0015   S   SVA-31    7096K    7240K   2200000
```

Command

map

Auto text function: Enter text that will be set to the command field after sending a command. Use % to indicate the initial position of the cursor. For e.g.: 0 1d sublib=%

Close Help

VSE Search utility

VS@

e-business

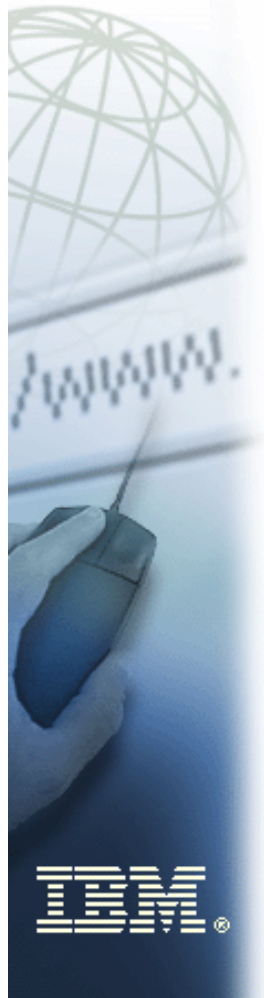

VSE/ESA Navigator - Search Utility

File name

Content text Case sensitive

Type of file

Date
vsewm://Librarian
vsewm://POWER
vsewm://POWER/RDR
vsewm://POWER/PUN

VSE/ESA Navigator - Search Utility

File name

Content text Case sensitive

Type of file

Date between and

	Member	Desc...	Path	Creati...
?	IPINIT00.L	ipinit	Librarian/PRD1.BASE	29.10.2001 - 03:18
?	IPINIT00.L	ipinit	Librarian/PRD2.CONFIG	05.03.2002 - 01:58

Search finished. Popup-menu of search results shows possible actions.