

Device Support Facilities



User's Guide and Reference

Release 17

Device Support Facilities



User's Guide and Reference

Release 17

Note:

Before using this information and the product it supports, be sure to read the general information under "Notices" on page 485.

Twenty-Fifth Edition, November 2003

This edition applies to Release 17 of the Device Support Facilities program and to all subsequent releases and modifications until otherwise indicated in new editions.

This edition replaces GC35-0033-25.

IBM® welcomes your comments. A form for readers' comments may be provided at the back of this document, or you may address your comments to the following address.

International Business Machines Corporation
Department 55JA, Mail Station P384
2455 South Road
Poughkeepsie, NY 12601-5400
United States of America

FAX (United States & Canada): 1+845+432-9405

FAX (Other Countries):

Your International Access Code +1+845+432-9405

IBMLink™ (United States customers only): IBMUSM10(MHVRCFS)

Internet e-mail: mhvrcfs@us.ibm.com

World Wide Web: <http://www.ibm.com/servers/eserver/zseries/zos/webqs.html>

If you would like a reply, be sure to include your name, address, telephone number, or FAX number.

Make sure to include the following in your comment or note:

- Title and order number of this document
- Page number or topic related to your comment

When you send information to IBM, you grant IBM a nonexclusive right to use or distribute the information in any way it believes appropriate without incurring any obligation to you.

© Copyright International Business Machines Corporation 1978, 2003. All rights reserved.

US Government Users Restricted Rights – Use, duplication or disclosure restricted by GSA ADP Schedule Contract with IBM Corp.

Contents

Figures	xv
Tables	xvii
About this document	xix
ICKDSF product library	xix
Additional reference information	xix
Softcopy documents on CD-ROM and DVD collections and the Internet	xxiii
Accessing LookAt message explanations	xxiii
Terminology	xxiv
How to use this document for your operating environment.	xxv
Summary of changes	xxvii

Part 1. Introducing ICKDSF 1

Chapter 1. Introduction to ICKDSF	3
About ICKDSF	3
Verifying your ICKDSF version	3
Running multiple ICKDSF jobs	3
Running ICKDSF on Dual Copy volumes.	3
ICKDSF commands	4
Operating systems that support ICKDSF	5
Versions that support ICKDSF commands	6
Storage requirements	6
Devices supported by ICKDSF	6
ICKDSF support of the RAMAC Array family	8
ICKDSF support of the Internal Disk	9
ICKDSF support of the 2105	9
Additional ICKDSF support information	10
Configuration checking	10
Processing on XRC volumes	10
Tasks you can perform with ICKDSF	11
Year 2000 support for ICKDSF	11
Chapter 2. About DASD storage media	13
DASD physical characteristics	13
Data checks	14
Degree of repeatability	14
Degree of visibility.	14
Correctable versus uncorrectable	14
Temporary versus permanent	15
Error notification	15
Chapter 3. Understanding ICKDSF command statements	17
ICKDSF command statement syntax	17
Conflicting keyword parameters	18
Abbreviating commands and parameters	18
Separating commands and parameters	18
Continuing lines	18
Commenting your code	19
Ending a command	19
Writing statements to control ICKDSF processing	19

Writing a SET statement	20
Writing the IF-THEN-ELSE statement	21
Writing the DO-END statement	22
Writing a null THEN and ELSE	23
Chapter 4. Getting started with the MVS version of ICKDSF	25
Overview of the ICKDSF tasks using the MVS version	25
Using JCL to run ICKDSF	27
Printed output data set	28
Using ISMF panels to run ICKDSF	28
Protecting MVS volumes and data sets	31
Protecting data sets in an offline mode	32
Protecting data sets in an online mode	32
Authorizing access with RACF	32
Limiting the use of resources with the Authorized Program Facility (APF)	34
Protecting ICKDSF commands with RACF	35
Processing in a shared environment	35
Preserving data during INSPECT	36
Preserving data during INSPECT under concurrent media maintenance	36
Operator's intervention consideration	36
Chapter 5. Getting started with the CMS version	39
Definition of a minidisk and dedicated device	39
Overview of ICKDSF tasks using the CMS version	39
Invoking ICKDSF under CMS from the console	42
Example of invoking ICKDSF from the console	42
Invoking ICKDSF with a CMS EXEC	43
Invoking ICKDSF with an input file	44
Using parameters to select the input and output devices	45
Supporting minidisks under the CMS version	45
Supporting general users without special authority	46
Using DEVMAINT authority	47
Supporting dedicated devices under the CMS version	48
Chapter 6. Getting started with the VSE version	49
Overview of the ICKDSF tasks using the VSE version	49
Running the VSE version of ICKDSF in batch mode	50
Running the VSE version of ICKDSF in command mode	51
Use of VSE ICKDSF command mode during VSE install process	52
Command mode restrictions	52
Verifying identification and preventing data loss	53
Processing in a shared environment	53
Sharing across multiple processors	53
Sharing across multiple users and partitions in a single processor	54
Chapter 7. Getting started with the Stand-Alone version	55
About the Stand-Alone version	55
Overview of the ICKDSF tasks using the Stand-Alone version	56
Creating an ICKDSF Stand-Alone IPL tape using MVS	58
Creating an ICKDSF Stand-Alone IPL tape using CMS	58
Preparing to use the Stand-Alone	58
IPLing the Stand-Alone ICKDSF	59
IPLing the Stand-Alone from a tape library	59
IPLing the Stand-Alone from SAPL	60
IPLing the Stand-Alone with a load parm specified	61
IPLing the Stand-Alone with no load parm specified	61

Loading the Stand-Alone ICKDSF from CD-ROM	62
Defining the input and output device	62
Interpreting error conditions	64
Performing ICKDSF tasks on minidisks with the Stand-Alone version	65
Chapter 8. ICKDSF versions supported as guests under VM.	67
Problem solving under VM	67

Part 2. Using ICKDSF to install and maintain CKD devices 69

Chapter 9. Examples of ICKDSF tasks—CKD devices	71
Installing devices	71
Completing the installation procedure	71
Installing a device from the factory.	71
Setting an IBM 3390 to 3380 track compatibility mode	72
Installing a 3375 or older HDA from the factory	72
Resuming initialization from a checkpoint location	73
Validating and writing the FFVDP	73
Validating part of a volume	73
Writing the FFVDP on part of a volume	74
Writing the FFVDP regardless of previous processing.	74
Validating from a specific point	74
Validating to a specific point	75
Validating and writing the FFVDP for one head	75
Validating the last heads of a device	75
Formatting devices	76
Formatting minidisks	76
Formatting an entire volume in the CMS version	76
Formatting part of a volume in the CMS version.	76
Writing the VTOC	77
Placing a VTOC at the end of a volume.	77
Determining the VTOC size and location	77
Expanding the VTOC at its current location	77
Changing the volume serial number and owner identification	77
Adding IPL text to a volume	78
Converting a volume to indexed format	78
Problem determination	78
Investigating suspected drive problems	79
Scanning data on part of a volume	79
Checking disk surfaces with INSPECT	80
Surface checking part of a volume.	80
Media maintenance	81
Conditionally assigning alternate tracks	81
Unconditionally assigning alternate tracks	82
Reclaiming a single flagged track	82
Reclaiming alternate tracks with INSPECT.	82
Finding where INSPECT failed	83
Saving data during surface checking	83
Emulating devices.	84
Using a 3995 Model 151 or 153 device	84
Initializing an emulated CKD device on a 3370 FBA device	85
Initializing an emulated CKD Device on an IBM 9313, 9332, or 9335 FBA device	85
Media maintenance on an emulated device	87
Performing miscellaneous tasks with ICKDSF	87
Clearing a storage path fence status	87

Erasing a volume	87
Printing a track assignment map	87
Chapter 10. AIXVOL command—CKD	89
Syntax	89
Required parameters.	89
Optional parameters	90
Formatting a cylinder with AIXVOL.	91
Errors reported by EXAMINE.	92
Minidisk support	92
Examples of the AIXVOL command	93
Formatting an entire volume	93
Formatting part of a volume	93
Inspecting a range of cylinders for errors	93
Rewriting the volume label	93
Chapter 11. ANALYZE command—CKD	95
Protecting the ANALYZE command with RACF	95
Syntax	95
Required parameters.	95
Optional parameters	96
Detecting hardware problems with DRIVETEST	101
Testing the drive and logical volume with ANALYZE	101
Path control under ANALYZE drive test	101
Verifying data records with ANALYZE	102
Data verification output	103
Unexpected I/O errors.	103
RANGE Parameters: specifying part of a volume	103
CMS version minidisk support	104
Dual copy volumes	105
Examples of the ANALYZE command	105
Analyzing volumes with the Stand-Alone version	105
Analyzing volumes with the CMS version.	106
Analyzing volumes with the MVS version.	106
Analyzing a volume with the VSE version.	106
Examples of path control under the ANALYZE drive test	107
Diagnostic messages	107
Drive test error summary.	107
Movable head error table.	108
Fixed-head error table.	109
Pathing reports	109
Path status table.	109
Logical path status table	111
Interface information	112
Host interface information	113
Fiber channel connection information	114
Example	114
Chapter 12. BUILDIX command—CKD	115
Protecting the BUILDIX command with RACF	115
Syntax	115
Required parameters	115
Optional parameters	116
Converting an OSVTOC to an indexed VTOC	116
Converting an indexed VTOC to an OSVTOC	117
Examples of the BUILDIX command	117

I
I

Changing an IXVTOC to an OSVTOC without operator's intervention	117
Building a VTOC index on a volume without an index allocated.	118
Building a VTOC index on a volume with an index allocated	118
Chapter 13. CONTROL command—CKD	121
Protecting the CONTROL command with RACF	121
Syntax	121
Required parameters	121
Optional parameters	122
Clearing a storage control without performing an IML	123
Allowing write operations through a storage control	123
Clearing a fenced path or device	124
Discarding data pinned in cache	125
Examples of the CONTROL command.	125
Clearing a WRITE INHIBITed storage control	125
Clearing a storage path fence status	125
Resetting indefinite status condition	126
Resetting a fence status	126
Display subsystem information.	126
Chapter 14. CPVOLUME command—CKD.	129
Formatting CP-owned volumes	129
Formatting CP-owned volumes for a specific VM operating system	129
Syntax	129
Required parameters	130
Optional parameters	131
Formatting cylinders	133
Formatting cylinder 0, track 0	133
Updating the allocation map	134
Examining volumes for errors	134
Displaying volume information	135
Rewriting the volume label	135
Copying data to a different device size.	135
Creating a minidisk allocation map	135
Examples of the CPVOLUME command	136
Formatting an entire volume	136
Formatting part of a volume.	136
Changing volume allocation.	136
Chapter 15. INIT command—CKD	137
Protecting the INIT command with RACF	138
Syntax	138
Required parameters	138
Optional parameters	139
Initializing volumes	150
Minimal initialization	151
Medial initialization	151
Initialization for open-system DASD	152
Processing in a shared environment	153
Processing in a shared DFSMS environment	153
Resuming after a job or system failure.	154
RANGE parameters: specifying part of a volume	154
CMS version minidisk support	156
Restoring FFVDP to a volume	156
Dual copy volumes	156
Examples of the INIT command	156

Initializing volumes for the MVS operating system	156
Initializing volumes with the Stand-Alone version	159
Initializing a minidisk in the CMS version	160
Initializing volumes with the VSE version	160
Chapter 16. INSPECT command—CKD	161
Protecting the INSPECT command with RACF	161
Understanding which INSPECT parameters to use	161
Syntax	163
Required parameters	163
Optional parameters	164
Controlling the level of surface checking	174
RANGE parameters: part of a volume	175
Assigning alternate tracks	176
Resource serialization when using INSPECT	177
Recovering data after a job or system failure	178
Preserving data during INSPECT.	179
Keeping your data in storage or in storage and backup	180
Preserving data under Concurrent Media Maintenance	180
Dual copy volumes	181
CMS version minidisk support	181
Examples of the INSPECT command	182
Inspecting volumes with the MVS version.	182
Producing a volume map of an entire volume in a Stand-Alone version	183
Inspecting volumes with the CMS version	183
Checking tracks for defects in the VSE version	184
Chapter 17. INSTALL command—CKD	185
Protecting the INSTALL command with RACF	186
Installing relocated devices	186
3380	186
3390	186
9345	186
Changing the mode of 3390 volumes	186
Syntax	186
Required parameters	187
Optional parameters	187
Resuming after a job or system failure.	188
Processing in a shared environment	188
Examples of the INSTALL command	189
Installing and initializing a volume	189
Converting an IBM 3390 to 3380 track compatibility mode	189
Chapter 18. IODELAY command—CKD	191
Protecting the IODELAY command with RACF	191
Syntax	191
Required parameters	191
Optional parameters	192
Examples of the IODELAY command	192
Delaying 100 ms after every 20 operations with the MVS version	192
Chapter 19. PPRCOPY commands—CKD	195
Protecting the PPRCOPY command with RACF	195
How PPRC works	195
Non-cascading	196
Cascading	196

I
I

	Managing asynchronous PPRC: extended distance mode	196
	Understanding how PPRC extended distance works	197
	Setting up your environment to use PPRC extended distance	197
	Using PPRC extended distance	197
	Establishing PPRC volume pairs	197
	Using synchronous and asynchronous PPRC	198
	Using cascading	198
	Establishing PPRC cascaded pairs	199
	Long distance data migration	200
	Converting from one PPRC volume state to another	200
	Monitoring PPRC volume pairs	202
	PPRCOPY FAILOVER and FAILBACK	202
	Using Freeze/Run	202
	ICKDSF Peer-to-Peer Remote Copy command functions	202
	Peer-to-Peer Remote Copy hardware requirements	203
	Peer-to-Peer Remote Copy (PPRC) restrictions	204
	Setting up the PPRC environment	204
	Identifying volume pairs	205
	Establishing the PPRC configuration	205
	Configuring storage subsystem resources for PPRC	206
	Controlling ICKDSF activity to PPRC volumes	207
	PPRCOPY ESTPATH—establishing paths	208
	Syntax	210
	Required parameters	210
	Optional parameters	215
	Examples	215
	PPRCOPY DELPATH—deleting paths	216
	Syntax	216
	Required parameters	217
	Optional parameters	218
	Example	219
	PPRCOPY ESTPAIR—establishing pairs	219
	Syntax	220
	Required parameters	221
	Optional parameters	222
	Example	225
	PPRCOPY DELPAIR—deleting pairs	226
	Syntax	226
	Required parameters	226
	Optional parameter	227
	Example	227
	PPRCOPY FREEZE—suspend all operations for all PPRC volumes on a single	
	storage control.	228
	Syntax	228
	Required parameters	228
	Example	229
	PPRCOPY RUN—resume all operations for all PPRC volumes on a single	
	storage control.	229
	Syntax	230
	Required parameters	230
	Example	231
	PPRCOPY SUSPEND—suspending pairs	231
	Syntax	232
	Required parameters	232
	Optional parameters	233
	Example	233

PPRCOPY RECOVER—recovering data on the recovery system	233
Syntax	234
Required parameters	234
Optional parameters	235
Example	235
PPRCOPY QUERY—querying status	235
Syntax	236
Required parameters	236
Optional parameters	236
Using PPRCOPY QUERY without the PATHS parameter	236
Using PPRCOPY QUERY with the PATHS parameter	240
Establishing and managing PPRC volumes and paths	243
Managing the PPRC system	243
Identifying Peer-to-Peer Remote Copy volume states	244
Details for setting cache and non-volatile storage	245
Obtain SSID, serial number, CCA, and LSS	247
Obtain physical 3990 interface and ESCON Director address	248
Establishing paths	249
Managing volumes and paths	250
Examples for using FAILOVER and FAILBACK	254
Chapter 20. REFORMAT command—CKD	257
Protecting the REFORMAT command with RACF	257
Syntax	257
Required parameters	258
Optional parameters	259
Examples of the REFORMAT command	263
Reformatting volumes with the MVS version	264
Using the REFORMAT command with the CMS version	266
Changing the volume serial number in the VSE version	267
Chapter 21. REVAL command—CKD	269
Protecting the REVAL command with RACF	270
Syntax	270
Required parameters	270
Optional parameters	271
Formatting tracks and reassigning alternate tracks	272
Repairing the cause of specific '4E4E' SIMS	273
Recommendation	273
Resuming after a job or system failure	274
Examples of the REVAL command	274
Running REVAL with FIXSIM	274
Reinitializing a volume	274
Chapter 22. TRKFMT command—CKD	275
Protecting the TRKFMT command with RACF	275
Syntax	275
Required parameters	276
Optional parameters	279
Handling of checkpoint data from a previous command	280
RANGE parameters: part of a volume	280
Resource serialization when using TRKFMT	281
Examples of the TRKFMT command	281
Processing tracks with the MVS version	282
Processing tracks in a Stand-Alone version	282
Processing tracks in a CMS version	282

Part 3. Using ICKDSF to install and maintain FBA devices 285

Chapter 23. Examples of ICKDSF tasks—FBA devices. 287

- Installing New devices. 287
 - Initializing a replaced HDA with a minimal INIT. 287
- Resuming initialization from a checkpoint location 288
- Formatting devices 289
 - Formatting FBA minidisks 289
 - Formatting an entire volume with the CMS version 289
 - Changing the volume serial Number and owner identification 289
 - Placing an FBAVTOC at the end of a volume 289
 - Writing the FBAVTOC 290
- Problem determination 290
 - Investigating suspected drive problems 290
 - Finding where INSPECT failed 291
 - Checking disk surfaces 291
- Media maintenance. 292
 - Conditionally assigning alternate blocks 292
 - Unconditionally assigning alternate blocks 292
 - Reclaiming flagged blocks 293
 - Saving data during surface checking 293
- Performing miscellaneous tasks with ICKDSF 295
 - Erasing a volume 295
 - Printing a block assignment map 295
 - Emulating a CKD device on an FBA device 295

Chapter 24. ANALYZE command—FBA. 297

- Syntax 297
 - Required parameters 297
 - Optional parameters 298
- Detecting hardware problems with DRIVETEST 299
 - Testing the drive and logical volume with ANALYZE 299
 - Verifying data records with ANALYZE 300
- Solving problems with ANALYZE output 300
 - Assumed conditions when running ANALYZE 301
- CMS version minidisk support 301
- Examples of the ANALYZE command 301
 - Analyzing volumes with the Stand-Alone version 301
 - Analyzing volumes with the CMS version. 302
 - Analyzing a VSE version volume 302
- Diagnostic messages 303

Chapter 25. CPVOLUME command—FBA 305

- Formatting CP volumes for a specific VM operating system 305
- Syntax 305
 - Required parameters 305
 - Optional parameters 306
- Formatting pages 308
 - Formatting blocks 0-15 309
 - Updating the allocation map 309
 - Examining pages for errors 309
 - Displaying volume information 309
 - Rewriting the volume serial 310
- Copying data to a different device size. 310

Creating a minidisk allocation map	310
Examples of the CPVOLUME command	310
Formatting an entire volume	310
Formatting part of a volume	311
Changing volume allocation	311
Chapter 26. INIT command—FBA	313
Syntax	313
Required parameters	314
Optional parameters	314
Initializing a volume at the minimal level	318
Initializing a volume at the maximal level	318
Resuming after a job or system failure	319
CMS version minidisk support	319
Examples of the INIT command	319
Initializing volumes with the Stand-Alone version	320
Initializing a VSE version FBA volume	320
Initializing a minidisk in the CMS version for a VSE environment	320
Chapter 27. INSPECT command—FBA	323
Understanding which INSPECT parameters to use	323
Syntax	324
Required parameters	324
Optional parameters	325
Assigning alternate blocks	328
Preserving data during INSPECT	329
Writing data from a backup or storage location	329
Retrieving data from the backup location	329
Recovering data after a job or system failure	330
CMS version minidisk support	331
Examples of the INSPECT command	331
Inspecting volumes with the Stand-Alone version	331
Inspecting volumes with the VSE version	332
Inspecting volumes with the CMS version	333
Chapter 28. IODELAY command—FBA	335
Syntax	335
Required parameters	335
Optional parameters	335
Examples of the IODELAY command	336
Delaying 100 ms after every 20 operations	336
Chapter 29. MAPALT command—FBA	337
Syntax	337
Required parameters	337
Optional parameters	338
Reading the MAPALT report output	338
MAPALT diagnostic output	339
Examples of the MAPALT command	339
Mapping volumes with the Stand-Alone version	339
Mapping a full VSE version volume	340
Chapter 30. REFORMAT command—FBA	341
Syntax	341
Required parameters	341
Optional parameters	342

Examples of the REFORMAT command	342
Reformatting volumes with the VSE version	343
Reformatting a minidisk in the CMS version	343
Appendix A. Device Support Facilities messages (ICK)	345
Message routing and descriptor codes	345
Messages received at the output printer	357
Appendix B. Volume layout and record formats on CKD Devices	461
Example of a 3380 volume map	462
Track contents after initialization	463
IPL bootstrap record contents	463
How track associations are recorded	464
Appendix C. VTOC index	465
Calculating the size of the VTOC	465
Calculating the size of the VTOC index	465
Calculating the number of tracks for the index	466
Determining how many VIERS you need	467
Appendix D. Fixed block architecture VTOC (FBAVTOC)	469
Label record format	469
FBAVTOC space requirements	470
Appendix E. Surface checking	471
Surface checking for possible defects	471
Primary checking	471
Primary checking for CKD devices	472
Primary checking for FBA devices	472
Skip displacement checking	472
CHECK(n) values	473
Appendix F. User security exit module	475
Loading registers	475
Return codes for password-protected data sets	476
Return codes for VSAM and unexpired data sets	476
Return codes for the IBM module	476
Replacing the IBM-supplied user exit routine	477
Appendix G. ICKMCLVL macro	479
Appendix H. Calling ICKDSF from an application program	481
Appendix I. Accessibility	483
Using assistive technologies	483
Keyboard navigation of the user interface	483
Notices	485
Programming interface information	486
Trademarks	486
Glossary	489
Index	497

Figures

1.	A DASD read-write head positioned on a disk	13
2.	How service information messages are generated	15
3.	ICKDSF command statement	17
4.	IF-THEN-ELSE statement	21
5.	DO-END statement	22
6.	IF-THEN-ELSE DO-END statement	23
7.	ICKDSF tasks using the MVS version	26
8.	Running ICKDSF with JCL	27
9.	ISPF PRIMARY OPTION MENU panel	29
10.	ISMF PRIMARY OPTION MENU - z/OS DFSMS V1 R3 panel	29
11.	VOLUME LIST SELECTION MENU	30
12.	VOLUME SELECTION ENTRY PANEL.	30
13.	VOLUME LIST	31
14.	ICKDSF tasks using the CMS version	40
15.	Invoking ICKDSF interactively from the console	43
16.	CPLIST EXEC.	44
17.	FMTMDVOL INPUT A	44
18.	Invoking ICKDSF interactively with input file FMTMDVOL	45
19.	ICKDSF tasks using the VSE version of ICKDSF	50
20.	Example of executing the VSE version of ICKDSF in batch mode	51
21.	Example of executing the VSE version of ICKDSF in command mode	52
22.	ICKDSF tasks using the Stand-Alone version	57
23.	MVS JCL to copy Stand-Alone ICKDSF to tape	58
24.	CMS EXEC to copy Stand-Alone ICKDSF to tape.	58
25.	Drive test error summary for the IBM 3380 and 3390	108
26.	Movable head error table—CKD.	108
27.	Fixed-head error table	109
28.	Volume state transitioning	201
29.	Movable-head error table—FBA	303
30.	CKD track and record formats	461
31.	Volume map output (CKD devices).	462
32.	Cylinder 0, track 0 layout (CKD devices).	463
33.	Primary/alternate track association (3390 model 2)	464
34.	Format of a FBAVTOC control interval	470
35.	Overriding ICKUSER1 to change return codes	477
36.	Link-edit for ICKUSER1	477
37.	ICKDSF invocation parameter list	481

Tables

1. Storage hardware documents	xx
2. Storage subsystem library	xx
3. Tape library information	xxi
4. 3990 storage control documents	xxi
5. Physical planning and reference information	xxii
6. Interactive Storage Management Facility (ISMF) information.	xxii
7. VSE system information	xxii
8. Icon symbols	xxv
9. ICKDSF commands	4
10. Commands supported by each version of ICKDSF	6
11. CKD devices and storage subsystems supported by ICKDSF commands	7
12. CKD devices and storage subsystems supported by ICKDSF commands	7
13. FBA devices supported by ICKDSF commands	8
14. Errors that prevent reading and writing of data	13
15. Command-statement elements	17
16. ICKDSF MVS RACF authorization table	32
17. Codes returned by the user security exit module for password protected data sets	34
18. RACF facility class profile names for ICKDSF commands	35
19. Devices supported by ICKDSF commands (minidisks under CMS)	45
20. ICKDSF Commands available to general users without special authority	46
21. ICKDSF Commands available to users with DEVMAINT authority	47
22. Using ICKDSF command parameters for security	53
23. IPL error PSW codes	64
24. ICKDSF commands	65
25. ICKDSF Commands that operate on a minidisk from a guest operating system	67
26. Problem solving under VM	68
27. Number of CKD records formatted per track by AIXVOL command	91
28. Parameter conditions	104
29. Path controls when running ANALYZE drive test	107
30. Path controls when running ANALYZE drive test	107
31. Path status table for the IBM 3380 and 3390	110
32. Path status table for the IBM 9345	110
33. Logical path status table.	111
34. Interface information	113
35. Host interface information	113
36. Number of CKD records formatted by CPVOLUME command	133
37. Maximum size permitted for the IPL program record	145
38. Mimic parameter for the INIT command	147
39. VTOC parameter for the INIT command	149
40. Parameter conditions when specifying part of a volume	155
41. Performing tasks with INSPECT parameters	161
42. The MIMIC parameter of the INSPECT command	169
43. Parameter conditions when specifying part of the volume	175
44. Assigning alternate tracks with INSPECT parameters	176
45. Where INSPECT rewrites the data of a defective track	177
46. Transitioning between volume states	201
47. PPRCopy ICKDSF commands	203
48. 3990 NVS and cache requirements for PPRC.	206
49. Field descriptions	237
50. Path status codes	241
51. 3990 Model 6 NVS and cache requirements	245
52. Determining LCU and CCA values for RVA	253
53. Determining SAID values for RVA	254

54. Maximum size for IPL program record	261
55. Maximum block and page numbers for FBA devices	308
56. Performing tasks with INSPECT parameters	323
57. Assigning alternate blocks with INSPECT parameters	328
58. MAPALT report (first part)	338
59. IPL bootstrap records.	464
60. Table of maximum VTOC and VTOC index sizes	466
61. Offsets of return codes for the IBM-supplied user exit module	476
62. Expansion of macro ICKMCLVL	480

About this document

This document describes the IBM Device Support Facilities (ICKDSF) product used with IBM direct access storage device (DASD) subsystems.

This document is for system programmers, system operators, and other data processing personnel who manage, maintain, or use DASD.

If you are experiencing problems

This document is a reference for ICKDSF. If you have device errors or media maintenance problems:

- For IBM 9345 DASDs, see:
 - *9340 Customer Guide for Using SIMs*, GC26-4858
- For any other IBM DASDs, see:
 - *Maintaining IBM Storage Subsystem Media*, GC26-4495
- For the Internal Disk Feature of the S/390® Multiprise® 2000 and Multiprise 3000, see:
 - *Internal Disk Subsystem Reference Guide, S/390*, SA24-4260
 - *Internal Disk Subsystem User's Guide, S/390*, SA24-4261
 - *Internal Disk Reference Guide, S/390 Multiprise 3000*, SA22-1025
 - *Internal Disk User's Guide, S/390 Multiprise 3000*, SA22-1026

For information about the accessibility features of z/OS®, for users who have a physical disability, see Appendix I, “Accessibility,” on page 483.

ICKDSF product library

The documents in the ICKDSF library are:

Device Support Facilities User's Guide and Reference, GC35-0033. This document gives detailed instructions for using the ICKDSF product.

Device Support Facilities Release 17 System Control Programming Specifications, GC26-3946. This document gives the specifications on the ICKDSF program.

Additional reference information

To use this product effectively, you should read, or have for reference, the following documents.

9340 Customer Guide for Using SIMs, GC26-4858, for information on error conditions and guidelines for performing media maintenance on 9340 subsystems.

Internal Disk Subsystem Reference Guide, S/390, SA24-4260, *Internal Disk Subsystem User's Guide, S/390*, SA24-4261, *Internal Disk Reference Guide, S/390 Multiprise 3000*, SA22-1025, *Internal Disk User's Guide, S/390 Multiprise 3000*, SA22-1026, for information and guidelines for using the Internal Disk feature of the S/390 Multiprise 2000 and Multiprise 3000.

Maintaining IBM Storage Subsystem Media, GC26-4495, for information on error conditions and guidelines for performing media maintenance on IBM subsystems other than the 9340.

About this document

EREP Reference, GC35-0152, *EREP User's Guide*, GC35-0151, for detailed information on the many reports to monitor system activity.

You should also have a complete set of documents about your operating system.

The following tables contain reference information that is divided into two parts. The documents listed in "Part One" and "Part Two" contain more detailed information on subjects described in this document. For each document, the tables show the titles with the document order number and a short description of its contents.

Part One contains hardware information. Storage hardware maintenance publications, Storage Subsystem Library documents, tape library publications, storage control documents, and documents containing information on physical planning and reference.

Part Two contains software information related to various operating environments.

Part One—hardware documents

The documents listed below contain detailed information on hardware-related subjects.

Table 1. Storage hardware documents

Title	Order Number	Contents
<i>9340 Customer Guide for Using SIMs</i>	GC26-4858	Information on using SIMs to recognize and respond to 9340 subsystem problems.
<i>EREP User's Guide</i>	GC35-0151	Description of EREP functions and commands for DASD media reporting.
<i>EREP Reference</i>	GC35-0152	Description of EREP functions and commands for DASD media reporting.
<i>Device Support Facilities User's Guide and Reference</i>	GC35-0033	Description of ICKDSF functions and commands for DASD initialization and maintenance.
<i>Maintaining IBM Storage Subsystem Media</i>	GC26-4495	Description of DASD media maintenance and error handling.
<i>Device Support Facilities Release 17 System Control Programming Specifications</i>	GC26-3946	Description of DASD media maintenance and error handling.
<i>Internal Disk Subsystem User's Guide, S/390</i>	SA24-4261	Description of S/390 Multiprise Internal Disk Subsystem.
<i>Internal Disk Subsystem Reference Guide, S/390</i>	SA24-4260	Description of S/390 Multiprise Internal Disk Subsystem.
<i>Internal Disk Reference Guide, S/390 Multiprise 3000</i>	SA22-1025	Description of S/390 Multiprise Internal Disk Subsystem.
<i>Internal Disk User's Guide, S/390 Multiprise 3000</i>	SA22-1026	Description of S/390 Multiprise Internal Disk Subsystem.

Table 2. Storage subsystem library

Title	Order Number	Contents
<i>Using the IBM RAMAC Array Subsystem in an MVS, VM, or VSE Environment</i>	GC26-7005	Information about using SIMs.
<i>3380 DASD Introduction</i>	GC26-4491	Overview of all 3380 models.

Table 2. Storage subsystem library (continued)

Title	Order Number	Contents
<i>3380 Model CJ2 Introduction and Reference</i>	GC26-4497	Overview of functions and reference information for 3380 Model CJ2.
<i>IBM 3390 Direct Access Storage Introduction</i>	GC26-4573	Overview of all 3390 models.
<i>3390 Reference Summary</i>	GX26-4577	Summary card containing 3390 device characteristics.
<i>3380, 3390, and 3990 Master Index and Glossary</i>	GC26-4496	Index to information in Storage Subsystem Library documents.
<i>Using IBM 3390 in an MVS Environment</i>	GC26-4574	Discussion of 3390 use under MVS.
<i>Using IBM 3390 Direct Access Storage in a VM Environment</i>	GC26-4575	Discussion of 3390 use under VM.
<i>Using IBM 3390 Direct Access Storage in a VSE Environment</i>	GC26-4576	Discussion of 3390 use under VSE.
<i>IBM 9340 Direct Access Storage Subsystems Introduction</i>	GC26-4694	Overview of 9340 models.
<i>IBM 9340 DASD Subsystems Reference Summary</i>	GX26-3778	Reference of device characteristics, channel commands, and sense byte information.
<i>Introduction to Nonsynchronous Direct Access Storage Subsystems</i>	GC26-4519	Provides specific information for programmers responsible for writing DASD channel programs that operate in a nonsynchronous environment.
<i>Using 9340 DASD Subsystems in an MVS Environment</i>	GC26-4646	Discussion of 9340 use under MVS.
<i>Using IBM 9340 Direct Access Storage Subsystems in a VM/ESA Environment</i>	GC26-4644	Discussion of 9340 use under VM/ESA.
<i>Using IBM 9340 Direct Access Storage Subsystems in a VSE/ESA Environment</i>	GC26-4645	Discussion of 9340 use under VSE/ESA.
<i>IBM 9340 Direct Access Storage Subsystems Reference</i>	GC26-4647	Contains reference information for the 9340 subsystem.
<i>IBM 9340 DASD Subsystems Reference Summary</i>	GX26-3778	Summarizes 9340 subsystem information and characteristics.

Table 3. Tape library information

Title	Order Number	Contents
<i>IBM TotalStorage Enterprise Automated Tape Library (3494) Operator's Guide</i>	GA32-0449	Provides details on how to set up and use a stand-alone device.
<i>IBM TotalStorage Enterprise Automated Tape Library (3494) Introduction and Planning Guide</i>	GA32-0448	Provides details on how to set up and use a stand-alone device.

Table 4. 3990 storage control documents

Title	Order Number	Contents
<i>IBM Cache Device Administration</i>	GC35-0101	Describes the IDCAMS cache utility commands necessary to manage cache and to obtain information about cache status and performance.

About this document

Table 4. 3990 storage control documents (continued)

Title	Order Number	Contents
<i>IBM 3990/9390 Storage Control Introduction</i>	GA32-0098	Overview of 3990/9390 storage control unit functions.
<i>IBM 3990/9390 Storage Control Planning, Installation, and Storage Administration Guide</i>	GA32-0100	Detailed information on installation and use of the 3990/9390 storage control.
<i>IBM 3990 Storage Control Reference (Models 1, 2, and 3)</i>	GA32-0099	Information on the 3990 channel interface (channel commands and sense bytes).
<i>Introduction to Nonsynchronous Direct Access Storage Subsystems</i>	GC26-4519	Describes nonsynchronous operation and provides descriptions of the ECKD command set and ECKD channel programs.
<i>z/OS DFSMS Advanced Copy Services</i>	SC35-0428	Describes remote copy functions and how to implement both Peer-to-Peer Remote Copy and extended remote copy for backup and recovery of data should a disaster occur to your data center.

Table 5. Physical planning and reference information

Title	Order Number	Contents
<i>IBM 3390 Direct Access Storage Migration Guide</i>	GG24-3373	Provides guidelines and detailed procedures for moving MVS and VM data to 3390 from other DASD.

Note: This reference document is no longer orderable.

Part Two—software documents

The documents listed below contain detailed information on software-related subjects described in this document.

Table 6. Interactive Storage Management Facility (ISMF) information

Title	Order Number	Contents
<i>z/OS DFSMS: Using the Interactive Storage Management Facility Release 3</i>	SC26-7411	Describes how to use ISMF to perform data and storage management tasks.

Table 7. VSE system information

Title	Order Number	Contents
<i>IBM VSE/Enterprise Systems Architecture Messages and Codes Volume 1 Version 2 Release 6</i>	SC33-6796	Provides explanations for messages issued by VSE/ESA and its component programs.
<i>IBM VSE/Enterprise Systems Architecture Messages and Codes Volume 2 Version 2 Release 6</i>	SC33-6798	Provides explanations for messages issued by VSE/ESA and its component programs.
<i>IBM VSE/Enterprise Systems Architecture Messages and Codes Volume 3 Version 2 Release 6</i>	SC33-6799	Provides explanations for messages issued by VSE/ESA and its component programs.
<i>VSE/ESA System Utilities</i>	SC33-6517	Description of VSE/ESA utilities, including Fast Copy.
<i>IBM VSE/Enterprise Systems Architecture VSE Central Functions Supervisor Diagnosis Reference Version 6 Release 4</i>	SC33-6323	Contains information related to VSE supervisor services.

Table 7. VSE system information (continued)

Title	Order Number	Contents
IBM VSE/Enterprise Systems Architecture VSE Central Functions Initial Program Load and Job Control Diagnosis Reference Version 6 Release 6	SC33-6325	Describes the diagnosis reference material for the VSE central functions initial program load and job control.
IBM VSE/Enterprise Systems Architecture VSE Central Functions Diagnosis Reference LIOCS Version 6 Release 4	SC33-6336	Contains information related to the VSE logical IOCS support.

Softcopy documents on CD-ROM and DVD collections and the Internet

This document will also be available on the following collections the next time they are updated:

z/OS V1Rx Collection, SK3T-4269

z/OS V1Rx and Software Products DVD Collection, SK3T-4271

VM Collection, SK2T-2067

VSE Collection, SK2T-0060

OS/390 Collection, SK2T-6700

OS/390 V2R10 PDF Library Collection, SK2T-6718

This document will also be available in BookManager[®] and PDF format on the z/OS Internet library at:

<http://www.ibm.com/servers/eserver/zseries/zos/bkserv/>

Using a BookManager READ program, you can view and find information quickly in BookManager documents in a variety of environments. You can view the documents directly from a CD-ROM or DVD, or copy the documents to a shared workstation or local area network (LAN) server. You can also transfer the documents to your host system or view them on the Internet. For instance, the z/OS product includes both BookManager READ for host viewing and BookManager BookServer, which allows you to access and read documents over an Internet or intranet connection using an HTML browser. From CD-ROM or DVD you can use any supported IBM BookManager reader, such as the IBM Softcopy Reader. For more information, see:

<http://www.ibm.com/servers/eserver/zseries/softcopy/>

You can view and print PDF files using an Adobe Acrobat Reader available free on the Internet at:

<http://www.adobe.com/prodindex/acrobat/>

Accessing LookAt message explanations

LookAt is an online facility that lets you look up explanations for most of the IBM[®] messages you encounter, as well as for some system abends and codes. Using LookAt to find information is faster than a conventional search because in most cases LookAt goes directly to the message explanation.

You can use LookAt from the following locations to find IBM message explanations for z/OS elements and features, z/VM[®], and VSE:

About this document

- The Internet. You can access IBM message explanations directly from the LookAt Web site at <http://www.ibm.com/eserver/zseries/zos/bkserv/lookat/>.
- Your z/OS TSO/E host system. You can install code on your z/OS or z/OS.e systems to access IBM message explanations, using LookAt from a TSO/E command line (for example, TSO/E prompt, ISPF, or z/OS UNIX System Services running OMVS).
- Your Windows® workstation. You can install code to access IBM message explanations on the *z/OS Collection* (SK3T-4269), using LookAt from a Windows DOS command line.
- Your wireless handheld device. You can use the LookAt Mobile Edition with a handheld device that has wireless access and an Internet browser (for example, Internet Explorer for Pocket PCs, Blazer, or Eudora for Palm OS, or Opera for Linux handheld devices). Link to the LookAt Mobile Edition from the LookAt Web site.

You can obtain code to install LookAt on your host system or Windows workstation from a disk on your *z/OS Collection* (SK3T-4269), or from the LookAt Web site (click **Download**, and select the platform, release, collection, and location that suit your needs). More information is available in the LOOKAT.ME files available during the download process.

Terminology

You should understand what the following terms mean in this document:

Dedicated device refers to a device dedicated to a virtual machine by either a DEDICATE control statement in the VM user directory or the CP ATTACH command.

Device refers to a uniquely addressable part of the DASD unit that includes a set of access arms, their associated surfaces, and the electronic circuitry needed to locate, read, and write data.

Formatting a volume refers to making a volume usable in a specific operating environment.

Maximal initialization or **maximal INIT** refers to using the INIT command to check the track surface and then perform the minimal INIT. You can only perform maximal INIT on 3370 and 9335 devices.

Medial initialization or **medial INIT** refers to using the INIT command to validate the home address and record 0, and then perform a minimal INIT on a volume.

The medial INIT is recommended for 3375 and older devices, such as:

- A new DASD unit
- A replaced or upgraded head disk assembly (HDA)
- A DASD unit that has been physically relocated

For 3380, 3390, and 9345 devices, use the INSTALL command.

Minimal initialization or **minimal INIT** refers to using the INIT command to write the volume label and volume table of contents (VTOC) on volumes for use by MVS or VSE operating systems.

MVS refers to the OS/390 and z/OS operating systems.

SA refers to the ICKDSF Stand-Alone version.

Volume refers to the DASD space identified by a common label and accessed by any of a set of related addresses.

VM refers to the VM/ESA and z/VM operating systems.

VSE refers to the VSE/ESA operating systems.

Additional terms used in this document are given in the glossary.

How to use this document for your operating environment





This document is organized for quick retrievability of ICKDSF information.

In addition, icon symbols begin sections, paragraphs, and list items that describe specific ICKDSF versions or operating systems information. An icon, or set of icons indicates information that is specific to a version or operating system. If placed in the left margin it references the paragraph to its right, if placed above a section it references that section, and if placed in the left margin next to a list item it references that list item.

This document is designed so you can discard those pages that do not pertain to your installation. For example, if you are running exclusively in an MVS environment, you can discard the chapters that describe using ICKDSF in other environments, and Part 3, "Using ICKDSF to install and maintain FBA devices," on page 285.

Table 8 contains the icon symbols and describes how they are used in this document.

Table 8. Icon symbols

Icon symbol	Description
	MVS version of ICKDSF Note: When MVS is referenced in this document, it includes OS/390 and z/OS unless specifically indicated otherwise.
	CMS version of ICKDSF
	VM operating environment Note: When VM is referenced in this document, it includes VM/ESA and z/VM unless specifically indicated otherwise.
	VSE version of ICKDSF
	Stand-Alone version of ICKDSF Note: When Stand-Alone/XA is referenced in this document, it also applies to Stand-Alone/ESA.

About this document

Summary of changes

The summary of changes informs you of changes to this document. Vertical bars in the left margin of the document indicate changes from the previous edition.

Summary of changes for GC35-0033-26, Release 17

This document contains information that was previously presented in *Device Support Facilities User's Guide and Reference Release 17*, GC35-0033-25. The following sections summarize the changes to that information.

New information

This edition includes the following new information:

- Added “Using cascading” on page 198.
- Added “Using Freeze/Run” on page 202.
- Additional ESTPATH parameters:
 - ESTPATH: “FCPPATHS parameter: establishes PPRC with Fibre Channel Protocol (FCP) paths” on page 211.
 - ESTPATH: “WWNN parameter: establishes the World Wide Node Name (WWNN) of the primary and secondary” on page 211.
 - ESTPATH: “CGROUP parameter: how an error that is related to a PPRC device is reported by the 2105” on page 215.
- Additional ESTPATH examples:
 - ESTPATH: “PPRC-FCP path example” on page 216.
 - ESTPATH: “Multiple PPRC-FCP path example” on page 216.
- Additional DELPATH parameters:
 - DELPATH: “FCPPATHS parameter: identifies PPRC with Fibre Channel Protocol (FCP) paths” on page 218.
 - DELPATH: “WWNN parameter: identifies the World Wide Node Name (WWNN) of the primary and secondary” on page 218.
- Additional DELPATH example:
 - DELPATH: “PPRC-FCP path example” on page 219.
- Additional FREEZE parameters:
 - FREEZE: “DDNAMEISYSNAMEIUNITADDRESS parameter: identify the primary volume” on page 228.
 - FREEZE: “PRIMARY and SECONDARY parameter: identifies the control unit” on page 229.
 - FREEZE: “LSS parameter: identify logical subsystem number” on page 229.
- Additional FREEZE example:
 - FREEZE: PPRC FREEZE UNIT; see “Example” on page 229.
- Additional FREEZE information:
 - “PPRCOPY FREEZE—suspend all operations for all PPRC volumes on a single storage control” on page 228.
- Additional RUN parameters:
 - RUN: “DDNAMEISYSNAMEIUNITADDRESS parameter: identify the primary volume” on page 230.
 - RUN: “PRIMARY and SECONDARY parameter: identifies the control unit” on page 230.

- RUN: “LSS parameter: identify logical subsystem number” on page 231.
- Additional RUN example:
 - RUN: PPRC RUN UNIT; see “Example” on page 231.
- Additional RUN information:
 - “PPRCOPY RUN—resume all operations for all PPRC volumes on a single storage control” on page 229.
- Additional ANALYZE parameter:
 - ANALYZE: “SECWWNN parameter: specifies the WWNN of a volume” on page 99.
- Additional ANALYZE information:
 - ANALYZE: “Fiber channel connection information” on page 114.
- Additional ESTPAIR parameter:
 - ESTPAIR: “CASCADE parameter: make a volume eligible for or establish it as a cascading volume” on page 222.
 - ESTPAIR: “ONLINSEC parameter: specifies online secondary volume (2105 devices only)” on page 224.
- Added “Processing on XRC volumes” on page 10.
- Added “IPLing the Stand-Alone from SAPL” on page 60.
- Added and changed messages; see Appendix A, “Device Support Facilities messages (ICK),” on page 345.
- Assistive features; see Appendix I, “Accessibility,” on page 483.
- Added Appendix H, “Calling ICKDSF from an application program,” on page 481.

Changed information

This edition contains changed information:

- Messages; see Appendix A, “Device Support Facilities messages (ICK),” on page 345.
- “Using synchronous and asynchronous PPRC” on page 198.
- “ICKDSF Peer-to-Peer Remote Copy command functions” on page 202.
- ESTPAIR examples; see “MODE parameter: copy mode” on page 224 and “OPTION parameter: additional options” on page 225.
- Status field descriptions; see Table 49 on page 237.
- “Using PPRCOPY QUERY with the PATHS parameter” on page 240.
- Path status codes; see Table 50 on page 241.
- “Console device status commands” on page 244.
- “Obtain SSID, serial number, CCA, and LSS” on page 247.
- “Establishing paths” on page 249.
- “PPRCOPY QUERY with the PATHS parameter” on page 251.
- “Deleting a PPRC volume pair” on page 252.

Moved information

This edition does not include moved information.

Deleted information

This edition does not include deleted information.

Summary of changes for GC35-0033-25, Release 17

This document contains information that was previously presented in *Device Support Facilities User's Guide and Reference Release 17*, GC35-0033-24. The following sections summarize the changes to that information.

New information

This edition includes the following new information:

- PPRC Failover and Failback support.
- Added messages; see Appendix A, "Device Support Facilities messages (ICK)," on page 345.

Changed information

This edition does not contain changed information.

Moved information

This edition does not include moved information.

Deleted information

This edition does not include deleted information.

Summary of changes for GC35-0033-24, Release 17

This document contains information that was previously presented in *Device Support Facilities User's Guide and Reference Release 16 Refresh*, GC35-0033-23. The following sections summarize the changes to that information.

New information

This edition includes the following new information:

- Added support for the 2105 device.
- Additional PPRC support for 2105.
- Additional reports added to the Analyze pathing reports for 2105.
- Limited support for selected pathing reports in the VSE environment.
- Support for entering a load parm in a Stand-Alone environment.
- Support for Stand-Alone from CD-ROM.
- Added "Protecting ICKDSF commands with RACF" on page 35 information.
- Added messages; see Appendix A, "Device Support Facilities messages (ICK)," on page 345.
- Added message handling, see "Accessing LookAt message explanations" on page xxiii.

Changed information

The following information changed in this edition:

- Reader's comment information.
- Information provided in "Softcopy documents on CD-ROM and DVD collections and the Internet" on page xxiii.

Moved information

This edition includes the following moved information:

- Bibliography information into "Additional reference information" on page xix.

- Macro list information into Appendix G, “ICKMCLVL macro,” on page 479.

Deleted information

This edition does not include the following information:

- Information related to running in 370 mode has been removed, as 370 mode is no longer supported by ICKDSF.
- Support for IPLDD in the VSE environment has been removed.

Part 1. Introducing ICKDSF

Chapter 1. Introduction to ICKDSF

This chapter introduces the ICKDSF product. The information in this chapter is organized as follows.

- About ICKDSF
 - Verifying your ICKDSF version
 - Running multiple ICKDSF jobs
 - Running ICKDSF on Dual Copy volumes
- ICKDSF commands
- Operating systems that support ICKDSF
- Devices supported by ICKDSF
- Tasks you can perform with ICKDSF

About ICKDSF

ICKDSF is a program you can use to perform functions needed for the installation, use, and maintenance of IBM DASD. You can also use it to perform service functions, error detection, and media maintenance.

Verifying your ICKDSF version

You can verify the version, release, modification level of ICKDSF, and the environment supported, by checking the format as follows at the top line of any printed page.

```
ICKDSF-xxx DEVICE SUPPORT FACILITIES yy.y
```

xxx	Indicates...
MVS/XA/ESA	MVS
CMS/XA/ESA	VM/CMS
SA/XA/ESA	Stand-Alone/XA or Stand-Alone/ESA mode
VSE	VSE/ESA

Notes:

1. When MVS is referenced in this document, it includes OS/390 and z/OS unless specifically indicated otherwise.
2. When VM is referenced in this document, it includes VM/ESA and z/VM unless specifically indicated otherwise.

yy.y The ICKDSF release and version (for example, Release 17.0).



You can also verify your ICKDSF version with the ICKMCLVL macro. For more details, see Appendix G, "ICKMCLVL macro," on page 479.

Running multiple ICKDSF jobs

Multiple concurrent ICKDSF jobs can cause contention for resources. This can occur when the number of ICKDSF jobs accessing devices on the same storage control or storage subsystem exceeds the number of paths to the devices. For example, if you are running in Device Level Selection Enhanced (DLSE) mode, the maximum number of copies you should use is four.

Running ICKDSF on Dual Copy volumes

You can use different ways to establish or suspend a dual pair (for example, using IDCAMS for MVS or the DUPLEX command for VM). When you are establishing or

Introduction to ICKDSF

suspending a dual pair, ICKDSF is unable to ensure the volume is in a usable state. You must allow the current ICKDSF command to run to its completion before changing the primary or secondary volume state (establishing or suspending a dual pair). Also, do not start ICKDSF until a dual volume change has completed. If an ICKDSF command function prematurely ends, examine the ICKDSF output carefully to determine the reason before you reissue the function. If the volume has changed from a duplex state to a suspended duplex state, the original primary and secondary may be swapped. Be sure you are reissuing ICKDSF to the correct volume. After you determine if it is the primary or the secondary having the problem, you can use the DIRECTIO parameter to issue the command to a secondary of the duplex pair.

ICKDSF commands

ICKDSF operates on both count key data (CKD) and fixed block architecture (FBA) devices. The commands, syntax, and functions are common to all the versions of ICKDSF, provided the operating system supports the device or function.

Table 9 contains descriptions of each command.

Table 9. ICKDSF commands

Command	Description
AIXVOL	Prepares a volume for use in an AIX® environment.
ANALYZE	Helps to detect and differentiate recording surface and drive-related problems on a volume. It can also scan data to help detect possible media problems.
BUILDIX	Changes a standard MVS-format VTOC into an indexed VTOC, or an indexed VTOC into a standard MVS-format VTOC.
CONTROL	<p>With the ALLOWWRITE parameter, this command allows subsequent writes to devices, if storage control has been WRITE INHIBITED by the error recovery procedures at the channel, director, or storage control level.</p> <p>With the CLEARFENCE parameter (IBM 3990 only), CONTROL allows you to clear a fence status of a path and device that the subsystem has fenced off.</p> <p>The CONTROL command with the RESETICD parameter allows you to reset the 'indefinite condition of device' that was set by the subsystem.</p> <p>The CONFIGURE(DISPLAY) parameter allows you to display some subsystem information for a device.</p>
CPVOLUME	Formats a volume for use in the VM environment as a CP volume.
INIT	Initializes MVS and VSE volumes by writing the volume label and volume table of contents (VTOC).
INSPECT	Provides surface checking functions for blocks or tracks on a subset of a volume.
INSTALL	<p>Performs verification procedures after installation or HDA replacement for 3380, 3390, and 9345 devices.</p> <p>Consult your IBM service representative to determine if INSTALL is required after physically moving your IBM 3380, 3390, and 9345 DASD.</p>

Table 9. ICKDSF commands (continued)

Command	Description
IODELAY	Allows functions other than ICKDSF more processing time by slowing down ICKDSF I/O operations. Instead of ICKDSF issuing consecutive I/Os, it allows other functions to process between ICKDSF I/Os.
MAPALT	Produces a report showing the assignment of primary blocks to alternate blocks on FBA devices.
PPRCOPY	PPRCOPY allows synchronous copying of a DASD volume from one subsystem to another subsystem volume, without host system dependencies, for those subsystems that support it.
REFORMAT	Updates portions of a previously initialized MVS or VSE volume. After issuing INIT to initialize a volume, use REFORMAT to change the volume serial number, owner identification, IPL bootstrap, program records, expand or refresh the VTOC, and expand the VTOC index.
REVAL	Performs three major functions: <ul style="list-style-type: none"> • DATA/NODATA <ul style="list-style-type: none"> – Performs a drive test – Validates home address and record zero – Performs data verification of the factory functional verification data patterns (FFVDP) • FIXSIM(4E4E) fixes specific 4E4E SIMs and performs surface checking on tracks for 3390 Models 1 and 2. • REFRESH rewrites user data for 3390 Model 3.
TRKFMT	Performs track-related functions on a subset of a volume.

For instructions about writing command statements, see Chapter 3, “Understanding ICKDSF command statements,” on page 17. For a detailed description and examples of each command, see:

- Part 2, “Using ICKDSF to install and maintain CKD devices,” on page 69
- Part 3, “Using ICKDSF to install and maintain FBA devices,” on page 285

Operating systems that support ICKDSF

ICKDSF versions are:

ICKDSF version	Program number
Stand-Alone	5747-DS1
MVS	5655-257
VM	5684-042
VSE/ESA	5747-DS2

Notes:

1. When MVS is referenced in this document, it includes OS/390 and z/OS unless specifically indicated otherwise.
2. When VM is referenced in this document, it includes VM/ESA and z/VM unless specifically indicated otherwise.

The Stand-Alone version of ICKDSF runs in a virtual machine on VM, and on S/390 and zSeries Enterprise Servers, ES/9000 and newer.

370 mode is no longer supported by ICKDSF.

Introduction to ICKDSF

Note: The program directory that is shipped with the machine-readable material gives instructions about how to install ICKDSF versions.

Versions that support ICKDSF commands

Table 10 shows which ICKDSF commands are supported by each ICKDSF version.

Table 10. Commands supported by each version of ICKDSF

	MVS	CMS	VSE	Stand-Alone
AIXVOL	-	X	-	X
ANALYZE	X	X	X	X
BUILDIX	X	-	-	-
CONTROL	X	X	X	X
CPVOLUME	-	X	-	X
INIT	X	X	X	X
INSPECT	X	X	X	X
INSTALL	X	X	X	X
IODELAY	X	X	X	X
MAPALT	-	X	X	X
PPRCOPY	X	X	X	X
REFORMAT	X	X	X	X
REVAL	X	X	X	X
TRKFMT	X	X	X	X

Note:

An X indicates support and a hyphen (-) indicates nonsupport.

All ICKDSF commands are not always supported by the operating system under which they run. For example, you can initialize a 9313 FBA minidisk using the CMS version, but the VSE operating system will not operate correctly against that FBA device.

Storage requirements

ICKDSF requires the following approximate amounts of processor storage space for execution:

MVS	2 MB virtual storage
CMS	2 MB user storage
VSE	2 MB minimum partition size
Stand-Alone	2 MB real storage

Devices supported by ICKDSF

Table 11 on page 7 and Table 12 on page 7 show the ICKDSF commands and the CKD devices each command supports, and Table 13 on page 8 shows similar information for FBA devices.

Before you run ICKDSF, make sure these DASD devices have reached thermal stability. You must power on all devices in the ready condition. Close all covers to establish thermal stability. To ensure thermal stability, the following is recommended.

Device	Time required
3380	2 hours 30 minutes
3390	1 hour 20 minutes
9345	10 minutes

Table 11 contains the CKD devices and storage subsystems supported by ICKDSF commands.

Table 11. CKD devices and storage subsystems supported by ICKDSF commands

	3375	3380	3390	3395 ²	9345
AIXVOL	-	X	X	X	X
ANALYZE	X	X	X	X	X
BUILDIX	X	X	X	X	X
CONTROL	X	X	X	X	-
CPVOLUME	X	X	X	X	X
INIT	X	X	X	X	X
INSPECT	X	X	X	-	X
INSTALL	-	X	X	-	X
PPRCOPY ¹	-	-	X	-	-
REFORMAT	X	X	X	X	X
REVAL	-	X	X	-	-
TRKFMT	-	X	X	-	X

Note: An X indicates support and a hyphen (-) indicates nonsupport.

¹ 3990 Model 6 attached (for 3390 and 9391) or devices attached to 9393 (RVA) or 2105.

² Models 151 and 153.

Table 12 contains additional CKD devices and storage subsystems supported by ICKDSF commands.

Table 12. CKD devices and storage subsystems supported by ICKDSF commands

	9391	9394	Internal Disk ²	9393	9396	9397	2105
AIXVOL	X	X	-	X	X	X	X
ANALYZE	X	X	X	X	X	X	X
BUILDIX	X	X	X	X	X	X	X
CONTROL	X	-	-	X	X	X	X
CPVOLUME	X	X	X	X	X	X	X
INIT	X	X	X	X	X	X	X
INSPECT	X	X	X	X	X	X	X
INSTALL	X	X	X	-	X	X	-
PPRCOPY ¹	X	-	-	X	-	-	X
REFORMAT	X	X	X	X	X	X	X
REVAL	X	-	-	X	X	X	-
TRKFMT	X	X	X	X	X	X	X

Note: An X indicates support and a hyphen (-) indicates nonsupport.

¹ 3990 Model 6 attached (for 3390 and 9391) or devices attached to 9393 (RVA) or 2105.

² Internal Disk Feature of the S/390 Multiprise 2000 and Multiprise 3000.

Introduction to ICKDSF

Table 13 contains FBA devices supported by ICKDSF commands.

Table 13. FBA devices supported by ICKDSF commands

	0671	3370	9313	9332	9335	9336
ANALYZE	-	X	-	-	X	-
CPVOLUME	X	X	X	X	X	X
INIT	X	X	X	X	X	X
INSPECT	X	X	X	X	X	X
MAPALT	-	X	-	-	X	-
REFORMAT	X	X	X	X	X	X

Note:

An X indicates support and a hyphen (-) indicates nonsupport.

The Stand-Alone version of ICKDSF supports all the devices listed in Table 11 on page 7 and Table 12 on page 7. The operating system versions of ICKDSF support those devices that each operating system supports.

For DASD operating as a paging subsystem, all ICKDSF commands must be directed to the base address.

If the DASD are attached to a cached storage control, ICKDSF automatically bypasses the cache in all channel programs.

ICKDSF support of the RAMAC Array family

The RAMAC Array family consists of the following devices:

- RAMAC Array Subsystem (9394)
- RAMAC Array DASD (9391)
- RAMAC Virtual Array (9393)
- RAMAC Scalable Array (9396)
- RAMAC Electronic Array (9397)

The characteristics of the physical devices that make up the RAMAC Array Family do not require use of the ICKDSF commands that perform installation, media maintenance and problem determination functions. These functions are currently part of the following commands:

INSTALL¹
ANALYZE
INSPECT
REVAL

ICKDSF supports the command and parameter combinations of these commands whenever possible. For those command and parameter combinations that are not supported on the RAMAC Array DASD and the RAMAC Array Subsystem, ICKDSF detects the ones which cannot execute and posts an error condition.

For example, an INSPECT PRESERVE CHECK(1) is not supported on the RAMAC Array DASD. A message is issued indicating that the function is not supported for the device.

1. INSTALL must be used to change 9391 devices to 3380 track format. INSTALL is not recommended otherwise.

However, an INSPECT PRESERVE CHECK(1) on the RAMAC Array Subsystem issues commands to preserve data and surface check the track. No data check conditions will ever be indicated, since media maintenance is done by the subsystem.

When you use the following commands in support of devices emulated by the RAMAC products, they support the emulated device in the same way they support the native device.

```
INIT NOVALIDATE (minimal init)
CPVOLUME
AIXVOL
BUILDIX
PPRCOPY
REFORMAT
```

ICKDSF support of the Internal Disk

Whenever IDisk or Internal Disk is referenced throughout this document, it refers to the Internal Disk Feature of the S/390 Multiprise 2000 or Multiprise 3000.

The characteristics of the Internal Disk devices do not require use of certain ICKDSF commands and parameters that perform installation, media maintenance and problem determination functions. For those commands and parameter combinations that are not supported, ICKDSF detects which ones cannot execute and posts an error condition. If the device does not support ICKDSF checkpointing operators, all ICKDSF checkpointing functions are bypassed.

ICKDSF support of the 2105

The characteristics of the 2105 (IBM TotalStorage™ Enterprise Storage Server™ (ESS)) do not require use of the ICKDSF commands that perform installation, media maintenance, and problem determination functions. These functions are currently part of the following commands:

```
INSTALL
ANALYZE
INSPECT
REVAL
```

ICKDSF supports the command and parameter combinations of these commands whenever possible. For those command and parameter combinations that are not supported on the 2105, ICKDSF detects the ones which cannot execute and posts an error condition. For example, the following command is not supported on the 2105:

```
INSPECT PRESERVE CHECK(1)
```

A message indicates that the function is not supported for the device.

When running offline in an MVS environment, the Alias address of a Parallel Access Volume (PAV) can not be specified for ICKDSF commands. An error message will result if specified. Instead, specify the base address.

Additional ICKDSF support information

If the device does not support ICKDSF checkpointing operations, or does not have CE cylinders, all ICKDSF checkpointing functions are bypassed. When the size of the volume is greater than 4 K cylinders or greater than 64 K tracks, the same rules and restrictions apply as for other devices with greater than 4 K cylinders or greater than 64 K tracks.

Configuration checking

ICKDSF checks for possible miscabled devices in the MVS offline environment (when running with the UNITADDRESS parameter specified), VM/CMS environment, and Stand-Alone environment. If the CKD device supports self description, ICKDSF will compare the Device NED (node element descriptor) for each available path. If the Device NED for all paths match, then ICKDSF will continue processing. If they do not all match, ICKDSF will terminate the command.

ICKDSF does not perform the miscable checking:

- When the device does not support self description
- When the device is online in the MVS environment
- When ICKDSF is running in the VSE environment
- For non-simplex volumes
- For FBA devices

If the Device NED information matches on all paths (or if only 1 path is available), ICKDSF will print the NED information as an informational message and continue processing.

If the Device NED information does not match on all paths, then ICKDSF will print the NED information for each path along with the CHPID number, and the ICKDSF command processing is terminated.

Processing on XRC volumes

Prior to APAR PQ73189 for release 17 when the subsystem status (Sense Subsystem Status Data) indicated that XRC was active on the volume, only ANALYZE, BUILDIX, CONTROL, and PPRCOPY commands were allowed to run on the volume unless you removed it from the XRC pair. With APAR PQ73189 for Release 17 all ICKDSF commands will be allowed to run, unless the new JCL parameter PARM=NOXRC is specified.

If you only want to run the ANALYZE, BUILDIX, CONTROL, and PPRCOPY commands to XRC active volumes after applying APAR PQ73189 then you must code this new parm in your JCL as follows.

```
//stepname EXEC PGM=ICKDSF,PARM=NOXRC
```

Note: This applies only to the primary volume as there is no indication to ICKDSF that a volume is a secondary of an XRC pair. It is the responsibility of the user to control activity to the secondary volume of the XRC pair.

See *z/OS DFSMS Advanced Copy Services* for more information about running ICKDSF on XRC volumes.

Tasks you can perform with ICKDSF

ICKDSF is a program you can use to perform functions needed for the installation, use, and maintenance of IBM DASD. Short descriptions of some of the tasks follow:

Installing a device: After your IBM service representative completes the physical installation of a device, you may need to complete additional installation procedures for that device.

Initializing and formatting the volume: Once you have completed the installation of a device, you must initialize and format the volume so that it can be used by an AIX, MVS, VM, or VSE operating system.

Problem determination: You can use ICKDSF to help determine if the origin of a problem is hardware or recording media. For background information on problem determination for storage media, see Chapter 2, "About DASD storage media," on page 13. Some of the specific tasks you can perform for problem determination are:

- Perform surface checking functions.

Note: The surface checking functions performed by ICKDSF are not equivalent to the surface checking that is performed on a volume at the factory. For more information, see Appendix E, "Surface checking," on page 471.

- Examine a device with a non-removable storage mechanism to determine if there are problems with the drive.
- Determine if there is a problem reading data stored on the volume.

Media maintenance: Some of the media maintenance tasks you can perform with ICKDSF are:

- Perform skip displacement checking
- Rewrite data
- Assign alternate tracks
- Reclaim a track

For information on the CKD and FBA device commands to use during the performance of these tasks, see Part 2, "Using ICKDSF to install and maintain CKD devices," on page 69 and Part 3, "Using ICKDSF to install and maintain FBA devices," on page 285.

Year 2000 support for ICKDSF

There are no migration considerations for ICKDSF for Year 2000. ICKDSF Release 17 is Year 2000 ready.

Chapter 2. About DASD storage media

This chapter provides some background information on DASD, their storage media, and the errors that can occur during data storage and retrieval.

This information is basic to understanding how to use the ICKDSF commands for installation and maintenance of your data storage devices.

DASD physical characteristics

DASD use disks coated with magnetized material as the medium for storing data. Actuators, a combination of access arms and electronics, control the disk rotation and the movement of the heads that write and read data (bit patterns) on the disk surface. Figure 1 shows the read-write heads positioned on a disk surface.

The disk surface is divided into separate concentric circles, or tracks, for storing data. Tracks are grouped into sets called cylinders; the tracks within a cylinder are numbered consecutively, starting with 0. This track address is used for data storage and retrieval and locating errors that occur on the disk surface (the storage media).

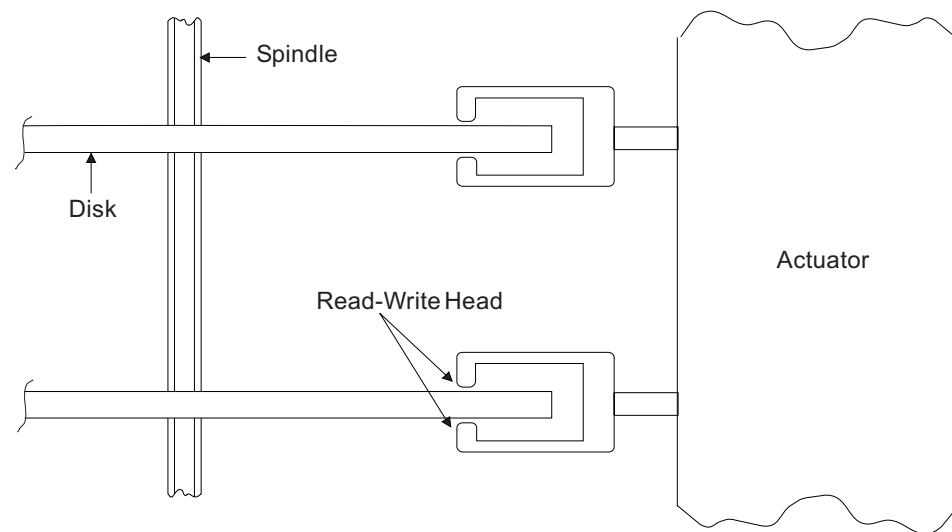

Figure 1. A DASD read-write head positioned on a disk

Errors can occur that prevent the reading or writing of data on the media. Table 14 lists the types of errors and the action to take when they occur.

Table 14. Errors that prevent reading and writing of data

Error	Action
Data check on the media	Use ICKDSF to correct the media on which the data check occurs.
Error caused by DASD hardware	Your hardware service representative can assist you in handling it.
Randomly occurring data checks	Ignore (they do not affect the performance of your system).

About DASD storage media

See *Maintaining IBM Storage Subsystem Media* for more details on DASD media maintenance and error handling. For 9345 modules see *9340 Customer Guide for Using SIMs*.

Data checks

A data check is an error detected in the bit pattern read from the disk. When it is a media problem, it is most likely to be caused by an imperfection on the disk surface.

Data checks can have the following attributes:

- Repeatable
- Visible
- Correctable (versus uncorrectable)
- Temporary (versus permanent)

Each of these attributes is described in the following sections.

Degree of repeatability

Every data check has a certain degree of repeatability. The higher the level of repeatability a data check has, the more likely it is that an error will be detected in any given read. For example, if a data check is 1% repeatable, then it will be read with an error 1 time out of every hundred times it is read. If a data check is 89% repeatable, then it is read with an error 89 times out of every hundred times it is read.

Degree of visibility

Data checks can be caused by media defects that are extremely small. In fact, they can be caused by defects that are smaller than the area of a single bit on the surface of the media.

Because defects are so small, the data can sometimes be rewritten to 'straddle' the defect. This straddling effect or skip displacement prevents subsequent reads from detecting the presence of the defect. The percentage of time that a data check is detected after multiple rewrites determines its degree of visibility. ICKDSF can perform skip displacement or assign an alternate track when skip displacement is not feasible.

Correctable versus uncorrectable

When data is written on a track, the DASD not only records the data, but also records error checking and correcting (ECC) bytes, known as *check bytes*. These check bytes make it possible to detect and correct data checks.

Along with the ability to detect the data check, these check bytes may provide sufficient information to reconstruct the data in error. When this reconstruction occurs, the data check is ECC correctable. ECC-correctable data checks are corrected either by the storage subsystem or by the operating system error recovery procedures (ERP).

When the check bytes are not sufficient to reconstruct the data, the data check is ECC-uncorrectable. Once a data check is found to be ECC uncorrectable, the storage subsystem or operating system invokes data recovery procedures in an attempt to read the data correctly. From the results of these procedures, the data checks can be classified as temporary or permanent.

Temporary versus permanent

Only ECC-uncorrectable data checks can be classified as temporary or permanent. Once an ECC-uncorrectable data check occurs, either the storage subsystem or the operating system executes a series of recovery attempts. The results of these attempts determine whether the data check is temporary or permanent. The classification conventions are described below.

Temporary data checks—If the subsystem or operating system error recovery procedures are successful, then the data check is temporary. Only the system sees a temporary data check; it is never returned to the application.

Permanent data checks—Permanent data checks can be viewed from the system or the application.

System view of a permanent data check—If error recovery procedures performed by the system or subsystem at the time the error occurred cannot successfully recover from the error condition, then the data check is permanent from the system perspective.

Application view of a permanent data check—If an error condition must be returned to the application, indicating unsuccessful completion of the I/O request, then the data check is permanent from an application perspective. The application is then responsible for determining how to deal with the error.

Error notification

Most devices notify you of error conditions on your storage media by service information messages (SIM). The subsystem sends the SIM to the operating system to report that service is required.

For device failures, the SIM is reported only on an I/O operation directed to the failing device. For attachment failures, the SIM is reported on any I/O operation directed to the subsystem.

The operating system's error recovery procedure (ERP) then notifies the operator that service is required by displaying a SIM alert message on the operator console. The operating system's ERP also adds the SIM to the error recording data set (ERDS) as shown in Figure 2.

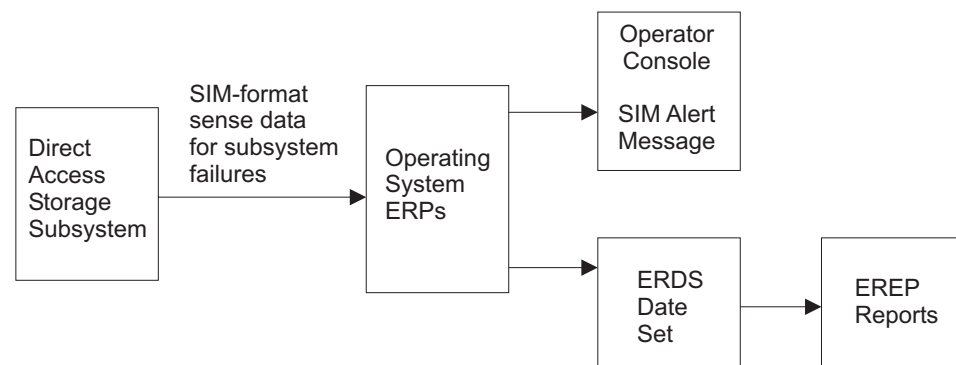

Figure 2. How service information messages are generated

Chapter 3. Understanding ICKDSF command statements

This chapter shows you how to use the ICKDSF commands and command parameters. It describes:

- Command statement syntax
 - The elements of a command statement
 - Conflicting keyword parameters
 - Abbreviating and separating commands and parameters
 - Ending a command
 - Continuing a command statement for more than one line
 - Commenting code
- Writing statements to control ICKDSF processing
 - Setting a condition code
 - Controlling the order in which ICKDSF commands run

ICKDSF command statement syntax

A command statement consists of a command name followed by one or more operands or parameters. All operands described in this book are called parameters. They provide the specific information needed for the command to perform the task you request.

Figure 3 shows an example of an ICKDSF command statement. In this example, the parameters used with the INSPECT command indicate where the volume is mounted, which tracks are to be inspected, and whether the volume serial number and owner identification should be verified.

```
INSPECT DDNAME(VOL1) TRACKS((4,6),(4,10)) VERIFY(DSF123,SMITH)
```

Parameter

DDNAME	DD statement that contains device description.
TRACKS	Inspect cylinder 4, track 6 and cylinder 4, track 10.
VERIFY	Verify volume serial number DSF123 and owner identification SMITH before inspection begins.

Figure 3. ICKDSF command statement

If you do not enter a parameter with the command, the parameter takes its default value.

Table 15 shows you how to use the command-statement elements (symbols, character strings, or values) when writing ICKDSF command statements.

Table 15. Command-statement elements

Element	What it means in a command statement
[] brackets	An optional field or parameter.
{ } braces	Alternative items. Select one.
(vertical bar)	A separator between alternative items. Select only one of the items.

ICKDSF command syntax

Table 15. Command-statement elements (continued)

Element	What it means in a command statement
... (ellipsis)	You can enter whatever immediately precedes the ellipsis a multiple number of times.
UPPERCASE	You must enter these exact characters. Enter such items as shown or in their abbreviated form.
BOLDFACE UPPERCASE	You can omit the parameter, and this value is assumed. It is the default option.
<i>italics</i>	You must supply these fields. These are parameter values. When a value consists of a list of items, you must enclose the list in parentheses.
Parentheses, commas, slashes, spaces, and other punctuation	You must enter as shown.
Numeric values	You can code numeric values in decimal or hexadecimal (X'n').
Character string	You can code character strings inside or outside single quotation marks.

Note: If a value contains commas, semicolons, blanks, parentheses, or slashes, enclose the entire value within single quotation marks.

When a field is enclosed within single quotes, code a single quote in the field as two single quotes, for example, **OWNERID('SUSAN'S PACK')**.

Conflicting keyword parameters

Conflicting keyword parameters are identified by a logical or-sign (|) that represents alternative items. If conflicting keyword parameters are entered, the command terminates with an error message.

Abbreviating commands and parameters

You can abbreviate some commands and parameters. Abbreviations for each command appear in the command parameter tables that are included with each ICKDSF command described in this book. The full form of the parameter is given first, followed by acceptable abbreviations.

Separating commands and parameters

When you issue a command, you must separate the command name from the first parameter by one or more blanks. You must separate parameters from each other by one or more blanks or a comma. Do not use a semicolon as a delimiter because any characters that follow a semicolon are ignored.

Continuing lines

If you write a command statement, IF statement, or comment that requires entry of more than one line, continue the command or comment by ending each line, except the last, with a plus (+) or minus (-). This line continuation character must be the last character on the line, and it cannot be put in any columns after column 72. You must precede it with a space.

The minus character causes leading blanks in a following line to be read as part of the command. The plus character causes leading blanks in a following line to be ignored.

For example, if you enter:

```
INSPECT DDNAME(VOL1) TRACKS((4,6),(4,10)) VERIFY(DSF123,SM + ITH)
```

ICKDSF reads it as:

```
INSPECT DDNAME(VOL1) TRACKS((4,6),(4,10)) VERIFY(DSF123,SMITH)
```

If you use a minus instead of a plus, ICKDSF reads it as:

```
INSPECT DDNAME(VOL1) TRACKS((4,6),(4,10)) VERIFY(DSF123,SM ITH)
```

When using an 80-column card format, you must enter ICKDSF commands between columns 2 and 72. If the length of the command exceeds column 72, you must enter a continuation character, and continue the command on the next line.



When you enter commands at the console in the Stand-Alone version of ICKDSF, they begin at the left margin and are also subject to the 72-character line maximum.



When you are entering ICKDSF commands under CMS, and you want a continuation line to follow (+ or -), press Enter, and then continue your next line.

Commenting your code

You can add comments to any of the commands wherever a blank character can appear. To distinguish your comments from the commands, surround them inside the comment delimiters `/*` and `*/`. Continue a comment onto the next line by using a line continuation character at the end of the line.

Ending a command

End a command with a terminator. The terminator can be either an end-of-command condition (that is, a no continuation character) or a semicolon (`;`). If you use a semicolon as the terminator, do not enclose it in quotation marks or imbed it in a comment. Everything to the right of the semicolon is ignored.

For example, if you code:

```
REFORMAT UNITADDRESS(0353) VOLID(AA3390) NOVERIFY; /*REFMT 3390*/ -
INIT
REFORMAT UNITADDRESS(0354) VOLID(BB3390) NOVERIFY
```

The characters following the semicolon terminator on the same line are ignored.

Because the minus character causes the first line to continue, the INIT command is also ignored. ICKDSF then recognizes the REFORMAT command.

Writing statements to control ICKDSF processing

The following sections describe how to write ICKDSF command statements to set condition codes and to control the execution of ICKDSF command sequences.

The condition codes are:

Code	Description
------	-------------

ICKDSF command syntax

- LASTCC** Compares the condition code of the last completed ICKDSF command with the condition code you indicated. For example, LASTCC=4 indicates 4 is the condition code you selected for the comparison match.
- MAXCC** Compares the condition code of the last completed ICKDSF command or SET sequence with the condition code you indicated as the maximum value. For example, MAXCC=8 indicates you selected condition codes 0, 4, and 8 as comparison matches.

Condition codes can have the following values:

Value Indicates...

- 0** The command completed and might have issued informational messages.
- 4** An error occurred while executing the command, but ICKDSF processing continued. The command might not have completed your desired task, but no data or volume was permanently harmed. A warning message was issued.
- For example, the system ignored a parameter that you specified, but that parameter did not apply.
- 8** The command completed, but some action was unavoidably bypassed. For example, ICKDSF was unable to reclaim an alternate track.
- 12** The command could not be completed. This condition code results from:
- A logical specification error. For example, inconsistent parameters were specified, a value specified was too large or small, or required parameters were missing.
 - A problem during execution. For example, the volume label cannot be changed.
- 16** A severe error occurred, causing the remainder of the command stream to be flushed. For example:
- The system output data set could not be opened because the SYSPRINT DD statement was missing.
 - An unrecoverable error occurred in a system data set.
 - ICKDSF encountered improper IF-THEN-ELSE statement sequences.

Condition codes greater than 16 are reduced to 16. You can use one of the following six comparison operators when comparing them:

Operator	Means
= or EQ	Equal
≠ or NE	Not equal
> or GT	Greater than
< or LT	Less than
>= or GE	Greater than or equal

Writing a SET statement

The SET statement sets a condition code. For example:

```
SET LASTCC=8
```

Term	Description
SET	SET sets a condition-code value (8, in the example above). If a SET statement follows a THEN or ELSE that is not executed because the comparison in the IF-statement does not allow it, the condition code specified with LASTCC or MAXCC is not set.
LASTCC=condition code	LASTCC indicates that the immediately preceding ICKDSF command sets the condition code.
MAXCC=condition code	MAXCC sets the condition code to the maximum condition code value. Setting MAXCC does not affect the condition code for LASTCC. If the LASTCC condition code is greater than the MAXCC condition code, MAXCC assumes the LASTCC condition code.

You can end all processing by setting the MAXCC or LASTCC to 16.

Note: Use continuation lines cautiously when using SET statements, comments, and blank lines in the input stream. Always use a continuation mark to end:

- Blank lines
- Lines ending with comments that are in the middle of a command
- Lines ending with comments that are between the THEN and ELSE clauses of an IF statement
- Lines that end with partial comments

Be careful not to write a null THEN or ELSE clause inadvertently.

Writing the IF-THEN-ELSE statement

Use the IF-THEN-ELSE statement sequence to control the order in which your ICKDSF commands run. Figure 4 shows an example of an IF-THEN-ELSE statement.

```
INIT DDNAME(VOLXYZ) VERIFY(VOLABC)
IF LASTCC=0 -
  THEN REFORMAT DDNAME(VOL293) VOLID(SYX1) NOVERIFY
  ELSE REFORMAT DDNAME(VOL123) VOLID(SYX2) NOVERIFY
```

Figure 4. IF-THEN-ELSE statement

Term	Description
IF	IF selects one or more ICKDSF commands on the basis of a condition code value test. The condition code is set by a SET command or reflects the completion status of a previous ICKDSF command or sequence.
LASTCC=0	LASTCC, with its comparison operator (= in the above example) and the condition code you select (0 in the above example), determines whether the THEN or ELSE action can run. It compares the condition code value resulting from the last completed ICKDSF command with the condition code you selected.

You can also use MAXCC in place of LASTCC.

ICKDSF command syntax

THEN If the LASTCC comparison is true, THEN runs a single command or a group of commands introduced by DO. This would be the first REFORMAT command in the example.

You can follow THEN with another IF statement.

ELSE If the LASTCC comparison is false, ELSE runs a single command or a group of commands introduced by DO. This is the second REFORMAT command in the example.

You can follow ELSE with another IF statement.

When an IF statement appears in a THEN or ELSE clause, it is called a nested IF statement. You are allowed as many as 10 nested IF statements, starting with the first time you use IF.

Within nested IF statements, the innermost ELSE is matched to the innermost THEN, the next innermost ELSE is matched to the next innermost THEN, and so on.

If the nested statements require a final ELSE, but the IF statement does not, you should follow THEN with a null ELSE.

Note: Use continuation lines cautiously when using IF-THEN-ELSE, statements, comments, and blank lines in the input stream. Always use a continuation mark to end:

- Blank lines
- Lines ending with comments that are in the middle of a command
- Lines ending with comments that are between the THEN and ELSE clauses of an IF statement
- Lines that end with partial comments

Be careful not to write a null THEN or ELSE clause inadvertently.

Writing the DO-END statement

Figure 5 contains information about writing a DO-END statement.

```
IF MAXCC=05 THEN DO
    ANALYZE UNITADDRESS(ccuu) SCAN
    REFORMAT UNITADDRESS(ccuu) NOVERIFY
END
```

Figure 5. DO-END statement

Term	Description
MAXCC	MAXCC, with its comparison operator (= in the above example) and the condition code you select (05 in the example), determines whether the THEN action will follow MAXCC compares the condition code of the last completed ICKDSF or SET command sequence with the condition code you indicated as the maximum value. You can also use LASTCC in place of MAXCC.
THEN DO	THEN DO (and THEN ELSE), followed by ICKDSF commands executes a group of commands as a single unit. The commands run as a result of a single IF statement.

Commands following a DO must begin on a new line. You cannot use the continuation sign (-) after the DO statement except as a comment. If you follow the DO statement with a hyphen, the next line is ignored.

END END stops those commands initiated by the nearest unended DO. END must be on a line by itself.

Figure 6 shows an example of an IF-THEN-ELSE DO-END statement.

```

ANALYZE UNITADDRESS(ccuu)
  IF LASTCC>4 -
    THEN...
  ELSE DO
    MAPALT UNITADDRESS(ccuu) SCAN
    INIT UNITADDRESS(ccuu) NOVERIFY VOLID(SYSX1)
  END

```

Figure 6. IF-THEN-ELSE DO-END statement

Note: Use continuation lines cautiously when using IF-THEN-DO-END statements. Always use a continuation mark to end:

- Blank lines
- Lines ending with comments that are in the middle of a command
- Lines ending with comments that are between the THEN and ELSE clauses of an IF statement
- Lines that end with partial comments

Writing a null THEN and ELSE

When a THEN or ELSE clause is not followed by a continuation character or by a command in the same record, it results in no action. This is called a null THEN or null ELSE clause.

In the Figure 6 example, the null THEN is without a continuation character or ICKDSF command. This null THEN clause allows the ICKDSF commands MAPALT and INIT to run if the condition code after ANALYZE completes is ≤ 4 .

Chapter 4. Getting started with the MVS version of ICKDSF

MVS

There are two ways you can use the MVS version of ICKDSF:

- Execute ICKDSF as a job or job step using job control language (JCL). ICKDSF commands are then entered as part of the SYSIN data for MVS.
- In the MVS versions, you can use Interactive Storage Management Facility (ISMF) panels to schedule ICKDSF jobs.

This chapter describes these two ways and includes information on an MVS operating environment. This chapter is organized as follows:

- Overview of the ICKDSF tasks using the MVS version
- Using JCL to run ICKDSF
- Using ISMF panels to run ICKDSF

This section includes information on entering an ICKDSF command against a volume under DFSMS/MVS®.

- Protecting MVS volumes and data sets
- Limiting the use of resources
- Processing in a shared environment

Overview of the ICKDSF tasks using the MVS version

Before using any ICKDSF commands, see their descriptions in Part 2, “Using ICKDSF to install and maintain CKD devices,” on page 69.

Figure 7 on page 26 is an example of the tasks you can perform using ICKDSF and the commands you need to complete each task. For information about specific ICKDSF commands, see:

Part 2, “Using ICKDSF to install and maintain CKD devices,” on page 69

Part 3, “Using ICKDSF to install and maintain FBA devices,” on page 285

Figure 7 on page 26 describes the general usage of ICKDSF commands. For detailed media maintenance procedures, see *Maintaining IBM Storage Subsystem Media*, GC26-4495. For the 9345 modules see *9340 Customer Guide for Using SIMs*, GC26-4858.

Using ICKDSF-MVS

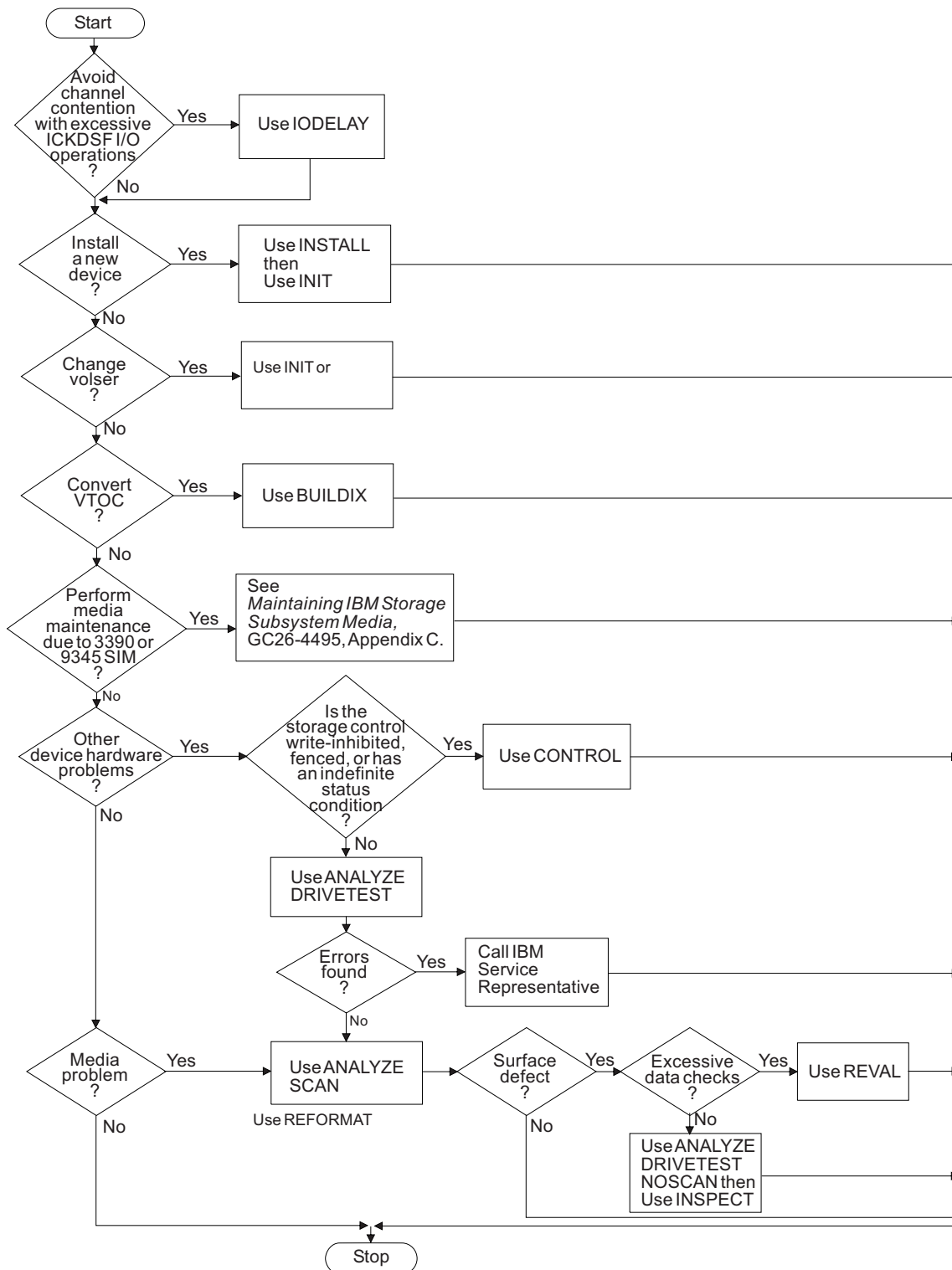

Figure 7. ICKDSF tasks using the MVS version

Using JCL to run ICKDSF

You enter the ICKDSF program by specifying PGM=ICKDSF in the EXEC statement as shown in Figure 8.

```
//JOBNAME JOB      YOUR INSTALLATION'S JOB-ACCOUNTING DATA
//JOBNAME DD      DSNAME=YOUR.CATALOG,DISP=SHR
//STEP1  EXEC     PGM=ICKDSF
//MYVOL  DD       UNIT=devicetype,DISP=OLD,VOL=SER=VOL123
//STEP1  DD       DSNAME=ANOTHER.CATALOG,DISP=SHR
//SYSOUT DD       SYSOUT=A
//SYSIN  DD       *
          ICKDSF commands
/*
```

Figure 8. Running ICKDSF with JCL

JCL Statement	Required or Optional	Explanation
//JOBNAME	Required	Describes your job to the MVS system. Follow the procedures at your installation to supply user identification, accounting, or authorization information with the JOB statement's parameters.
//JOBNAME	Optional	Identifies a user catalog that each job step can use. If your job uses only the master catalog, do not specify the JOBNAME DD statement since the master catalog is always open and available to all the jobs on the system. The JOBNAME DD statement is not supported in a DFSMS (Data Facility Storage Management Subsystem) environment.
//STEP1	Required	The EXEC statement invokes ICKDSF to process the ICKDSF commands.
//MYVOL	Required	If you use the ICKDSF DDNAME parameter. Identifies the volume on which you want ICKDSF to run. Not Necessary if the volume is offline.
//STEP1	Optional	Identifies a user catalog that can be used when processing the job step. If user catalogs are identified with JOBNAME and STEP1 DD statements, only the catalog identified with the STEP1 DD statement and the master catalog are used with the job step. If your job step uses only the master catalog, do not specify the STEP1 DD statement, because the master catalog is always open and available to all the jobs on the system. The STEP1 DD statement is not supported in a DFSMS environment.
//SYSOUT	Required	Identifies the output data set to which ICKDSF sends messages and output information.
//SYSIN	Required	Identifies the source of the input statements. An input statement to ICKDSF is a command. When you code SYSIN DD *, you identify the statements that follow as input.
/*	Optional	Indicates the end of data placed in the input stream. It appears in the first two columns of the following input record.

Printed output data set

The standard printed output data set is SYSPRINT. The default parameters for it are:

- Record format of VBA
- Logical-record length of 125 (121 + 4)
- Block size of 629 (5 x (121 + 4) + 4)

The first byte of each record is the American National Standards Institute (ANSI) control character. The minimum logical-record length (LRECL) is 121 (U-format records only). If a smaller size is specified, it will be overridden to 121.

You can alter the above defaults by placing the desired values in the data control block (DCB) parameter of the SYSPRINT statement. However, if you specify the record format as F or FB, it will be changed to VBA.

Using ISMF panels to run ICKDSF

You can also enter ICKDSF commands with Interactive Storage Management Facility (ISMF), which is a component of DFSMS.

You can use ISMF menu-driven panels with these systems to build job streams for ICKDSF tasks. Fill in the values on the panels and ISMF generates the job stream. You can either submit the job or save the job stream for later use.

You can use the following ICKDSF commands with ISMF panels:

- ANALYZE
- BUILDIX
- CONTROL
- INIT
- INSPECT
- INSTALL
- PPRCOPY
- REFORMAT
- REVAL
- TRKFMT

For information on specific ICKDSF commands, see Part 2, “Using ICKDSF to install and maintain CKD devices.” For information on ISMF, see the ISMF online help panels or the *z/OS DFSMS: Using the Interactive Storage Management Facility*, (SC26–7411) document.

Figure 9 on page 29 through Figure 13 on page 31 show you how to enter an ICKDSF command against a volume under MVS. The volume’s serial number is HSM920.

1. To enter ICKDSF under ISMF, log on to TSO and select ISMF from the ISPF PRIMARY OPTION MENU. This procedure can vary, depending on your installation.
2. As shown in Figure 9 on page 29, select the ISMF application from the ISPF PRIMARY OPTION MENU panel. In the example, this selection is **9**. This takes you to the ISMF PRIMARY OPTION MENU - z/OS DFSMS V1 R3 panel which is at the z/OS DFSMS V1 R3 level.

```

Menu Utilities Compilers Options Status Help
----- ISPF PRIMARY OPTION MENU -----
OPTION ==> 9

0 ISPF PARMS - Specify terminal and user parameters      USERID - KOESTER
1 BROWSE     - Display source data or output listings    TIME    - 13:01
2 EDIT       - Create or change source data             TERMINAL - 3278
3 UTILITIES  - Perform utility functions                PF KEYS - 24
4 FOREGROUND - Invoke language processors in foreground
5 BATCH      - Submit job for language processing
6 COMMAND    - Enter TSO Command, CLIST, or REXX exec
7 DIALOG TEST - Perform dialog testing
8 LM UTILITIES - Perform library management utility functions
9 ISMF       - Invoke interactive storage management facility
E SMP/E      - SMP/E Dialogs
H DFHSM      - DFHSM space maintenance
I IPCS       - IPCS problem analysis services
C CHANGES   - Display summary of changes for this release
T TUTORIAL   - Display information about ISPF/PDF
X EXIT       - Terminate ISPF using log and list defaults

Enter END command to terminate ISPF.

```

Figure 9. ISPF PRIMARY OPTION MENU panel

- As shown in Figure 10, select the VOLUME application from the ISMF PRIMARY OPTION MENU - z/OS DFSMS V1 R3 panel. In the example, this selection is **2**.

```

Panel Help
-----
                ISMF PRIMARY OPTION MENU - z/OS DFSMS V1 R3
Enter Selection or Command ==> 2

Select one of the following options and press Enter:

0 ISMF Profile          - Specify ISMF User Profile
1 Data Set              - Perform Functions Against Data Sets
2 Volume               - Perform Functions Against Volumes
3 Management Class     - Specify Data Set Backup and Migration Criteria
4 Data Class           - Specify Data Set Allocation Parameters
5 Storage Class        - Specify Data Set Performance and Availability
6 Storage Group        - Specify Volume Names and Free Space Thresholds
7 Automatic Class Selection - Specify ACS Routines and Test Criteria
8 Control Data Set     - Specify System Names and Default Criteria
9 Aggregate Group      - Specify Data Set Recovery Parameters
10 Library Management  - Specify Library and Drive Configurations
11 Enhanced ACS Management - Perform Enhanced Test/Configuration Management
C Data Collection       - Process Data Collection Function
L List                 - Perform Functions Against Saved ISMF Lists
R Removable Media Manager - Perform Functions Against Removable Media
X Exit                 - Terminate ISMF
Use HELP Command for Help; Use END Command or X to Exit.

```

Figure 10. ISMF PRIMARY OPTION MENU - z/OS DFSMS V1 R3 panel

- As shown in Figure 11, generate a list of DASD volumes by selecting the DASD option. In the example, this selection is **1**.

```

Panel Help
-----
                                VOLUME LIST SELECTION MENU
ENTER SELECTION OR COMMAND ==>  1
SELECT ONE OF THE FOLLOWING:
  1  DASD                      - Generate a list of DASD volumes
  2  MOUNTABLE OPTICAL         - Generate a list of Mountable Optical volumes
...
USE HELP COMMAND FOR HELP; USE END COMMAND TO EXIT.
...

```

Figure 11. VOLUME LIST SELECTION MENU

- Figure 12 shows how you build or generate a volume list. Enter the volume number in the space next to the label VOLUME SERIAL NUMBER on the VOLUME SELECTION ENTRY PANEL. In this example, the asterisk (*) in **HSM92*** indicates you are selecting all volumes from HSM920 to HSM925.

```

Panel Defaults Utilities Scroll Help
-----
                                VOLUME SELECTION ENTRY PANEL                Page 1 of 3
Command ==>

Select Source to Generate Volume List . . 2 (1 - Saved list, 2 - New list)
  1 Generate from a Saved List          Query Name To
    List Name . .                      Save or Retrieve
  2 Generate a New List from Criteria Below
    Specify Source of the New List . . 1 (1-Physical, 2-SMS, 3-LSA)
    Optionally Specify One or More:
    Enter "/" to select option _ Generate Exclusive list
    Type of Volume List . . . 1         (1-Online,2-Not Online,3-Either)
    Volume Serial Number . . HSM92*    (fully or partially specified)
    Device Type . . . . .              (fully or partially specified)
    Device Number . . . . .           (fully specified)
    To Device Number . . .            (for range of devices)
    Acquire Physical Data . . N       (Y or N)
    Acquire Space Data . . . N       (Y or N)
    Storage Group Name . . .         (fully or partially specified)
    CDS Name . . . . .                (fully specified or 'Active')

Use ENTER to Perform Selection; Use DOWN Command to View next Selection Panel;
Use HELP Command for Help; Use END Command to Exit.

```

Figure 12. VOLUME SELECTION ENTRY PANEL

- Figure 13 on page 31 shows how you can enter ICKDSF commands against a volume. Once you have generated the volume list, enter the ICKDSF command next to the volume serial you want ICKDSF to run against. In this example, ANALYZE was entered next to VOLUME SERIAL HSM920.

```

Panel List Utilities Scroll Help
-----
                                VOLUME LIST
Command ==>                                Scroll ==> PAGE
                                           Entries 1-6 of 6
Enter Line Operators below:                Data Columns 3-8 of 40

  LINE      VOLUME FREE      %   ALLOC      FRAG  LARGEST      FREE
  OPERATOR  SERIAL SPACE    FREE SPACE  INDEX  EXTENT      EXTENTS
---(1)---- -(2)-- ---(3)--- (4)- ---(5)--- -(6)- ---(7)--- --(8)--
ANALYZE    HSM920   644498   23   2127002   356   82174    31
           HSM921   752513   27   2018987   264   501122   263
           HSM922   825336   30   1946164   230   406996   38
           HSM923   735581   27   2035919   207   436158   45
           HSM924   860861   31   1910639   191   555241   35
           HSM925   827604   30   1943896   115   659051   28
-----
                                BOTTOM OF DATA
-----

```

Figure 13. VOLUME LIST

Protecting MVS volumes and data sets

You can use ICKDSF commands to protect DASD volumes. Volume security with ICKDSF includes:

- **VERIFY** parameter: INIT, INSPECT, INSTALL, REVAL, REFORMAT, and TRKFMT

Ensures that the volume serial number and owner identification supplied in the command match those found on the volume. If they match, the command continues to run. If not, the command terminates with an error message.

Note: IBM highly recommends the use of this parameter when running ICKDSF to any volume.

- **PASSWORDS** parameter: INIT, INSPECT, and TRKFMT

Ensures that the user of non-VSAM password-protected data sets is authorized to alter the data sets.

- **User Exit Module**

A default user exit module is shipped with ICKDSF. You can tailor this module to suit the security needs of your installation. For more information, see Appendix F, “User security exit module.”

- **Resource Access Control Facility (RACF®)**, a component of the Security Server Determines whether the volume is RACF-protected (RACF DASDVOL is active) and whether the user has authority to access the volume. If the user has insufficient access authority to a RACF-protected volume, the command terminates with an error message. RACF is valid for INIT, INSPECT, and TRKFMT commands.

Note: Since the ANALYZE command does not write on any user tracks and does not transmit any user data from the device, it requires no security measures.

The system programmer or storage administrator uses ICKDSF to format tracks, write a volume label, and create a VTOC. The system programmer or storage administrator needs to have RACF DASDVOL authority to perform any of these tasks. No users need DASDVOL authority to allocate space on volumes. The system controls space on system-managed storage (SMS) volumes by other means, such as the ACS routines, storage group definitions, and ISMF commands.

- **RACF** protection of ICKDSF commands

Using ICKDSF–MVS

Individual ICKDSF commands can be RACF protected; see “Protecting ICKDSF commands with RACF” on page 35.

Protecting data sets in an offline mode

Data set security in an offline mode is limited to the PURGE parameter of the INIT command. Before the command starts processing the volume, message ICK003D requests permission to alter the volume contents (for more information, see this message in Appendix A, “Device Support Facilities messages (ICK),” on page 345 on page 346). If you confirm that the volume contents can be changed, the command continues running and ICKDSF purges any data sets contained on the volume.

Protecting data sets in an online mode

For on-line volumes, data security checking occurs only when you issue the INSPECT command. The action taken depends on the type of data set, the expiration date, and whether the data set is RACF or password protected. The following sections describe the actions taken for:

- RACF-protected data sets
- Non-VSAM password-protected data sets
- VSAM and unexpired data sets
- VTOC and the VTOCIX data sets

Authorizing access with RACF

Table 16 shows the required RACF authorization for each ICKDSF command.

Table 16. ICKDSF MVS RACF authorization table

ICKDSF Command/Function	Required RACF Access Authority	Volume	Type of Access Used
ANALYZE	None		Read only
BUILDIX	ALTER		Alters VTOC
CONTROL	None		Does not access data on volume
INIT	ALTER		Contents of volume destroyed
INSPECT	ALTER		Data unavailable; can be destroyed
INSTALL	Not applicable		Volume offline
PPRCOPY	None		Read only of primary
REFORMAT—IPLDD	UPDATE		Changes IPL text
REFORMAT—no IPLDD	Not applicable		Changes off-line volume label
REFORMAT-NEWVTOC	ALTER		Alters VTOC
REFORMAT-EXTVTOC	ALTER		Alters VTOC
REFORMAT-EXTINDEX	ALTER		Alters VTOC
REFORMAT-REFVTOC	ALTER		Alters VTOC
REVAL-DATA/NODATA	Not applicable		Volume offline
REVAL-FIXSIM(4E4E)	None		Data is rewritten
REVAL-REFRESH	None		Data is rewritten
TRKFMT	Alter		Data is unavailable; can be destroyed

RACF protected data sets

INIT	RACF is called for each RACF-protected data set on the volume to determine whether the user is authorized to access it.
INSPECT	RACF is called for each user-specified track that falls within any RACF protected data set to determine whether the user has authority to access and alter the data set.
TRKFMT	RACF is called for each user-specified track that falls within any RACF protected data set to determine whether the user has authority to access and alter the data set.

If the user has the appropriate authority, INIT, INSPECT, or TRKFMT continues to run; otherwise, the command terminates.

Non-VSAM password-protected data sets

INIT	All password-protected data sets on a volume are subject to the security function.
INSPECT	The security function is called for each track that falls within a password-protected data set. You can provide passwords by using the PASSWORDS parameter on the INIT, INSPECT, and TRKFMT commands. When the first password-protected data set subject to the security function is encountered, ICKDSF issues a user-security-exit module to determine what needs to be done. A default user-security-exit module, ICKUSER1, returns a code to ICKDSF indicating one of the actions in Table 17 on page 34. For more information about this module, see Appendix F, “User security exit module.”

For normal checking, ICKDSF looks for a user-supplied password for the current data set. If unsuccessful, the command ends and ICKDSF checks the next data set. When ICKDSF finds a password, it then checks the system **PASSWORD** data set to see if the user-supplied password is authorized to alter the data set. If the password is not authorized, the command ends and ICKDSF checks the next data set.

As long as there is a return code indicating that ICKDSF should call the routine again, ICKDSF calls the user exit routine for each password-protected data set. Even if the command is targeted to end, password checking continues for all data sets on the volume. This ensures that all missing passwords are identified.

VSAM and unexpired data sets

INIT	Issues the security function against all VSAM and unexpired data sets on a volume. INIT normally checks to see that PURGE has been specified. If it has not, INIT checks each data set and terminates.
INSPECT	Calls the security function for each VSAM/unexpired data set that contains a track for inspection. When the first VSAM/unexpired data set is encountered, ICKDSF issues a user-security-exit module, ICKUSER1, to determine what needs to be done. This module returns a code to ICKDSF indicating one of the actions in Table 17 on page 34

on page 34. For more information about this module, see Appendix F, “User security exit module.”

INSPECT normally checks each data set, and then terminates.

TRKFMT Calls the security function for each VSAM/unexpired data set that contains a track for processing. When the first VSAM/unexpired data set is encountered, ICKDSF invokes a user-security-exit module, ICKUSER1, to determine what needs to be done. This module returns a code to ICKDSF indicating one of the actions in Table 17. For more information about this module, see Appendix F, “User security exit module.”

TRKFMT normally checks each data set, and then terminates.

Table 17. Codes returned by the user security exit module for password protected data sets

Return Code	Meaning
0	Bypass checking of password-protected data sets on the volume, and do not call the exit routine again.
4	Bypass checking of the current password-protected data set, but call the exit routine for the next password-protected data set.
8	Check the current password-protected data set normally, and call the exit routine for the next password-protected data set.
12	Check all password-protected data sets on the volume normally, and do not call the exit routine again. (The default for ICKUSER1.)
16	Reject access to this data set, but return to the exit routine for the next data set.
20	End this command immediately.

VTOC and the VTOCIX data sets

INSPECT When you enter NOPRESERVE, ICKDSF does not allow inspection of the following in an online mode:

- Tracks inside a VTOC or a VTOCIX data set
- Cylinder 0, track 0

TRKFMT ICKDSF does not allow processing of the following in an online mode:

- Tracks inside a VTOC or a VTOCIX data set
- Cylinder 0, track 0

Limiting the use of resources with the Authorized Program Facility (APF)

The Authorized Program Facility (APF) limits the use of sensitive system services and resources to authorized system and user programs. For information about using APF for program authorization, see *z/OS MVS Programming: Authorized Assembler Services Guide*, SA22-7608.

The ICKDSF load module is contained in SYS1.LINKLIB and link-edited with the SETCODE AC(1) attribute. This ensures that the ICKDSF module is correctly link-edited into an authorized program library. If you link-edit the ICKDSF module into an unauthorized library, the APF authorization of ICKDSF ends.

This authorization is established at the task level. If, while running the APF-authorized job step, a load request is satisfied from an unauthorized library,

the task will end. Ensure that a load request cannot be satisfied from an unauthorized library during ICKDSF processing.

Protecting ICKDSF commands with RACF

You can protect certain ICKDSF commands by defining FACILITY class resource profiles and restricting access to those profiles. Table 18 shows these commands and their associated RACF class profiles. Protection of an ICKDSF command occurs when the following conditions are met:

- RACF FACILITY class is active
- The FACILITY class profile has been defined

When FACILITY class is active and one of the profiles shown in Table 18 is defined, you need access authority to that profile in order to use the associated command. Otherwise, any user can use that command.

Table 18. RACF facility class profile names for ICKDSF commands

ICKDSF Command	FACILITY Class Profile Name
ANALYZE	STGADMIN.ICK.ANALYZE
BUILDIX	STGADMIN.ICK.BUILDIX
CONTROL	STGADMIN.ICK.CONTROL
INIT	STGADMIN.ICK.INIT
INSPECT	STGADMIN.ICK.INSPECT
INSTALL	STGADMIN.ICK.INSTALL
IODELAY	STGADMIN.ICK.IODELAY
PPRCOPY	STGADMIN.ICK.PPRCOPY
REFORMAT	STGADMIN.ICK.REFORMAT
REVAL	STGADMIN.ICK.REVAL
TRKFMT	STGADMIN.ICK.TRKFMT

Note: For additional information on FACILITY class profiles, see *z/OS Security Server RACF Security Administrator's Guide, SA22-7683*.

Processing in a shared environment

During offline and online processing, the commands BUILDIX, INIT, INSPECT, INSTALL, REVAL, and REFORMAT issue the RESERVE macro to obtain control of the device. After processing on the device finishes, the DEQ macro is issued to release the device.

This procedure prevents other processors from accessing the volume, but does not guarantee exclusive access to the volume from the same processor.

When processing online, it is always possible that a particular track will be concurrently updated. The following actions minimize this impact:

After any ICKDSF command modifies the volume label, the VTOC, or the VTOC index, issue a MOUNT command from the processors that share the volume.

Preserving data during INSPECT

This section describes preserving data during INSPECT when your data is either:

- Not on the IBM 9345.
- Not on DASD attached to an IBM 3990 Storage Control that supports concurrent media maintenance.

When you use INSPECT SKIP to perform skip displacement processing and a track is part of a data set, INSPECT enqueues on the data set while processing that track.

INSPECT can expose user data. Exposure time depends on the device type and how busy your operating system is. If INSPECT exposes user data, ICKDSF enqueues for exclusive control of the data set containing the track to be processed. Data set enqueue takes place when:

- The device is online to the operating system.
- The track is part of a non-VSAM data set.
- The SKIP parameter is specified.
- NOSKIP is specified, but primary surface checking indicates that skip displacement processing is necessary for the track. TOLERATE(ENQFAIL) is assumed to be in effect.

If ICKDSF cannot obtain exclusive control of a data set, a message is issued, and processing continues on the next track.

- When you use SKIP, the TOLERATE(ENQFAIL) parameter allows INSPECT to continue processing if the data set enqueue fails.
- When processing online, always specify TOLERATE(ENQFAIL) for tracks in VSAM data sets.

Preserving data during INSPECT under concurrent media maintenance

Concurrent media maintenance allows user access to the data on a track while INSPECT is processing on that track. The entire volume is available to all users from all shared systems for the duration of the INSPECT job. Because the data on the track is always available, you can run INSPECT even when there is other activity on the volume.

Concurrent media maintenance is automatic with PRESERVE. INSPECT does not perform the hardware reserve or the VTOC ENQ for the volume. Data set ENQ and all restrictions on VSAM data sets are eliminated.

Concurrent media maintenance runs automatically when your data is either on:

- IBM 9345.
- DASD attached to an IBM 3990 storage control that supports concurrent media maintenance.

Operator's intervention consideration

Operator's intervention (reply U or T) is no longer required if VERIFY(void) and EXEC PGM=ICKDSF,PARM='NOREPLYU' in the JCL are specified. This rule only applies to an offline device with the INIT, INSPECT, INSTALL, REFORMAT, REVAL, or TRKFMT commands. See the example in "Initializing a volume in offline mode without operator's intervention" on page 158.

Since there is no VERIFY/NOVERIFY parameter for the BUILDIX command, PARM='NOREPLYU' in the EXEC card must be specified in order to bypass the operator's intervention.

Chapter 5. Getting started with the CMS version

This chapter describes how the CMS version of ICKDSF operates for both minidisk and dedicated devices and the ways you can use the CMS version of ICKDSF. It includes the following information:

- Definition of a minidisk and dedicated device
- Overview of ICKDSF tasks using the CMS version
- Invoking ICKDSF under CMS from the console
- Invoking ICKDSF with a CMS EXEC
- Invoking ICKDSF with an input file
- Using parameters to select the input and output devices
- Supporting minidisks under the CMS version
- Supporting dedicated devices under the CMS version

For information about using the Stand-Alone version of ICKDSF, see Chapter 7, “Getting started with the Stand-Alone version.”

If you are experiencing problems running ICKDSF..

When you use ICKDSF under VM, you must follow any restrictions imposed by VM (such as levels of authority).

For more information, see “Problem solving under VM” on page 67.

Definition of a minidisk and dedicated device

A **minidisk** is a portion of a disk that is linked to your virtual machine.

A **full-pack minidisk** is a virtual disk that contains all of the addressable cylinders of a real DASD volume and can also contain the alternate cylinder. INSPECT can use a track on the alternate cylinder when assigning an alternate track. For INSPECT to do this, the MDISK directory control statement definition for the full-pack minidisk must include the alternate cylinder.

Only the CMS and stand-alone versions of ICKDSF support minidisks. Only the CMS version supports minidisk media maintenance.

A **dedicated device** is an entire device for your exclusive use. A device is dedicated to a virtual machine when you use the CP ATTACH command or the DEDICATE directory control statement.

Overview of ICKDSF tasks using the CMS version

Figure 14 on page 40 is an example of the tasks you can perform using ICKDSF and the commands you need to complete each task. For information on specific ICKDSF commands, see:

Part 2, “Using ICKDSF to install and maintain CKD devices,” on page 69

Part 3, “Using ICKDSF to install and maintain FBA devices,” on page 285

Figure 14 on page 40 describes the general usage of ICKDSF commands. For detailed media maintenance procedures, see *Maintaining IBM Storage Subsystem Media*, GC26-4495. For the 9345 modules, see *9340 Customer Guide for Using SIMs*, GC26-4858.

Using ICKDSF-CMS

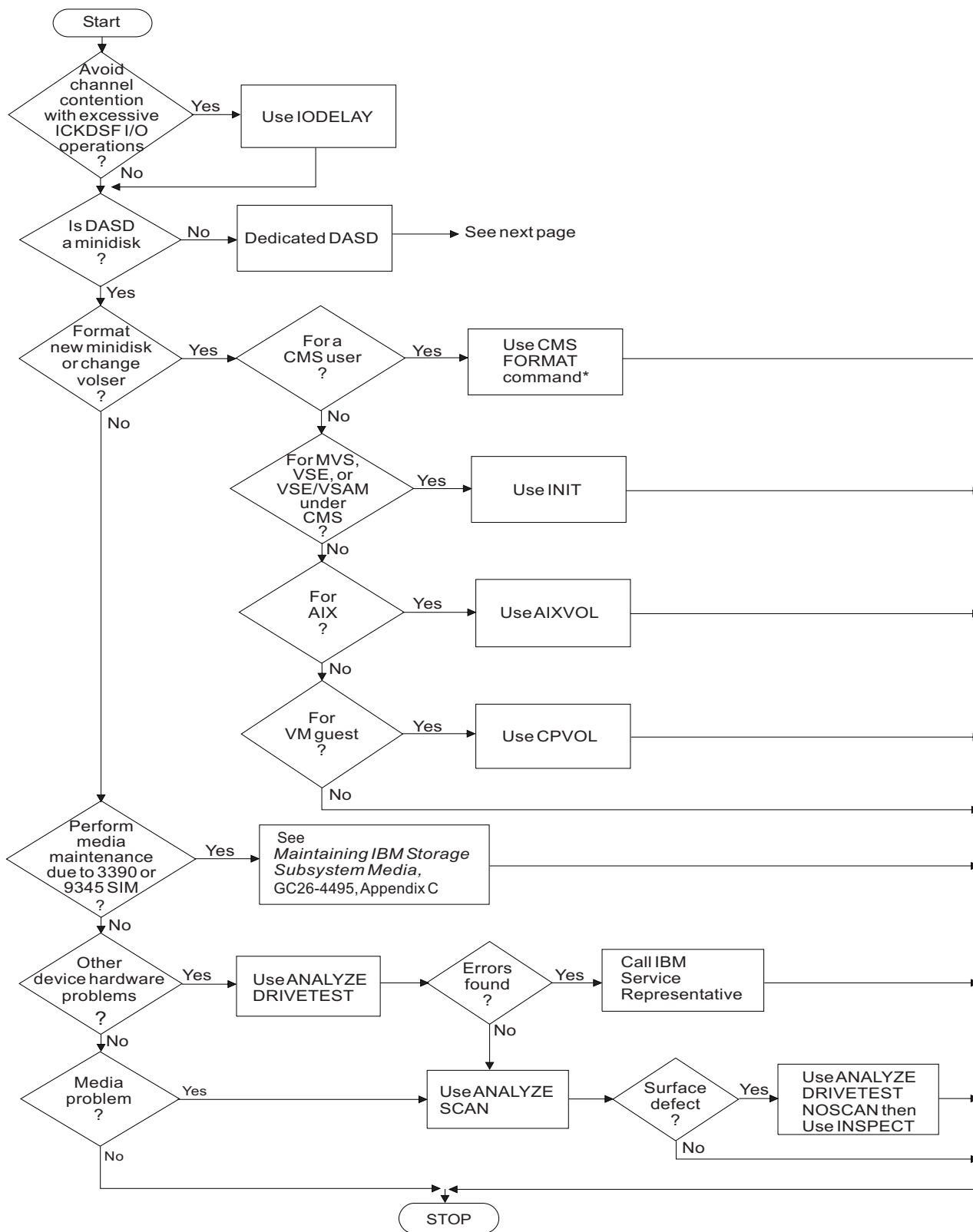

Figure 14. ICKDSF tasks using the CMS version (Part 1 of 2)

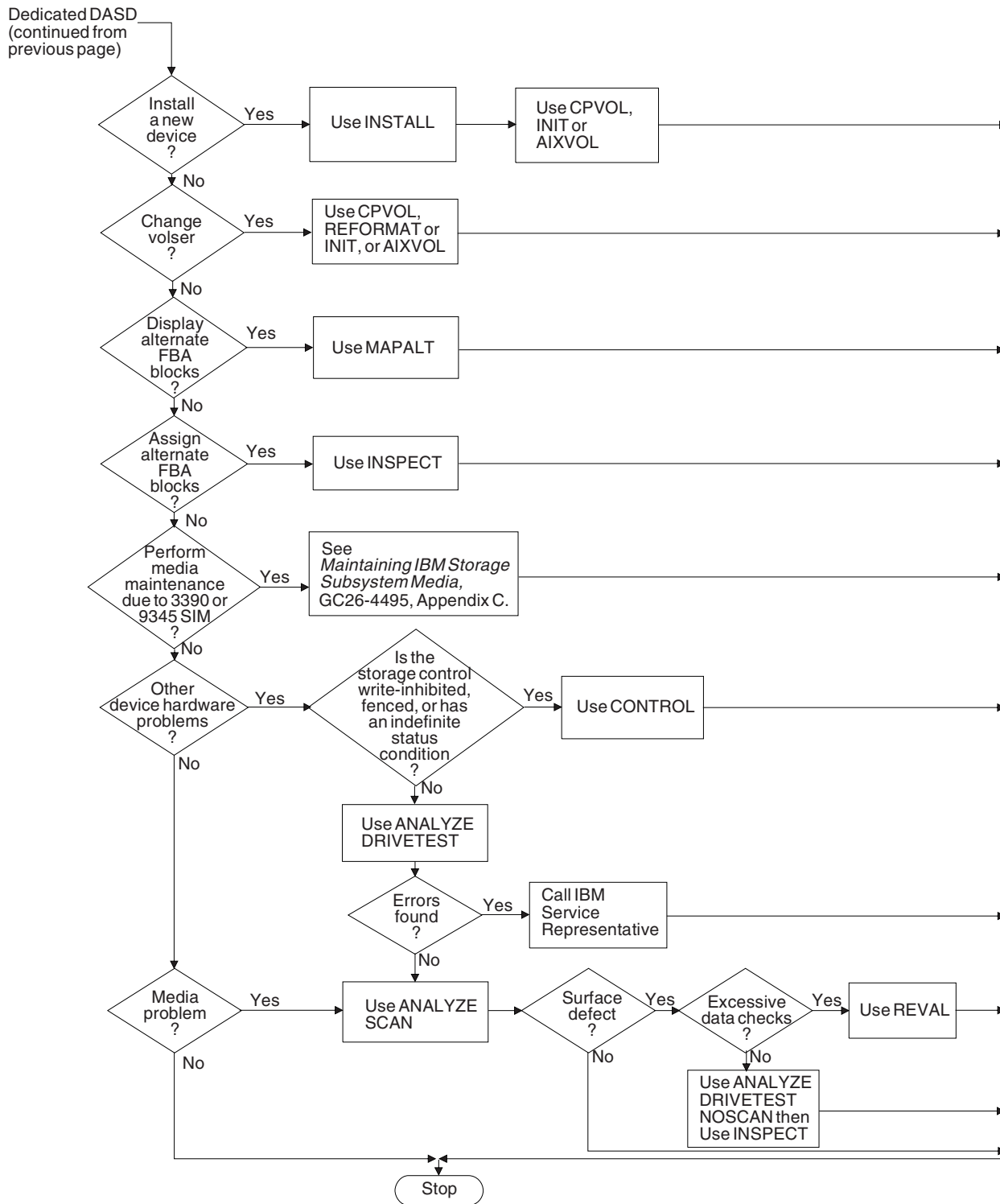

Figure 14. ICKDSF tasks using the CMS version (Part 2 of 2)

Invoking ICKDSF under CMS from the console

You can enter ICKDSF from a CMS operating system in two ways:

Method 1:

1. Enter **ICKDSF** at the console, then press Enter.
2. Enter the input or output device by selecting one of the following actions:
 - a. Enter **CONSOLE** or enter a null line as the input device when the following message appears:

```
ICK030E DEFINE INPUT DEVICE: fn ft fm, 'CONSOLE', OR 'READER'
```

You can also read commands and parameters from your virtual reader. Enter **READER** and ICKDSF uses your first reader file.

- b. Enter **CONSOLE** or a null line as the output device, when the following message appears:

```
ICK031E DEFINE OUTPUT DEVICE: fn ft fm, 'CONSOLE', OR 'PRINTER'
```

You could also route the output to your virtual printer, by entering **PRINTER**.

3. Enter the ICKDSF commands after the following message appears:

```
ICKDSF - CMS DEVICE SUPPORT FACILITIES Release 17.0 Time: hh/mm/ss Date: mm/dd/yy  
ENTER INPUT COMMAND:
```

Method 2:

1. Enter **ICKDSF CONSOLE CONSOLE** as a single command, then press Enter.
2. Enter the ICKDSF commands after the following message appears:

```
ICKDSF - CMS DEVICE SUPPORT FACILITIES Release 17.0 Time: hh/mm/ss Date: mm/dd/yy  
ENTER INPUT COMMAND:
```

Getting Help: Before ICKDSF invocation, enter **ICKDSF ?** or **HELP ICKDSF** to display the online help panels. After you invoke ICKDSF and the “Enter input command” message appears, enter **?** to get online help.

Example of invoking ICKDSF from the console

Figure 15 on page 43 is an example of what appears on your console when you interactively issue the CPVOLUME command of ICKDSF with the LABEL parameter. In this example, the existing volume serial is verified, and a new volume serial is written to the volume label of the volume or minidisk.

```

ickdsf
ICK030E DEFINE INPUT  DEVICE: FN FT FM, "CONSOLE", OR "READER"
console
CONSOLE
ICK031E DEFINE OUTPUT DEVICE: FN FT FM, "CONSOLE", OR "PRINTER"
console
CONSOLE
ICKDSF - CMS/XA/ESA DEVICE SUPPORT FACILITIES 17.0  TIME: 11:17:13  6/06/02  PAGE 1

ENTER INPUT COMMAND:
cpvol label unit(9b2) vfy(vol001) valid(tst001)
CPVOL LABEL UNIT(9B2) VFY(VOL001) VALID(TST001)
ICK00700I DEVICE INFORMATION FOR 09B2 IS CURRENTLY AS FOLLOWS:
      PHYSICAL DEVICE = 9345
      STORAGE CONTROLLER = 9343
      STORAGE CONTROL DESCRIPTOR = E0
      DEVICE DESCRIPTOR = 04
ICK03090I VOLUME SERIAL = VOL001
ICK003D REPLY U TO ALTER VOLUME 09B2 CONTENTS, ELSE T
u
U
ICK03000I CPVOL REPORT FOR 09B2 FOLLOWS:

      VOLUME SERIAL NUMBER IS NOW = TST001

ICK00001I FUNCTION COMPLETED, HIGHEST CONDITION CODE WAS 0
      11:18:06    06/06/02

ENTER INPUT COMMAND:
end
END

ICK00002I ICKDSF PROCESSING COMPLETE. MAXIMUM CONDITION CODE WAS 0
Ready;

```

Figure 15. Invoking ICKDSF interactively from the console

Invoking ICKDSF with a CMS EXEC

You can invoke ICKDSF under CMS using an EXEC. The EXEC must:

- Contain the required statements to enter ICKDSF
- Identify the input and output devices
- Identify the ICKDSF commands and parameters for the task

When ICKDSF processing has completed, the highest condition code (MAXCC) set during the entire command processing is returned to CMS.

Figure 16 on page 44 shows an example of a CMS REXX named CPLIST. CPLIST EXEC issues the CPVOLUME command of ICKDSF with the LIST parameter. This displays the device information, volume serial, and allocation map of a control program (CP) formatted volume or minidisk given the virtual device number or virtual device address.

```
/* Sample CMS REXX procedure of the CPVOLUME command of ICKDSF */  
  
Address 'COMMAND'  
Arg ccuu .  
  
Queue 'CPVOLUME LIST UNITADDRESS('ccuu') NOVERIFY'  
Queue 'END'  
'ICKDSF CONSOLE CONSOLE'  
  
Exit Rc
```

Figure 16. CPLIST EXEC

The EXEC:

1. Invokes ICKDSF.
2. Identifies the console as the input and output device.
3. Issues the CPVOLUME LIST command. You must supply the UNITADDRESS when you invoke the EXEC from the console. For example, if the UNITADDRESS was E45, you would enter **CPLIST E45** at the console to run the EXEC.
4. Terminates ICKDSF.

Invoking ICKDSF with an input file

You can call ICKDSF under CMS using a CMS file.

- INPUT is the file type default.
- A is the file mode default.
- The logical record size of the file must be 132 or less. However, as ICKDSF uses column 72 for a line continuation character, the input line is 70 characters. Use lines beyond 72 for comments. For more information on continuing lines, see “Continuing lines” on page 18.

You can also store your output in a CMS file.

- OUTPUT is the file type default.
- A is the file mode default.
- If the file already exists, the following message appears:

```
FILE ALREADY EXISTS, REPLY U TO ERASE, ELSE T
```

Enter **U** to erase the file.

Figure 17 is an example of an input file. The input file, FMTMDVOL, contains the CPVOLUME commands to format cylinder 0 of two volumes that will contain user minidisks.

```
/* ICKDSF input from a file must be between columns 2 and 72 */  
CPVOLUME FORMAT UNITADDRESS(A00) NOVERIFY VOLID(ESAMD1) RANGE(0,0)  
CPVOLUME FORMAT UNITADDRESS(A01) NOVERIFY VOLID(ESAMD2) RANGE(0,0)
```

Figure 17. FMTMDVOL INPUT A

Figure 18 shows how you would interactively invoke ICKDSF from the console with the input file FMTMDVOL.

```

ickdsf
ICK030E DEFINE INPUT  DEVICE: FN FT FM, "CONSOLE", OR "READER"
fntmdvol
FMTMDVOL
ICK031E DEFINE OUTPUT DEVICE: FN FT FM, "CONSOLE", OR "PRINTER"
103192 dsf1555 a
103192 DSF1555 A
Ready; T=0.11/0.21 15:58:46

```

Figure 18. Invoking ICKDSF interactively with input file FMTMDVOL

Figure 18 shows how you would:

1. Invoke ICKDSF.
2. Identify **FMTMDVOL INPUT A** as the input device. The filetype default is INPUT, and the filemode default is A.
3. Identify **103192 DSF1555 A** as the output file. The output filename is the date, and the output file type represents ICKDSF and what time you ran the commands.

If there already is an output file named 103192 DSF1555 A, respond **U** to the message to erase the file.

4. You do not have to enter **END** at the console to terminate ICKDSF. ICKDSF ends when it detects an end-of-file from the input file.

Using parameters to select the input and output devices

As described in “Invoking ICKDSF under CMS from the console” on page 42, you can enter the CMS version of ICKDSF with a single command (for example, ICKDSF CONSOLE CONSOLE). You can use the following parameters with the ICKDSF command to select your input and output devices.

Input Device	Output Device
CONSOLE	CONSOLE
READER	PRINTER
filename filetype filemode	filename filetype filemode

You cannot use READER, PRINTER, or CONSOLE as a filename. There are no default values.

Supporting minidisks under the CMS version

Table 19 shows the ICKDSF-supported commands and their supported devices when you process minidisks under the CMS version.

Table 19. Devices supported by ICKDSF commands (minidisks under CMS)

Devices	AIXVOL	ANALYZE SCAN	ANALYZE DRIVETEST	CPVOLUME	INSPECT	Minimal INIT/ REFORMAT
CKD Devices						
3375	—	O	D,E	N	D,E	N
3380	N	O	D,E	N	D,E	N
3390	N	O	D,E	N	D,E	N
9345	N	O	D	N	D	N
9391	N	O	D	N	D	N
9394	N	O	D	N	D	N

Using ICKDSF–CMS

Table 19. Devices supported by ICKDSF commands (minidisks under CMS) (continued)

Devices	AIXVOL	ANALYZE SCAN	ANALYZE DRIVETEST	CPVOLUME	INSPECT	Minimal INIT/ REFORMAT
FBA Devices						
0671	—	—	—	N	D	N
3370	—	O	D	N	D	N
9313	—	—	—	N	D	N
9332	—	—	—	N	D	N
9335	—	D	D	N	D	N
9336	—	—	—	N	D	N

Note: The IODELAY command supports minidisks of all device types and does not require DEVMAINT authority.

Legend

—	Not supported.
D	Requires DEVMAINT authority.
E	Directory option LINKEclu is required.
N	No special authority is required.
O	No special authority is required when you process your own minidisks. Otherwise, DEVMAINT authority is required.

Supporting general users without special authority

Table 20 describes the ICKDSF commands that support general users who own minidisks. Support includes the CPVOLUME, INIT, and REFORMAT commands, plus the data-scanning function of the ANALYZE command. You operate on minidisks that are linked to your ID and that you own.

Table 20. ICKDSF Commands available to general users without special authority

AIXVOL	Formats a volume in CMS or stand-alone version for use in an AIX environment for 3380, 3390, and 9345 DASD.
ANALYZE SCAN	Provides information on readability of data on your minidisk. The IBM 0671, 9313, 9332, and 9336 are not supported for ANALYZE For more information about CKD devices, see “CMS version minidisk support” on page 104. For more information about FBA devices, see “CMS version minidisk support” on page 301.
CPVOLUME	Formats minidisks for use in the VM environment. For more information, see minidisk support in Chapter 14, “CPVOLUME command—CKD,” on page 129 or Chapter 25, “CPVOLUME command—FBA,” on page 305.
INIT	Performs a minimal INIT on minidisks for guest MVS or VSE use, or for VSE/VSAM under CMS. This allows you to write the IPL bootstrap records, the volume label and the IPL text, the new owner identification, and reserve space for the VTOC (and index data set). For more information about CKD devices, see “CMS version minidisk support” on page 156. For more information about FBA devices, see “CMS version minidisk support” on page 319.
IODELAY	Allows functions other than ICKDSF more processing time by slowing down ICKDSF I/O operations. For more information about IODELAY, see Chapter 18, “IODELAY command—CKD,” on page 191 or Chapter 28, “IODELAY command—FBA,” on page 335.

Table 20. ICKDSF Commands available to general users without special authority (continued)

REFORMAT	<p>For a guest MVS or VSE minidisk, it changes the volume serial number, owner identification, and IPL bootstrap records, and expands or refreshes the VTOC, that were previously initialized by the INIT command. For MVS volumes, it expands the index VTOC.</p> <p>For more information, see Chapter 20, “REFORMAT command—CKD,” on page 257 or Chapter 30, “REFORMAT command—FBA,” on page 341.</p>
----------	---

Using DEVMAINT authority

With DEVMAINT authority, you can perform:

- All the functions in Table 20
- The drive test capability of the ANALYZE command
- The media maintenance functions of the INSPECT command for your own or another user’s minidisks

When using the ANALYZE and INSPECT commands, you can designate the:

- Real address of a device
- Virtual address of a device
- Userid of the minidisk owner

DEVMAINT authority is not supported in VM/XA.

For information on how to obtain DEVMAINT authority, see the the CP planning and administration document applicable to your VM operating system.

Besides having DEVMAINT authority, you must also have specified LNKEclu on the OPTION directory control statement in the user’s directory definition when performing media maintenance on minidisks.

Table 21 shows you the commands you can use with DEVMAINT authority (in addition to the ones listed in Table 20 on page 46).

Table 21. ICKDSF Commands available to users with DEVMAINT authority

Command	With Parameters	Explanation
ANALYZE	USERID and UNITADDRESS	Provides information on readability of data on the minidisk.
	DRIVETEST	Ensures that a minidisk can perform basic operations, such as seeks, reads, and writes.
	REALADDR	Verifies the data on a minidisk is readable when the real cylinder and head (or block) are known but the virtual cylinder and head (or block) are not known.
		For more information about CKD devices, see “CMS version minidisk support” on page 104. For more information about FBA devices, see “CMS version minidisk support” on page 301.

Using ICKDSF–CMS

Table 21. ICKDSF Commands available to users with DEVMAINT authority (continued)

Command	With Parameters	Explanation
INSPECT	REALADDR	Performs surface analysis of a minidisk when the real cylinder and head (or block) are known but the virtual cylinder and head (or block) are unknown.
	USERID and UNITADDRESS	Performs surface analysis of another user's minidisks. For more information about CKD devices, see "CMS version minidisk support" on page 181. For more information about FBA devices, see "CMS version minidisk support" on page 331.

Supporting dedicated devices under the CMS version

You can perform any ICKDSF function under VM when the volume is dedicated to your virtual machine. Your capability depends on the device type and VM system restrictions.

You might require special authorization to perform device support functions. You need MAINTCCW authority, which is defined in the OPTION statement in the CP directory.

Table 13 on page 8 lists the ICKDSF commands and the devices each command supports when you process dedicated devices under CMS.

Chapter 6. Getting started with the VSE version

This chapter gives an overview of ICKDSF tasks available to the VSE user, explains how to execute the VSE version of ICKDSF, describes how to prevent data loss, and provides guidelines for processing in a shared environment.

To use the VSE version of ICKDSF, you run it as a VSE job, either in “batch” mode, where ICKDSF commands are input by way of SYSIPT, or in “command” mode, where ICKDSF commands are input interactively from the console (SYSLOG).

For detailed information on how you can control ICKDSF command execution by using IF-THEN-ELSE statements, see “Writing statements to control ICKDSF processing” on page 19.

Note: There are some ICKDSF commands that render the device they are issued against to be unusable in its current form (for example, INIT, INSTALL). Before execution of these commands, make sure that no other users/jobs are currently accessing that device.

Overview of the ICKDSF tasks using the VSE version

Figure 19 on page 50 shows an example of the tasks you can perform using ICKDSF and the commands you need to complete each task. Before using any ICKDSF commands, see their descriptions in:

Part 2, “Using ICKDSF to install and maintain CKD devices,” on page 69

Part 3, “Using ICKDSF to install and maintain FBA devices,” on page 285

Figure 19 on page 50 also describes the general usage of ICKDSF commands. For detailed media maintenance procedures, see *Maintaining IBM Storage Subsystem Media*, GC26-4495. For the 9345 modules see *9340 Customer Guide for Using SIMs*, GC26-4858.

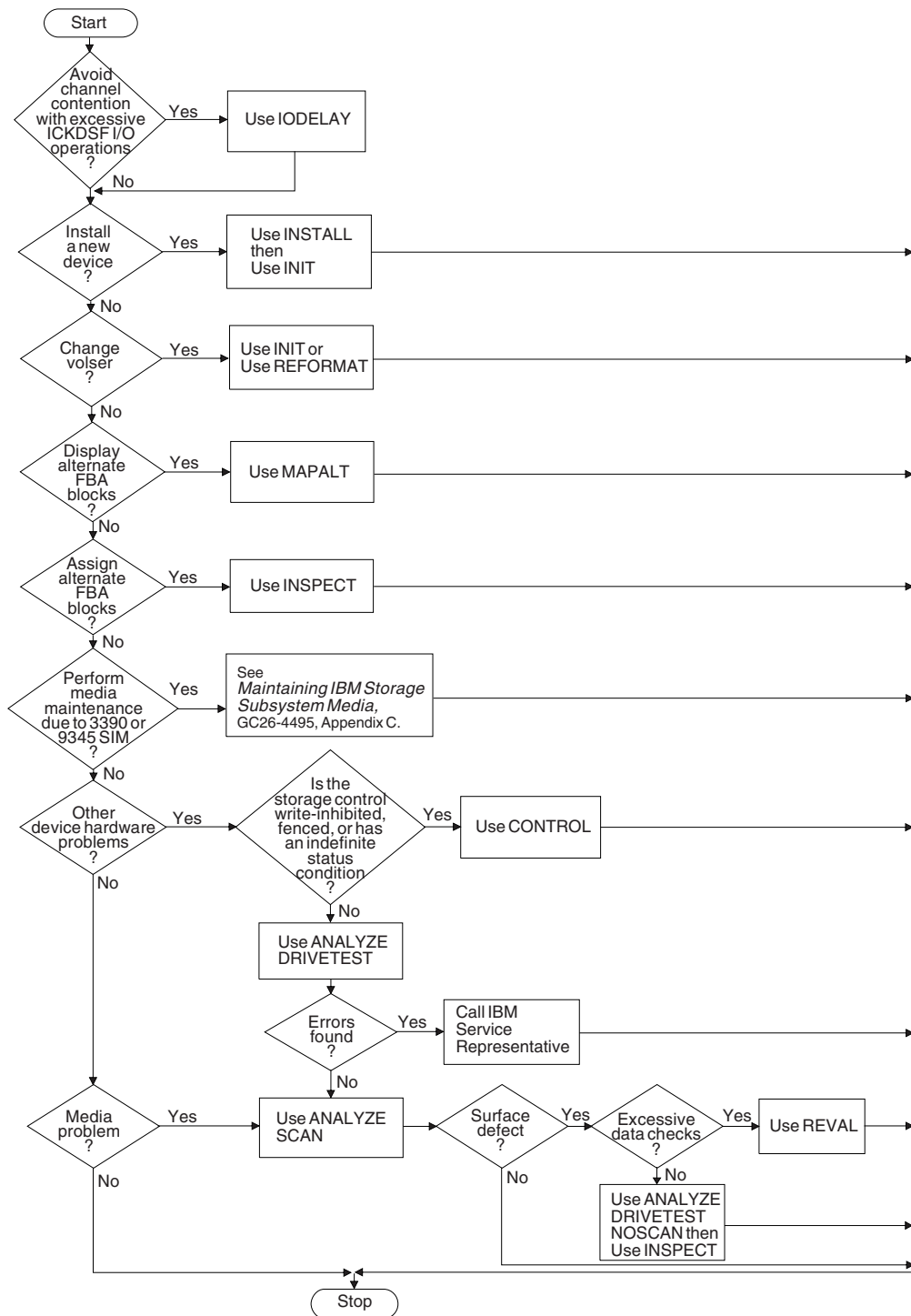

Figure 19. ICKDSF tasks using the VSE version of ICKDSF

Running the VSE version of ICKDSF in batch mode

To run the VSE version of ICKDSF in batch mode, submit a job with an EXEC ICKDSF job control statement as shown in the example in Figure 20 on page 51. All printed output is directed to SYSLST.

Note: In batch mode, the device to be operated on is specified by the SYSNAME(SYSxxx) parameter, and must be online and “DVCUP”.

```
// JOB      jobname  YOUR INSTALLATION'S JOB-ACCOUNTING DATA
// ASSGN    SYS010,353
// EXEC     ICKDSF,SIZE=AUTO
           other ICKDSF commands
/*
/ &
```

Figure 20. Example of executing the VSE version of ICKDSF in batch mode

// JOB	Describes your job to the VSE system.
// ASSGN	Assigns the logical unit name SYS010 to the device with a channel and unit address of 353.
/*	Appears in the first two columns of the input record following the last input statement.
/ &	Appears in the first two columns of the input record following the /* card to indicate end of job.

Running the VSE version of ICKDSF in command mode

To run the VSE version of ICKDSF in command mode, you use Job Control Commands (JCC) to both initiate ICKDSF and provide ICKDSF commands. To start ICKDSF execution in command mode, execute a job stream with a PAUSE JCL statement in it, such as the one shown in the example in Figure 21 on page 52.

Enter “n EXEC ICKDSF” on the VSE console (SYSLOG) when prompted by VSE for input for that partition. Then enter ICKDSF commands (preceded by the appropriate partition identifier) when prompted. Enter “n END” when finished. All ICKDSF command output is written to the console and to SYSLST.

Note: In command mode, the device to be operated on is specified by the UNIT(cuu)² parameter, and must be online and “DVCUP”.

2. VSE supports 3 digit addresses (cuu), but a leading 0 can be used (0cuu).

Using ICKDSF-VSE

```
=> r rdr,ickdsf
BG 0000 // JOB ICKDSF
      DATE 06/07/2002, CLOCK 09/54/00
BG-0000 // PAUSE
=> 0 exec ickdsf
BG 0000 ICKDSF - VSE          DEVICE SUPPORT FACILITIES 17.0      TIME
BG 0000 : 09:54:42          06/07/02      PAGE 1
BG 0000
BG 0000 ENTER INPUT COMMAND:
BG-0000
=> 0 init unit(e40) novfy volid(vse001)
BG 0000 INIT UNIT(E40) NOVFY VOLID(VSE001)
BG 0000 ..... (ICKDSF RESPONSE)
BG 0000 ..... (ICKDSF RESPONSE)
BG 0000 ICK003D REPLY U TO ALTER VOLUME 0E40 CONTENTS, ELSE T
BG-0000
=> 0 u
BG 0000 .....(ICKDSF RESPONSE)
BG 0000 .....(ICKDSF RESPONSE)
BG 0000
BG 0000 ENTER INPUT COMMAND:
BG 0000
=> 0 end      (ANOTHER COMMAND OR 'END' TO FINISH)
BG 0000 ICK00002I ICKDSF PROCESSING COMPLETE. MAXIMUM CONDITION CODE ..
BG 0000
BG 0000 1S55I LAST RETURN CODE WAS 0000
BG-0000 1I00D READY FOR COMMUNICATIONS.
=> 0
BG 0000 EOJ ICKDSF      MAX.RETURN CODE=0000
      DATE 06/07/2002, CLOCK 09/55/37, DURATION 00/01/37
```

Figure 21. Example of executing the VSE version of ICKDSF in command mode

Use of VSE ICKDSF command mode during VSE install process

Command mode VSE ICKDSF is used in place of Stand-Alone ICKDSF during VSE's optional manual install process.

If the manual mode of installation is chosen, VSE issues the following messages:

```
SA09I SELECT ONE OF THE FOLLOWING PROGRAMS OR TYPE END
SA10D FASTCOPY, RESTORE, ICKDSF, DITTO, REIPL
```

To execute ICKDSF, reply to BG with "0 ickdsf."

You will then be prompted for ICKDSF commands. Enter them preceded by the BG partition designator: "0 init unit(cuu)....".

After all ICKDSF commands required to complete the ICKDSF phase of the install process have been entered, ICKDSF is terminated by entering "0 end".

Note: In command mode, the device to be operated on is specified by the UNIT(cuu) parameter.

Command mode restrictions

The input command may only be a maximum of 70 characters per line; if additional length is required, the continuation character ('-') must be used to denote that additional input needs to be entered for which the console will continue to be prompted.

Command mode supports the same commands and parameters that are supported in VSE ICKDSF batch mode.

Verifying identification and preventing data loss

In a VSE environment, only the online mode of operation is available.

Table 22 shows the ICKDSF commands you can use to secure your data sets and prevent data loss on DASD volumes.

Because the ANALYZE and MAPALT commands do not write on any user tracks and do not transmit any user data from the device, they require no security measures.

Table 22. Using ICKDSF command parameters for security

If you specify the	It ensures...
VERIFY parameter of the INIT, INSPECT, REFORMAT, and TRKFMT commands	The volume serial number and owner identification supplied in the command match those found on the volume. If they match, the command continues to run. If they do not match, the command ends.
NOPURGE parameter of the INIT command	If unexpired files, data-secured files, or VSAM files are on the volume, INIT ends.
PURGE parameter of INIT or NOPRESERVE parameter of INSPECT, or TRKFMT command	If unexpired files, data-secured files, or VSAM files are on the volume, data loss is prevented.

PURGE or NOPRESERVE parameters prevent data loss as follows:

Unexpired files: Message ICK001D requests permission to purge the volume contents. Only one request is made, regardless of the number of unexpired files on the volume. ICKDSF does not provide a list of the unexpired files.

Data-secured files: Message ICK017D prompts you with the name of the secured file. Message ICK018D requests permission to purge the file. This sequence is repeated for each data-secured file on the volume.

VSAM files: If a single VSAM file is found on the volume, message ICK019D requests permission to purge all the VSAM files on the volume.

For more information on these messages, see Appendix A, “Device Support Facilities messages (ICK),” on page 345.

Processing in a shared environment

This section describes sharing across multiple processors and sharing across multiple users and partitions.

Sharing across multiple processors

ICKDSF requests permission to access a device that is being shared across multiple processors by issuing console message ICK020D. Processing continues only after you reply positively, else the request is terminated.

Sharing across multiple users and partitions in a single processor

During an INIT or REFORMAT process, ICKDSF issues OVTOC to gain exclusive control of the VTOC before starting its processing. After ICKDSF completes its processing, CVTOC is issued to release exclusive control. This ensures that no other user/partition (that uses OVTOC) has access to the volume while ICKDSF is changing the VTOC.

For media maintenance operations, if you are not running “concurrent media maintenance”, simultaneous access to a particular track by ICKDSF and users/programs in another VSE partition can result in a data integrity exposure. To avoid this, make sure that when running ICKDSF you have exclusive use of those tracks. For more information, see “Preserving data under Concurrent Media Maintenance” on page 180.

Chapter 7. Getting started with the Stand-Alone version

SA

This chapter describes how to use the Stand-Alone version of ICKDSF. It includes the following information:

- About the Stand-Alone version
- Overview of the ICKDSF tasks using the Stand-Alone version
- Creating an ICKDSF Stand-Alone IPL tape using MVS
- Creating an ICKDSF Stand-Alone IPL tape using CMS
- Preparing to use the Stand-Alone
- IPLing the Stand-Alone ICKDSF
- IPLing the Stand-Alone from a tape library
- IPLing the Stand-Alone with a load parm specified
- IPLing the Stand-Alone with no load parm specified
- Loading the Stand-Alone ICKDSF from CD-ROM
- Defining the input and output device
- Interpreting error conditions
- Performing ICKDSF tasks on minidisks with the Stand-Alone version

For other examples of ICKDSF tasks using the Stand-Alone version, see:

“Analyzing volumes with the Stand-Alone version” on page 105

“Initializing volumes with the Stand-Alone version” on page 159

“Analyzing volumes with the Stand-Alone version” on page 301

“Inspecting volumes with the Stand-Alone version” on page 331

“Mapping volumes with the Stand-Alone version” on page 339

About the Stand-Alone version

You can run the Stand-Alone version of ICKDSF under an IBM System/390® in ESA, LPAR, or XA mode, and in a virtual machine on VM. However, it is recommended that you use the CMS version of ICKDSF under VM, as described in Chapter 5, “Getting started with the CMS version.”

You can run the Stand-Alone version of ICKDSF under VM three ways:

- IPL ICKDSF from a Stand-Alone tape.
- Using exec “ICKGENSA” to create module “ICKSADSF MODULE” from the ICKDSF Stand-Alone core image file, which is provided with the CMS version. This module may then be used by the Stand-Alone Program Loader (SAPL), which is available with VM/ESA 2.0 or higher. See the VM planning and Administrations document for your VM operating system for more information about the Stand-Alone Program Loader.
- Punch the CMS file ICKSADSF COREIMAG to your virtual card reader and IPL the file from the virtual reader.

Note: The preferred method in a CMS environment is to use the CMS executable module.

VM

Under VM, each device must either be dedicated to the virtual machine or linked as a minidisk. For more information on using ICKDSF under VM, see Chapter 8, “ICKDSF versions supported as guests under VM.”

Using ICKDSF–Stand-Alone

VSE

The Stand-Alone version of ICKDSF is no longer shipped with the VSE version (in DSFSA.Z). With VSE version 2 and above, the VSE Stand-Alone supervisor will load the VSE version of ICKDSF, rather than creating an IPLable Stand-Alone ICKDSF using BACKUP.

Overview of the ICKDSF tasks using the Stand-Alone version

Figure 22 on page 57 shows an example of the tasks you can perform using ICKDSF and the commands you need to complete each task. Before using any ICKDSF commands, see their descriptions in:

Part 2, “Using ICKDSF to install and maintain CKD devices,” on page 69

Part 3, “Using ICKDSF to install and maintain FBA devices,” on page 285

Figure 22 on page 57 also describes the general usage of ICKDSF commands. For detailed media maintenance procedures, see *Maintaining IBM Storage Subsystem Media*, GC26-4495. For 9345 devices see *9340 Customer Guide for Using SIMs*, GC26-4858.

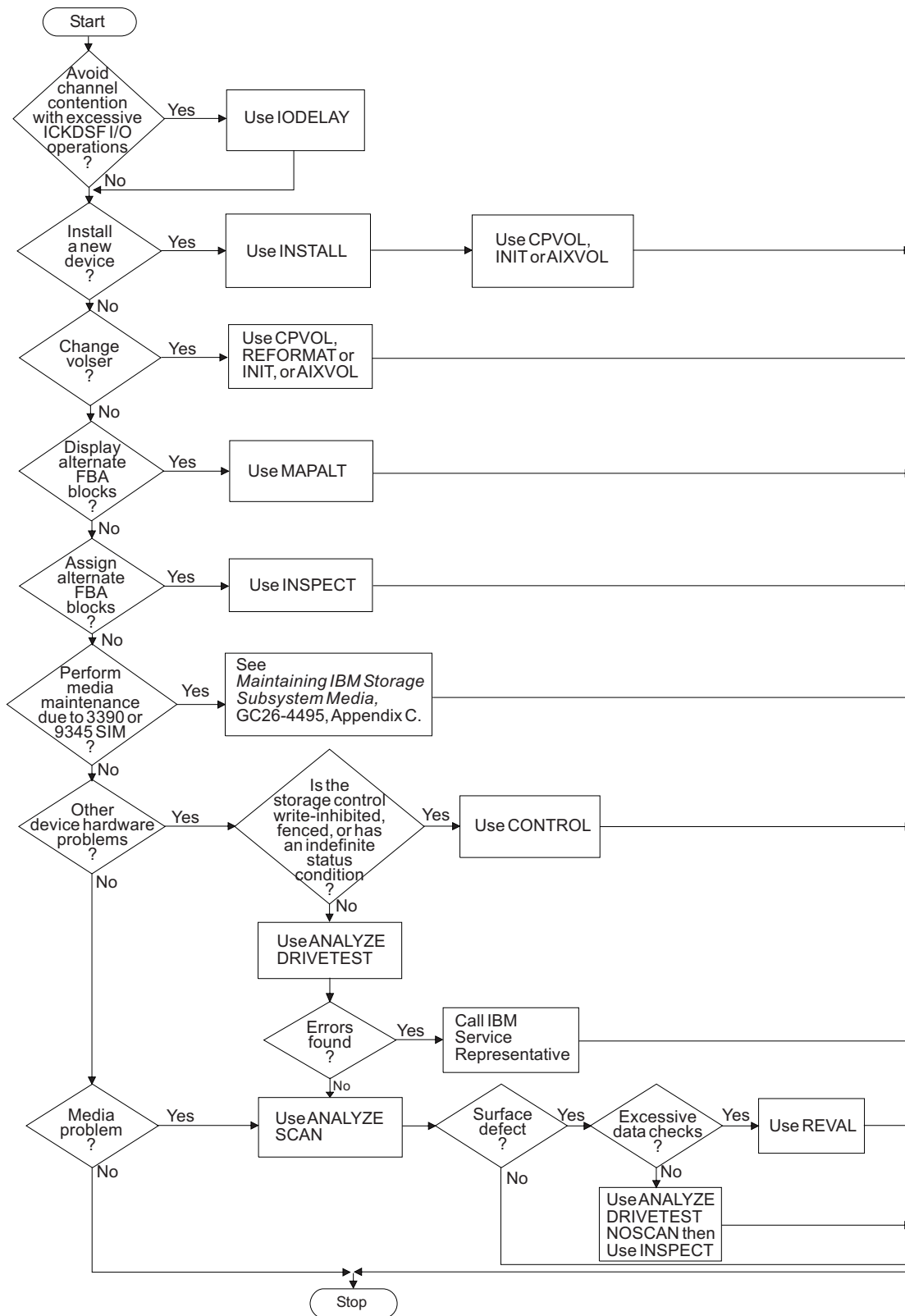

Figure 22. ICKDSF tasks using the Stand-Alone version

Creating an ICKDSF Stand-Alone IPL tape using MVS

MVS

For MVS, the Stand-Alone code is in SYS1.SAMPLIB as ICKSADSF. You can load the ICKDSF program from a file on tape or from a binary-card deck.

Figure 23 is an example of how you can use MVS job control language (JCL) to copy the Stand-Alone ICKDSF code to an unlabeled tape. There should be only one file on the tape. BLKSIZE=80 is required on the tape data set.

```
//JOBNAME JOB JOB CARD PARAMETERS
//STEPNAME EXEC PGM=IEBGENER
//SYSPRINT DD SYSOUT=A
//SYSIN DD DUMMY,DCB=BLKSIZE=80
//SYSUT1 DD DSN=SYS1.SAMPLIB(ICKSADSF),UNIT=SYSDA,
// DISP=SHR,VOLUME=SER=XXXXXX
//SYSUT2 DD DSN=ICKDSF,UNIT=3490,LABEL=(,NL),
// DISP=(,KEEP),VOLUME=SER=YYYYYY,
// DCB=(RECFM=F,LRECL=80,BLKSIZE=80)
```

Figure 23. MVS JCL to copy Stand-Alone ICKDSF to tape

Creating an ICKDSF Stand-Alone IPL tape using CMS

CMS

For CMS, the Stand-Alone code is in the CMS file ICKSADSF COREIMAG.

Figure 24 is an example of how you can use an EXEC to copy the Stand-Alone program code to an unlabeled tape.

```
/* This EXEC creates an IPLable stand-alone Device Support Facilities */
/* tape from the CMS file ICKSADSF COREIMAG. */

Address 'COMMAND'
'CP REWIND 181'
If Rc = 0
Then Do
'FILEDEF INMOVE DISK ICKSADSF COREIMAG * ( LRECL 80 RECFM F'
'FILEDEF OUTMOVE TAP1 ( LRECL 80 RECFM F BLOCK 80'
'MOVEFILE'
If Rc = 0
Then Say '*** stand-alone ICKDSF successfully generated ***'
Else Say '*** error loading ICKSADSF COREIMAG to tape ***'
End
Else Say '*** tape at 181 not attached or not ready ***'
Exit Rc
```

Figure 24. CMS EXEC to copy Stand-Alone ICKDSF to tape

Preparing to use the Stand-Alone

The ICKDSF Stand-Alone can be loaded in one of the following ways:

- It can be IPLed from a tape or card reader.
- It can be IPLed from the ICKDSF CD-ROM version by way of the Optical Media Attach (OMA). When you use OMA to IPL the Stand-Alone, the CD-ROM emulates a channel-attached 3422 tape drive.

Note: When you IPL from the CDROM by way of OMA, if you are on a 2074 that has other systems attached, and the 2074 is busy because of other activity from those systems, then you may encounter a 'load failed' because the control unit is busy. If this occurs, you should retry the IPL, or wait until the 2074 is not busy.

- It can be loaded from the ICKDSF CD-ROM version by way of the 'Load from CD-ROM or SERVER' task on IBM processors that support this feature. This method cannot be used to load the Stand-Alone when running under VM.

IPLing the Stand-Alone ICKDSF

Stand-Alone ICKDSF requires the following conditions or preparation when you IPL (from tape, card reader, or by way of OMA on the ICKDSF CD-ROM):

- Use a Service Call Logical Processor Facility (SCLP) console or any console that is compatible with the IBM 327X. Remote devices are not supported.

When IPLing the Stand-Alone, there are 2 methods that can be used:

- You can enter a load parm on the IPL panel (on supported processors) prior to IPLing, to predefine the console that you want ICKDSF Stand-Alone to use. When you use this method, ICKDSF Stand-Alone will attempt to use the console you specified in the load parm.
- You can IPL the Stand-Alone without specifying a load parm. When you use this method, ICKDSF interprets the first interrupt it receives as the console device. Therefore, you must disconnect any device other than the console that can generate an interrupt before IPLing ICKDSF Stand-Alone.

IPLing the Stand-Alone from a tape library

Stand-Alone ICKDSF can be IPLed from the IBM 3494 Tape Library Dataserver (D/T3494) with the following limitations/restrictions:

- ICKDSF Stand-Alone must be at Release 16 or higher.
- Microcode levels must be at the following levels or higher:
 - Library Manager microcode level - 50C.00
 - D/T3490 microcode level - C05568R
- Supported only when running in XA or ESA mode.
- Drives to be used for Stand-Alone MUST be offline to other systems.
- When using the D/T3494 tape library for the IPL tape, the IPL tape must be mounted and ready prior to performing the IPL.
- Mounting of the IPL tape can be done by way of either:
 - MOUNTING TAPES INSIDE THE LIBRARY: Tapes inside the D/T3494 library can be mounted by way of the Library Manager Console 'Setup Stand-Alone Device' pop up window using the 'Mount a single volume' selection, and specifying the device and the volser.
DeMOUNTING: Select the 'Demount a single volume' selection, specifying the device, to unload and demount the IPL tape after Stand-Alone completion.
 - MOUNTING TAPES NOT INSIDE THE LIBRARY: The transient mount operation can be used to mount tapes not inside the D/T3494 library, by way of the 'Library Manager Console Setup Stand-Alone Device' pop up window, using the 'Mount from Input Station' selection, and specifying the device.
DeMOUNTING: Unload and demount the IPL tape after Stand-Alone completion by cancelling the mount from input station (cancel from library manager console).

Using ICKDSF–Stand-Alone

See the *Magstar 3494 Tape Library Dataserver Operator's Guide*, GA32-0280, and the *3494 Tape Library Dataserver Intro and Plan Guide*, GA32-0279, for details on how to set up and use a Stand-Alone device.

IPLing the Stand-Alone from SAPL

When IPLing Stand-Alone from the stand alone program loader (SAPL) the load parameters and IPL parameters supported by SAPL will also be supported by ICKDSF. When IPLing Stand-Alone the following load parms may be specified:

```
CNSLxxxx  
CONSxxxx  
xxxx
```

Where

1. 'CNSL' or 'CONS' identifies that load parm is a console.
2. 'xxxx' is the console address to use and must be:
 - a. 'SCLP' or 'SYSC' to indicate that you want to use an SCLP (or HMC) console. For example, the load parm would be CONSSYSC to indicate that ICKDSF Stand-Alone should attempt to use the HMC console.

Or

- b. 'ccuu', where ccuu is the device address of a channel attached console. For example, the load parm would be specified as 'CNSL9' or just '9' to indicate that ICKDSF Stand-Alone should attempt to use the console at address 9.

The following rules apply for specifying a 'ccuu':

'ccuu' must be specified as 1 to 4 digits.

The digits must be valid hex digits (0-9, A-F).

The device must be a valid supported console in the configuration and must be operational. If the address consists of valid hex digits ICKDSF will do the console I/O to the device and has no way to check if the device exists, or if it is working, or if in fact it is a console without doing I/O to it.

The following IPL parameters are also supported from the SAPL panel:

```
CON=xxxx  
CONS=xxxx
```

Where

1. 'CON' or 'CONS' identifies that ipl parm is a console.
 2. 'xxxx' is the console address to use and must be:
 - a. 'SYSC' to indicate that you want to use an SCLP (or HMC) console. For example, the ipl parm would be CONS=SYSC to indicate that ICKDSF Stand-Alone should attempt to use the HMC console.
- Or
- b. 'ccuu', where ccuu is the device address of a channel attached
 - c. 'ccuu', where ccuu is the device address of a channel attached console. For example, the ipl parm would be specified as 'CONS=9' to indicate that ICKDSF Stand-Alone should attempt to use the console at address 9. The same rules that apply for load parm of 'ccuu' also apply to the ipl parm of 'ccuu'.

When a load or ipl parm is specified to indicate a console to be used, and an error occurs attempting initial communication with that device, a disabled wait is loaded

to identify the type of problem. The user must correct the problem and re-IPL the Stand-Alone to identify the console to be used.

IPLing the Stand-Alone with a load parm specified

Prior to IPLing, specify the load parm to indicate the console you want ICKDSF to use.

The required format for the load parm for Stand-Alone ICKDSF is 8 characters specified as:

CNSLxxxx

Where

1. 'CNSL' is required as the first 4 characters to ensure residual data in the load parm field is not interpreted as the predefined console.
2. 'xxxx' indicates the console you want to use and must be either:
 - a. 'SCLP' to indicate that you want to use an SCLP (or HMC) console. For example, the load parm would be specified as CNSLSCLP to indicate that ICKDSF Stand-Alone should attempt to use the HMC console.

Or

- b. 'ccuu', where ccuu is the device address of a channel attached console. For example, the load parm would be specified as CNSL0521 to indicate that ICKDSF Stand-Alone should attempt to use the console at address 521.

The following rules apply for specifying a 'ccuu':

- 'ccuu' must be specified as 4 digits (a leading zero is required for a 3 digit device address).
- The digits must be valid hex digits (0-9, A-F).
- The device must be a valid supported console in the configuration and must be operational. If the address consists of valid hex digits, ICKDSF will do the console I/O to the device and has no way to check if the device exists, or if it is working, or if in fact it is a console without doing I/O to it.
- The console must be a 3270 type console (not a printer/keyboard type such as 3215, etc.).

When a load parm is specified to indicate a console to be used, and an error occurs attempting initial communication with that device, a disabled wait is loaded to identify the type of problem. The user must correct the problem and re-IPL the Stand-Alone to identify the console to be used.

IPLing the Stand-Alone with no load parm specified

IPL the ICKDSF Stand-Alone from your IPL device according to the procedures for your installation.

1. IPL the ICKDSF program from the tape unit according to the procedures for your installation. The program contains the instructions necessary to load and store itself in the lower addresses of main storage.

When the program is loaded, the processor enters the WAIT state, and the program status word (PSW) contains the following:

EC mode * 030E0000 XXFFFFFF

Using ICKDSF–Stand-Alone

An asterisk (*) before the PSW indicates the high-order bit is or is not on (either X'80' or X'00') in the byte designated by XX. For other wait PSW conditions, see "Interpreting error conditions" on page 64.

When you IPL the ICKDSF Stand-Alone from your IPL device (with no load parm specified) according to the procedures for your installation, ICKDSF interprets the first interrupt it receives as the console device. Therefore, you must disconnect any device other than the console that can generate an interrupt before IPLing ICKDSF.

2. Identify the console by pressing the Request or Enter key at the console.

Loading the Stand-Alone ICKDSF from CD-ROM

Stand-Alone ICKDSF requires the following conditions or preparation when you load from CD-ROM or SERVER:

- An SCLP console. If you do not have an SCLP console, this method of loading ICKDSF Stand-Alone is not supported.
- A processor that supports the 'Load from CD-ROM or SERVER' task.

Load the ICKDSF Stand-Alone according to the procedures for your installation.

When loading the ICKDSF Stand-Alone by way of 'load from CD-ROM or SERVER' the ICKDSF Stand-Alone will automatically attempt to use the SCLP type console as the operator console.

Defining the input and output device

Defining the input and output device information follows:

1. After you identify the console, the following message appears:

```
ICK005E DEFINE INPUT DEVICE, REPLY "dddd,ccuu" or "CONSOLE"
```

To specify the console as the input device, enter **CONSOLE** or a null line.

To specify a different device type as the input device, enter **dddd,ccuu**, where **dddd** is one of the device types listed below, **cc** is the channel address, and **uu** is the unit address. For example, to select the 3505 Card Reader, enter **3505,ccuu**.

- 1442 Model N1 Card Read Punch, Model N2 Card Punch
 - 2501 Models B1 and B2 Card Reader
 - 2520 Model B1 Card Read Punch, Models B2 and B3 Card Punch
 - 2540 Model 1 Card Read Punch
 - 3504 Models A1 and A2 Card Reader
 - 3505 Models B1 and B2 Card Reader
 - 3525 Card Punch (with card-read feature)
 - SCLP Hardware System Console (or compatible console) attached to an ES/9000 processor, supported as CONSOLE
 - CARD
2. After you identify the input device, the following message appears:

```
ICK006E DEFINE OUTPUT DEVICE, REPLY "dddd,ccuu" or "CONSOLE"
```

To specify the console as the output device, enter **CONSOLE** or a null line.

To specify a different device type as the output device, enter **dddd,ccuu**, where **dddd** is one of the device types listed below, **cc** is the channel address, and **uu** is the unit address. For example, to select the 3800 Printing Subsystem, enter **3800,ccuu**.

- 1403 Models 2, 7, and N1 Printer
 - 1443 Model N1 Printer
 - 3203 Models 1, 2, 4, and 5 Printer
 - 3211 Printer
 - 3800 Printing Subsystem
 - 3262 Line Printer
 - 3289 Model 4 Printer
 - 4248 Printer
 - 5203 Model 3 Printer
 - 6262 Printer
 - SCLP Hardware System Console (or compatible console) attached to an ES/9000 processor, supported as CONSOLE
 - PRNT
3. The date and time are automatically picked up from the processor's time-of-day (TOD) clock. The clock usually indicates Greenwich Mean Time, and this date and time are reflected in any listings.

If the TOD clock is in error or not set, the following message appears:

```
ICK015E SUPPLY TODAY'S DATE, REPLY "MM/DD/YY"
```

Enter today's date in the format indicated.

4. After you enter today's date, the following message appears:

```
ICK016E SUPPLY TIME OF DAY, REPLY "HH:MM:SS"
```

Enter the current time in the format indicated.

If you press the Enter without specifying a date or time of day, they are set to 0.



Messages ICK015E and ICK016E can reappear if you create a VTOC entry for a data set. Enter the information each time to ensure that the VTOC entry is correct.

5. You are now ready to enter ICKDSF commands from the input device. You can control ICKDSF command execution by using IF-THEN-ELSE statements. For more information, see "Writing statements to control ICKDSF processing" on page 19.
6. The ICKDSF program stops running at the end of the command input stream. If you are using the console as the input device, enter **EOF** when prompted for the next command.

When the program stops, the processor is placed in a WAIT state, and the PSW should contain the following:

```
EC mode * 030E0000 XXEEEEzz
```

Using ICKDSF–Stand-Alone

zz indicates the highest decimal condition code encountered while running.

zz	Indicates condition code
X'00'	0
X'04'	4
X'08'	8
X'0C'	12
X'10'	16

For condition code values, see “Writing statements to control ICKDSF processing” on page 19.

Interpreting error conditions

Table 23 shows the PSW error condition codes for ICKDSF and their meanings. An asterisk (*) before the PSW indicates the high-order bit might or might not be on (either X'80' or X'00') in the byte designated by XX.

Table 23. IPL error PSW codes

PSW Error Condition (EC Mode)	Indicates...																		
* 000A0000 XX000033	Insufficient real storage available for ICKDSF. All input is read.																		
* 000A0000 XX000022	A unit check occurred on the IPL device during IPL.																		
* 000A0000 XX000044	A channel error occurred on the IPL channel during IPL.																		
* 000A0000 XX000055	The IPL device was not operational during IPL.																		
* 000A0000 XX0000E2	A machine check.																		
* 020A0000 XX111111	ICKDSF is waiting for an I/O interrupt. If ICKDSF stops running, a missing I/O interrupt condition has occurred. Re-IPL ICKDSF and rerun the failing command. If the problem persists, contact your IBM service representative.																		
* 010A0000 XXF1F1F1	Waiting for the operator to input data from the SCLP console.																		
* 010A0000 XXF4F4F4	Waiting for the SCLP external interrupt.																		
* XXEE0040	SCLP equipment check.																		
* XXEE0340	SCLP equipment check.																		
* 010A0000 XXF3F3F3	The Stand-Alone is waiting for a response from the processor in order to determine system features. If this wait state continues to persist, contact your IBM service representative to determine why the processor did not respond.																		
* 010A0000 00999999	A wait state.																		
* 030E0000 XXEEEEnn	The processor is placed in a WAIT state. <i>nn</i> indicates the type of error: <table border="0" style="margin-left: 20px;"> <thead> <tr> <th>nn</th> <th>Indicates</th> </tr> </thead> <tbody> <tr> <td>X'13'</td> <td>A supervisor call instruction (SVC) interrupt</td> </tr> <tr> <td>X'14'</td> <td>A program interrupt</td> </tr> <tr> <td>X'15'</td> <td>Insufficient main storage</td> </tr> <tr> <td>X'16'</td> <td>An I/O error</td> </tr> <tr> <td>X'17'</td> <td>Data set not open</td> </tr> <tr> <td>X'18'</td> <td>Console not defined</td> </tr> <tr> <td>X'19'</td> <td>No end-of-data routine</td> </tr> <tr> <td>X'1A'</td> <td>SCLP console not defined or not operational</td> </tr> </tbody> </table>	nn	Indicates	X'13'	A supervisor call instruction (SVC) interrupt	X'14'	A program interrupt	X'15'	Insufficient main storage	X'16'	An I/O error	X'17'	Data set not open	X'18'	Console not defined	X'19'	No end-of-data routine	X'1A'	SCLP console not defined or not operational
nn	Indicates																		
X'13'	A supervisor call instruction (SVC) interrupt																		
X'14'	A program interrupt																		
X'15'	Insufficient main storage																		
X'16'	An I/O error																		
X'17'	Data set not open																		
X'18'	Console not defined																		
X'19'	No end-of-data routine																		
X'1A'	SCLP console not defined or not operational																		
* 000A0000 XXFAFAFA	'CNSLSCLP' was specified in the load parm, but the SCLP-type console cannot be used. Possible reasons are: it does not exist or is not supported on the processor, or an error occurred attempting to determine if the support exists.																		

Table 23. IPL error PSW codes (continued)

PSW Error Condition (EC Mode)	Indicates...
* 000A0000 XXFBFBFB	A 'ccuu' was specified in the load parm to identify an I/O attached console. However, an error occurred trying to attempt initial communication with the device.
* 000A0000 XXFCFCFC	The Stand-Alone was unable to communicate with the console identified in the load parm because it is not attached or is not operational.
* 000A0000 XXFDFFDFD	The load parm was specified incorrectly. The characters 'CNLS' must be the first 4 characters specified.
* 000A0000 XXFEFEFE	A 'ccuu' was specified in the load parm to identify an I/O attached console, but the 'ccuu' specified in the load parm is invalid.
* 000A0000 XXFFyyyy	'CNLS SCLP' was specified in the load parm to identify an SCLP-type console. However, an unexpected error occurred trying to attempt initial communication with the console. 'yyyy' represents the error code returned from the hardware.
* 000A0000 XXFF0040	'CNLS SCLP' was specified in the load parm to identify an SCLP-type console. However, a SCLP equipment check occurred trying to attempt initial communication with the console.
* 000A0000 XXFF0340	'CNLS SCLP' was specified in the load parm to identify an SCLP-type console. However, a SCLP equipment check occurred trying to attempt initial communication with the console.
* XXEEyyyy	An unexpected error occurred when communicating with the SCLP-type console. 'yyyy' represents the error code returned from the hardware.

Note: ICKDSF Stand-Alone no longer supports 370 mode. If you IPL in 370 mode you will receive a wait psw with one of the following:
 BC mode * 00020000 XX370370
 EC mode * 000A0000 XX370370

Performing ICKDSF tasks on minidisks with the Stand-Alone version

Table 24 shows the commands you can use to perform tasks on minidisks with the Stand-Alone version of ICKDSF.

If you need diagnostic or media maintenance on a device in the Stand-Alone version, the device must be dedicated to a virtual machine. However, the commands you use depend on the device type, VM system restrictions, and your need for special authorization.

Table 24. ICKDSF commands

AIXVOL	You format 3380, 3390, and 9345 minidisks in a CMS or Stand-Alone version for use in the AIX/ESA environment by using the MIMIC parameter.
ANALYZE	You can use ANALYZE with the SCAN parameter on minidisks, but you must always use LIMITS (or the equivalent range parameters). LIMITS must be within the bounds of the minidisk. If you do not set limits, I/O is attempted outside the range of the minidisk and apparent I/O errors will occur.
CPVOLUME	You can format minidisks for use in the VM environment by using the MIMIC parameter. For more information, see minidisk support in Chapter 14, "CPVOLUME command—CKD," on page 129 or Chapter 25, "CPVOLUME command—FBA," on page 305.

Using ICKDSF–Stand-Alone

Table 24. ICKDSF commands (continued)

INIT	<p>You can initialize minidisks at the minimal level for guest operating system use. This includes all current DASD.</p> <p>CKD Devices—To run a minimal INIT on CKD devices, enter:</p> <p>MIMIC(MINI(n)) DEVTYPE(devicetype)</p> <ul style="list-style-type: none">• n= number of cylinders• DEVTYPE(devicetype) is required <p>If you omit the MIMIC parameter and attempt a minimal INIT, I/O errors occur because the device is recognized as a real device.</p> <p>FBA Devices—Minidisk processing for the INIT command for FBA devices is automatic. Do not specify MIMIC(MINI(n)). ICKDSF can dynamically determine the number of blocks allocated to the minidisk and can initialize the device accordingly.</p> <p>MAP is not supported.</p>
REFORMAT	<hr/> <p>Operates on a minidisk exactly as it does on a real volume.</p> <p>Accesses only those areas where the volume serial number, owner identification, IPL bootstrap records, and VTOC and Index exist on the volume. REFORMAT generally does not include diagnostic channel command words (CCWs) and should complete without errors.</p> <hr/>

Chapter 8. ICKDSF versions supported as guests under VM

This chapter describes ICKDSF versions on guest operating systems and gives some guidelines for problem solving under VM.

SA The Stand-Alone version of ICKDSF supports minidisks, but cannot perform media maintenance to minidisks. All devices are treated as dedicated. For more information, see Chapter 7, “Getting started with the Stand-Alone version.”

MVS **VSE** The MVS and VSE versions of ICKDSF treat all devices as real. Before you IPL the guest operating system, use the CMS or Stand-Alone version of ICKDSF to initialize (use the INIT command) a minidisk. You cannot perform media maintenance on minidisks or full-pack minidisks from a guest system.

A full-pack minidisk is treated the same as any other minidisk because it does not contain the service, diagnostic, or surface analysis cylinders necessary for device support purposes. A full-pack minidisk can contain the alternate cylinder depending on how it was defined in the user directory. In addition, the VM system restricts the use of certain types of channel command words (CCWs) on minidisks.

You can perform media maintenance only on a real device that is dedicated to the virtual machine. You might require special authorization to perform device support functions.

All devices are treated as real. Table 25 shows the commands that can operate on a minidisk from a guest operating system. These commands and functions do not generally issue diagnostic type CCWs.

Table 25. ICKDSF Commands that operate on a minidisk from a guest operating system

ANALYZE	You can use ANALYZE with the NODRIVE SCAN parameter on minidisks, but you must always use LIMITS (or the equivalent range parameters). LIMITS must be within the bounds of the minidisk. If you do not set limits, I/O is attempted outside the range of the minidisk, and apparent I/O errors will occur.
BUILDIX	MVS You can use BUILDIX to access only those areas where the VTOC and IXVTOC exist on the volume. BUILDIX generally does not issue diagnostic CCWs and completes without errors.
REFORMAT	You can use REFORMAT to access volume serial number, owner identification, IPL bootstrap records, and VTOC and Index on the volume. REFORMAT generally does not include diagnostic channel command words (CCWs) and should complete without errors.

Note: You can use an ICKDSF command on a minidisk from a guest operating system only if the ICKDSF version supports the command.

Problem solving under VM

To perform device support functions, you might require special authorization. You need MAINTCCW authority, which is defined on the option statement in the CP directory.

In addition, the VM system restricts the use of certain types of CCWs.

ICKDSF versions under VM

If ICKDSF ends with an I/O error message, determine if the error is generated by the VM system or the device under test. Use a CP TRACE CCW command to recreate and determine the problem.

If the error is generated by the VM system, then the error is generally caused by either a command reject or channel program check.

If the error is caused by a command reject, then the I/O error sense information has byte 0 bit 0 on. Often, bytes 23 and 24 contain either X'0F00' or X'0F04'.

If the error is caused by a channel program check, it is sometimes reflected in the channel status word (CSW), such as CSW byte 4 and 5 as X'0020'.

Errors are most likely caused by one of the following:

Table 26. Problem solving under VM

Error	Action
Your user ID does not have the required authorization and the CCW issued by ICKDSF is restricted by the VM system. The device can be a minidisk or a dedicated volume.	Contact the VM system programmer to obtain authorization.
The area that ICKDSF was trying to access does not exist on the volume. When a device is a minidisk, it can contain alternate, service, diagnostic, or surface analysis cylinders which are necessary for device support purposes.	<ul style="list-style-type: none">• The command you are using is not supported in the current environment. Do not use that command.or• You need to use the MIMIC(MINI) parameter in the Stand-Alone version. Note that a full-pack minidisk is still a minidisk.
The actual size of the primary area of the minidisk is smaller than the requested ICKDSF function. For example, MIMIC(MINI(50)) is specified for a 20 cylinder minidisk.	Specify the correct size.

Part 2. Using ICKDSF to install and maintain CKD devices

Part 2. describes how to use the ICKDSF commands to install and maintain CKD devices. See Table 13 on page 8 for a list of CKD devices supported by ICKDSF.

Chapter 9, “Examples of ICKDSF tasks—CKD devices,” on page 71 is an overview of the tasks you perform for installation and maintenance of CKD devices. It provides guidelines to help you determine why, when, and how to run ICKDSF.

The other chapters in **Part 2.** list the commands in alphabetic order. Each command explanation includes:

- A table summarizing the syntax of the command
For a detailed explanation of ICKDSF command syntax see Chapter 3, “Understanding ICKDSF command statements,” on page 17
- An explanation of required and option parameters
- A general description of the command and its use
- Examples.

Examples of ICKDSF commands used to install and maintain FBA devices appears in Part 3, “Using ICKDSF to install and maintain FBA devices.”

Chapter 9. Examples of ICKDSF tasks—CKD devices

The examples in this chapter show the commands and parameters needed for the following tasks:

- Installing devices
- Resuming initialization from a checkpoint location
- Formatting devices
- Problem determination
- Media maintenance
- Emulating devices
- Performing miscellaneous tasks with ICKDSF

Default parameters are included only when they produce additional output. For complete descriptions of each command and more examples, see the individual commands beginning with Chapter 10, “AIXVOL command—CKD,” on page 89.

Installing devices

This section includes guidelines for:

- Completing the installation procedure after physical installation
- Installing devices from the factory
- Setting an IBM 3390 or 9391 to 3380 track compatibility mode or 3380 track format
- Installing older devices

See “Formatting devices” on page 76 for the tasks you perform after installation.

Note: These tasks are not required for any devices emulated by the 9394.

Completing the installation procedure

When your IBM service representative completes the physical installation of a new device, you must complete the recommended installation procedure for that device:

- For 3995-151, 3995-153, 9391, 9394, 9393, 9396, 9397, and Internal Disk devices installation procedures are not required. Use the procedures in “Formatting devices” on page 76 to initialize these devices for use in your operating environment.
- For 3380, 3390, and 9345 devices, use the INSTALL command.
- For all other devices, use the INIT command to perform a medial INIT.

After completing the installation process, you must format the volume, that is, make it usable in a specific operating environment.

Minimal INIT refers to using the INIT command to write the volume label and VTOC on volumes for use by MVS or VSE operating systems.

Medial INIT refers to using the INIT command to validate the home address and record 0, followed by a minimal INIT.

Installing a device from the factory

For 3380, 3390, and 9345 HDAs, use the INSTALL command to rewrite all home addresses and record 0s on the volume.

Examples of ICKDSF tasks—CKD devices

In the following example, for all 3390 head-disk assemblies (HDA) except the 3390-9, you could also use the SETMODE parameter. For more information, see “Setting an IBM 3390 to 3380 track compatibility mode.” The 3390-9 device does not support 3380 track compatibility mode.

```
INSTALL UNITADDRESS(ccuu)
```

If you are installing a new 9345 device, you might not need to run the INSTALL command. Your IBM customer engineer will run a Track Center Test during the install process and give you a list of device addresses against which you need to run the INSTALL command. If no 9345 devices need the INSTALL command run, then you are ready to format the device for your operating environment. For more information about formatting volumes, see “Formatting devices” on page 76.

If you have physically moved the device and need to reinstall it, the volume has a volser. Because the volume has a volser, you must specify either the VERIFY or NOVERIFY parameter to process the volume.

Use CPVOL or AIXVOL to prepare a volume for use in a VM or AIX operating system environment.

Data on the volume is erased. If you want to preserve your data, copy it to a backup device before processing begins.

Setting an IBM 3390 to 3380 track compatibility mode

MVS

In this example, an IBM 3390 volume is changed from 3390 mode to 3380 track compatibility mode.

Note: The 3390-9 and 9394 devices do not support 3380 track compatibility mode.

After INSTALL command processing, the volume is not formatted. Because this is an MVS volume, a minimal INIT is issued. INIT formats the volume by specifying the volume identification and NOVERIFY.

```
//EXAMPLE JOB
// EXEC PGM=ICKDSF
//SYSPRINT DD SYSOUT=A
//SYSIN DD *
INSTALL UNITADDRESS(0353) SETMODE(3380)
IF LASTCC<8 -
THEN INIT UNIT(0353) NOVERIFY VOLID(ABCD4) NOVALIDATE
/*
```

To format the volume for other systems, use:
The INIT command for VSE or MVS volumes
The CPVOLUME command for VM volumes
The AIXVOL command for AIX volumes

For more information about formatting volumes, see “Formatting devices” on page 76 or the applicable command explanation.

Installing a 3375 or older HDA from the factory

For all 3375, or older volumes, you must use the INIT command to perform a medial INIT. medial INIT validates the home address and record 0, and then performs a minimal INIT on a volume.

```
INIT UNITADDRESS(ccuu) NOVERIFY VOLID(serial) OWNERID(owner) –
      VTOC(cylinder,track,extent) VALIDATE DATA
```

Usage Notes:

- **Data on the volume is erased.**
- This example establishes a volume ID, an owner ID, and a VTOC for the volume.
- The VALIDATE parameter ensures that potentially erroneous data on all tracks is erased by initializing at the medial level for the entire volume.

MVS

- To write IPL program records on the volume, add the IPLDD parameter to the end of the parameter list:

```
IPLDD(SYSIN,ABSFORMAT)
```

- The DATA parameter is valid only for the IBM 3375, 3380, 3390, and 9345 devices. If the example is run against a device other than the 3375, 3380, 3390, or 9345, DATA is ignored.

The DATA parameter writes a full track of data on every track on the volume. This data is a predefined pattern similar to the data that is used to certify the volume at the factory. The data is referred to as **factory functional verification data patterns (FFVDP)**.

Resuming initialization from a checkpoint location

You can resume processing after ICKDSF automatically checkpoints itself while initializing a volume. For 3380, 3390, and 9345 volumes, you reissue your original INSTALL command. For other volumes, you use the INIT command. If the device does not support ICKDSF checkpointing operations, all ICKDSF checkpointing functions are bypassed.

The examples that follow show how you use the INIT command to resume processing from checkpoint cylinder 200, head 0.

Validating and writing the FFVDP

The following example shows you how to validate and write the FFVDP on a volume.

```
INIT UNIT(ccuu) NOVFY VALIDATE DATA
```

Validating part of a volume

You use the CONTINUE parameter of INIT to resume from the last checkpoint. For example, if processing is interrupted after you issue:

```
INIT UNIT(ccuu) NOVFY VALIDATE DATA
```

and you are unsure of the size of the track you are initializing, you can validate part of a volume by using the INIT command with the CONTINUE parameter.

```
INIT UNIT(ccuu) VALIDATE NODATA NOVERIFY –
      CYLRANGE(100,500) HEADRANGE(2,6) CONTINUE VOLID(volser)
```

Usage Notes:

- All tracks, starting at cylinder 200, head 0 (the last checkpointed location) and continuing for about 1000 tracks, are validated; and data is erased from those tracks. An IBM 3380 would be validated from cylinder 200, head 0 to cylinder 266, head 14.
- Validation (including erasing data) is also done for heads 2 through 6 for all cylinders beyond the last cylinder validated above, up to and including cylinder 500. For example, on a 3380, cylinders 267 to 500 are validated.
- The minimal initialization is then performed.

Writing the FFVDP on part of a volume

If after issuing:

```
INIT UNIT(ccuu) NOVFY VALIDATE DATA
```

processing is interrupted; you can write the FFVDP on part of a volume. The part of the volume specified in the above example was entirely completed before the last checkpointed location. You would then issue:

```
INIT UNIT(ccuu) NOVFY DATA VALIDATE –  
CYLRANGE(0,100) CONTINUE VOLID(volser)
```

Usage Notes:

- All tracks, starting at cylinder 200, head 0 (the last checkpointed location) and continuing for about 1000 tracks, are validated; and the FFVDP is written on them.
- There is no additional validation and writing of the FFVDP for the tracks in the specified range, because the specified range is entirely contained before the last checkpointed location.
- The minimal initialization is then performed.

Writing the FFVDP regardless of previous processing

If after issuing:

```
INIT UNIT(ccuu) NOVFY VALIDATE DATA
```

processing is interrupted; you can use the NOCONTINUE parameter to write the FFVDP on part of the volume, regardless of where previous processing was interrupted.

```
INIT UNIT(ccuu) NOVFY VALIDATE DATA –  
CYLRANGE(0,100) NOCONTINUE VOLID(volser)
```

Usage Notes:

- All tracks, starting at cylinder 200, head 0 (the last checkpointed location) and continuing for about 1000 tracks, are validated; and the FFVDP is written on them.
- Tracks are validated, and the FFVDP is written for the specified cylinders for all heads on the device:
For a 3380 A04, AA4, and AD4, ICKDSF processes heads 0 through 14 for cylinders 0 through 100.
- The minimal initialization is then performed.

Validating from a specific point

If after issuing:

```
INIT UNIT(ccuu) NOVFY VALIDATE DATA
```

processing is interrupted; you can validate part of the volume from a specific point.

```
INIT UNIT(ccuu) NOVFY VALIDATE –  
FROMRANGE(500,6) CONTINUE VOLID(volser)
```

Usage Notes:

- All tracks, starting at cylinder 200, head 0 (the last checkpointed location) and continuing for approximately 1000 tracks, are validated; and data is erased.
- All tracks are then validated, starting from cylinder 500 head 6 through the last head on the last alternate cylinder.

For a 3380 A04, AA4, and AD4, ICKDSF processes all tracks on each cylinder starting from cylinder 500, head 6 through cylinder 885, head 14.

- The minimal initialization is then performed.

Validating to a specific point

If after issuing:

```
INIT UNIT(ccuu) NOVfy VALIDATE DATA
```

processing is interrupted; you can validate part of the volume to a specific point.

```
INIT UNIT(ccuu) NOVfy VALIDATE
TORANGE(500,6) CONTINUE VOLID(volser)
```

Usage Notes:

- All tracks, starting at cylinder 200, head 0 (the last checkpointed location) and continuing for approximately 1000 tracks, are validated; and data is erased.
- Starting from cylinder 200, head 0 through cylinder 500, head 6, all tracks on each cylinder are validated; and data is erased from those tracks.

Validating and writing the FFVDP for one head

If after issuing:

```
INIT UNIT(ccuu) NOVfy VALIDATE DATA
```

processing is interrupted; you can validate and write the FFVDP for part of the volume, starting at a specific cylinder for only one head.

```
INIT UNIT(ccuu) NOVfy VALIDATE DATA -
CYLRANGE(500,9999) HEADRANGE(6,6) CONTINUE VOLID(volser)
```

Usage Notes:

- All tracks, starting at cylinder 200, head 0 (the last checkpointed location) and continuing for approximately 1000 tracks, are validated; and the FFVDP is written on them.
- Tracks are validated and the FFVDP is written on head 6 only, from cylinder 500 through the last alternate cylinder.
For a 3380 A04, AA4, and AD4, ICKDSF processes head 6 only, from cylinder 500 through cylinder 885.
- The minimal initialization is then performed.

Validating the last heads of a device

If after issuing:

```
INIT UNIT(ccuu) NOVfy VALIDATE DATA
```

processing is interrupted, you can validate the last few heads of a device.

```
INIT UNIT(ccuu) NOVfy VALIDATE -
HEADRANGE(8,99) CONTINUE VOLID(volser)
```

Usage Notes:

- All tracks, starting at cylinder 200, head 0 (the last checkpointed location) and continuing for approximately 1000 tracks, are validated; and data is erased.
- Validation is performed and data is erased for all cylinders on the device, for heads 8 through n (where n is the maximum head number for the device).

Examples of ICKDSF tasks—CKD devices

For a 3380 A04, AA4, and AD4, ICKDSF processes heads 8 through 14, from cylinder 200 through cylinder 885.

- The minimal initialization is then performed.

Formatting devices

Once your device is initialized, you must format it for your operating environment.

To format your volume, use the:

INIT command for MVS or VSE

CPVOLUME command for VM

AIXVOL command for AIX

Formatting minidisks



With the CMS version of ICKDSF, you can use the INIT command to format a minidisk for MVS use.

This example establishes a volume ID, an owner ID, and a VTOC for a minidisk.

```
INIT UNITADDRESS(ccuu) NOVERIFY VOLID(serial) OWNERID(owner) -  
  VTOC(cylinder,track,extent)
```

To format minidisks for other environments, use:

- The CMS command `FORMAT` for a CMS user. For more information about the CMS `FORMAT` command, see the *CMS Command Reference* applicable to your installation.
- `INIT` for VSE or VSE/VSAM under CMS.
- `AIXVOL` for AIX.
- `CPVOLUME` for a VM guest.

Formatting an entire volume in the CMS version



In this example, all 3339 cylinders on a 3390 Model 3 volume are formatted for a VM guest. The allocation map will indicate that all 3339 cylinders on the volume are allocated as PERM space.

Because `NOREADCHECK` is specified, a read-back check of the volume does not occur.

Because `NOVERIFY` is specified, any existing volume label is ignored, and the volume is labelled “CPVOL1”.

```
CPVOLUME FORMAT UNIT(0150) NOVERIFY VOLID(CPVOL1) NOREADCHECK
```

Formatting part of a volume in the CMS version



The device used in this example is a 3380 with 885 cylinders. The first 100 cylinders on the volume are formatted. The allocation map will indicate that cylinder 0 is PERM space, cylinders 1 through 99 are PAGE space, and cylinders 100 through 884 are PERM space.

Because `NOVERIFY` is specified, any existing volume label is ignored, and the volume is labelled “CPVOL1”.

```
CPVOLUME FORMAT UNIT(0150) NOVERIFY VOLID(CPVOL1) RANGE(0,99) TYPE((PAGE,1,99))
```

Writing the VTOC

MVS **VSE**

This example shows how you can write a VTOC.

```
INIT UNITADDRESS(ccuu) NOVERIFY VOLID(serial) -
  OWNERID(owner) VTOC(cylinder,track,extent)
```

Placing a VTOC at the end of a volume

VSE

In the following example, ICKDSF puts the VTOC at the end of the VSE volume on the last primary cylinder. The VTOC is one cylinder in length.

```
INIT UNIT(ccuu) NOVfy VOLID(volser) VSEVTOC(END)
```

This example allows ICKDSF to choose the location and size of the VTOC. It is valid for all devices except the 3390-9.

Determining the VTOC size and location

MVS

In the following example, ICKDSF determines the location and size of the VTOC for an MVS system. ICKDSF places the VTOC on the last primary cylinder of the volume. The VTOC is one cylinder in length.

```
INIT UNIT(ccuu) NOVfy VOLID(volser) VTOC(END)
```

This example allows ICKDSF to choose the location and size of the VTOC. It is valid for all devices except the 3390-9.

Expanding the VTOC at its current location

In the following example, ICKDSF expands the VTOC at its current location. *n* is the total size in tracks of the new VTOC after the expansion.

```
REFORMAT UNIT(ccuu) NVfy EXTVTOC(n)
```

The following is an example of expanding the VTOC and the Index using the EXTVTOC and EXTINDEX parameters of the REFORMAT command.

```
//EXAMPLE JOB
// EXEC PGM=ICKDSF
//VOLDD DD DISP=SHR,UNIT=3380,VOL=SER=TMP121
//SYSPRINT DD SYSOUT=A
//SYSIN DD *
REFORMAT DDNAME(VOLDD) VERIFY(TMP121) EXTVTOC(200) EXTINDEX(16)
/*
```

Changing the volume serial number and owner identification

MVS **VSE**

Use the REFORMAT command to change the volume serial number and owner identification for MVS or VSE volumes.

You can use the VOLID and OWNERID parameters, or both. You can also add IPL text to the volume at the same time with the IPLDD(SYSIN) parameter.

No other data on the volume is changed.

Examples of ICKDSF tasks—CKD devices

```
REFORMAT UNITADDRESS(ccuu) NOVERIFY VOLID(newvol) -  
OWNERID(newowner)
```

AIX Use AIXVOL LABEL to change the VOLID in an AIX/ESA environment.

CMS Use CPVOL LABEL to change the VOLID for CP volumes.

Adding IPL text to a volume

MVS Use the REFORMAT command to add IPL text to an already-initialized volume.

```
REFORMAT UNITADDRESS(ccuu) NOVERIFY BOOTSTRAP IPLDD(SYSIN)
```

Converting a volume to indexed format

MVS To convert an OS VTOC to indexed format, use the BUILDIX command:

```
//jobname JOB  
//stepname EXEC PGM=ICKDSF  
//SYSPRINT DD SYSOUT=A  
//VOLDD DD UNIT=(3390,,DEFER),VOL=(PRIVATE,SER=VL3390),  
// DSN=SYS1.VTOCIX.VL3390,DISP=OLD  
//SYSIN DD *  
BUILDIX DDNAME(VOLDD) IX  
/*
```

MVS To convert an indexed VTOC back to OS format, use the BUILDIX command:

```
//jobname JOB  
//stepname EXEC PGM=ICKDSF  
//SYSPRINT DD SYSOUT=A  
//VOLDD DD UNIT=(3390,,DEFER),VOL=(PRIVATE,SER=VL3390),  
// DSN=SYS1.VTOCIX.VL3390,DISP=OLD  
//SYSIN DD *  
BUILDIX DDNAME(VOLDD) OS  
/*
```

Problem determination

You can use ICKDSF to diagnose errors without the assistance of a service representative.

You can use the ANALYZE command to examine a device and the data on a volume to help determine the existence and the nature of errors.

You use two parameters with the ANALYZE command:

- DRIVETEST tests the hardware device
- SCAN reads data on a volume

You can use the DRIVETEST parameter to ensure that device hardware can perform basic operations, such as seeks, reads, and writes. DRIVETEST can impact your system performance, but does not alter data.

You can use ANALYZE SCAN to read data that currently exists on a volume. If ANALYZE SCAN reads the data successfully the first time, no further rereading of the track takes place.

A **data check** is an error detected in the bit pattern read from the disk. If a ANALYZE SCAN detects a data check on the first read, it issues further reads of the data. This ensures that the data check is not a random occurrence.

Data is read with subsystem and error recovery processes disabled to allow ANALYZE SCAN to identify all data checks. ANALYZE SCAN has no effect on user data on the volume.

ANALYZE SCAN can also detect 0F0B conditions.³ This condition can arise during a dynamic sparing operation on a 9391 device if an error was detected on the original device during the copy operation. The corresponding track on the spare device will be put in an '0F0B' condition. At times this condition appears as a permanent data check instead of an "0F0B". You can issue INSPECT NOCHECK NOPRESERVE ASSIGN to fix the 0F0B condition. If applicable the name of the containing data set for each track that fails the scan will be printed.

You can enter DRIVETEST and SCAN independently or together. Data is never recorded in the error recording data set (ERDS) during ANALYZE SCAN or ANALYZE DRIVETEST processing. ERDS information is stored in SYS1.LOGREC by MVS, in SYSREC by VSE, and in the error recording area by VM.

Dual copy volumes that are in duplex or suspended duplex state are supported by the ANALYZE command.

Investigating suspected drive problems

If you suspect a problem with a drive, use the ANALYZE command to determine:

- If the drive can perform basic operating functions correctly
- If all data can successfully be read from the disk surface

```
ANALYZE UNITADDRESS(ccuu) SCAN
```

Usage Notes:

- The data on the volume is not altered.
- The drive test option of the ANALYZE command is valid only for the following devices with nonremovable media: IBM 3375, 3380, 3390, 9345, or any CKD emulated on CKD devices. The drive test option is not valid for the 3995 Models 151 and 153.
- Use the SPEED parameter to scan data one cylinder at a time rather than one track at a time.
- Use the LIMITS parameter to specify only a limited area for scanning.

Scanning data on part of a volume

The following examples show how you can use the ANALYZE command to scan selected tracks.

Scanning heads 5 and 6 only, cylinders 500 through 599

In this example, the data verification test is performed for heads 5 and 6 only, on cylinders 500 through cylinder 599.

```
ANALYZE UNIT(ccuu) SCAN NODRIVE -  
          CYLRANGE(500,599) HEADRANGE(5,6)
```

3. An 0F0B condition arises on a track when the home address appears to be defective, but record zero does not point to an alternate track.

Examples of ICKDSF tasks—CKD devices

Scanning from Head 14, Cylinder 500

In this example, after the drive test, the data verification test is performed for all heads starting at head 14, for all cylinders starting at cylinder 500.

```
ANALYZE UNIT(ccuu) SCAN -  
      CYLRANGE(500,9999) HEADRANGE(14,9999)
```

Usage Notes:

After the drive test, all cylinders, from cylinder 500 until the last primary cylinder, are scanned for heads 14 through the last head for this device type.

- For a 3380 A04, AA4, and AD4, ICKDSF processes head 14 only, on cylinders 500 through 884 (alternate cylinder not processed).

Checking disk surfaces with INSPECT

Most media-related data checks are caused by small defective areas on track surfaces. The DASD subsystem can skip these areas. This is referred to as a **skip displacement**.

ICKDSF surface checking detects error sites that might produce data checks when user data is stored on the track. When errors are detected, ICKDSF assigns skip displacements for these error sites. If more than the allowed number of sites are detected for a track, ICKDSF can assign an alternate track.

The 3375, 3380, 3390, and the 9345 tracks contain skip displacement areas.

To check the disk surfaces of these devices, you can use INSPECT with the SKIP parameter. For example:

```
INSPECT UNIT(ccuu) NOVERIFY SKIP TRACKS(cccc,hhhh)
```

In this example, PRESERVE and ASSIGN are default parameters.

PRESERVE saves the data on the track by moving the data from the current track to an alternate track. **NOPRESERVE erases the data on the track.** Use this parameter only if there is no meaningful data on the track or if track errors prevent successful use of PRESERVE.

ASSIGN automatically assigns an alternate track if the track requires more than the device skip-area limit.

For the IBM 9345, you can use the SKIP or CHECK parameter to perform surface checking.

Note: The devices emulated by the 9394 and 9391 have no skip areas. Surface checking is not supported for these devices.

Surface checking part of a volume

Cylinder 4, head 6 through cylinder 50, head 8

In this example, primary checking begins at cylinder 4, head 6 and ends at cylinder 50, head 8. You can inspect up to 2500 tracks.

```
INSPECT UNIT(ccuu) NOVFY CHECK(2) NOSKIP -  
      FROMRANGE(4,6) TORANGE(50,8) PRESERVE
```

All heads, cylinders 50 through 100

In this example, primary surface checking is performed on all the heads from cylinder 50 through cylinder 100.

```
INSPECT UNIT(ccuu) NOVFY CHECK(2) NOSKIP CYLRANGE(50,100) PRESERVE
```

Head 4 only on all cylinders

In this example, primary surface checking is performed on cylinder 0, head 4, to the last alternate cylinder, head 4. Data is saved at the backup location on each track processed.

```
INSPECT UNIT(ccuu) NOVFY CHECK(2) NOSKIP HEADRANGE(4,4) PRESERVE
```

Heads 5 and 6 only, cylinders 500 through 599

In this example, primary surface checking is performed on heads 5 and 6 only, from cylinder 500 to cylinder 599.

```
INSPECT UNIT(ccuu) NOVFY CHECK(2) NOSKIP –  
CYLRANGE(500,599) HEADRANGE(5,6) PRESERVE
```

All heads from 14, all cylinders from 500

In this example, all cylinders, from cylinder 500 through the last alternate cylinder, are processed for heads 14 through the last head for this device type.

For a 3390-2, ICKDSF processes cylinders 500 through 2226, head 14 only.

The total combination of tracks cannot exceed 2500.

```
INSPECT UNIT(ccuu) NOVFY CHECK(2) NOSKIP –  
CYLRANGE(500,9999) HEADRANGE(14,9999) PRESERVE
```

Alternate cylinders of 3380 Models A04, AA4, and AD4

In this example, skip-displacement surface checking occurs on all tracks on the alternate cylinder of an IBM 3380 Model A04, AA4, and AD4.

```
INSPECT UNIT(ccuu) NOVFY CHECK(1) SKIP CYLRANGE(885,885)
```

Media maintenance

Once you suspect media as a cause of data checks, you can use ICKDSF to assign skips, assign alternate tracks, rewrite the data, or reclaim the track. For more information about performing media maintenance, see:

- *9340 Customer Guide for Using SIMS*, GC26-4858, for 9345 DASD information.
- *Maintaining IBM Storage Subsystem Media*, GC26-4495, for any other IBM DASD information.

Conditionally assigning alternate tracks

Use the INSPECT command to check the surface of a track and to assign an alternate track if the surface-checking process indicates that the track is defective. When PRESERVE is used, the data is moved from the current track to the assigned alternate track.

```
INSPECT UNITADDRESS(ccuu) NOVERIFY CHECK(n) –  
TRACKS(cccc,hhhh) PRESERVE
```

Usage Notes:

- **n** can be any number from 1 through 10. For recommended values of **n** for specific devices, see Appendix E, “Surface checking,” on page 471.

Examples of ICKDSF tasks—CKD devices

- PRESERVE saves the data on the current track by moving it to an alternate track. **NOPRESERVE erases the data on the track.** Use this parameter only if there is no meaningful data on the track, or if track errors prevent successful use of PRESERVE.

MVS

- When ICKDSF runs online to an MVS operating system, data security procedures are issued. For more information, see “Protecting data sets in an online mode” on page 32.

Unconditionally assigning alternate tracks

Use the INSPECT command to unconditionally assign an alternate track regardless of the condition of the primary track. When you issue PRESERVE, ICKDSF moves the data from the current track to the assigned alternate track.

```
INSPECT UNITADDRESS(ccuu) VERIFY(serial,owner) NOCHECK –  
      ASSIGN TRACKS(cccc,hhhh) PRESERVE
```

Usage Notes:

- If the track is an alternate, the primary track currently assigned to it is assigned a different alternate track.
- **NOPRESERVE erases the data on the track.** Use this parameter only if there is no meaningful data on the track or if track errors prevent successful use of PRESERVE.

MVS

- When ICKDSF runs online to an MVS operating system, data security procedures are issued. For more information, see “Protecting data sets in an online mode” on page 32.

Reclaiming a single flagged track

Use the INSPECT command to check the surface of a track and to reclaim the track if it is currently flagged defective.

```
INSPECT UNITADDRESS(ccuu) NOVERIFY CHECK(n) –  
      TRACKS(cccc,hhhh) RECLAIM PRESERVE
```

Usage Notes:

- Data from the alternate track is written onto the reclaimed track. Therefore, the data on the reclaimed track is first erased, and then replaced with the data from the alternate track.
- The maximum level of surface checking occurs for the track. If the track condition is good, and the track was assigned an alternate when processing began, reclamation takes place. If the track condition is defective, reclamation does not occur.
- If the above task is used for a track that is not flagged defective when processing begins, the results are the same as those described for “Conditionally assigning alternate tracks” on page 81.
- For recommended values of **n** for specific devices, see Appendix E, “Surface checking.”

Reclaiming alternate tracks with INSPECT

For 3375, 3380, 3390, and 9345 devices, use INSPECT to surface check and reclaim tracks. The 3995 Models 151 and 153 do not support surface checking. Existing data is read from the track and its surface is checked for high-repeatability, high-visibility error sites. The data is then rewritten to the track.

To rewrite data, enter the NOSKIP parameter on the INSPECT command by specifying:

```
INSPECT UNIT(ccuu) NOVERIFY NOSKIP TRACKS(cccc,hhhh)
```

The CHECK and PRESERVE parameters are defaulted in this example. The CHECK parameter ensures that rewrite checking is performed, and the PRESERVE parameter ensures that data is rewritten to the tracks. INSPECT provides a summary of all the currently assigned alternate tracks.

Finding where INSPECT failed

This example shows how the checkpoint processing works. It is not meant to show you how to use INSPECT to perform media maintenance procedures.

If you issued the following INSPECT command to perform surface checking on a 3380:

```
INSPECT UNIT(ccuu) NOVFY CHECK(2) SKIP -
        FROMRANGE(200,4) TORANGE(201,3) PRESERVE
```

and processing was interrupted on cylinder 201, head 1, you can use ANALYZE to locate the track that was being processed when the program stopped. For example, you can issue:

```
ANALYZE UNIT(ccuu) DRIVETEST
```

The DRIVETEST parameter is valid only for DASD with nonremovable storage media. For more information, see Chapter 11, “ANALYZE command—CKD,” on page 95.

Saving data during surface checking

The following examples show how you can recover after an INSPECT fails. They show how the checkpoint processing works, and are not meant to show you how to use INSPECT to perform media maintenance procedures.

Use PRESERVE to save a copy of the data on the track at a backup location and in storage. If processing does not complete, ICKDSF finds and restores the track it was processing when the INSPECT was interrupted, provided PRESERVE was initially able to read the track successfully.

Example 1: The following example ensures that data is saved during surface checking for all tracks on cylinder 200. Use PRESERVE to save a copy of the data on the track at a backup location and in storage.

```
INSPECT UNIT(ccuu) NOVFY CHECK(1) SKIP -
        CYLRANGE(200,200) PRESERVE
```

Example 2: The following example performs skip-displacement surface checking on part of a 3380 volume. Processing was interrupted on cylinder 201, head 1. Use PRESERVE to save a copy of the data on the track at a backup location and in storage.

```
INSPECT UNIT(ccuu) NOVFY CHECK(2) SKIP -
        FROMRANGE(200,4) TORANGE(201,3) PRESERVE
```

Example 3: If this INSPECT command was interrupted:

```
INSPECT UNIT(ccuu) NOVFY CHECK(2) SKIP -
        FROMRANGE(200,4) TORANGE(201,3) PRESERVE
```

You can surface check a different portion of the volume, by issuing:

```
INSPECT UNIT(ccuu) NOVFY CHECK(2) NOSKIP -
        CYLRANGE(498,500) HEADRANGE(2,6) KEEPIT
```

Usage Notes:

Examples of ICKDSF tasks—CKD devices

- Cylinder 201, head 1 is validated and the primary surface is checked.
- If primary surface checking for cylinder 201, head 1 fails, skip-displacement surface checking is issued.
- If there is data on cylinder 201, head 1 when processing is interrupted, it is rewritten on cylinder 201, head 1 from the backup location.
- Primary surface checking is then performed for all the tracks within the new range: heads 2 through 6 on cylinders 100 through 500.

Example 4: If this INSPECT command was interrupted:

```
INSPECT UNIT(ccuu) NOVFY CHECK(2) SKIP –  
FROMRANGE(200,4) TORANGE(201,3) PRESERVE
```

You can surface check the specified heads for part of the volume by issuing:

```
INSPECT UNIT(ccuu) NOVFY CHECK(2) NOSKIP –  
CYLRANGE(498,500) HEADRANGE(2,6) PRESERVE
```

Usage Notes:

- Cylinder 201, head 1 is validated and the primary surface checked.
- If primary surface checking for cylinder 201, head 1 fails, skip displacement surface checking is issued.
- If any data existed for cylinder 201, head 1 when processing was interrupted, the data is rewritten on cylinder 201, head 1.
- Primary surface checking is then done for all the tracks within the new range.

Example 5: If this INSPECT command was interrupted:

```
INSPECT UNIT(ccuu) NOVFY CHECK(2) SKIP –  
FROMRANGE(200,4) TORANGE(201,3) PRESERVE
```

You can use INSPECT to restore any data that exists on the backup location, and ensure the usability of the volume. Issue:

```
INSPECT UNIT(ccuu) NOVFY
```

Usage Notes:

- Cylinder 201, head 1 is validated and the primary surface checked.
- If primary surface checking for cylinder 201, head 1 fails, skip-displacement surface checking is issued.
- If there is data on cylinder 201, head 1 when processing is interrupted, it is rewritten on cylinder 201, head 1.

Emulating devices

ICKDSF operates on CKD devices that can be emulated on other CKD devices, and on CKD devices that can be emulated on FBA devices.

For CKD devices emulated on other CKD devices, the emulation is transparent. However, an emulated device works in the same manner as the device being emulated, not the native device.

Using a 3995 Model 151 or 153 device

The following ICKDSF functions are valid when you are emulating a 3390-2 on the 3995 Model 151 or 153:

```
AIXVOL (with no surface checking functions)  
ANALYZE (SCAN function only)
```

BUILDIX
 CONTROL
 CPVOLUME (with no surface checking functions)
 INIT (minimal initialization)
 REFORMAT

The following ICKDSF functions are not valid when you are emulating a 3390-2 on the 3995 Model 151 or 153:

The drive test function of the ANALYZE command
 The checkpoint CONTINUE function of the INIT command
 INSPECT
 INSTALL
 REVAL

Initializing an emulated CKD device on a 3370 FBA device

To emulate a CKD device on a 3370 FBA device:

1. Use ICKDSF to initialize the FBA disk for use. If you have not already done so, initialize the FBA disk with the FBAVTOC in the standard location (FBAVTOC(2,56,1024)) and write a volume label. For an example of initializing, see Figure 34 on page 470.
2. Run the format-emulated extent utility (INITEM). For a description, see *VSE/ESA System Utilities*, SC33-6517.
3. If it is not already active, activate the Direct Access Storage Compatibility Feature.
4. Use the ICKDSF INIT command to initialize the emulated CKD disk for use.

For fully-emulated CKD devices, use:

```
INIT UNITADDRESS(ccuu) NOVERIFY VALIDATE -
      VOLID(volser) MIMIC(EMUALL) DEVTYPE(type)
```

For partially-emulated CKD devices, use:

```
INIT UNITADDRESS(ccuu) NOVERIFY VALIDATE -
      VOLID(volser) MIMIC(EMU(n)) DEVTYPE(type)
```

Usage Notes:

- For type, substitute the device type to be emulated.
- For n, substitute the same number of cylinders that you gave as the size of the sub-disk during the INITEM program/operator dialog. ICKDSF does not check the validity of n.
- INIT writes a special data set control block (DSCB) on the partial CKD device to ensure that the nonexistent cylinders are never accessed.
- The drive test function of the ANALYZE command does not operate on CKD devices being emulated on FBA devices.

Initializing an emulated CKD Device on an IBM 9313, 9332, or 9335 FBA device

When you emulate a CKD device on the 9313, 9332, or 9335, you can use the same commands and parameters that you use when not emulating a CKD device. You do not need to:

- Use the MIMIC(EMU) or MIMIC(EMUALL) parameter.
- Perform any of the steps listed in “Initializing an emulated CKD device on a 3370 FBA device.”

Warning

To convert 9313, 9332, or 9335 devices to usable CKD devices, you must have loaded the correct microcode level. For more information, contact your IBM service representative.

If the emulated device has never been initialized after conversion to CKD emulation, the device is unusable. To avoid unpredictable results, run a medial INIT before running any other command.

The following ICKDSF functions are valid when you are emulating CKD devices on the 9313, 9332, or 9335:

ANALYZE SCAN
Minimal or medial initialization
INSPECT, with no surface checking functions

The following ICKDSF functions are not valid when you are emulating CKD devices on the 9313, 9332, or 9335:

The drive test function of the ANALYZE command
The checkpoint CONTINUE function of the INIT command
Range parameters during a medial initialization

Initializing an emulated device at a medial level

To perform a medial initialization on a CKD device emulated on an IBM 9313, 9332, or 9335, enter:

```
INIT UNITADDRESS(ccuu) NOVERIFY VALIDATE -  
VOLID(volser) VTOC(cylinder,track,extent)
```

Usage Notes:

- The VTOC is rewritten and access to data on the volume is lost.
- The volser you specify is checked against the volser of the volume.
- The checkpoint CONTINUE function of the INIT command is not supported.
- Maximal initialization is not supported.
- A medial initialization must process the whole volume. Range parameters are ignored.

Scanning data

To perform a data scan on a CKD device emulated on a 9313, 9332, or 9335 enter:

```
ANALYZE UNITADDRESS(ccuu) NODRIVETEST SCAN
```

Only the data verification test is supported. The drive test is not supported.

Assigning alternate tracks

To unconditionally assign alternate tracks on a CKD device emulated on a 9313, 9332, or 9335, enter:

```
INSPECT UNITADDRESS(ccuu) NOCHECK ASSIGN TRACKS(cccc,hhhh)
```

The surface checking functions of the INSPECT command are not valid when you are emulating CKD devices on the 9313, 9332, or 9335. Use the TRACKS parameter to specify the required tracks to be reassigned.

Media maintenance on an emulated device

When you perform media maintenance because of surface defects, use INSPECT or the FBA maximal INIT against the base address. INSPECT can assign an alternate track to the emulated device. This does, however, have a greater performance impact than assigning alternates to blocks found defective on the base FBA device address.

Performing miscellaneous tasks with ICKDSF

The following examples show how you can:

- Clear a storage path fence status
- Erase a volume
- Print a track assignment map

Clearing a storage path fence status

In the following example, ICKDSF clears a fence status. When this command is issued, it clears all paths to all devices on the subsystem.

```
CONTROL UNITADDRESS(0162) CLEARFENCE
```

When you issue the CLEARFENCE parameter of the CONTROL command, it is assumed the path or the device that has been fenced off by the subsystem has been repaired.

Erasing a volume

If the data is residual, you can reformat the volume.

Use the INIT command for MVS or VSE volumes

Use CPVOLUME FORMAT for MVS or VSE volumes

MVS

The following example shows you how to use INIT to erase data on an MVS volume. INIT restores the FFVDP on the volume. You can specify DATA or NODATA; either way, the volume is erased.

```
INIT UNITADDRESS(ccuu) NOVERIFY VALIDATE VOLID(serial) PURGE
```

You can also use REVAL to erase data from 3380 and 3390 volumes, see Chapter 21, “REVAL command—CKD,” on page 269.

You can also use the TRKFMT command to erase a track or tracks. See Chapter 22, “TRKFMT command—CKD,” on page 275.

Printing a track assignment map

Use the INSPECT command to format and print a report of alternate tracks assigned on the volume.

```
INSPECT UNITADDRESS(ccuu) NOVERIFY NOCHECK NOASSIGN -  
ALLTRACKS MAP
```

Data on the volume is not altered. For the IBM 9345, do not specify ALLTRACKS. Alternate track maps will not be printed for 9391 and 9394 because there are no alternate tracks.

Chapter 10. AIXVOL command—CKD



The AIXVOL command formats a volume for use in an AIX/ESA® environment. It writes 4096-byte records on all cylinders to be used by AIX. AIXVOL formats cylinder 0 with records that include the volume label. Use one of the parameters, FORMAT, LABEL, or EXAMINE, to complete your task.

- FORMAT** Writes records required by AIX on cylinder 0. Writes the required number of 4096-byte records on each track of an entire volume or on a range of cylinders.
- LABEL** Rewrites the volume serial number.
- EXAMINE** Reads an AIXVOL-formatted volume to verify that it is properly formatted and that records can be read without error.

Use the RANGE parameter to format or examine an entire volume, or limit the operation to part of a volume. If you omit RANGE, AIXVOL assumes that the range is for the entire volume. If you choose a range that does not begin with cylinder 0, then cylinder 0 must have been previously formatted.

All of the cylinders on a volume do not have to be formatted with 4096-byte records. Only those cylinders that are to be used by AIX need to be formatted. You must, however, always format cylinder 0 before formatting any other cylinders.

For information on ICKDSF support of the 9391 and 9394, see “ICKDSF support of the RAMAC Array family” on page 8.

Syntax

AIXVOL
Required Parameters FORMATLABELIEXAMINE UNITADDRESS(<i>ccuu</i>) VERIFY({ <i>serial</i> *NONE*}) NOVERIFY
Optional Parameters MIMIC(MINI(<i>nnnn</i>)) RANGE(<i>start,end</i>) READCHECK NOREADCHECK VOLID(<i>serial</i>)

Required parameters

FORMATLABELIEXAMINE parameter: specify function

Parameter/ Abbreviations	Description
FORMAT FMT	Required when you want to format a volume. You can format an entire volume or a range of cylinders.
LABEL	Rewrite the volume label of a previously formatted volume.
EXAMINE EXAM	Inspect an entire volume or range of cylinders on a previously formatted volume for errors.
Default:	None.
Restrictions:	FORMAT, LABEL, and EXAMINE are mutually exclusive.

UNITADDRESS parameter: identify the device

Parameter/ Abbreviations	Description
UNITADDRESS(<i>ccuu</i>) UNITADDR UNIT	Specifies the address of the volume to be processed. For <i>ccuu</i> , use the virtual address of the volume.
Default:	None.

VERIFY/NOVERIFY parameter: verify the volume serial number

Parameter/ Abbreviations	Description
VERIFY(<i>serial</i>) VFY	Required when you want to verify the volume serial number before performing the requested function on the volume. If the volume serial number does not match that found on the volume, the AIXVOL command ends. For <i>serial</i> , substitute 1 to 6 alphanumeric characters for the volume serial number. To verify that a volume serial number does not exist, substitute the string *NONE* for <i>serial</i> . If no volume serial exists, or if the volume serial is actually “*NONE*”, the AIXVOL operation continues. If a volume serial exists, the AIXVOL command ends.
NOVERIFY NOVFY NVFY	Required when you want to bypass verification of the volume serial number.
Default:	None. You must specify either VERIFY or NOVERIFY.
Restrictions:	None. When you use the VERIFY parameter and verification fails, the command stops running.

Optional parameters

MIMIC(MINI) parameter: specify a special volume usage



Parameter/ Abbreviations	Description
MIMIC(MINI(<i>nnnn</i>))	Specifies the number of cylinders to be processed. For <i>nnnn</i> specify the number of cylinders for the device.
Default:	If MIMIC(MINI) is not specified, the device is assumed to be dedicated.
Restrictions:	MIMIC(MINI) is valid only in the Stand-Alone version. It is unnecessary when Stand-Alone is running under VM.

RANGE parameter: specify the range of cylinders

Parameter/ Abbreviations	Description
RANGE(<i>start,end</i>)	Specifies the range of cylinders that are to be formatted or examined. Use <i>start,end</i> to specify a range of cylinders. Invalid range values are processed as follows: <ul style="list-style-type: none"> • If ending range > volume capacity, then the end range is set to the last cylinder on the volume and an informational message is issued. • If the starting range > volume capacity or ending range, then a message is issued and the command ends.
Default:	If RANGE is not specified, the default is the entire volume.
Restrictions:	RANGE is valid only when you specify either FORMAT or EXAMINE.

READCHECKINOREADCHECK parameter: specify read-back check

Parameter/ Abbreviations	Description
READCHECK READCHK RDCHECK READ	Performs a read-back check for each cylinder after it is formatted. If read-back check media errors are detected, and the device supports media maintenance is not a minidisk, the INSPECT function is issued to repair the track. INSPECT performs skip-displacement surface-checking to eliminate data checks from the track, and will assign an alternate track if required. After the track is inspected, it is formatted once more and the FORMAT operation continues.
NOREADCHECK NOREADCHK NOREAD NREAD	Specifies that a read-back check is not to be performed.
Default:	READCHECK
Restrictions:	READCHECK is valid only when you specify FORMAT. The 3995-191, 3995-193, 9391, 9394, and 2105 do not support media maintenance. Therefore, if you specify READCHECK against any one of these devices and media maintenance errors are detected, the INSPECT function will not be issued and the AIXVOL command will end.

VOLID parameter: specify the volume serial number

Parameter/ Abbreviations	Description
VOLID(<i>serial</i>)	Specifies which volume serial number to write in the volume label.
Default:	If you do not specify a VOLID, the existing volume serial number is used. If there is no current volume serial number, then you must specify VOLID.
Restrictions:	VOLID is valid only when you specify FORMAT or LABEL.

Formatting a cylinder with AIXVOL

The AIXVOL command formats a cylinder by writing as many 4096-byte records as possible on each track of a cylinder. Each record is sequentially numbered within a track. For example, a 3390 volume has 12 records per track; therefore, each track contains records 1-12.

Table 27 shows the number of records formatted on each of the CKD devices supported by the AIXVOL command:

Table 27. Number of CKD records formatted per track by AIXVOL command

Device	Records Per Track	Tracks Per Cylinder	Records Per Cylinder	High Cylinder ¹	Records Per Volume
3380-A, B, D, J	10	15	150	884	132 750
3380-E	10	15	150	1 769	265 500
3380-K	10	15	150	2 654	398 250
3390-1	12	15	180	1 112	200 340
3390-2	12	15	180	2 225	400 680
3390-3	12	15	180	3 338	601 020
3390-9	12	15	180	10 016	1 803 060
9345-1	10	15	150	1 439	216 000

AIXVOL command—CKD

Table 27. Number of CKD records formatted per track by AIXVOL command (continued)

Device	Records Per Track	Tracks Per Cylinder	Records Per Cylinder	High Cylinder ¹	Records Per Volume
9345-2	10	15	150	2 155	323 400

¹ High cylinder is the highest address. The number of cylinders is one more.

AIXVOL formats track 0 on cylinder 0 with the following records:

IPL record	AIXVOL creates an IPL record and writes zeros in this record.
Checkpoint record	AIXVOL writes zeros in this record.
Volume Label record	The owner field of the label record contains "AIXES".
Format 4 DSCB	Contains device constant information.
Format 5 DSCB	The VTOC records created by AIXVOL indicate that no space is available on the volume.

Errors reported by EXAMINE

Use EXAMINE to ensure an entire volume or a range of cylinders is properly formatted for the AIX system.

Two types of errors are reported by the EXAMINE function: format errors and data checks. A **format error** occurs when a track does not have the correct number of 4096-byte records or if the records do not have the correct record number (record ID). Format errors are reported by cylinder range; cylinders within the reported range are improperly formatted.

Data checks are not reported for cylinders if EXAMINE reports that they have format errors. For more information about data checks, see *Customer Guide for Using 9340 Direct Access Storage Subsystems Service Information Messages*, for 9345 devices or *Maintaining IBM Storage Subsystem Media*, for 3380 and 3390 devices.

For cylinders that are properly formatted, EXAMINE will report the CCHH of the first track that contains a data check.

EXAMINE is read-only and will not write over any user data. For any errors reported by EXAMINE, you should take appropriate corrective action. For format errors, use AIXVOL to format the cylinders. For data check errors, use the INSPECT command to check the track surface.

Minidisk support



In the Stand-Alone version, use MIMIC(MINI(n)) to indicate the number of cylinders of the minidisk you want to format. If you do not specify MIMIC(MINI(n)) for a minidisk, AIXVOL assumes that the device is dedicated.

For example, to format 5 minidisk cylinders, you enter the ICKDSF command:

```
AIXVOL UNIT(193) NVFY FORMAT MIMIC(MINI(5))
```



To format 5 minidisk cylinders with the CMS version, issue:

```
AIXVOL UNIT(193) NVFY FORMAT
```

Examples of the AIXVOL command

The following examples show different ways to code the AIXVOL command. The device used in the examples is a 3380 with 885 cylinders.

Formatting an entire volume

In this example all 885 cylinders on the volume are formatted. A read-back check is specified to verify that all of the formatted records can be read without error.

Because NOVERIFY is specified, any existing volume label is ignored, and the volume is labelled "AIXVL1".

```
AIXVOL FORMAT UNIT(0150) NOVERIFY VOLID(AIXVL1) READCHECK
```

Formatting part of a volume

In this example the first 100 cylinders on the volume are formatted. Cylinders 100 through 884 are available space.

Because NOVERIFY is specified, any existing volume label is ignored, and the volume is labelled "AIXVL1".

```
AIXVOL FORMAT UNIT(0150) NOVERIFY VOLID(AIXVL1) RANGE(0,99) NOREADCHECK
```

Inspecting a range of cylinders for errors

In this example, cylinders 100 through 150 are examined for errors.

Because NOVERIFY is specified, the volume serial number is not verified.

```
AIXVOL EXAM UNIT(129) NOVERIFY RANGE(100,150)
```

Rewriting the volume label

In this example, the volume label is changed from AIXTST to AIXFMT.

```
AIXVOL LABEL UNIT(129) VERIFY(AIXTST) VOLID(AIXFMT)
```

After this command is issued, the following message appears:

```
ICK003D REPLY U TO ALTER VOLUME 0129 CONTENTS, ELSE T
```

Reply U to message ICK003D, and ICKDSF will relabel the volume.

Chapter 11. ANALYZE command—CKD



The ANALYZE command examines the drive and the user's data on a volume to determine if errors exist. The output:

- Shows drive problems on nonremovable media
- Shows media problems
- Assists in locating and fixing problems

ANALYZE has two basic functions: drive test and data scan. For more general information on what ANALYZE does, see "Problem determination" on page 78.

For information about ICKDSF support of the RAMAC Array family, see "ICKDSF support of the RAMAC Array family" on page 8.

For information about ICKDSF support of the Internal Disk devices, see "ICKDSF support of the Internal Disk" on page 9.

Protecting the ANALYZE command with RACF

The MVS version of ICKDSF checks the general resource profile for a facility class profile of STGADMIN.ICK.ANALYZE. If RACF is not installed or the facility STGADMIN.ICK.ANALYZE is not created, the ANALYZE command executes with no authorization check. For additional information, see "Protecting ICKDSF commands with RACF" on page 35.

Syntax

ANALYZE	
Required Parameters	DDNAME(<i>dname</i>) SYSNAME(<i>sysxxx</i>) UNITADDRESS(<i>ccuu</i>) REALADDR(<i>ccuu</i>)
Optional Parameters	ALL CHPID(<i>nn,nn,...</i>) ALLCHPID DIRECTIO(PRIMARY SECONDARY) DRIVETEST NODRIVETEST FROMRANGE(<i>cylinder,head</i>) HEADRANGE(<i>start,end</i>) LIMITS(<i>start,end</i>) CYLRANGE(<i>start,end</i>) PRINTDS SCANINOSCAN SECWWNN(<i>swwnn</i>) SPEEDINOSPEED TORANGE(<i>cylinder,head</i>) USERID(<i>user's ID</i>)

Required parameters

DDNAME|SYSNAME|UNITADDRESS|REALADDR parameter: identify volume (or minidisk)

Parameter/Abbreviations	Description
DDNAME(<i>dname</i>) DDNAME	Required for an online MVS volume. The volume must be online. For <i>dname</i> , specify the MVS JCL statement that identifies the volume.

ANALYZE command—CKD

Parameter/ Abbreviations	Description
SYSNAME(<i>sysxxx</i>)	Required for a VSE volume when executing ICKDSF in batch mode; the volume must be online. For <i>sysxxx</i> , specify the SYSNAME in the ASSGN system control statement.
UNITADDRESS(<i>ccuu</i>) UNITADDR UNIT	<p>Required for an offline MVS volume, a Stand-Alone volume, and an attached CMS volume. For VSE, it is required when executing ICKDSF in command mode; the volume must be online.</p> <p>In MVS, the volume must be on a path that is online. If the volume is on a path that is offline, the program might enter a nonterminating wait state. For <i>ccuu</i>, specify the address (3 or 4 hexadecimal digits) of the channel and unit of the volume.</p> <p>For the CMS version, specify the virtual address of the minidisk or dedicated volume.</p> <p>The unit address is the device number.</p>
REALADDR(<i>ccuu</i>) RADDR	<p>Used to specify the real address of a volume. This parameter is valid only when you are running the CMS version of ICKDSF and you have DEVMAINT authority. For <i>ccuu</i>, specify the real address (3 or 4 hexadecimal digits) of the channel and unit of the volume.</p> <p>REALADDR is mutually exclusive with UNITADDRESS, DDNAME, SYSNAME, and USERID.</p>
Default:	None.
Restrictions:	None.

Optional parameters

ALL parameter: specify the area of data verification

Parameter/ Abbreviations	Description
ALL	Reads all cylinders of the specified device during the data verification tests.
Default:	ALL is the default if you do not specify LIMITS or CYLRANGE.
Restrictions:	ALL applies only when you specify the SCAN parameter. You cannot specify ALL with FROMRANGEITORANGE, CYLRANGEIHEADRANGE, or LIMITS.

CHPIDIALLCHPID parameter: specify path control

Parameter/ Abbreviations	Description
CHPID(<i>nn,nn,...</i>) CHP	<p>Specifies the path control to be used for the drive test of a 3380, 3390, or 9345 device. CHPID specifies that the drive test is to process the specified CHPIDs.</p> <p><i>nn</i> specifies the CHPID to be used. A maximum of eight CHPIDs can be specified. Valid values for CHPID are 00-FF and must match a valid CHPID in your configuration.</p>
ALLCHPID ALLCHP	Specifies that all CHPIDs are to be processed.
Default:	None.
Restrictions:	<p>CHPIDIALLCHPID is valid only in the MVS, Stand-Alone, or CMS environment.</p> <p>CHPIDIALLCHPID is valid only for 3380, 3390, and 9345 devices.</p> <p>CHPIDIALLCHPID is not valid for minidisks.</p>

DIRECTIO parameter: specify primary or secondary volumes

Parameter/ Abbreviations	Description
DIRECTIO(PRIMARY) DIO(PRI)	Direct the I/O for the drive test or the data verification test to the primary volume of a dual copy pair.

Parameter/ Abbreviations	Description
DIRECTIO(SECONDARY) DIO(SEC)	Direct the I/O for the drive test or the data verification test to the secondary volume of a dual copy pair.
Default:	If the DIRECTIO parameter is not specified when you are using a dual copy pair, the default is: <ul style="list-style-type: none"> • The primary volume if the dual copy pair is in duplex state. • The secondary volume if the dual copy pair is in suspended duplex state.
Restrictions:	Effective only when the dual copy pair is in duplex or suspended duplex state. Ignored if the volume is in simplex state or the subsystem does not support dual copy.

DRIVETESTINODRIVETEST parameter: specify the drivetest

Parameter/ Abbreviations	Description
DRIVETEST DRIVE	Runs the drive test. This parameter is valid only for the following IBM DASD that have nonremovable storage media: 3375, 3380, 3390, 9345, the RAMAC family of devices, the Internal Disk, and any supported DASD emulation where these devices are the native devices. The drive test function is not valid for the 3995-151, the 3995-153, and the 2105. If DRIVETEST is specified for a nonsupported device, a warning message is issued and processing continues.
NODRIVETEST NODRIVE	Bypasses the drive test.
Default:	DRIVETEST
Restrictions:	If path control is supported, NODRIVE NOSCAN prints the pathing reports that are applicable to the operating system environment, and the device or control unit type. If path control is not supported, NODRIVE NOSCAN performs no functions but will complete without error. For path control support information, see “Path control under ANALYZE drive test” on page 101. DRIVETEST must be the only ICKDSF command running on a device.  You cannot run multiple DRIVETESTs on a volume or minidisk. With the CMS version of ICKDSF, DRIVETEST is valid for dedicated devices. DRIVETEST is also valid for minidisks that are linked if the user has DEVMAINT authority.

FROMRANGE parameter: specify a specific starting location

Parameter/ Abbreviations	Description
FROMRANGE(<i>cylinder,head</i>) FROMR FROM	Use this parameter to specify the starting track (cylinder and head) to be scanned. For <i>cylinder,head</i> substitute decimal (n) or hexadecimal digits (for example, X'2AB',X'E') to identify the cylinder and head at which processing is to start. If you specify only one value, that value defaults to the cylinder and the head value is defaulted to 0. If you specify FROMRANGE and do not specify TORANGE, TORANGE is defaulted to the last cylinder of a volume or minidisk. For information on specifying the ending track (TORANGE) to go with the starting track, see “TORANGE parameter: specify a specific ending location” on page 100. For information on specifying part of a volume to be examined, see “RANGE Parameters: specifying part of a volume” on page 103.
Default:	None.
Restrictions:	FROMRANGE cannot be specified with CYLRANGEIHEADRANGE. FROMRANGE applies only when SCAN is specified.

HEADRANGE parameter: specify a range of heads

Parameter/ Abbreviations	Description
HEADRANGE(<i>start,end</i>) HDRANGE HEADR HDR HD	<p>Use the HEADRANGE parameter to specify the starting and ending heads to be scanned.</p> <p>For <i>start,end</i> substitute decimal (n) or hexadecimal digits (for example, X'1',X'E') to identify the starting and ending heads to be examined. If you specify only one value, ICKDSF takes the value to be the starting range and defaults the ending range to the device maximum.</p> <p>If you specify HEADRANGE and do not specify CYLRANGE, the specified heads for all the cylinders on a volume or minidisk are processed.</p> <p>For information on specifying the starting and ending cylinders (CYLRANGE) to go with the starting and ending heads, see "LIMITSICYLRANGE parameter: specify the area of data verification."</p> <p>For information on specifying part of a volume, see "RANGE Parameters: specifying part of a volume" on page 103.</p>
Default:	None.
Restrictions:	<p>The starting value is required for HEADRANGE. If you specify an ending value greater than the maximum for the device, the device maximum is used for the ending value.</p> <p>HEADRANGE applies only when you specify SCAN.</p> <p>HEADRANGE cannot be specified with FROMRANGEITORANGE.</p> <p>Because SPEED operates on one cylinder at a time, it is not valid with HEADRANGE, and is ignored if you specify both parameters.</p>

LIMITSICYLRANGE parameter: specify the area of data verification

Parameter/ Abbreviations	Description
LIMITS(<i>start,end</i>) LIMIT LIMS LIM	<p>Specifies the area of the disk where data verification is to be performed. Specifies the range of cylinders to be read during the data verification tests.</p> <p><i>start and end</i> specifies the relative cylinder number for the start and end of the data verification tests. These values can be expressed in decimal (n) or hexadecimal (for example, X'2AB',X'3DE') form.</p> <p>The numbers <i>start</i> and <i>end</i> must be equal, or in ascending order.</p>
CYLRANGE(<i>start,end</i>) CYLR CYL	<p>For <i>start,end</i>, substitute decimal (n) or hexadecimal digits (for example, X'2AB',X'3DE') to identify the starting and ending cylinders to be examined.</p> <p>If you specify CYLRANGE and do not specify HEADRANGE, all the heads of the specified cylinders are processed.</p> <p>For information on specifying the starting and ending heads (HEADRANGE) to go with the starting and ending cylinders, see "HEADRANGE parameter: specify a range of heads."</p> <p>For information about specifying part of a volume, see "RANGE Parameters: specifying part of a volume" on page 103.</p>
Default:	<p>If you do not specify LIMITS or CYLRANGE, ALL is the default if SCAN is specified.</p> <p> With the CMS version, if you do not specify a range for a minidisk, the default is the entire specified minidisk.</p>
Restrictions:	<p>The LIMITSICYLRANGE parameters apply only when the SCAN parameter has been specified.</p> <p>The starting value is required for LIMITSICYLRANGE. If you do not specify an ending value, the last primary cylinder is used as the ending value.</p> <p>LIMITS or CYLRANGE cannot be specified with FROMRANGEITORANGE.</p>

PRINTDS parameter: print data set name

Parameter/ Abbreviations	Description
PRINTDS PRINT PRTDS	If an uncorrectable data check is found, and the track in error resides within a data set the data set name will be printed out.
Default:	None.
Restrictions:	Valid only when SCAN is specified.

SCANINOSCAN parameter: run data verification tests

Parameter/ Abbreviations	Description
SCAN SCN	Indicates that you want the data verification test to be run. Data verification is run if you specify SCAN and any of the following is true: The drive test completed successfully. The drive test is not supported for the input device type. The drive test has been bypassed. For 9345 and 9394 devices, SCAN reports those media service information messages (SIMs) that have not been closed. Scan will detect 0F0B errors ¹ for all ICKDSF supported device types. It will report all 0F0B tracks and print the data set name (MVS version only) if the track was allocated to a data set.
NOSCAN NOSCN NSCAN NSCN	Indicates that you do not want the data verification test to be run.
Default:	NOSCAN
Restrictions:	None.
¹ The 0F0B condition arises on a track when the home address appears to be defective, but record zero does not point to an alternate track.	

SECWWNN parameter: specifies the WWNN of a volume

Parameter/ Abbreviations	Description
SECWWNN(<i>swwnn</i>) SWWWNN	Specifies the World Wide Node Name (WWNN) of the volume for which you want fibre channel connection information. The WWNN you specify identifies a volume that you may wish to use as a secondary PPRC volume connected through fibre channel protocol (FCP) paths to the volume to which the I/O is addressed. When PPRC FCP support exists, the ANALYZE pathing reports includes the fibre channel connection Information Table. This information indicates the potential connectivity of the fibre channel ports in the ESS where the I/O is issued, to each system adapter port in the ESS specified by the secondary WWNN. Each WWNN is an 8-byte hexadecimal value <code>xxxxxxxxxxxxxxxx</code> . <i>swwnn</i> represents the secondary WWNN.
Default:	None.
Restrictions:	Although the SECWWNN value is a hex value the leading 'X' and the trailing apostrophe are not allowed in the specification of the value.

SPEEDINOSPEED parameter: specify data verification tests

Parameter/ Abbreviations	Description
SPEED	I/O reads one cylinder for the data verification tests.

ANALYZE command—CKD

Parameter/ Abbreviations	Description
NOSPEED NSPEED	I/O reads one track for the data verification tests.
Default:	NOSPEED
Restrictions:	<p>Because SPEED operates one cylinder at a time, it improves the performance of the scanning process, but it can severely degrade the performance of other users accessing the channel. This impact should be considered. SPEED is valid only when SCAN is specified.</p> <p>For the 9345, SPEEDINOSPEED are ignored if specified. When the data verification test is run for the 9345, one I/O is issued for each cylinder to be processed within the range you specify. For example, if you specify FROM(3,5) TO(13,4), 11 I/Os are issued (one I/O per cylinder, and 150 tracks are read). Similarly, if you specify CYLRANGE(20,21) HEADRANGE(1,2), two I/Os are issued.</p> <p> SPEED is not recommended for VM operating systems or guest minidisks that are part of a volume where other users are active.</p>

TORANGE parameter: specify a specific ending location

Parameter/ Abbreviations	Description
TORANGE(<i>cylinder,head</i>) TOR TO	<p>Use this parameter to specify the ending track (<i>cylinder</i> and <i>head</i>) to be scanned.</p> <p>For <i>cylinder,head</i>, substitute the decimal (n) or hexadecimal digits (for example, X'2AC',X'E') to identify the cylinder and head where processing is to end. If you specify only one value, that value defaults to the cylinder and defaults the head to the device maximum.</p> <p>If you specify TORANGE and do not specify FROMRANGE, FROMRANGE is defaulted to cylinder 0, head 0 of the specified minidisk.</p> <p>For information on specifying the starting track of part of a volume (FROMRANGE) see "FROMRANGE parameter: specify a specific starting location" on page 97.</p> <p>For information on specifying part of a volume, see "RANGE Parameters: specifying part of a volume" on page 103.</p>
Default:	None.
Restrictions:	None.

USERID parameter: specify another user's minidisk



Parameter/ Abbreviations	Description
USERID(<i>user's ID</i>) UID	<p>Performs the ANALYZE data verification test on another user's minidisk.</p> <p>For <i>user's ID</i>, substitute the 1 to 8 characters of the ID of the user whose minidisk you want to verify.</p>
Default:	If USERID is not specified, your own minidisk is verified.
Restrictions:	<p>USERID can be specified only if you are using the CMS version of ICKDSF and have DEVMAINT authority. USERID is ignored in all other system environments.</p> <p>USERID and REALADDR are mutually exclusive.</p> <p>You must use UNITADDRESS with USERID. UNITADDRESS specifies the virtual address of the minidisk.</p>

Detecting hardware problems with DRIVETEST

The drive test ensures that the device hardware can perform basic operations, such as seeks, reads, and writes. It is used with the following IBM DASD that have nonremovable storage media: the 3375, 3380, 3390, 9345, 9391, and 9394. The drive test function is not valid for the 3995-151, 3995-153, or 2105.



The drive test is supported if you are running ICKDSF under VM for dedicated devices. Minidisks and LINKed devices are also supported if the user has DEVMAINT authority.

The drive test runs with all system error recovery procedures disabled.

Testing the drive and logical volume with ANALYZE

ANALYZE determines that the drive is fully operational. ANALYZE tests the drive's functional capabilities by performing I/O operations on the CE track. Each I/O operation, called a channel command word (CCW) chain, tests a specific function of the drive and logical volume. Tests are executed in order of increasing complexity.

ANALYZE tests the following drive functions:

- Access arm positioning
- Ability to read and write on the CE cylinder
- Address mark detection
- Switching read/write heads in response to a multitrack command
- Sensing disk's rotational position
- Detecting and skipping over defective areas on a track

If PRESERVE or CONTINUE data exists on the CE cylinder, ANALYZE does not destroy this data. (PRESERVE or CONTINUE data is written on the CE cylinder by an INSPECT, INSTALL, REVAL, or INIT command.) ANALYZE bypasses writing over the data, and reports the presence of the data. Because this feature is part of the drive test, it is supported only where the drive test is supported.

The drive test is optional. It is controlled by the DRIVETESTINODRIVETEST parameters.

WRITE commands are issued to the CE cylinder only. Wherever the CE cylinder is referred to, this can be either the CE, device support, or diagnostic cylinder depending on the device.

The drive test does not support the IBM 2305 or the 2105.

Path control under ANALYZE drive test

Warning

If you specify path control when other programs are running on devices that share the same path, contention problems may arise.

The channel path sends signals and data between a processor and storage control to perform I/O requests. The device path is a connection between a storage control and a device. To use path control, specify the channel path or CHPID. When you are running the ANALYZE drive test, you can direct ICKDSF to process the drive test down every channel path; or you can limit processing to specific channel paths. All device paths on the selected channel path are processed.

ANALYZE command—CKD

Path control is provided to assist you in determining if errors are caused by the media or hardware. Use path control for all I/O to a device and to identify the path used when errors occur. If only one path to a device has errors and other paths do not, the media or the drive is probably not at fault. If all paths to a device have errors, the media or the drive is suspect.

Path control is valid only for IBM 3380, 3390, and 9345 devices. It is not performed:

- If path control parameters are not specified
- When you are processing minidisks
- Under the VSE version of ICKDSF

Path control is not supported on Internal Disk devices. Path parameters are ignored if specified.

When path control is specified, ICKDSF prints pathing tables with path information and status. The type and number of tables is dependent on the device type being processed and the operating system environment. See “Pathing reports” on page 109 for examples and information about the pathing tables. Print the pathing reports without executing the drive test by specifying NODRIVE NOSCAN.

The number of unique paths is limited by the number of channel paths accessible to ICKDSF.

ANALYZE path control processing is valid for the drive test only. Any errors that occur before or after this test cannot distinguish path control errors from other errors, and the “I/O Error” message is issued without regard to path.

Verifying data records with ANALYZE

The data verification test reads (without data transfer across the channel to the processor) all data records on the volume or minidisk if you are running ICKDSF under CMS.

The data verification test scans the current data on the volume for data checks. For 9345 and 9394 devices, the data verification test will report any media service information messages (SIMs) that are not closed. For more information on the 9345, see *9340 Customer Guide for Using SIMS*, GC26-4858. For more information about the 9394, see *Using the IBM RAMAC Array Subsystem*, GC26-7005.

Data verification ensures all the data is readable, but does not ensure that the volume is in standard IBM format.

ANALYZE data verification completes successfully, even if one or more of the following is true:

- No data exists on the volume.
- Data on the volume is written as nonstandard record 0's.
- There are no record 0's on the volume.

Before running the ANALYZE data verification test (or any ICKDSF job), the devices must establish thermal stability. See “Devices supported by ICKDSF” on page 6.

Options for the data verification tests include:

- Specifying data verification of the whole volume (minidisk).
- Selecting a range of data to be verified:
 - By cylinders (LIMITS or CYLRANGE)

- Cylinder,head to cylinder,head (FROMRANGE,TORANGE)
- All heads within a range of cylinders, for example, cylinder to cylinder (CYLRANGE or LIMITS)
- All cylinders for certain heads, for example, head 3 for all cylinders (HEADRANGE).
- A range of heads within a range of cylinders, for example, heads 2 through 4 on cylinders 10 through 20 (CYLRANGE and HEADRANGE). Similarly, if you are running the CMS version of ICKDSF, you can select a range to be verified within a minidisk.
- Performing one I/O per cylinder for CKD devices on the data verification tests (SPEED).
- Performing one I/O per track for CKD devices on the data verification tests (NOSPEED).

For the 9345 and 9394, SPEED and NOSPEED are ignored. For more information, see “SPEEDINOSPEED parameter: specify data verification tests” on page 99.

Data verification output

ANALYZE will report (in HEX format X'cccc' X'hhhh'):

- For 3380 and 3390 devices, only repeatable and duplicate ECC-correctable data checks
- For other IBM devices, the cylinder and head location of all error correcting code (ECC) correctable data checks
- The cylinder and head location of ECC-uncorrectable data checks
- The CCW, CSW, and sense bytes of the failing I/O

The data verification portion of ANALYZE runs without system error recovery procedures (regardless of the environment you are running in), and with storage control retry inhibited where possible. No data check error records are written to the ERDS.

If the surface defect can be corrected by storage control retry (that is, an error in a count field or a key field), ANALYZE will report the error as uncorrectable.

Subsequent I/O against the data in a standard operating system environment might detect the error as correctable, or might not detect the error at all.

Unexpected I/O errors

If the data verification test encounters an unexpected I/O error:

Error	ANALYZE
Equipment check	Issues a message and stops processing.
Invalid track format	Issues a message and continues.
Environmental data	Ignores the error and continues.

RANGE Parameters: specifying part of a volume

LIMITS, CYLRANGEIHEADRANGE, and FROMRANGEITORANGE are optional parameters, used to limit the areas of a volume or minidisk that are to be scanned.

CYLRANGEIHEADRANGE—Specifies the starting and ending cylinders and starting and ending heads to be scanned.

ANALYZE command—CKD

FROMRANGEITORANGE—Specifies the starting track (cylinder and head) and the ending track (cylinder and head) to be scanned.

The following table shows the parameter conditions when specifying part of the volume.

Table 28. Parameter conditions

Parameter	Interchangeable?	Other Notes
LIMITS	With CYLRANGE	If you do not specify LIMITS or CYLRANGE, the default is ALL if SCAN is specified. If you are running under CMS and do not specify a range, the default is all of the specified minidisk.
CYLRANGE	With LIMITS	If you specify CYLRANGE and do not specify HEADRANGE, all the heads of the specified cylinders are processed. Both the starting and ending values are required for CYLRANGE. If you specify an ending value greater than the maximum for the device, the device (minidisk) maximum is used for the ending value.
HEADRANGE	No	If you specify HEADRANGE and do not specify CYLRANGE, the specified heads for all the cylinders on the volume (minidisk) are processed. Both the starting and ending values are required for HEADRANGE. If you specify an ending value greater than the maximum for the device, the device (minidisk) maximum is used for the ending value.
FROMRANGE	No	If you specify FROMRANGE and do not specify TORANGE, TORANGE is defaulted to the last cylinder of the device (minidisk).
TORANGE	No	If you specify TORANGE and do not specify FROMRANGE, FROMRANGE is defaulted to cylinder 0, track 0 (starting cylinder and track of the minidisk)

Note: CYLRANGEIHEADRANGE and FROMRANGEITORANGE are mutually exclusive pairs. All parameters are valid only if SCAN is specified.

CMS version minidisk support



When you are using the CMS version of ICKDSF, you can use the ANALYZE command to perform the data verification test for a minidisk.

The following parameters are valid for minidisks:

ALL, CYLRANGE, NODRIVETEST, FROMRANGE, HEADRANGE, LIMITS, SCANINOSCAN, SPEEDINOSPEED, TORANGE, and UNITADDRESS

Note: DRIVETEST is valid only when operating under VM with DEVMAINT authority.

The following parameters are valid only when you are using the CMS version of ICKDSF and have DEVMAINT authority (as defined in the CP directory):

USERID	With DEVMAINT authority, you can use the USERID parameter to perform the data verification test on another user's minidisk. All of the parameters listed above are valid in this mode.
REALADDR	With DEVMAINT authority, you can use the REALADDRESS parameter to specify the real device address to perform the data verification test on a volume. UNITADDRESS is not valid in this mode. All of the other parameters listed above are valid.
DRIVETEST	With DEVMAINT authority, you can use the DRIVETEST parameter to ensure that the minidisk hardware can perform basic operations, such as seeks, reads, and writes.

For more information, see Chapter 5, "Getting started with the CMS version."

Dual copy volumes

When you process dual copy volumes using the ANALYZE command, specify the DIRECTIO parameter to select the primary or secondary volume. Otherwise, the default is selected depending on the mode of the device.

The ANALYZE command supports dual copy volumes that are in duplex or suspended duplex state.

Examples of the ANALYZE command

The following examples show different ways to use the ANALYZE command.

Any values specified here are examples only and should not necessarily be interpreted as the values for your system. Add your JCL or job control statement (JCS) to complete these examples.

Analyzing volumes with the Stand-Alone version



The following examples show how you can analyze a volume using the Stand-Alone version of ICKDSF.

Performing a drive test

In this example, only the DASD drive tests are performed.

```
ANALYZE UNITADDRESS(0141)
```

Using keyword abbreviations, you could have specified:

```
ANALYZE UNIT(0141)
```

Performing a drive test and data verification test

In this example, the DASD drive tests are performed and are followed by the data verification tests for the entire volume. ALL is the default.

```
ANALYZE UNITADDRESS(0141) SCAN
```

Bypassing the drive test and verifying part of a volume

In this example, the DASD drive tests are bypassed. A partial data verification test, starting at relative cylinder 6 and ending at relative cylinder 9, is performed.

ANALYZE command—CKD

```
ANALYZE UNITADDRESS(0351) LIMITS(6,9) SCAN NODRIVETEST
```

Analyzing a partial volume

In this Stand-Alone version example, the data verification test is performed for all heads starting at cylinder 500 head 14, to the end of the volume.

```
ANALYZE UNITADDRESS(0351) SCAN -  
FROMRANGE(500,14) TORANGE(9999,9999)
```

Analyzing volumes with the CMS version

CMS

The following examples show how you can analyze a volume using the CMS version of ICKDSF.

Analyzing another user's minidisk

In this CMS version example, the data verification test is performed for another user's minidisk. You specify the USERID parameter to ANALYZE the minidisk which is owned by user SMITH at the user's virtual address 0351. You must have DEVMAINT authority to specify the USERID parameter.

```
ANALYZE UNIT(0351) SCAN USERID(SMITH) NODRIVETEST
```

Analyzing a volume with a real address

In this CMS version example, the data verification test is performed for a volume at real address 290 by using the REALADDR parameter. You must have DEVMAINT authority to specify the REALADDR parameter.

```
ANALYZE REALADDR(290) SCAN NODRIVETEST
```

Analyzing volumes with the MVS version

MVS

The following examples show how you can analyze a volume using the MVS version of ICKDSF.

Analyzing the primary volume of a dual copy pair

In this example, the ANALYZE drive test is run on the primary volume of a dual copy pair with a primary address of 141. Note that the device must be in duplex or suspended duplex state.

```
ANALYZE UNITADDRESS(0141) DRIVETEST NOSCAN DIRECTIO(PRIMARY)
```

Analyzing the secondary volume of a dual copy pair

In this example, the ANALYZE drive test is run against the secondary volume of a dual copy pair with a primary address of 141.

```
ANALYZE UNIT(0141) DRIVE DIO(SEC)
```

In the MVS version, the data definition (DD) card should point to the primary volume of a dual copy pair. Note that the device must be in duplex or suspended duplex state.

Analyzing a volume with the VSE version

VSE

In this example, drive tests are performed on volume SYS001. Specification of the NOSCAN parameter indicates that data verification tests are not to be performed.

```
// JOB    jobname
// ASSGN  SYS001,150
// EXEC  ICKDSF,SIZE=AUTO
//       ANALYZE SYSNAME(SYS001) NOSCAN
/*
/ &
```

Examples of path control under the ANALYZE drive test

Table 29 and Table 30 shows examples of ANALYZE drive test run with a variety of path controls.

Table 29. Path controls when running ANALYZE drive test

ANALYZE drive test runs...	Command Entered
System will select the first available CHPID	ANALYZE UNIT(0141) DRIVE NOSCAN

Table 30 shows examples of ANALYZE drive test run with a variety of path controls.

Table 30. Path controls when running ANALYZE drive test

ANALYZE drive test runs on all device paths accessible through...	Command Entered
All CHPIDs in an MVS, CMS, or Stand-Alone environment.	ANALYZE UNIT(0141) DRIVE NOSCAN ALLCHPID
CHPID 0E in an MVS, CMS, or Stand-Alone environment.	ANALYZE UNIT(0141) DRIVE NOSCAN CHPID(0E)

Diagnostic messages

ANALYZE prints diagnostic messages to the output device. You or your customer engineer can use them as an aid in determining if and what type of problem might exist on the volume.

The informational and diagnostic messages are listed and described in Appendix A, “Device Support Facilities messages (ICK),” on page 345.

In addition, ANALYZE produces a movable head and fixed-head error table that summarizes errors associated with the read/write circuitry and data verification. Figure 26 on page 108 and Figure 27 on page 109 are examples of these respective tables.

Note: The fixed-head error table may print even if the drive under test does not include the fixed-head feature. In that case, map the fixed-head numbers to the physical movable cylinder and head.

Drive test error summary

When you run the drive test for the IBM 3380 and 3390, a drive test error summary prints if any errors are detected during the read or write test on the CE cylinder.

The CE cylinder is device dependent, and can be the CE, device support, or diagnostic cylinder. (For the IBM 9345, the subsystem manages these functions.)

Figure 25 on page 108 is an example of the drive test error summary.

ANALYZE command—CKD

DRIVE TEST HEAD	ERROR WRTCE	SUMMARY RDCE
--0000--	-----	-----
--0001--	-----	-----
--0002--	-----	-----
--0003--	-----	-----
--0004--	-----	-----
--0005--	-----	-----
--0006--	-----	-----
--0007--	---X---	-----
--0008--	-----	-----
--0009--	-----	-----
--000A--	-----	-----
--000B--	-----	-----
--000C--	-----	-----
--000D--	-----	-----
--000E--	-----	-----

Figure 25. Drive test error summary for the IBM 3380 and 3390

X indicates that at least one error has occurred on the indicated head during the write tests (WRTCE column) or the read tests (RDCE column) to the CE cylinder (part of the drive test).

Movable head error table

Figure 26 is an example of the movable head error table.

Figure 26. Movable head error table—CKD

HEAD NUMBER	MOVABLE HEAD ERROR TABLE					ERROR CODE
	DATA CHK	SEEK VERIFY CHECK	WRITE CHK	DATA CHK CE CYL	DATA COMP ERROR	
00	---TUC---	-----	-----	-----	-----	-----
01	-----	-----	-----	-----	-----	-----
02	-----	-----	-----	-----	-----	-----
03	---U---	-----	-----	-----	-----	--B--
04	-----	-----	-----	-----	-----	--B--
05	---T-C---	-----	-----	-----	-----	-----
06	-----	-----	-----	-----	-----	--B--
07	---C---	-----	-----	-----	-----	-----
08	---UR---	-----	-----	-----	-----	-----
09	---TU---	-----	-----	-----	-----	-----
11	-----	-----	-----	-----	-----	-----
12	-----	-----	-----	-----	-----	-----
13	---T---	-----	-----	-----	-----	-----
14	-----	-----	-----	-----	-----	-----
15	-----	-----	-----	-----	-----	-----
16	-----	-----	-----	-----	-----	-----
17	-----	-----	-----	-----	-----	-----
18	-----	-----	-----	-----	-----	-----
19	-----	-----	-----	-----	-----	-----
20	-----	-----	-----	-----	-----	-----
21	-----	-----	-----	-----	-----	-----
22	-----	-----	-----	-----	-----	-----
23	-----	-----	-----	-----	-----	-----
24	-----	-----	-----	-----	-----	-----
25	-----	-----	-----	-----	-----	-----
26	-----	-----	-----	-----	-----	-----
27	-----	-----	-----	-----	-----	-----
28	---C---	---X---	---X---	---X---	---X---	-----
29	---U---	---X---	---X---	---X---	---X---	-----

In the data check column:

Symbol	Indicates...
T	Which heads exceeded the data check threshold error rate.
U	At least one ECC-uncorrectable or unrecoverable error occurred on this head.
C	At least one ECC-correctable error occurred on this head.
X	At least one error, as indicated by the column heading, has occurred on this head.
R	At least one recoverable error occurred on this head.
B	Indicates 0F0B error. A defective track was found without a valid alternate track pointer.

For the actual number of errors that occurred for a specific head, examine previous messages provided in the ANALYZE output.

Fixed-head error table

Figure 27 is an example of the fixed-head error table.

Figure 27. Fixed-head error table

FIXED-HEAD ERROR TABLE							
HEAD NUMBER	DATA CHECK	SEEK VERIFY		HEAD NUMBER	DATA CHECK	SEEK VERIFY	
		CHECK	CHECK			CHECK	CHECK
00	-----U-----	-----X-----		30	-----U-----	-----X-----	
01	-----C-----	-----X-----		31	-----C-----	-----X-----	
02	-----	-----		32	-----	-----	
03	-----	-----		33	-----	-----	
04	-----	-----		34	-----	-----	
05	-----	-----		35	-----	-----	
.				.			
.				.			
.				.			
28	-----	-----		58	-----	-----	
29	-----	-----		59	-----	-----	

In the data check column:

Symbol	Indicates...
U	An ECC-uncorrectable error occurred on this head.
C	An ECC-correctable error occurred on this head.
X	At least one error, as indicated by the column heading, has occurred on this head.

Note: The fixed-head error table may be printed, although the drive under test does not include the fixed-head feature. The table then applies to movable heads 00 through 29.

Pathing reports

When path control is specified, ICKDSF prints pathing tables with path information and status. The type and number of tables is dependent on the device type being processed and the operating system environment.

Path status table

The path status table prints when you run the drive test for the IBM 3380, 3390, 9345, or 9391, with path control parameters. It also prints if you specify NODRIVE

ANALYZE command—CKD

NOSCAN for the IBM 3380, 3390, 9345, 9391, or 2105. The path status table is not printed in the VSE environment. Table 31 is an example of a path status table for the 3380 and 3390.

Table 31. Path status table for the IBM 3380 and 3390

	Path Status							
CHPID	09	0D	0E	0F	–	–	–	–
AVAILABLE	YES	YES	YES	YES	–	–	–	–
ONLINE	YES	NO	YES	YES	–	–	–	–
STORAGE DIRECTOR	BC	BC	BD	BD	–	–	–	–
SUBSYSTEM ID	0060	0060	0060	0060	–	–	–	–
DLSE	YES	YES	YES	YES	–	–	–	–
CLUSTER	1	0	1	0	–	–	–	–
STORAGE PATH 0	A	AD	ADFC	A	–	–	–	–
STORAGE PATH 1	A	A F	A	A	–	–	–	–

Legend:

- Not applicable
- A** Attached storage path
- D** Disabled storage path
- F** Device fenced from storage path
- C** Channel fenced from storage path

Table 32 is an example of a path status table for the 9345.

Table 32. Path status table for the IBM 9345

	Path Status							
CHPID	–	–	3D	3E	–	–	–	–
AVAILABLE	–	–	YES	NO	–	–	–	–
ONLINE	–	–	YES	–	–	–	–	–
SUBSYSTEM ID	–	–	00AA	–	–	–	–	–

In Table 31 and Table 32, paths are displayed in the sequence the system returns path information. Depending on your system environment and storage control, certain lines in the table do not print. For example:

Item	Prints only if you are using...
CHPID	MVS, CMS or Stand-Alone
ONLINE	MVS
STORAGE DIRECTOR	IBM 3880 storage control
SUBSYSTEM ID	IBM 3990 storage control or 9340 subsystem, or 2105
DLSE	IBM 3990 storage control or 2105
CLUSTER	IBM 3990 storage control or 2105
STORAGE PATH 0	IBM 3990 storage control or 2105
STORAGE PATH 1	IBM 3990 storage control or 2105

In addition, DLSE, CLUSTER, STORAGE PATH 0, and STORAGE PATH 1 do not print if you are using an IBM 9345.

When you are using dual copy volumes:

- The path status table reflects only the path status for the volume being processed (primary or secondary). The table header indicates whether the primary or secondary volume is being processed.
- When you are processing a secondary volume, the line indicating online status is not printed.

Logical path status table

When you specify the NODRIVE NOSCAN parameters, ICKDSF will print the Logical Path Status Table if it is supported for the subsystem you are processing.

Table 33 is an example of a logical path status table.

Table 33. Logical path status table

LOGICAL PATH		SYSTEM ADAPTER ID	HOST LINK ADDRESS	SP FENCES 0 1 2 3	PATH GROUP ID			
NUMBER	TYPE				ID	SERIAL	CPU TYPE	CPU TIME STAMP
35	E	05	C500		xxxx	xxxxxx	2064	B7B1B137

ANALYZE command—CKD

Legend:

LOGICAL PATH

Storage Control Unit identification of its logical path resource.

NUMBER

A decimal number, specifying the sequence number of the logical path.

TYPE

One of the following values:

- N/A = Logical Path not available
- N/E = Logical Path not established
- E = Logical Path is on an ESCON channel path
- C = Logical Path is on an OEMI channel path
- P = Logical Path is a parallel path
- R = Logical Path is Peer to Peer Control Unit Path
- E/L = ESCON-Established to another logical subsystem
- E/A = ESCON-Peer-to-Peer Remote Copy-Control Unit mode
- E/B = ESCON-Peer-to-Peer Remote Copy-Channel mode
- F/N = FICON™-Not established
- F/E = FICON-Established
- F/L = FICON-Established to another local subsystem

SYSTEM ADAPTER ID

When the Logical Path type is E, C, P, R, E/L, F, or F/L, this field contains a single value identifying the physical system adapter on which the path was established. When the type is N/E or F/N, the field contains two values identifying the lowest and highest numbered system adapter on which the logical path might be established.

HOST LINK ADDRESS

When Logical Path type is E or E/L, the high order two characters contain a value in the range 00 through FF, identifying the ESCON link ID to which the using processor is attached. The low order two characters contain a value identifying the logical partition ID if the processor is operating in PR/SM™ mode.

When Logical Path type is F/E or F/L, the high order 6 characters contain a 3 byte FICON link address. The low order two characters contain a value identifying the logical partition ID if the processor is operating in PR/SM mode.

When Logical Path type is not E, E/L, F/E, or F/L, this field is blank.

SP FENCES

A value of Y indicates that the Logical Path is Fenced from, and therefore cannot be addressed by, the identified Storage Path. The 2105 will print FENCED in the table and have Y if it is fenced.

PATH GROUP ID

When the path group is other than E/A, and path group information is available, then the host path group identification consists of:

- CPU Serial No.
As received by way of a SPID command
- CPU Type
As received by way of a SPID command
- CPU Time Stamp
As received by way of a SPID command

When the logical path type is E/A, the ID field contains the 1 byte LSS number followed by the 2 byte SSID. The SERIAL field contains the subsystem serial number. The CPU type field will be blank, and the CPU Time Stamp field contains the last 3 bytes of the returned path group id information.

Interface information

When you specify the NODRIVE NOSCAN parameters on a 2105, ICKDSF prints the Interface Information table. This information can be used to assist in determining the link address information for establishing PPRC paths. The table

indicates the type (such as ESCON or FICON), the system adapter ID's, and the corresponding port link address when connected to a switch. (The port link address is the destination address portion of the PPRC link address.)

Note: A type of F will be indicated if the path is FICON, and a 3 byte FICON port link address will be printed. The legend will indicate F = FICON. The port link information in the table refers to the connection between the control unit and the switch. If the port information is not available or if it is not installed, the field will print N/A.

The following is an example of an Interface Information table:

Table 34. Interface information

TYPE	SYSTEM ADAPTER ID	HOST LINK ADDRESS
F	04	010A08
E	80	96

N/A = Not Available or Not Assigned
Interface Type:
E = ESCON
F = FICON

Host interface information

When you specify the NODRIVE NOSCAN parameters on a 2105, ICKDSF prints the Host Interface Information table. The Host Interface Information table is not printed in the VSE environment.

When the table shows a value in the CHPID column with all other fields containing “-”, the CHPID may be defined but unavailable. You can reference the Path Status table printed at the beginning of the pathing reports to help determine if this is the case.

The following is an example of the Host Interface Information table.

Table 35. Host interface information

TYPE	CHPID	HOST LINK ADDRESS	SYSTEM ADAPTER ID
E	D0	DB00	80
-	2C	-	-
F	F4	20010000	04
-	2D	-	-

- = Not Applicable
Interface Type:
E = ESCON
F = FICON

Note: When a device/control unit is attached through ‘FICON bridge’, or in a mixed environment where some paths are attached through ‘FICON bridge’, paths attached through ‘FICON bridge’ will show as ESCON. The information printed is based on information returned by the control unit, and they will show as ESCON because it appears to the control unit as if it is connected through ESCON.

Fiber channel connection information

The fiber channel connection information table prints when you run ANALYZE NODRIVE NOSCAN and have specified the new SECWWNN parameter. The table is printed only for 2105 devices at the appropriate level of microcode.

The information indicates potential connectivity of the Fibre Channel ports in the ESS to each system adapter port in the ESS.

A parameter is added to the ANALYZE command to allow the user to specify the World Wide Node Name (WWNN) of the volume that they want to use as a secondary PPRC volume connected by way of FCP paths. When PPRC FCP support exists, the ANALYZE pathing reports will include the Fibre Channel Connection Information Table. This information indicates the potential connectivity of the Fibre Channel ports in the ESS where the I/O is issued, to each system adapter port in the ESS specified by the secondary WWNN.

Example

The information shown below is for example purposes only, the actual values would reflect the real devices used and values returned. The example is intended to show the format of the table and what the information represents.

In this example, the user would run

```
ANALYZE UNIT(DA01) NODRIVE NOSCAN SECWWNN(5005076300C0A222)
```

If the FCP support exists, the following table would be printed, showing that the addressed device DA01 with WWNN=5005076300C0A234 can potentially connect to the device with WWNN=5005076300C0A222 from:

```
PRI SAID 0000 TO THE SECONDARY TAGS 0000 THRU 000F
PRI SAID 0001 TO THE SECONDARY TAGS 0004, 0005, 0006
PRI SAID 0002 TO THE SECONDARY TAGS 000D, 000E, 000F
PRI SAID 0003 TO THE SECONDARY TAGS 0000 THRU 0002, 000E, 000F
```

```
FIBRE CHANNEL CONNECTION INFORMATION TABLE
PRIMARY WWNN = 5005076300C0A234, SECONDARY WWNN =5005076300C0A222
```

PRIM SAID	AVAILABLE SECONDARY SAIDS
0000	0000(0000) 0001(0000) 0002(0007) 0003(0002) 0004(0000) 0005(0001) 0006(0006) 0007(0000) 0008(0001) 0009(0001) 000A(0001) 000B(0000) 000C(0001) 000D(0000) 000E(0000) 000F(0001)
0001	0004(0000) 0005(0001) 0006(0006)
0002	000D(0000) 000E(0000) 000F(0001)
0003	0000(0000) 0001(0000) 0002(0007) 000E(0000) 000F(0001)

WHERE THE NUMBER IN PARENTHESIS IS THE RETURN CODE FOR THE SAID, AS FOLLOWS

```
0000=POTENTIAL CONNECTION
0001=NO POTENTIAL CONNECTION
0002=PRIMARY ADAPTER OFFLINE
0003=LINK FAILURE
0004=INVALID TOPOLOGY
0005=ERRORS DETECTED
0006=SECONDARY WWNN INVALID
0007=TIMEOUT DETECTED
```

Chapter 12. BUILDIX command—CKD

MVS

The BUILDIX command builds a VTOC index using the MVS version of ICKDSF. Use BUILDIX to:

- Change direct access volumes from an OS format VTOC (OSVTOC) to an indexed format VTOC (IXVTOC).
- Build a VTOC index data set and format the VTOC to show that the volume is in IXVTOC format.
- Change a volume in IXVTOC format to OSVTOC format.

To build an index data set on a volume, the BUILDIX command requires that the host system contain indexed VTOC programming support. Without this support, BUILDIX will not run.

For more information about indexed format VTOCs, see Appendix C, “VTOC index.”

Volumes containing split cylinder extents are not supported by the BUILDIX command.

BUILDIX supports dual copy volumes that are in duplex or suspended duplex state.

For information on ICKDSF support of the RAMAC family of devices, see “ICKDSF support of the RAMAC Array family” on page 8.

Protecting the BUILDIX command with RACF

The MVS version of ICKDSF checks the general resource profile for a facility class profile of STGADMIN.ICK.BUILDIX. If RACF is not installed or the facility STGADMIN.ICK.BUILDIX is not created, the BUILDIX command executes with no authorization check. For additional information, see “Protecting ICKDSF commands with RACF” on page 35.

Syntax

BUILDIX
Required Parameters DDNAME(<i>dname</i>) IXVTOCIOSVTOC
Optional Parameters PURGEINOPURGE

Required parameters

DDNAME parameter: identify the volume

Parameter/ Abbreviations	Description
DDNAME(<i>dname</i>) DDNAME	Must be specified to identify the volume where the VTOC is to be changed. Required for an online MVS volume. For <i>dname</i> , specify the MVS JCL DD statement that identifies the device.

BUILDIX command—CKD

Parameter/ Abbreviations	Description
Default:	None.
Restrictions:	The MVS volume must be online.

IXVTOCIOSVTOC parameter: identify the BUILDIX function

Parameter/ Abbreviations	Description
IXVTOC IX	Causes an OSVTOC to be changed to the indexed format.
OSVTOC OS	Causes an indexed VTOC to be changed to an OSVTOC.
Default:	None.
Restrictions:	You must specify IXVTOC or OSVTOC for BUILDIX to run. IXVTOC can be specified only if indexed VTOC programming support is part of the host system. If this support is not available, BUILDIX will not run.

Optional parameters

PURGEINOPURGE parameter: specify disposition of the index data set

Parameter/ Abbreviations	Description
PURGE PRG	Deletes the index data set when changing an indexed VTOC to an OSVTOC.
NOPURGE NOPRG	Leaves the index on the volume.
Default:	NOPURGE
Restrictions:	PURGEINOPURGE is valid only when changing from an indexed VTOC to an OSVTOC. If specified with the parameter IXVTOC, the option is ignored.

Converting an OSVTOC to an indexed VTOC

Before you invoke BUILDIX to change an indexed VTOC, you must preallocate the index data set in a separate job or job step, or you must provide a DD card describing the index data set in the same job step so the scheduler allocates the index before the command runs.

Be sure that the name of the index data set begins with "SYS1.VTOCIX." and that each index data set in your installation has a unique third-level qualifier. The recommended convention is SYS1.VTOCIX.volser. This prevents ENQ lockouts on all other volumes needing IXVTOC services.

If the first character of the volser is numeric, use another convention. The convention used for the INDEX parameter of the INIT command is to replace the first character of the volser with the letter V; the last five characters of all volsers starting with a numeric character must be unique. The name SYS1.VTOCIX. is a reserved name in systems supporting the indexed VTOC, and only one data set per volume can begin with this prefix.

Space for the index must be reserved in one continuous extent. Allocate the index by absolute track or specify the CONTIG subparameter for all other requests. The amount of space to reserve for the index is device-dependent, as well as dependent upon the size (in tracks) of the VTOC. A reference table to aid in determining how much space to reserve for the index is found in Appendix C, “VTOC index.”

When you convert the VTOC to OSVTOC or IXVTOC, BUILDIX performs a dummy allocation. The data set name used for the dummy allocation is SYS1.VTOCIX.Vxxxxx (see the INDEX parameter of the INIT command for the conventions followed for this data set name).

Converting an indexed VTOC to an OSVTOC

You can change an indexed VTOC to an OSVTOC.

You can leave the index allocated (NOPURGE) or delete it (PURGE). If you change the OSVTOC back to the IXVTOC format, NOPURGE allows for no calculation as to size and optimum location. If you temporarily move an IXVTOC volume to a location that does not have programming support for the indexed VTOC, NOPURGE allows you to easily return it to a location having such support.

Before you move IXVTOC volumes to nonindexed VTOC systems, run BUILDIX with the OSVTOC parameter to format them. Upon return of a volume, use BUILDIX to rebuild the index.

Be careful when temporarily moving IXVTOC volumes to nonindexed VTOC systems. If you do not change the volumes to OSVTOC format before moving them, serious errors can occur when the volumes are returned to the indexed VTOC system. Direct access device space management (DADSM) functions performed by the nonindexed VTOC system on the VTOC do not always force reconstruction of the VTOC to OSVTOC format. VTOC changes that do not reconstruct the VTOC are not recorded in the index and, in effect, invalidate the index.

Examples of the BUILDIX command

The following examples show how you can code BUILDIX in a variety of situations. They show the JCL statements you need to use when entering BUILDIX.

The data definition statement varies according to the function.

Changing an IXVTOC to an OSVTOC without operator’s intervention

In this example, a 3390 volume with the volume identification VL3390 is changed to OSVTOC format. The DD statement simply identifies the volume.

```
//jobname    JOB
//stepname   EXEC PGM=ICKDSF,PARM='NOREPLYU'
//SYSPRINT  DD SYSOUT=A
//DDCARD    DD UNIT=(3390,,DEFER),VOL=(PRIVATE,SER=VL3390),
//          DISP=OLD
//SYSIN     DD *
BUILDIX DDNAME(DDCARD) OS NOPURGE
/*
```

- PARM='NOREPLYU' indicates that no operator intervention is required for this command. ICKDSF will not issue message ICK508A prompting for the reply.
- UNIT=(3390,,DEFER) specifies that mounting of the volume on the 3390 device type is to be deferred.

BUILDIX command—CKD

- VOL=(PRIVATE,SER=VL3390) identifies the volume and specifies a private mounting to prevent use of the volume for temporary data sets. The volume must have been mounted as PRIVATE.
- DISP=OLD specifies that allocation routines check the mount status of VL3390 and issue appropriate messages to the operator.
- NOPURGE in the BUILDIX command statement indicates that the index is to be left allocated. If you did not use NOPURGE, the command statement would have the same effect, since NOPURGE is the default. PURGE, as shown in the following command statement, deletes the index.

```
BUILDIX DDNAME(DDCARD) OSVTOC PURGE
```

Note: Whether the index is purged or left allocated is controlled by command parameters. Disposition of the index data set must not be specified in the DD statement.

Building a VTOC index on a volume without an index allocated

This option requires additional parameters on the DD statement to cause allocation of the index. The statement must contain data set information for the index.

```
//jobname JOB
//stepname EXEC PGM=ICKDSF
//SYSPRINT DD SYSOUT=A
//VOLDD DD UNIT=(3390,,DEFER),VOL=(PRIVATE,SER=339003),
// DSN=SYS1.VTOCIX.V39003,DISP=(NEW,KEEP),
// SPACE=(TRK,10,,CONTIG)
//SYSIN DD *
BUILDIX DDNAME(VOLDD) IXVTOC
/*
```

- DSN=SYS1.VTOCIX.V39003 specifies the name of the index data set. Because the INDEX parameter of INIT replaces the first character of the volume serial number with the letter V, the third-level qualifier appears as V39003. The recommended convention for naming the index is using the letter V as the first character, for example VL3390. For more information, see “Converting an OSVTOC to an indexed VTOC” on page 116.
- DISP=(NEW,KEEP) directs the system allocation routines to allocate the data set before running ICKDSF commands and to retain it upon termination of the task.
- SPACE=(TRK,10,,CONTIG) when location is not a primary concern, reserves ten contiguous tracks at some location. If you are processing system-managed volumes, you cannot specify ABSTR on the SPACE parameter.
- SPACE=(ABSTR,(10,1)) directs the allocation routines to allocate a ten track index starting at track 1. ABSTR is specified in the space request to ensure that the index space is a single continuous extent and is in the location desired.

Building a VTOC index on a volume with an index allocated

In this example, volume VL3390 was changed to an OSVTOC, either by the user or by a system routine that disabled the index and changed the VTOC to OSVTOC format. The index data set was left allocated on the volume. The DD statement required to change again to an IXVTOC is shown.

```
//jobname JOB
//stepname EXEC PGM=ICKDSF
//SYSPRINT DD SYSOUT=A
//VOLDD DD UNIT=(3390,,DEFER),VOL=(PRIVATE,SER=VL3390),
// DSN=SYS1.VTOCIX.VL3390,DISP=OLD
//SYSIN DD *
BUILDIX DDNAME(VOLDD) IX
/*
```

Note: DISP=OLD specifies that the data set already exists.

Chapter 13. CONTROL command—CKD



You can use the CONTROL command to reset certain subsystem conditions that have been previously set. Use CONTROL after the condition has been repaired to reset them. For example, use CONTROL to:

- Reset a device that has been WRITE INHIBITED
- Reset an indefinite status condition
- Clear a fence status of a path or a device

The CONTROL command supports dual copy volumes that are in duplex or suspended duplex state. It can also be used to display some subsystem information.

CMS When you run the CMS version of ICKDSF, the CONTROL command is valid only with dedicated devices. For more information, see Chapter 5, “Getting started with the CMS version.”

For information on ICKDSF support of the RAMAC family of devices, see “ICKDSF support of the RAMAC Array family” on page 8.

For information on ICKDSF support of the Internal Disk devices, see “ICKDSF support of the Internal Disk” on page 9.

Protecting the CONTROL command with RACF

The MVS version of ICKDSF checks the general resource profile for a facility class profile of STGADMIN.ICK.CONTROL. If RACF is not installed or the facility STGADMIN.ICK.CONTROL is not created, the CONTROL command executes with no authorization check. For additional information, see “Protecting ICKDSF commands with RACF” on page 35.

Syntax

CONTROL
Required Parameters DDNAME(<i>dname</i>) SYSNAME(<i>sysxxx</i>) UNITADDRESS(<i>ccuu</i>)
Optional Parameters ALLOWWRITE CLEARFENCE CONFIGURE(DISPLAY) RESETICD REMOVEFCPY

Required parameters

DDNAME|SYSNAME|UNITADDRESS parameter: identify the volume



Parameter/ Abbreviations	Description
DDNAME(<i>dname</i>) DNAME	Required for an online MVS volume. The volume must be online. For <i>dname</i> , specify the MVS JCL DD statement that identifies the volume.

CONTROL command—CKD

Parameter/ Abbreviations	Description
SYSNAME(sysxxx)	Required for a VSE volume when executing ICKDSF in batch mode; the volume must be online. For <i>sysxxx</i> , specify the SYSNAME in the ASSGN control statement.
UNITADDRESS(<i>ccuu</i>) UNITADDR UNIT	<p>Required for an offline MVS volume, a Stand-Alone volume, and an attached CMS volume. For VSE, it is required when executing ICKDSF in command mode; the volume must be online.</p> <p>In MVS, the volume must be on a path that is online. If the volume is on a path that is offline, the program might enter a nonterminating wait state. For <i>ccuu</i>, specify the address in hexadecimal (3 or 4 digits) of the channel and unit for the volume.</p> <p>For the CMS version, specify the virtual address of the dedicated volume.</p> <p>The unit address is the device number.</p>
Default:	None.
Restrictions:	None.

Optional parameters

ALLOWWRITE parameter: clear a storage control

Parameter/ Abbreviations	Description
ALLOWWRITE ALLOWWR	Must be specified if you want to clear a storage control that has been WRITE INHIBITED.
Default:	 <p>If you are running the MVS, CMS, or Stand-Alone version, ALLOWWRITE is the default.</p> <p>If you want to execute ALLOWWRITE and CLEARFENCE, both parameters must be specified.</p>
Restrictions:	 <p>Not valid for the VSE version.</p> <p>Valid only for DASD devices attached to an IBM 3880 or IBM 3990 Storage Control.</p>

CLEARFENCE parameter: clear a fence status

Parameter/ Abbreviations	Description
CLEARFENCE CLEARF CLRF	Clears a fence status of a path or a device.
Default:	 <p>If you are running the VSE version, CLEARFENCE is the default.</p>
Restrictions:	<p>If you want to run ALLOWWRITE and CLEARFENCE, you must specify both parameters.</p> <p>Valid only for DASD devices attached to an IBM 3990 Storage Control.</p>

CONFIGURE(DISPLAY) parameter: display subsystem information

Parameter/ Abbreviations	Description
CONFIGURE(DISPLAY)	Use to display subsystem information, such as subsystem serial number, subsystem ID, and channel connection address, which may be used with the PPRCOPY command.
Default:	None.
Restrictions:	CONFIGURE(DISPLAY) is not valid for RVA.
Note: The information displayed will vary depending on the device type.	

RESETICD parameter: reset indefinite status condition

Parameter/ Abbreviations	Description
RESETICD	Use to reset a device indefinite status condition. Use when the status track of a device attached to an IBM 3990 Model 3 or Model 6 are unreadable, and the device is flagged as "status cannot be determined".
Default:	None.
Restrictions:	Valid only for devices attached to an IBM 3990 Model 3 or 6. RESETICD is not valid on a 2105 device.

REMOVEFCPY parameter: remove Flash Copy information

Parameter/ Abbreviations	Description
REMFCPY	Use on a 2105 to tell the subsystem to remove Flash Copy information. When specified, the 2105 removes all Flash Copy information from the subsystem for all Flash Copy pairs. Note: There may be a time delay between the completion of the ICKDSF CONTROL command and the time that the subsystem completes removal of the Flash Copy information.
Default:	None.
Restrictions:	Valid only for 2105 devices.

Clearing a storage control without performing an IML

The **CONTROL** command with the **ALLOWWRITE** parameter is valid for **MVS, CMS (dedicated devices only), and Stand-Alone users only**. This command and parameter combination allows subsequent writes to the devices controlled by an IBM 3880 or IBM 3990 Storage Control if the storage control has been **WRITE INHIBITED** by the error recovery procedures at the channel, director, or storage control level.

After **WRITE INHIBIT**, subsequent write operations to any device attached to the **WRITE INHIBITED** storage control will fail. **CONTROL ALLOWWRITE** clears all storage controls to which a specified device is attached for subsequent write operations. **CONTROL ALLOWWRITE** lets you clear a storage control that has been **WRITE INHIBITED** without having to perform an IML.

Allowing write operations through a storage control



CONTROL command—CKD

In an MVS environment, the system error recovery procedures (ERPs) might detect an error condition in the storage control. Future write operations to some or all of the devices through the storage control might then fail.

If the ERPs detect such a condition, they can write-inhibit the storage control (at different levels), thereby inhibiting any further write operations to the devices through the failing storage control. If an alternate path exists through a different storage control, the devices can remain online and functional.

Maintenance is required on the failing storage control.

After you repair the failing storage control, use CONTROL to write-allow the storage control. Write operations through that storage control will be restored.

Because CONTROL operates on a device basis, if more than one storage control (that is, path) to a device is failing, all such storage controls must be repaired before executing the CONTROL command.

SA When running Stand-Alone ICKDSF, all storage controls attached to the specified device are cleared for subsequent write operations.

MVS If you receive message IEA467E or IEA468I at the system console, perform maintenance on the failing storage control.

Clearing a fenced path or device

When an IBM 3990 Storage Control is in DLSE mode, an error can occur that causes the subsystem to fence off one particular path to a device or group of devices. The subsystem continues to function with the remaining paths.

Repair the condition that caused the FENCE on the failing storage control and device. After repairing the failing unit, if the path is still fenced, use the CONTROL command with the CLEARFENCE parameter to clear the fenced condition for the path.

The CONTROL command with the CLEARFENCE parameter will clear ALL paths to ALL devices on the subsystem. The specified device can be any device on the subsystem.

Warning

Make sure the CE panel on the control unit and DASD is inactive, or that the CE has finished the repair action panels and cleared the repair action, **before** the job is run.

The CLEARFENCE function is available in the CMS, VSE, MVS, and Stand-Alone environments.

MVS Perform maintenance after receiving console message IEA473I, which indicates a fence condition has occurred.

Discarding data pinned in cache

When devices are attached to an IBM 3990 Model 3 or Model 6 Storage Control, errors can occur when the Storage Control attempts to read the device status track. If the device status track is unreadable, the device is placed in an indefinite status condition and all subsequent data transfer operations end with a unit check.

The unit check sense data indicates the error that prevents reading of the status track. Because of the indefinite status condition, Modified Cache Fast Write or DASD Fast Write data may exist in the 3990 Model 3 or Model 6 cache storage and cannot be written to the device.

Use RESETICD to reset the indefinite status condition.

MVS

Then use the SETCACHE command of the IDCAMS utility to destage or discard any data that is pinned in the cache because of the indefinite status condition.

VM

For VM, use DESTAGE or DISCARD.

Examples of the CONTROL command

MVS

VSE

The following examples show you how to use the CONTROL command and the JCL statements you will need to use when running CONTROL.

Clearing a WRITE INHIBITED storage control

In the following example, a WRITE INHIBITED IBM 3880 or IBM 3990 Storage Control, attached to an IBM 3380 (or 3390) DASD volume with a volume serial number of ABCDEF, is to be cleared. The DD statement identified in the input stream identifies an online DASD volume.

```
//jobname JOB
//stepname EXEC PGM=ICKDSF
//SYSPRINT DD SYSOUT=A
//DDCARD DD UNIT=3380,DISP=OLD,VOL=SER=ABCDEF
//SYSIN DD *
CONTROL ALLOWWR DDNAME(DDCARD)
/*
```

Clearing a storage path fence status

The following example shows the CONTROL command and JCL used to reset a fence status after the path and the device have been repaired. The DD statement identified in the input stream identifies an online DASD volume.

```
//jobname JOB
//stepname EXEC PGM=ICKDSF
//SYSPRINT DD SYSOUT=A
//DDCARD DD UNIT=3380,DISP=OLD,VOL=SER=ABCDEF
//SYSIN DD *
CONTROL CLEARFENCE DDNAME(DDCARD)
/*
```

Resetting indefinite status condition

The following example shows the JCL and CONTROL command used to reset the indefinite status condition on device 162 where the status track is unreadable. Device 162 is attached to an IBM 3990 Model 3 or 6 Storage Control. Device 162 is offline to the MVS operating system.

```
//jobname JOB
//stepname EXEC PGM=ICKDSF
//SYSPRINT DD SYSOUT=A
//SYSIN DD *
CONTROL UNIT(0162) RESETICD
/*
```

Resetting a fence status



The following example shows the CONTROL command used to reset a fence status after the path and the device have been repaired. The example is for the CMS or Stand-Alone version of ICKDSF.

```
CONTROL CLEARFENCE UNITADDRESS(0162)
```

Display subsystem information

The following example shows the CONTROL command used with the CONFIGURE(DISPLAY) parameter to display subsystem information, such as the serial number of a control unit:

```
CONTROL UNIT(D43) CONFIGURE(DISPLAY)
ICK00700I DEVICE INFORMATION FOR 0D43 IS CURRENTLY AS FOLLOWS:
    PHYSICAL DEVICE = 3390
    STORAGE CONTROLLER = 3990
    STORAGE CONTROL DESCRIPTOR = E9
    DEVICE DESCRIPTOR = 06
    ADDITIONAL DEVICE INFORMATION = 08001500
ICK04000I DEVICE IS IN SIMPLEX STATE
ICK00706I SUBSYSTEM INFORMATION FOR 0D43 IS CURRENTLY AS FOLLOWS:
    SUBSYSTEM SERIAL NUMBER = 90007
    SUBSYSTEM ID = 0057
    CHANNEL CONNECTION ADDRESS = 03
    PATHS/CLUSTER ID = C0
    SYSTEM ADAPTER ID = 04
    HOST LINK ADDRESS = C100
ICK00001I FUNCTION COMPLETED, HIGHEST CONDITION CODE WAS 0
```

The following example shows the CONTROL command used with the CONFIGURE(DISPLAY) parameter on a 2105 device. PATHS/CLUSTER ID is not applicable to 2105. LSS NUMBER is the logical subsystem number.

```
CONTROL DDNAME(DD1) CONFIGURE(DISPLAY)
ICK00700I DEVICE INFORMATION FOR 4F92 IS CURRENTLY AS FOLLOWS:
    PHYSICAL DEVICE = 3390
    STORAGE CONTROLLER = 2105
    STORAGE CONTROL DESCRIPTOR = E8
    DEVICE DESCRIPTOR = 06
    ADDITIONAL DEVICE INFORMATION = 42000035
ICK00706I SUBSYSTEM INFORMATION FOR 4F92 IS CURRENTLY AS FOLLOWS:
    SUBSYSTEM SERIAL NUMBER = FCA29
    SUBSYSTEM ID = 06C7
    CHANNEL CONNECTION ADDRESS = 12
    PATHS/CLUSTER ID = N/A
    LSS NUMBER = 07
```

SYSTEM ADAPTER ID = 40
HOST LINK ADDRESS = DB01
ICK00001I FUNCTION COMPLETED, HIGHEST CONDITION CODE WAS 0

CONTROL command—CKD

Chapter 14. CPVOLUME command—CKD



The CPVOLUME command is used to format a volume for use in a VM environment. It is used to perform the following functions associated with formatting VM volumes for CP use:

- | | |
|-----------------|---|
| FORMAT | Write records required by CP on cylinder 0. Write 4096-byte CP page records on an entire volume or on a range of cylinders. |
| ALLOCATE | Update the allocation map to indicate how each cylinder on a CP-formatted volume is to be used. |
| EXAMINE | Read a CP-formatted volume to verify that it is properly formatted and that records can be read without error. |
| LIST | Display the allocation map, volume serial, and device information, such as the number of cylinders. |
| LABEL | Rewrite the volume serial. |

For information on ICKDSF support of the RAMAC family of devices, see “ICKDSF support of the RAMAC Array family” on page 8.

For information on ICKDSF support of the Internal Disk devices, see “ICKDSF support of the Internal Disk” on page 9.

Formatting CP-owned volumes

CPVOLUME writes 4096-byte records on all of the cylinders to be used by CP. These records are referred to as **CP pages**. In addition to CP pages, cylinder 0 is formatted with records that include the volume label and the allocation map. The allocation map indicates how each cylinder on the volume is to be used by CP.

You can format or examine an entire volume, or you can limit the operation to part of a volume by specifying the RANGE parameter. If you omit the range parameter, CPVOLUME assumes that the range is for the entire volume. If you specify a range that does not begin with cylinder 0, then cylinder 0 must have been previously formatted.

All of the cylinders on a volume do not have to be formatted with CP pages. Only those cylinders that are to be used by CP need to be formatted. You must, however, always format cylinder 0, and it must be formatted before any other cylinders.

Formatting CP-owned volumes for a specific VM operating system

The CPVOLUME command formats volumes for use on VM/ESA or z/VM systems.

Syntax

The abbreviation for CPVOLUME is CPVOL.

CPVOLUME

CPVOLUME command—CKD

Required Parameters FORMAT ALLOCATE LABEL LIST EXAMINE UNITADDRESS(<i>ccuu</i>) VERIFY(<i>{serial}*NONE*</i>) NOVERIFY
Optional Parameters FILLER NOFILLER MIMIC(MINI(<i>nnnn</i>)) RANGE(<i>start,end</i>) READCHECK NOREADCHECK TYPE(<i>(type of allocation,start,end)...</i>) VOLID(<i>serial</i>)

Required parameters

FORMAT|ALLOCATE|LABEL|LIST|EXAMINE parameter: specify function

Parameter/ Abbreviations	Description
FORMAT FMT	Formats a volume. An entire volume or a range of cylinders can be formatted.
ALLOCATE ALLOC	Updates the allocation map of a previously formatted volume.
LABEL	Rewrites the volume label of a previously formatted volume.
LIST	Displays volume information for a previously formatted volume.
EXAMINE EXAM	Examines an entire volume or range of cylinders on a previously formatted volume for errors.
Default:	None.
Restrictions:	FORMAT, ALLOCATE, LABEL, LIST, and EXAMINE are mutually exclusive.

UNITADDRESS parameter: identify the device

Parameter/ Abbreviations	Description
UNITADDRESS(<i>ccuu</i>) UNITADDR UNIT	Required to specify the address of the volume to be processed. For <i>ccuu</i> , specify the address of the volume. The unit address is the device number.
Default:	None.
Restrictions:	None.

VERIFY|NOVERIFY parameter: verify the volume serial number

Parameter/ Abbreviations	Description
VERIFY(<i>serial</i>) VFY	Required when you want to verify the volume serial number before performing the requested function on the volume. If the volume serial number does not match that found on the volume, the CPVOLUME command ends. For <i>serial</i> , substitute 1 to 6 alphanumeric characters for the volume serial number. To verify that a volume serial number does not exist, substitute the string *NONE* for <i>serial</i> . If no volume serial exists, or if the volume serial is actually “*NONE*”, the CPVOLUME operation continues. If a volume serial exists, the CPVOLUME command ends.
NOVERIFY NOVFY NVFY	Required when you want to bypass verification of the volume serial number.

Parameter/ Abbreviations	Description
Default:	None. You must specify either VERIFY or NOVERIFY.
Restrictions:	None. However, when you specify the VERIFY parameter and verification fails, the command stops running.

Optional parameters

FILLERINOFILLER parameter: specify to include filler records

Parameter/ Abbreviations	Description
FILLER FILL	Includes filler records when 3380 or 3390 volumes in 3380 track compatibility mode are formatted.
NOFILLER NOFILL NFILL	Excludes filler records when 3380 or 3390 volumes in 3380 track compatibility mode are formatted.
Default:	NOFILLER is the default unless the volume was previously formatted with Filler records.
Restrictions:	FILLERINOFILLER applies to the IBM 3380 or 3390 volumes in 3380 track compatibility mode only. The parameters are ignored for other devices. NOFILLER is not valid with the range parameters if the volume was previously formatted with Filler records. FILLER is not valid with the range parameters if the volume was previously formatted without Filler records.

MIMIC(MINI) parameter: specify a special volume usage



Parameter/ Abbreviations	Description
MIMIC(MINI(<i>nnnn</i>))	Specifies the number of cylinders to be processed. For <i>nnnn</i> , specify the number of cylinders for the device.
Default:	If MIMIC(MINI) is not specified, the device is assumed to be dedicated.
Restrictions:	Valid only in the Stand-Alone version.

RANGE parameter: specify the range of cylinders

Parameter/ Abbreviations	Description
RANGE(<i>start,end</i>)	Specifies the range of cylinders that are to be formatted or examined. Use <i>start,end</i> to specify a range of cylinders.
Default:	If RANGE is not specified, the default is the entire volume.
Restrictions:	Valid only when you specify either FORMAT or EXAMINE.

READCHECKINOREADCHECK parameter: specify read-back check

Parameter/ Abbreviations	Description
READCHECK READCHK RDHECK READ	Performs a read-back check for each cylinder after it is formatted. If read-back check media errors are detected and the device supports media maintenance and is not a minidisk, the INSPECT function is issued to repair the track.
NOREADCHECK NOREADCHK NOREAD NREAD	Specifies not to perform a read-back check.
Default:	READCHECK
Restrictions:	<p>READCHECK is valid only when you specify FORMAT.</p> <p>The 3995-151, 3995-153, RAMAC array devices, Internal Disk devices, and the 2105 do not support media maintenance. Therefore, if you specify READCHECK against one of these devices and media maintenance errors are detected, the INSPECT function will not be issued, and the CPVOL command will end.</p>

TYPE parameter: specify the type of allocation

Parameter/ Abbreviations	Description														
TYPE(<i>type of allocation, start,end</i> ...)	<p>Specifies the type of allocation.</p> <p>Multiple statements of each <i>type of allocation</i> can be specified (up to 100). Be careful when you use multiple statements. Each succeeding statement modifies allocation without regard to previous statements.</p> <p>Use <i>start,end</i> to specify the cylinders required for the <i>type of allocation</i>.</p> <p>Specify <i>type of allocation</i> as follows:</p> <table border="0"> <tr> <td>Type</td> <td>Allocates...</td> </tr> <tr> <td>DRCT</td> <td>Directory space</td> </tr> <tr> <td>PAGE</td> <td>Paging space</td> </tr> <tr> <td>PARM</td> <td>Disk space for the CP PARM</td> </tr> <tr> <td>PERM</td> <td>Permanent space</td> </tr> <tr> <td>SPOL</td> <td>Spooling space for VM</td> </tr> <tr> <td>TDSK</td> <td>Temporary disk space</td> </tr> </table> <p>You can have back-to-back PARM disks.</p>	Type	Allocates...	DRCT	Directory space	PAGE	Paging space	PARM	Disk space for the CP PARM	PERM	Permanent space	SPOL	Spooling space for VM	TDSK	Temporary disk space
Type	Allocates...														
DRCT	Directory space														
PAGE	Paging space														
PARM	Disk space for the CP PARM														
PERM	Permanent space														
SPOL	Spooling space for VM														
TDSK	Temporary disk space														
Default:	None. You must specify <i>type of allocation</i> and <i>start,end</i> .														
Restrictions:	<p>Valid only with the FORMAT and ALLOCATE.</p> <p>When a volume is formatted for the first time, any space not specified by DRCT, PAGE, PERM, SPOL, and TDSK parameters is allocated as PERM. Subsequently, the allocation does not change unless you specify TYPE.</p> <p>Once you have allocated PARM as the <i>type of allocation</i>, you must reallocate the entire range if a change is required.</p>														

VOLID parameter: specify the volume serial number

Parameter/ Abbreviations	Description
VOLID (<i>serial</i>)	Writes the volume serial number in the volume label.
Default:	If VOLID is not specified, the existing volume serial number is used. If there is no current volume serial number, then you must specify VOLID.

Parameter/ Abbreviations	Description
Restrictions:	Valid only when you specify FORMAT or LABEL.

Formatting cylinders

The unit for formatting and allocation is the cylinder. CPVOLUME formats a cylinder by writing as many 4096-byte records as possible on each track of a cylinder. Each record is sequentially numbered within the cylinder. For example, a 3380 volume has ten records per track, therefore the first track contains records 1-10, the second track contains records 11-20, and the last track contains records 141-150.

You specify a range of cylinders to be formatted, which may be the entire volume. CPVOLUME formats each cylinder by writing the required number of 4096-byte page records on each track of the cylinder. If you specify READCHECK, CPVOLUME will read check each cylinder to ensure there are no errors.

If you specify READCHECK and a data check is encountered on a track:

1. ICKDSF issues INSPECT to check the surface of the track for defects.
2. INSPECT performs skip displacement surface checking to eliminate data checks from the track
3. If required, INSPECT assigns an alternate track.
4. After the track has been inspected, it is formatted once more and the FORMAT operation continues.

When formatting is complete, the allocation map will be updated from any allocation TYPE statements that you specified in the CPVOLUME FORMAT command.

Table 36 lists the number of records formatted on each of the CKD devices supported by the CPVOLUME command.

Table 36. Number of CKD records formatted by CPVOLUME command

Device	Records Per Track	Tracks Per Cylinder	Records Per Cylinder	High Cylinder¹	Records Per Volume
3375	8	12	96	958	92 064
3380-A, B, D, J	10	15	150	884	132 750
3380-E	10	15	150	1 769	265 500
3380-K	10	15	150	2 654	398 250
3390-1	12	15	180	1 112	200 340
3390-2	12	15	180	2 225	400 680
3390-3	12	15	180	3 338	601 020
3390-9	12	15	180	10 016	1 803 060
9345-1	10	15	150	1 439	216 000
9345-2	10	15	150	2 155	323 400

¹ High cylinder is the highest address. Number of cylinders is one more.

Formatting cylinder 0, track 0

CPVOLUME formats track 0 on cylinder 0 with the following records:

CPVOLUME command—CKD

IPL record

CPVOLUME creates an IPL record that puts the system into a wait state if the volume is IPLed before the CP nucleus is built.

Checkpoint record

CPVOLUME writes zeros in this record. The checkpoint record is written by CP and used by CP to save and retrieve information for a warm start.

Volume Label record

The owner field of the label record contains “CP370” if the volume is formatted for use on a System/370 VM system. The owner field of the label record contains “CPVOL” if the volume is formatted for use on a VM/XA or VM/ESA system.

Allocation record

Contains the allocation map for the VM operating system.

OS/VTOC Format 4 DSCB

The VTOC records created by CPVOLUME indicate that no space is available on the volume.

OS/VTOC Format 5 DSCB

The VTOC records created by CPVOLUME indicate that no space is available on the volume.

Updating the allocation map

Use ALLOCATE to update the allocation map on cylinder 0. If the volume has never been used before, all cylinders on a volume are initially allocated as PERM by CPVOLUME. You tell the ALLOCATE function how the allocation map should be changed by specifying a *type of allocation* followed by a range of cylinders. For example, (TDSK,100,199) indicates that the 100 cylinders from 100 to 199 should be allocated as temporary disk space.

Examining volumes for errors

Use EXAMINE to verify that cylinders are CP-formatted and readable without error. You specify a range of cylinders to be examined, which may be the entire volume. CPVOLUME reads each track on each cylinder to be examined. Validation ensures that each track contains the correct number of 4096-byte page records, that each record has the correct record number, and that data contained in the record can be read without error.

Two types of errors are reported by the EXAMINE function: format errors and data checks. A **format error** occurs when a track does not have the correct number of 4096 byte records or if the records do not have the correct record number (record ID). Format errors are reported by cylinder range; all cylinders within the reported range are improperly formatted.

Cylinders formatted for use as CMS minidisks, and cylinders contained in minidisks used by guest operating systems cause format errors to be reported. You can ignore these errors because the cylinders are not CP-formatted.

Data checks are not reported for cylinders that have format errors reported against them. For cylinders that are properly formatted, EXAMINE will report the CCHH of the first track that contains a data check.

The EXAMINE function is read-only and will not write over any user data. You can use the EXAMINE function to inspect any CP-formatted volume for formatting or

data check errors. For any errors reported by EXAMINE, you should take appropriate corrective action. For format errors, you can use CPVOLUME to format the cylinders. For data check errors, you can use the INSPECT command of ICKDSF to check the track surface.

Displaying volume information

Use LIST to display current volume information. Use this function to display the allocation map, volume label, and device information (for example, the number of cylinders).

Rewriting the volume label

Use LABEL to rewrite the volume label of a previously formatted volume. When the serial is rewritten, the remaining bytes of the volume label are unaltered.

Copying data to a different device size

On a CP-formatted volume, the size of the allocation map must match the number of cylinders on the volume. The map contains a one-byte allocation code for each cylinder and following the last byte is an “end-of-volume” code indicating that no more cylinders can be allocated.

When different models of the same device type are copied from one to another, the allocation map that is copied will no longer match the number of cylinders on the volume.

For example, if you copy a 3380 with 885 cylinders to a 3380 with 1770 cylinders, the allocation map will indicate that only 885 cylinders are allocated (even though the new volume has 1770 cylinders).

CPVOLUME will report such a mismatch; and if you allow CPVOLUME to continue, the allocation map will be expanded from 885 to 1770 cylinders. The expanded cylinders will be allocated as PERM space. The expanded cylinders will not be formatted as part of the expansion process. To format the expanded cylinders, issue CPVOLUME FORMAT RANGE(885,1769).

When data is copied from a large volume to a smaller volume, and cylinder 0 is included in the copy operation, the allocation map will map more cylinders than are on the volume.

Using the above example, the allocation map will indicate that 1770 cylinders are allocated, even though the new volume has only 885 cylinders. When CPVOLUME encounters a volume that has a mismatch, it is reported; and if you allow CPVOLUME to continue, the allocation map is reduced from 1770 to 885 cylinders. The allocation information for the last 885 cylinders is eliminated.

Creating a minidisk allocation map

The allocation map that CPVOLUME creates for a minidisk will map the number of cylinders of the minidisk. For example, for a 10-cylinder minidisk, CPVOLUME will create an allocation map that maps 10 cylinders. Likewise, CPVOLUME will not allow you to format cylinders beyond the bounds of the minidisk.



CPVOLUME command—CKD

The Stand-Alone version of CPVOLUME is unable to determine the size of the minidisk. In the Stand-Alone version, use the MIMIC(MINI(n)) parameter to indicate the number of cylinders of the minidisk. If you do not specify MIMIC(MINI(n)) for a minidisk, CPVOLUME assumes that the device is dedicated.

For example, to format 5 minidisk cylinders, you enter the ICKDSF command:

```
CPVOL UNIT(193) NVFY FORMAT MIMIC(MINI(5))
```

If you then attempt to update the size by issuing:

```
CPVOL UNIT(193) NVFY FORMAT MIMIC(MINI(10))
```

The following messages appears:

```
ICK03030I ALLOCATION MAP WILL BE EXPANDED FROM 5 TO 10 CYLINDERS  
ICK003D REPLY U TO ALTER VOLUME CONTENTS, ELSE T
```

Reply U to message ICK003D, and ICKDSF will update the allocation map.

Examples of the CPVOLUME command

The following examples show different ways to code the CPVOLUME command. The device used in the examples is a 3380 with 885 cylinders.

Formatting an entire volume

In this example, all 885 cylinders on the volume are formatted. A read-back check is specified to verify that all of the formatted records can be read without error. The allocation map will indicate that all 885 cylinders on the volume are allocated as PERM space.

Because NOVERIFY is specified, any existing volume label is ignored, and the volume is labelled "CPVOL1".

```
CPVOLUME FORMAT UNIT(0150) NOVERIFY VOLID(CPVOL1) READCHECK
```

Formatting part of a volume

In this example, the first 100 cylinders on the volume are formatted. The allocation map will indicate that cylinder 0 is PERM space, cylinders 1-99 are PAGE space, and cylinders 100-884 are PERM space.

Because NOVERIFY is specified, any existing volume label is ignored, and the volume is labelled "CPVOL1".

```
CPVOLUME FORMAT UNIT(0150) NOVERIFY VOLID(CPVOL1) RANGE(0,99) TYPE((PAGE,1,99))
```

Changing volume allocation

In this example, the allocation map on a 3390 Model 2 volume, which has already been formatted, is updated. The 426 cylinders that previously had been allocated as PERM are given a new allocation of TDSK, to be used as temporary disk space.

Because VERIFY is specified, CPVOLUME checks that the volume on unit address 9C4 has a volume label of ESA001.

```
CPVOLUME ALLOCATE UNITADDRESS(9C4) VERIFY(ESA001)-  
TYPE((TDSK,1800,2225))
```

Chapter 15. INIT command—CKD

If you are installing 3380, 3390, or 9345 devices...

You should use the INSTALL command. See Chapter 17, “INSTALL command—CKD,” on page 185.



You use the INIT command to initialize volumes. There are four levels of initialization.

1. **Minimal initialization** or **minimal INIT** refers to using the INIT command to write the volume label and VTOC on volumes for use by MVS or VSE operating systems. Minimal INIT is required for 3380, 3390, and 9345 devices after you use INSTALL or REVAL commands on MVS or VSE volumes. Minimal INIT is the only level of initialization valid for the 3995-151, 3995-153, and 3390-9 devices, and the minidisks.
2. **Medial initialization** or **medial INIT** refers to using the INIT command to validate the home address and record 0, and then perform a minimal INIT on a volume.

For 3375 and older devices, medial INIT is recommended for:

- A new DASD unit
- Replaced or upgraded HDA
- A DASD unit that has been physically relocated

For 3380, 3390, and 9345 devices, use the INSTALL command.

3. **Initialization for open-system DASD** formats the volume for use as open-system DASD.



Do not use the INIT command to perform a minimal INIT to volumes that are to be formatted for use in a VM environment. Use the CPVOLUME command instead.

When you initialize dual copy volumes, minimal initialization is the only level supported. Medial initialization requires that the volume is in simplex state.

For INIT support of minidisks and emulated devices, see:

- “MIMIC parameter: specify a special volume usage format” on page 146.
- Chapter 5, “Getting started with the CMS version.”
- “Emulating devices” on page 84.

For information on ICKDSF support of the RAMAC family of devices, see “ICKDSF support of the RAMAC Array family” on page 8.

For information on ICKDSF support of the Internal Disk devices, see “ICKDSF support of the Internal Disk” on page 9.

Protecting the INIT command with RACF

The MVS version of ICKDSF checks the general resource profile for a facility class profile of STGADMIN.ICK.INIT. If RACF is not installed or the facility STGADMIN.ICK.INIT is not created, the INIT command executes with no authorization check. For additional information, see “Protecting ICKDSF commands with RACF” on page 35.

Syntax

INIT
Required Parameters DDNAME(<i>dname</i>) SYSNAME(<i>sysxxx</i>) UNITADDRESS(<i>ccuu</i>) VERIFY(<i>serial</i> *NONE*[, <i>owner</i>]) NOVERIFY
Optional Parameters BOOTSTRAP NOBOOTSTRAP CONTINUE NOCONTINUE CYLRANGE(<i>start</i> , <i>end</i>) DATA NODATA DEVICETYPE(<i>devtype</i>) DOS[VSE] VTOC(EN <i>cylinder</i> , <i>head</i> [, <i>extent</i>]) FROMRANGE(<i>cylinder</i> , <i>head</i>) HEADRANGE(<i>start</i> , <i>end</i>) INDEX(<i>cylinder</i> , <i>head</i> [, <i>extent</i>]) NOINDEX IPLDD({ <i>dname</i> <i>sysin</i> }[, OBJFORMAT ABSFORMAT]) LABELS(<i>n</i>) MAP NOMAP MIMIC(<i>type</i>) NOCHECK OWNERID(<i>owner</i>) PASSWORDS((<i>dsname</i> / <i>password</i>),...) PURGE NOPURGE STORAGEEGROUP TORANGE(<i>cylinder</i> , <i>head</i>) VALIDATE NOVALIDATE VOLID(<i>serial</i>) VTOC(EN IOPENDISK <i>cylinder</i> , <i>head</i> [, <i>extent</i>])

Required parameters

DDNAME|SYSNAME|UNITADDRESS parameter: identify the volume

Parameter/ Abbreviations	Description
DDNAME(<i>dname</i>) DNAME	Required for an online MVS volume. Note that the volume must be online and mounted as PRIVATE. For <i>dname</i> , specify the MVS JCL statement that identifies the volume. WARNING. During online INIT processing, do not submit another job that will access the same volume. When you initialize a volume for the first time under MVS, the volume must be mounted offline because it contains no volume label and is not acceptable to an operating system.
SYSNAME(<i>sysxxx</i>)	Required for a VSE volume when executing ICKDSF in batch mode; the volume must be online. For <i>sysxxx</i> , specify the SYSNAME in the ASSGN system control statement.

Parameter/ Abbreviations	Description
UNITADDRESS(<i>ccuu</i>) UNITADDR UNIT	<p>Required for an offline MVS volume, a Stand-Alone volume, and an attached CMS volume. For VSE, it is required when executing ICKDSF in command mode; the volume must be online.</p> <p>In MVS, the volume must be on a path that is online. If the volume is on a path that is offline, the program might enter a nonterminating wait state. For <i>ccuu</i>, specify the address (3 or 4 hexadecimal digits) of the channel and unit of the volume.</p> <p>For the CMS version, specify the virtual address of the dedicated volume or minidisk.</p> <p>The unit address is the device number.</p>
Default:	None.
Restrictions:	None.

VERIFYINOVERIFY parameter: verify volser and ownerid

Parameter/ Abbreviations	Description
VERIFY(<i>serial[,owner]</i>) VFY	<p>Required when you want to verify the volume serial number and owner identification before initializing the volume or minidisk. If the volume serial number or owner identification does not match that found on the volume or minidisk, INIT ends.</p> <p>For <i>serial</i>, substitute 1 to 6 alphanumeric characters for the volume serial number.</p> <p>To verify that a volume serial number does not exist, substitute the string *NONE* for <i>serial</i>. If no volume serial exists, or if the volume serial is actually "**NONE**", the INIT operation continues. If a volume serial exists, the INIT command ends.</p> <p>For <i>owner</i>, substitute 1 to 14 alphanumeric characters for the owner identification.</p> <p>Running in the offline mode, if VERIFY(<i>serial</i>) parameter is specified in the INIT command and PARM='NOREPLYU' is specified in the EXEC card in the JCL, no operator's intervention (Reply <i>U</i> or <i>T</i>) is required.</p>
NOVERIFY NOVFY NVFY	Required when you want to bypass verification of the volume serial number.
Default:	None. You must specify either VERIFY or NOVERIFY.
Restrictions:	<p>You cannot verify the owner identification separately from the volume serial number. Both the volume serial number and the owner identification must be verified when you want to verify the owner identification.</p> <p>When you specify the VERIFY parameter and verification fails, the command stops running.</p>

Optional parameters

BOOTSTRAPINBOOTSTRAP parameter: write IPL records

Parameter/ Abbreviations	Description
BOOTSTRAP BOOT	<p>Indicates that you are supplying the IPL bootstrap records that are written on the volume or minidisk during initialization.</p> <p>These records must be the first four records in the IPL program text. The first text record must have IPL1 in the first four columns, followed by 24 bytes of data. These 24 bytes have the same format as the first IPL record described under ABSFORMAT in "IPLDD parameter: write a user-supplied IPL program on the volume" on page 144.</p> <p>The next three text records must have IPL2 in their first four columns, followed by 68 bytes of data each in the second and third records and eight bytes of data in the last record. These 144 bytes of data have the same format as IPL record 2 described under ABSFORMAT.</p>

INIT command—CKD

Parameter/ Abbreviations	Description
NOBOOTSTRAP NOBOOT NBOOT	Indicates that you want the system to supply the IPL bootstrap records that are written on the volume during initialization.
Default:	NOBOOTSTRAP
Restrictions:	<p>The BOOTSTRAPINOBOOTSTRAP parameters apply only when the IPLDD parameter is specified. This parameter is ignored when the IPL program is supplied in absolute format.</p> <p>The BOOTSTRAPINOBOOTSTRAP parameters are not valid for the 3995-151 and 3995-153 devices.</p> <p>Note: The BOOTSTRAP parameter cannot be specified without the IPLDD parameter.</p>

CONTINUE|NOCONTINUE parameter: resume from a checkpoint

Parameter/ Abbreviations	Description
CONTINUE CONT	<p>Resumes processing from the last checkpointed location.</p> <p>Issues a message indicating where processing is resumed.</p>
NOCONTINUE NOCONT	<p>When you specify NOCONTINUE, INIT recovers approximately 1,000 tracks from the last checkpoint, and then processes the new range or full volume, as specified. For examples of this parameter, see “Resuming initialization from a checkpoint location” on page 73.</p> <p>Note that ICKDSF still goes to the backup location even if you issue NOCONTINUE. This is done to ensure no tracks are left in a nonstandard format.</p>
Default:	CONTINUE
Restrictions:	<p>These parameters are interrogated only if processing was previously interrupted during a medial or maximal initialization.</p> <p>The CONTINUE function does not support the 3995-151, 3995-153, 3390-9, or a CKD device emulated on an FBA device.</p> <p>CONTINUE is ignored for minidisks.</p> <p>When VTOC(OPENDISK) is specified, the CONTINUE and NOCONTINUE parameters are ignored. Checkpoint recovery may take place for a previous checkpoint, but the volume formatting will then resume from the beginning of the volume to ensure every track on the volume has the proper format.</p>

CYLRange parameter: specify a range of cylinders

Parameter/ Abbreviations	Description
CYLRange(<i>start,end</i>) CYLR CYL	<p>Used to specify what part of a volume is to be surface checked. Use the CYLRange parameter to specify the starting and ending cylinders to be examined before standard volume initialization is performed.</p> <p>For <i>start,end</i>, substitute decimal (n) or hexadecimal digits (for example, X'2AB',X'3DE') to identify the starting and ending cylinders to be examined.</p> <p>If you specify CYLRange and do not specify HEADRange, all the heads of the specified cylinders are processed.</p> <p>For information on specifying the starting and ending heads (HEADRange) to go with the starting and ending cylinders, see “HEADRange parameter: specify a range of heads” on page 143.</p> <p>For information on specifying part of a volume, see “Range parameters: specifying part of a volume” on page 154.</p>
Default:	None.

Parameter/ Abbreviations	Description
Restrictions:	<p>Only the starting value is required for CYLRANGE. If the user does not specify an ending value, the last cylinder is used as the ending value. By specifying an ending value greater than the maximum for the device, processing is performed to the maximum value for that device.</p> <p>CYLRANGE:</p> <ul style="list-style-type: none"> • Cannot be specified with FROMRANGE/TORANGE. • Applies only when VALIDATE is specified.

DATAINODATA parameter: write FFVDP

Parameter/ Abbreviations	Description
DATA	Writes the FFVDP on the specified tracks during the validate process.
NODATA	Indicates you do not want to write the FFVDP on the volume.
Default:	NODATA
Restrictions:	<p>The DATA parameter applies only when the VALIDATE parameter has been specified. If DATA is specified with NOVALIDATE, the function ends with a condition code of 12.</p> <p>DATA:</p> <ul style="list-style-type: none"> • Is valid for the IBM 3375, 3380, 9345, 9391, 9394, and the 3390 (models 1, 2, and 3), 9393, 9396, 9397, and Internal Disk devices. • Is not valid for the 3390-9 or when you are processing minidisks. <p>When DATA is specified for other devices, the parameter is ignored and no data is written.</p>

DEVICETYPE parameter: identify the type of device

Parameter/ Abbreviations	Description
DEVICETYPE(<i>devtype</i>) DEVTYPE DEVTYP	<p>Required in the Stand-Alone version when the MIMIC(MINI) or MIMIC(EMU) parameter is specified.</p> <p>For <i>devtype</i>, substitute 1 to 8 characters for the type of device on which the volume is mounted. See Table 13 on page 8 for valid device types.</p>
Default:	None.
Restrictions:	Applies only when you are initializing a volume in the Stand-Alone version and MIMIC(MINI) or MIMIC(EMU) is specified. If DEVICETYPE is specified when it does not apply, it will be ignored.

DOSVTOCIVSEVTOC parameter: specify the VTOC in VSE



Parameter/ Abbreviations	Description
DOSVTOC(ENDI <i>cylinder,head[,extent]</i>) DVTOC	<p>Specifies the location and size of the volume or minidisk VTOC for a VSE system.</p> <p>For <i>cylinder,head</i>, specify decimal (n) or hexadecimal numbers (for example, X'AB',X'0') to identify the cylinder and head where the volume table of contents is to be placed.</p> <p>For <i>extent</i>, specify decimal (n) or hexadecimal numbers (for example, X'E') for the number of tracks that are to be reserved for the volume or minidisk VTOC. If extent is omitted, one track is reserved.</p> <p>When you specify DOSVTOC(END) or VSEVTOC(END), the VTOC is put on the last primary cylinder of the volume or minidisk and is one cylinder in length.</p>

INIT command—CKD

Parameter/ Abbreviations	Description
VSEVTOC(ENDI <i>cylinder,head[,extent]</i>)	VSEVTOC and DOSVTOC give the same results. See DOSVTOC explanation above.
Default:	If VTOC, DOSVTOC, or VSEVTOC, are not specified, the default taken is an MVS VTOC at cylinder 0, track 1. If VTOC, DOSVTOC, or VSEVTOC are not specified, and the device is not a minidisk, the size is defaulted to the number of tracks in a cylinder minus one.
Restrictions:	You cannot place a VTOC at cylinder 0, track 0. Specification of the INDEX parameter is invalid with DOSVTOC. For devices that have the ability to be configured as small volumes, do not use the ICKDSF default sizes if the volume is too small for them. The size must be specified to fit within the size of the device configured.
Note: For devices containing more than 64K tracks, there are special considerations for VTOC placement. The existing IBM software uses relative track addressing or the Track-Track-Record (TTR) format to process the VTOC. This restricts the highest address that can be referenced as a VTOC track to be 64K-1. Because of this, the entire VTOC must reside within the first 64K tracks; that is, the VTOC must end before cylinder 4369 (X'1111') head 1.	

FROMRANGE parameter: specify a specific starting location

Parameter/ Abbreviations	Description
FROMRANGE(<i>cylinder,head</i>) FROMR FROM	Use this parameter to specify the starting track (cylinder and head) to be surface checked or examined before minimal volume initialization is performed. For <i>cylinder,head</i> substitute decimal (n) or hexadecimal digits (for example, X'2AB',X'E') to identify the cylinder and head at which processing is to start. If you specify only one value, ICKDSF takes it to be the cylinder and the head value is defaulted to 0. If you specify FROMRANGE and do not specify TORANGE, TORANGE is defaulted to the last alternate cylinder of a volume or minidisk. For information on specifying the ending track (TORANGE) to go with the starting track, see "TORANGE parameter: specify a specific ending location" on page 148. For information on specifying part of a volume to be examined, see "RANGE parameters: specifying part of a volume" on page 154.
Default:	None.
Restrictions:	FROMRANGE cannot be specified with CYLRANGE/HEADRANGE. FROMRANGE applies only when VALIDATE is specified.

HEADRANGE parameter: specify a range of heads

Parameter/ Abbreviations	Description
HEADRANGE(<i>start,end</i>) HDRANGE HEADR HDR HD	<p>Use the HEADRANGE parameter to specify the part of a volume you want surface checked.</p> <p>For <i>start,end</i>, substitute decimal (n) or hexadecimal digits (for example, X'8',X'E') to identify the starting and ending heads to be examined. If you specify only one value, ICKDSF takes the value to be the starting range and defaults the ending range to the device maximum.</p> <p>If you specify HEADRANGE and do not specify CYLRANGE, the specified heads for all the cylinders on a volume or minidisk are processed.</p> <p>For information on specifying the starting and ending cylinders (CYLRANGE) to go with the starting and ending heads, see “CYLRANGE parameter: specify a range of cylinders” on page 140.</p> <p>For information on specifying part of a volume, see “RANGE parameters: specifying part of a volume” on page 154.</p>
Default:	None.
Restrictions:	<p>The starting value is required for HEADRANGE. If you do not specify an ending value, the highest head is used as the ending value.</p> <p>HEADRANGE:</p> <ul style="list-style-type: none"> • Cannot be specified with FROMRANGE/TORANGE • Applies only when VALIDATE is specified • Is not valid for the minidisks

INDEXINOINDEX parameter: creating a VTOC index



Parameter/ Abbreviations	Description
INDEX(<i>cylinder,head</i> [, <i>extent</i>])	<p>Specifies the starting location and size of the index data set. Values for subparameters <i>cylinder</i> and <i>head</i> are required; specification of <i>extent</i> is optional.</p> <p>For <i>cylinder,head</i>, specify decimal (n) or hexadecimal numbers (for example, X'1AB',X'E') to identify the cylinder and head, where the index is to start.</p> <p>For <i>extent</i>, specify decimal (n) or hexadecimal numbers (for example, X'E') for the number of tracks that are to be reserved for the index data set. If you specify cylinder and head but not extent, extent will be calculated based on the size of the VTOC.</p> <p>The default name of SYS1.VTOCIX.volser is used as the VTOC index name. If the <i>volser</i> begins with a numeric character, the default data set name will be SYS1.VTOCIX.Vxxxxx. For example, if the <i>volser</i> is 339001, the default data set name is SYS1.VTOCIX.V39001. For more information about indexed format VTOCs, see Appendix C, “VTOC index.”</p> <p>If you issue: INDEX(10,11,12) the index will be placed starting at cylinder 10, track 11 for a total of 12 tracks. Expressed in hexadecimal: INDEX(X'A',X'B',X'C')</p>
NOINDEX NIX	Use this parameter when you do not want ICKDSF to generate an index.
Default:	<p>If DOSVTOC or VSEVTOC is specified, the default is NOINDEX. Otherwise the default is INDEX.</p> <p>When the index parameter is defaulted, the index is generated starting at the track following the end of the VTOC with a size equal to the number of tracks per cylinder; that is, the index follows the VTOC. However, if you specify VTOC(END), the default index is located in the previous cylinder that precedes the VTOC and uses the whole cylinder.</p>

INIT command—CKD

Parameter/ Abbreviations	Description
Restrictions:	<p>Specification of the INDEX parameter is invalid with the VSEVTOC or DOSVTOC parameters.</p> <p>The STORAGEGROUP and NOINDEX parameters are mutually exclusive. For devices that have the ability to be configured as small volumes, do not use the ICKDSF default sizes if the volume is too small for them. The size must be specified to fit within the size of the device configured.</p>
Note:	The system generates SYS1.VTOCIX.volser as the name of VTOC index unless the volser begins with a numeric character, in which case the convention is SYS1.VTOCIX.Vxxxxx, where xxxxx is the volser with the first character overlaid by V.

IPLDD parameter: write a user-supplied IPL program on the volume

Parameter/ Abbreviations	Description
IPLDD({ <i>dname</i> / <i>sysin</i> }[OBJFORMAT ABSFORMAT])	
IPLDD IPL	Allows you to supply an IPL program to be written on the volume or minidisk during initialization. For more detailed information, see “Writing an IPL program on the volume with IPLDD” on page 145.
OBJFORMAT OBJECT OBJ	<p>Specifies that IPL data is being supplied in object deck format; that is, cards will have one of the following strings of EBCDIC characters in columns 2 through 4:</p> <p style="margin-left: 40px;">TXT RLD ESD END</p> <p>Note that only cards with TXT will be processed. All others will be ignored.</p>
ABSFORMAT ABSOLUTE ABS	Specifies that IPL data is being supplied as variable-length records that contain executable instructions. For more detailed information, see “Supplying variable-length records as IPL data” on page 145.
Default:	OBJFORMAT
Restrictions:	<p>The system provides special IPL bootstrap records if you specify the IPLDD parameter without specifying the BOOTSTRAP parameter.</p> <div style="display: flex; align-items: center; margin-bottom: 10px;"> <div style="background-color: black; color: white; padding: 2px 5px; margin-right: 10px;">CMS</div> <div style="background-color: black; color: white; padding: 2px 5px; margin-right: 10px;">SA</div> <div style="margin-left: 10px;">In the CMS or Stand-Alone versions, the <i>dname</i> subparameter of IPLDD must be SYSIN.</div> </div> <p>When an IPL program is included in the SYSIN stream, it must immediately follow the INIT command and end with an ENDIPLTEXT card. The ENDIPLTEXT card is optional when the IPL program is in a data set other than the one specified by SYSIN or when the end-of-file indicator (/*) immediately follows the data for the IPL program.</p> <p>The IPLDD parameter is not valid for 3995-151 or 3995-153.</p> <p>IPLDD is not valid in the VSE environment.</p>

NOCHECK parameter: surface checking of the volume

Parameter/ Abbreviations	Description
NOCHECK NOCHK NCHK	Indicates that you do not want the tracks to be surface checked for recording errors during initialization. Initialization will be done at the medial or minimal level only, depending on the VALIDATEINOVALIDATE specification.
Default:	NOCHECK
Restrictions:	The CHECK parameter is no longer supported.

Writing an IPL program on the volume with IPLDD

The following is an explanation of the results you can expect from the IPLDD and BOOTSTRAP parameters:

- If you specify IPLDD but do not specify BOOTSTRAP, ICKDSF supplies an IPL bootstrap that is written on the volume or minidisk during initialization together with the IPL text you supply.
- If you specify IPLDD and BOOTSTRAP, ICKDSF uses the IPL bootstrap and the IPL text you supply. If necessary, ICKDSF updates the bootstrap records to allow for possible user labels.
- If you do not specify IPLDD, ICKDSF writes special bootstrap records that cause the processing unit to be placed in a WAIT state if the volume or minidisk is specified during an attempt to load the system. Bit 12 of the wait state PSW is set on.

The maximum size permitted for the IPL program record depends upon the type of volume being initialized. The maximum sizes allowed are:

Table 37. Maximum size permitted for the IPL program record

Volume Type	Maximum Bytes for IPL Program
3375	33 984
3380	44 948
3390 (3380 mode)	44 948
3390	53 450
9345	49 938

Also, the number of additional user volume labels can further limit the size allowed for the IPL program. If you supply an IPL program that exceeds the size allowed, you receive an error message but initialization continues.

MVS

With the MVS version, use *dname*. For *dname*, substitute 1 to 8 alphanumeric characters for the DD statement identifying the data set that contains the IPL program you want written on the volume (or minidisk) being initialized. The IPL program can be included within the MVS JCL input stream (SYSIN). If the IPL program is in the MVS JCL input stream, the data must be included immediately after the INIT command.

CMS

SA

With the CMS or Stand-Alone versions, use *sysin*. It must be the same device as the input device. The data must immediately follow the INIT command and end with an ENDIPLTEXT card. In a VM environment, the IPLDD data must be contiguous to the INIT command.

Supplying variable-length records as IPL data

ABSFORMAT specifies that IPL data is being supplied as variable-length records that contain executable instructions. When IPL data is supplied in this format, it is necessary to provide a minimum of three records. The maximum number of records supplied and their lengths are limited only by the track capacity of the volume or minidisk on which these records are to be written.

The first two records supplied must be the bootstrap records and are restricted to lengths of 24 and 144 bytes, respectively.

The contents of the IPL records and the contents of the program are not checked by ICKDSF. It is the user's responsibility to ensure that the IPL records can load an executable program. The first IPL record must contain a PSW followed by two CCWs (channel command words). The following is an example of CCWs in an IPL record:

INIT command—CKD

First CCW 06xxxxxx 60000090
Second CCW 08xxxxxx 00000000

The first CCW is a command to read in the second IPL record at main storage address xxxxxx. The second CCW is a transfer-in-channel command (a branch) to the CCW that begins the second IPL record.

The second IPL record must be 144 bytes long. Bytes 32 through 42 (starting from byte 0) cannot be used. Bytes 32 through 42 are used by ICKDSF for the seek address (bytes 32 through 37) and the CCHHR (bytes 38 through 42) of the third IPL record.

The third through nth records that are supplied are assumed to be IPL program records and will be written on the volume, without any modification, after the standard volume label and any existing user volume labels. Note that the IPL program will be written only on the first track of the pack. If the records supplied exceed in length the remaining space on the first track, the function will end with an error message.

LABELS parameter: reserve space for additional volume labels

Parameter/ Abbreviations	Description
LABELS(<i>n</i>) LABEL LBL	Specifies that space on cylinder 0, track 0 is to be reserved for additional volume labels, also known as user volume labels. In addition to the label that must be written on the volume, a maximum of nine additional volume labels can be specified. To specify <i>n</i> , substitute a decimal number from 1 through 9 for the number of additional user volume labels to be placed on the volume during initialization.
Default:	None.
Restrictions:	If LABELS is not specified, user volume labels that existed from a previous initialization are destroyed. If a value greater than 9 is specified with the LABELS parameter, the INIT command ends.

MAPINOMAP parameter: print a volume map

Parameter/ Abbreviations	Description
MAP	Prints a volume map during initialization. The volume map lists tracks that are found to be defective or inconsistent during initialization.
NOMAP	Indicates that you do not want to print a volume map during initialization.
Default:	MAP
Restrictions:	Potential entries in the MAP are limited to the scope of tracks that were referenced during processing. For minimal initialization, referenced tracks include only the alternate tracks and any primary tracks that might be associated with them. For medial and maximal initialization, this also includes all tracks in the specified range. Note that if there are primary tracks incorrectly associated with alternates, that information is not available in a minimal initialization MAP. MAP is ignored for 9391, 9393, 9396, 9397, Internal Disk devices, 2105, and minidisks. Note: The MAP parameter is ignored for devices that do not have alternate tracks.

MIMIC parameter: specify a special volume usage format



Table 38. Mimic parameter for the INIT command

Parameter/ Abbreviations	Description
MIMIC(<i>type</i>)	Specifies a special usage format for the volume being initialized. For <i>type</i> , specify MINI(n), EMU(n), or EMUALL.
MINI(n)	<p>Indicates that a minidisk is to be initialized. <i>n</i> represents the number of cylinders that are to comprise the minidisk. For more information, see Chapter 7, “Getting started with the Stand-Alone version.”</p> <p>The MINI(n) parameter is valid in the Stand-Alone version only. You must specify the DEVICETYPE parameter with MINI(n). MINI(n) should be used only with minimal INIT for all devices.</p> <p>VM If media maintenance functions are required on a device in the VM environment, the device must be dedicated to the user ID that is executing ICKDSF. MIMIC(MINI(n)) is not required when running Stand-Alone under the VM operating system.</p>
EMU(n)	Indicates that a partial CKD disk emulated on a 3370 FBA device is to be initialized. In the Stand-Alone version, you must also specify the DEVICETYPE parameter.
EMUALL	Indicates that a full CKD disk is emulated on a 3370 FBA device.
Default:	None.
Restrictions:	<p>If EMU(n) or EMUALL is specified for an emulated device, validation and surface checking functions are bypassed. Data checks should be handled using the INIT command against the base FBA device.</p> <p>CMS MIMIC is not valid in the CMS version.</p> <p>When you emulate a CKD device on the 9313, 9332, or 9335, do not use MIMIC(EMU) or MIMIC(EMUALL). For more information, see “Initializing an emulated CKD Device on an IBM 9313, 9332, or 9335 FBA device” on page 85.</p> <p>To change the mode of an IBM 3390 to either 3390 mode or 3380 track compatibility mode, use INSTALL SETMODE, not INIT.</p>

OWNERID parameter: specify the owner identification

Parameter/ Abbreviations	Description
OWNERID(<i>owner</i>) OWNER	<p>Writes the owner identification in the volume or minidisk label.</p> <p>For <i>owner</i>, substitute 1 to 14 alphanumeric characters for the owner identification to be written in the volume or minidisk label.</p>
Default:	<p>The default for <i>owner</i> during a first-time initialization is 14 blanks.</p> <p>If you do not specify OWNERID when reinitializing a previously initialized volume, the owner identification remains unchanged.</p>
Restrictions:	None.

PASSWORDS parameter: provide passwords for data set security

Parameter/ Abbreviations	Description
PASSWORDS ((<i>dsname/password</i>),...)	Specifies passwords for non-VSAM password-protected data sets. The supplied passwords will be used to determine if the user has authority to alter the data sets.
PASSWORD PASSWD PWD PD	For <i>dsname</i> , substitute the fully qualified name of a password-protected data set. For <i>password</i> , substitute the password you wish to apply to this data set.
Default:	None.
Restrictions:	<p>Up to a maximum of 512 passwords may be specified.</p> <p>This parameter is ignored in the CMS, VSE, and Stand-Alone versions.</p>

PURGEINOPURGE parameter: write over previously written data

Parameter/ Abbreviations	Description
PURGE PRG	Indicates that you want to write over the data in the following types of data sets during initialization: Unexpired VSAM Password-protected RACF-protected A volume that appears to contain real data cannot be initialized unless the PURGE parameter is specified. For more information about the actions taken when certain types of data are found on the volume, see “Protecting MVS volumes and data sets” on page 31.
NOPRG NPRG	Indicates that you do not want to write over existing data. If a volume appears to contain real data, it cannot be initialized unless the PURGE parameter is specified in the VSE environment. In the MVS environment, the volume can be initialized even with NOPURGE specified, if the user is authorized.
Default:	NOPURGE
Restrictions:	The NOPURGE parameter does not apply in offline mode or in the CMS or Stand-Alone versions. If you initialize a volume in offline mode or in the CMS or Stand-Alone versions, all existing data on the volume is purged, regardless of the data set security attributes.

STORAGEGROUP parameter: initialize a volume that is system-managed

Although STORAGEGROUP is valid only in an MVS operating environment, you can issue it with the MVS, CMS, and Stand-Alone versions of ICKDSF.

Parameter/ Abbreviations	Description
STORAGEGROUP STGR SG	Specifies that the volume to be initialized is to be in a DFSMS environment.
Default:	None.
Restrictions:	The STORAGEGROUP parameter and the NOINDEX parameter are mutually exclusive.

TORANGE parameter: specify a specific ending location

Parameter/ Abbreviations	Description
TORANGE(<i>cylinder,head</i>) TOR TO	Use this parameter to specify the ending track (<i>cylinder and head</i>) to be examined before minimal volume initialization is performed. For <i>cylinder,head</i> , substitute the decimal (<i>n</i>) or hexadecimal digits (for example, X'2AB',X'E') to identify the cylinder and head where processing is to end. If you specify only one value, ICKDSF takes it to be the cylinder and defaults the head to the device maximum. If you specify TORANGE and do not specify FROMRANGE, FROMRANGE is defaulted to cylinder 0, head 0 of the specified or minidisk. For information on specifying the starting track of part of a volume (FROMRANGE), see “FROMRANGE parameter: specify a specific starting location” on page 142. For information on specifying part of a volume, see “RANGE parameters: specifying part of a volume” on page 154.
Default:	None.
Restrictions:	Valid only when VALIDATE is specified.

VALIDATE/NOVALIDATE parameter: validate home address/record 0

Parameter/ Abbreviations	Description
VALIDATE VAL	Performs a medial initialization when NOCHECK is specified. The home address and record 0 for each track in the specified range are read, validated, and rewritten. The data remaining on a track is erased. VALIDATE is less time-consuming than surface checking.
NOVALIDATE NOVAL NVAL	Indicates that you do not want to validate the home address and record 0 for each track during initialization. When you specify NOVALIDATE with the NOCHECK parameter, you initialize the volume at the minimal level.
Default:	NOVALIDATE
Restrictions:	VALIDATE is not valid for minidisks, 3995-151, 3995-153, and real 3390-9.

VOLID parameter: specify the volume serial number

Parameter/ Abbreviations	Description
VOLID(<i>serial</i>)	Writes the volume serial number in the volume or minidisk label. For <i>serial</i> , substitute 1 to 6 alphanumeric characters for the volume serial number. If fewer than six characters are specified, the serial is left-justified, and the remainder of the field is padded with blanks (X'40').
Default:	When you initialize a volume or minidisk that was previously initialized and do not specify the VOLID parameter, the old volume serial number remains unchanged.
Restrictions:	You cannot change the volume serial number of an online MVS volume. You must vary the volume offline to change the volume serial number.

VTOC parameter: specify the volume table of contents



Table 39. VTOC parameter for the INIT command

Parameter/ Abbreviations	Description
VTOC(ENDDISK/ <i>cylinder,head[,extent]</i>)	Specifies the location and size of the volume table of contents, or that the volume and VTOC are to be formatted for open-system use. Identify the <i>cylinder</i> and <i>head</i> , by specifying decimal (n) or hexadecimal numbers (for example, X'1AB',X'0') where the volume table of contents is to be placed. For <i>extent</i> , specify decimal (n) or hexadecimal numbers (for example, X'E') for the number of tracks that are to be reserved for the volume table of contents. For information on specifying the size of the VTOC index, see Appendix C, "VTOC index." When you specify VTOC(END), the VTOC is put on the last primary cylinder of the volume (or minidisk) and is one cylinder in length. Specify VTOC(OPENDISK) to indicate that the volume and VTOC should be formatted for use as an open-system DASD that is formatted for the 9399 IBM Cross Platform Extension.

INIT command—CKD

Table 39. VTOC parameter for the INIT command (continued)

Parameter/ Abbreviations	Description
Default:	<p>The default for <i>cylinder,head</i> is 0,1.</p> <p>If you do not specify VTOC, DOSVTOC, or VSEVTOC, the default is an MVS VTOC at cylinder 0, track 1.</p> <p>If you do not specify VTOC, DOSVTOC, or VSEVTOC, and the device is not a minidisk, the size is defaulted to the number of tracks in a cylinder minus 1. For a 3390, the default is cylinder 0, track 1 for 14 tracks.</p> <p>If you specify cylinder and head but not the extent, the default for extent is one track. The default extent for minidisks is one track.</p>
Restrictions:	<ul style="list-style-type: none">• A VTOC cannot be placed at cylinder 0, track 0.• For the devices containing more than 64K tracks, the ending location of the VTOC must be below the 64K track line. For example, VTOC(4369,1,1) or above, are not valid (see the note below).• VTOC(END) is not valid for devices containing more than 64K tracks.• When VTOC(OPENDISK) is specified:<ul style="list-style-type: none">– The following devices are supported, ONLY when the device is in 3390 track format, and ONLY when the device is operating as a real or emulated 3390 model 3 DASD.<ul style="list-style-type: none">- 3390 model 3 (attached to 3990 model 6 unit only)- RAMAC 9391 DASD (attached to 3990 model 6 or 9390 control unit)- RAMAC Virtual Array (9393)- RAMAC Scalable Array (9396)– The following parameter restrictions apply:<ul style="list-style-type: none">- INDEX, IPLDD, FROMRANGE, TORANGE, CYLRANGE, HEADRANGE, VALIDATE, MIMIC, DATA, BOOTSTRAP, NOINDEX, STORAGEEGROUP are not allowed with VTOC(OPENDISK).- CONTINUE, NOCONTINUE parameters are ignored. Checkpoint recovery may take place for a previous checkpoint, but the volume formatting will then resume from the beginning of the volume to ensure every track on the volume has the proper format.– The volume is initialized as a non-SMS volume. If an SMS volume is desired, the volume must be varied online and a DFSMSdss CONVERTV can be run against the volume. <p>For devices that have the ability to be configured as small volumes, do not use the ICKDSF default sizes if the volume is too small for them. The size must be specified to fit within the size of the device configured.</p> <p>Note: For devices containing more than 64K tracks, there are special considerations for VTOC placement. The existing IBM software uses relative track addressing or the Track-Track-Record (TTR) format to process the VTOC. This restricts the highest address that can be referenced as a VTOC track to be 64K-1. Because of this, the entire VTOC must reside within the first 64K tracks; that is, the VTOC must end before cylinder 4369 (X'1111') head 1.</p> <p>The VTOC placement restriction does not apply to the INDEX. The INDEX may be placed above the 64K track limit.</p>

Initializing volumes

You use the INIT command to initialize volumes. There are three levels of initialization:

- Minimal initialization or minimal INIT
- Medial initialization or medial INIT
- Initialization for open-system DASD

Minimal initialization

A **minimal initialization** refers to using the INIT command to write a volume label and a VTOC on the device for use by MVS or VSE operating systems. Optionally, the minimal INIT writes other items that are needed by your operating environment, such as IPL text.

A volume is always initialized at least to the minimal level. When both the NOVALIDATE and NOCHECK parameters are specified, minimal initialization is all that is performed.

Minimal initialization creates the contents of cylinder 0, track 0 by writing:

IPL bootstrap records as records 1 and 2

A volume label as record 3

IPL text (optional)

Initialization also reserves and formats tracks for the VTOC at the location specified by the user and for the number of tracks specified. If no location is specified, tracks are reserved at the default location. The size and location can also be defaulted to the end of the volume. Access to a previous VTOC is destroyed by a minimal INIT; however, residual data can remain from previous use.

If the INDEX parameter of the INIT command is specified, the default data set name of SYS1.VTOCIX.volser is used in the VTOC to identify the space. If the *volser* begins with a numeric character, the default data set name will be SYS1.VTOCIX.Vxxxxx, where xxxxx is the volser with the first character overlaid by V. For example, if the *volser* is 339001, the default data set name is SYS1.VTOCIX.V39001. For more information about indexed format VTOCs, see Appendix C, “VTOC index.”

If the IPLDD parameter is specified, the IPL text is added to the volume.

At the completion of the minimal initialization, defective primary tracks that were using an alternate are now assigned alternates in sequential order within the alternate track area.

Minimal initialization is the only level supported for dual copy volumes.

Medial initialization

Medial initialization includes the actions of minimal initialization, and the validation of the existence and content of the track's home address and record 0 for every track in the specified range. Validation ensures that the proper track address (cylinder and head) appears in both the home address and record 0 on the track, and that a standard record 0 exists on the track. Validation rewrites the home address and record 0.

A volume is initialized at the medial level when both the VALIDATE and NOCHECK options are specified.

At the completion of the medial initialization processing for the requested tracks, defective primary tracks that were using an alternate are now assigned alternates in sequential order within the alternate track area.

If a medial initialization does not run to completion, the CONTINUE function is provided to allow you to recover in a minimum amount of time, and to ensure the

INIT command—CKD

volume is usable. For more information concerning continuing after a failure, see “Resuming after a job or system failure” on page 154.

When you are performing a medial initialization for a CKD device that is being emulated on an IBM 9313, 9332, or 9335, the CONTINUE function is not supported and range parameters are ignored.

Before running a medial initialization (or any ICKDSF job), the devices must establish thermal stability. For more information, see “Devices supported by ICKDSF” on page 6.

Medial initialization is not supported for dual copy volumes or real 3390-9 devices.

Initialization for open-system DASD

Initialization for open-system DASD formats the volume and VTOC for use as an open-system DASD.

When VTOC(OPENDISK) is specified, formatting is performed, and required files are created for use with the 9399 IBM Cross Platform Extension.

Some restrictions apply when specifying VTOC(OPENDISK). Refer to the VTOC parameter for information on device types supported and the list of parameters that are not allowed with VTOC(OPENDISK).

When VTOC(OPENDISK) is specified, the CONTINUE, NOCONTINUE parameters are ignored. Checkpoint recovery may take place for a previous checkpoint, but the volume formatting will then resume from the beginning of the volume to ensure every track on the volume has the proper format.

A 1 track VTOC, and a 1 track VTOC index data set are created on cylinder 0. Some free space is left on cylinder 0 in case a VVDS needs to be created on the volume later. The VTOC is created to indicate that the remaining tracks on the volume are allocated.

The volume is initialized as a non-SMS volume. If an SMS volume is desired, the volume must be varied online and a DFSMSdss CONVERTV can be run against the volume.

Note: Existing ICKDSF commands that are supported on the device will be allowed to run on these volumes. The storage administrator must manage which ICKDSF commands are executed on these devices, because other ICKDSF functions can change the format of the volume or tracks. Some examples of this for an open-system formatted volume (but not the only cases) are:

- INSPECT NOPRESEVE will not save data on the track being inspected and will result in the format of the track as well as the data being destroyed.
- Depending on the parameters used, the BUILDIX and REFORMAT commands may result in a volume without an index.

When other ICKDSF commands are executed on an open-system formatted volume, the storage administrator may need to take additional steps to rebuild the VTOC index or restore the format and/or the data on one or more tracks. The storage administrator should set up procedures to handle situations when other ICKDSF functions are necessary on the volume.

Processing in a shared environment

When running a minimal INIT on a volume shared between systems, follow these guidelines:

1. Vary the device offline to the other systems.
2. Run the INIT command.
3. Format your volume for your operating system.
4. Vary the device back online to the other systems.

The other systems will then recognize the volume serial number and other system operating information of the volume. If you do not follow these guidelines, other systems accessing the volume may experience unpredictable results.

Processing in a shared DFSMS environment



If the volume to be initialized is system managed and shared between systems, then use one of the following methods:

- Spare or Empty Volume
 1. Vary the device offline to the other systems.
 2. Run the INIT command.
 3. Vary the device back online to the other systems.
 4. Define the volume to the storage group for use.
- Volume in Use
 1. Move data sets from the volume to be reinitialized to other volumes in the storage group.
 2. Change DFSMS status of the storage group from ENABLE to DISNEW for all systems. This will prevent new allocations to the storage group and, in particular, to the volume to be reinitialized.
 3. Vary the device offline to other the systems.
 4. Remove the volume definition from the storage group.
 5. Change DFSMS status of the storage group from DISNEW to ENABLE for all systems.
 6. Run the INIT command specifying VTOC index.
 7. Vary the device back online to the other systems.
 8. Define the volume to the storage group for use.

System-managed volume initialization

You can initialize a volume that is to be managed in a DFSMS environment by specifying the STORAGEEGROUP parameter.

ICKDSF marks the volume as being system managed during the initialization process. It also informs the operating system that the volume has been initialized for a DFSMS environment. If the volume you are initializing is online, ICKDSF will:

- Bypass RACF DASDVOL checks
- Check that there are no system-managed data sets on the volume

You can initialize previously system-managed volumes as system managed or nonsystem-managed.

Resuming after a job or system failure

If for any reason a medial initialization does not run to completion, subsequent processing can start from a checkpoint location. ICKDSF checkpoints itself automatically during processing and remembers where to resume processing.

After a job or system failure, you can submit a new job:

- At the minimal or medial level
- For the entire volume, or for a different specified range, or the same specified range (for medial INIT)
- To resume from the point of failure, or to ignore the previous processing and start to process a different range

Regardless of the job you choose to run after a failure, when processing completes, all tracks on the volume that ICKDSF might have operated on are in a usable condition. Note that, while ICKDSF will fix any tracks that were left unusable because of the failure, it cannot ensure the usability of any track that is not in the current specified range or that was not processed before the point of failure.

Because INIT processing always destroys the volume label, a subsequent invocation must include the VOLID parameter.

INIT checkpoints its current location not more than every 5 minutes. When INIT is run after a previous failure, it detects the checkpointed information, and then validates or skip analyzes (depending on the device type that failed) all the tracks from the last checkpoint. This is done for all levels of initialize, regardless of the CONTINUEINOCONTINUE parameters. This ensures that ICKDSF has not left any tracks in an unusable condition because of the failure. Note that this adds additional run time to INIT and is most noticeable for minimal INIT.

After the tracks from the previous point of failure have been processed, if CONTINUE is specified, processing continues from the point of failure in correlation with the current specified range as follows:

- If the new range is entirely before the previous point of failure, no new tracks are processed.
- If the new range is entirely beyond the adjusted point of failure, then the entire new range is processed.
- The point of failure is adjusted if the new job specifies VALIDATE, since we have already validated the tracks to the next checkpoint location.
 - If the new job specifies a range that is entirely before where the next checkpoint should occur, there are no more tracks to process.
 - If the new job specifies a range that overlaps the point of failure, then processing begins from the point of failure.
- If NOCONTINUE is specified, processing begins with the first track in the current specified range.

RANGE parameters: specifying part of a volume

CYLRANGEIHEADRANGE, and FROMRANGEITORANGE are optional parameters, used to limit the areas of a volume or minidisk that are to be processed.

CYLRANGEIHEADRANGE –Specifies the starting and ending cylinders and starting and ending heads to be examined before minimal initialization.

FROMRANGEITORANGE –Specifies the starting track (cylinder and head) and the ending track (cylinder and head) to be examined before standard volume initialization.

Note that the VTOC and volume label are still written even when range parameters are specified.

The term “specified range” is used in this book to describe the tracks that are the result of the:

- Combination of FROMRANGE and TORANGE, or
- Combination of CYLRANGE and HEADRANGE, or
- Entire volume, if all the range parameters are omitted.

The following table shows the parameter conditions when specifying part of a volume.

Table 40. Parameter conditions when specifying part of a volume

Parameter	Other Notes
CYLRANGE	If you specify CYLRANGE and do not specify HEADRANGE, all the heads of the specified cylinders are processed. If you specify an ending value greater than the maximum for the device, the device (minidisk) maximum is used for the ending value.
HEADRANGE	If you specify HEADRANGE and do not specify CYLRANGE, the specified heads for all the cylinders on the volume (minidisk) are processed. If you specify an ending value greater than the maximum for the device, the device (minidisk) maximum is used for the ending value.
FROMRANGE	If you specify FROMRANGE and do not specify TORANGE, TORANGE is defaulted to the last cylinder of the device (minidisk).
TORANGE	If you specify TORANGE and do not specify FROMRANGE, FROMRANGE is defaulted to cylinder 0, track 0 (starting cylinder and track of the minidisk)

Notes:

1. CYLRANGEIHEADRANGE and FROMRANGEITORANGE are mutually exclusive pairs.
2. Primary tracks within the range specified have alternate tracks assigned as necessary.
3. Primary tracks outside the range specified are not read or validated and do not have their alternate track pointers verified.
4. If there is a need to verify the alternate tracks on a volume (that is, primary/alternate pairs are valid), you can specify the range parameters for the alternate cylinders.

If you specify:

NOCHECK VALIDATE

NOCHECK NOVALIDATE

No range parameters

Then...

The home address and record 0 are rewritten only for those tracks within the range.

The range parameters are ignored.

For medial initialization, operate on the entire volume.

CMS version minidisk support

CMS For the CMS version of ICKDSF, only minimal INIT is supported.

When you initialize a minidisk at the minimal level, you can specify the minidisk volume label (VOLID), the VTOC, the index data set (INDEX), the owner identification (OWNERID), and whether you or the system will supply the IPL bootstrap records.

The following INIT parameters are supported by the CMS version of ICKDSF:
UNITADDRESS, BOOTSTRAPINBOOTSTRAP, DOSVTOC, INDEXINOINDEX, IPLDD, LABELS, OWNERID, PASSWORD, PURGE, VERIFY, VOLID, and VTOC

For more information about running the CMS version, see Chapter 5, “Getting started with the CMS version.”

Restoring FFVDP to a volume

If you need to ensure that data exists on every track of an IBM 3375, 3380, 3390, 9394, 9391, or 9345 volume (for example, for a subsequent ANALYZE SCAN after a volume has been moved elsewhere), the DATA parameter can be used. When you specify DATA, records are written that correspond to the FFVDP, which are written on the volume at the factory.

Dual copy volumes

Minimal initialization is the only level supported for dual copy volumes. The volume must be in duplex or suspended duplex state. Medial initialization requires the volume to be in simplex state.

Examples of the INIT command

The following examples show different ways to code the INIT command.

Any values specified here are examples only and should not necessarily be interpreted as the values for your system. Most examples are for the offline and online modes of MVS.

CMS

SA

To initialize a volume in the Stand-Alone version:

1. Eliminate the MVS JCL.
2. Substitute the UNITADDRESS parameter for the DDNAME parameter.
3. Specify the DEVICETYPE parameter if the MIMIC(MINI) or MIMIC(EMU) parameter is also specified.
4. Use SYSIN if the IPLDD parameter is specified.

VSE

To initialize a VSE version volume:

1. Replace the MVS JCL statements with VSE system control statements.
2. Substitute the SYSNAME parameter for the DDNAME parameter.
3. Introduce the VSEVTOC or DOSVTOC parameter if a VSE type VTOC is required on the volume.

Initializing volumes for the MVS operating system

MVS

The following examples show you how to initialize volumes for use in the MVS operating system.

Initializing a volume for the first time in offline mode

In this example, a volume is initialized at the minimal level because the VALIDATE parameter is not specified. Because the volume is being initialized for the first time, it must be mounted offline, and the volume serial number must be specified. Because the VTOC parameter is not specified, the default volume table of contents size is the number of tracks in a cylinder minus one. For a 3390, the default is cylinder 0, track 1 for 14 tracks.

```
//EXAMPLE JOB
// EXEC PGM=ICKDSF
//SYSPRINT DD SYSOUT=A
//SYSIN DD *
INIT UNITADDRESS(0353) NOVERIFY VOLID(VOL123) -
    OWNERID(PAYROLL)
/*
```

Initializing two volumes in offline mode

In this example, the VALIDATE parameter in the first INIT command causes medial level initialization. The volume serial number is verified before initialization continues and is then replaced by the number supplied in the command. A default volume table of contents size is the number of tracks in a cylinder minus one. For a 3390, the default is cylinder 0, track 1 for 14 tracks. Four user volume labels are written in addition to the volume label. Because the volume is being reinitialized in offline mode, all existing data is purged, regardless of whether it is unexpired or password protected. The IPLDD parameter specifies that a user-supplied IPL program is to be written, and the BOOTSTRAP parameter specifies that the bootstrap records are also user supplied. (The IPL program and bootstrap records are indicated by the vertical ellipsis.)

The second INIT command initializes a volume at the minimal level. The volume serial number and owner identification remain unchanged. A default volume table of contents size is the number of tracks in a cylinder minus one. For a 3390, the default is cylinder 0, track 1 for 14 tracks. Because the volume is being reinitialized in offline mode, all existing data is purged, regardless of whether it is unexpired or password protected.

```
//EXAMPLE JOB
// EXEC PGM=ICKDSF
//IPLDECK DD *
:
/*
//SYSPRINT DD SYSOUT=A
//SYSIN DD *
INIT UNITADDRESS(0353) VALIDATE VOLID(AAA789) -
    OWNERID(SMITH) VERIFY(XYZ123) -
    IPLDD(IPLDECK) BOOTSTRAP LABELS(4) NOMAP
INIT UNITADDRESS(0271) NOVERIFY
/*
```

Initializing a volume using the VTOC(OPENDISK) parameter

In this example, the VTOC(OPENDISK) parameter is used to initialize a volume under MVS. Because the volume is being initialized in offline mode, all existing data is purged, regardless of whether it is unexpired or password protected.

INIT command—CKD

```
//EXAMPLE JOB
//          EXEC PGM=ICKDSF
//SYSPRINT DD  SYSOUT=A
//SYSIN DD *
INIT UNITADDRESS(0F40) VERIFY(339003) VOLID(339003) VTOC(OPENDISK)
/*
```

Initializing a volume in offline mode without operator's intervention

In this example, a volume is reinitialized at the minimal level. The VOLID is specified; the volume serial will be changed. Because the VERIFY(volser) parameter is specified in INIT and 'NOREPLYU' is specified in the JCL, no reply U or T is necessary. If either one of the parameters is not specified, the user will be prompted for a reply U or T.

Changing valid with the INIT command can only be done in the offline mode. Therefore if you are running in online mode, you have to vary off the device to change the volser then vary back online to resume normal operation.

```
//EXAMPLE JOB
//GENER1 EXEC PGM=IEBGENER
//SYSPRINT DD  SYSOUT=*
//SYSIN DD DUMMY
//SYSUT2 DD  SYSOUT=(A,INTRDR)
//SYSUT1 DD  DATA,DLM='$$'
//INIT1 JOB D77E,MSGCLASS=A,TYPRUN=HOLD
// VARY 0353,OFFLINE
//STEP1 EXEC PGM=IEFBR14
$$
//STEP2 EXEC PGM=ICKDSF,PARM='NOREPLYU'
//STEPLIB DD DSN=SYS1.LINKLIB,DISP=SHR,UNIT=3380,VOL=SER=USRPAK
//SYSPRINT DD  SYSOUT=A
//SYSIN DD *
INIT UNIT(0353) VFY(XYZ123) VOLID(ABC456)
/*
//GENER3 EXEC PGM=IEBGENER
//SYSPRINT DD  SYSOUT=*
//SYSIN DD DUMMY
//SYSUT2 DD  SYSOUT=(A,INTRDR)
//SYSUT1 DD  DATA,DLM='$$'
//INIT3 JOB D77E,MSGCLASS=A,TYPRUN=HOLD
// VARY 0353,ONLINE
//STEP3 EXEC PGM=IEFBR14
$$
```

Initializing a volume to be managed in a DFSMS environment

In the following example, a volume that is to be system managed is initialized. The volume is initialized in offline mode at the minimal level. The VTOC is placed at cylinder 2, track 1 and occupies ten tracks. The VTOC is followed by the VTOC index. The STORAGEGROUP parameter indicates the volume is to be managed in a DFSMS environment.

```
INIT UNIT(0353) NOVERIFY STORAGEGROUP -
OWNERID(PAYROLL) VTOC(2,1,10) INDEX(2,11,5)
```

Initializing a volume previously system-managed in a DFSMS environment

The following example initializes a volume that has been previously initialized for a DFSMS environment. The volume is initialized at the minimal level in online mode. The VTOC is placed at cylinder 10 track 1 and is allotted 20 tracks. The VTOC index is placed at cylinder 11, track 6 and is allotted ten tracks. The STORAGEGROUP parameter specifies that the volume is to be a system-managed

volume. When the OWNERID is specified, the owner is changed. If there are any data sets on the volume, a reinitialize cannot be performed.

To initialize a previously system-managed volume to a nonsystem-managed volume, do not include the STORAGEGROUP parameter in this example.

```
//EXAMPLE JOB
// EXEC PGM=ICKDSF
//DDN1 DD UNIT=3380,DISP=OLD,VOL=SER=XXX001
//SYSPRINT DD SYSOUT=A
//SYSIN DD *
INIT DDNAME(DDN1) NOVERIFY STORAGEGROUP -
OWNERID(DBGROUP) VTOC(10,1,20) INDEX(11,6,10)
/*
```

Initializing a volume with an index

This example performs an online minimal initialization, and as a result of the command, an index to the VTOC is created.

```
// JOB
// EXEC PGM=ICKDSF
//XYZ987 DD UNIT=3375,DISP=OLD,VOL=SER=PAY456
//SYSPRINT DD SYSOUT=A
//SYSIN DD *
INIT DDNAME(XYZ987) NOVERIFY INDEX(X'A',X'B',X'2')
/*
```

Initializing volumes with the Stand-Alone version



The following examples show you how to initialize volumes with the Stand-Alone version of ICKDSF.

Initializing a volume at the medial level

In this example, a previously initialized volume is reinitialized at the medial level because the VALIDATE parameter is specified. The home address and record 0 on each track are read and validated. The volume serial number and owner identification are verified before initialization continues and, because a new volume serial number or an owner identification is not specified, they remain unchanged on the reinitialized volume. Specification of the VTOC parameter causes a volume table of contents to be created at cylinder 42, track 12. The VTOC occupies three tracks. Because the volume is being reinitialized in the Stand-Alone version of ICKDSF, all existing data is purged, regardless of whether it is unexpired or password protected.

```
INIT UNITADDRESS(0272) -
VERIFY(VOL123,PAYROLL) VALIDATE VTOC(42,X'C',3)
```

Reinitializing a volume at the medial level

In this example, a previously initialized 3375, 3380, 3390, or 9345 volume is reinitialized at the medial level because VALIDATE is specified. DATA is also specified, causing the FFVDP to be written on the volume. The home address and record 0 on each track are read and validated. The volume serial number and owner identification are verified before initialization continues and, because a new volume serial number or an owner identification is not specified, they remain unchanged on the reinitialized volume. Because the volume is being reinitialized in the Stand-Alone version of ICKDSF, all existing data is purged, regardless of whether it is unexpired or password protected.

```
INIT UNITADDRESS(0272) VOLID(338001) VALIDATE DATA -
VERIFY(VOL222,MASTER)
```

INIT command—CKD

Initializing a minidisk

In this example, a 3390 minidisk is initialized with an IPL program. It provides 30 primary and no alternate cylinders on unit 151. The VTOC is written at a default location of cylinder 0, track 1 for a length of one track. The volume is labeled 339000. The IPL program supplied as the input deck is written on cylinder 0, track 0. The label and VTOC are written in MVS format.

```
INIT UNITADDRESS(0151) NOVERIFY DEVICETYPE(3390) -  
MIMIC(MINI(30)) VOLID(33900) IPLDD(SYSIN)
```

Initializing a minidisk in the CMS version

CMS

In this example, a minidisk is initialized at the minimal level. It establishes a VOLID, OWNERID, and the VTOC on a minidisk with a virtual address of 391. The VTOC is written at the default location of cylinder 0, track 1 of the minidisk for a length of one track. The minidisk is labeled 338012 and the owner ID is PAYROLL. The VTOC is written in MVS format.

After performing the INIT, the minidisk is ready for future use in an MVS operating system environment.

```
INIT UNITADDRESS(0391) NOVERIFY VOLID(338012) OWNERID(PAYROLL)
```

Initializing volumes with the VSE version

VSE

The following examples show you how to initialize volumes with the VSE version of ICKDSF.

Initializing a volume at the minimal level

In this example, a volume is initialized at a minimal level under VSE. A VSE format VTOC is written on cylinder 32, track 0 for a length of 20 tracks. The volume is labeled 338001.

```
// JOB      jobname  
// ASSGN   SYS002,151  
// EXEC    ICKDSF,SIZE=AUTO  
          INIT SYSNAME(SYS002) NOVERIFY -  
              VSEVTOC(X'20',X'0',X'14') VOLID(338001)  
/*  
/&
```

Initializing an emulated partial disk at the minimal level

In this example, an emulated partial disk is initialized under VSE. A VSE format VTOC is written at cylinder 0, track 1 for a length of one track. The volume is labeled AA3380.

```
// JOB      jobname  
// ASSGN   SYS000,353  
// EXEC    ICKDSF,SIZE=AUTO  
          INIT SYSNAME(SYS000) NVFY VSEVTOC(0,1,1) -  
              VOLID(AA3380) MIMIC(EMU(20))  
/*  
/&
```

Chapter 16. INSPECT command—CKD



The INSPECT command inspects a subset of a volume and can:

- Check the surface of a track to determine if there is a defect
- Assign a skip to avoid a defect
- Assign an alternate track
- Reclaim a track that has been flagged defective
- Print a map of defective tracks on a volume

Before using the INSPECT command, you should first make sure there are no hardware problems. It is recommended that you issue ANALYZE DRIVETEST NOSCAN before any INSPECT operation.

The INSPECT command does not support the 3995-151 and 3995-153 devices.

For more general information about INSPECT, see “Problem determination” on page 78.

For information on ICKDSF support of the 9391 and 9394, see “ICKDSF support of the RAMAC Array family” on page 8.

Protecting the INSPECT command with RACF

The MVS version of ICKDSF checks the general resource profile for a facility class profile of STGADMIN.ICK.INSPECT. If RACF is not installed or the facility STGADMIN.ICK.INSPECT is not created, the INSPECT command executes with no authorization check. For additional information, see “Protecting ICKDSF commands with RACF” on page 35.

Understanding which INSPECT parameters to use

You can perform several functions using INSPECT with various options. Table 41 shows you which parameters to use to perform certain tasks. For more details about these parameters, see the explanations that follow. The parameters appear in alphabetical order under “Optional parameters” on page 164.

Table 41. Performing tasks with INSPECT parameters

To...	Use the INSPECT parameter...
Surface check individual tracks or groups of tracks.	CYLRANGE/HEADRANGE FROMRANGE/TORANGE TRACKS
Check each track surface. Permit optional specification of the number of checking cycles of each inspected track.	CHECK Alternate track assignment is done only after an inspection of the surface reveals defects.
Suppress track checking.	NOCHECK Unless alternate track assignment is suppressed, an alternate will be unconditionally assigned to the primary track.

INSPECT command—CKD

Table 41. Performing tasks with INSPECT parameters (continued)

To...	Use the INSPECT parameter...
For the IBM 3375, 3380, 3390, and 9345, locate and skip over the defective areas on the track.	<p>CHECK</p> <p>Only when the primary track contains more than the maximum number of allowable defects is it considered defective.</p> <p>SKIP</p> <p>The SKIP parameter controls the level of surface checking performed and, consequently, the total execution time required to inspect individual tracks or groups of tracks.</p> <p>Note: The SKIP parameter is more extensive and takes much longer than NOSKIP.</p>
Save data that would normally be destroyed during the track inspection.	<p>PRESERVE KEEPIT HOLDIT</p> <p>The NOPRESERVE parameter allows inspection of tracks when the data cannot be read.</p> <p>Data Loss Warning:</p> <p>When you use HOLDIT, data is kept in storage only. If processing abnormally terminates before the data is rewritten, the track for which the data was preserved will not contain a standard record 0, and the data will be lost.</p>
Write a copy of the data at a backup location as well as keep it in storage.	<p>PRESERVE</p> <p>If processing ends abnormally, the next use of INSPECT detects the data at the backup location and automatically restores the data to the track on which processing previously ended abnormally.</p>
Reclaim a track that was previously flagged defective if the track inspection has determined it is currently defect-free.	RECLAIM
Suppress automatic track reclamation.	NORECLAIM
Fix 0F0B errors (defective track without valid alternate track pointer).	<p>TRACKS</p> <p>INSPECT TRACKS NOPRESERVE NOCHECK ASSIGN will rewrite the HA and R0 to fix the 0F0B error.</p>
Assign alternates if required.	ASSIGN
Suppress the assignment of alternates	NOASSIGN
Print output of the detailed status of each track being inspected.	MAP
Suppress the printed output of detailed track status.	NOMAP
<p>Note: When you are emulating CKD devices on IBM 0671, 3995-151, 3995-153, 9313, 9332, 9335, or 9336, you cannot use INSPECT for surface checking.</p>	

For information on ICKDSF support of the 9391 and 9394, see “ICKDSF support of the RAMAC Array family” on page 8.

Syntax

INSPECT
Required Parameters DDNAME(<i>dname</i>) SYSNAME(<i>sysxxx</i>) UNITADDRESS(<i>ccuu</i>) REALADDR(<i>ccuu</i>) VERIFY(<i>serial*NONE*</i> [<i>,owner</i>]) NOVERIFY
Optional Parameters ALLTRACKS ASSIGN NOASSIGN AVAILABLE CHECK (<i>n</i>) NOCHECK CYLRANGE(<i>start,end</i>) DEVICETYPE(<i>devtype</i>) DIRECTIO(PRIMARY SECONDARY) FORCE FROMRANGE(<i>cylinder,head</i>) HEADRANGE(<i>start,end</i>) MAP NOMAP MIMIC(<i>type</i>) PASSWORDS((<i>dsname/password</i>),...) PRESERVE KEEPIT NOPRESERVE HOLDIT RECLAIM NORECLAIM SKIP NOSKIP TOLERATE(ENQFAIL PRIFAIL) TORANGE(<i>cylinder,head</i>) TRACKS((<i>cylinder,head</i>)[<i>,...</i>]) USERID(<i>user's ID</i>)

Required parameters

DDNAME|SYSNAME|UNITADDRESS|REALADDR parameter: identify volume (or minidisk)

Parameter/ Abbreviations	Description
DDNAME(<i>dname</i>) DNAME	Required for an online MVS volume. Note that the volume must be online. For <i>dname</i> , specify the MVS JCL statement that identifies the volume.
SYSNAME(<i>sysxxx</i>)	Required for a VSE volume when executing ICKDSF in batch mode; the volume must be online. For <i>sysxxx</i> , specify the SYSNAME in the ASSGN system control statement.
UNITADDRESS(<i>ccuu</i>) UNITADDR UNIT	<p>Required for an offline MVS volume, a Stand-Alone volume, and an attached CMS volume. For VSE, it is required when executing ICKDSF in command mode; the volume must be online.</p> <p>In MVS, the volume must be on a path that is online. If the volume is on a path that is offline, the program might enter a nonterminating wait state. For <i>ccuu</i>, specify the address (3 or 4 hexadecimal digits) of the channel and unit of the volume.</p> <p>For the CMS version, specify the virtual address of the dedicated volume or minidisk.</p> <p>The unit address is the device number.</p>

INSPECT command—CKD

Parameter/ Abbreviations	Description
REALADDR(<i>ccuu</i>) RADDR	Used to specify the real address of a volume. This parameter is valid only when you are running the CMS version of ICKDSF and you have DEVMAINT authority. For <i>ccuu</i> , specify the real address (3 or 4 hexadecimal digits) of the channel and unit of the volume. REALADDR is mutually exclusive with UNITADDRESS, DDNAME, SYSNAME, and USERID.
Default:	None.
Restrictions:	None.

VERIFY/NOVERIFY parameter: verify volser and ownerid

Parameter/ Abbreviations	Description
VERIFY(<i>serial[,owner]</i>) VFY	Required when you want to verify the volume serial number and owner identification before inspecting a track on the volume or minidisk. If the volume serial number or owner identification does not match that found on the volume or minidisk, INSPECT ends. For <i>serial</i> , substitute 1 to 6 alphanumeric characters for the volume serial number. To verify that a volume serial number does not exist, substitute the string *NONE* for <i>serial</i> . If no volume serial exists, or if the volume serial is actually ""NONE"", the INSPECT operation continues. If a volume serial exists, the INSPECT command ends. For <i>owner</i> , substitute 1 to 14 alphanumeric characters for the owner identification. Running in the offline mode, if VERIFY(<i>serial</i>) parameter is specified in the INSPECT command and PARM='NOREPLYU' is specified in the EXEC card in the JCL, no operator's intervention (Reply U or T) is required.
NOVERIFY NOVFY NVFY	Required when you want to bypass verification of the volume serial number.
Default:	None. You must specify either VERIFY or NOVERIFY.
Restrictions:	You cannot verify the owner identification separately from the volume serial number. Both the volume serial number and the owner identification must be verified when you want to verify the owner identification. When you specify the VERIFY parameter and verification fails, the command terminates.

Optional parameters

ALLTRACKS parameter: inspect the total volume

Parameter/ Abbreviations	Description
ALLTRACKS ALLTRACK ALLTRKS ALLTRK	Specifies all tracks on the volume (or minidisk) are to be processed. ALLTRACKS is valid only when NOASSIGN and NOCHECK are specified. NOCHECK NOASSIGN with ALLTRACKS reads all home address records and record 0s on a volume (or minidisk) and issues messages if any discrepancies are found. A primary/alternate track assignment map is also produced.
Default:	None.
Restrictions:	Not valid for the IBM 9345, the RAMAC family of devices, the 2105, and Internal Disk devices.

ASSIGNNOASSIGN parameter: specify assignment of alternate tracks

Parameter/ Abbreviations	Description
ASSIGN ASGN	<p>Flags the specified tracks if they are found defective. If the specified track is a primary track, an alternate track is assigned to it. If the specified track is an alternate track that has a previously assigned primary track associated with it, then the primary track will have a new alternate assigned to it.</p> <p>When used with CHECK(n), any track that is declared defective will undergo assignment. For an explanation of how a track is declared defective, see Appendix E, “Surface checking.”</p> <p>When used with NOCHECK, assignment takes place for all tracks being processed. For the RAMAC family of devices, and Internal Disk devices, ASSIGN with NOCHECK can be used to rewrite home address and record 0.</p>
NOASSIGN NOASGN NASGN	<p>Indicates that you do not want alternate tracks assigned. When used with NOCHECK, this combination will cause ICKDSF to read the home address and record 0 for the specified tracks and issue a message if anything invalid is detected.</p> <p>NOCHECK NOASSIGN with ALLTRACKS reads all home address records and record 0s on a volume. A primary/alternate track assignment map is also produced.</p> <p>Notes:</p> <ol style="list-style-type: none"> 1. If NOASSIGN is specified with the CHECK parameter, and the track is defective, the inspected track is not marked defective and an alternate is not assigned, regardless of the declared condition of the track. A message is issued for this condition. 2. If CHECK/PRESERVE or CHECK/HOLDIT is specified and user data cannot be rewritten because of surface defects, NOASSIGN is overridden and assignment takes place.
Default:	ASSIGN
Restrictions:	<p>The combination of ASSIGN NOCHECK cannot be specified with the range parameters (FROMRANGEITORANGE or CYLRANGEIHEADRANGE).</p> <p>The TRACKS parameter must be used for unconditional alternate track assignment.</p>

AVAILABLE parameter: specify processing is to continue

Parameter/ Abbreviations	Description
AVAILABLE AVAIL	<p>Ensures concurrent media maintenance for 3380, 3390, and 9345 devices during INSPECT processing. AVAILABLE specifies that INSPECT processing should continue only if the data for the track in process is continuously available during the INSPECT operation.</p> <p>For a simplex volume, if concurrent media maintenance cannot be performed for the track, processing for the track is not continued. For volumes which are part of a duplex pair, the AVAILABLE parameter is ignored because a copy of the data is always available.</p> <p>Use the AVAILABLE parameter when you are automating media maintenance procedures. It provides you the ability to control media maintenance being automatically issued for a track if there is a possibility of the data becoming unavailable for a period of time.</p>
Default:	If you do not specify AVAILABLE during PRESERVE processing, concurrent media maintenance occurs if supported for the device. If concurrent media maintenance is not supported, then normal PRESERVE processing occurs.
Restrictions:	AVAILABLE is ignored if you specify NOPRESERVE.

CHECKINOCHECK parameter: surface checking of the volume

Parameter/ Abbreviations	Description
CHECK(<i>n</i>) CHK	<p>Indicates that you want each track to be surface checked for recording errors during inspection and declared defective only if the checked track appears defective. Each track is surface checked by writing and reading specially patterned records. Upon completion of surface checking, the home address and a standard record 0 are rewritten on the track.</p> <p>For <i>n</i>, substitute a decimal number from 1 to 10 for the number of times you want each track to be checked. For information on values of <i>n</i>, see Appendix E, "Surface checking."</p> <p>The level of surface checking to be performed is determined by the SKIPINOSKIP parameters. For more information on these parameters, see "SKIPINOSKIP parameter: specify the level of surface checking" on page 172.</p> <p>For the IBM 9345 and 9394, checking is performed if you specify either CHECK or SKIP. The <i>n</i> value of CHECK(<i>n</i>) is ignored.</p>
NOCHECK NOCHK NCHK	<p>Indicates that you do not want the tracks to be surface checked for recording errors during inspection. Alternate tracks are unconditionally assigned when NOCHECK and ASSIGN are specified. For the RAMAC family of devices, and Internal Disk devices, when NOCHECK and ASSIGN are specified, only home address and record 0 will be rewritten. NOCHECK ASSIGN cannot be specified with ALLTRACKS.</p> <p>NOCHECK NOASSIGN with ALLTRACKS reads all home addresses and record 0s on a volume (or minidisk) to ensure validity. A primary/alternate track assignment map is also produced.</p> <p>The TRACKS parameter must be used for unconditional alternate track assignment.</p>
Default:	CHECK(1)
Restrictions:	<p>The maximum number you can specify with the CHECK(<i>n</i>) parameter is 10.</p> <p>The CHECK parameter is invalid for the 9391, 9393, 9396, 9397, 2105, and Internal Disk devices.</p>

CYLRANGE parameter: specify a range of cylinders

Parameter/ Abbreviations	Description
CYLRANGE(<i>start,end</i>) CYLR CYL	<p>Used to specify what part of a volume or minidisk is to be inspected. Use the CYLRANGE parameter to specify the starting and ending cylinders.</p> <p>For <i>start,end</i>, substitute decimal (<i>n</i>) or hexadecimal digits (for example, X'1AB',X'2DE') to identify the starting and ending cylinders to be examined.</p> <p>If you specify CYLRANGE and do not specify HEADRANGE, all the heads of the specified cylinders are processed.</p> <p>For information on specifying the starting and ending heads (HEADRANGE) to go with the starting and ending cylinders, see "HEADRANGE parameter: specify a range of heads" on page 168.</p> <p>For information on specifying part of a volume or minidisk, see "RANGE parameters: part of a volume" on page 175.</p>
Default:	None.
Restrictions:	<p>Both the starting and ending values are required for CYLRANGE. By specifying an ending value greater than the maximum for the device, processing is performed to the maximum value for that device. However, if you specify REALADDR, the maximum is one cylinder.</p> <p>CYLRANGE cannot be specified with FROMRANGEITORANGE or TRACKS.</p> <p>This parameter is not valid for the 9391, 9393, 9396, 9397, and Internal Disk devices.</p>

DEVICETYPE parameter: identify the type of device

Parameter/ Abbreviations	Description
DEVICETYPE(<i>devtype</i>) DEVTYPE DEVYYP	Required in the Stand-Alone version when the MIMIC(MINI) or MIMIC(EMU) parameter is specified. For <i>devtype</i> , substitute 1 to 8 characters for the type of device on which the volume is mounted. See Table 13 on page 8 for valid device types.
Default:	None.
Restrictions:	Applies only when you are inspecting a volume in the Stand-Alone version and MIMIC(MINI) or MIMIC(EMU) is specified. If DEVICETYPE is specified when it does not apply, it will be ignored.

DIRECTIO parameter: identify volume of a dual copy pair

Parameter/ Abbreviations	Description
DIRECTIO(PRIMARY) DIO(PRI)	Directs I/O to the primary volume of a dual copy pair.
DIRECTIO(SECONDARY) DIO(SEC)	Directs I/O to the secondary volume of a dual copy pair.
Default:	If the DIRECTIO parameter is not specified when you are using a dual copy pair, the default operation is the: <ul style="list-style-type: none"> • Primary volume if the dual copy pair is in duplex state • Secondary volume if the dual copy pair is in suspended duplex state
Restrictions:	The DIRECTIO parameter is ignored if the subsystem does not support dual copy or the volume is in simplex state. HOLDIT and MIMIC are not valid with the DIRECTIO parameter. DIRECTIO(PRIMARY) and NOPRESERVE are mutually exclusive. DIRECTIO(SECONDARY) and PRESERVE are mutually exclusive. Only DIRECTIO(PRIMARY) is allowed if the device is in duplex state.

FORCE parameter: specify concurrent processing

Parameter/ Abbreviations	Description
FORCE	Used only in the recovery of a prior concurrent media maintenance failure on another processor.
Default:	None.
Restrictions:	Use FORCE only to recover from a prior concurrent media maintenance failure on another processor. Misuse of the parameter can cause loss of data.

FROMRANGE parameter: specify a specific starting location

Parameter/ Abbreviations	Description
FROMRANGE(<i>cylinder,head</i>) FROMR FROM	<p>Use this parameter to specify the starting track (cylinder and head) to be inspected.</p> <p>For <i>cylinder,head</i> substitute decimal (n) or hexadecimal digits (for example, X'2AB',X'A') to identify the cylinder and head at which processing is to start. If you specify only one value, ICKDSF takes it to be the cylinder and the head value is defaulted to 0.</p> <p>If you specify FROMRANGE and do not specify TORANGE, TORANGE is defaulted to the last alternate cylinder of a volume or minidisk.</p> <p>For information on specifying the ending track (TORANGE) to go with the starting track, see "TORANGE parameter: specify a specific ending location" on page 173.</p> <p>For information on specifying part of a volume to be examined, see "RANGE parameters: part of a volume" on page 175.</p>
Default:	None.
Restrictions:	<p>FROMRANGE and CYLRANGE HEADRANGE are mutually exclusive.</p> <p>This parameter is not valid for the 9391, 9393, 9396, 9397, and Internal Disk devices.</p> <p>CMS</p> <p>In the CMS version, if you specify REALADDR the range must be contained within one cylinder.</p>

HEADRANGE parameter: specify a range of heads



Parameter/ Abbreviations	Description
HEADRANGE(<i>start,end</i>) HDRANGE HEADR HDR HD	<p>Use the HEADRANGE parameter to specify the starting and ending heads to be inspected.</p> <p>For <i>start,end</i> substitute decimal (n) or hexadecimal digits (for example, X'B',X'E') to identify the starting and ending heads to be examined. If you specify only one value, ICKDSF takes the value to be the starting range and defaults the ending range to the device maximum.</p> <p>If you specify HEADRANGE and do not specify CYLRANGE, the specified heads for all the cylinders on a volume or minidisk are processed.</p> <p>For information on specifying the starting and ending cylinders (CYLRANGE) to go with the starting and ending heads, see "CYLRANGE parameter: specify a range of cylinders" on page 166.</p> <p>For information on specifying part of a volume, see "RANGE parameters: part of a volume" on page 175.</p>
Default:	None.
Restrictions:	<p>Both the starting and ending values are required for HEADRANGE. If you specify an ending value greater than the maximum for the device, the device maximum is used for the ending value.</p> <p>HEADRANGE is mutually exclusive with FROMRANGE TORANGE and with TRACKS.</p> <p>HDRANGE is not valid for the 9391, 9393, 9396, 9397, 2105, and Internal Disk devices.</p>

MAPINOMAP parameter: print a volume map

Parameter/ Abbreviations	Description
MAP	Prints a volume or minidisk map during inspection. The volume map lists tracks that are found to be defective during inspection. Regardless of the tracks being inspected, MAP will list the defective tracks that are currently assigned alternates. The MAP parameter is ignored for devices that do not have alternate tracks.
NOMAP	Indicates that you do not want to print a volume map during inspection.
Default:	MAP Note: When INSPECT ends, the alternate tracks are examined for availability and primary track assignment, regardless of which tracks have been inspected. This information is printed in the map, but no cross check is done to determine if the primary tracks accurately reflect the alternate assignments. For a complete check of all primary and alternate tracks, enter: INSPECT ALLTRACKS NOCHECK NOASSIGN MAP
Restrictions:	MAP is ignored for 9391, 9393, 9396, 9397, 2105, minidisks, and Internal Disk devices.

MIMIC parameter: specify a special volume usage format

Table 42. The MIMIC parameter of the INSPECT command

Parameter/ Abbreviations	Description
MIMIC(<i>type</i>)	Specifies a special usage format for the volume being inspected. For <i>type</i> , specify EMU(n), or EMUALL.
EMU(n)	Indicates that a partial CKD disk emulated on a 3370 FBA device is to be inspected.  In the Stand-Alone version, you must also specify the DEVICETYPE parameter.
EMUALL	Indicates that a full CKD disk is emulated on a 3370 FBA device.
Default:	None.
Restrictions:	When you emulate a CKD device on the 9313, 9332, or 9335, do not use MIMIC(EMU) or MIMIC(EMUALL). For more information, see “Initializing an emulated CKD Device on an IBM 9313, 9332, or 9335 FBA device” on page 85. The EMU(n) EMUALL subparameter is not recommended with INSPECT because inspecting an emulated device causes the device to operate inefficiently. Data checks should be handled using the INSPECT command against the base FBA device. For more information, see “Emulating devices” on page 84.  MIMIC(<i>type</i>) is not valid in the CMS version of ICKDSF.

PASSWORDS parameter: provide passwords for data set security

 MVS

Parameter/ Abbreviations	Description
PASSWORDS ((<i>dsname/password</i>),...)	Specifies passwords for non-VSAM password-protected data sets. The supplied passwords will be used to determine if the user has authority to alter the data sets.
PASSWORD PASSWORD PWD PD	For <i>dsname</i> , substitute the fully qualified name of a password-protected data set. For <i>password</i> , substitute the password you wish to apply to this data set.
Default:	None.
Restrictions:	Up to a maximum of 512 passwords may be specified.

PRESERVE|KEEPIT|NOPRESERVE|HOLDIT parameter: preserve data

Parameter/ Abbreviations	Description
PRESERVE PRSV	<p>Saves the data on the inspected tracks. Saves a copy of each track at a backup location on DASD as well as in storage (the storage copy is used to rewrite the data). If processing ends abnormally on a track, INSPECT detects the data at the backup location and automatically restores the data to that track. For more detailed information, see “Reading and saving data on inspected tracks.”</p> <p>MVS If a track is part of a data set, INSPECT will enqueue on the data set while processing that track.</p>
KEEPIT KEEP	PRESERVE and KEEPIT are synonymous.
NOPRESERVE NOPRSV NPRSV	<p>Indicates that you do not want to save the data on the inspected tracks. NOPRESERVE always destroys the current contents of the track:</p> <ul style="list-style-type: none"> • If you specify CHECK. • If unconditional assignment of alternate tracks is taking place (ASSIGN NOCHECK). <p>MVS Use NOPRESERVE only if data errors on a particular track make it impossible to preserve the data.</p> <p>When you specify NOPRESERVE, you cannot inspect tracks inside a VTOC or a VTOCIX data set in an online MVS mode. Also, cylinder 0, track 0 cannot be inspected with NOPRESERVE in an online mode.</p>
HOLDIT HOLD	Indicates that you want to save the data on the inspected tracks. For more detailed information, see “Saving data on the inspected tracks” on page 171.
Default:	PRESERVE
Restrictions:	<p>Minidisks are always processed as HOLDIT.</p> <p>HOLDIT is not valid for the IBM 9345, RAMAC family of devices, or Internal Disk.</p> <p>DIRECTIO(PRIMARY) and NOPRESERVE are mutually exclusive. DIRECTIO(SECONDARY) and PRESERVE are mutually exclusive.</p> <p>PRESERVE is invalid for 9391, 9393, 9396, 9397, 2105, and Internal Disk devices.</p>

Reading and saving data on inspected tracks

PRESERVE and KEEPIT specify whether to read and save the data on the inspected tracks. Data read from the specified tracks is held in storage.

Data on a track can also be saved at a backup location as well as held in storage (the storage copy is used to rewrite the data). If processing ends abnormally, the next use of INSPECT detects the data at the backup location and restores the data to the track where processing ended abnormally.

When running online, certain security and integrity precautions are taken to prevent inadvertent destruction of data. When running offline (MVS) or in Stand-Alone, data destruction is not prevented. For more information about security, see:

- “Protecting MVS volumes and data sets” on page 31
- “Resource serialization when using INSPECT” on page 177

When you specify CHECK with either PRESERVE, HOLDIT, or KEEPIT, the data is still at varying degrees of risk.

Writing data from a backup location with PRESERVE or KEEPIT

The backup location and the storage copy of the track are erased at the completion of a command.

A performance degradation may be caused by the writing of the data at the backup location. The time duration of degradation depends on the total number of tracks being processed for the current INSPECT.

When the data is written at the backup location, it is read-back-checked to ensure it was written correctly. However, when the backup location is used to restore the data at the next use of the INSPECT command, there is no guarantee that the data can be recovered.

Writing data from a CE cylinder

For devices that use the CE cylinder as the backup cylinder, if data exists at the backup location, ANALYZE DRIVETEST, which writes on the CE cylinder, does not destroy the data. ANALYZE does indicate the cylinder and head of the track for which data exists. **Note, however, that the CE micro-diagnostics may destroy the data at the backup location.**

Therefore, if INSPECT processing does not complete because of a problem on the volume that requires the assistance of an IBM customer engineer, make every attempt to restore the data first, if necessary.

If errors occur while writing data with PRESERVE or KEEPIT

If permanent, uncorrectable data checks are occurring on a track, INSPECT cannot read the data from the track. Therefore, if PRESERVE or KEEPIT is specified, the command will stop processing before writing anything on the track.

If an error occurs when writing the user data back onto the track (or an assigned alternate), INSPECT assigns an alternate to the primary track and writes the data on the alternate. No surface checking takes place at this time, but, if the write to the alternate fails, a new alternate is assigned (up to three times).

When you specify PRESERVE or KEEPIT, and your DASD is an IBM 9345, 9394, or is attached to an IBM 3990 which supports concurrent media maintenance, concurrent media maintenance is automatically issued. This allows user access to the data on a track while INSPECT is processing on that track. Because the data on the track is always available, you can run INSPECT even when there is other activity on the volume.

For more information, see “Preserving data under Concurrent Media Maintenance” on page 180.

Saving data on the inspected tracks

HOLDIT reads the data and keeps it in storage. If processing for the track does not run to completion, the data is lost and record 0 for the track is in a nonstandard format. An INSPECT with NOPRESERVE can be run against the track to fix the record 0 condition. You can then restore the data from a user backup copy.

Canceling a job that contains an INSPECT HOLDIT is not recommended. When INSPECT HOLDIT is running against multiple tracks, ICKDSF cannot determine which, if any, of the tracks caused processing to stop. After an INSPECT HOLDIT command does not run to completion, determine the readability of the home address and record 0s on the volume by running:

```
INSPECT ALLTRACKS NOCHECK NOASSIGN
```

You will receive message ICK31064I for any track that ICKDSF was processing when the previous job ended. You can then fix the record 0 condition and restore data for that track, as described above.

INSPECT command—CKD

If permanent, uncorrectable data checks are occurring on a track, INSPECT cannot read the data from the track. Therefore, if HOLDIT is specified, the command will stop processing before writing anything on the track.

If an error occurs when writing the user data back onto the track (or an assigned alternate), INSPECT assigns an alternate to the primary track and writes the data on the alternate. No surface checking takes place at this time, but, if the write to the alternate fails, a new alternate is assigned (up to three times).

RECLAIMINORECLAIM parameter: reclaim defective tracks

Parameter/ Abbreviations	Description
RECLAIM RCLM	<p>Indicates that you want to reclaim primary or alternate tracks that were flagged as defective in input but appear usable after surface checking.</p> <p>Reclamation occurs only if surface checking is performed without errors for that track.</p> <p>If a track is currently flagged defective, the maximum available surface checking procedure is used. If the checking process indicates that the track has no errors, the track is reclaimed.</p>
NORECLAIM NORCLM NRCLM	<p>Indicates that you want to suppress track reclamation during inspection.</p>
Default:	NORECLAIM
Restrictions:	<p>The RECLAIM parameter applies only when the CHECK parameter has been specified. If RECLAIM is specified with NOCHECK, it will be ignored.</p> <p>RECLAIM is ignored for the RAMAC family of devices, the 2105, and the Internal Disk devices.</p>

SKIPINOSKIP parameter: specify the level of surface checking

Parameter/ Abbreviations	Description
SKIP	<p>When CHECK is specified, SKIP performs extensive surface checking on all tracks within the specified range. If a data check is detected on a track, skip displacement is performed for that track.</p> <p>If SKIP is specified, the maximum total number of tracks within the combination of range parameters cannot exceed the number of tracks contained in one cylinder for the specified device type. Because of this limitation, when you specify SKIP, you must also use the range parameters to specify part of a volume.</p> <p>Because SKIP does extensive surface checking for all tracks within the range, the run time can be excessive, even with the one cylinder limit. (Extensive surface checking can take up to 5 minutes per track or more, depending on the device type and system conditions.)</p> <p>When skip displacement processing is being performed for INSPECT, for every track that is part of a non-VSAM data set, the data set is enqueued while processing the track.</p> <p>If the track is part of a data set, INSPECT will enqueue on the data set while processing that track.</p> <p>For tracks in VSAM data sets, TOLERATE(ENQFAIL) must be specified when processing online.</p> <p>For the IBM 9345 and 9394, surface checking is performed by the subsystem when you specify either CHECK or SKIP.</p> <p>For more information on surface checking, see Appendix E, "Surface checking."</p>
NOSKIP	<p>Indicates that primary surface checking is to be performed for all tracks in the specified range. If a data check is detected on a track during primary checking, skip displacement checking is performed for that track.</p> <p>The total number of tracks that can be inspected when NOSKIP is specified is 2500.</p>
Default:	If your job specifies TRACKS, the default is SKIP. If your job specifies a range of tracks, the default is NOSKIP.

Parameter/ Abbreviations	Description
Restrictions:	<p>SKIPINOSKIP is ignored if NOCHECK is specified.</p> <p>If SKIP is specified, the value of <i>n</i> in CHECK(<i>n</i>) is ignored.</p> <p>For the 9345 and the 9394, NOSKIP is ignored.</p> <p>SKIP processing is much more extensive and takes longer than NOSKIP.</p> <p>SKIP is ignored for the 9391, 9393, 9396, 9397, 2105, and Internal Disk devices.</p>

TOLERATE parameter: specify continue processing

Parameter/ Abbreviations	Description
TOLERATE(ENQFAIL) TOL(ENQF)	<p>MVS Specifies that in the event exclusive access cannot be obtained for a data set, that processing is to continue for the track. If TOLERATE(ENQFAIL) is not specified, processing continues on the next track.</p> <p>For tracks in VSAM data sets, TOLERATE(ENQFAIL) must be specified when processing online.</p>
TOLERATE(PRIFAIL) TOL(PRIF)	<p>Specifies that when you are processing the secondary volume of a dual copy pair, you wish to continue processing (on the same track) when the same data on the primary volume cannot be read.</p> <p>If TOLERATE(PRIFAIL) is not specified when you are processing the secondary volume of a dual copy pair and the corresponding track on the primary volume cannot be read, a warning message is issued and processing continues on the next track (current track is not processed).</p>
Default:	None.
Restrictions:	<p>MVS TOLERATE(ENQFAIL) is ignored if NOSKIP is specified (MVS systems only). ICKDSF assumes TOLERATE(ENQFAIL) is in effect if NOSKIP is specified and a data check requires that an enqueue be performed. TOLERATE(ENQFAIL) is ignored for IBM 9345 and 9394 devices and devices attached to an IBM 3990 Storage Control that support concurrent media maintenance.</p> <p>TOLERATE(PRIFAIL) is:</p> <ul style="list-style-type: none"> • Not valid when DIRECTIO(PRIMARY) is specified • Ignored for a simplex device

TORANGE parameter: specify a specific ending location

Parameter/ Abbreviations	Description
TORANGE(<i>cylinder,head</i>) TOR TO	<p>Use this parameter to specify the ending track (cylinder and head) of the volume or minidisk to be inspected.</p> <p>For <i>cylinder,head</i>, substitute the decimal (<i>n</i>) or hexadecimal digits (for example, X'2AB',X'E') to identify the cylinder and head where processing is to end. If you specify only one value, ICKDSF takes it to be the cylinder and defaults the head to the device maximum.</p> <p>If you specify TORANGE and do not specify FROMRANGE, FROMRANGE is defaulted to cylinder 0, head 0 of the specified or minidisk.</p> <p>For information on specifying the starting track of part of a volume (FROMRANGE), see "FROMRANGE parameter: specify a specific starting location" on page 168.</p> <p>For information on specifying part of a volume, see "RANGE parameters: part of a volume" on page 175.</p>
Default:	None.

INSPECT command—CKD

Parameter/ Abbreviations	Description
Restrictions:	You cannot specify TORANGE with CYLRANGEIHEADRANGE or TRACKS. TORANGE is not valid for 9391, 9393, 9396, 9397, 2105, and Internal Disk devices.

TRACKS parameter: specify discrete tracks

Parameter/ Abbreviations	Description
TRACKS(<i>cylinder,head</i> [,...]) TRACK TRKS TRK	Specifies discrete tracks to be inspected. For <i>cylinder,head</i> , specify decimal (n) or hexadecimal digits to identify the cylinder, and decimal (n) or hexadecimal digits (for example, X'2AB',X'E') to identify the track to be inspected. To inspect more than one track at a time, specify: TRACKS((<i>cylinder,head</i>), (<i>cylinder,head</i>)) The TRACKS parameter is also used to fix tracks that have an 0F0B condition. In order to fix this condition the NOSKIP, NOASSIGN, and NOPRESERVE parameters must also be specified on the INSPECT command.
Default:	None.
Restrictions:	The maximum number of individual tracks that you can specify with TRACKS is 20. However, unless you specify NOSKIP, the maximum number of tracks is the number of tracks in a cylinder. TRACKS and the range parameters are mutually exclusive. If you do not specify TRACKS or the range parameters, INSPECT checks for the existence of backup data and performs the recovery functions if backup data exists. If you are trying to recover from a previous failure at this time, and have not specified tracks or a range, the track that was being processed at the time of failure is recovered. However, if you also want to perform an INSPECT function, you must specify TRACKS or a range.

USERID parameter: specify another user's minidisk

CMS

Parameter/ Abbreviations	Description
USERID(<i>user's ID</i>) UID	Performs the INSPECT function on another user's minidisk. For <i>user's ID</i> , substitute the 1 to 8 characters of the user ID of the owner of the minidisk you want to verify.
Default:	If USERID is not specified, your own minidisk is verified.
Restrictions:	USERID can be specified only if you are using the CMS version of ICKDSF and have DEVMAINT authority. USERID is ignored in all other system environments. USERID and REALADDR are mutually exclusive.

Controlling the level of surface checking

When you specify CHECK(**n**), the level of surface checking, which is performed for each track in a specified range, is controlled by the SKIPINOSKIP parameters. If you specify NOCHECK, no surface checking is performed. For more information on surface checking, see Appendix E, "Surface checking."

NOSKIP indicates that primary surface checking is to be performed for all tracks in the specified range, and skip displacement surface checking is performed only if a data check is detected. NOSKIP is the default if you specify any of the range parameters.

SKIP indicates that skip displacement surface checking is to be performed for every track in the specified range. Although SKIP provides a more extensive check of the surface of a track, it runs for a longer period of time per track. If SKIP is specified, the total number of tracks in the specified range is limited to the number of tracks in a cylinder. SKIP is the default if you specify the TRACKS parameter.

For the IBM 9345 and 9394, surface checking is performed by the subsystem. There is only one level of surface checking, and it is issued by specifying either CHECK or SKIP. For the IBM 9345 and 9394, NOSKIP is ignored.

RANGE parameters: part of a volume

CYLRANGEIHEADRANGE and FROMRANGEITORANGE are optional parameters used to limit the areas of a volume or minidisk that are to be inspected.

CYLRANGEIHEADRANGE—Specifies the starting and ending cylinders and starting and ending heads to be inspected.

FROMRANGEITORANGE—Specifies the starting track (cylinder and head) and the ending track (cylinder and head) to be inspected.

Table 43 shows the parameter conditions when specifying part of the volume.

Table 43. Parameter conditions when specifying part of the volume

Parameter	NOCHECK ASSIGN Valid?	Other Notes
CYLRANGE	No	If you specify CYLRANGE and do not specify HEADRANGE, all the heads of the specified cylinders are processed. Both the starting and ending values are required. If you specify an ending value greater than the maximum for the device, the device (minidisk) maximum is used for the ending value.
HEADRANGE	No	If you specify HEADRANGE and do not specify CYLRANGE, the specified heads for all the cylinders on the volume (minidisk) are processed. Both the starting and ending values are required. If you specify an ending value greater than the maximum for the device, the device (minidisk) maximum is used for the ending value.
FROMRANGE	No	If you specify FROMRANGE and do not specify TORANGE, TORANGE is defaulted to the last cylinder of the device (minidisk).
TORANGE	No	If you specify TORANGE and do not specify FROMRANGE, FROMRANGE is defaulted to cylinder 0, track 0 (starting cylinder and track of the minidisk)

INSPECT command—CKD

Table 43. Parameter conditions when specifying part of the volume (continued)

Parameter	NOCHECK ASSIGN Valid?	Other Notes
Notes:		
1. CYLRANGEIHEADRANGE and FROMRANGEITORANGE are mutually exclusive pairs. Either pair is mutually exclusive with TRACKS.		
2. If NOCHECK is specified with any of the range parameters, the home address and record 0 of all tracks in the specified range are read. This can be used to verify alternate/primary track assignments of a subset of a volume.		
3. If you want to verify the alternate tracks on a volume (that is, primary/alternate pairs are valid), specify the range parameters for the alternate cylinders.		
4. Range parameters used with NOPRESERVE can destroy large areas of a volume.		
5. Use TRACKS with the NOCHECK and ASSIGN parameters to unconditionally assign alternate surfaces.		
6. With NOSKIP, depending on which is greater, you can inspect: <ul style="list-style-type: none">• Up to 2500 tracks, or• The total number of cylinders per volume (if you have provided only one head).		
With SKIP, the total cannot exceed the number of tracks in a cylinder for the specified device type.		

Assigning alternate tracks

A track can be flagged as defective, and an alternate assigned either conditionally or unconditionally. The amount of surface checking done before an alternate is assigned is determined by multiple factors, including:

- The use of the CHECK or NOCHECK parameter
- The availability of skip displacement bytes for the device type
- The current condition of the track

In the following example, ICKDSF assigns the next available alternate track for track (2,3). Since NOPRESERVE is specified, the contents of track (2,3) are not copied to the alternate track; the data on the specified track is destroyed when the command completes:

```
INSPECT UNIT(0273) NOVERIFY TRACKS(2,3) NOCHECK NOPRESERVE
```

For a detailed description of the type of checking performed, see Appendix E, “Surface checking,” on page 471.

Table 44 shows you how to control the assignment of alternate tracks. The parameter explanations appear in alphabetical order under “Optional parameters” on page 164.

Table 44. Assigning alternate tracks with INSPECT parameters

To...	Use the INSPECT parameters...
Detect defective primary and alternate tracks and assign an alternate surface if the defective track is a primary one.	CHECK and ASSIGN
Unconditionally assign alternate surfaces for the tracks specified.	NOCHECK and ASSIGN
Inspect primary and alternate tracks, but prevent assignment of alternates.	CHECK and NOASSIGN

Table 44. Assigning alternate tracks with INSPECT parameters (continued)

To...	Use the INSPECT parameters...
Assign an alternate surface when data cannot be rewritten because of surface defects, regardless of the ASSIGNINOASSIGN value.	PRESERVE In the map, this option will indicate all defective tracks but alternates will not be assigned. Skip displacement will be assigned as required.

Table 45 shows you where data is rewritten when INSPECT finds a defective track.

Table 45. Where INSPECT rewrites the data of a defective track

If defective track is:	Then data is rewritten...
A primary track	On the assigned alternate.
An alternate track associated with a primary surface	To a different alternate, and the defective alternate is flagged.
A reclaimed primary track that was previously flagged as defective	From the alternate surface to the reclaimed primary surface, and the alternate surface is made available.

Resource serialization when using INSPECT

MVS

This section describes data integrity when you are processing DASD which is:
Not an IBM 9345, 9394, or on DASD attached to an IBM 3990 storage control, which supports concurrent media maintenance.

See “Preserving data under Concurrent Media Maintenance” on page 180 for information on the IBM 9345 or on DASD attached to an IBM 3990 storage control.

When INSPECT occurs, the RESERVE macro is issued to obtain control of the device. DEQ is issued to release the device after processing is completed.

When INSPECT is used to perform skip displacement processing (using the SKIP parameter), if a track is part of a data set, INSPECT will enqueue on the data set while processing that track.

Additionally, if the INSPECT command exposes user data for a relatively long period of time, ICKDSF enqueues for exclusive control of the data set containing the track which is to be processed. Data set enqueue takes place when any one of the following conditions is true:

- The device is online to the operating system.
- The track is part of a non-VSAM data set.
- The SKIP parameter is specified.
- NOSKIP is specified, but primary surface checking indicates that skip displacement processing is necessary for the track.

If exclusive control of a data set cannot be obtained, a message is issued and processing continues on the next track.

The TOLERATE(ENQFAIL) parameter is provided to indicate that processing is to continue if the data set enqueue fails when SKIP is specified.

INSPECT command—CKD

If the enqueue is performed as a result of primary surface checking indicating the need for skip displacement surface checking, TOLERATE(ENQFAIL) is assumed to be in effect.

For tracks in VSAM data sets, TOLERATE(ENQFAIL) must always be specified when processing online.

Recovering data after a job or system failure

This section describes recovering data which is not on the IBM 9345, 9394, or on DASD attached to an IBM 3990

See “Preserving data under Concurrent Media Maintenance” on page 180 for information on recovering data, which is on the IBM 9345 or on DASD attached to an IBM 3990 storage control.

If an INSPECT command ends before completing, and PRESERVE was specified on the failing job, ICKDSF has saved the data. It will be automatically recovered on the next use of the INSPECT command.

After resolving the reason for the failure, you can submit:

- The same INSPECT job.

This does a primary surface check of the track being processed at the time of failure, recovers the data, and inspects all the tracks in the specified range, including those tracks that were inspected prior to the previous failure.

- An INSPECT job for a entirely different or partially different range.

This does a primary surface check of the track being processed at the time of failure, recovers the data, and processes all tracks in the new range.

- An ANALYZE job (for nonemulated, nonremovable media devices only) to determine the track that failed.

ANALYZE will print the cylinder and head of the track that was being processed at the point of failure.

Then you can issue a new INSPECT job with a modified range, according to the previous point of failure.

- Enter INSPECT with neither TRACKS nor any of the range parameters specified.

This does a primary surface check of the track being processed at the time of failure, and recovers the data.

Warning

Be careful about using the volume before recovering the data. In addition to the data being unavailable, the track may be unusable to the operating system, and any use of the track can cause I/O errors.

If you run INIT on this volume before the next INSPECT, INIT erased the data at the backup location.

Notes:

1. Recovery is only possible if PRESERVE was specified on the job running at the time of failure. It is not possible if HOLDIT or NOPRESERVE were specified or if you were processing minidisks under CMS.

2. It is possible that the track that is being processed at the time of failure contained no data. In that case, recovery consists of only doing a primary surface check of the track. This ensures that the track is usable (that is, that the track now contains just a home address and a standard record 0).
3. It is possible that INSPECT was “between tracks” when the job failed, and there is no track or data to recover.
4. The restore function is not optional. If data exists at the backup location, it is restored.
 If there is data on the track being restored (that is, the track being processed at the point of failure), the operator is prompted either to restore the data or erase the data.
 If the data cannot be restored, for whatever reason, the operator is prompted for the next action.
 To put the restored data in storage, you can run a job that specifies HOLDIT.
5. When you are processing minidisks on devices that do not support concurrent media maintenance, data is not saved at the backup location. Therefore, no recovery of data is possible.

Preserving data during INSPECT

This section describes preserving data which is not on the IBM 9345, 9394, or on DASD attached to an IBM 3990 storage control, which supports concurrent media maintenance.

See “Preserving data under Concurrent Media Maintenance” on page 180 for information on recovering data, which is on the IBM 9345 or on DASD attached to an IBM 3990 storage control.

When you specify the PRESERVE parameter of the INSPECT command, a backup copy of the data on a track is stored at the backup location as well as held in storage. This backup location uses two tracks: the recovery track and the preserve track.

The recovery track contains the control information, and the preserve track contains the actual data. This information resides on:

- The CE cylinder of the volume, if there is a uniquely addressable CE cylinder on the volume.
- The SA cylinder of the volume, if there is no CE cylinder, but there is an SA cylinder with unused tracks.
- An alternate track, if the device does not have a CE cylinder or an SA cylinder.

If processing ended abnormally, the next use of INSPECT will:

- Detect the data at the backup location and determine the track to be recovered (the recovery track).
- Check the home address and record 0 of the recovery track for validity.
- Surface check the track to be restored at the primary level unless a data check is detected. If a data check is detected, INSPECT will perform skip displacement surface checking.
- Restore the data.

The restoration of the track from the preserved data is automatic, and is independent of the range specified in the current job. To perform only the restore function, run INSPECT with no tracks specified.

Keeping your data in storage or in storage and backup

INSPECT allows you to choose from two levels of data preservation:

- In storage only.

HOLDIT specifies that a copy of the data on the track being processed is to be kept in storage only, with no copy being kept at the backup location.

- In storage and at a backup location.

PRESERVE or KEEPIT specifies that a copy of the data on the track being processed is to be written at the backup location as well as kept in storage. The copy at the backup location is used only during the restore procedure.

The backup location and the copy of the data in storage are erased at the completion of the command.

Even when a track that contains no data is processed, the backup location is still accessed. This ensures that the integrity of the volume can be restored if a restart is necessary.

PRESERVE|KEEPIT is the default. When PRESERVE|KEEPIT is specified, you might notice a performance degradation caused by the writing of the data at the backup location. The performance degradation depends on the total number of tracks being processed by the current INSPECT command.

When using PRESERVE, be careful:

- When data is written at the backup location. **It cannot be guaranteed that the data is always retrievable from the backup location.**
- If the backup location is the CE cylinder. **The ANALYZE command (which writes on the CE cylinder) will not destroy restored data if it exists.** ANALYZE indicates the cylinder and head of the track that originally had the problem.

CE micro-diagnostics may destroy the data at the backup location.

Therefore, if INSPECT processing does not complete because of a problem on the volume that requires the assistance of an IBM customer engineer, issue INSPECT to restore the data first, if necessary.

Preserving data under Concurrent Media Maintenance

Concurrent media maintenance allows user access to the data on a track while INSPECT is processing on that track. In addition, the entire volume is available for use by all users from all shared systems for the duration of the INSPECT job. Because the data on the track is always available, you can run INSPECT even when there is other activity on the volume.

MVS

Concurrent media maintenance is automatically issued when you specify PRESERVE. INSPECT will no longer perform the hardware “reserve” or the VTOC ENQ for the volume. Data set ENQ is eliminated as well as all restrictions on VSAM data sets.

If your device is a 3380, it is recommended you use the INSPECT command with the AVAILABLE parameter.

Concurrent media maintenance is automatically performed when your data is on IBM 9345 or 9394 devices, or on DASD attached to an IBM 3990 storage control that supports concurrent media maintenance.



Minidisks are also supported. If you are trying to preserve data for minidisk 192, INSPECT will stop running if you have previously preserved data for a real volume, for example, minidisk 193. If this occurs, reissue the INSPECT PRESERVE command for minidisk 193 to recover the previously preserved data. Then you can issue the INSPECT PRESERVE command to preserve data for minidisk 192.

How Concurrent Media Maintenance is performed

Concurrent media maintenance allows continued data availability on DASD while an INSPECT is processing on the track. User data is moved to an alternate track and is accessed from that track by any user while INSPECT operates on the primary track. When surface checking is complete, the data is returned to the primary track.

If execution of the INSPECT should end before completion, the following should be noted:

- User data remains on the alternate track and will be accessed from there until a subsequent INSPECT is run for that device.
- If a subsequent INSPECT is started from the same processor, processing will automatically continue for the track that received the failure.
- If a subsequent INSPECT is started from a different processor, the FORCE parameter is required to support recovery of a prior concurrent media maintenance failure from another processor. This is necessary in order to prevent multiple INSPECT jobs from different processors accessing the same track simultaneously.

Warning

Use the FORCE parameter only to recover from a prior concurrent media maintenance failure on another processor. Misuse of this parameter can cause data integrity problems when two INSPECT jobs are running simultaneously.

Dual copy volumes

When you INSPECT dual copy volumes, you should specify the DIRECTIO parameter to select the primary or secondary volume, otherwise the default is selected depending on the mode of the device. If INSPECT cannot read from the primary volume, INSPECT will terminate.

CMS version minidisk support

CMS

The following parameters are valid only when you are using the CMS version of ICKDSF and have DEVMAINT authority (as defined in the CP directory):

USERID—With DEVMAINT authority, you can use the USERID parameter to perform the data verification test on another user's minidisk. The following parameters are valid:

ALLTRACKS, ASSIGNINOASSIGN, CHECKINOCHECK, CYLRANGE, FROMRANGE, HEADRANGE, HOLDIT, MAPINOMAP, PRESERVE, RECLAIMINORECLAIM, SKIPINOSKIP, TORANGE, TRACKS, and UNITADDRESS.

INSPECT command—CKD

REALADDR—With DEVMAINT authority, you can use the REALADDRESS parameter to specify the real device address. ALLTRACKS and UNITADDRESS are not valid in this mode. All of the other parameters listed above are valid.

Besides DEVMAINT authority, you must also have specified LNKEclu on the OPTION directory control statement in the user's directory definition when performing media maintenance on minidisks.

For more information, see Chapter 5, "Getting started with the CMS version."

Examples of the INSPECT command

The following examples show different ways to code the INSPECT command.

Any values specified here are examples only and should not necessarily be interpreted as the values for your system. Most show the use of the command in offline and online mode under MVS.

CMS

SA

To inspect a volume in the Stand-Alone version:

1. Eliminate the MVS JCL.
2. Substitute the UNITADDRESS parameter for the DDNAME parameter.
3. Specify the DEVICETYPE parameter if the MIMIC(EMU) or MIMIC(MINI) parameter is also specified.

VSE

To inspect a VSE version volume:

1. Replace the MVS JCL statements with VSE system control statements.
2. Substitute the SYSNAME parameter for the DDNAME parameter.

Inspecting volumes with the MVS version

MVS

The following examples show you how to inspect volumes with the MVS version of ICKDSF.

Inspecting for conditional assignment of alternate tracks in online mode

In this example, the assignment of alternate tracks depends on the results of surface checking. The data on each specified track is copied to an alternate track if the track is defective or is written back to the primary track if the track is not defective. Volume PAY345 was previously mounted as PRIVATE.

```
//EXAMPLE JOB
//      EXEC  PGM=ICKDSF
//VOLUME DD   UNIT=3390,DISP=OLD,VOL=SER=PAY345
//SYSPRINT DD  SYSOUT=A
//SYSIN  DD   *
      INSPECT DDNAME(VOLUME) NOVERIFY CHECK(3) -
              TRACKS((1,3),(1,2),(2,0),(2,3),(3,2))
/*
```

Inspecting for unconditional assignment of alternate tracks in offline mode

In this example, the next available alternate track is assigned for the specified primary track. If the primary track is already assigned an alternate track, it will be reassigned a different alternate track. The default parameter PRESERVE causes the contents of the specified primary track to be copied to the assigned alternate.

```
//EXAMPLE JOB
//      EXEC  PGM=ICKDSF
//SYSPRINT DD  SYSOUT=A
//SYSIN  DD   *
INSPECT UNITADDRESS(0273) NOVERIFY TRACKS('X'2',3) NOCHECK
/*
```

Reclaiming tracks in offline mode

In this example, a volume is inspected to reclaim tracks that were previously marked defective. The default parameter PRESERVE causes the contents of the alternate track to be copied to the primary track if the primary track is reclaimed. The alternate track then becomes available for future assignment.

```
//EXAMPLE JOB
//      EXEC  PGM=ICKDSF
//SYSPRINT DD  SYSOUT=A
//SYSIN  DD   *
INSPECT UNITADDRESS(0354) NOVERIFY TRACKS((2,3),(3,1),(1,3)) -
      RECLAIM
/*
```

Inspecting the secondary volume of a duplex pair in online mode

In this example, an INSPECT is specified on the secondary volume of a dual copy pair in suspended duplex state with a primary volume serial of PAY345.

```
//EXAMPLE JOB      jobname
//      EXEC  PGM=ICKDSF
//VOLUME1 DD      UNIT=3380,DISP=SHR,VOL=SER=PAY345
//SYSPRINT DD      SYSOUT=A
//SYSIN  DD      *
INSPECT DDNAME(VOLUME1) NVFY CHK(1) -
      TRACKS(6,3) DIRECTIO(SECONDARY) NOPRESERVE
/*
```

Inspecting the secondary volume of a duplex pair in offline mode

In this example, an INSPECT is specified on the secondary volume of a dual copy pair in suspended duplex state. The DIRECTIO and SECONDARY parameters are abbreviated.

```
//EXAMPLE JOB      jobname
//      EXEC  PGM=ICKDSF
//SYSPRINT DD      SYSOUT=A
//SYSIN  DD      *
INSPECT UNIT(0274) NVFY CHK(1) TRACKS(6,3) DIO(SEC) NOPRESERVE
/*
```

Producing a volume map of an entire volume in a Stand-Alone version



In this example, all the tracks on the volume are inspected to produce a volume map that lists all the defective tracks. No alternate tracks are assigned.

```
INSPECT UNITADDRESS(0353) NOVERIFY -
      ALLTRACKS NOASSIGN NOCHECK
```

Inspecting volumes with the CMS version



The following examples show you how to inspect volumes with the CMS version of ICKDSF.

INSPECT command—CKD

Inspecting another user's minidisk

In this example, a minidisk that is owned by another user is inspected. You specify the USERID parameter to inspect the minidisk of a user named BROWN. You must have DEVMAINT authority for this example. TRACKS(3,1) is the cylinder and head address relative to the beginning of the minidisks.

```
INSPECT UNITADDRESS(0391) NOVERIFY USERID(BROWN) TRACKS(3,1)
```

Inspecting a minidisk with a real address

In this example of batch mode execution, part of a volume with a real address of 290 is inspected. Cylinder 3, tracks 0 through 9 are inspected. If any of the inspected tracks are defective, an alternate is assigned. SKIP specifies that skip displacement checking is to be performed on the specified tracks. You must have DEVMAINT authority for this example.

```
INSPECT REALADDR(290) NOVERIFY  
FROMRANGE(3,0) TORANGE(3,9) SKIP
```

Checking tracks for defects in the VSE version

VSE

In this example, a volume previously initialized under VSE is inspected. If any of the inspected tracks are defective, an alternate will be assigned. The SKIP parameter specifies that skip displacement surface checking is to be performed on the tracks specified.

```
// JOB      jobname  
// ASSGN    SYS010,151  
// EXEC     ICKDSF,SIZE=AUTO  
INSPECT SYSNAME(SYS010) NVFY TRKS((2,3),(3,1),(1,3)) -  
SKIP  
/*  
/&
```

Chapter 17. INSTALL command—CKD



The INSTALL command is an enhanced installation procedure that includes the writing of home address and record 0 on every track of a 3380, 3390, and 9345 volume. You issue INSTALL before formatting 3380, 3390, and 9345 volumes on:

- A new DASD unit
- Replaced or upgraded HDA
- A DASD unit that has been physically relocated

For an example of using the INSTALL command on a new device, see “Installing a device from the factory” on page 71.

If you are installing a new 9345 device, you might not need to run the INSTALL command. Your IBM customer engineer will run a Track Center Test during the install process and give you a list of device addresses against which you need to run the INSTALL command. If no 9345 devices need the INSTALL command run, you are ready to format the device for your operating environment.

You also use the INSTALL command to change the mode of IBM 3390 or 9391 volumes to 3380 track compatibility mode (3380 track format). The 3390-9 and 9394 do not support 3380 track compatibility mode.

The INSTALL command is valid on IBM 3380, 3390, and 9345 volumes. If INSTALL is needed on dual copy volumes, the pair must be broken.

The INSTALL command is not recommended for use on the 9394.

The INSTALL command is not supported on 9393 and 2105 devices.

For information on ICKDSF support of the RAMAC family of devices, see “ICKDSF support of the RAMAC Array family” on page 8.

For information on ICKDSF support of the Internal Disk devices, see “ICKDSF support of the Internal Disk” on page 9.



When you are using the CMS version of ICKDSF, the INSTALL command is valid only with dedicated devices. For more information, see Chapter 5, “Getting started with the CMS version.”

Warning

After the install process is complete, you must initialize the volume for use in your operating environment. To initialize your volume, use the:

- INIT command for MVS or VSE
- CPVOLUME command for VM
- AIXVOL command for AIX

Note: In MVS or VSE, if you want to erase the FFVDP on the volume, use INIT VALIDATE NODATA command, or use the TRKFMT command.

INSTALL command—CKD

Multiple concurrent ICKDSF jobs can cause contention for resources. This can occur when the number of ICKDSF jobs accessing devices on the same storage control or storage subsystem exceeds the number of paths to the devices. For example, if you are running in device level selection enhanced (DLSE) mode, the maximum number of copies you should use is four.

Protecting the INSTALL command with RACF

The MVS version of ICKDSF checks the general resource profile for a facility class profile of STGADMIN.ICK.INSTALL. If RACF is not installed or the facility STGADMIN.ICK.INSTALL is not created, the INSTALL command executes with no authorization check. For additional information, see “Protecting ICKDSF commands with RACF” on page 35.

Installing relocated devices

3380

When your IBM 3380 has been moved to a new location, you may need to run the INSTALL command. The model of your 3380 determines whether this INSTALL procedure is required, recommended, or optional. The INSTALL function is:

- Required for Models AJ4, BJ4, AK4, and BK4
- Recommended for Models AE4 and BE4
- Optional for all other 3380 models

3390

Before you move the 3390 to a new location, it is recommended that you transfer the data on the 3390 to another device in the event the 3390 is subject to severe shocks or vibrations during the move. After the 3390 is in its final location and your service representative completes the physical installation process, you must issue the INSTALL command to write the home address and record 0 at track center.

Note: If the 3390 is not subjected to severe shocks or vibration during the move, you may not need to transfer the data to another device or run the INSTALL command.

9345

When you move your 9345 to a new location, your IBM customer engineer will run a diagnostic to determine whether you need to run the INSTALL command. After running the diagnostic, your customer engineer will give you a list of device addresses against which you need to run the INSTALL command.

Changing the mode of 3390 volumes

To change the volume mode (3390 mode or 3380 track compatibility mode) of IBM 3390 devices (models 1, 2, and 3 only), or 9391 devices, use the SETMODE parameter. If a volume is in a transition state due to a previous INSTALL command where part of the volume has been converted, ICKDSF will detect and complete the conversion.

Syntax

INSTALL

Required Parameters SYSNAME(<i>sysxxx</i>) UNITADDRESS(<i>ccuu</i>)
Optional Parameters SETMODE(3380 3390) VERIFY(<i>serial</i> *NONE*) NOVERIFY

Required parameters

SYSNAME|UNITADDRESS parameter: identify the volume

Parameter/ Abbreviations	Description
SYSNAME(<i>sysxxx</i>)	Required for a VSE volume when executing ICKDSF in batch mode; the volume must be online. For <i>sysxxx</i> , specify the SYSNAME in the ASSGN system control statement.
UNITADDRESS(<i>ccuu</i>) UNITADDR UNIT	<p>Required for an offline MVS volume, a Stand-Alone volume, and an attached CMS volume. For VSE, it is required when executing ICKDSF in command mode; the volume must be online.</p> <p>In MVS, the volume must be on a path that is online. If the volume is on a path that is offline, the program might enter a nonterminating wait state. For <i>ccuu</i>, specify the address (3 or 4 hexadecimal digits) of the channel and unit of the volume.</p> <p>For the CMS version, specify the virtual address of the dedicated volume or minidisk.</p> <p>The unit address is the device number.</p>
Default:	None.
Restrictions:	You must run INSTALL offline.

Optional parameters

SETMODE parameter: set 3390 mode

Parameter/ Abbreviations	Description						
SETMODE(3380 3390) MODE	<p>Specifies the IBM 3390 or 9391 is to be set to 3390 mode, 3380 track compatibility mode (3380 track format).</p> <table border="0"> <tr> <td>Option</td> <td>Sets the volume to:</td> </tr> <tr> <td>3380</td> <td>3380 track compatibility mode.</td> </tr> <tr> <td>3390</td> <td>3390 mode.</td> </tr> </table>	Option	Sets the volume to:	3380	3380 track compatibility mode.	3390	3390 mode.
Option	Sets the volume to:						
3380	3380 track compatibility mode.						
3390	3390 mode.						
Default:	<p>If you do not specify the SETMODE parameter, the device type is the default.</p> <p>If you specify the SETMODE parameter, you must specify either 3380 or 3390.</p>						
Restrictions:	<p>Valid for IBM 3390 (models 1, 2, and 3 only), and IBM 9391.</p> <p>Not valid for 9394, 9393, 9396, 9397, and Internal Disk devices.</p>						

VERIFY/NOVERIFY parameter: verify the volume serial number

Parameter/ Abbreviations	Description
VERIFY(<i>serial</i>) VFY	<p>Specify when you want to verify the volume serial number before installing a volume. If the volume serial number does not match that found on the volume, INSTALL terminates.</p> <p>For <i>serial</i>, substitute 1 to 6 alphanumeric characters for the volume serial number.</p> <p>To verify that a volume serial number does not exist, substitute the string *NONE* for <i>serial</i>. If no volume serial exists, or if the volume serial is actually “*NONE*”, the INSTALL operation continues. If a volume serial exists, the INSTALL command ends.</p> <p>If VERIFY(<i>serial</i>) parameter is specified in the INSTALL command and PARM='NOREPLYU' is specified in the EXEC card in the JCL, no operator's intervention (Reply U or T) is required.</p>
NOVERIFY NOVFY NVFY	Specify when you want to bypass verification of the volume serial number.
Default:	None.
Restrictions:	<p>The command ends:</p> <ul style="list-style-type: none"> • If you specify VERIFY and verification fails. • If you do not specify either VERIFY or NOVERIFY and a <i>volser</i> exists.

Resuming after a job or system failure

Warning

The INSTALL command must be run to complete the mode change before the volume can be used. If you issue a mode change, you must check the messages carefully to ensure the command completes.

This command should be allowed to run to completion. If processing is interrupted, restart the command. If you do not restart the command, the device might be left in an unusable state. If you subsequently try to run other ICKDSF commands on the device, ICKDSF will either ask or force you to enter an INSTALL command to return the device to its proper condition.

If INSTALL command processing is interrupted when you are converting an IBM 3390 or 9391 volume between 3390 mode and 3380 track compatibility mode (or the reverse), the device is left in an unusable state. Subsequent I/O operations to the device will fail.

Processing in a shared environment

When running the INSTALL command on a volume shared between systems, follow these guidelines:

1. Vary the device offline to the other systems.
2. Run the INSTALL command.
3. Format your volume for your operating system.
4. Vary the device back online to the other systems.

The other systems will then recognize the volume serial number and other system operating information of the volume. If you do not follow these guidelines, other systems accessing the volume may experience unpredictable results.

Examples of the INSTALL command

The following examples show different ways to code the INSTALL command.

Any values specified here are examples only and should not necessarily be interpreted as the values for your system. Most show the use of the command in offline and online mode under MVS.

SA

To install a volume in the Stand-Alone version, eliminate the MVS JCL.

VSE

To install a VSE version volume:

```
// JOB      INSTALL
// LIBDEF   PHASE,SEARCH=(IJSYSRS.SYSLIB)
// OPTION   NODUMP
// ASSGN    SYS011,D40
// EXEC     ICKDSF,SIZE=AUTO
INSTALL SYSNAME(SYS011) NVFY
/*
/ &
```

Warning

After the install process is complete, you must format the volume for use in your operating environment. To format your volume, use the:

INIT command for MVS or VSE
CPVOLUME command for VM

Installing and initializing a volume

MVS

This example does not include the VERIFY or NOVERIFY parameters for the INSTALL command. Therefore, if the volume had a volume serial, the example would not run. The volume is then formatted for use in an MVS environment.

```
//EXAMPLE JOB
// EXEC    PGM=ICKDSF
//SYSPRINT DD  SYSOUT=A
//SYSIN    DD  *
INSTALL UNITADDRESS(0353)
IF LASTCC<=4 (or <8)
THEN INIT UNIT(0353) NOVERIFY VOLID(ABCD4) NOVALIDATE
/*
```

Converting an IBM 3390 to 3380 track compatibility mode

CMS

In this example, an IBM 3390 volume is converted from 3390 mode to 3380 track compatibility mode. This example does not include the VERIFY or NOVERIFY parameters. Therefore, if the volume had a volume serial, the example would not run.

```
INSTALL UNITADDRESS(0353) SETMODE(3380)
```

VM

In the VM environment, once the mode is changed, you must vary the device offline and then online.

INSTALL command—CKD

MVS In the MVS environment, once the mode is changed, you must re-IPL the system or issue an ACTIVATE command to activate a new IODF.

Chapter 18. IODELAY command—CKD



ICKDSF issues very intensive I/O during processing. Sometimes this can degrade the performance of other users accessing the channel and impact your entire system throughput. The IODELAY command slows down ICKDSF processing by allowing time in between I/O rather than issuing consecutive I/O operations.

The IODELAY command allows you to specify:

- The number of consecutive I/Os that ICKDSF can issue
- The allowable time period between those I/Os

When ICKDSF is issued, the time delay is set to zero (same as current processing). Once you set the time delay with the IODELAY command, it remains set until you reset it.

Protecting the IODELAY command with RACF

The MVS version of ICKDSF checks the general resource profile for a facility class profile of STGADMIN.ICK.IODELAY. If RACF is not installed or the facility STGADMIN.ICK.IODELAY is not created, the IODELAY command executes with no authorization check. For additional information, see “Protecting ICKDSF commands with RACF” on page 35.

Syntax

IODELAY
Required Parameters SETIRESET
Optional Parameters PERIO(<i>n</i>) SECONDS(<i>n</i>) MSECONDS(<i>n</i>) USECONDS(<i>n</i>)

Required parameters

SETIRESET parameter: set an I/O delay

Parameter/ Abbreviations	Description
SET	Used to set a timed delay which will apply to all ICKDSF functions.
RESET	Used to reset the time delay. After issuing RESET, there is no time delay in effect.
Default:	None.
Restrictions:	None.

Optional parameters

PERIO parameter: number of I/Os scheduled

Parameter/ Abbreviations	Description
PERIO(<i>n</i>)	Allows you to specify the number of I/Os to be scheduled between each time delay. The number specified here is the number of I/Os ICKDSF will schedule before it will quiesce and allow other functions to gain control. Specify n as the number of I/Os (1 to 1000) allowed before the time interval is reactivated.
Default:	If PERIO is not specified with SET, PERIO defaults to 1.
Restrictions:	None.

SECONDSIMSECONDSIUSECONDS parameter: set the time period

Parameter/ Abbreviations	Description
SECONDS(<i>n</i>) SEC	Specifies the amount of time in seconds which is allowed between ICKDSF issuing I/Os. Specify n as the number of seconds (1 to 60) delay.
MSECONDS(<i>n</i>) MILLI MSEC	Specifies the amount of time in milliseconds which is allowed between ICKDSF issuing I/Os. Specify n as the number of milliseconds (1 to 1000) delay.
USECONDS(<i>n</i>) MICRO USEC	Specifies the amount of time in microseconds which is allowed between ICKDSF issuing I/Os. Specify n as the number of microseconds (1 to 1000) delay.
Default:	None.
Restrictions:	Under the CMS version, an I/O delay time of less than 1 second might excessively use your processor. Because of this, use the PERIO and SECOND parameters together, instead of the MSECONDS or USECONDS parameters. For example, if you want 10 I/Os with a 1-second delay: <code>IODELAY SET PERIO(10) SECONDS(1)</code>

Examples of the IODELAY command

The following example shows how to code the IODELAY command.

Any values specified here are examples only and should not necessarily be interpreted as the values for your system. The example is for offline modes under MVS.

VSE

To run IODELAY in the VSE version:

1. Replace the MVS JCL statements with VSE system control statements.
2. Substitute the SYSNAME parameter for the UNITADDRESS parameter.

Delaying 100 ms after every 20 operations with the MVS version

MVS

In this example, the IODELAY command is used to set a delay of 100 ms after every 20 ICKDSF I/O operations. This allows functions other than ICKDSF to perform during this delay. The first IODELAY command is followed by the ANALYZE command, which has a delay of 100 ms after every 20 ICKDSF I/O operations while it is processing. The second IODELAY command uses RESET, so that the medial initialization has no delay.

```
//EXAMPLE JOB
// EXEC PGM=ICKDSF
//SYSPRINT DD SYSOUT=A
//SYSIN DD *
IODELAY SET PERIO(20) MILLI(100)
ANALYZE UNITADDRESS(0151) SCAN
IODELAY RESET
INIT UNITADDRESS(0151) CYLRANGE(50,51) VALIDATE NOVERIFY
/*
```

IODELAY command—CKD

Chapter 19. PPRCOPY commands—CKD



Peer-to-Peer Remote Copy (PPRC) allows synchronous and asynchronous copying of a DASD volume from one subsystem to another subsystem volume, without host system dependencies, for those subsystems that support it.

A detailed description of PPRC can be found in *z/OS DFSMS Advanced Copy Services*, SC35-0428. You need to read this before using the ICKDSF PPRCOPY commands.

This document provides information on PPRC and on the ICKDSF PPRCOPY commands, which initiates and supports the PPRC functions:

- How PPRC works
- Using synchronous and asynchronous PPRC
- Using cascading
- Converting from one PPRC volume state to another
- PPRCOPY FAILOVER and FAILBACK
- Using Freeze/Run
- ICKDSF PPRC Command Functions
- PPRC Hardware Requirements
- PPRC Software Requirements
- PPRC Restrictions
- Setting Up the PPRC Environment
- PPRCOPY commands

ESTPATH –Establishes ESCON® and fibre channel protocol (FCP) paths between two subsystems

DELPATH –Deletes ESCON and FCP paths between two subsystems

ESTPAIR –Establishes remote copy device pairs

DELPAIR –Deletes remote copy device pairs

SUSPEND –Suspends pairs

RECOVER –Reestablishes access to a secondary volume

QUERY –Queries status

- Establishing and managing PPRC volumes and paths

Protecting the PPRCOPY command with RACF

The MVS version of ICKDSF checks the general resource profile for a facility class profile of STGADMIN.ICK.PPRCOPY. If RACF is not installed or the facility STGADMIN.ICK.PPRCOPY is not created, the PPRCOPY command executes with no authorization check. For additional information, see “Protecting ICKDSF commands with RACF” on page 35.

How PPRC works

There are two flavors of PPRC; cascading and non-cascading.

Non-cascading

The primary subsystem (application site) establishes the ESCON/FCP paths and links to a secondary subsystem (recovery site) and manages the copying of a DASD volume from the primary site to the secondary site either synchronously or asynchronously depending on the option specified when the pair was created.

From the primary host, the I/O operation to the secondary subsystem is transparent. A single interrupt is presented to the host to indicate successful completion of the operation.

Cascading

Cascading is a situation where a PPRC secondary volume serves as PPRC primary volume in another PPRC relationship. The same volume serves as both. So a cascaded triad could be represented as follows.

A -> B -> C

Where volumes A and B form the so called local pair and volumes B and C form the remote pair. Volume A is the primary of the local pair, volume C is the secondary of the remote pair, and volume B is both the secondary of the local pair and the primary of the remote pair. The primary subsystem manages the copying of the volume from the primary site to the intermediate site and the intermediate subsystem manages the copying between the intermediate site to the remote site.

Although the subsystem manages virtually all the operation, PPRCOPY provides the means to initiate and terminate the functions, suspend a copy operation, query the status of volumes, and provide to a recovery host the ability to recover control of the secondary volume.

Managing asynchronous PPRC: extended distance mode

When the PPRC extended distance feature is installed and enabled on the ESS, it provides an alternate to synchronous PPRC. It also adds a new alternative in the ESS-to-ESS data mirroring capabilities. When PPRC extended distance is enabled, updates made to a PPRC primary volume are sent to a secondary volume asynchronously. This helps minimize the impact on application throughput. When the PPRC extended distance feature is enabled, the primary and recovery storage control sites can be separated by very long distances. Channel extender technology can be used to link the primary and recovery storage control sites. This technology allows these systems to be connected over large distances by using less expensive telecommunication lines, with little performance impact. Therefore, if your environment has bandwidth restrictions or has extended distance requirements, you may want to consider PPRC extended distance. When operating in extended distance mode, the primary volume sends a periodic, incremental copy of updated tracks to the secondary volume instead of a constant stream of updates. This causes less impact to application writes for primary volumes and less demand for bandwidth resources, while allowing a more flexible use of the available bandwidth. In addition, the lower bandwidth requirement creates the potential for worldwide distance capability when using channel extenders.

Understanding how PPRC extended distance works

During an extended distance operation, the ESS captures information about updates to the primary and periodically sends those updates to the secondary. After the initial copy of tracks, the ESS periodically starts a synchronization cycle where all updated tracks, in ascending order from the lowest numbered track, is copied from the primary volume to the secondary volume.

The ESS updates the secondary tracks with the current information for that track, regardless of the number of updates between the time it was last copied, the current time, and the order in which the updates occurred. When this process completes, the cycle is repeated. There is little response time degradation on application I/O while operating in extended distance mode. Write updates to the primary volume receive an immediate completion because the synchronization cycle is independent of the primary write updates.

Setting up your environment to use PPRC extended distance

There are three requirements for setting up your environment to use PPRC extended distance mode:

- A PPRC link must be active between the primary storage control and recovery storage control.
- A PPRC volume pair must be established with PPRCOPY ESTPAIR OPTION(XD).
- The primary and secondary devices must be in SIMPLEX state or in SUSPEND state at the beginning of the process.

Using PPRC extended distance

The following sections contain information about using PPRC extended distance.

Establishing PPRC volume pairs

The PPRCOPY ESTPAIR command allows you to establish a PPRC volume pair using PPRC extended distance mode and then transition the volume pair to synchronous mode. The command now includes an OPTION parameter with the following values.

SYNC: This value establishes a PPRC volume pair in synchronous mode. In this mode, the volume pair reaches DUPLEX status after the initial copy of the volume pair is completed and the primary updates are mirrored synchronously with the I/O in progress. As a consequence, there is propagation overhead, manageable under 103 km, but which becomes progressively significant at very long distances. If a volume pair is established in extended distance mode, specifying this value causes the volume pair to change to synchronous mode.

XD: This value establishes a PPRC volume pair in extended distance mode. In this mode, the volume pair does not reach DUPLEX state after the initial copy of the volume pair is completed. The volume remains in a PENDING XD state. The primary volume updates complete before they are mirrored to the secondary volume. These track updates are recorded into a bitmap and periodically copied to the secondary volume. As a consequence, there is no guarantee that application dependent writes are transferred in the same sequence that they have been applied to the primary volume. Because the contents of the copy are uncertain, the secondary copy is described as being fuzzy, as shown in "Converting from one

PPRCOPY commands—CKD

PPRC volume state to another” . Because mirroring in extended distance mode is done asynchronously with PPRC volume pairs, CRIT(YES) is not valid for a volume pair established with OPTION(XD).

Using synchronous and asynchronous PPRC

The enhanced flexibility with synchronous PPRC means that you can have some volume pairs established in synchronous mode and others in PPRC extended distance mode. For example, if you have an environment with restricted bandwidth but have volumes that are critical to your operation, you can establish those volumes in synchronous mode. Synchronous mode allows the recovery storage control to remain current with the primary storage control, which is critical should a disaster occur. Less critical volumes can be established in PPRC extended distance mode.

In addition, you might also consider using PPRC in synchronous and extended distance modes of operation during peak and nonpeak hours. For example, you might consider using PPRC extended distance mode during peak work hours when minimal performance impact to primary applications is an important requirement. Then, during nonpeak hours, you can use synchronous mode, which allows your data to remain current at the recovery site in the event that an unplanned outage or disaster occurs. Another use of the synchronous and extended distance modes are in a cascading triad, where the connection between the local primary and the intermediate secondary is a synchronous one and that between the intermediate primary and the remote secondary is extended distance. The synchronous connection between the local primary and the intermediate secondary ensures that the two volumes are exact copies of each other. The extended distance connection between the intermediate primary and the remote secondary avoids the performance impact the primary site would otherwise experience in waiting for the I/O to complete on the remote secondary and requires much less bandwidth to operate.

Using cascading

PPRC cascading is a PPRC mode where a single volume can be both a PPRC primary and a secondary. This allows for disaster recovery situations in which a primary volume can be PPRCed to a secondary volume, which at the same time is operating as a PPRC primary volume.

The intended benefits of such an arrangement are:

- Long distance remote copy solution with the performance impact of only a short distance synchronous PPRC
- Three or two site configuration options where three sites provide zero data loss
- The intermediate site can be within synchronous PPRC distance, but isolated such that a disaster at the local site would be unlikely to affect the intermediate site
- The remote site may be any distance away from the intermediate site
- Local to intermediate connection is PPRC-SYNC so the intermediate site is an exact copy of the local site

A cascading configuration can be represented as follows:

A -> B -> C

Where volumes A and B form the so called local pair and volumes B and C form the remote pair. Volume A is the primary of the local pair, volume C is the secondary of the remote pair, and volume B is both the secondary of the local pair

and the primary of the remote pair. The primary subsystem manages the copying of the volume from the primary site to the intermediate site and the intermediate subsystem manages the copying between the intermediate site to the remote site.

The individual pairs can be configured in synchronous or extended distance mode. The allowed configurations are as follows:

- SYNC -> XD

Where there is a synchronous PPRC relationship from the local site to the Intermediate site, and then an extended distance PPRC relationship from the intermediate site to the remote site. In this case, the Intermediate site is an exact copy of the local site. If there is an outage at the local site, the intermediate site still contains all of the data. The intermediate site would complete sending the updates to the remote site and then the remote site would have a copy of the data up to the time of failure.

- XD -> XD

Here there is an extended distance relationship from the local site to the intermediate site, and an extended distance relationship from the intermediate site to the remote site.

- SYNC -> SYNC

It is allowed to have the local site to intermediate site be synchronous PPRC and the intermediate site to remote site also be synchronous, although this will have a performance impact on the host I/O.

If FCP paths are established between the local pair and the pair is then established in synchronous mode then the remote pair should be established in extended distance (XD) mode regardless of the pathing protocol used. If the remote pair is established in synchronous mode any I/O directed to the local primary will result in the remote pair being suspended. In such a case the remote pair should be reestablished in XD mode.

FCP synchronous to synchronous mode is allowed to accommodate situations such as the following.

A local pair is established FCP synchronous and it's remote pair in XD mode. At some later time backups at the remote secondary site are desired. To accomplish this the local pair could be FROZEN, which suspends the local primary. The remote pair can then be converted to synchronous mode with the ESTPAIR command. Once the volumes become synchronized the backups can be taken. Once the backups are completed, the remote pair can be returned to XD mode, the RUN command would then be issued to the local primary and paths and the pair could then be reestablished.

- XD-> SYNC

It is not allowed.

Establishing PPRC cascaded pairs

Cascade is a new keyword used in conjunction with the PPRC ESTPAIR command.

The cascaded volumes can be established in either order:

- Recommended order
 1. Establish remote pairs with NOCOPY
 2. Establish local pairs
- Alternate order
 1. Establish local pairs
 2. Wait for the volumes to go **Full Duplex**

PPRCOPY commands—CKD

3. Establish remote pairs

Note: It is possible to do other combinations, for example, in the first case above, the remote pairs do not have to be established with **NOCOPY**, but it is a waste of bandwidth to do so.

A pair can be made eligible to be a cascaded pair at the time the pair is established or at a later time. What this means is that when a PPRC pair is initially established, the user can indicate that the pair is eligible for cascading. For an already established pair, the user can issue an establish command that makes it a cascaded pair without breaking the existing pair to do the reestablish.

Some examples of this are shown below, where, SITEA is the local site, SITEB is the intermediate site and SITEC is the remote site:

- SITEB -> SITEC is initially established with the indication that the volume at SITEB is eligible for cascading. When SITEA -> SITEB is established, this now becomes a cascaded relationship.
- SITEB -> SITEC was already established without the indication that it is eligible for cascading. An establish is reissued to the volume at SITEB to indicate that it is eligible for cascading, and the pair remains established. Then SITEA -> SITEB can be established, without breaking the SITEB -> SITEC pair. This now becomes a cascaded relationship.
- SITEA -> SITEB is already established. Then SITEB -> SITEC can be established with an indication that the volume at SITEB is eligible for cascading, without breaking the SITEA -> SITEB pair. This now becomes a cascaded relationship.

Long distance data migration

You can use PPRC extended distance for long distance data migration. During the migration, application updates from the primary to the secondary can still occur. When the migration copy is complete, you can quiesce the applications to ensure that no further updates occur and that the updates are on the migration volumes. You can use the new volumes to start your applications at the new location.

Converting from one PPRC volume state to another

You can convert PPRC volume pairs from PPRC extended distance mode to synchronous mode and vice versa on regular PPRC pairs as well as on cascaded pairs. A switch to synchronous mode can be done using the PPRCOPY ESTPAIR command while the volume pair is active or after the volume pair has been suspended. Figure 28 on page 201 and Table 46 on page 201 explain the commands used to convert between PPRC states, including PPRC extended distance. Each number in the figure is listed in the table with the appropriate command for that state change.

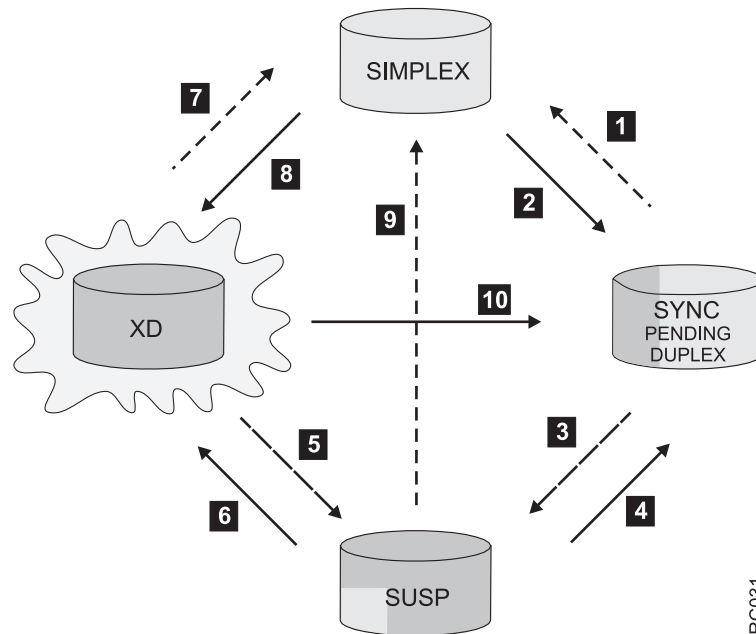

Figure 28. Volume state transitioning

Table 46. Transitioning between volume states

	To transition from...	To...	Use the following command:
1	SYNC	SIMPLEX	DELPAIR
2	SIMPLEX	SYNC	ESTPAIR
3	SYNC	SUSP	SUSPEND
4	SUSP	SYNC	ESTPAIR MODE(RESYNC)
5	XD	SUSP	SUSPEND
6	SUSP	XD	ESTPAIR MODE(RESYNC) OPTION(XD)
7	XD	SIMPLEX	DELPAIR
8	SIMPLEX	XD	ESTPAIR MODE(COPY) OPTION(XD)
9	SUSP	SIMPLEX	DELPAIR
10	XD	SYNC	ESTPAIR OPTION(SYNC)

Notes:

1. To go from synchronous PPRC to PPRC extended distance mode (pending-XD), the pair must be in a suspended state, and then you can do an ESTPAIR and specify MODE(RESYNC) and OPTION(XD).
2. To go from PPRC extended distance mode (pending-XD) to synchronous PPRC, the pair must be in a pending-XD state, and then you can do an ESTPAIR and specify OPTION(SYNC).
3. To go to PPRC extended distance mode (pending-XD) from a suspended state, you can do an ESTPAIR with MODE(RESYNC) and OPTION(XD).

Monitoring PPRC volume pairs

To monitor the copy process of PPRC volumes, issue the QUERY command. When PPRC extended distance is enabled, you should monitor volumes that have the most out-of-sync tracks waiting to be transmitted because of the delays introduced before updates are received by the recovery site. The amount of data lost during a disaster increases with the number of out-of-sync tracks.

PPRCOPY FAILOVER and FAILBACK

PPRC FAILOVER and FAILBACK allows for reversing the direction of PPRC on regular PPRC pairs. The reason you would want to use FAILOVER is to provide access to the data from the secondary site if the primary site fails.

When the primary site access is lost, FAILOVER is issued to PPRC secondary volumes to become PPRC primary volumes and enter a suspended state. No checking for secondary volume is performed and no active paths to the secondary are required. If the volumes are in full duplex or suspended state, it will go into PPRC FAILOVER mode without requiring the PPRC pair to be deleted. When the primary site is accessible again, PPRC paths are established from the secondary site to the primary site and FAILBACK is issued to the volume at the secondary site to perform resynchronization.

Using Freeze/Run

PPRC Freeze/Run is designed for data base consistency automation.

The PPRC FREEZE command is issued to control operations for multiple PPRC volume pairs on a **single storage control**. This allows you to suspend all operations for all PPRC volumes on a single storage control. You must issue a separate FREEZE command to suspend operations on each storage control.

FREEZE specifies that PPRC stop all updates to secondary storage controls that are related to this volume pair. PPRC does not allow any activity to the secondary volumes. All the paths will be removed for the secondary controller.

The PPRC RUN command indicates that the necessary work has been completed to ensure secondary PPRC volume consistency across all controllers and devices that are related.

RUN is issued to control operations for multiple PPRC volume pairs on a single storage control. This allows you to resume all operations for all PPRC volumes on a single storage control. You must issue a separate RUN command to resume operations on each storage control.

Once the PPRC RUN command has been successfully performed the paths and pairs must be reestablished.

ICKDSF Peer-to-Peer Remote Copy command functions

ICKDSF PPRC commands initiate PPRC subsystem activity. Table 47 on page 203 shows the PPRC ICKDSF commands and the devices to which they can be issued. Commands are processed in the order that they are issued.

Table 47. PPRCopy ICKDSF commands

Command	Function	Issue to Primary Device?	Issue to Secondary Device?
ESTPATH	Establishes ESCON/FCP paths between an application site (source) storage control and a recovery site (target) storage control.	Yes	No (unless cascaded intermediate)
DELPATH	Deletes all established ESCON/FCP paths between an application site (source) storage control and a recovery site (target) storage control.	Yes	No (unless cascaded intermediate)
ESTPAIR	Establishes a remote copy device pair.	Yes	No (unless cascaded intermediate)
DELPAIR	Removes primary and secondary volumes from PPRC and returns the devices to a simplex state.	Yes	No (unless cascaded intermediate)
RECOVER	Allows the recovery site (target) system to regain control of a DASD volume on its storage control.	No (unless cascaded intermediate)	Yes
SUSPEND	Suspends PPRC operation between a primary and secondary volume pair.	Yes	Yes
QUERY	Queries the status of one volume of a PPRC volume pair and the status of paths associated with the storage control for the addressed device.	Yes	Yes

Peer-to-Peer Remote Copy hardware requirements

Peer-to-Peer Remote Copy hardware requirements for 3990 are:

- A 3990 Model 6 with PPRC licensed internal code (LIC) is required to be installed on both application and recovery site storage control units
- Physical ESCON connections between PPRC storage subsystems

Peer-to-Peer Remote Copy is supported by the following devices when they are attached to a 3990 Model 6 with remote copy-capable LIC:

- All models of the IBM 3390 DASD
- RAMAC Array DASD

Peer-to-Peer Remote Copy hardware requirements for RVA (9393) are:

- A RVA (9393) with PPRC licensed internal code (LIC) is required to be installed on both application and recovery site storage control units
- Physical ESCON connections between PPRC storage subsystems

Peer-to-Peer Remote Copy is supported by all devices that can be attached to a RVA (9393) with remote copy-capable LIC.

Peer-to-Peer Remote Copy hardware requirements for 2105 are:

- A 2105 with PPRC licensed internal code (LIC) is required to be installed on both application and recovery site 2105 devices
- Physical ESCON/FCP connections between PPRC storage subsystems

PPRCOPY commands—CKD

- To establish pairs in extended distance mode, or to use the ESUSP parameter, the PPRC licensed internal code (LIC) for PPRC-extended distance support is required to be installed on both application and recovery site 2105 devices.

Peer-to-Peer Remote Copy (PPRC) restrictions

The RVA does not support parallel channels on subsystems that support PPRC. RVA does not support cascading or FAILOVER/FAILBACK.

Primary and secondary volumes may either be members of a PPRC pair or a dual copy pair, but not both, on a 3990-6.

An application system volume (primary) can be copied to only one secondary volume. A PPRC volume can be only primary or secondary; it cannot be used for both functions at the same time. If the device is a 2105 at the appropriate level of microcode, for example cascading is supported, then a volume can be both a primary and secondary volume at the same time.

A 3990 Model 6 can be the application storage control for some volumes and the recovery storage control for other volumes at the same time.

ESCON paths established by PPRC provide connections between two or more 3990-6s. Specifically, a single path can be established, **in one direction**, to transfer a volume or volumes from, say, storage subsystem A to storage subsystem B. The same logical and physical path established from A to B **cannot** be used to transfer data from B to A; however, a separate path can be established to transfer data from subsystem B to subsystem A.

PPRC secondary volumes act much like 3990 dual copy secondary volumes in that no read or write access is permitted. IBM recommends that you vary the attached secondary volumes offline to all attached systems. The PPRC secondary volume IDs are the same as those on the application system (primary) volumes.

On RAMAC Array DASD, the dynamic sparing feature of RAMAC Array DASD is automatically disabled when the RAMAC volume is a member of a dual copy or PPRC volume pair.

VM Note: When operating as a guest under VM:

- All PPRC volumes must either be dedicated volumes, or defined as fullpack minidisks (including DEVNO-defined minidisks).
- The VM guest directory must include an entry stating “STDEVOPT DATAMOVER=YES”.

Adding DASD channel extenders to a PPRC configuration to support longer distances can seriously degrade the performance due to the additional time added to each copy write I/O. IBM therefore does not generally recommend using DASD channel extenders with PPRC.

Setting up the PPRC environment

This section describes how to set up the Peer-to-Peer Remote Copy environment, including how to:

- Identify volume pairs
- Establish the PPRC configuration
- Configure the storage subsystems for PPRC

- Control ICKDSF activity to PPRC volumes

Identifying volume pairs

The storage administrator must identify application volumes to copy, and create Peer-to-Peer Remote Copy volume pairs. PPRC provides an image copy of a volume on a record-for-record basis, with a one-to-one correspondence between the record on the primary volume track and the record on the secondary volume track. Because PPRC writes data on the same tracks on the secondary DASD as it does on the primary DASD, the secondary DASD must have the same track sizes and number of tracks per cylinder, and the same or larger volume capacities, as the primary. If these criteria are not met, the PPRCOPY ESTPAIR command will fail.

Secondary volumes must be dedicated to PPRC use only and should be varied offline to its host system. PPRC secondary volumes are similar to 3390 dual copy secondary volumes in that all read and write host operations directed to these secondary volumes will be rejected.

Remote copy supports volumes, not data sets. As a result, all data sets on the volumes that are copied are part of remote copy activity, and are therefore copied to the recovery system. This support is application (IBM or non-IBM) independent and supports all data set types.

Because applications deal with data sets and not volumes, multivolume data sets require special attention. (Multivolume data set types include data sets that reside on multiple volumes, and for MVS, striped data sets, and VSAM spheres.) Unless all volumes of a multivolume data set are copied, then only part of the data set will be copied. Other data sets on the copied volume may be usable, but the multivolume data sets will not be. If multivolume data sets are critical for recovery, you must also copy the other volumes on which these data sets reside.

Carefully choose the volumes to copy so as not to unnecessarily impact overall PPRC performance. For example, copying a volume containing page or other data sets specific to the application host system would not be a good use of PPRC resources; copying page data sets can impact performance.

Establishing the PPRC configuration

Plan your configuration to provide for capacity and redundancy requirements. Peer-to-Peer Remote Copy allows from one to four ESCON paths (IBM recommends at least two paths) from any application site storage control to a single recovery site storage control. A specific application site storage control can be attached to up to four different recovery site storage controls. A single 3990 subsystem at the recovery site, however, can be linked to a maximum of 64 application site 3990s. A large cache and nonvolatile storage (NVS) will help the recovery site 3990 to accept the copy workloads from multiple application site storage subsystems.

With the necessary licensed internal code installed in each 3990 Model 6 Storage Control, RVA, or 2105, you can establish PPRC paths between these devices. You can either install dedicated ESCON channels between the 3990, RVA, or 2105, or use existing ESCON channels that are connected by a common ESCON Director or Directors.

The devices connected must be of the same type. That is, a 3990 must be connected to a 3990, an RVA to an RVA, and a 2105 to a 2105.

PPRCOPY commands—CKD

An ESCON path being used by PPRC may also be used by a host to access a 3990, if that path is switched through an ESCON Director. This is not true for RVA or the 2105.

For 3990 Model 6 and RVA, up to four paths can be established between a pair of storage controllers with each ICKDSF PPRCOPY ESTPATH command. Eight paths can be established with each ICKDSF PPRCOPY ESTPATH command for 2105. The following information is required before you can issue a PPRCOPY ESTPATH command:

- Primary device number
- Primary device's storage subsystem ID (SSID)
- Primary device's storage control serial number
- Recovery storage subsystem ID (SSID)
- Recovery storage control serial number
- Link addresses between the two control subsystems
- Logical control unit number for RVA
- Logical subsystem number for 2105

Configuring storage subsystem resources for PPRC

Properly configured Peer-to-Peer Remote Copy resources provide the following benefits:

- Avoid unintended interruptions to remote copy resources
- Maximize data integrity on the secondary volumes
- Minimize impact on system performance as a result of remote copy activity

The following sections address these concerns.

Configuring the 3990 storage controls

The following 3990 configuration options can affect PPRC operations at both sites:

- Availability of cache and NVS
- VPD settings for SIM alert reporting level

There are additional concerns for the storage controls at the recovery site:

- Attachment to at least one host for SIM reporting
- Use of remote power sequence control cables

Availability of cache and NVS

If commands that alter NVS or cache states are issued to a storage control with PPRC-managed volumes, all volume pairs managed by that storage control are put into suspended duplex state, or ended. Because of this, be careful when using caching commands that deactivate the NVS or cache on 3990s that contain remote copy operations. Table 48 shows when NVS and cache are required to run PPRC. PPRC on the RVA is not affected by subsystem settings for cache and NVS.

Table 48. 3990 NVS and cache requirements for PPRC

For 3990 Model 6 at:	Subsystem Cache	NVS	Volume Cache	DASD Fast Write
Application site	Required	Required	Recommended	Recommended
Recovery site	Required	Required	Required	Required

3990 VPD settings for SIM alerts

Specify that the VPD for all 3990 with PPRC operations is set so that SIM alert messages are routed to a host system console. Do not select "No Alerts", as this option prohibits the 3990 from sending any SIM alert messages to attached host systems. In the event of a subsystem failure that affected PPRC operation (such as

a permanent error on a secondary volume), the subsystem must be able to alert an operator to the problem. This is especially critical at an unattended recovery site where a subsystem problem, if left unresolved, can jeopardize the entire PPRC copy operation.

Recovery site 3990 attached to a host system

IBM recommends that you keep at least one host system attached to each recovery site 3990 Model 6. This is necessary so that the 3990s for the secondary volumes can offload important SIMs in the event of a problem on the recovery storage subsystem.

Use of Remote Power Sequence Control Cables: Make every effort to minimize power interruptions to PPRC recovery site 3990 Model 6 Storage subsystems. IBM recommends that you do not use power sequence control cables between recovery site processors and attached 3990 Storage Controls that contain PPRC secondary volumes.

These cables, when installed, allow an attached host processor to remotely remove power from the 3990 Model 6 Storage Control. If power sequence control cables are present, ensure that the power select switches (located on the 3990 power sequence control board) for both clusters are set to the “LOCAL” position. This setting removes the possibility that a processor at the recovery site can inadvertently power down a PPRC recovery storage subsystem.

Accessing PPRC secondary volumes

All PPRC secondary volumes are dedicated exclusively to PPRC use. Any host read or write access is automatically rejected regardless of whether the secondary volume is online or offline.

Controlling ICKDSF activity to PPRC volumes

The storage administrator must control ICKDSF activity to primary and secondary PPRC-managed volumes. Some ICKDSF operations are not copied from the primary to secondary volumes. If ICKDSF is used to perform Media Maintenance functions on either a primary or secondary volume, remove the volume pair and reinitialize it with a PPRCOPY ESTPAIR operation.

Performing an ICKDSF repair on a PPRC-managed primary volume

To perform an ICKDSF repair on a PPRC-managed primary volume, proceed as follows:

Warning

Failure to follow step 1 through step 3 may result in potential data integrity exposures to offline volumes.

1. Issue the PPRCOPY SUSPEND command to the primary volume of the pair.
Note: The volume may have already been suspended by the error when it first occurred.
2. When the pair is in the suspended state, use the recommended ICKDSF media maintenance procedure to correct the error.
3. Remove the volumes from the suspended state, using the PPRCOPY ESTPAIR command with the MODE(RESYNC) parameter, to resume operations.
The RESYNC option specifies that all changed cylinders are copied to the secondary volume.

Performing an ICKDSF repair on a PPRC-managed secondary volume

To perform an ICKDSF repair on a PPRC-managed secondary volume, proceed as follows:

Warning

Failure to follow the step 1 through step 4b may result in potential data integrity exposures to offline volumes.

1. Issue the PPRCOPY SUSPEND command to the secondary volume of the pair, allowing change recording to continue.
2. Issue the PPRCOPY RECOVER command to the secondary volume, so repairs can be made. PPRC puts the volume into simplex state to permit I/O access.
3. Use the recommended ICKDSF media maintenance procedure to correct the error.
4. Issue the PPRCOPY ESTPAIR command:
 - a. If no data has been changed on the secondary volume, issue the PPRCOPY ESTPAIR command with the MODE(RESYNC) parameter.
The RESYNC option specifies that all changed cylinders are copied to the secondary volume.
 - b. If the repair action has caused the data to be changed on the secondary volume, issue the PPRCOPY ESTPAIR command with the MODE(COPY) parameter.

PPRCOPY ESTPATH—establishing paths

Use the ESTPATH command to establish ESCON or FCP paths between an application site (source) storage control and a recovery site (target) storage control.

Each ESTPATH command can establish up to four paths from one application site storage control to a single recovery site storage control for 3990-6 and RVA. For the 2105, each ESTPATH command can establish up to eight paths from one application site storage control to a single recovery site storage control.

The storage control for a specific primary (source) volume can, at any one time, be linked to a maximum of four storage control units for secondary (target) volumes. You need to use a separate PPRCOPY ESTPATH command to establish paths between each pair of controllers.

The ESTPATH command is a “replace” function. Specified paths that establish a link between an application site storage control and a recovery site storage control replace any previously established PPRC paths. The paths you specify each time you issue a ESTPATH command replace the paths established by the last ESTPATH command issued.

Mixing of FCP and ESCON paths between logical control units (designated by the LSS values) is not allowed. So, for example, it is possible to establish FCP paths between LSS A and LSS B, and to establish ESCON paths between LSS A and LSS C. But it is not possible to establish FCP paths between LSS A and LSS B and ESCON paths between the same two LSSs.

| If a switch from one type of path to the other type is desired then the paths must be
| disestablished using the DELPATH command and reestablished using the
| ESTPATH command.

| For ESCON paths, the replacement takes place for the paths of the two
| subsystems, uniquely identified by their SSID and serial number. When other paths,
| which belong to other controllers, are present, they remain undisturbed. For FCP
| paths, the replacement takes place for the paths of the two subsystems, uniquely
| identified by their SSID and world wide node name (WWNN).

| In a cascaded triad, if FCP paths are established between the local pair and the
| pair is established in synchronous mode then the remote pair should be established
| in extended distance (XD) mode. If the remote pair is established in synchronous
| mode any I/O directed to the local primary will result in the remote pair being
| suspended. In such a case the remote pair should be reestablished in XD mode.
| See “Using cascading” on page 198 for additional information.

Syntax

PPRCOPY ESTPATH
Required Parameters DDNAME(<i>dname</i>) SYSNAME(<i>sysxxx</i>) UNITADDRESS(<i>ccuu</i>) PRIMARY(<i>ssid,ser#</i>) SECONDARY(<i>ssid,ser#</i>) FCPPATHS(<i>path1,...,path8</i>) WWNN(<i>pwwnn,swwnn</i>) LINK(<i>linkaddr1...linkaddr8</i>)
Optional Parameters CGROUP(NOIYES) FORCE LSS(<i>X'pp',X'ss</i>)

Required parameters

DDNAME|SYSNAME|UNITADDRESS parameter: identify the primary volume

Parameter/ Abbreviations	Description
DDNAME(<i>dname</i>) DNAME	Required for an online MVS volume. The volume must be online. For <i>dname</i> , specify the MVS JCL statement that identifies the volume.
SYSNAME(<i>sysxxx</i>)	Required for a VSE volume when executing ICKDSF in batch mode; the volume must be online. For <i>sysxxx</i> , specify the SYSNAME in the ASSGN system control statement.
UNITADDRESS(<i>ccuu</i>) UNITADDR UNIT	<p>Required for an offline MVS volume, a Stand-Alone volume, and a VM volume. For VSE, it is required when executing ICKDSF in command mode; the volume must be online.</p> <p>In MVS, the volume must be on a path that is online. If the volume is on a path that is offline, the program might enter a nonterminating wait state. For <i>ccuu</i>, specify the address (3 or 4 hex digits) of the channel and unit of the volume.</p> <p>For the CMS version, specify the virtual address of the dedicated volume or fullpack minidisk.</p> <p>The unit address is the device number.</p>
Default:	None.
Restrictions:	None.

PRIMARY and SECONDARY parameter: identifies control unit

Parameter/ Abbreviations	Description
PRIMARY(<i>ssid,ser#</i>) PRIM PRI	<p>Specifies the application site storage control subsystem ID and serial number.</p> <p>The storage control subsystem ID (<i>ssid</i>) is a 4-digit hexadecimal address.</p> <p>The <i>ser#</i> is the storage control serial number, and is the last five digits of the 12-digit machine serial number for 3990 and 2105 or the last seven digits of 12-digit machine serial number for RVA.</p> <p>The storage control subsystem id, and storage control serial number may be obtained with the CONTROL CONFIGURE(DISPLAY) command for 3990 and 2105 or PPRCOPY QUERY without the PATHS parameter for RVA.</p>
SECONDARY(<i>ssid,ser#</i>) SEC	Specifies the recovery site storage control subsystem ID (<i>ssid</i>) and serial number. The descriptions for the values are the same as for the PRIMARY parameter.
Default:	None.
Restrictions:	None.

FCPPATHS parameter: establishes PPRC with Fibre Channel Protocol (FCP) paths

Parameter/ Abbreviations	Description
FCPPATHS(<i>path1</i> ,... <i>path8</i>) FCPPS FCPP	<p>The FCPPATHS parameter is specified to indicate that PPRC is to be established with FCP (Fibre Channel Protocol) paths.</p> <p>Specifies the addressing path from the application site storage control to the recovery site storage control. Up to 8 paths can be specified. Each path is an 8-digit hexadecimal address in the form X'aaaabbbb' where:</p> <ul style="list-style-type: none"> 'aaaa' is the Primary volume's cluster interface system adapter ID (SAID) 'bbbb' is the secondary volume's (destination) SAID <p>When FCPPATHS is specified, the WWNN parameter is required.</p>
Default:	None.
Restrictions:	<p>FCP paths and ESCON paths cannot be established between the same PPRC pair or in the same ESTPATH command. Therefore, the FCPPATHS parameter is not valid with the LINK parameter.</p> <p>FCPPATHS is only supported on 2105 with the PPRC FCP microcode support. If the device is not an ESS, or if the device is an ESS without the PPRC-FCP support, then message ICK31054I 'DEVICE NOT SUPPORTED FOR SPECIFIED FUNCTION' is issued and the command is terminated.</p>

WWNN parameter: establishes the World Wide Node Name (WWNN) of the primary and secondary

Parameter/ Abbreviations	Description
WWNN(<i>pwwnn</i> , <i>swwnn</i>)	<p>Specifies the World Wide Node Name (WWNN) of the Primary and Secondary. Each WWNN is an 8-byte hexadecimal value <i>wwnnnnnnnnnnnnnnnnnn</i>. <i>pwwnn</i> represents the primary WWNN and <i>swwnn</i> represents the Secondary WWNN.</p> <p>The WWNN can be determined from using the ICKDSF PPRC QUERY PATHS command.</p>
Default:	None.
Restrictions:	Although the WWNN value is a hex value the leading X' and the trailing apostrophe are not allowed in the specification of the value.

LINK parameter: specifies the addressing path

Parameter/ Abbreviations	Description																																		
LINK(<i>linkaddr1...</i> <i>linkaddrx</i>)	<p>LINK specifies the addressing path from the application site storage control to the recovery site storage control. Up to four path addresses can be specified with each LINK parameter. Each path address is an 8-digit hexadecimal address in the form X'aaaabccc' where:</p> <p>For 3990</p> <p>aaaa Primary volume's 3990 Cluster/Interface "SAID" as shown below.</p> <p>bb ESCON Director "DESTINATION" address. "00" if directly attached pair of DASD control units or with static ESCON switch.</p> <p>cc Always "00" for a 3990-06.</p> <p>The LINK parameter address consists of:</p> <ul style="list-style-type: none"> An application system SAID (System Adapter ID) interface identifier, aaaa in this example, that uniquely identifies the physical location of the associated node interface. Corresponding to ESCON channel interfaces A through H, for each of the clusters, the SAID bytes are: <table border="0" data-bbox="451 716 834 1163"> <thead> <tr> <th>3990 Cluster/Interface</th> <th>SAID Bytes</th> </tr> </thead> <tbody> <tr><td>0 Interface A</td><td>X '0000'</td></tr> <tr><td>0 Interface B</td><td>X '0001'</td></tr> <tr><td>0 Interface C *</td><td>X '0002'</td></tr> <tr><td>0 Interface D *</td><td>X '0003'</td></tr> <tr><td>0 Interface E</td><td>X '0004'</td></tr> <tr><td>0 Interface F</td><td>X '0005'</td></tr> <tr><td>0 Interface G *</td><td>X '0006'</td></tr> <tr><td>0 Interface H *</td><td>X '0007'</td></tr> <tr><td>1 Interface A</td><td>X '0010'</td></tr> <tr><td>1 Interface B</td><td>X '0011'</td></tr> <tr><td>1 Interface C *</td><td>X '0012'</td></tr> <tr><td>1 Interface D *</td><td>X '0013'</td></tr> <tr><td>1 Interface E</td><td>X '0014'</td></tr> <tr><td>1 Interface F</td><td>X '0015'</td></tr> <tr><td>1 Interface G *</td><td>X '0016'</td></tr> <tr><td>1 Interface H *</td><td>X '0017'</td></tr> </tbody> </table> <p>* These ports are supported on 3990-6s with 4-port ESCON SA cards.</p> <ul style="list-style-type: none"> A recovery site storage control ESCON link destination address, bb in this example. If the ESCON Director is installed, it assigns the recovery site storage control ESCON link destination address (bb). For direct fiber optic cable connections between storage controls or static connections through an ESCON Director, the link address value is zero. A reserved address, cc in this example, which must be 00. 	3990 Cluster/Interface	SAID Bytes	0 Interface A	X '0000'	0 Interface B	X '0001'	0 Interface C *	X '0002'	0 Interface D *	X '0003'	0 Interface E	X '0004'	0 Interface F	X '0005'	0 Interface G *	X '0006'	0 Interface H *	X '0007'	1 Interface A	X '0010'	1 Interface B	X '0011'	1 Interface C *	X '0012'	1 Interface D *	X '0013'	1 Interface E	X '0014'	1 Interface F	X '0015'	1 Interface G *	X '0016'	1 Interface H *	X '0017'
3990 Cluster/Interface	SAID Bytes																																		
0 Interface A	X '0000'																																		
0 Interface B	X '0001'																																		
0 Interface C *	X '0002'																																		
0 Interface D *	X '0003'																																		
0 Interface E	X '0004'																																		
0 Interface F	X '0005'																																		
0 Interface G *	X '0006'																																		
0 Interface H *	X '0007'																																		
1 Interface A	X '0010'																																		
1 Interface B	X '0011'																																		
1 Interface C *	X '0012'																																		
1 Interface D *	X '0013'																																		
1 Interface E	X '0014'																																		
1 Interface F	X '0015'																																		
1 Interface G *	X '0016'																																		
1 Interface H *	X '0017'																																		

Parameter/ Abbreviations	Description																																																			
LINK(<i>linkaddr1...</i> <i>linkaddrx</i>)	<p>LINK specifies the addressing path from the application site storage control to the recovery site storage control. Up to four path addresses can be specified with each LINK parameter. Each path address is an 8-digit hexadecimal address in the form X'aaaabccc' where:</p> <p>For RVA</p> <p>aaaa Primary volume's RVA Cluster/Interface "SAID" as shown below.</p> <p>bb ESCON Director "DESTINATION" address. "00" if directly attached pair of DASD control units or with static ESCON switch.</p> <p>cc Logical Subsystem Number for RVA.</p> <p>The LINK parameter address consists of:</p> <ul style="list-style-type: none"> An application system SAID (System Adapter ID) interface identifier, aaaa in this example, that uniquely identifies the physical location of the associated node interface. Corresponding to ESCON channel interfaces A through H, for each of the clusters, the SAID bytes are: <table border="1" data-bbox="483 667 868 1119"> <thead> <tr> <th>RVA</th> <th>Cluster/Interface</th> <th>SAID Bytes</th> </tr> </thead> <tbody> <tr><td>0</td><td>Interface A</td><td>X '0000'</td></tr> <tr><td>0</td><td>Interface B</td><td>X '0001'</td></tr> <tr><td>0</td><td>Interface C</td><td>X '0020'</td></tr> <tr><td>0</td><td>Interface D</td><td>X '0021'</td></tr> <tr><td>0</td><td>Interface E</td><td>X '0040'</td></tr> <tr><td>0</td><td>Interface F</td><td>X '0041'</td></tr> <tr><td>0</td><td>Interface G</td><td>X '0060'</td></tr> <tr><td>0</td><td>Interface H</td><td>X '0061'</td></tr> <tr><td>1</td><td>Interface A</td><td>X '0010'</td></tr> <tr><td>1</td><td>Interface B</td><td>X '0011'</td></tr> <tr><td>1</td><td>Interface C</td><td>X '0030'</td></tr> <tr><td>1</td><td>Interface D</td><td>X '0031'</td></tr> <tr><td>1</td><td>Interface E</td><td>X '0050'</td></tr> <tr><td>1</td><td>Interface F</td><td>X '0051'</td></tr> <tr><td>1</td><td>Interface G</td><td>X '0070'</td></tr> <tr><td>1</td><td>Interface H</td><td>X '0071'</td></tr> </tbody> </table> <ul style="list-style-type: none"> A recovery site storage control ESCON link destination address, bb in this example. If the ESCON Director is installed, it assigns the recovery site storage control ESCON link destination address (bb). For direct fiber optic cable connections between storage controls or static connections through an ESCON Director, the link address value is zero. The RVA logical Subsystem Number, cc in this example. 	RVA	Cluster/Interface	SAID Bytes	0	Interface A	X '0000'	0	Interface B	X '0001'	0	Interface C	X '0020'	0	Interface D	X '0021'	0	Interface E	X '0040'	0	Interface F	X '0041'	0	Interface G	X '0060'	0	Interface H	X '0061'	1	Interface A	X '0010'	1	Interface B	X '0011'	1	Interface C	X '0030'	1	Interface D	X '0031'	1	Interface E	X '0050'	1	Interface F	X '0051'	1	Interface G	X '0070'	1	Interface H	X '0071'
RVA	Cluster/Interface	SAID Bytes																																																		
0	Interface A	X '0000'																																																		
0	Interface B	X '0001'																																																		
0	Interface C	X '0020'																																																		
0	Interface D	X '0021'																																																		
0	Interface E	X '0040'																																																		
0	Interface F	X '0041'																																																		
0	Interface G	X '0060'																																																		
0	Interface H	X '0061'																																																		
1	Interface A	X '0010'																																																		
1	Interface B	X '0011'																																																		
1	Interface C	X '0030'																																																		
1	Interface D	X '0031'																																																		
1	Interface E	X '0050'																																																		
1	Interface F	X '0051'																																																		
1	Interface G	X '0070'																																																		
1	Interface H	X '0071'																																																		

PPRCOPY commands—CKD

Parameter/ Abbreviations	Description																																																																		
LINK(<i>linkaddr1... linkaddrx</i>)	<p>LINK specifies the addressing path from the application site storage control to the recovery site storage control. Eight path addresses can be specified with each link character for the 2105. Each path address is an 8-digit hexadecimal address in the form X'aaaabccc', where:</p> <p>For 2105</p> <p>aaaa Primary volumes 2105 cluster interface system adapter ID (SAID) as shown below.</p> <p>bb ESCON director "DESTINATION" address (X'00' if directly attached pair of DASD control units or static ESCON switch).</p> <p>cc Logical subsystem number for 2105.</p> <p>The LINK parameter address consists of:</p> <ul style="list-style-type: none"> AN application system SAID (system adapter ID) interface identifier AAAA, that uniquely identifies the physical location of the associated node interface. Corresponding to ESCON channel interfaces the SAID bytes are: <table border="1"> <thead> <tr> <th>2105 CLUSTER/INTERFACE</th> <th>SAID BYTES</th> </tr> </thead> <tbody> <tr><td>1 BAY 1 CARD 1 LINK00</td><td>X'0000'</td></tr> <tr><td>1 BAY 1 CARD 1 LINK01</td><td>X'0001'</td></tr> <tr><td>1 BAY 1 CARD 2 LINK00</td><td>X'0004'</td></tr> <tr><td>1 BAY 1 CARD 2 LINK01</td><td>X'0005'</td></tr> <tr><td>1 BAY 1 CARD 3 LINK00</td><td>X'0008'</td></tr> <tr><td>1 BAY 1 CARD 3 LINK01</td><td>X'0009'</td></tr> <tr><td>1 BAY 1 CARD 4 LINK00</td><td>X'000C'</td></tr> <tr><td>1 BAY 1 CARD 4 LINK01</td><td>X'000D'</td></tr> <tr><td>1 BAY 2 CARD 1 LINK00</td><td>X'0020'</td></tr> <tr><td>1 BAY 2 CARD 1 LINK01</td><td>X'0021'</td></tr> <tr><td>1 BAY 2 CARD 2 LINK00</td><td>X'0024'</td></tr> <tr><td>1 BAY 2 CARD 2 LINK01</td><td>X'0025'</td></tr> <tr><td>1 BAY 2 CARD 3 LINK00</td><td>X'0028'</td></tr> <tr><td>1 BAY 2 CARD 3 LINK01</td><td>X'0029'</td></tr> <tr><td>1 BAY 2 CARD 4 LINK00</td><td>X'002C'</td></tr> <tr><td>1 BAY 2 CARD 4 LINK01</td><td>X'002D'</td></tr> <tr><td>2 BAY 3 CARD 1 LINK00</td><td>X'0080'</td></tr> <tr><td>2 BAY 3 CARD 1 LINK01</td><td>X'0081'</td></tr> <tr><td>2 BAY 3 CARD 2 LINK00</td><td>X'0084'</td></tr> <tr><td>2 BAY 3 CARD 2 LINK01</td><td>X'0085'</td></tr> <tr><td>2 BAY 3 CARD 3 LINK00</td><td>X'0088'</td></tr> <tr><td>2 BAY 3 CARD 3 LINK01</td><td>X'0089'</td></tr> <tr><td>2 BAY 3 CARD 4 LINK00</td><td>X'008C'</td></tr> <tr><td>2 BAY 3 CARD 4 LINK01</td><td>X'008D'</td></tr> <tr><td>2 BAY 4 CARD 1 LINK00</td><td>X'00A0'</td></tr> <tr><td>2 BAY 4 CARD 1 LINK01</td><td>X'00A1'</td></tr> <tr><td>2 BAY 4 CARD 2 LINK00</td><td>X'00A4'</td></tr> <tr><td>2 BAY 4 CARD 2 LINK01</td><td>X'00A5'</td></tr> <tr><td>2 BAY 4 CARD 3 LINK00</td><td>X'00A8'</td></tr> <tr><td>2 BAY 4 CARD 3 LINK01</td><td>X'00A9'</td></tr> <tr><td>2 BAY 4 CARD 4 LINK00</td><td>X'00AC'</td></tr> <tr><td>2 BAY 4 CARD 4 LINK01</td><td>X'00AD'</td></tr> </tbody> </table>	2105 CLUSTER/INTERFACE	SAID BYTES	1 BAY 1 CARD 1 LINK00	X'0000'	1 BAY 1 CARD 1 LINK01	X'0001'	1 BAY 1 CARD 2 LINK00	X'0004'	1 BAY 1 CARD 2 LINK01	X'0005'	1 BAY 1 CARD 3 LINK00	X'0008'	1 BAY 1 CARD 3 LINK01	X'0009'	1 BAY 1 CARD 4 LINK00	X'000C'	1 BAY 1 CARD 4 LINK01	X'000D'	1 BAY 2 CARD 1 LINK00	X'0020'	1 BAY 2 CARD 1 LINK01	X'0021'	1 BAY 2 CARD 2 LINK00	X'0024'	1 BAY 2 CARD 2 LINK01	X'0025'	1 BAY 2 CARD 3 LINK00	X'0028'	1 BAY 2 CARD 3 LINK01	X'0029'	1 BAY 2 CARD 4 LINK00	X'002C'	1 BAY 2 CARD 4 LINK01	X'002D'	2 BAY 3 CARD 1 LINK00	X'0080'	2 BAY 3 CARD 1 LINK01	X'0081'	2 BAY 3 CARD 2 LINK00	X'0084'	2 BAY 3 CARD 2 LINK01	X'0085'	2 BAY 3 CARD 3 LINK00	X'0088'	2 BAY 3 CARD 3 LINK01	X'0089'	2 BAY 3 CARD 4 LINK00	X'008C'	2 BAY 3 CARD 4 LINK01	X'008D'	2 BAY 4 CARD 1 LINK00	X'00A0'	2 BAY 4 CARD 1 LINK01	X'00A1'	2 BAY 4 CARD 2 LINK00	X'00A4'	2 BAY 4 CARD 2 LINK01	X'00A5'	2 BAY 4 CARD 3 LINK00	X'00A8'	2 BAY 4 CARD 3 LINK01	X'00A9'	2 BAY 4 CARD 4 LINK00	X'00AC'	2 BAY 4 CARD 4 LINK01	X'00AD'
2105 CLUSTER/INTERFACE	SAID BYTES																																																																		
1 BAY 1 CARD 1 LINK00	X'0000'																																																																		
1 BAY 1 CARD 1 LINK01	X'0001'																																																																		
1 BAY 1 CARD 2 LINK00	X'0004'																																																																		
1 BAY 1 CARD 2 LINK01	X'0005'																																																																		
1 BAY 1 CARD 3 LINK00	X'0008'																																																																		
1 BAY 1 CARD 3 LINK01	X'0009'																																																																		
1 BAY 1 CARD 4 LINK00	X'000C'																																																																		
1 BAY 1 CARD 4 LINK01	X'000D'																																																																		
1 BAY 2 CARD 1 LINK00	X'0020'																																																																		
1 BAY 2 CARD 1 LINK01	X'0021'																																																																		
1 BAY 2 CARD 2 LINK00	X'0024'																																																																		
1 BAY 2 CARD 2 LINK01	X'0025'																																																																		
1 BAY 2 CARD 3 LINK00	X'0028'																																																																		
1 BAY 2 CARD 3 LINK01	X'0029'																																																																		
1 BAY 2 CARD 4 LINK00	X'002C'																																																																		
1 BAY 2 CARD 4 LINK01	X'002D'																																																																		
2 BAY 3 CARD 1 LINK00	X'0080'																																																																		
2 BAY 3 CARD 1 LINK01	X'0081'																																																																		
2 BAY 3 CARD 2 LINK00	X'0084'																																																																		
2 BAY 3 CARD 2 LINK01	X'0085'																																																																		
2 BAY 3 CARD 3 LINK00	X'0088'																																																																		
2 BAY 3 CARD 3 LINK01	X'0089'																																																																		
2 BAY 3 CARD 4 LINK00	X'008C'																																																																		
2 BAY 3 CARD 4 LINK01	X'008D'																																																																		
2 BAY 4 CARD 1 LINK00	X'00A0'																																																																		
2 BAY 4 CARD 1 LINK01	X'00A1'																																																																		
2 BAY 4 CARD 2 LINK00	X'00A4'																																																																		
2 BAY 4 CARD 2 LINK01	X'00A5'																																																																		
2 BAY 4 CARD 3 LINK00	X'00A8'																																																																		
2 BAY 4 CARD 3 LINK01	X'00A9'																																																																		
2 BAY 4 CARD 4 LINK00	X'00AC'																																																																		
2 BAY 4 CARD 4 LINK01	X'00AD'																																																																		
	<ul style="list-style-type: none"> A recovery site storage control ESCON link destination address, BB, in this example. If the ESCON director is installed, it assigns the recovery site storage control ESCON link destination address (bb). For direct cable connections between storage controls or static connections through an ESCON director, the link address value is zero. The logical subsystem number of the destination, CC, in this example. This value must match the logical subsystem number of the secondary logical subsystem specified in the LSS parameter. <p>To determine the logical subsystem number (LSS) for the 2105, run the ICKDSF CONTROL CONFIGURE(DISPLAY) command which will print the LSS number.</p>																																																																		
Default:	None.																																																																		
Restrictions:	FCPPATHS and WWNN cannot be specified with the LINK parameter.																																																																		

Optional parameters

CGROUP parameter: how an error that is related to a PPRC device is reported by the 2105

Parameter/ Abbreviations	Description
CGROUP(NOIYES)	CGROUP specifies: <ul style="list-style-type: none"> NO Specifies that error handling and reporting is performed the same way as a 3990 storage control with the automated recovery bit in the vital product data (VPD) set to Off. YES Specifies that the 2105 subsystem responds to PPRC pair errors with the same status that is returned from a 3990-6 storage control with the automated recovery bit in the vital product data (VPD) set to On. This bit enables the extended long busy condition for a consistency group. Automation products can detect PPRC volume pair outages on these devices and take appropriate action.
Default:	NO
Restrictions:	CRIT(YES) is not valid when CASCADE is specified.

FORCE parameter: force removal of existing logical paths

Parameter/ Abbreviations	Description
FORCE	Used to force removal of existing logical paths. If the links used for PPRC do not have existing logical paths established, then FORCE is not necessary. <p>Note: When FORCE is used to remove existing logical paths, operating system messages may be issued stating that the removed paths are not operational or have been taken offline.</p>
Default:	None.
Restrictions:	The FORCE parameter is ignored for all devices except the 2105.

LSS parameter: identify logical subsystem number

Parameter/ Abbreviations	Description
LSS(X'pp',X'ss')	LSS is required to identify the logical subsystem number on 2105 devices. The X'pp' value is the primary logical subsystem number. The X'ss' value is the secondary logical subsystem number. <p>Obtain the logical subsystem number with the following command.</p> <p>CONTROL CONFIGURE(DISPLAY)</p>
Default:	None.
Restrictions:	LSS is valid only for 2105 devices.

Examples

```
PPRC ESTPATH UNIT(0142) PRI(X'6060',62006) SEC(X'6061',68006) LINK(X'0004C400')
```

Multiple path example

The following command adds four ESCON paths between the application site storage control (SSID 6060, serial number ending with 62006) and the recovery site storage control (SSID 6061, serial number ending with 68006). The PPRCOPY ESTPATH command may be issued to any device on the application site storage control.

```
PPRCOPY ESTPATH UNIT(0142) PRIM(X'6060',62006) SEC(X'6061',68006) -  
LINK(X'0000B000',X'0001B000',X'0016B000',X'0017B000')
```

PPRCOPY commands—CKD

The examples assume that all of the physical and logical paths already exist.

PPRC-FCP path example

The following example shows how to specify the PPRCOPY ESTPATH to establish a PPRC-FCP path:

```
PPRCOPY ESTPATH UNIT(4C80) -  
PRI(X'2901',FCA29) SEC(X'2905',FCA29) -  
LSS(X'01',X'05') -  
FCPPATHS(x'002000E6') -  
WWNN(5005076300123456,5005076300234567)
```

Multiple PPRC-FCP path example

The following example shows how to specify the PPRCOPY ESTPATH to establish multiple PPRC-FCP paths:

```
PPRCOPY ESTPATH UNIT(4C80) -  
PRI(X'2901',FCA29) SEC(X'2905',FCA29) -  
LSS(X'01',X'05') -  
FCPPATHS(x'002000E6', x'002000E7') -  
WWNN(5005076300123456,5005076300234567)
```

Example for 2105 using the LSS parameter

The following example shows an ESTPATH command for 2105 using the LSS parameter. The secondary is LSS X'02'. The last byte of the link address is X'02', which must match the value that is specified for the secondary in the LSS parameter.

```
PPRCOPY ESTPATH UNIT(4C00) LSS(X'07',X'02') -  
PRI(X'06C7',FCA29) SEC(X'06C2',FCA29) -  
LINK(X'00A0E402')
```

PPRCOPY DELPATH—deleting paths

Use the DELPATH command to delete all established ESCON paths between an application site (source) storage control and a recovery site (target) storage control. Only active paths to the specified recovery site storage control are affected; all other paths to other storage controls are unaffected.

You may delete one or more paths at a time if there are no other pairs of DASD in the “PPRC active pair” state.

Syntax

PPRCOPY DELPATH
Required Parameters DDNAME(<i>dname</i>) SYSNAME(<i>sysxxx</i>) UNITADDRESS(<i>ccuu</i>) PRIMARY(<i>ssid,ser#</i>) SECONDARY(<i>ssid,ser#</i>) FCPPATHS(<i>path1,...path8</i>) WWNN(<i>pwwnn,swwnn</i>)
Optional Parameters FORCE LSS(<i>X'pp',X'ss</i>)

Required parameters

DDNAME|SYSNAME|UNITADDRESS parameter: identify the primary volume

Parameter/ Abbreviations	Description
DDNAME(<i>dname</i>) DNAME	Required for an online MVS volume. The volume must be online. For <i>dname</i> , specify the MVS JCL statement that identifies the volume.
SYSNAME(<i>sysxxx</i>)	Required for a VSE volume when executing ICKDSF in batch mode; the volume must be online. For <i>sysxxx</i> , specify the SYSNAME in the ASSGN system control statement.
UNITADDRESS(<i>ccuu</i>) UNITADDR UNIT	<p>Required for an offline MVS volume, a Stand-Alone volume, and a VM volume. For VSE, it is required when executing ICKDSF in command mode; the volume must be online.</p> <p>In MVS, the volume must be on a path that is online. If the volume is on a path that is offline, the program might enter a nonterminating wait state. For <i>ccuu</i>, specify the address (3 or 4 hex digits) of the channel and unit of the volume.</p> <p>For the CMS version, specify the virtual address of the dedicated volume or fullpack minidisk.</p> <p>The unit address is the device number.</p>
Default:	None.
Restrictions:	None.

PRIMARY and SECONDARY parameter: identify control unit

Parameter/ Abbreviations	Description
PRIMARY(<i>ssid,ser#</i>) PRIM PRI	<p>Specifies the application site storage control subsystem ID and serial number.</p> <p>The storage control subsystem ID (<i>ssid</i>) is a 4-digit hexadecimal address.</p> <p>The <i>ser#</i> is the storage control serial number, and is the last five digits of the 12-digit machine serial number for 3990 and 2105 or the last seven digits of the 12-digit machine serial number for RVA.</p> <p>The storage control subsystem id, and storage control serial number may be obtained with the CONTROL CONFIGURE(DISPLAY) command for 3990 and 2105 or PPRCOPY QUERY without the PATHS parameter for RVA.</p>
SECONDARY(<i>ssid,ser#</i>) SEC	Specifies the recovery site storage control subsystem ID (<i>ssid</i>) and serial number (<i>ser#</i>). The descriptions for the values are the same as for the PRIMARY parameter.
Default:	None.
Restrictions:	None.

FCPPATHS parameter: identifies PPRC with Fibre Channel Protocol (FCP) paths

Parameter/ Abbreviations	Description
FCPPATHS(<i>path1,...path8</i>) FCPPS FCPP	<p>The FCPPATHS parameter is specified to indicate that FCP (Fibre Channel Protocol) paths are to be deleted.</p> <p>Specifies the addressing path from the application site storage control to the recovery site storage control. Up to 8 paths can be specified. Each path is an 8-digit hexadecimal address in the form X'aaaabbbb' where:</p> <ul style="list-style-type: none"> 'aaaa' is the primary volume's cluster interface system adapter ID (SAID) 'bbbb' is the secondary volume's (destination) SAID <p>When FCPPATHS is specified, the WWNN parameter is required.</p>
Default:	None.
Restrictions:	<p>FCP paths and ESCON paths cannot be established between the same PPRC pair or in the same ESTPATH command. Therefore, the FCPPATHS parameter is not valid with the LINK parameter.</p> <p>FCPPATHS is only supported on 2105 with the PPRC FCP microcode support. If the device is not an ESS, or if the device is an ESS without the PPRC-FCP support, then message ICK31054I 'DEVICE NOT SUPPORTED FOR SPECIFIED FUNCTION' will be issued and the command is terminated.</p>

WWNN parameter: identifies the World Wide Node Name (WWNN) of the primary and secondary

Parameter/ Abbreviations	Description
WWNN(<i>pwwnn,swwnn</i>)	<p>Specifies the World Wide Node Name (WWNN) of the Primary and Secondary. Each WWNN is an 8-byte hexadecimal value wwwwwwwwwwwwwwwww. <i>pwwnn</i> represents the Primary WWNN and <i>swwnn</i> represents the Secondary WWNN.</p> <p>The WWNN can be determined from using the ICKDSF PPRC QUERY PATHS command.</p>
Default:	None.
Restrictions:	Although the WWNN value is a hex value the leading X' and the trailing apostrophe are not allowed in the specification of the value.

Optional parameters

FORCE parameter: force removal of existing paths

Parameter/ Abbreviations	Description
FORCE	Indicates that you want to force removal of existing paths. The existence of PPRC pairs will be ignored and the pairs will remain in the state prior to execution of this command. This parameter can be used to remove PPRC paths from a secondary site as part of the procedure to return to the original primary site.
Default:	None.
Restrictions:	FORCE is only valid on D/T2105 (ESS) devices that have the FAILOVER and FAILBACK microcode support.

LSS parameter: identifies logical subsystem number

Parameter/ Abbreviations	Description
LSS(X'pp',X'ss')	LSS is required to identify the logical subsystem number on 2105 devices. The X'pp' value is the primary logical subsystem number. The X'ss' value is the secondary logical subsystem number. Obtain the logical subsystem number with the following command: CONTROL CONFIGURE(DISPLAY)
Default:	None.
Restrictions:	LSS is valid only for 2105 devices.

Example

The following command deletes all established ESCON paths between application site storage control 0057 and recovery site storage control 053F.

```
PPRCOPY DELPATH UNIT(0D42) PRIM(X'0057',90007) SEC(X'053F',90014)
```

PPRC-FCP path example

The following example shows how to specify the PPRCOPY DELPATH to delete a PPRC-FCP path.

```
PPRCOPY DELPATH UNIT(4C80) -
PRI(X'2901',FCA29) SEC(X'2905',FCA29) -
LSS(X'01',X'05') -
FCPPATHS(x'002000E6') -
WVNN(5005076300123456,5005076300234567)
```

Example for 2105 using the LSS parameter

The following example shows a DELPATH command for 2105 using the LSS parameter.

```
PPRCOPY DELPATH UNIT(4C00) LSS(X'07',X'02') -
PRI(X'06C7',FCA29) SEC(X'06C2',FCA29)
```

PPRCOPY ESTPAIR—establishing pairs

Use the ESTPAIR command to specify PPRC primary and secondary volumes to establish a remote copy device pair.

The device track characteristics of the primary and secondary volumes must be equivalent. The following must be the same for both volumes:

- Tracks on each cylinder
- Bytes on each track

The primary and secondary control units must have active subsystem cache and NVS. Active volume cache and DASD Fast Write is recommended for the primary device; it is required for the secondary device. The secondary device must also have the same track format and at least as many cylinders as the primary device.

The DASD Fast Write status of the primary device does not change after you issue the ESTPAIR command. You can change the DFW status while in the Peer-to-Peer Remote Copy state.

Warning

Protect your data by ensuring your secondary device is correct; no checking is done at the secondary subsystem to protect the data on the secondary volume.

Some additional notes for the ESTPAIR command:

- Peer-to-Peer Remote Copy allows data to be copied from a smaller primary device (fewer cylinders) to a larger secondary device (more cylinders) as long as the tracks per cylinder and capacity of the devices are the same. The additional space on the secondary volume is not available until the PPRC volumes in the pair are returned to simplex state and ICKDSF Release 16 or above is run against the secondary volume to rebuild the VTOC. When this is done, the additional capacity of the secondary volume is reflected in its free space.
- For VSE, special considerations apply to unlike-size volume copy operations if the primary volume contains VSE/VSAM space. VSE/VSAM catalog information will not be consistent with the new secondary volume's size, requiring that the catalog inconsistency be resolved before DEFINE SPACE or DELETE SPACE commands are issued.

To synchronize the catalog with the size of the new secondary volume, use either of the following methods:

- FASTCOPY the secondary volume to a volume of the same size as the smaller primary volume, and use this volume instead of the larger secondary volume.

Or

- On the secondary volume:
 - Backup all VSE/VSAM files
 - Remove all VSAM objects (cluster, space, and catalog if present)
 - Redefine the space/catalog
 - Restore the backed-up VSAM files
- Because multivolume data sets span multiple volumes, they require special handling. To ensure that the data set is recoverable, copy all volumes of a multivolume data set.
- Peer-to-Peer Remote Copy only supports full pack minidisks.
- VM requires STDEVOPT DASDSYS DATAMOVER or STDEVOPT DASDSYS CONCOPY authorization in the Directory in order to successfully establish pairs for PPRC.

Syntax

PPRCOPY ESTPAIR

Required Parameters

DDNAME(*dname*)|SYSNAME(*sysxxx*)|UNITADDRESS(*ccuu*)
 PRIMARY(*ssid,ser#,cca*)
 SECONDARY(*ssid,ser#,cca*)

Optional Parameters

CASCADE
 CRIT(**NO**IYES)
 ESUSP
 FAILOVERIFAILBACK
 LSS(*X'pp'*; *X'ss'*)
 MODE(**COPY**|**NO**COPY|**YES**SYNC)
 MSGREQ(**NO**IYES)
 ONLINSEC(**NO**IYES)
 OPTION(SYNC|XD)
 PACE(1...**15**...255)

Required parameters**DDNAME|SYSNAME|UNITADDRESS parameter: identify the primary volume**

Parameter/ Abbreviations	Description
DDNAME(<i>dname</i>) DNAME	Required for an online MVS volume. The volume must be online. For <i>dname</i> , specify the MVS JCL statement that identifies the volume.
SYSNAME(<i>sysxxx</i>)	Required for a VSE volume when executing ICKDSF in batch mode; the volume must be online. For <i>sysxxx</i> , specify the SYSNAME in the ASSGN system control statement.
UNITADDRESS(<i>ccuu</i>) UNITADDR UNIT	<p>Required for an offline MVS volume, a Stand-Alone volume, and a VM volume. For VSE, it is required when executing ICKDSF in command mode; the volume must be online.</p> <p>In MVS, the volume must be on a path that is online. If the volume is on a path that is offline, the program might enter a nonterminating wait state. For <i>ccuu</i>, specify the address (3 or 4 hex digits) of the channel and unit of the volume.</p> <p>For the CMS version, specify the virtual address of the dedicated volume or fullpack minidisk.</p> <p>The unit address is the device number.</p>
Default:	None.
Restrictions:	None.

PRIMARY and SECONDARY parameter: identify control unit

Parameter/ Abbreviations	Description
PRIMARY(<i>ssid,ser#,cca</i>) PRIM PRI	<p>Specifies the application site storage control subsystem ID, serial number, and channel connection address.</p> <p>The storage control subsystem ID (<i>ssid</i>) is a 4-digit hexadecimal address.</p> <p>The <i>ser#</i> is the storage control serial number, and is the last five digits of the 12-digit machine serial number for 3990 and 2105 or the last seven digits of the 12-digit machine serial number for RVA.</p> <p>The channel connection address (<i>cca</i>) is a 2-digit hex address.</p> <p>The storage control subsystem id, storage control serial number, and channel connection address may be obtained with the CONTROL CONFIGURE(DISPLAY) command for 3990 and 2105 or PPRCOPY QUERY without the PATHS parameter for RVA.</p>
SECONDARY(<i>ssid,ser#,cca</i>) SEC	<p>Specifies the recovery site storage control subsystem ID, serial number, and the secondary volume channel connection address (<i>cca</i>). The descriptions for the values are the same as for the PRIMARY parameter. Warning: Protect your data by ensuring your secondary device is correct; No checking is done at the secondary subsystem to protect the data on the secondary volume.</p>
Default:	None.

PPRCOPY commands—CKD

Parameter/ Abbreviations	Description
Restrictions:	None.

Optional parameters

CASCADE parameter: make a volume eligible for or establish it as a cascading volume

Parameter/ Abbreviations	Description
CASCADE	<p>This parameter indicates whether a volume is to be eligible for PPRC cascading and become an intermediate volume. This parameter is issued to the volume that is to become the intermediate volume of a cascaded relationship.</p> <p>If ESTPAIR with CASCADE is issued to a volume is in simplex state, this parameter indicates only that the volume is eligible for cascading. The volume does not become part of a cascaded relationship until it is established as an intermediate volume with another site.</p> <p>If ESTPAIR with CASCADE is reissued to a volume that is eligible to be a CASCADE intermediate volume, and the volume is already the primary of an existing PPRC pair, then the volume becomes eligible for cascading without breaking this existing pair. This allows you to make a volume eligible for cascading that was previously not eligible.</p> <p>If ESTPAIR with CASCADE is issued to a volume that is to become the intermediate volume and the volume is already the Secondary of an existing PPRC pair, the volume becomes the primary of the remote pair and is then part of a cascaded relationship.</p> <p>If CASCADE is specified and the device is not an ESS or the device is an ESS without the PPRC cascading microcode, the command will be terminated, with message ICK31054I 'DEVICE NOT SUPPORTED FOR SPECIFIED FUNCTION'.</p> <p>If ESTPAIR without CASCADE specified, is issued to a volume in simplex state, the volume is not eligible for cascading.</p> <p>If ESTPAIR without CASCADE specified, is issued to a volume that is part of a PPRC pair, the cascading state remains unchanged. If the volume is already set to be eligible for cascading, you must break the pair in order to reset the cascading state.</p>
Default:	None.
Restrictions:	CRIT(YES) is not valid when CASCADE is specified.

CRIT parameter: write update error processing

Parameter/ Abbreviations	Description
CRIT(NOIYES)	<p>NO specifies that, following an I/O error attempting to write an update to the secondary, subsequent write requests to the primary volume in suspended duplex state are allowed without a unit check being issued.</p> <p>YES specifies that a failure to write update the secondary will result in a unit check and the primary will not be placed in a suspended duplex state.</p>
Default:	NO
Restrictions:	<p>When you reestablish a suspended pair that was originally established with CRIT(YES) specified, you must again specify CRIT(YES) with the PPRCOPY ESTPAIR command if you want this option to remain in effect.</p> <p>CRIT(YES) is not valid when either OPTION(XD) or CASCADE is specified.</p>

ESUSP parameter: enable suspension after establishment

Parameter/ Abbreviations	Description
ESUSP	This parameter indicates that you want the volume to enter suspension after establishment of the volume.
Default:	None.
Restrictions:	EUSP is not valid with MODE(NOCOPY) or OPTION(XD). ESUSP is only valid on 2105 devices that have PPRC extended distance support.

FAILOVERIFAILBACK parameter: reverse direction of PPRC

Parameter/ Abbreviations	Description
FAILOVER FO	Indicates that you want to reverse the direction of an existing PPRC pair so that the original secondary becomes the primary and goes into a suspended state, without performing the checking normally done for a secondary volume.
FAILBACK FB	Indicates that you want to change the state of a PPRC pair that was previously set in FAILOVER mode. When FAILBACK is specified, OPTION(XD) or ESUSP are allowed.
Default:	None.
Restrictions:	<ul style="list-style-type: none"> • FAILOVER - The volume must be a secondary volume and must be in the full duplex or suspended state. • FAILOVER is not valid when OPTION(XD) or ESUSP parameters are specified. • FAILOVER is not valid with MSGREQ(YES), CRIT(YES), MODE(COPY), or MODE(RESYNC) • FAILOVER is only valid on D/T2105 (ESS) devices that have the FAILOVER and FAILBACK microcode support. • FAILBACK - The volume must be a suspended PPRC primary volume (the command is issued from the original secondary site). • FAILBACK is not valid with MSGREQ(YES), CRIT(YES), MODE(COPY), or MODE(RESYNC) • FAILBACK is only valid on D/T2105 (ESS) devices that have the FAILOVER and FAILBACK microcode support.
Note: When FAILOVER and FAILBACK are specified, the parameters identifying the primary and secondary volume are specified such that they represent the volume you want to be the new primary and secondary volumes. In other words, with both FAILOVER and FAILBACK, the primary parameters for <i>ssid</i> , <i>lss</i> , serial number, <i>cca</i> , are specified for the volume that is to be the new primary and the secondary parameters for <i>ssid</i> , <i>lss</i> , serial number, <i>cca</i> , are specified for the volume that is to be the new secondary.	

LSS parameter: identify logical subsystem number

Parameter/ Abbreviations	Description
LSS(X'pp',X'ss')	LSS is required to identify the logical subsystem number on 2105 devices. The X'pp' value is the primary logical subsystem number. The X'ss' value is the secondary logical subsystem number. Obtain the logical subsystem number with the following command: CONTROL CONFIGURE(DISPLAY)
Default:	None.
Restrictions:	LSS is valid only for 2105 devices.

MODE parameter: copy mode

Parameter/ Abbreviations	Description
MODE(COPY NOCOPY RESYNC)	<p>MODE specifies one of the following modes:</p> <p>COPY specifies that all tracks on the primary are to be copied to the secondary volume.</p> <p>NOCOPY specifies that only those tracks on the primary volume that are updated after the pair is established are to be copied to the secondary volume. Specify this mode only if the volumes are exact copies of each other.</p> <p>Note: The NOCOPY option assumes that the specified volumes are fully synchronized at the time the copy is started. Ensure that no I/O operations occur to either volume prior to starting the copy operation. This is necessary in order to protect the data integrity of the two volumes.</p> <p>RESYNC specifies that a suspended copy be reestablished. Only those tracks updated during the period of suspension are copied from the primary volume to the secondary volume.</p>
Default:	COPY
Restrictions:	NOCOPY is not valid when OPTION(XD) or ESUSP is specified. If the CASCADE support for ICKDSF is applied by way of APAR PQ72465 and the appropriate level of microcode is applied then OPTION(XD) with NOCOPY is allowed.

MSGREQ parameter: completion message processing

Parameter/ Abbreviations	Description
MSGREQ(NO YES)	<p>MSGREQ specifies:</p> <p>YES Specifies that PPRC wait until the initial full-volume copy operation is complete before issuing completion messages.</p> <p>NO Specifies that the command is complete upon initiating the request to the storage control. PPRC does not wait for the copy operation to complete before issuing completion messages.</p>
Default:	NO
Restrictions:	<p>The MSGREQ parameter is valid only with the MODE(COPY) option.</p> <p>MSGREQ(YES) is not valid when OPTION(XD) is specified.</p>

ONLINSEC parameter: specifies online secondary volume (2105 devices only)

Parameter/ Abbreviations	Description
ONLINSEC(NO YES) ONSEC	<p>ONLINSEC specifies:</p> <p>NO Specifies that, if the secondary volume appears to be online to a host system the command will fail with an error message and the PPRC pair will not be established.</p> <p>YES Specifies that the command will be processed even if the secondary volume is online to a host system.</p>
Default:	NO
Restrictions:	ONLINSEC is valid on 2105 devices only.

OPTION parameter: additional options

Parameter/ Abbreviations	Description
OPTION(SYNCIXD)	Option specifies on of the following: SYNC If the PPRC pair is already established in the extended distance mode, specifying this parameter will cause the pair to change to synchronous. The MODE parameter is ignored when OPTION(SYNC) is specified and the PPRC pair is currently in the extended distance mode (for example, when currently in pending-XD state). XD Specifies that the PPRC pair is to be established in extended distance mode on a subsystem that has the support for this feature. When XD is specified, one of the following conditions must exist: <ul style="list-style-type: none"> • Both the primary and secondary devices must be in Simplex state. • The primary and secondary devices must be in a Suspended state.
Default:	None.
Restrictions:	When OPTION(XD) is specified, MODE(NOCOPY), CRIT(YES) and MSGREQ(YES) are not valid. If the CASCADE support for ICKDSF is applied by way of APAR PQ72465 and the appropriate level of microcode is applied then OPTION(XD) with NOCOPY is allowed. OPTION is only valid on 2105 devices that have PPRC extended distance support.

PACE parameter: number of tracks to be copied

Parameter/ Abbreviations	Description
PACE(1...15...255)	PACE specifies the number of tracks to be copied at one time before allowing another host interrupt. The allowable range is from 1 to 255. A value of 1 will copy three tracks at a time. Value 2 to 255 will copy 15 tracks at a time.
Default:	15
Restrictions:	PACE is ignored if you specify MODE(NOCOPY). PACE is ignored for RVA and 2105 devices.

Example

The following command establishes a PPRC pair:

```
PPRCOPY ESTPAIR UNIT(0D42) PRIM(X'0057',90007,X'02') -
      SEC(X'053F',90014,X'0E') MODE(COPY) PACE(15) CRIT(NO)
```

PPRC extended distance examples

The following example shows how to specify the PPRCOPY ESTPAIR to go from a simplex state to PPRC extended distance mode:

```
PPRCOPY ESTPAIR UNIT(4C80) LSS(X'01',X'05') -
      PRI(X'2901',FCA29,X'00') SEC(X'2905',FCA29,X'00') -
      MODE(COPY) OPTION(XD)
```

The following example shows how to specify the PPRCOPY ESTPAIR to go from synchronous PPRC to PPRC extended distance mode. The PPRC pair must be in suspended state prior to invoking this command.

```
PPRCOPY ESTPAIR UNIT(4C80) LSS(X'01',X'05') -
      PRI(X'2901',FCA29,X'00') SEC(X'2905',FCA29,X'00') -
      MODE(RESYNC) OPTION(XD)
```

The following example shows how to specify the PPRCOPY ESTPAIR to go from PPRC extended distance mode to synchronous PPRC. The pair must be either in a 'pending-XD' state or in a suspended state, prior to invoking this command.

PPRCOPY commands—CKD

Note: When OPTION(SYNC) is specified, the MODE keyword is ignored if specified.

```
PPRCOPY ESTPAIR UNIT(4C80) LSS(X'01',X'05') -  
PRI(X'2901',FCA29,X'00') SEC(X'2905',FCA29,X'00') -  
OPTION(SYNC)
```

The following example shows how to specify the PPRCOPY ESTPAIR to go from a suspended state to PPRC extended distance mode. The pair must be in a suspended state prior to invoking this command.

```
PPRCOPY ESTPAIR UNIT(4C80) LSS(X'01',X'05') -  
PRI(X'2901',FCA29,X'00') SEC(X'2905',FCA29,X'00') -  
MODE(RESYNC) OPTION(XD)
```

Example for 2105 using LSS parameter

The following example shows an ESTPAIR command for 2105 using the LSS parameter:

```
PPRCOPY ESTPAIR UNIT(4C00) LSS(X'07',X'02') -  
PRI(X'06C7',FCA29,X'01') SEC(X'06C2',FCA29,X'01') -  
MODE(COPY)
```

PPRCOPY DELPAIR—deleting pairs

Use the PPRCOPY command DELPAIR function to specify the primary and secondary volumes to remove from PPRC and return the devices to a simplex state. When this function is used, the duplex pair must not be in DASD Fast Write pending status.

If this command is received on the primary address, the primary and secondary device will be returned to simplex. The DASD Fast Write and caching status of the device on the primary address will be the same as the DASD Fast Write and caching status of the Duplex Pair.

Syntax

PPRCOPY DELPAIR	
Required Parameters	DDNAME(<i>dname</i>) SYSNAME(<i>sysxxx</i>) UNITADDRESS(<i>ccuu</i>) PRIMARY(<i>ssid,ser#,cca</i>) SECONDARY(<i>ssid,ser#,cca</i>)
Optional Parameters	LSS(<i>X'pp',X'ss'</i>)

Required parameters

DDNAME|SYSNAME|UNITADDRESS parameter: identify the primary volume

Parameter/Abbreviations	Description
DDNAME(<i>dname</i>) DNAME	Required for an online MVS volume. The volume must be online. For <i>dname</i> , specify the MVS JCL statement that identifies the volume.
SYSNAME(<i>sysxxx</i>)	Required for a VSE volume when executing ICKDSF in batch mode; the volume must be online. For <i>sysxxx</i> , specify the SYSNAME in the ASSGN system control statement.

Parameter/ Abbreviations	Description
UNITADDRESS(<i>ccuu</i>) UNITADDR UNIT	<p>Required for an offline MVS volume, a Stand-Alone volume, and a VM volume. For VSE, it is required when executing ICKDSF in command mode; the volume must be online.</p> <p>In MVS, the volume must be on a path that is online. If the volume is on a path that is offline, the program might enter a nonterminating wait state. For <i>ccuu</i>, specify the address (3 or 4 hex digits) of the channel and unit of the volume.</p> <p>For the CMS version, specify the virtual address of the dedicated volume or fullpack minidisk.</p> <p>The unit address is the device number.</p>
Default:	None.
Restrictions:	None.

PRIMARY and SECONDARY parameter: identify control unit

Parameter/ Abbreviations	Description
PRIMARY(<i>ssid,ser#,cca</i>) PRIM PRI	<p>Specifies the application site storage control subsystem ID, serial number, and channel connection address.</p> <p>The storage control subsystem ID (<i>ssid</i>) is a 4-digit hexadecimal address.</p> <p>The <i>ser#</i> is the storage control serial number, and is the last five digits of the 12-digit machine serial number for 3990 or the last seven digits of the 12-digit machine serial number for RVA.</p> <p>The channel connection address (<i>cca</i>) is a 2-digit hex address.</p> <p>The storage control subsystem id, storage control serial number, and channel connection address may be obtained with the CONTROL CONFIGURE(DISPLAY) command for 3990 or PPRCOPY QUERY without the PATHS parameter for RVA.</p>
SECONDARY(<i>ssid,ser#,cca</i>) SEC	<p>Specifies the recovery site storage control subsystem ID, serial number, and the secondary volume channel connection address (<i>cca</i>). The descriptions for the values are the same as for the PRIMARY parameter.</p>
Default:	None.
Restrictions:	None.

Optional parameter

LSS parameter: identify logical subsystem number

Parameter/ Abbreviations	Description
LSS(<i>X'pp',X'ss'</i>)	<p>LSS is required to identify the logical subsystem number on 2105 devices. The <i>X'pp'</i> value is the primary logical subsystem number. The <i>X'ss'</i> value is the secondary logical subsystem number.</p> <p>Obtain the logical subsystem number with the following command: CONTROL CONFIGURE(DISPLAY)</p>
Default:	None.
Restrictions:	LSS is valid only for 2105 devices.

Example

```
PPRCOPY DELPAIR UNIT(D42) PRIM(X'0057',90007,X'02') -
SEC(X'053F',90014,X'0E')
```

PPRCOPY commands—CKD

Example for 2105 using LSS parameter

The following example shows a DELPAIR command for 2105 using the LSS parameter:

```
PPRCOPY DELPAIR UNIT(4C00) LSS(X'07',X'02') -  
PRI(X'06C7',FCA29,X'01') SEC(X'06C2',FCA29,X'01')
```

PPRCOPY FREEZE—suspend all operations for all PPRC volumes on a single storage control

The FREEZE command is designed for automating database consistency. The FREEZE command is issued to control operations for multiple PPRC volume pairs on a single storage control. This command allows you to suspend all operations for all PPRC volumes on a single storage control. You must issue a separate FREEZE command to suspend operations on each storage control.

FREEZE specifies that PPRC stop all updates to secondary storage controls that are related to this volume pair. PPRC does not allow any activity to the secondary volumes. All the paths are removed for the secondary controller.

Syntax

Note: The FREEZE command is supported on 3390, RVA, and 2105.

PPRCOPY FREEZE

Required Parameters

DDNAME(*dname*)|SYSNAME(*sysxxx*)|UNITADDRESS(*ccuu*)
PRIMARY(*ssid,ser#*)
SECONDARY(*ssid,ser#*)
LSS(*X'pp',X'ss'*)

Required parameters

DDNAME|SYSNAME|UNITADDRESS parameter: identify the primary volume

Parameter/ Abbreviations	Description
DDNAME(<i>dname</i>) DNAME	Required for an online MVS volume. The volume must be online. For <i>dname</i> , specify the MVS JCL statement that identifies the volume.
SYSNAME(<i>sysxxx</i>)	Required for a VSE volume when executing ICKDSF in batch mode; the volume must be online. For <i>sysxxx</i> , specify the SYSNAME in the ASSGN system control statement.
UNITADDRESS(<i>ccuu</i>) UNITADDR UNIT	Required for an offline MVS volume, a Stand-Alone volume, and a VM volume. For VSE, it is required when executing ICKDSF in command mode; the volume must be online. In MVS, the volume must be on a path that is online. If the volume is on a path that is offline, the program might enter a nonterminating wait state. For <i>ccuu</i> , specify the address (3 or 4 hex digits) of the channel and unit of the volume. For the CMS version, specify the virtual address of the dedicated volume or fullpack minidisk. The unit address is the device number.
Default:	None.
Restrictions:	None.

PRIMARY and SECONDARY parameter: identifies the control unit

Parameter/ Abbreviations	Description
PRIMARY(<i>ssid,ser#</i>) PRIM PRI	Specifies the application site storage control subsystem ID, serial number, and channel connection address. The storage control subsystem ID (<i>ssid</i>) is a 4-digit hexadecimal address. The <i>ser#</i> is the storage control serial number, and is the last five digits of the 12-digit machine serial number for 3990 and 2105 or the last seven digits of the 12-digit machine serial number for RVA. The storage control subsystem id and storage control serial number may be obtained with the CONTROL CONFIGURE(DISPLAY) command for 3990 and 2105 or PPRCOPY QUERY without the PATHS parameter for RVA.
SECONDARY(<i>ssid,ser#</i>) SEC	Specifies the recovery site storage control subsystem ID and serial number. The descriptions for the values are the same as for the PRIMARY parameter. Warning: Protect your data by ensuring your secondary device is correct. No checking is done at the secondary subsystem to protect the data on the secondary volume.
Default:	None.
Restrictions:	None.

LSS parameter: identify logical subsystem number

Parameter/ Abbreviations	Description
LSS(<i>X'pp',X'ss'</i>)	LSS is required to identify the logical subsystem number on 2105 devices. The <i>X'pp'</i> value is the primary logical subsystem number. The <i>X'ss'</i> value is the secondary logical subsystem number. Obtain the logical subsystem number with the following command: CONTROL CONFIGURE(DISPLAY)
Default:	None.
Restrictions:	LSS is valid only for 2105 devices.

Example

```
PPRC FREEZE UNIT(5401) -
      PRI(X'2014',22010) -
      SEC(X'6404',24264) -
      LSS(04,04)
```

PPRCOPY RUN—resume all operations for all PPRC volumes on a single storage control

The RUN command is designed for automating database consistency. It indicates that the necessary work has been completed to ensure secondary PPRC volume consistency across all controllers and devices that are related.

The RUN command is issued to control operations for multiple PPRC volume pairs on a single storage control. This allows you to resume all operations for all PPRC volumes on a single storage control. You must issue a separate RUN command to resume operations on each storage control.

RUN specifies that PPRC resume all operations for all PPRC volumes for the storage control. I/O to the primary volumes resumes, but the pairs remain suspended.

Syntax

Note: The RUN command is supported on 3390, RVA, and 2105.

PPRCOPY RUN
Required Parameters DDNAME(<i>dname</i>) SYSNAME(<i>sysxxx</i>) UNITADDRESS(<i>ccuu</i>) PRIMARY(<i>ssid,ser#</i>) SECONDARY(<i>ssid,ser#</i>) LSS(<i>X'pp',X'ss'</i>)

Required parameters

DDNAME|SYSNAME|UNITADDRESS parameter: identify the primary volume

Parameter/ Abbreviations	Description
DDNAME(<i>dname</i>) DNAME	Required for an online MVS volume. The volume must be online. For <i>dname</i> , specify the MVS JCL statement that identifies the volume.
SYSNAME(<i>sysxxx</i>)	Required for a VSE volume when executing ICKDSF in batch mode; the volume must be online. For <i>sysxxx</i> , specify the SYSNAME in the ASSGN system control statement.
UNITADDRESS(<i>ccuu</i>) UNITADDR UNIT	Required for an offline MVS volume, a Stand-Alone volume, and a VM volume. For VSE, it is required when executing ICKDSF in command mode; the volume must be online. In MVS, the volume must be on a path that is online. If the volume is on a path that is offline, the program might enter a nonterminating wait state. For <i>ccuu</i> , specify the address (3 or 4 hex digits) of the channel and unit of the volume. For the CMS version, specify the virtual address of the dedicated volume or fullpack minidisk. The unit address is the device number.
Default:	None.
Restrictions:	None.

PRIMARY and SECONDARY parameter: identifies the control unit

Parameter/ Abbreviations	Description
PRIMARY(<i>ssid,ser#</i>) PRIM PRI	Specifies the application site storage control subsystem ID and serial number. The storage control subsystem ID (<i>ssid</i>) is a 4-digit hexadecimal address. The <i>ser#</i> is the storage control serial number, and is the last five digits of the 12-digit machine serial number for 3990 and 2105 or the last seven digits of the 12-digit machine serial number for RVA. The storage control subsystem id and storage control serial number may be obtained with the CONTROL CONFIGURE(DISPLAY) command for 3990 and 2105 or PPRCOPY QUERY without the PATHS parameter for RVA.
SECONDARY(<i>ssid,ser#</i>) SEC	Specifies the recovery site storage control subsystem ID and serial number. The descriptions for the values are the same as for the PRIMARY parameter. Warning: Protect your data by ensuring your secondary device is correct. No checking is done at the secondary subsystem to protect the data on the secondary volume.
Default:	None.
Restrictions:	None.

LSS parameter: identify logical subsystem number

Parameter/ Abbreviations	Description
LSS(X'pp',X'ss')	LSS is required to identify the logical subsystem number on 2105 devices. The X'pp' value is the primary logical subsystem number. The X'ss' value is the secondary logical subsystem number. Obtain the logical subsystem number with the following command: CONTROL CONFIGURE(DISPLAY)
Default:	None.
Restrictions:	LSS is valid only for 2105 devices.

Example

The following is an example of a RUN command to resume PPRC operations on the primary of a PPRC pair on which the FREEZE command was previously run. The RUN command is followed by the ESTPATH and ESTPAIR commands required to reestablish the PPRC pair.

```

PPRC RUN UNIT(5401)          -
      PRI(X'2014',22010)    -
      SEC(X'6404',24264)    -
      LSS(04,04)

PPRC ESTPATH UNIT(5401)     -
      PRI(X'2014',22010)    -
      SEC(X'6404',24264)    -
      LINK(X'00210004',X'00A10004') -
      LSS(X'04',X'04')

PPRC ESTPAIR UNIT(5401)    -
      PRI(X'2014',22010,X'01') -
      SEC(X'6404',24264,X'01') -
      LSS(04,04)           -
      MODE(RESYNC)         -
      LOCAL

```

PPRCOPY SUSPEND—suspending pairs

Use the PPRCOPY SUSPEND command to suspend PPRC operation between a primary and secondary volume pair. When the PPRCOPY SUSPEND command is directed to the primary or secondary device of a PPRC volume pair, the pair is suspended, and data is no longer transferred to the secondary volume. The primary device records which cylinders are no longer synchronous. When the pair is reestablished with the PPRCOPY ESTPAIR command, you can use MODE(RESYNC) to synchronize the volume again.

When the PPRCOPY SUSPEND with the optional PRIMAINIT parameter is specified, the pair is suspended, and all write data I/O directed to the primary device are unit checked, except for media maintenance channel programs, (when the maintenance panel has been set up to specify that writes are inhibited on any failure). When ICKDSF media maintenance operations have completed, the pair can be reestablished with the PPRCOPY ESTPAIR command specifying the MODE(RESYNC) parameter. The PRIMAINIT option should only be used as a part of an ICKDSF media maintenance procedure. The PRIMAINIT option is not valid on RVA or 2105.

Syntax

PPRCOPY SUSPEND
Required Parameters DDNAME(<i>dname</i>) SYSNAME(<i>sysxxx</i>) UNITADDRESS(<i>ccuu</i>) PRIMARY(<i>ssid,ser#,cca</i>) SECONDARY(<i>ssid,ser#,cca</i>)
Optional Parameters PRIMAINIT LSS(<i>X'pp',X'ss'</i>)

Required parameters

DDNAME|SYSNAME|UNITADDRESS parameter: identify the volume

Parameter/ Abbreviations	Description
DDNAME(<i>dname</i>) DNAME	Required for an online MVS volume. The volume must be online. For <i>dname</i> , specify the MVS JCL statement that identifies the volume.
SYSNAME(<i>sysxxx</i>)	Required for a VSE volume when executing ICKDSF in batch mode; the volume must be online. For <i>sysxxx</i> , specify the SYSNAME in the ASSGN system control statement.
UNITADDRESS(<i>ccuu</i>) UNITADDR UNIT	<p>Required for an offline MVS volume, a Stand-Alone volume, and a VM volume. For VSE, it is required when executing ICKDSF in command mode; the volume must be online.</p> <p>In MVS, the volume must be on a path that is online. If the volume is on a path that is offline, the program might enter a nonterminating wait state. For <i>ccuu</i>, specify the address (3 or 4 hex digits) of the channel and unit of the volume.</p> <p>For the CMS version, specify the virtual address of the dedicated volume or fullpack minidisk.</p> <p>The unit address is the device number.</p>
Default:	None.
Restrictions:	None.

PRIMARY and SECONDARY parameter: identify control unit

Parameter/ Abbreviations	Description
PRIMARY(<i>ssid,ser#,cca</i>) PRIM PRI	<p>Specifies the application site storage control subsystem ID, serial number, and channel connection address.</p> <p>The storage control subsystem ID (<i>ssid</i>) is a 4-digit hexadecimal address.</p> <p>The <i>ser#</i> is the storage control serial number, and is the last five digits of the 12-digit machine serial number for 3990 or the last seven digits of the 12-digit machine serial number for RVA.</p> <p>The channel connection address (<i>cca</i>) is a 2-digit hex address.</p> <p>The storage control subsystem id, storage control serial number, and channel connection address may be obtained with the CONTROL CONFIGURE(DISPLAY) command for 3990 or PPRCOPY QUERY without the PATHS parameter for RVA.</p>
SECONDARY(<i>ssid,ser#,cca</i>) SEC	Specifies the recovery site storage control subsystem ID, serial number, and the secondary volume channel connection address (<i>cca</i>). The descriptions for the values are the same as for the PRIMARY parameter.
Default:	None.
Restrictions:	None.

Optional parameters

LSS parameter: identify logical subsystem number

Parameter/ Abbreviations	Description
LSS(<i>X'pp'</i> , <i>X'ss'</i>)	LSS is required to identify the logical subsystem number on 2105 devices. The <i>X'pp'</i> value is the primary logical subsystem number. The <i>X'ss'</i> value is the secondary logical subsystem number. Obtain the logical subsystem number with the following command: CONTROL CONFIGURE(DISPLAY)
Default:	None.
Restrictions:	LSS is valid only for 2105 devices.

PRIMAINT parameter: reject write I/O

Parameter/ Abbreviations	Description
PRIMAINT PRIMA PRM	PRIMAINT directs PPRC to reject all write data I/O to the primary volume except for ICKDSF media maintenance channel programs.
Default:	None.
Restrictions:	Use the PRIMAINT option only as part of an ICKDSF media maintenance procedure as it causes the 3990 storage control to unit check all application write I/O to the primary device. PRIMAINT is not valid for RVA or 2105.

Example

The following command suspends PPRC operations between a volume pair. The PPRCOPY SUSPEND command must be issued to a valid primary or secondary PPRC device.

```
PPRCOPY SUSPEND UNIT(0D42) PRIM(X'0057',90007,X'02') -
SEC(X'053F',90014,X'0E')
```

A PPRCOPY ESTPAIR command specifying the RESYNC option must be issued to resume PPRC operations for the volume pair.

Note: When you reestablish a suspended pair that was originally established with CRIT(YES) specified, you must again specify CRIT(YES) with the PPRCOPY ESTPAIR command if you want this option to remain in effect.

Example for 2105 using LSS parameter

The following example shows a SUSPEND command for 2105 using the LSS parameter:

```
PPRCOPY SUSPEND UNIT(4C00) LSS(X'07',X'02') -
PRI(X'06C7',FCA29,X'01') SEC(X'06C2',FCA29,X'01')
```

PPRCOPY RECOVER—recovering data on the recovery system

Use the RECOVER command to allow the recovery system to regain control of a DASD volume. This command is issued from the recovery system. It signals the recovery site storage control to stop processing and force the secondary volume into simplex mode to reestablish recovery system control. During this process, you can verify the volser and relabel the volume if so desired.

Syntax

PPRCOPY RECOVER
Required Parameters DDNAME(<i>dname</i>) SYSNAME(<i>sysxxx</i>) UNITADDRESS(<i>ccuu</i>) PRIMARY(<i>ssid,ser#,cca</i>) SECONDARY(<i>ssid,ser#,cca</i>)
Optional Parameters NOVERIFY VERIFY(<i>serial</i>) VOLID(<i>serial</i>) LSS(<i>X'pp',X'ss'</i>)

Required parameters

DDNAME|SYSNAME|UNITADDRESS parameter: identify the secondary volume

Parameter/ Abbreviations	Description
DDNAME(<i>dname</i>) DNAME	Required for an online MVS volume. The volume must be online. For <i>dname</i> , specify the MVS JCL statement that identifies the volume.
SYSNAME(<i>sysxxx</i>)	Required for a VSE volume when executing ICKDSF in batch mode; the volume must be online. For <i>sysxxx</i> , specify the SYSNAME in the ASSGN system control statement.
UNITADDRESS(<i>ccuu</i>) UNITADDR UNIT	<p>Required for an offline MVS volume, a Stand-Alone volume, and a VM volume. For VSE, it is required when executing ICKDSF in command mode; the volume must be online.</p> <p>In MVS, the volume must be on a path that is online. If the volume is on a path that is offline, the program might enter a nonterminating wait state. For <i>ccuu</i>, specify the address (3 or 4 hex digits) of the channel and unit of the volume.</p> <p>For the CMS version, specify the virtual address of the dedicated volume or fullpack minidisk.</p> <p>The unit address is the device number.</p>
Default:	None.
Restrictions:	None.

PRIMARY and SECONDARY parameter: identify control unit

Parameter/ Abbreviations	Description
PRIMARY(<i>ssid,ser#,cca</i>) PRIM PRI	<p>Specifies the application site storage control subsystem ID, serial number, and channel connection address.</p> <p>The storage control subsystem ID (<i>ssid</i>) is a 4-digit hexadecimal address.</p> <p>The <i>ser#</i> is the storage control serial number, and is the last five digits of the 12-digit machine serial number for 3990 or the last seven digits of the 12-digit machine serial number for RVA.</p> <p>The channel connection address (<i>cca</i>) is a 2-digit hex address.</p> <p>The storage control subsystem id, storage control serial number, and channel connection address may be obtained with the CONTROL CONFIGURE(DISPLAY) command for 3990 or PPRCOPY QUERY without the PATHS parameter for RVA.</p>
SECONDARY(<i>ssid,ser#,cca</i>) SEC	Specifies the recovery site storage control subsystem ID, serial number, and the secondary volume channel connection address (<i>cca</i>). The descriptions for the values are the same as for the PRIMARY parameter.
Default:	None.
Restrictions:	None.

Optional parameters

VERIFY/NOVERIFY parameter: verify volser

Parameter/ Abbreviations	Description
VERIFY(<i>serial</i>) VFY	Required when you want to verify the volume serial number before relabeling it. If the volume serial number does not match that found on the volume, it will not be relabeled.
NOVERIFY NOVFY NVFY	Required when you want to bypass verification of the volume serial number.
Default:	None. You must specify either VERIFY or NOVERIFY.
Restrictions:	Valid only when you specify VOLID.

VOLID parameter: specify the volume serial number

Parameter/ Abbreviations	Description
VOLID(<i>serial</i>)	Writes the volume serial number in the volume label.
Default:	None.
Restrictions:	Valid only when you specify VERIFY or NOVERIFY. You cannot change the volume serial number of an online MVS volume. You must vary the volume offline to change the volume serial number.

LSS parameter: identify logical subsystem number

Parameter/ Abbreviations	Description
LSS(<i>X'pp',X'ss'</i>)	LSS is required to identify the logical subsystem number on 2105 devices. The <i>X'pp'</i> value is the primary logical subsystem number. The <i>X'ss'</i> value is the secondary logical subsystem number. Obtain the logical subsystem number with the following command: CONTROL CONFIGURE(DISPLAY)
Default:	None.
Restrictions:	LSS is valid only for 2105 devices.

Example

```
PPRC RECOVER UNIT(0C04) VFY(OLDC04) VOLID(NEWC04) -
  PRIM(X'6060',62006,X'04') SEC(X'6061',68006,X'09')
```

Example for 2105 using LSS parameter

The following example shows a RECOVER command for 2105 using LSS parameter:

```
PPRCOPY RECOVER UNIT(4C00) LSS(X'07',X'02') -
  PRI(X'06C7',FCA29,X'01') SEC(X'06C2',FCA29,X'01') -
  VFY(OLDC00) VOLID(NEWC00)
```

PPRCOPY QUERY—querying status

Use the PPRCOPY QUERY command to query the PPRC and path status of a volume. Query can be issued to either a primary or secondary PPRC volume. Path status is not available for the secondary device. For 2105, the LSS number will be displayed when it is available.

PPRCOPY commands—CKD

A host system that is attached only to a primary volume cannot obtain the status of the secondary volume for that pair. In the same way, a host that is attached only to the secondary volume cannot obtain the status of the primary volume.

Syntax

PPRCOPY QUERY
Required Parameters DDNAME(<i>dname</i>)SYSNAME(<i>sysxxx</i>)UNITADDRESS(<i>ccuu</i>)
Optional Parameters PATHS

Required parameters

DDNAME|SYSNAME|UNITADDRESS parameter: identify the volume

Parameter/ Abbreviations	Description
DDNAME(<i>dname</i>) DNAME	Required for an online MVS volume. The volume must be online. For <i>dname</i> , specify the MVS JCL statement that identifies the volume.
SYSNAME(<i>sysxxx</i>)	Required for a VSE volume when executing ICKDSF in batch mode; the volume must be online. For <i>sysxxx</i> , specify the SYSNAME in the ASSGN system control statement.
UNITADDRESS(<i>ccuu</i>) UNITADDR UNIT	Required for an offline MVS volume, a Stand-Alone volume, and a VM volume. For VSE, it is required when executing ICKDSF in command mode; the volume must be online. In MVS, the volume must be on a path that is online. If the volume is on a path that is offline, the program might enter a nonterminating wait state. For <i>ccuu</i> , specify the address (3 or 4 hex digits) of the channel and unit of the volume. For the CMS version, specify the virtual address of the dedicated volume or fullpack minidisk. The unit address is the device number.
Default:	None.
Restrictions:	None.

Optional parameters

PATHS parameter: display path status

Parameter/ Abbreviations	Description
PATHS	PATHS directs PPRC to display all of the paths associated with the application site storage control (primary), and the status of each path.
Default:	None.
Restrictions:	None.

Using PPRCOPY QUERY without the PATHS parameter

When you use the PPRCOPY QUERY command without the PATHS parameter, as in this example.

```
PPRCOPY UNIT(0D42) QUERY
```

You see the following information.

QUERY REMOTE COPY - VOLUME

DEVICE	LEVEL	STATE	PATH STATUS	(PRIMARY) SSID CCA SERIAL#	(SECONDARY) SSID CCA SERIAL#
0D42	PRIMARY	DUPLEX	ACTIVE	0057 02 90007	053F 0E 90014
PATHS	SAID/DEST	STATUS	DESCRIPTION		
1	0015 D600	01	PATH ESTABLISHED		
	----	00	NO PATH		
	----	00	NO PATH		
	----	00	NO PATH		
	----	00	NO PATH		
	----	00	NO PATH		
	----	00	NO PATH		
	----	00	NO PATH		

IF STATE = PENDING/SUSPEND: FIRST CYL OUT OF SYNC =
LAST CYL OUT OF SYNC =
SECONDARY WAS SUSPENDED (GMT): YYYY-MM-DD HH.MM.SS.NNNNNN

Note: On 2105 devices, IF PENDING/SUSPEND: COUNT OF TRACKS REMAINING TO BE COPIED = , will be printed instead of First and Last Cyl out of sync. This is presented only on the primary volume.

Table 49 describes the fields.

Table 49. Field descriptions

Field	Description
DEVICE	Displays the 4-digit hexadecimal device address.
LEVEL	Displays whether the volume is a primary or secondary volume. When the device is simplex, this column is not applicable (N/A).
STATE	Indicates whether the PPRC volume is in simplex, duplex pending, duplex, or suspended duplex (suspend(n)) state. XD is indicated if the volume is in PPRC extended distance mode. The value n for SUSPEND is one of the following: <ul style="list-style-type: none"> (3) Copy suspended. Host suspended the primary device. No read or write commands will be accepted. (4) Copy suspended. Host suspended the secondary device. Updates to the primary will be accepted and out of sync cylinders will be recorded. (5) Copy is suspended by the primary control unit update secondary device status command. This value is only returned by the secondary device. (6) Copy is suspended by internal conditions within the storage control. (7) Copy is suspended due to secondary control unit sending a state change interrupt to the primary control unit indicating a transition to simplex state. (8) Copy is suspended by internal conditions within the secondary device. (9) Copy is suspended as a result of an IML or power interruption to the primary site storage control. (A) Copy is suspended due to the host issuing a Freeze PPRC group order.
PATH STATUS	Displays whether the status is active or inactive. When device is a simplex or secondary volume, this column is not applicable (N/A).

PPRCOPY commands—CKD

Table 49. Field descriptions (continued)

Field	Description
PRIMARY SSID CCA Serial#	Displays the 4-digit hexadecimal subsystem ID (SSID) of the application site storage control, the 2-digit hexadecimal channel connection address (CCA) of the primary volume, and one of the following: <ul style="list-style-type: none">• The last 5 digits of the storage control serial number for 3990 or 2105.• The last 7 digits of the storage control serial number for RVA.• Dots, when the volume is a secondary.
SECONDARY SSID CCA Serial#	Displays the 4-digit hexadecimal subsystem ID (SSID) of the recovery site storage control, the 2-digit hexadecimal channel connection address (CCA) of the primary volume, and the last 5 digits of the storage control serial number for 3990 or the last 7 digits of the storage control serial number for RVA.
PATHS	Displays the number of valid links, if there are any, between application site and recovery site storage controls. Note: When device is a simplex or secondary volume, no information below this point will be displayed unless the secondary volume resides in the same storage control with the primary volume.
SAID	Displays the 4-digit hexadecimal system adapter ID (SAID) of the application site storage control. SAID and DEST (described below) make up the link address.
DEST	Specifies up to four 4-digit, hexadecimal-character link addresses. The link addresses each consist of a 2-digit, hexadecimal-character ESCON port address followed by the 2-digit, hexadecimal-character logical storage control ID. DEST and SAID (described above) make up the link address.

Table 49. Field descriptions (continued)

Field	Description
STATUS	<p data-bbox="518 254 1130 279">A 2-digit number indicating the detailed status of the path</p> <p data-bbox="518 310 1094 336">The following is a short description of status indicator:</p> <ul style="list-style-type: none"> <li data-bbox="518 346 683 371">• 00 - No path <li data-bbox="518 382 776 407">• 01 - Established path <li data-bbox="518 420 789 445">• 02 - Initialization failed <li data-bbox="518 457 691 483">• 03 - Time out <li data-bbox="518 493 959 518">• 04 - No resources available at primary <li data-bbox="518 531 989 556">• 05 - No resources available at secondary <li data-bbox="518 569 857 594">• 06 - Serial number mismatch <li data-bbox="518 606 821 632">• 07 - SCU SSID mismatch <li data-bbox="518 644 821 669">• 08 - ESCON link is offline <li data-bbox="518 682 1227 707">• 09 - Establish failed but will retry again when conditions change <li data-bbox="518 720 1157 745">• 0A - System adapter has a host path already established <li data-bbox="518 758 1094 783">• 0B - Path cannot be connected in the same cluster <li data-bbox="518 795 797 821">• 10 - Configuration error <li data-bbox="518 833 1032 858">• 11 - Cannot establish between CKD and FBA <li data-bbox="518 871 964 896">• 12 - LSS and link address miscompare <li data-bbox="518 909 834 934">• 13 - Fibre path established <li data-bbox="518 947 906 972">• 14 - Fibre channel path link down <li data-bbox="518 984 964 1010">• 15 - Fibre channel path retry exceeded <li data-bbox="518 1022 1430 1068">• 16 - Fibre channel path secondary adapter not PPRC capable. This problem could be due to one of the following: <ul style="list-style-type: none"> <li data-bbox="581 1100 1357 1150">- Secondary adapter not configured properly, does not have the correct microcode loaded <li data-bbox="610 1163 639 1188">Or <li data-bbox="581 1199 1344 1224">- The secondary adapter is already a target of 32 different ESS boxes <li data-bbox="518 1236 1146 1262">• 17 - Fibre channel path secondary adapter not available <li data-bbox="518 1274 1053 1299">• 18 - Fibre channel path primary login exceeded <li data-bbox="518 1312 1084 1337">• 19 - Fibre channel path secondary login exceeded <li data-bbox="518 1350 846 1375">• nn - Status is undetermined
FIRST CYL...	<p data-bbox="518 1388 1442 1438">This information, when available, is presented only for volumes in duplex pending and suspended duplex states.</p> <p data-bbox="518 1470 1458 1608">If the volume is a primary volume, this is the lowest cylinder number out of synchronization on the primary volume. If the volume is a secondary volume, this is the lower cylinder number received from the primary which is staged in cache and not yet written to the secondary volume. Users might receive this information intermittently due to the staging in cache.</p>
LAST CYL...	<p data-bbox="518 1629 1458 1797">This information, when available, is presented only for volumes in duplex pending and suspended duplex states. If the volume is primary volume, this is the highest cylinder number out of synchronization on the primary volume. If the volume is a secondary volume, this is the higher cylinder number received from the primary which is staged in cache and not yet written to the secondary volume. Users might receive this information intermittently due to the staging in cache.</p>

PPRCOPY commands—CKD

Table 49. Field descriptions (continued)

Field	Description
TRACKS REMAINING...	'IF PENDING/SUSPEND: COUNT OF TRACKS REMAINING TO BE COPIED = ' This information, when available is presented only for primary volumes in duplex pending or suspended duplex states. This is printed on 2105 devices instead of the First and Last Cyl Out of sync information.
SECONDARY SUSPENDED	When available, the Greenwich Mean Time (GMT) that this secondary volume was suspended. In the ISO form: "YYYY-MM-DD HH.MM.SS.NNNNNN". Note: This time stamp is the value from the clock of the system that issued the SUSPEND. It may not be the application system or even the same systems that are receiving the QUERY response, so you may not be able to correlate the time value with events on the application system or other systems.

Using PPRCOPY QUERY with the PATHS parameter

When you use the PPRCOPY QUERY command with the PATHS parameter, as in this example.

```
PPRCOPY UNIT(DA01) QUERY PATHS
```

You see the following information.

```
PPRC QUERY UNIT(DA01) PATHS
ICK00700I DEVICE INFORMATION FOR DA01 IS CURRENTLY AS FOLLOWS:
    PHYSICAL DEVICE = 3390
    STORAGE CONTROLLER = 3990
    STORAGE CONTROL DESCRIPTOR = E9
    DEVICE DESCRIPTOR = 0A
    ADDITIONAL DEVICE INFORMATION = 4A001B35
ICK04030I DEVICE IS A PEER TO PEER REMOTE COPY VOLUME
ICK02213I VOLUME IS ELIGIBLE FOR PPRC CASCADING
Note: The remainder of this output will only be
produced for an intermediate device.
ICK02214I INFORMATION FOR THIS VOLUME AS A PRIMARY FOLLOWS
```

QUERY REMOTE COPY - PATHS

PRIMARY CONTROL UNIT INFORMATION

SERIAL NUMBER	SSID	LSS NUM	WORLD WIDE NODE NAME
25738	3805	04	5005076300C0A222

SECONDARY CONTROL UNIT INFORMATION

SERIAL NUMBER	SSID	WORLD WIDE NODE NAME	PATH	SAID	DEST	S*
1ST: 12032	320A	5005076300234567	1	0001	0009	01
			2	0081	0009	01
2ND: 25738	3806	5005076300C0A222	1	008C	002C	13
3RD:	00
4TH:	00

S*=PATH STATUS

```
00=NO PATH
01=ESTABLISHED
02=INIT FAILED
03=TIME OUT
04=NO RESOURCES AT PRI
05=NO RESOURCES AT SEC
06=SERIAL# MISMATCH
07=SCU SSID MISMATCH
```



```

|      08=ESCON LINK IS OFFLINE
|      09=ESTABLISH FAILED BUT WILL RETRY AGAIN WHEN CONDITIONS CHANGE
|      0A=SYSTEM ADAPTER HAS A HOST PATH ALREADY ESTABLISHED
|      0B=PATH CANNOT BE CONNECTED IN THE SAME CLUSTER
|      10=CONFIGURATION ERROR
|      11=CANNOT ESTABLISH PATH BETWEEN CKD AND FBA
|      12=LSS AND LINKADDRESS MISCOMPARE
|      13=ESTABLISHED FIBRE CHANNEL PATH
|      14=FIBRE CHANNEL PATH LINK DOWN
|      15=FIBRE CHANNEL PATH RETRY EXCEEDED
|      16=FIBRE CHANNEL PATH SECONDARY ADAPTER NOT PPRC CAPABLE
|      17=FIBRE CHANNEL PATH SECONDARY ADAPTER NOT AVAILABLE
|      18=FIBRE CHANNEL PATH PRIMARY LOGIN EXCEEDED
|      19=FIBRE CHANNEL PATH SECONDARY LOGIN EXCEEDED

```

The logical subsystem number (LSS) will be printed for 2105 devices, if available.

The display contains the following information for the application (PRIMARY) storage control:

- The last 5 digits of the application site storage control serial number for 3990 or 2105 or the last 7 digits of the application site storage control serial number for RVA.
- The 4-digit hexadecimal subsystem ID (SSID)

The display contains information for up to four recovery site (SECONDARY) storage controls. Under each storage control it lists:

- The last 5 digits of the serial number for 3990 or 2105
- The last 7 digits of the serial number for RVA
- The 4-digit hexadecimal subsystem ID (SSID)
- The count of the number of paths established for that subsystem
- Specific information for each path, with the SAID, followed by the link address (DEST), followed by the status of that path (S*)

Table 50 explains the path status codes.

Table 50. Path status codes

Path Status Code	Meaning
00 - NO PATH	The request to establish this path is in process, or no request has been made for this entry. (The SAID/DEST appears as "----" until the PPRCOPY ESTPATH command operation has completed.)
01 - ESTABLISHED	ESCON path is operational.
02 - INIT FAILED	An attempt to establish this path has failed. Verify the physical link, including ESCD ports, for the connection you are attempting. Verify the integrity of the fiber optic links between the requested source and the destination.
03 - TIME OUT	An attempt to establish this path has failed. Verify the physical link at the application storage control. Determine if non-PPRC system activity has degraded link response times during the establish time. Retry the PPRCOPY ESTPATH command.
04 - NO RESOURCES AT PRI	An attempt to establish this path has failed. Verify that the application storage control does not already have the maximum number of logical paths already established. Verify the configuration and remove any unnecessary channel paths. When the problem is resolved, issue a PPRCOPY QUERY command with the PATHS option to verify that the path has been automatically established.

PPRCOPY commands—CKD

Table 50. Path status codes (continued)

Path Status Code	Meaning
05 - NO RESOURCES AT SEC	An attempt to establish this path has failed. Verify that the recovery site storage control does not already have the maximum number of logical paths already established. Verify the configuration and remove any unnecessary channel paths. When the problem is resolved, issue a PPRCOPY QUERY command with the PATHS option to verify that the path has been automatically established.
06 - SERIAL # MISMATCH	The recovery site storage control specified by the SAID/DEST does not have the same serial number specified in the PPRCOPY ESTPATH command. Verify the SAID/DEST port and serial number parameters. A PPRCOPY QUERY command with the PATHS option from the host to a secondary volume can provide the serial number information.
07 - SCU SSID MISMATCH	Secondary Control Unit SSID mismatch.
08 - ESCON LINK IS OFFLINE	ESCON link is offline.
09 - ESTABLISH FAILED BUT WILL RETRY WHEN CONDITIONS CHANGE	The attempt to establish state will persist until a CU retry is successful or a PPRCOPY DELETE PATHS is executed.
0A - SYSTEM ADAPTER HAS A HOST PATH ALREADY ESTABLISHED	0A is returned if you try to establish a path on a link where a host connection exists.
0B - PATH CANNOT BE CONNECTED IN THE SAME CLUSTER	Path cannot be connected in the same cluster.
10 - CONFIGURATION ERROR	The SAID is invalid for the application site 3990 ESCON SA card, or a PPRC path has already been established on this logical link. Verify the SAID is appropriate for the number of physical ESCON ports installed on the application storage control SA card. Issue a PPRCOPY QUERY command with the PATHS option to the indicated storage controls at both sites to determine if this is already a PPRC logical path, possibly established in the other direction.
11 - CANNOT ESTABLISH BETWEEN CKD AND FBA	A PPRC session cannot be established between CKD and FBA device.
12 - LSS AND LINK ADDRESS MISCOMPARE	The secondary LSS in the LSS parameter does not match the last byte of the LINK address. 'cc' in the LINK parameter of ESTPATH.
13 - ESTABLISHED FIBRE CHANNEL PATH	The fibre channel path is operational.
14 - FIBRE CHANNEL PATH LINK DOWN	The fibre channel path link is down.
15 - FIBRE CHANNEL PATH RETRY EXCEEDED	The fibre channel path retry is exceeded.
16 - FIBRE CHANNEL PATH SECONDARY ADAPTER NOT PPRC CAPABLE	The fibre channel path secondary adapter not PPRC capable. This problem could be due to one of the following: <ul style="list-style-type: none"> – Secondary adapter not configured properly, does not have the correct microcode loaded Or – The secondary adapter is already a target of 32 different ESS boxes
17 - FIBRE CHANNEL PATH SECONDARY ADAPTER NOT AVAILABLE	The fibre channel path secondary adapter is not available.
18 - FIBRE CHANNEL PATH PRIMARY LOGIN EXCEEDED	The fibre channel path primary login is exceeded.

Table 50. Path status codes (continued)

Path Status Code	Meaning
19 - FIBRE CHANNEL PATH SECONDARY LOGIN EXCEEDED	The fibre channel path secondary login is exceeded.

Establishing and managing PPRC volumes and paths

This section explains the major PPRC system dependencies, and describes how to:

- Manage the PPRC system
- Identify PPRC volume states
- Set cache and non-volatile storage
- Obtain SSID, serial number, CCA, and LSS
- Obtain Physical Interface and ESCON Director Address
- Establish PPRC paths
- Manage PPRC volumes and paths
- Determining the Logical Subsystem Number (LSS) for 2105
- Determining the Logical Control Unit (LCU) for RVA
- Determining the Channel Connection Address for RVA

Managing the PPRC system

This section gives the PPRC system management dependencies.

System IPL volumes

Because PPRC secondary volumes are treated much like 3990 dual copy volumes, a limited set of I/O operations to these volumes is permitted. Therefore, during recovery, you can IPL a recovery system, one that is separate from all PPRC volumes, in order to issue the PPRCOPY RECOVER command and remove all PPRC volumes from secondary PPRC volume status. As a result, SYSRES, PAGE, and SPOOL volumes, as well as all data sets required to initialize the recovery system (including those used to startup JES and TSO) should not be PPRC secondary volumes.

Alternatively, you can have a second set of SYSRES, PAGE, and SPOOL volumes that are copied to as part of PPRC and have a separate set of these volumes to use for recovery. When recovery is complete, the recovered set of SYSRES, PAGE, and SPOOL volumes can then be used to initialize the recovered system.

The PPRC RECOVER command with the ICKDSF Stand-Alone version may also be used to remove the PPRC volumes from secondary volume status.

ESCON Manager

PPRC paths and operations are not known to the ESCON Manager. As a result, when making PPRC changes to the ESCON Director, you must be aware of all of the existing physical path connections. This includes configuration changes made at the ESCON Director console or through the ESCON Manager's integrated systems management feature, because no protection (using ESCON Manager) is available.

Performance measurement data

Each application host system write I/O operation is directed through the PPRC connection to the recovery site storage control, and then to the recovery system DASD. Activity on the PPRC connection will not be reported in performance reports.

PPRCOPY commands—CKD

Performance reports list reasons for I/O operation delays, including storage control and ESCON Director port "busy" states. Even though PPRC activity may be responsible for these busy conditions, PPRC activity itself is not tracked by Performance measurement software explicitly. Application system I/O operations may be delayed due to PPRC activity. You should consider this when you do your capacity planning as well as performance data interpretation.

Console device status commands

Existing MVS, VM, and VSE operator commands used to determine the status of IBM Storage Control 3990 dual copy pair, cache, NVS, and DASD Fast Write functions are not extended with PPRC support. These facilities do not report PPRC copy volume pairs or states. The PPRC QUERY is the command that can display information about PPRC volumes. In addition, the CONTROL CONFIG(DISPLAY) command can also display the volume SSID, CCA, serial number, the existing path SAID, and destination address for the specified volume. The CONTROL CONFIG(DISPLAY) command is not valid for RVA. The ANALYZE NODRIVE NOSCAN can also be used to display 3990 or 2105 Logical Path Status. If the new WWNN keyword is used to identify an FCP capable device, a list of potential connectivity between SAIDs on the addressed device and SAIDs on the identified device is displayed. The ANALYZE NODRIVE NOSCAN is not valid for RVA.

Reset notification

Whenever the connectivity of a storage control or device changes, such as when they are moved from one system to another or they are varied offline or online, a reset notification is raised to all attached hosts. In some situations, such as when active volumes are switched to another system, the reset notification can invalidate the PPRC synchronous copy operation. State changes are sent to all attached host systems through self description data.

Warning

Use caution when changing storage control, volume, or path connectivity for PPRC-managed volumes. If access to secondary volumes is lost, the PPRC volume pair goes into suspended duplex state.

Identifying Peer-to-Peer Remote Copy volume states

In order to manage Peer-to-Peer Remote Copy (PPRC) operations, you need to know the state of PPRC volumes. To determine the state of a volume, issue the PPRCOPY QUERY command to that volume.

At any given time a volume can be in one of the following states:

Simplex—The initial state of a volume.

Duplex—The state of a volume pair after copying is complete and the volume pair is in synchronization.

Duplex pending—The initial state of a defined volume pair. This state can also occur after a storage subsystem failure when the volume pair is reestablished. Data is copied to each volume in the pair.

Pending-XD—The volumes have been established in PPRC extended distance mode.

Suspended duplex—The state of a volume pair when the 3990 Model 6 subsystems cannot keep the primary and secondary volumes synchronized, or when either the application host or recovery site host issues a PPRCOPY SUSPEND command. A PPRC volume pair will go into suspended duplex state, for instance, when the application system 3990 Model 6 fails to complete a write operation to the recovery system 3990 Model 6. During this state, the primary volume's storage control records cylinders that have been updated so that, when a PPRCOPY ESTPAIR command with the RESYNC parameter is issued, only data in cylinders that have been changed is recopied to get both volumes back into a synchronized state.

Details for setting cache and non-volatile storage

This section gives the details for setting cache and NVS.

The cache and NVS requirements for the 3990 Model 6 at the application and recovery sites are shown in Table 51.

Table 51. 3990 Model 6 NVS and cache requirements

3990-6 Location	Subsystem Cache	NVS	Device Cache	DASD Fast Write
Application Site	Required	Required	Recommended	Recommended
Recovery Site	Required	Required	Required	Required

Use the following host processor SCP commands to set cache and NVS:

- On VM, the primary and secondary devices to be used should be varied on, and attached to your user ID, before beginning. Also, at times when status changes and VM is unaware of it (for example, re-IML, power cycle), you may need to detach the devices, vary them off, then vary them back on, and then attach to your user ID again.

Note: The secondary does not need to be attached and on-line, but having it attached to the user prevents other users from being able to access and change the data on that device.

- In the following examples 0D48 is used for the CCUU of the primary, and 0D8C is the secondary CCUU.
- On VM, type CMS command:

```
q dasd details d48
0D48 CUTYPE = 3990-E9, DEVTYPE = 3390-06, VOLSER =
  CACHE DETAILS:  CACHE NVS CFW DFW PINNED CONCOPY
    -SUBSYSTEM   Y   Y   Y   -   N   N
    -DEVICE      Y   -   -   N   N   N
  DEVICE DETAILS: CCA = 08, DDC = 08
  DUPLEX DETAILS: SIMPLEX
```

```
q dasd details D8C
0D8C CUTYPE = 3990-E9, DEVTYPE = 3390-0A, VOLSER =
  CACHE DETAILS:  CACHE NVS CFW DFW PINNED CONCOPY
    -SUBSYSTEM   Y   Y   Y   -   N   N
    -DEVICE      Y   -   -   N   N   N
  DEVICE DETAILS: CCA = 0C, DDC = 0C
  DUPLEX DETAILS: SIMPLEX
```

From the above VM responses, Device DFW on the secondary needs to be turned on:

PPRCOPY commands—CKD

```
#CP SET DASDFW ON D8C
0D8C DASD fast write function has been activated.

q dasd details D8C
0D8C CUTYPE = 3990-E9, DEVTYPE = 3390-0A, VOLSER =
  CACHE DETAILS:  CACHE NVS CFW DFW PINNED CONCOPY
                   -SUBSYSTEM Y Y Y - N N
                   -DEVICE Y - - Y N N
  DEVICE DETAILS: CCA = 0C, DDC = 0C
  DUPLEX DETAILS: SIMPLEX
```

- The other relevant VM commands to use, in the event that cache and/or NVS are not active, would be:

```
#CP set cache subsystem on CUU /* sets 'subsys' cache on */
#CP set cache device on CUU /* sets 'device' cache on */
#CP set nvs on CUU /* sets 'subsys' NVS on */
```

- On MVS, use the command DS p,uu,1 (on TSO use /ds p,uu,1)

```
DS P,D48,1
IEE459I 07.15.45 DEVSERV PATHS 799
UNIT DTYPE M CNT VOLSER CHPID=PATH STATUS
  RTYPE SSID CFW TC DFW PIN DC-STATE CCA DDC ALT CU-TYP
0D48,33902 ,F,000, ,20=+ 24=+
  0057 Y YY. NY. N SIMPLEX 08 08 3990-6
F = OFFLINE + = PATH AVAILABLE
```

```
DS P,D8C,1
IEE459I 07.30.08 DEVSERV PATHS 823
UNIT DTYPE M CNT VOLSER CHPID=PATH STATUS
  RTYPE SSID CFW TC DFW PIN DC-STATE CCA DDC ALT CU-TYP
0D8C,33903 ,F,000, ,20=+ 25=+ 22=+ 27=+
  053F Y YY. YY. N SIMPLEX 0C 0C 3990-6
  |
  | | | |
  | | | | +--- NO pinned data
  | | | | +--- NVS is ACTIVE
  | | | | +--- DASDFW Vol. ELIGIBLE for DASD Fast Write
  | | | | +----- Track Caching ACTIVE for SUBSYS
  | | | | +----- Vol. ELIGIBLE for Track Caching
  | | | | +----- Cache Fast Write is ACTIVE
```

- On MVS, activate cache and/or NVS, from ISPF, select ISMF, then select number 2 ...

```
ISMF PRIMARY OPTION MENU
ENTER SELECTION OR COMMAND ==> 2

SELECT ONE OF THE FOLLOWING:

0 ISMF PROFILE - Change ISMF user profile
1 DATA SET - Perform Functions Against Data Sets
2 VOLUME - Perform Functions Against Volumes
```

Then you see the following panel, select number 1 ...

```
VOLUME LIST SELECTION MENU
ENTER SELECTION OR COMMAND ==>

SELECT ONE OF THE FOLLOWING:

1 DASD - Generate a list of DASD volumes
```

Continue by entering the appropriate values on the next panel, use 'help' if needed.

- On VSE, use the following AR commands to determine cache/NVS status: (AR=Attention Routine commands)

```
CACHE SUBSYS=D48,STATUS
```

```
SUBSYSTEM CACHING STATUS: ACTIVE
CACHE FAST WRITE: ACTIVE
NVS STATUS: AVAILABLE
```

```
CACHE UNIT=D48,STATUS
```

```
DEVICE CACHING STATUS: ACTIVE
DASD FAST WRITE: ACTIVE
DUAL COPY STATUS: SIMPLEX
```

- On VSE, activate cache and/or NVS with the following AR commands:

```
CACHE UNIT=cuu,ON      Activates caching for the specified device.
CACHE SUBSYS=cuu,ON    Activates caching for the entire specified
                        subsystem.
CACHE UNIT=cuu,FAST,ON Enables DASD fast write access for the
                        specified device.
CACHE SUBSYS=cuu,NVS,ON Makes non-volatile storage available
                        for the subsystem.
```

Obtain SSID, serial number, CCA, and LSS

This section gives the details for obtaining SSID, Serial Number, CCA, and LSS for both primary and secondary sites.

Invoke ICKDSF and execute the following listed commands. Note and save the values indicated by "-->"; these values are required as parameters for issuing the ICKDSF PPRC commands.

Note: If no Interface connection exists from the primary site CPU to the secondary control unit, the command must be issued at the secondary site for that secondary CU.

```
ENTER INPUT COMMAND:

CONTROL UNIT(DA06) CONFIG(DISPLAY)
ICK00700I DEVICE INFORMATION FOR DA06 IS CURRENTLY AS FOLLOWS:
      PHYSICAL DEVICE = 3390
      STORAGE CONTROLLER = 2105
      STORAGE CONTROL DESCRIPTOR = E8
      DEVICE DESCRIPTOR = 0A
      ADDITIONAL DEVICE INFORMATION = 4A000035
ICK04000I DEVICE IS IN SIMPLEX STATE
ICK00091I DA06 NED=002105.000.IBM.13.000000025738
ICK00706I SUBSYSTEM INFORMATION FOR DA06 IS CURRENTLY AS FOLLOWS:
--> SUBSYSTEM SERIAL NUMBER = 25738
--> SUBSYSTEM ID = 3805
--> CHANNEL CONNECTION ADDRESS = 06
      PATHS/CLUSTER ID = N/A
--> LSS NUMBER = 04
      SYSTEM ADAPTER ID = 08
      HOST LINK ADDRESS = 61141305
ICK00001I FUNCTION COMPLETED, HIGHEST CONDITION CODE WAS 0

ENTER INPUT COMMAND:

CONTROL UNIT(D8A6) CONFIG(DISPLAY)
ICK00700I DEVICE INFORMATION FOR D8A6 IS CURRENTLY AS FOLLOWS:
      PHYSICAL DEVICE = 3390
      STORAGE CONTROLLER = 2105
      STORAGE CONTROL DESCRIPTOR = E8
      DEVICE DESCRIPTOR = 0A
```

PPRCOPY commands—CKD

```

|
|           ADDITIONAL DEVICE INFORMATION = 4A000035
| ICK04000I  DEVICE IS IN SIMPLEX STATE
| ICK00091I  D8A6 NED=002105.000.IBM.13.000000028639
| ICK00706I  SUBSYSTEM INFORMATION FOR DA06 IS CURRENTLY AS FOLLOWS:
|
| -->       SUBSYSTEM SERIAL NUMBER = 28639
| -->       SUBSYSTEM ID = 4306
| -->       CHANNEL CONNECTION ADDRESS = 05
|           PATHS/CLUSTER ID = N/A
| -->       LSS NUMBER = 07
|           SYSTEM ADAPTER ID = 06
|           HOST LINK ADDRESS = 53241305
| ICK00001I  FUNCTION COMPLETED, HIGHEST CONDITION CODE WAS 0
|

```

Obtain physical 3990 interface and ESCON Director address

This section gives the details for obtaining the physical 3990 cluster interface destination address (cluster port) and ESCON Director destination address (output port).

This information may be obtained from the system programmer and/or from the individual(s) that have the physical planning responsibility for the sites.

The destination address may be located at the secondary site, and the person(s) to be contacted may be at the remote location.

The following is an example of how to obtain the link parameters required by some of the ICKDSF PPRC commands. This example shows:

- 3990 primary and secondary site control units connected by way of a 9032 ESCON Director.
- The cluster port address of the primary 3990 (you need this value) that is being connected to the secondary 3990 or ESCON Director.
- The output port address of the ESCON Director (you need this value)

For two 3990-6 control units interconnected directly, the third byte value used is x'00'.

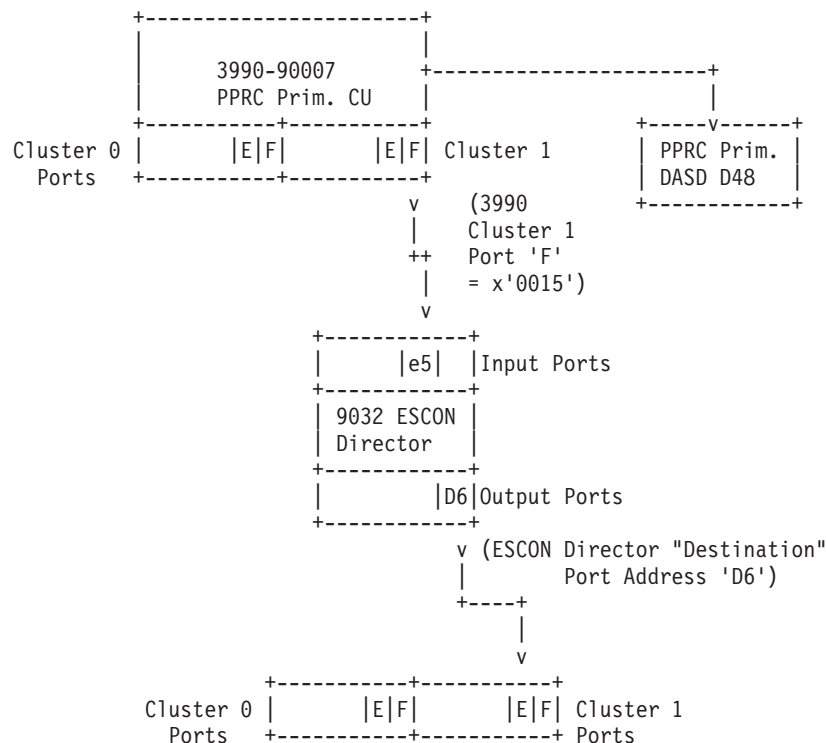

PPRCOPY commands—CKD

storage control (SSID 6061, serial number ending with 68006). The PPRCOPY ESTPATH command is issued to any device on the application site storage control.

```
PPRCOPY ESTPATH UNIT(0142) PRIM(X'6060',62006) SEC(X'6061',68006) -
LINK(X'0000B000',X'0001B000',X'0016B000',X'0017B000')
```

The example assumes that all of the physical and logical paths already exist.

Managing volumes and paths

This section describes how to add, delete, and suspend volume pairs, query a Peer-to-Peer Remote Copy volume, and delete a PPRC path.

Establishing a PPRC volume pair

Use the PPRCOPY ESTPAIR command to specify the PPRC primary and secondary volumes. The PPRCOPY ESTPAIR command is issued to the primary (source) device address.

Prior to issuing the PPRCOPY ESTPAIR command, it may be useful to issue a PPRCOPY QUERY command to each of the simplex devices that will become the PPRC duplex pair. The returned information includes the device's storage control SSID and serial number, and the device's CCA. This information is required as part of the PPRCOPY ESTPAIR command.

The following command establishes a PPRC volume pair.

```
PPRCOPY ESTPAIR UNIT(0D42) PRIM(X'0057',90007,X'02') -
SEC(X'053F',90014,X'0E') MODE(COPY) PACE(15) CRIT(N)
```

Querying PPRC volumes and paths

Issue the PPRCOPY QUERY command to query the status of one volume of a PPRC volume pair, the status of all PPRC paths established for a volume's storage control, or to collect information about a volume in the simplex state.

The following command queries volume 0D42:

```
PPRCOPY QUERY UNIT(0D42)
```

PPRCOPY QUERY without the PATHS parameter

When the PPRCOPY QUERY command is issued without the PATHS parameter, the following information is displayed to the ICKDSF user.

```
QUERY REMOTE COPY - VOLUME
```

DEVICE	LEVEL	STATE	PATH STATUS	(PRIMARY)		(SECONDARY)	
				SSID	CCA SERIAL#	SSID	CCA SERIAL#
0D42	PRIMARY	PENDING	ACTIVE	0057	02 90007	0000	00
PATHS	SAID/DEST	STATUS	DESCRIPTION				
1	0015 D600	01	PATH ESTABLISHED				
	----	00	NO PATH				
	----	00	NO PATH				
	----	00	NO PATH				

IF STATE=PENDING or SUSPEND: FIRST CYL OUT OF SYNC = 00509
LAST CYL OUT OF SYNC = 02225

Note: On 2105 devices, IF PENDING/SUSPEND: COUNT OF TRACKS REMAINING TO BE COPIED = , will be printed instead of First and Last Cyl out of

sync. This is presented only on the primary volume. The STATE will also indicate XD if the volume is in PPRC extended distance mode.

When the PPRCOPY QUERY command is issued without the PATHS parameter and to a simplex volume, the following information is displayed to the ICKDSF user.

```

QUERY REMOTE COPY - VOLUME

                                (PRIMARY) (SECONDARY)
                                SSID CCA  SSID CCA
                                SERIAL#  SERIAL#
-----
0D42      N/A      SIMPLEX      N/A      0057 02  0000 00
                                90007      .....
    
```

When the PPRCOPY QUERY command is issued without the PATHS parameter and to a secondary volume, the following information is displayed to the ICKDSF user.

```

QUERY REMOTE COPY - VOLUME

                                (PRIMARY) (SECONDARY)
                                SSID CCA  SSID CCA
                                SERIAL#  SERIAL#
-----
0D42      SECONDARY  DUPLEX      N/A      0057 02  0000 00
                                90007      .....
    
```

PPRCOPY QUERY with the PATHS parameter

When the PPRCOPY QUERY is issued, the output also reflects the FCP path information along with the world wide node name (WWNN).

```

PPRC QUERY UNIT(DA01) PATHS
ICK00700I DEVICE INFORMATION FOR DA01 IS CURRENTLY AS FOLLOWS:
      PHYSICAL DEVICE = 3390
      STORAGE CONTROLLER = 3990
      STORAGE CONTROL DESCRIPTOR = E9
      DEVICE DESCRIPTOR = 0A
      ADDITIONAL DEVICE INFORMATION = 4A001B35
ICK04030I DEVICE IS A PEER TO PEER REMOTE COPY VOLUME
ICK02213I VOLUME IS ELIGIBLE FOR PPRC CASCADING
ICK02214I INFORMATION FOR THIS VOLUME AS A PRIMARY FOLLOWS
    
```

The information shown below is for example purposes only; the actual values would reflect the real devices used. The example shows only two secondary control units. The third and fourth secondary would follow in a similar fashion. Only 2 paths are shown in this example, however all 8 paths might be shown if they are available.

```

QUERY REMOTE COPY - PATHS

PRIMARY CONTROL UNIT INFORMATION
      SERIAL      LSS  WORLD WIDE
      NUMBER  SSID  NUM  NODE NAME
-----
      25738    3805  04  5005076300C0A222

SECONDARY CONTROL UNIT INFORMATION
      SERIAL      WORLD WIDE
      NUMBER  SSID  NODE NAME      PATH  SAID  DEST  S*
-----
1ST:  12032    320A  5005076300234567  1    0001  0009  01
      2       0081  0009  01
2ND:  25738    3806  5005076300C0A222  1    008C  002C  13
3RD:  .....
4TH:  .....
    
```

PPRCOPY commands—CKD

```
S*=PATH STATUS
00=NO PATH
01=ESTABLISHED
02=INIT FAILED
03=TIME OUT
04=NO RESOURCES AT PRI
05=NO RESOURCES AT SEC
06=SERIAL# MISMATCH
07=SCU SSID MISMATCH
08=ESCON LINK IS OFFLINE
09=ESTABLISH FAILED BUT WILL RETRY AGAIN WHEN CONDITIONS CHANGE
0A=SYSTEM ADAPTER HAS A HOST PATH ALREADY ESTABLISHED
0B=PATH CANNOT BE CONNECTED IN THE SAME CLUSTER
10=CONFIGURATION ERROR
11=CANNOT ESTABLISH PATH BETWEEN CKD AND FBA
12=LSS AND LINKADDRESS MISCOMPARE
13=ESTABLISHED FIBRE CHANNEL PATH
14=FIBRE CHANNEL PATH LINK DOWN
15=FIBRE CHANNEL PATH RETRY EXCEEDED
16=FIBRE CHANNEL PATH SECONDARY ADAPTER NOT PPRC CAPABLE
17=FIBRE CHANNEL PATH SECONDARY ADAPTER NOT AVAILABLE
18=FIBRE CHANNEL PATH PRIMARY LOGIN EXCEEDED
19=FIBRE CHANNEL PATH SECONDARY LOGIN EXCEEDED
```

Note: The logical subsystem number (LSS) will be printed for 2105 devices, if available.

Suspending PPRC volume pair operations

Issue the PPRCOPY SUSPEND command to suspend PPRC operations between the primary and secondary of a volume pair. When you specify the SUSPEND parameter, this allows the primary applications to resume their read and write I/O to these volumes, and also directs the primary application storage subsystem to keep a record of cylinders that change on the primary volumes.

Access is permitted to the primary volumes and all changed tracks are logged on the primary storage control. For this example, you could next issue a PPRCOPY DELPAIR command or a PPRCOPY ESTPAIR command to continue in either simplex or duplex state.

The following command suspends PPRC operations between a volume pair. The PPRCOPY SUSPEND command must be issued to a valid primary or secondary PPRC device.

```
PPRCOPY SUSPEND UNIT(0D42) PRIM(X'0057',90007,X'02') -
SEC(X'053F',90014,X'0E')
```

A PPRCOPY ESTPAIR command specifying the RESYNC option must be issued to resume PPRC operations for the volume pair.

Note: When you reestablish a suspended pair that was originally established with CRIT(YES) specified, you must again specify CRIT(YES) with the PPRCOPY ESTPAIR command if you want this option to remain in effect.

Deleting a PPRC volume pair

Issue the PPRCOPY DELPAIR command to delete PPRC primary and secondary volumes. Direct the command to the primary device.

The following command deletes a PPRC volume pair:

```
PPRCOPY DELPAIR UNIT(D42) PRIM(X'0057',90007,X'02') -
SEC(X'053F',90014,X'0E')
```

Deleting a PPRC path

Use the PPRCOPY DELPATH command to delete all established ESCON/FCP paths between application site storage controls and recovery site storage controls. The PPRCOPY DELPATH command must be issued only to a valid PPRC primary device. In a cascaded triad, the remote pair can be broken leaving the intermediate volume a secondary in the local pair. In such a case the DELPATH command can be successfully issued to this intermediate volume.

Only active paths to the recovery site storage control are affected, all other paths to other storage controls are unaffected.

The following command deletes all established ESCON paths between application site storage control 0057 and recovery site storage control 053F.

```
PPRCOPY DELPATH UNIT(D42) PRIM(X'0057',90007) SEC(x'053F',90014)
```

Determining the logical subsystem number (LSS) for 2105

Run the ICKDSF CONTROL CONFIGURE(DISPLAY) command to display the LSS number. The LSS number is also displayed when ANALYZE NODRIVE NOSCAN is run.

Determining the logical control unit (LCU) number for RVA

The LCU can be calculated from the output of the MVS DEVSERV PATHS command by substituting the DDC value for the last two digits of the device number in Table 6. For example, for a DDC address in the 00 - 3F range, use LCU0; in the 80 - BF range, use LCU2. Another way to determine the LCU number is to refer to the CUADD, which is specified in the IOCP/HCD configuration for each logical control unit. Each of the four CUADD's contain 64 devices. If the device numbers on the RVA subsystem have been generated as a contiguous group of 256 addresses, the LCU can be calculated from the last two digits of the device number. For example, for device numbers AA40-AA7F the corresponding LCU is LCU1. Table 6 shows which device numbers equate to which LCU's.

Determining the channel connection address (CCA) for RVA

The channel connection address (cca) on an RVA is relative to the LCU and is always between 00 and 3F. If the device numbers have been generated as a contiguous group of 256 addresses, the CCA can be calculated from the last two digits of the device number as shown in Table 6. For example, for device numbers AAC0 - AAFF subtract X'C0' from the last two digits of the device number and the corresponding CCA's are 00 - 3F.

Table 52. Determining LCU and CCA values for RVA

Device Number	LCU =	CCA =
00 - 3F	LCU00	00 - 3F
40 - 7F	LCU01	00 - 3F subtract X'40' from device number
80 - BF	LCU02	00 - 3F subtract X'80' from device number
C0 - FF	LCU03	00 - 3F subtract X'C0' from device number

When you are running PPRC on an RVA that supports 1024 addresses, you can determine the CCA by running the PPRCOPY QUERY (without the PATHS parameter) on the volume you will be using for the primary and also on the volume that you are using for the secondary. When run on each volume in simplex state, look in the Primary column for the information for the volume. You can then use the CCA value listed in this column for the PPRC commands.

Determining the System Adapter ID (SAID) value for RVA

The System Adapter ID (SAID) is determined by the cluster and the ESCON channel adapter numbers, as shown in Table 53

Table 53. Determining SAID values for RVA

Cluster/Channel Interface	SAID Values for RVA
0/Interface A	0000
0/Interface B	0001
0/Interface C	0020
0/Interface D	0021
0/Interface E	0040
0/Interface F	0041
0/Interface G	0060
0/Interface H	0061
1/Interface A	0010
1/Interface B	0011
1/Interface C	0030
1/Interface D	0031
1/Interface E	0050
1/Interface F	0051
1/Interface G	0070
1/Interface H	0071

Examples for using FAILOVER and FAILBACK

The following examples show how the parameters for FAILOVER and FAILBACK are used. For these examples, SITE-A is the original primary site, and SITE-B is the original secondary site, with the following devices at each site:

SITE-A	SITE-B
DEVICE ADDR= 4C80	DEVICE ADDR= 4E80
LSS= 01	LSS= 05
SSID= 2901	SSID= 8605
SERIAL= FCA29	SERIAL= FCA86
CCA= 00	CCA= 00

INITIAL ESTABLISH

The PPRC paths are established between SITE-A → SITE-B using the ESTPATH command.

The PPRC pair is established originally with the following parameters, making device 4C80 at SITE-A the primary:

```
PPRCOPY ESTPAIR UNIT(4C80) LSS(X'01',X'05') -
PRI(X'2901',FCA29,X'00') SEC(X'8605',FCA86,X'00') -
MODE(COPY)
```

SITE-A BECOMES UNAVAILABLE

When access to SITE-A becomes unavailable, the ESTPAIR command with the FAILOVER parameter is issued to the device 4E80 at SITE-B (at this time the current secondary), using the following command. After this command is issued, the 4E80 device at SITE-B becomes the new primary and becomes suspended.

```
PPRCOPY ESTPAIR UNIT(4E80) LSS(X'05',X'01') -
PRI(X'8605',FCA86,X'00') SEC(X'2901',FCA29,X'00') -
FAILOVER
```

SITE-A BECOMES AVAILABLE AGAIN

When access to SITE-A is available again, PPRC paths are established between SITE-B → SITE-A using the PPRC ESTPATH command (ESTPATH issued to the volume at SITE-B).

Then the ESTPAIR command with the FAILBACK parameter is issued to the 4E80 device at SITE-B (this is now the current suspended primary), using the following command. After this command is issued, the 4E80 device at SITE-B becomes the primary in active duplex.

```
PPRCOPY ESTPAIR UNIT(4E80) LSS(X'05',X'01') -
PRI(X'8605',FCA86,X'00') SEC(X'2901',FCA29,X'00') -
FAILBACK
```

TO REMOVE PATHS WHEN PAIRS ARE ESTABLISHED

The PPRC paths can be removed from SITE-B using the DELPATH FORCE as shown in the following command:

```
PPRCOPY DELPATH UNIT(4E80) LSS(X'05',X'01') -
PRI(X'8605',FCA86) SEC(X'2901',FCA29) -
FORCE
```

TO GO BACK TO SITE-A AS PRIMARY

When it is desired to return to the original SITE-A as primary and SITE-B as secondary, the FAILOVER and FAILBACK can be done in reverse. (It is not necessary to delete the pairs from SITE-B before establishing from SITE-A again).

- ESTPAIR with FAILOVER is issued to device 4C80 at SITE-A. After this command is issued, the 4C80 device at SITE-A becomes the new primary and becomes suspended.

```
PPRCOPY ESTPAIR UNIT(4C80) LSS(X'01',X'05') -
PRI(X'2901',FCA29,X'00') SEC(X'8605',FCA86,X'00') -
FAILOVER
```

- ESTPAIR with FAILBACK is issued to device 4C80 at SITE-A. After this command is issued, the 4C80 device at SITE-A becomes the primary in active duplex.

```
PPRCOPY ESTPAIR UNIT(4C80) LSS(X'01',X'05') -
PRI(X'2901',FCA29,X'00') SEC(X'8605',FCA86,X'00') -
FAILBACK
```

Chapter 20. REFORMAT command—CKD



The REFORMAT command updates:

- Portions of a previously initialized MVS or VSE volume
- A minidisk for a VSE or MVS guest operating system

After issuing INIT to initialize a volume, use REFORMAT to change the:

Volume serial number
Owner identification
IPL bootstrap
Program records
VTOC size

Only volumes that have been previously initialized can be reformatted.



Do not use REFORMAT to update volumes, which have been formatted with the CPVOLUME command for use in a VM environment. Use the CPVOLUME command instead.

The following REFORMAT parameters are supported for minidisks: BOOTSTRAP, EXTVTOC, IPLDD, NEWVTOC, OWNERID, PURGE, REFVTOC, VERIFY, VOLID, and UNITADDRESS. For more information, see Chapter 5, “Getting started with the CMS version.”

The REFORMAT command supports dual copy volumes, which are in duplex or suspended duplex state.

For information on ICKDSF support of the RAMAC® Array Family, see “ICKDSF support of the RAMAC Array family” on page 8.

Protecting the REFORMAT command with RACF

The MVS version of ICKDSF checks the general resource profile for a facility class profile of STGADMIN.ICK.REFORMAT. If RACF is not installed or the facility STGADMIN.ICK.REFORMAT is not created, the REFORMAT command executes with no authorization check. For additional information, see “Protecting ICKDSF commands with RACF” on page 35.

Syntax

The abbreviation for REFORMAT is RFMT.

REFORMAT

Required Parameters

DDNAME(<i>dname</i>) SYSNAME(<i>sysxxx</i>) UNITADDRESS(<i>ccuu</i>) VERIFY(<i>serial</i> *NONE*[<i>,owner</i>]) NOVERIFY

REFORMAT command—CKD

Optional Parameters

BOOTSTRAP|NOBOOTSTRAP
 EXTINDEX
 EXT|VTOC(*n*)|NEWVTOC(*cylinder,head,n*|ANY,*n*)
 IPLDD({*dname*|*sysin*}[*,OBJFORMAT*],ABSFORMAT)
 OWNERID(*owner*)
 PURGE|NOPURGE
 REFVTOC
 VOLID(*serial*)
 VTOCPTR(END|*cylinder,head*)

Required parameters

DDNAME|SYSNAME|UNITADDRESS parameter: identify the volume

Parameter/ Abbreviations	Description
DDNAME(<i>dname</i>) DNAME	<p>Required for an online MVS volume. Note that the volume must be online and mounted as PRIVATE. For <i>dname</i>, specify the MVS JCL statement that identifies the volume.</p> <p>Warning: During online REFORMAT processing, do not submit another job that will access the same volume.</p>
SYSNAME(<i>sysxxx</i>)	<p>Required for a VSE volume when executing ICKDSF in batch mode; the volume must be online. For <i>sysxxx</i>, specify the SYSNAME in the ASSGN system control statement.</p>
UNITADDRESS(<i>ccuu</i>) UNITADDR UNIT	<p>Required for an offline MVS volume, a Stand-Alone volume, and an attached CMS volume. For VSE, it is required when executing ICKDSF in command mode; the volume must be online.</p> <p>In MVS, the volume must be on a path that is online. If the volume is on a path that is offline, the program might enter a nonterminating wait state. For <i>ccuu</i>, specify the address (3 or 4 hexadecimal digits) of the channel and unit of the volume.</p> <p>For the CMS version, specify the virtual address of the dedicated volume or minidisk.</p> <p>The unit address is the device number.</p>
Default:	None.
Restrictions:	None.

VERIFY|NOVERIFY parameter: verify the volser and ownerid

Parameter/ Abbreviations	Description
VERIFY(<i>serial</i> [, <i>owner</i>]) VFY	<p>Required when you want to verify the volume serial number and owner identification before reformatting the volume or minidisk. If the volume serial number or owner identification does not match that found on the volume or minidisk, REFORMAT ends.</p> <p>For <i>serial</i>, substitute 1 to 6 alphanumeric characters for the volume serial number.</p> <p>For <i>owner</i>, substitute 1 to 14 alphanumeric characters for the owner identification.</p> <p>Running in the offline mode, if VERIFY(<i>serial</i>) parameter is specified in the REFORMAT command and PARM='NOREPLYU' is specified in the EXEC card in the JCL, no operator's intervention (Reply U or T) is required.</p>
NOVERIFY NOVFY NVFY	<p>Required when you want to bypass verification of the volume serial number.</p>
Default:	None.

Parameter/ Abbreviations	Description
Restrictions:	You cannot verify the owner identification separately from the volume serial number. Both the volume serial number and the owner identification must be verified when you want to verify the owner identification. When you specify the VERIFY parameter and verification fails, the command stops running.

Optional parameters

BOOTSTRAPINOBOTSTRAP parameter: write IPL records

Parameter/ Abbreviations	Description
BOOTSTRAP BOOT	Indicates that you are supplying the IPL bootstrap records that are written on the volume or minidisk during reformatting. These records must be the first four records in the IPL program text. The first text record must have IPL1 in the first four columns, followed by 24 bytes of data. These 24 bytes have the same format as the first IPL record described in “the description of the ABSFORMAT parameter” on page 260. The next three text records must have IPL2 in their first four columns, followed by 68 bytes of data each in the second and third records and 8 bytes of data in the last record. These 144 bytes of data have the same format as IPL record 2 described in “the description of the ABSFORMAT parameter” on page 260.
NOBOOTSTRAP NOBOOT NBOOT	Indicates that you want the system to supply the IPL bootstrap records that are written on the volume during reformatting.
Default:	NOBOOTSTRAP
Restrictions:	The BOOTSTRAPINOBOTSTRAP parameters apply only when the IPLDD parameter is specified. This parameter is ignored when the IPL program is supplied in absolute format. The BOOTSTRAPINOBOTSTRAP parameters are not valid for 3995-151 and 3995-153.

EXTINDEX parameter: extend index

Parameter/ Abbreviations	Description
EXTINDEX(n) XINDEX(n)	If an index exists when you expand the VTOC, it must be deleted and rebuilt to reflect the VTOC changes. This parameter is used to specify the total track size of the index to be rebuilt. For 'n', substitute the decimal or hexadecimal digits (for example, X'1E') to specify the total number of tracks for the new index after expansion. If the value for 'n' is less than the current value, the current value is used.
Default:	None.
Restrictions:	Valid only for MVS online volumes. Valid only when EXTVTOC is specified.

EXTVTOCINNEWVTOCIREFVTOC parameter: expand VTOC in current or new location

Parameter/ Abbreviations	Description
EXTVTOC(n) XVTOC	Expands the VTOC at its current location. For <i>n</i> , substitute the decimal or hexadecimal digits (for example, X'AB') to specify the total size in tracks of the new VTOC after expansion. The value for <i>n</i> must be greater than the size of the old VTOC.

REFORMAT command—CKD

Parameter/ Abbreviations	Description
NEWVTOC(<i>cylinder,head</i> ANY, <i>n</i>) NVTOC	<p>Moves and expands the VTOC into a new location.</p> <p>For <i>cylinder,head,n</i>, substitute the decimal or hexadecimal digits (for example, X'1A',X'0',X'3B') to specify the beginning location and size of the new VTOC. The beginning and ending locations must not be the same as the old VTOC and a single extent free space must be available for the new VTOC. The <i>n</i> will specify the total size in tracks of the new VTOC. The value for <i>n</i> must be greater than the size of the old VTOC.</p> <p>If ANY is specified, the new VTOC is placed on the first available free space extent that is large enough.</p>
REFVTOC RVTOC	Rebuilds the VTOC at its current location for the current track size. Use when you suspect there is a mismatch between your VTOC and VTOC INDEX, or between your VTOC or VTOC INDEX and a physical device.
Default: Restrictions:	<p>None.</p> <p>For MVS, the volume must be offline when you specify the NEWVTOC parameter.</p> <p>MVS</p> <p>If EXTVTOC is specified without the EXTINDEX parameter, and the volume is online to MVS in index format, ICKDSF will calculate the best index size to use, based on the size of the VTOC. The calculation that will be used is the same one that is used by the INIT command.</p> <p>REFVTOC Not valid with other VTOC parameters.</p> <p>If the VTOC is an indexed VTOC the index data set will be deleted. If the device is online to MVS, the index data set will be rebuilt.</p>

IPLDD parameter: write a user-supplied IPL program on the volume

Parameter/ Abbreviations	Description
IPLDD(<i>{dnamesysin}</i> [,OBJFORMAT ABSFORMAT])	
IPLDD IPL	Allows you to supply an IPL program to be written on the volume or minidisk during reformatting. For more detailed information, see "Writing an IPL program on the volume with IPLDD" on page 261.
OBJFORMAT OBJECT OBJ	<p>Specifies that IPL data is being supplied in object deck format; that is, cards will have one of the following strings of EBCDIC characters in columns 2 through 4:</p> <p>TXT RLD ESD END</p> <p>Note that only cards with TXT will be processed. All others will be ignored.</p>
ABSFORMAT ABSOLUTE ABS	Specifies that IPL data is being supplied as variable-length records that contain executable instructions. For more detailed information, see "Supplying variable-length records as IPL data" on page 261.
Default: Restrictions:	<p>OBJFORMAT</p> <p>The system provides special IPL bootstrap records if you specify the IPLDD parameter without specifying the BOOTSTRAP parameter.</p> <p>When an IPL program is included in the SYSIN stream, it must immediately follow the INIT command and end with an ENDIPLTEXT card. The ENDIPLTEXT card is optional when the IPL program is in a data set other than the one specified by SYSIN, or when the end-of-file indicator (/*) immediately follows the data for the IPL program.</p> <p>The IPLDD parameter is not valid for 3995-151 and 3995-153.</p> <p>IPLDD is not valid in the VSE environment.</p>

Writing an IPL program on the volume with IPLDD

The following is an explanation of the results you can expect from the IPLDD and BOOTSTRAP parameters:

- If you specify IPLDD but do not specify BOOTSTRAP, ICKDSF supplies an IPL bootstrap that is written on the volume or minidisk during initialization together with the IPL text you supply.
- If you specify IPLDD and BOOTSTRAP, ICKDSF uses the IPL bootstrap and the IPL text you supply. If necessary, ICKDSF updates the bootstrap records to allow for possible user labels.

Note: If you do not specify IPLDD, the existing bootstrap records remain unchanged. The BOOTSTRAP parameter cannot be specified without the IPLDD parameter.

The maximum size permitted for the IPL program record depends upon the type of volume being initialized. The maximum sizes allowed are:

Table 54. Maximum size for IPL program record

Volume Type	Maximum Bytes for IPL Program
3375	33 984
3380	44 948
3390 (3380 mode)	44 948
3390	53 450
9345	49 938

Also, the number of additional user volume labels can further limit the size allowed for the IPL program. If you supply an IPL program that exceeds the size allowed, you receive an error message but reformatting continues.



On the MVS version, use *dname*. For *dname*, substitute 1 to 8 alphanumeric characters for the DD statement identifying the data set that contains the IPL program you want written on the volume (or minidisk) being reformatted. The IPL program can be included within the MVS JCL input stream (SYSIN). If the IPL program is in the MVS JCL input stream, the data must be included immediately after the REFORMAT command.



You must specify SYSIN. It must be the same device as the input device. The data must immediately follow the REFORMAT command and end with an ENDIPLTEXT card. In a VM environment, the IPLDD data must be contiguous to the REFORMAT command.

Supplying variable-length records as IPL data

ABSFORMAT specifies that IPL data is being supplied as variable-length records that contain executable instructions. When IPL data is supplied in this format, it is necessary to provide a minimum of three records. The maximum number of records supplied and their lengths are limited only by the track capacity of the volume or minidisk on which these records are to be written.

The first two records supplied must be the bootstrap records and are restricted to lengths of 24 and 144 bytes, respectively.

The contents of the IPL records and the contents of the program are not checked by ICKDSF. It is the user's responsibility to ensure that the IPL records can load an

REFORMAT command—CKD

executable program. The first IPL record must contain a PSW followed by two CCWs (channel command words). The following is an example of CCWs in an IPL record:

```
First CCW    06xxxxxx 60000090
Second CCW   08xxxxxx 00000000
```

The first CCW is a command to read in the second IPL record at main storage address xxxxxx. The second CCW is a transfer-in-channel command (a branch) to the CCW that begins the second IPL record.

The second IPL record must be 144 bytes long. Bytes 32 through 42 (starting from byte 0) cannot be used. Bytes 32 through 42 are used by ICKDSF for the seek address (bytes 32 through 37) and the CCHHR (bytes 38 through 42) of the third IPL record.

The third through nth records that are supplied are assumed to be IPL program records and will be written on the volume, without any modification, after the standard volume label and any existing user volume labels. Note that the IPL program will be written only on the first track of the pack. If the length of the records supplied exceeds the remaining space on the first track, the function will end with an error message.

OWNERID parameter: specify a new volume-owner identification

Parameter/ Abbreviations	Description
OWNERID(<i>owner</i>) OWNER	Writes a new volume-owner identification in the volume or minidisk label. For <i>owner</i> , substitute 1 to 14 alphanumeric characters to change the owner identification written in the volume or minidisk label.
Default:	If you do not specify a new owner identification when reformatting a volume or minidisk, the old owner identification remains unchanged.
Restrictions:	None.

PURGEINOPURGE parameter: rewrite user volume labels

Parameter/ Abbreviations	Description
PURGE PRG	Indicates that you want to write over existing volume labels during reformatting.
NOPURGE NOPRG NPRG	Indicates that you do not want to write over any user volume labels. If a volume or minidisk contains user volume labels and the IPLDD parameter is specified, the IPL program record is written following the last user volume label.
Default:	NOPURGE
Restrictions:	PURGE applies only when IPLDD is specified.

VOLID parameter: specify a new volume serial number

Parameter/ Abbreviations	Description
VOLID(<i>serial</i>)	Writes a new volume serial number in the volume or minidisk label. For <i>serial</i> , substitute 1 to 6 alphanumeric characters for the volume serial number. If fewer than six characters are specified, the serial is left-justified, and the remainder of the field is padded with blanks (X'40').
Default:	When you reformat a volume or minidisk and do not specify the VOLID parameter, the old volume serial number remains unchanged.

Parameter/ Abbreviations	Description
Restrictions:	<p>Any catalog that identifies the volume by its volume serial number must be changed to reflect the new volume serial number for any cataloged data sets that reside on the reformatted volume.</p> <p>No check is made to determine if the volume contains an indexed VTOC. If an indexed VTOC exists on the volume, the data set name of the index remains unmodified. (That is, the index may be named SYS1.IXVTOC.VOL001 but the new volume label is VOL002.) This does not cause any functional problems, but may have an impact on the uniqueness of indexed VTOC data set names.</p> <p>You cannot change the volume serial number of an online MVS volume. You must vary the volume offline to change the volume serial number.</p>

VTOCPTR parameter: restore a destroyed volume serial

Parameter/ Abbreviations	Description
VTOCPTR(ENI <i>cylinder,head</i>)	<p>Restores the destroyed volume serial (<i>volser</i>) of a previously initialized volume (or minidisk).</p> <p>Use <i>cylinder,head</i> to specify the original location of the VTOC on the volume. Specify decimal (n) or hexadecimal numbers (for example, X'AB',X'E') to identify the cylinder and head.</p> <p>When you specify VTOCPTR(ENI), the original VTOC is assumed to have been located on the last primary cylinder of the volume or minidisk.</p>
Default:	None.
Restrictions:	<p>When you specify VTOCPTR, all of the following must be true:</p> <p>The device must be a CKD device.</p> <p>NOVERIFY, VOLID, and PURGE must be specified.</p> <p>There must be no <i>volser</i> on the volume (the key field and the first four bytes of the data field of VOL1 record are not "VOL1").</p> <p>MVS In the MVS environment, the device must be offline.</p> <p>If any of these conditions are not true, the restore function ends.</p> <p>REFORMAT checks the existence of a format-4 DSCB at the location you specify by examining the key field and the first four bytes of the data field. After the restore function is completed, the IPL1 and IPL2 records are rewritten and the existing records beyond the <i>volser</i> (if any) are erased. If the IPL record is required, you can specify the IPLDD parameter.</p> <p>MVS</p> <p>RACF volume access authority checking is bypassed in the MVS environment.</p>

Examples of the REFORMAT command

The following examples show different ways to code the REFORMAT command in offline and online mode (MVS), and for the VSE and CMS versions of ICKDSF.

Any values specified here are examples only and should not necessarily be interpreted as the values for your system.



To reformat a volume in the CMS or Stand-Alone version:

1. Eliminate the MVS JCL.
2. Substitute the UNITADDRESS parameter for the DDNAME parameter.
3. Specify the DEVICETYPE parameter if the MIMIC(EMU) or MIMIC(MINI) parameter is also specified.
4. Substitute SYSIN for *dname* in the IPLDD parameter.

Reformatting volumes with the MVS version



The following examples show you how to reformat volumes with the MVS version of ICKDSF.

Changing the volume serial number in offline mode

In this example, the volume serial number is being changed. Any catalogs that identify the volume by its old volume serial number must be modified. The VERIFY parameter is specified to ensure that the correct volume is being accessed before the volume serial number is changed.

```
//EXAMPLE JOB
//      EXEC  PGM=ICKDSF
//SYSPRINT DD  SYSOUT=A
//SYSIN  DD   *
REFORMAT UNITADDRESS(0353) VERIFY(OLDVOL) -
VOLID(NEWVOL)
/*
```

Adding an IPL program in online mode

In this example, an IPL program is added to the volume, and the owner identification is changed. Volume VOL123 was previously mounted as PRIVATE. If any user volume labels exist on the volume, the IPL program is written over them because the PURGE parameter is specified. ICKDSF will supply the appropriate IPL bootstrap records.

If IPL text already exists on the volume, the operator will be prompted to specify whether or not to continue processing.

```
//EXAMPLE JOB
//      EXEC  PGM=ICKDSF
//IPLDECK DD  *
:
:
//VOLUMEL DD  UNIT=3390,DISP=OLD,VOL=SER=VOL123
//SYSPRINT DD  SYSOUT=A
//SYSIN  DD   *
REFORMAT DDNAME(VOLUMEL) IPLDD(IPLDECK) -
OWNERID(BROWN) PURGE NOVERIFY
/*
```

Adding IPL text from another volume

In this example, IPL text is copied from one volume to another. The target volume's label is TARGET and its volume address is XXX. The source volume's label is SOURCE, and the IPL text is in the library SYS1.SAMPLIB.

If IPL text already exists on the volume, the operator will be prompted to specify whether or not to continue processing.

Note: Check your Program Directory for your operating system for specific examples for your operating environment.

```
//IPLTEXT JOB <job parameters>
//*MESSAGE PLEASE AUTHORIZE IPLTEXT UPDATE FOR volser(JES2 user)
//*OPERATOR PLEASE AUTHORIZE IPLTEXT UPDATE FOR volser(JES3 user)
//STP1 EXEC PGM=ICKDSF,REGION=0M
//SYSPRINT DD SYSOUT=*
//IVOL DD VOL=SER=volser,UNIT=SYSALLDA,DISP=SHR
//SAMPLIB DD DSN=SYS1.SAMPLIB(IPLRECS),DISP=SHR,UNIT=SYSALLDA,
//          VOL=SER=vvvvvv
//          DD DSN=SYS1.SAMPLIB(IEAIPL00),DISP=SHR,UNIT=SYSALLDA,
```



```
//          VOL=SER=vvvvvv
//SYSIN DD *
  REFORMAT DDNAME(IVOL) VERIFY(volser) IPLDD(SAMPLIB,OBJ) -
  BOOTSTRAP
/*
```

Notes:

1. Update the job parameters.
2. Replace vvvvvv with the volser of your volume.
3. Replace volser with the volser of your IPL volume.

Expanding the VTOC and the index

The following is an example of expanding the VTOC and the Index using the EXTVTOC and EXTINDEX parameters.

```
//EXAMPLE JOB
//          EXEC PGM=ICKDSF
//VOLDD DD DISP=SHR,UNIT=3380,VOL=SER=TMP121
//SYSPRINT DD SYSOUT=A
//SYSIN DD *
  REFORMAT DDNAME(VOLDD) VERIFY(TMP121) EXTVTOC(200) EXTINDEX(16)
/*
```

An example of the ICKDSF output from the above job is as follows:

```
ICK00700I DEVICE INFORMATION FOR 0B00 IS CURRENTLY AS FOLLOWS:
          PHYSICAL DEVICE = 3380
          STORAGE CONTROLLER = 3990
          STORAGE CONTROL DESCRIPTOR = EC
          DEVICE DESCRIPTOR = 1E
ICK04000I DEVICE IS IN SIMPLEX STATE
ICK01520I THE VTOC-INDEX WAS DELETED
ICK01314I VTOC IS LOCATED AT CCHH=X'0000 0001' AND IS 200 TRACKS.
ICK01502I BUILDIX FUNCTION STARTED
ICK01503I 0B00 REQUEST RECEIVED TO CONVERT VTOC TO IXFORMAT
ICK01504I 0B00 VTOC FORMAT IS CURRENTLY OSFORMAT, REQUEST ACCEPTED
ICK01508A 0B00 SHOULD CONVERSION PROCEED? REPLY U TO CONTINUE, ELSE T
ICK01513I 0B00 BUILDIX PROCESSING COMPLETED: VTOC IS NOW IN IXFORMAT
ICK00001I FUNCTION COMPLETED, HIGHEST CONDITION CODE WAS 0
```

Refreshing the VTOC and index

Use the REFVTOC parameter to rebuild the VTOC in its current location, using the same track size. The Fmt4 DSCB is rebuilt to reflect the real device capacity. The Fmt5 and Fmt7 free space chains are set to zero, so that they may be updated with the correct values upon first allocation. If the VTOC is an indexed VTOC the index data set will be deleted. If the device is online to MVS, the index data set will be rebuilt to reflect the VTOC changes.

The following is an example of refreshing the VTOC and the Index on an online MVS volume, using the REFVTOC parameter:

```
//EXAMPLE JOB
//          EXEC PGM=ICKDSF
//VOLDD DD DISP=SHR,UNIT=3380,VOL=SER=TMP121
//SYSPRINT DD SYSOUT=A
//SYSIN DD *
  REFORMAT DDNAME(VOLDD) VERIFY(TMP121) REFVTOC
/*
```

An example of the ICKDSF output from the above job:

```
ICK00700I DEVICE INFORMATION FOR 0B00 IS CURRENTLY AS FOLLOWS:
          PHYSICAL DEVICE = 3380
          STORAGE CONTROLLER = 3990
```

REFORMAT command—CKD

```
STORAGE CONTROL DESCRIPTOR = EC
DEVICE DESCRIPTOR = 1E
ICK04000I DEVICE IS IN SIMPLEX STATE
ICK01520I THE VTOC-INDEX WAS DELETED
ICK01314I VTOC IS LOCATED AT CHH=X'0000 0001' AND IS 200 TRACKS.
ICK01502I BUILDIX FUNCTION STARTED
ICK01503I 0B00 REQUEST RECEIVED TO CONVERT VTOC TO IXFORMAT
ICK01504I 0B00 VTOC FORMAT IS CURRENTLY OSFORMAT, REQUEST ACCEPTED
ICK01508A 0B00 SHOULD CONVERSION PROCEED? REPLY U TO CONTINUE, ELSE T
ICK01513I 0B00 BUILDIX PROCESSING COMPLETED: VTOC IS NOW IN IXFORMAT
ICK00001I FUNCTION COMPLETED, HIGHEST CONDITION CODE WAS 0
```

The following is an example of JCL which can be used to refresh an OSVTOC and rebuild the Fmt5 and Fmt7 free space chains on an online MVS volume, using the REFVTOC parameter. The dummy allocation will cause the Fmt5 and Fmt7 free space chains to be rebuilt.

```
//EXAMPLE JOB
//
//          EXEC PGM=ICKDSF
//VOLDD    DD DISP=SHR,UNIT=3390,VOL=SER=TESTIT
//SYSPRINT DD SYSOUT=A
//SYSIN    DD *
REFORMAT DDNAME(VOLDD) VERIFY(TESTIT) REFVTOC
//ALLOC    EXEC PGM=IEFBR14
//SYSPRINT DD SYSOUT=A
//DD2      DD DSN=TESTIT,UNIT=SYSDA,DISP=(,DELETE),
//          VOL=SER=TESTIT,SPACE=(CYL,(0,0)),CONTIG)
/*
```

Using the REFORMAT command with the CMS version



The following examples show you how to use the REFORMAT command in the CMS version of ICKDSF.

Updating a minidisk in the CMS version

In this example, the volume serial number of an MVS minidisk at virtual address 291 is being changed from OLDVOL to NEWVOL and the owner identification from PAYROLL to NEWPAY. The VERIFY parameter is specified to ensure that the correct volume is being accessed before the volume serial and owner ID are changed.

```
REFORMAT UNITADDRESS(0291) VERIFY(OLDVOL,PAYROLL) -
          VOLID(NEWVOL) OWNERID(NEWPAY)
```

Adding IPL text to an MVS volume using the CMS version

In this example, ICKDSF is invoked using a CMS input file, and IPL text is added to an MVS volume. The IPL text is included in the input file after the REFORMAT command line:

```
REFORMAT UNITADDRESS(A01) VERIFY(MVSRES) IPLDD(SYSIN)
. . .
IPL text
. . .
```

The CMS input file name is IPLTEXT INPUT A. ICKDSF is invoked with the following command and output goes to the console.

```
ICKDSF IPLTEXT INPUT A CONSOLE
```

Changing the volume serial number in the VSE version

VSE

In this example, the volume serial number is verified and a new volume serial number is assigned.

```
// JOB      jobname
// ASSGN    SYS010,151
// EXEC     ICKDSF,SIZE=AUTO
          REFORMAT SYSNAME(SYS010) VERIFY(OLDVOL) VOLID(NEWVOL)
/*
/ &
```

REFORMAT command—CKD

Chapter 21. REVAL command—CKD



Use the REVAL command when some form of rewriting is necessary on all or part of a volume.

REVAL (DATA or NODATA) can perform the following combination of functions on 3380 and 3390 devices:

- A drive test
- Rewrite home address and record 0
- Data verification of the FFVDP
- Surface checking on tracks if required

When you are reinitializing a 3380 or 3390 volume, use REVAL DATA with the VERIFY parameter to ensure you are reinitializing the volume you want or to revalidate the volume's home address and record 0.

This command is valid on IBM 3380 and 3390 volumes only. For 9345 devices, use INSTALL. REVAL does not support dual copy volumes, 9394, or Internal Disk devices.

The REVAL command is not recommended for use on the 9391 and is not supported on 2105 devices.



When you are using the CMS version of ICKDSF, REVAL is valid only with dedicated devices. For more information, see Chapter 5, "Getting started with the CMS version."

Warning

REVAL DATA or NODATA processing will destroy the volser, the VTOC pointer and all of the data in the range specified, so that no data on the volume will be accessible.

FIXSIM provides a nondisruptive method of repairing the cause of specific '4E4E' SIMs that would normally require you to move your data to another device and make this device available for service.

REVAL REFRESH is an enhanced process that provides the capability to rewrite user data.

Do not use the REVAL command as an alternative when media maintenance actions are required for the device. For more information on media maintenance, see:

- "Problem determination" on page 78.
- *Maintaining IBM Storage Subsystem Media*, GC26-4495.

For more information on using ANALYZE or INSPECT to perform media maintenance, see the chapters with their command descriptions.

For information on ICKDSF support of the 9391 and 9394, see "ICKDSF support of the RAMAC Array family" on page 8.

Protecting the REVAL command with RACF

The MVS version of ICKDSF checks the general resource profile for a facility class profile of STGADMIN.ICK.REVAL. If RACF is not installed or the facility STGADMIN.ICK.REVAL is not created, the REVAL command executes with no authorization check. For additional information, see “Protecting ICKDSF commands with RACF” on page 35.

Syntax

REVAL
Required Parameters DDNAME(<i>dname</i>) SYSNAME(<i>sysxxx</i>) UNITADDRESS(<i>ccuu</i>) VERIFY(<i>serial</i> *NONE*[<i>,owner</i>]) NOVERIFY
Optional Parameters CYLRANGE(<i>start,end</i>) DATAINODATA FIXSIM(4E4E) REFRESH HEADRANGE(<i>start,end</i>)

Required parameters

SYSNAME|UNITADDRESS parameter: identify the volume

Parameter/ Abbreviations	Description
DDNAME(<i>dname</i>)	Required for an online MVS volume. The volume must be mounted as PRIVATE. For <i>dname</i> specify the MVS JCL statement that identifies the volume.
SYSNAME(<i>sysxxx</i>)	Required for a VSE volume when executing ICKDSF in batch mode; the volume must be online. For <i>sysxxx</i> , specify the SYSNAME in the ASSGN control statement.
UNITADDRESS(<i>ccuu</i>) UNITADDR UNIT	<p>Required for an offline MVS volume, a Stand-Alone volume, and an attached CMS volume. For VSE, it is required when executing ICKDSF in command mode; the volume must be online.</p> <p>In MVS, the volume must be on a path that is online. If the volume is on a path that is offline, the program might enter a nonterminating wait state. For <i>ccuu</i>, specify the address in hexadecimal (3 or 4 digits) of the channel and unit for the volume.</p> <p>For the CMS version specify the virtual address of the dedicated volume.</p> <p>The unit address is the device number.</p>
Default:	None.
Restrictions:	DDNAME is valid only when FIXSIM(4E4E) or REFRESH is specified.

VERIFY/NOVERIFY parameter: verify the volser and ownerid

Parameter/ Abbreviations	Description
VERIFY(<i>serial</i> [, <i>owner</i>]) VFY	<p>Required when you want to verify the volume serial number and owner identification before processing the volume or minidisk. If the volume serial number or owner identification does not match that found on the volume or minidisk, REVAL ends.</p> <p>For <i>serial</i>, substitute 1 to 6 alphanumeric characters for the volume serial number.</p> <p>To verify that a volume serial number does not exist, substitute the string *NONE* for <i>serial</i>. If no volume serial exists, or if the volume serial is actually “*NONE*”, the REVAL operation continues. If a volume serial exists, the REVAL command ends.</p> <p>For <i>owner</i>, substitute 1 to 14 alphanumeric characters for the owner identification.</p> <p>Running in the offline mode, if VERIFY(<i>serial</i>) parameter is specified in the REVAL command and PARM='NOREPLYU' is specified in the EXEC card in the JCL, no operator's intervention (Reply U or T) is required.</p>
NOVERIFY NOVFY NVFY	Required when you want to bypass verification of the volume serial number.
Default:	None.
Restrictions:	<p>You cannot verify the owner identification separately from the volume serial number. Both the volume serial number and the owner identification must be verified when you want to verify the owner identification.</p> <p>When you specify the VERIFY parameter and verification fails, the command stops running.</p>

Optional parameters**CYLRange parameter: specify a range of cylinders**

Parameter/ Abbreviations	Description
CYLRange(<i>start</i> , <i>end</i>) CYLR CYL	<p>Used to specify what part of a volume is to be surface checked. Use the CYLRange parameter to specify the starting and ending cylinders.</p> <p>For <i>start</i>,<i>end</i>, substitute decimal (n) or hexadecimal digits (for example, X'AB',X'DE') to identify the starting and ending cylinders to be examined.</p> <p>If you specify CYLRange and do not specify HEADRange, all the heads of the specified cylinders are processed.</p> <p>For information on specifying the starting and ending heads (HEADRange) to go with the starting and ending cylinders, see “HEADRange parameter: specify a range of heads” on page 272.</p> <p>For information on specifying part of a volume, see “Range parameters: specifying part of a volume” on page 154.</p>
Default:	None.
Restrictions:	Only the starting value is required for CYLRange. If the user does not specify an ending value, the last cylinder is used as the ending value. By specifying an ending value greater than the maximum for the device, processing is performed to the maximum value for that device.

DATA|NODATA|FIXSIM|REFRESH parameter: rewrite home address and record Zero or user data

Parameter/ Abbreviations	Description
DATA	Writes the FFVDP on the specified tracks during the validate process for the IBM 3380 and 3390 devices.
NODATA	Indicates that you do not want to write the FFVDP on the volume.
FIXSIM(4E4E)	Provides a nondisruptive method of repairing the cause of specific '4E4E' SIMs that would normally require you to move your data to another device and make this device available for service. User data is rewritten for the range specified on the HEADRANGE parameter. The volume can be online running in concurrent mode or offline.
REFRESH	REVAL REFRESH is an enhanced process that provides the capability to rewrite user data. User data is rewritten for the range specified on the HEADRANGE parameter. This can be either done offline or online in concurrent mode.
Default: Restrictions:	<p>DATA</p> <p>FIXSIM(4E4E)</p> <ul style="list-style-type: none"> • Caution: Follow the checking procedure to determine if the device is a candidate of REVAL FIXSIM. • Is valid only for the 3390-1 and 3390-2. • If the previous FIXSIM(4E4E) did not complete, you must vary the device offline and reissue the REVAL FIXSIM (4E4E) command with a small range to recover it. <p>REFRESH</p> <ul style="list-style-type: none"> • Is valid only for the 3390-3. • If the previous REFRESH did not complete, you must vary the device offline and reissue the REVAL REFRESH command with a small range to recover it.

HEADRANGE parameter: specify a range of heads

Parameter/ Abbreviations	Description
HEADRANGE(<i>start,end</i>) HDRANGE HEADR HDR HD	<p>Use the HEADRANGE parameter to specify the part of a volume you want surface checked.</p> <p>For <i>start,end</i> substitute decimal (n) or hexadecimal digits (for example, X'B',X'E') to identify the starting and ending heads to be examined. If you specify only one value, ICKDSF takes the value to be the starting range and defaults the ending range to the device maximum.</p> <p>If you specify HEADRANGE and do not specify CYLRANGE, the specified heads for all the cylinders on a volume are processed.</p> <p>For information on specifying the starting and ending cylinders (CYLRANGE) to go with the starting and ending heads, see "CYLRANGE parameter: specify a range of cylinders" on page 271.</p> <p>For information on specifying part of a volume, see "RANGE parameters: specifying part of a volume" on page 154.</p>
Default: Restrictions:	<p>None.</p> <p>The starting value is required for HEADRANGE. If you specify an ending value greater than the maximum for the device, the device maximum is used for the ending value.</p>

Formatting tracks and reassigning alternate tracks

At the completion of the REVAL DATA, or NODATA process, all tracks in the specified range are initialized for use by IBM operating systems. Nonfactory alternate tracks are reset and reassigned if necessary. **However, the volume label, VTOC pointer, and all user data are destroyed.**

Follow REVAL with the command that formats the volume for your operating system. Use:

- The INIT command for MVS or VSE.
- The CPVOLUME command for VM. Use the FORMAT/ALLOCATE cylinder 0 for the entire volume.
- The AIXVOL command for AIX.

See the appropriate command chapters for more information on formatting your volumes.

Repairing the cause of specific '4E4E' SIMS

The FIXSIM(4E4E) parameter provides an enhanced process intended for use on specific 3390 Models 1 and 2 "4E4E" SIMS.

REVAL FIXSIM(4E4E) can be run on a single head or a range of heads. It can alleviate the situation that caused the SIM without affecting existing data on the volume. It will operate either offline, or online in concurrent mode.

The criteria for REVAL FIXSIM(4E4E) are:

1. The device type that surfaced the SIM is a 3390 Model 1/2 ONLY.
2. The SIM that has surfaced is 4E4E-80xx-xxx2, **OR**

The SIM that has surfaced is 4E4E-xxxx-xxx9 AND your service representative has validated that REVAL FIXSIM(4E4E) is applicable for this device.

Any device that does not meet criteria 1 and 2 should be handled using normal maintenance action(s). If criteria 1 and 2 are satisfied, proceed to next step.

3. Run ANALYZE SCAN NODRIVE on the entire volume that surfaced the 4E4E" SIM.

If the ending CONDITION CODE from ANALYZE SCAN NODRIVE is 0 (CC=0), **OR**

If the ending CONDITION CODE is 4 (CC=4), and there are NO "4XCX" ESCs indicated in ANALYZE SCAN NODRIVE output, the device qualifies for REVAL FIXSIM(4E4E).

Run REVAL FIXSIM(4E4E) on this device using the head number indicated in the SIM sense record (byte 31).

Any device that does not meet this criteria should be handled using normal maintenance action(s).

Recommendation

If the device is active and running in concurrent mode:

- The NOSPEED parameter must be added to the ANALYZE SCAN NODRIVE command to avoid the impact to other applications.
- IODELAY can be used before REVAL is issued to avoid performance impact to other applications. IODELAY should be reset when the REVAL command completes.

If the device is running in Stand-Alone mode, the SPEED parameter should be added to the ANALYZE SCAN NODRIVE command to improve the performance of the scanning process.

The REVAL command does not run on devices that are part of a dual copy pair. The dual copy pair should be terminated before REVAL FIXSIM(4E4E).

Resuming after a job or system failure

Let REVAL run to completion. If processing is interrupted, restart the command, otherwise the device may be left in an unusable state. Subsequent invocation of ICKDSF commands on behalf of the device will detect this condition and either ask or force you to enter a REVAL command to return the device to its proper condition.

Examples of the REVAL command

The following examples show how to code the REVAL command.

Any values specified here are examples only and should not necessarily be interpreted as the values for your system.

Running REVAL with FIXSIM



In this example REVAL processes head 4 beginning at cylinder 0 and continues to the last cylinder.

```
REVAL UNITADDR(ccuu) NVFY FIXSIM(4E4E) HEADRANGE(4,4)
```

VSE To run the above example with the VSE version:

```
// JOB      REVAL
// LIBDEF  PHASE,SEARCH=(IJSYSRS.SYSLIB)
// OPTION  NODUMP
// ASSGN   SYS010,AAF
// EXEC    ICKDSF,SIZE=AUTO
REVAL SYSNAME(SYS010) NVFY -
      FIXSIM(4E4E) HEADRANGE(4,4)
/*
/ &
```

Reinitializing a volume

MVS In this example, a volume is reinitialized by the REVAL command.

Warning

After REVAL runs, the volume is not formatted for the MVS environment. The contents of the volume are destroyed. In this example, INIT is issued after REVAL to format the volume.

```
//EXAMPLE  JOB
//          EXEC  PGM=ICKDSF
//SYSPRINT DD  SYSOUT=A
//SYSIN    DD   *
REVAL UNITADDRESS(0353) VERIFY(VOL123,PAYROLL)
      IF LASTCC<8 -
      THEN INIT UNIT(0353) NOVERIFY VOLID(ABCD4)
/*
```

Chapter 22. TRKFMT command—CKD



The TRKFMT command performs track-related functions on a subset of a volume.

When data is no longer needed, the ERASEDATA parameter overwrites a specified track or range of tracks, and upon completion performs an erase.

The TRKFMT command can be used for 2105, 3380, 3390 and 9345 devices (except for devices attached to 3880 control units, and 3990-CJ2).

The TRKFMT command does not support the 3995-151 and 3995-153 devices.

Warning

TRKFMT ERASEDATA processing will destroy data on the tracks specified.

Protecting the TRKFMT command with RACF

The MVS version of ICKDSF checks the general resource profile for a facility class profile of STGADMIN.ICK.TRKFMT. If RACF is not installed or the facility STGADMIN.ICK.TRKFMT is not created, the TRKFMT command executes with no authorization check. For additional information, see “Protecting ICKDSF commands with RACF” on page 35.

Syntax

TRKFMT
Required Parameters DDNAME(<i>dname</i>) SYSNAME(<i>sysxxx</i>) UNITADDRESS(<i>ccuu</i>) VERIFY(<i>serial</i> *NONE*[<i>owner</i>]) NOVERIFY ERASEDATA TRACKS((<i>cylinder,head</i>)[<i>,...</i>]) CYLRANGE(<i>start,end</i>) HEADRANGE(<i>start,end</i>) FROMRANGE(<i>cylinder,head</i>) TORANGE(<i>cylinder,head</i>)
Optional Parameters CYCLES(<i>n</i>) PASSWORDS((<i>dname/password</i>),...) TOLERATE(ENQFAIL)

Required parameters

CYLRANGE parameter: specify a range of cylinders

Parameter/ Abbreviations	Description
CYLRANGE(<i>start,end</i>) CYLR CYL	<p>Used to specify what part of a volume or minidisk is to be processed. Use the CYLRANGE parameter to specify the starting and ending cylinders.</p> <p>For <i>start,end</i>, substitute decimal (n) or hexadecimal digits (for example, X'1AB',X'2DE') to identify the starting and ending cylinders to be processed.</p> <p>If you specify CYLRANGE and do not specify HEADRANGE, all the heads of the specified cylinders are processed.</p> <p>For information on specifying the starting and ending heads (HEADRANGE) to go with the starting and ending cylinders, see “HEADRANGE parameter: specify a range of heads” on page 277.</p> <p>For information on specifying part of a volume or minidisk, see “RANGE parameters: part of a volume” on page 280.</p>
Default:	None.
Restrictions:	<p>Both the starting and ending values are required for CYLRANGE. By specifying an ending value greater than the last primary cylinder for the device, processing is performed to the last primary cylinder for the device.</p> <p>CYLRANGE cannot be specified with FROMRANGEITORANGE or TRACKS.</p>

DDNAME|SYSNAME|UNITADDRESS parameter: identify volume (or minidisk)

Parameter/ Abbreviations	Description
DDNAME(<i>dname</i>) DNAME	Required for an online MVS volume. Note that the volume must be online. For <i>dname</i> , specify the MVS JCL statement that identifies the volume.
SYSNAME(<i>sysxxx</i>)	Required for a VSE volume when executing ICKDSF in batch mode; the volume must be online. For <i>sysxxx</i> , specify the SYSNAME in the ASSGN system control statement.
UNITADDRESS(<i>ccuu</i>) UNITADDR UNIT	<p>Required for an offline MVS volume, a Stand-Alone volume, and an attached CMS volume. For VSE, it is required when executing ICKDSF in command mode; the volume must be online.</p> <p>In MVS, the volume must be on a path that is online. If the volume is on a path that is offline, the program might enter a nonterminating wait state. For <i>ccuu</i>, specify the address (3 or 4 hexadecimal digits) of the channel and unit of the volume.</p> <p>For the CMS version, specify the virtual address of the dedicated volume or minidisk.</p> <p>The unit address is the device number.</p>
Default:	None.
Restrictions:	None.

ERASEDATA parameter: ERASE a track

Parameter/ Abbreviations	Description
ERASEDATA ERASE	<p>Specifies each track to be overwritten. Each track will be overwritten with a set of special patterns. Upon completion of the overwrites, the track will be erased, leaving only the home address and record 0 on the track.</p> <p>Only the tracks specified will be erased.</p> <p>The CYCLES(n) parameter can be specified with ERASEDATA to write the set of patterns multiple times.</p>
Default:	None.
Restrictions:	None.

FROMRANGE parameter: specify a specific starting location

Parameter/ Abbreviations	Description
FROMRANGE(<i>cylinder,head</i>) FROMR FROM	<p>Use this parameter to specify the starting track (cylinder and head) to be processed.</p> <p>For <i>cylinder,head</i> substitute decimal (n) or hexadecimal digits (for example, X'2AB',X'A') to identify the cylinder and head at which processing is to start. If you specify only one value, ICKDSF takes it to be the cylinder and the head value is defaulted to 0.</p> <p>If you specify FROMRANGE and do not specify TORANGE, TORANGE is defaulted to the last primary cylinder of a volume or minidisk.</p> <p>For information on specifying the ending track (TORANGE) to go with the starting track, see "TORANGE parameter: specify a specific ending location" on page 278.</p> <p>For information on specifying part of a volume to be examined, see "RANGE parameters: part of a volume" on page 280.</p>
Default:	None.
Restrictions:	FROMRANGE and CYLRANGEIHEADRANGE are mutually exclusive.

HEADRANGE parameter: specify a range of heads

Parameter/ Abbreviations	Description
HEADRANGE(<i>start,end</i>) HDRANGE HEADR HDR HD	<p>Use the HEADRANGE parameter to specify the starting and ending heads to be processed.</p> <p>For <i>start,end</i> substitute decimal (n) or hexadecimal digits (for example, X'B',X'E') to identify the starting and ending heads to be processed. If you specify only one value, ICKDSF takes the value to be the starting range and defaults the ending range to the device maximum.</p> <p>If you specify HEADRANGE and do not specify CYLRANGE, the specified heads for all the cylinders on a volume or minidisk are processed.</p> <p>For information on specifying the starting and ending cylinders (CYLRANGE) to go with the starting and ending heads, see "CYLRANGE parameter: specify a range of cylinders" on page 276.</p> <p>For information on specifying part of a volume, see "RANGE parameters: part of a volume" on page 280.</p>
Default:	None.

TRKFMT command—CKD

Parameter/ Abbreviations	Description
Restrictions:	<p>Both the starting and ending values are required for HEADRANGE. If you specify an ending value greater than the maximum for the device, the device maximum is used for the ending value.</p> <p>HEADRANGE is mutually exclusive with FROMRANGEITORANGE and with TRACKS.</p>

TORANGE parameter: specify a specific ending location

Parameter/ Abbreviations	Description
TORANGE(<i>cylinder,head</i>) TOR TO	<p>Use this parameter to specify the ending track (cylinder and head) of the volume or minidisk to be processed.</p> <p>For <i>cylinder,head</i>, substitute the decimal (n) or hexadecimal digits (for example, X'2AB',X'E') to identify the cylinder and head where processing is to end. If you specify only one value, ICKDSF takes it to be the cylinder and defaults the head to the device maximum.</p> <p>If you specify TORANGE and do not specify FROMRANGE, FROMRANGE is defaulted to cylinder 0, head 0 of the specified or minidisk.</p> <p>For information about specifying the starting track of part of a volume (FROMRANGE), see "FROMRANGE parameter: specify a specific starting location" on page 277.</p> <p>For information on specifying part of a volume, see "RANGE parameters: part of a volume" on page 280.</p>
Default:	None.
Restrictions:	<p>You cannot specify TORANGE with CYLRANGEIHEADRANGE or TRACKS.</p> <p>Only primary tracks can be specified.</p>

VERIFYNOVERIFY parameter: verify volser and ownerid

Parameter/ Abbreviations	Description
VERIFY(<i>serial[,owner]</i>) VFY	<p>Required when you want to verify the volume serial number and owner identification before processing a track on the volume or minidisk. If the volume serial number or owner identification does not match that found on the volume or minidisk, TRKFMT ends.</p> <p>For <i>serial</i>, substitute 1 to 6 alphanumeric characters for the volume serial number.</p> <p>To verify that a volume serial number does not exist, substitute the string *NONE* for <i>serial</i>. If no volume serial exists, or if the volume serial is actually ""NONE"", the TRKFMT operation continues. If a volume serial exists, the TRKFMT command ends.</p> <p>For <i>owner</i>, substitute 1 to 14 alphanumeric characters for the owner identification.</p> <p>Running in the offline mode, if VERIFY(<i>serial</i>) parameter is specified in the TRKFMT command and PARM='NOREPLYU' is specified in the EXEC card in the JCL, no operator's intervention (Reply <i>U</i> or <i>T</i>) is required.</p>
NOVERIFY NOVFY NVFY	Required when you want to bypass verification of the volume serial number.
Default:	None. You must specify either VERIFY or NOVERIFY.

Parameter/ Abbreviations	Description
Restrictions:	You cannot verify the owner identification separately from the volume serial number. Both the volume serial number and the owner identification must be verified when you want to verify the owner identification. When you specify the VERIFY parameter and verification fails, the command terminates.

Optional parameters

CYCLES parameter: number of iterations of overwrite

Parameter/ Abbreviations	Description
CYCLES(<i>n</i>)	Specified with the ERASEDATA parameter to indicate the number of times you want the set of data patterns to be written. Upon completion of all cycles, the track will be erased, (leaving the home address and record 0 on the track). For <i>n</i> , substitute a decimal number from 1 to 10 for the number of times you want the set of patterns to be written. The larger the value of <i>n</i> , the longer the execution time.
Default:	CYCLES(1)
Restrictions:	The maximum number you can specify with the CYCLES(<i>n</i>) parameter is 10.

PASSWORDS parameter: provide passwords for data set security

MVS

Parameter/ Abbreviations	Description
PASSWORDS ((<i>dsname/password</i>),...)	Specifies passwords for non-VSAM password-protected data sets. The supplied passwords will be used to determine if the user has authority to alter the data sets.
PASSWORD PASSWD PWD PD	For <i>dsname</i> , substitute the fully qualified name of a password-protected data set. For <i>password</i> , substitute the password you wish to apply to this data set.
Default:	None.
Restrictions:	Up to a maximum of 512 passwords may be specified. PASSWORD is valid only in the MVS version.

TOLERATE parameter: specify continue processing

Parameter/ Abbreviations	Description
TOLERATE(ENQFAIL) TOL(ENQF) MVS	Specifies that in the event exclusive access cannot be obtained for a data set, that processing is to continue for the track (MVS systems only). If TOLERATE(ENQFAIL) is not specified, processing continues on the next track. For tracks in VSAM data sets, TOLERATE(ENQFAIL) must be specified when processing online.
Default:	None.
Restrictions:	MVS

TRACKS parameter: specify discrete tracks

Parameter/ Abbreviations	Description
TRACKS((<i>cylinder,head</i>) [,...]) TRACK TRKS TRK	<p>Specifies discrete tracks to be processed.</p> <p>For <i>cylinder,head</i>, specify decimal (n) or hexadecimal digits to identify the cylinder, and decimal (n) or hexadecimal digits (for example, X'2AB',X'E') to identify the track to be processed. To process more than one track at a time, specify:</p> <p style="padding-left: 40px;">TRACKS((<i>cylinder,head</i>),(<i>cylinder,head</i>))</p> <p>The maximum number of individual tracks that you can specify is 20.</p> <p>Either the TRACKS parameter or the range parameters must be specified.</p>
Default:	None.
Restrictions:	<p>TRACKS and the range parameters are mutually exclusive.</p> <p>Only primary tracks can be specified.</p>

Handling of checkpoint data from a previous command

The TRKFMT command will look for checkpoint data from a previous command that may not have completed. (When the volume being processed is a minidisk, TRKFMT will not look for previous checkpoint data.) If previous checkpoint data is determined to exist, a message is issued and the TRKFMT command is terminated. The failing command must be rerun prior to re-invoking the TRKFMT command.

RANGE parameters: part of a volume

CYLRANGEIHEADRANGE and FROMRANGEITORANGE are optional parameters used to limit the areas of a volume or minidisk that are to be processed.

CYLRANGEIHEADRANGE—Specifies the starting and ending cylinders and starting and ending heads to be processed.

FROMRANGEITORANGE—Specifies the starting track (cylinder and head) and the ending track (cylinder and head) to be processed.

The following table shows the parameter conditions when specifying part of the volume.

Parameter	Other Notes
CYLRANGE	<p>If you specify CYLRANGE and do not specify HEADRANGE, all the heads of the specified cylinders are processed.</p> <p>Both the starting and ending values are required. If you specify an ending value greater than the last primary cylinder for the device, the last primary cylinder of the device (or minidisk) is used for the ending value.</p>
HEADRANGE	<p>If you specify HEADRANGE and do not specify CYLRANGE, the specified heads for all the primary cylinders on the volume (minidisk) are processed.</p> <p>Both the starting and ending values are required. If you specify an ending value greater than the maximum for the device, the device (minidisk) maximum is used for the ending value.</p>
FROMRANGE	<p>If you specify FROMRANGE and do not specify TORANGE, TORANGE is defaulted to the last primary cylinder of the device (minidisk).</p>

Parameter	Other Notes
TORANGE	If you specify TORANGE and do not specify FROMRANGE, FROMRANGE is defaulted to cylinder 0, track 0 (starting cylinder and track of the minidisk)

Notes:

1. CYLRANGEIHEADRANGE and FROMRANGEITORANGE are mutually exclusive pairs. Either pair is mutually exclusive with TRACKS. Either the TRACKS parameter or the range parameters must be specified.
2. Range parameters used with ERASEDATA can destroy large areas of a volume.
3. It is not recommended to process a large range of tracks online. If you process a range of more than 1000 cylinders online (in one invocation of the TRKFMT command), you may need to increase the amount of storage required to run (beyond the current 2M storage minimum needed for other commands).

Resource serialization when using TRKFMT



This section describes data integrity when you are processing DASD.

When TRKFMT processing occurs, the RESERVE macro is issued to obtain control of the device. DEQ is issued to release the device after processing is completed.

When TRKFMT is used, if a track is part of a data set, ICKDSF will enqueue on the data set while processing that track. Data set enqueue takes place when any one of the following conditions is true:

- The device is online to the operating system.
- The track is part of a non-VSAM data set.

If exclusive control of a data set cannot be obtained, a message is issued and processing continues on the next track.

The TOLERATE(ENQFAIL) parameter is provided to indicate that processing is to continue if the data set enqueue fails.

For tracks in VSAM data sets, TOLERATE(ENQFAIL) must always be specified when processing online.

Examples of the TRKFMT command

The following examples show different ways to code the TRKFMT command.

Any values specified here are examples only and should not necessarily be interpreted as the values for your system. Most show the use of the command in offline and online mode under MVS.



To process a volume in the Stand-Alone or CMS version:

1. Eliminate the MVS JCL.
2. Substitute the UNITADDRESS parameter for the DDNAME parameter.

TRKFMT command—CKD

VSE

To process a VSE version volume:

1. Replace the MVS JCL statements with VSE system control statements.
2. Substitute the SYSNAME parameter for the DDNAME parameter.

Processing tracks with the MVS version

MVS

The following examples show you how to process volumes with the MVS version of ICKDSF.

Processing of tracks in online mode

In this example, the volume is online to MVS. Each specified track is overwritten 1 time with the set of data patterns, and then the track is erased.

```
//EXAMPLE JOB
//      EXEC  PGM=ICKDSF
//VOLUME DD  UNIT=3390,DISP=OLD,VOL=SER=TST345
//SYSPRINT DD  SYSOUT=A
//SYSIN  DD   *
TRKFMT DDNAME(VOLUME) VERIFY(TST345) ERASEDATA -
        TRACKS((9,2),(9,3),(12,0),(12,1))
/*
```

In this example, the volume is online to MVS. Because CYCLES(3) is specified, each specified track is overwritten 3 times with the set data patterns, and then the track is erased.

```
//EXAMPLE JOB
//      EXEC  PGM=ICKDSF
//VOLUME DD  UNIT=3390,DISP=OLD,VOL=SER=TST345
//SYSPRINT DD  SYSOUT=A
//SYSIN  DD   *
TRKFMT DDNAME(VOLUME) VERIFY(TST345) ERASEDATA -
        TRACKS((9,2),(9,3),(12,0),(12,1)) CYCLES(3)
/*
```

Processing of tracks in offline mode

In this example, the volume is offline to MVS. Each specified track is overwritten 1 time with the set of data patterns, and then the track is erased.

```
//EXAMPLE JOB
//      EXEC  PGM=ICKDSF
//SYSPRINT DD  SYSOUT=A
//SYSIN  DD   *
TRKFMT UNITADDRESS(0345) VERIFY(TST345) ERASEDATA -
        TRACKS((12,3),(13,1),(11,3))
/*
```

Processing tracks in a Stand-Alone version

SA

In this example, all tracks on cylinder 5 are processed.

```
TRKFMT UNITADDRESS(0345) VERIFY(TST345) ERASEDATA -
        CYLRANGE(5,5)
```

Processing tracks in a CMS version

CMS

In this example, all tracks on cylinder 5 are processed.

```
TRKFMT UNITADDRESS(0345) VERIFY(TST345) ERASEDATA -  
CYLRANGE(5,5)
```

Processing tracks in the VSE version

VSE In this example, a volume previously initialized under VSE is processed. Each specified track is overwritten 1 time with the set of data patterns, and then the track is erased.

```
// JOB      jobname  
// ASSGN   SYS010,345  
// EXEC    ICKDSF,SIZE=AUTO  
// TRKFMT  SYSNAME(SYS010) VERIFY(TST345) ERASEDATA -  
//         TRACKS((12,1),(12,2))  
/*  
/&
```

TRKFMT command—CKD

Part 3. Using ICKDSF to install and maintain FBA devices

Part 3. describes how to use ICKDSF commands to install and maintain FBA devices. For a list of FBA devices supported by ICKDSF, see Table 11 on page 7.

Chapter 23, “Examples of ICKDSF tasks—FBA devices,” on page 287 is an overview of the tasks you perform for installation and maintenance of the FBA devices. It provides guidelines to help you determine why, when, and how to run ICKDSF.

The other chapters in this section list the ICKDSF commands in alphabetic order. Each command explanation includes:

- A table summarizing the syntax of the command
For a detailed description of the command syntax, see Chapter 3, “Understanding ICKDSF command statements,” on page 17.
- An explanation of required and optional parameters.
- A general description of the command and its use
- Examples

Chapter 23. Examples of ICKDSF tasks—FBA devices

The examples in this chapter show the commands and parameters needed for the following tasks:

- Installing devices
- Resuming initialization from a checkpoint location
- Formatting devices for specific operating environments
- Problem determination
- Media maintenance
- Emulating devices
- Miscellaneous tasks

Default parameters are included only when they produce additional output. For complete descriptions of each command and more examples, see the individual commands beginning with Chapter 24, “ANALYZE command—FBA.”

Examples of ICKDSF commands used to install and maintain CKD devices appear in Part 2, “Using ICKDSF to install and maintain CKD devices.”

Installing New devices

When your IBM service representative completes the physical installation of a new device, you must complete the recommended installation procedure for that device. For all FBA devices, you use the INIT command.

For 3370, and 9335 devices, you use the INIT command to perform a maximal INIT. For all other FBA devices, you use the INIT command to perform a minimal INIT.

Minimal INIT—Refers to using the INIT command to write the volume label and FBAVTOC on volumes for use by VSE operating systems.

Maximal INIT—Refers to using the INIT command to check the block surface and then perform the minimal INIT.

Formatting a volume—Refers to making a volume usable in a specific operating environment.

Initializing a replaced HDA with a minimal INIT

INIT writes the volume label, VTOC, home address and record 0 on a volume. To surface check the volume for possible defects (not normally required for a new device), see “Checking disk surfaces” on page 291.

```
INIT UNITADDRESS(ccuu) NOVERIFY FBAVTOC(rbn,extent,cisize) -  
VOLID(serial) OWNERID(owner) NOMAP
```

Usage Notes:

- **Data on the volume is erased.**
- This example establishes a volume ID, an owner ID, and a FBAVTOC for the volume.
-

VSE

Examples—FBA devices

If you operate in a VSE environment, add the PURGE parameter.

Resuming initialization from a checkpoint location

You use the CONTINUE parameter to resume processing after ICKDSF automatically checkpoints itself while initializing a volume.

The examples that follow show how you use the INIT command with the CONTINUE parameter to resume processing from checkpoint block 5000. Checkpointing is assumed to occur every 20000 blocks.

Example 1:

If after issuing:

```
INIT UNIT(ccuu) NOVFY CHECK(3)
```

processing is interrupted, and you are unsure of the size of the block you are initializing, you can initialize part of the volume. Use CONTINUE to resume from the last checkpoint.

```
INIT UNIT(ccuu) NOVFY NOCHECK CONTINUE VOLID(volser) NOMAP
```

Usage Notes:

- Blocks 5000 through 24999 are processed to ensure that the data fields are readable.
- The minimal initialization function is then performed.

Example 2:

If after issuing:

```
INIT UNIT(ccuu) NOVFY CHECK(3)
```

processing is interrupted, you can ensure processing starts from the beginning of the specified range.

```
INIT UNIT(ccuu) NOVFY CHECK(3) -  
BLOCKRANGE(3000,24000) NOCONTINUE VOLID(volser) NOMAP
```

Usage Notes:

- Blocks 3000 through 24000 are surface checked.
- Blocks 24001 through 24999 are processed to ensure that the data fields are readable.
- The minimal initialization function is then performed.

Example 3:

If after issuing:

```
INIT UNIT(ccuu) NOVFY CHECK(3)
```

processing is interrupted, you can surface check part of the volume.

```
INIT UNIT(ccuu) NOVfy CHECK(3) -
  BLOCKRANGE(3000,24000) CONTINUE VOLID(vo1ser) NOMAP
```

Usage Notes:

- The blocks, starting at block 5000 and continuing for 20000 blocks, are surface checked.
- No additional blocks are processed.
- The minimal initialization function is then performed.

Formatting devices

Once your device is initialized, you must format it for your operating environment. To format your volume, use the:

INIT command for VSE
CPVOLUME command for VM

Formatting FBA minidisks

CMS **SA**

With the CMS or the stand-alone version of ICKDSF, you can use the INIT command to format an FBA minidisk for use.

This example initializes a minidisk at the minimal level by establishing a volume ID, an owner ID, and an FBA VTOC on the minidisk.

```
INIT UNITADDRESS(ccuu) NOVERIFY FBAVTOC(rbn,extent,csize) -
  VOLID(serial) OWNERID(owner)
```

Formatting an entire volume with the CMS version

CMS

In this example, all 69750 pages on a 3370-1 volume are formatted. The allocation map indicates that all 69750 pages on the volume are allocated as PERM space.

Because NOREADCHECK is specified, a read-back check of the volume does not occur.

Because NOVERIFY is specified, any existing volume label is ignored, and the volume is labelled 'ESARES'.

```
CPVOLUME FORMAT UNIT(0150) NOVERIFY VOLID(ESARES) NOREADCHECK
```

Changing the volume serial Number and owner identification

CMS **SA**

You may specify either VOLID or OWNERID, or both. No other data on the volume is changed.

```
REFORMAT UNITADDRESS(ccuu) VERIFY(serial,owner) -
  VOLID(newserial) OWNERID(newowner)
```

Placing an FBAVTOC at the end of a volume

VSE

In the following example, ICKDSF puts the FBAVTOC at the end of the volume. This example allows ICKDSF to choose the location and size of the FBAVTOC. It is valid for any device.

Examples—FBA devices

```
INIT SYSNAME(sysxxx) NOVFY VOLID(volser) FBAVTOC(END) NOMAP
```

Writing the FBAVTOC

VSE This example shows how you can write a FBAVTOC.

```
INIT SYSNAME(sysxxx) NOVERIFY VOLID(serial) -  
OWNERID(owner) FBAVTOC(rbn,extent,csize) NOMAP
```

Problem determination

You can use ICKDSF to diagnose errors without the assistance of a service representative.

You can use the ANALYZE command to examine a device and the data on a volume to help determine the existence and the nature of errors. Dual copy volumes, which are in duplex or suspended duplex state, are supported by the ANALYZE command.

You use two parameters with the ANALYZE command:

- DRIVETEST which tests the hardware device
- SCAN which reads data on a volume

You can use the DRIVETEST parameter to ensure that device hardware can perform basic operations, such as seeks, reads, and writes. DRIVETEST can impact your system performance, but does not alter data.

You can use ANALYZE SCAN to read data that currently exists on a volume. If ANALYZE SCAN reads the data successfully the first time, no further rereading of the block takes place.

A **data check** is an error detected in the bit pattern read from the disk. If ANALYZE SCAN detects a data check on the first read, it issues further reads of the data. This ensures that the data check is not a random occurrence.

Data is read with subsystem and error recovery processes disabled to allow ANALYZE SCAN to identify all data checks. ANALYZE SCAN has no effect on user data on the volume.

You can enter DRIVETEST and SCAN independently or together. Data is never recorded in the error recording data set (ERDS) during ANALYZE SCAN or ANALYZE DRIVETEST processing. ERDS information is stored in SYSREC by VSE and in the error recording area by VM.

Investigating suspected drive problems

If you suspect a problem with a drive, use the ANALYZE command to determine:

- If the drive can perform basic operating functions correctly
- If all data can successfully be read from the disk surface

```
ANALYZE UNITADDRESS(ccuu) SCAN
```

Usage Notes:

- The data on the volume is not altered.
- Add the SPEED parameter to scan the maximum number of data blocks on each pass.

VM

This option is not recommended for VM users; although SPEED makes the scanning process faster, it also keeps the drive busy and therefore degrades the performance of other VM users.

- Add the LIMITS parameter to specify only a limited area for scanning.
- For information on ANALYZE output, see to Chapter 24, “ANALYZE command—FBA.”

Finding where INSPECT failed

This example shows how the checkpoint processing works. It is not meant to show you how to use INSPECT to perform media maintenance procedures.

If you issued the following INSPECT command to perform surface checking on an FBA device:

```
INSPECT UNIT(ccuu) NOVFY CHECK(3) -
      BLOCKRANGE(5000,25000) PRESERVE
```

and processing was interrupted on block 13656, you can use ANALYZE to locate the block that was being processed when the program stopped. For example, you can issue:

```
ANALYZE UNIT(ccuu) DRIVETEST
```

The DRIVETEST parameter is valid only for devices that have nonremovable storage media. For more information, see Chapter 24, “ANALYZE command—FBA.”

Checking disk surfaces

Use the INIT command to check the surface of all blocks during initialization. INIT writes test patterns and then reads them back for every block on the volume. An alternate block is assigned for any primary block that is indicated as defective. For example:

```
INIT UNITADDRESS(ccuu) VERIFY(serial,owner) -
      FBAVTOC(rbn,extent,cisize) CHECK(3)
```

For more information, see “Conditionally assigning alternate blocks” on page 292.

Usage Notes:

- **Data on the volume is erased.** If you do not want to erase your data, dump it before processing begins.
- The CHECK(3) parameter ensures that all three data patterns available for surface checking are used. A value higher than 3 merely repeats the three basic patterns. If you select 1 or 2 for the number of patterns, ICKDSF needs less time to run, but the surface checking is less thorough.
-

VSE

Examples—FBA devices

If you operate in VSE, add the PURGE parameter.

- The MAP parameter is a default. MAP prints a volume map of alternate blocks assigned during this process.
- No attempt is made to reclaim defective blocks; for the recommended procedure, see “Reclaiming flagged blocks” on page 293.

Media maintenance

Once you suspect media as a cause of data checks, you can use ICKDSF to assign alternate blocks, rewrite the data, or reclaim the block. For more information about performing media maintenance, see *Maintaining IBM Storage Subsystem Media*, GC26-4495.

Conditionally assigning alternate blocks

Use the INSPECT command to check the surface of a block and to assign an alternate block if the surface-checking process indicates that the block is defective. When PRESERVE is used, the data is moved from the current block to the assigned alternate block.

```
INSPECT UNITADDRESS(ccuu) VERIFY(serial,owner) BLOCKS(rbn) -  
CHECK(3) NOPRESERVE|PRESERVE
```

Usage Notes:

- The CHECK(3) parameter ensures that the three data patterns available for surface checking are all used. A value higher than 3 merely repeats the three basic patterns. If you select 1 or 2 for the number of patterns, ICKDSF needs less time to run, but the surface checking is less thorough.
- You may specify up to 20 blocks for conditional assignment by adding them to the BLOCKS parameter (separated by commas).
- **NOPRESERVE erases the data on the block.** Use this parameter only if there is no meaningful data on the block or if block errors prevent successful use of PRESERVE.
- For IBM 3370 FBA devices, assignment of an alternate block is generally done on the same physical cylinder on which the defective block resides, thereby minimizing any performance degradation experienced when seeking to an independent alternate cylinder.

A block is therefore considered defective for correctable data checks as well as for uncorrectable data checks when the correctable data check is made visible to ICKDSF.

Unconditionally assigning alternate blocks

Use the INSPECT command to unconditionally assign an alternate block regardless of the condition of the primary block.

```
INSPECT UNITADDRESS(ccuu) VERIFY(serial,owner) BLOCKS(rbn) -  
ASSIGN NOCHECK
```

Usage Notes:

- If the inspected block has a current alternate, a new alternate is assigned.
- You may specify up to 20 blocks for unconditional assignment by adding them to the BLOCKS parameter (separated by commas).

Reclaiming flagged blocks

In general, a block should be flagged defective only if ICKDSF finds a known defect. If a volume contains multiple-flagged blocks that no longer need to be flagged, the defective blocks may be reclaimed.

To reclaim blocks, first use the ANALYZE command to verify that the device is operative. Then, if there are no problems with the device, use the INIT command to reclaim previously flagged blocks.

```
ANALYZE UNITADDRESS(ccuu)
IF LASTCC ≤ 4 THEN -
INIT UNITADDRESS(ccuu) VERIFY(serial,owner) -
    FBAVTOC(rbn,extent,cisize) CHECK(3) RECLAIM
```

Usage Notes:

- **Data on the volume is erased.** If you do not want to erase your data, dump it before processing begins.
- After all assigned alternate blocks (except factory-flagged blocks) become unassigned, the INIT command makes a thorough surface check of all nondefective primary blocks and factory-assigned alternate blocks. Any block found defective and any block previously flagged defective at the factory are assigned alternate blocks.
- The CHECK(3) parameter ensures that the three data patterns available for surface checking are all used. A value higher than 3 merely repeats the three basic patterns. If you select 1 or 2 for the number of patterns, ICKDSF needs less time to run, but the surface checking is less thorough.
-

VSE

If you operate in VSE, add the PURGE parameter.

- The MAP parameter is a default. MAP prints a volume map of alternate blocks assigned during this process.
- If a maximal initialization, with the RECLAIM parameter, ends with an I/O error before INIT ends, the volume might have one or more defective primary blocks with invalid alternate block pointers. If this occurs, determine what caused INIT to end, then rerun the maximal INIT RECLAIM again. Any future attempt to initialize the volume will force the maximal INIT RECLAIM to continue.

Saving data during surface checking

The following examples show how you can recover after an INSPECT fails. They show how the checkpoint processing works and are not meant to show you how to use INSPECT to perform media maintenance procedures.

Use PRESERVE to save a copy of the data on the block at a backup location and in storage. If processing does not complete, ICKDSF finds and restores the block it was processing when the INSPECT was interrupted. (Provided PRESERVE was initially able to read the track successfully.)

Example 1:

Examples—FBA devices

In the following example, INSPECT surface checks all blocks from the beginning of the volume through block 25000. PRESERVE saves the data during surface checking at the backup location and in storage.

```
INSPECT UNIT(ccuu) NOVFY CHECK(1) -  
      BLOCKRANGE(0,25000) PRESERVE NOMAP
```

Example 2:

In the following example, INSPECT surface checks an FBA device and is interrupted on block 13656. PRESERVE saves the data during surface checking at the backup location and in storage.

```
INSPECT UNIT(ccuu) NOVFY CHECK(3) -  
      BLOCKRANGE(5000,25000) PRESERVE
```

Example 3:

If after issuing:

```
INSPECT UNIT(ccuu) NOVFY CHECK(3) -  
      BLOCKRANGE(5000,25000) PRESERVE
```

processing is interrupted on block 13656, you can surface check a different part of the volume:

```
INSPECT UNIT(ccuu) NOVFY CHECK(3) -  
      BLOCKRANGE(50000,100000) PRESERVE NOMAP
```

Usage Notes:

- Block 13656 is surface checked. If any data existed for block 13656 when processing was interrupted, the data is rewritten on block 13656.
- Surface checking is then performed for all the blocks within the new range.

Example 4:

If after issuing:

```
INSPECT UNIT(ccuu) NOVFY CHECK(3) -  
      BLOCKRANGE(5000,25000) PRESERVE
```

processing is interrupted on block 13656, you can ensure the usability of the block and recover the data.

```
INSPECT UNIT(ccuu) NOVFY
```

13656 is surface checked. If any data existed for block 13656 when processing was interrupted, the data is rewritten on block 13656.

Example 5:

The following example performs the data verification test for blocks 0 to 100000. The drive test is not performed. You can substitute LIMITS for BLOCKRANGE.

```
ANALYZE UNIT(ccuu) SCAN NODRIVE BLOCKRANGE(0,100000)
```

Performing miscellaneous tasks with ICKDSF

The following examples show how you can:

- Erase a volume
- Print a block assignment map

Erasing a volume

If the data is residual, you can reformat the volume.

For VSE volumes, use the INIT command.

For VM volumes use CPVOLUME FORMAT.

VSE

The following example shows you how to use INIT to erase data on an VSE volume. INIT restores the FFVDP on the volume.

```
INIT SYSNAME(sysxxx) NOVERIFY VOLID(serial) PURGE
```

Printing a block assignment map

Use the MAPALT command to format and print a detailed report of alternate block assignment status for the volume.

```
MAPALT UNITADDRESS(ccuu) DETAIL
```

Usage Notes:

- The data on the volume is not altered.
- Add the LIMITS parameter to restrict the report to a specific range of blocks.
- To produce only a summary report, remove the DETAIL parameter.
- You can also use INIT or INSPECT to get a map of alternate blocks assigned.

Emulating a CKD device on an FBA device

For more information, see “Emulating devices” on page 84.

Chapter 24. ANALYZE command—FBA



The ANALYZE command examines the drive and the user's data on a volume to determine if errors exist. The output:

- Shows drive problems on nonremovable media
- Shows media problems
- Assists in locating and fixing problems

The IBM 0671, 9313, 9332, and 9336 are not supported by the ANALYZE command.

ANALYZE has two basic functions: drive test and data scan. For more general information on what ANALYZE does, see "Problem determination" on page 290.

Syntax

ANALYZE
Required Parameters SYSNAME(<i>sysxxx</i>) UNITADDRESS(<i>ccuu</i>) REALADDR(<i>ccuu</i>)
Optional Parameters DRIVETEST INODRIVETEST LIMITS(<i>start,end</i>) BLOCKRANGE(<i>start,end</i>) ALL SCAN INOSCAN SPEED INOSPEED USERID(<i>user's ID</i>)

Required parameters

SYSNAME|UNITADDRESS|REALADDR parameter: identify the volume

Parameter/ Abbreviations	Description
SYSNAME(<i>sysxxx</i>)	Required to identify a VSE volume when executing ICKDSF in batch mode; the volume must be online. For <i>sysxxx</i> , specify the SYSNAME in the ASSGN system control statement.
UNITADDRESS(<i>ccuu</i>) UNITADDR UNIT	Required for a minidisk, Stand-Alone, or CMS version volume. For VSE, it is required when executing ICKDSF in command mode; the volume must be online. For <i>ccuu</i> , specify the address (3 or 4 hexadecimal digits) of the channel and unit of the volume. For the CMS version, specify the virtual address of the dedicated volume or minidisk. The unit address is the device number.
REALADDR(<i>ccuu</i>) RADDR	Used to specify the real address of a volume. This parameter is valid only when you are running the CMS version of ICKDSF and you have DEVMAINT authority. For <i>ccuu</i> , specify the real address (3 or 4 hexadecimal digits) of the channel and unit of the volume. CMS REALADDR is mutually exclusive with UNITADDRESS, SYSNAME, and USERID.
Default:	None.
Restrictions:	None.

Optional parameters

DRIVETEST|NODRIVETEST parameter: specify the drive test

Parameter/ Abbreviations	Description
DRIVETEST DRIVE	Runs the drive test.
NODRIVETEST NODRIVE	Bypasses the drive test.
Default:	DRIVETEST
Restrictions:	NODRIVE NOSCAN performs no functions.
	You cannot run multiple DRIVETESTs on a volume or minidisk.
	With the CMS version of ICKDSF, DRIVETEST is valid for dedicated devices.

LIMITS|BLOCKRANGE|ALL parameter: specify data verification area

Parameter/ Abbreviations	Description
LIMITS(<i>start,end</i>) LIMIT LIMS LIM	Specifies the area of the disk where data verification is to be performed. <i>start,end</i> specifies the relative starting and ending block numbers of the data verification tests. The values can be expressed in decimal or hexadecimal, must be equal or in ascending order, and must fall within the device address limits. For device limits, see Table 55 on page 308.
BLOCKRANGE (<i>start,end</i>) BLKRANGE BLOCKR BLKR	For <i>start,end</i> , specify the starting and ending relative block numbers to be verified. The values can be expressed in decimal or hexadecimal and must fall within the device limits. See Table 55 on page 308 for device limits. BLOCKRANGE is identical in function to LIMITS and is included for consistency with other ICKDSF commands.
ALL	Reads all blocks of a volume or minidisk during the data verification tests.
Default:	All blocks is the default if you do not specify LIMITS or BLKR.
Restrictions:	LIMITS, BLOCKRANGE, or ALL apply only when the SCAN parameter has been specified. LIMITS, BLOCKRANGE, and ALL are mutually exclusive.

SCAN|NOSCAN parameter: run data verification tests

Parameter/ Abbreviations	Description
SCAN SCN	Indicates that you want the data verification test to be run. Data verification is run if you specify SCAN, and any of the following is true: <ul style="list-style-type: none"> The drive test completed successfully. The drive test has been bypassed (NODRIVE).
NOSCAN NOSCN NSCAN NSCN	Indicates that you do not want the data verification test to be run.
Default:	NOSCAN
Restrictions:	None.

SPEEDINOSPEED parameter: specify data verification tests

Parameter/ Abbreviations	Description
SPEED	Specifies that each I/O will read the maximum number of blocks: 744 blocks for the 3370, and 426 blocks for the 9335.
NOSPEED NSPEED	Specifies that each I/O will read the minimum number of blocks: 248 blocks for the 3370, and 71 blocks for the 9335.
Default:	NOSPEED
Restrictions:	SPEED is not recommended for VM operating system or guest minidisks that are part of a volume where other users are active.

USERID parameter: specify another user's minidisk**CMS**

Parameter/ Abbreviations	Description
USERID(<i>user's ID</i>) UID	Performs the ANALYZE data verification test on another user's minidisk. For <i>user's ID</i> , substitute the 1 to 8 characters of the ID of the user whose minidisk you want to verify. For more information on processing minidisks, see Chapter 8, "ICKDSF versions supported as guests under VM."
Default:	If USERID is not specified, your own minidisk is verified.
Restrictions:	USERID can be specified only if you are using the CMS version of ICKDSF and have DEVMAINT authority. USERID is ignored in all other system environments. USERID is mutually exclusive with REALADDR. You must use UNITADDRESS with USERID. UNITADDRESS specifies the virtual address of the minidisk.

Detecting hardware problems with DRIVETEST

The drive test is a general exercising of the storage device by issuing locate, read, and write commands. From the results, ANALYZE determines the drive's ability to perform expected actions.

ANALYZE does not require exclusive control of the drive under test. Most of ANALYZE's channel command word (CCW) chains (its channel programs) do not hold the drive busy for longer than 0.5 seconds. However, if the operating system runs error recovery procedures as a result of I/O errors detected during ANALYZE processing, the error recovery procedures may hold the drive busy for a longer period of time.

ANALYZE supports FBA block devices in fixed block mode only. This mode is based on data transfers of 512-byte blocks for storing and retrieving data.

Testing the drive and logical volume with ANALYZE

ANALYZE determines that the drive is fully operational by performing I/O operations on the CE block that test the drive's functional capabilities. Each I/O operation, called a CCW chain, tests a specific function of the drive and logical volume. Tests are executed in order of increasing complexity.

ANALYZE command—FBA

Drive problems that can be detected during ANALYZE's initial tests are access arm positioning errors and the ability to read and write.

If you have issued PRESERVE or CONTINUE for the data that exists on the CE cylinder, ANALYZE does not destroy this data. This data is written by an INSPECT or INIT. If this data exists, ANALYZE bypasses writing over the data and reports the presence of the data.

The drive test is optional. It is controlled by the DRIVETESTINODRIVETEST parameters.

Verifying data records with ANALYZE

The ANALYZE data verification test determines the status of the drive's storage medium by reading (without data transfer across the channel to the processor) all data records on the volume or minidisk if you are running the CMS version of ICKDSF. If a data check is detected during the test, both the address and relative block number are noted in a diagnostic message on the printer. When a block is found to be defective, you can bypass the defect by assigning an alternate block to it.

Options for data verification include:

- Specifying data verification of the whole volume (or minidisk for the CMS version).
- Selecting a range of data to be verified by blocks (LIMITS or BLOCKRANGE parameters).
- Controlling the duration of each I/O by specifying either SPEED or NOSPEED.
NOSPEED—Specifies that each I/O will read the minimum number of blocks: 248 blocks for the 3370, and 71 blocks for the 9335.
SPEED—Specifies that each I/O will read the maximum number of blocks: 744 blocks for the 3370, and 426 blocks for the 9335.

Solving problems with ANALYZE output

The ANALYZE command is designed to produce output that can be used to aid in problem determination for a current volume. Certain errors that might occur are correctable by the device and its storage control. These errors are normally never seen by the software. Other errors are never seen by the user. They can be corrected by the software usually under the operating system error recovery procedures.

Some errors are unrecoverable under all procedures. Errors that are persistent and that cannot be corrected by the device's internal error-correction circuitry result in messages to the output device.

As part of an installation's operating procedure, ANALYZE output can assist in determining whether or not recovery procedures can or should be executed. However, the use of ANALYZE output by customer engineers to isolate and to repair drive malfunctions should not replace the use of more detailed diagnostic tools. ANALYZE output in such instances should serve only as an initial reference. It may indicate the final problem symptom but does not specifically isolate the problem source.

Assumed conditions when running ANALYZE

When you run ANALYZE, the following conditions are assumed to exist:

- Each block has a properly formatted ID field and 512-byte data area.
- The blocks used by ANALYZE in the CE area are defect-free.

ANALYZE performs two testing procedures to detect errors—the drive test and the data verification test.

CMS version minidisk support

CMS

When you are using the CMS version of ICKDSF, you can use the ANALYZE command to perform the data verification test for a minidisk.

The following parameters are valid for minidisks:

ALL, LIMITSIBLOCKRANGE, SCANINOSCAN, SPEEDINOSPEED, and UNITADDRESS

Note: You must have DEVMAINT authority to issue the ANALYZE command for the IBM 9335.

The following parameters are valid only when you are using the CMS version of ICKDSF and have DEVMAINT authority (as defined in the CP directory):

USERID: With DEVMAINT authority you can use the USERID parameter to perform the data verification test on another user's minidisk. All of the parameters listed above are valid in this mode.

REALADDR: With DEVMAINT authority you can use the REALADDRESS parameter to specify the real device address to perform the data verification test on a volume. UNITADDRESS is not valid in this mode. All of the other parameters listed above are valid. For more information, see Chapter 5, "Getting started with the CMS version."

Examples of the ANALYZE command

The following examples show different ways to use the ANALYZE command.

Any values specified here are examples only and should not necessarily be interpreted as the values for your system.

Analyzing volumes with the Stand-Alone version

SA

The following examples show how you can analyze a volume using the Stand-Alone version of ICKDSF.

Performing a drive test

In this example, the 3370 Direct Access Storage drive tests are performed:

```
ANALYZE UNITADDRESS(0141)
```

ANALYZE command—FBA

Using keyword abbreviations, you could have specified:

```
ANALYZE UNIT(0141)
```

Performing a drive test and data verification test

In this example, the 3370 Direct Access Storage drive tests are performed and are followed by the data verification tests for the entire 3370 volume. ALL is the default.

```
ANALYZE UNITADDRESS(0141) SCAN
```

Performing a partial data verification test

In this example, the 3370 Direct Access Storage drive tests are performed, followed by partial data verification tests starting at relative block number 25 and ending at relative block number 50. Abbreviations have been used.

```
ANALYZE UNIT(0141) LIMS(X'19',X'32') SCN
```

Analyzing volumes with the CMS version

CMS

The following examples show how you can analyze a volume using the CMS version of ICKDSF.

Analyzing another user's minidisk

In this CMS version example, the data verification test is performed for another user's minidisk. You specify the USERID parameter to ANALYZE the minidisk which is owned by user SMITH at the user's virtual address 0351. You must have DEVMAINT authority (as defined in the CP directory) to specify the USERID parameter.

```
ANALYZE UNIT(0351) SCAN USERID(SMITH) NODRIVETEST
```

Analyzing a volume specifying a real address

In this CMS version example, the data verification test is performed for a volume at real address 290 by using the REALADDR parameter. You must have DEVMAINT authority (as defined in the CP directory) to specify the REALADDR parameter.

```
ANALYZE REALADDR(290) SCAN NODRIVETEST
```

Analyzing a VSE version volume

VSE

In this example, drive tests are performed on the volume SYS001. Specification of the NOSCAN parameter indicates that data verification tests are not to be performed.

```
// JOB    jobname  
// ASSGN  SYS001,150  
// EXEC  ICKDSF,SIZE=AUTO  
        ANALYZE SYSNAME(SYS001) NOSCAN  
/*  
/&
```

Diagnostic messages

ANALYZE prints diagnostic messages to the output device. You or your customer engineer can use them as an aid in determining what type of problem might exist on the volume.

The informational and diagnostic messages are listed and explained in Appendix A, “Device Support Facilities messages (ICK).”

In addition, ANALYZE produces a movable-head and fixed-head error table that summarizes errors associated with the read/write circuitry and data verification. This table is printed on the system printer after all tests are completed.

Figure 29 shows the format of the movable-head error table. The physical heads are listed in the first column on the left. A character 'X' is placed in the column corresponding to the type of error detected for a particular head.

MOVABLE HEAD ERROR TABLE					
HEAD NUMBER	DATA CHK	SEEK VERIFY	WRITE CHK	DATA CHK	DATA COMP
		CHECK		CE CYL	ERROR
00	----	-----	-----	-----	-----
01	----	-----	-----	-----	-----
02	----	-----	-----	-----	-----
03	----	-----	-----	-----	-----
04	----	-----	-----	-----	-----
05	----	-----	-----	-----	-----
06	----	-----	-----	-----	-----
07	----	-----	-----	-----	-----
08	----	-----	-----	-----	-----
09	----UC----	-----	-----	-----	-----
10	----U----	----X----	----X----	----X----	----X----
11	----C----	----X----	----X----	----X----	----X----

In the data check column:

Symbol	Indicates...
U	At least one ECC uncorrectable error occurred on this head.
C	At least one ECC correctable error occurred on this head.
UC	At least one ECC correctable and one ECC uncorrectable error occurred on this head.
X	At least one error, as indicated by the column heading, has occurred on this head.

For the actual number of errors that occurred for a specific head, examine previous messages provided in the ANALYZE output.

Figure 29. Movable-head error table—FBA

Chapter 25. CPVOLUME command—FBA



The CPVOLUME command is used to format a volume for use in a VM environment. It is used to perform the following functions associated with formatting VM volumes for CP use:

FORMAT	Write records required by CP on page 0. Write 4096-byte CP page records on an entire volume or on a range of pages. For more information about CP page records, see “Formatting pages” on page 308.
ALLOCATE	Update the allocation map to indicate how each page on a CP-formatted volume is to be used.
EXAMINE	Read a CP-formatted volume to verify that it is properly formatted and that records can be read without error.
LIST	Display the allocation map, volume serial, and device information, such as the number of pages.
LABEL	Rewrite the volume serial.

Formatting CP volumes for a specific VM operating system

The CPVOLUME command formats volumes for use on VM/ESA or z/VM systems.

Syntax

CPVOLUME
Required Parameters FORMAT ALLOCATE LABEL LIST EXAMINE UNITADDRESS(<i>ccuu</i>) VERIFY(<i>serial</i> *NONE*) NOVERIFY
Optional Parameters RANGE(<i>start,end</i>) READCHECK NOREADCHECK TYPE(<i>(type of allocation,start,end)...</i>) VOLID(<i>serial</i>)

Required parameters

FORMAT|ALLOCATE|LABEL|LIST|EXAMINE parameter: specify function

Parameter/ Abbreviations	Description
FORMAT FMT	Formats a volume. An entire volume or a range of pages can be formatted.
ALLOCATE ALLOC	Updates the allocation map of a previously formatted volume.
LABEL	Rewrites the volume serial of a previously formatted volume.
LIST	Displays volume information for a previously formatted volume.

CPVOLUME command—FBA

Parameter/ Abbreviations	Description
EXAMINE EXAM	Examines entire volume or range of pages on a previously formatted volume for errors.
Default:	None.
Restrictions:	FORMAT, ALLOCATE, LABEL, LIST, and EXAMINE are mutually exclusive.

UNITADDRESS parameter: identify the volume

Parameter/ Abbreviations	Description
UNITADDRESS(<i>ccuu</i>) UNITADDR UNIT	Required to specify the address of the volume to be processed. For <i>ccuu</i> , specify the virtual address of the volume. The unit address is the device number.
Default:	None.
Restrictions:	None.

VERIFY/NOVERIFY parameter: verify the volume serial number

Parameter/ Abbreviations	Description
VERIFY(<i>serial</i>) VFY	Required when you want to verify the volume serial number before performing the requested function on the volume. If the volume serial number does not match that found on the volume, the CPVOLUME command ends. For <i>serial</i> , substitute 1 to 6 alphanumeric characters for the volume serial number. To verify that a volume serial number does not exist, substitute the string *NONE* for <i>serial</i> . If no volume serial exists, or if the volume serial is actually “*NONE*”, the CPVOLUME operation continues. If a volume serial exists, the CPVOLUME command ends.
NOVERIFY NOVFY NVFY	Required when you want to bypass verification of the volume serial number.
Default:	None. You must specify either VERIFY or NOVERIFY.
Restrictions:	When you specify the VERIFY parameter and verification fails, the command stops running.

Optional parameters

RANGE parameter: specify the range of pages

Parameter/ Abbreviations	Description
RANGE(<i>start,end</i>)	Specifies the range of pages that are to be formatted or examined. Use <i>start,end</i> to specify a range of pages.
Default:	If RANGE is not specified, the default is the entire volume.
Restrictions:	Valid only when you specify either FORMAT or EXAMINE.

READCHECKINOREADCHECK parameter: specify read-back check

Parameter/ Abbreviations	Description
READCHECK READCHK RDCHECK READ	Performs a read-back check for each page after it is formatted. If read-back check media errors are detected, it issues the INSPECT command to repair the block.
NOREADCHECK NOREADCHK NOREAD NREAD	Specifies not to perform a read-back check.
Default:	READCHECK
Restrictions:	READCHECK is valid only when you specify FORMAT.

TYPE parameter: specify the type of allocation

Parameter/ Abbreviations	Description														
TYPE(<i>(type of allocation, start,end)...</i>)	<p>Specifies the type of allocation.</p> <p>Multiple statements of each <i>type of allocation</i> can be specified (up to 100). Be careful when you use multiple statements. Each succeeding statement modifies allocation without regard to previous statements.</p> <p>Use <i>start,end</i> to specify the pages required for the <i>type of allocation</i>.</p> <p>Specify <i>type of allocation</i> as follows:</p> <table border="1"> <thead> <tr> <th>Type</th> <th>Allocates...</th> </tr> </thead> <tbody> <tr> <td>DRCT</td> <td>Directory space</td> </tr> <tr> <td>PAGE</td> <td>Paging space</td> </tr> <tr> <td>PARM</td> <td>Disk space for CP PARM</td> </tr> <tr> <td>PERM</td> <td>Permanent space</td> </tr> <tr> <td>SPOL</td> <td>Spooling space for VM</td> </tr> <tr> <td>TDSK</td> <td>Temporary disk space</td> </tr> </tbody> </table> <p>You can have back-to-back PARM disks.</p>	Type	Allocates...	DRCT	Directory space	PAGE	Paging space	PARM	Disk space for CP PARM	PERM	Permanent space	SPOL	Spooling space for VM	TDSK	Temporary disk space
Type	Allocates...														
DRCT	Directory space														
PAGE	Paging space														
PARM	Disk space for CP PARM														
PERM	Permanent space														
SPOL	Spooling space for VM														
TDSK	Temporary disk space														
Default:	None. You must specify <i>type of allocation</i> and <i>start,end</i> .														
Restrictions:	<p>When a volume is formatted for the first time, any space not specified by DRCT, PAGE, PERM, and TDSK parameters is allocated as PERM. Subsequently, the allocation does not change unless you specify TYPE.</p> <p>Once you have allocated PARM as the <i>type of allocation</i>, you must reallocate the entire range if a change is required.</p>														

VOLID parameter: specify the volume serial number

Parameter/ Abbreviations	Description
VOLID	Writes the volume serial number in the volume label.
Default:	If VOLID is not specified, the existing volume serial number is used. If there is no current volume serial number, then the system issues 'NONE'.
Restrictions:	If VOLID is not specified, the existing volume serial number is used. If there is no current volume serial number, then the system issues 'NONE'.

Formatting pages

FBA volumes store data in 512-byte blocks. A CP-formatted volume stores data in 4096-byte logical records. These records are referred to as **CP pages**. Eight FBA blocks hold one CP page record.

The unit for formatting and allocation is the page. CPVOLUME formats a page by writing 0s in each of the 512-byte blocks assigned to the page. Pages are numbered sequentially beginning with page 0. Blocks are also numbered sequentially beginning with block 0. For example, to format page 2, CPVOLUME writes 0s in blocks 16-23.

The first 32 blocks (pages 0, 1, 2, and 3) are reserved for system use. These reserved pages are formatted with records that include the volume label and allocation map. The allocation map indicates how each page on the volume is to be used by CP. Always format pages 0 and 1 before any other pages.

All of the pages on a volume do not have to be formatted, only those pages that you want initialized with 0s. To format an entire volume or limit the operation to part of a volume, issue the RANGE parameter. If you omit the range parameter, CPVOLUME assumes that the range is for the entire volume. If you specify a range that does not begin with page 0, then pages 0 and 1 must have been previously formatted.

If you specify READCHECK, CPVOLUME reads and checks the pages to ensure that there are no errors.

If you specify READCHECK and a data check is encountered on a page:

1. ICKDSF issues INSPECT to check the surface of the blocks in the page.
2. INSPECT performs skip displacement surface checking to eliminate data checks from the blocks
3. If required, INSPECT will assign an alternate block.
4. After the blocks have been inspected, the page is formatted again, and the FORMAT operation continues.

When formatting is complete, the allocation map is updated from any allocation TYPE statements that you specified in the CPVOLUME FORMAT command.

The maximum block/page numbers for FBA devices are shown in Table 55.

Table 55. Maximum block and page numbers for FBA devices

Device	High Block	High Page
0671-0	574 559	71 819
0671-4	615 383	76 922
0671-8	513 071	64 133
3370-1	557 999	69 749
3370-2	712 751	89 093
9313	246 239	30 779
9332-400/402	360 035	45 003
9332-600/602	554 799	69 349
9335	804 713	100 588

Table 55. Maximum block and page numbers for FBA devices (continued)

Device	High Block	High Page
9336-10	920 114	115 013
9336-20	1 672 880	209 109

Formatting blocks 0-15

CPVOLUME formats blocks 0-15 with the following records:

BLOCK	Record Created	Description
0	IPL record	CPVOLUME creates an IPL record that puts the system into a wait state if the volume is IPLed before the CP nucleus is built.
1	Volume Label record	The owner field of the label record contains “CP370” if the volume is formatted for use on a System/370 VM system.
2	OS/VTOC Format 4 and Format 5 DSCBs	The VTOC records created by CPVOLUME indicate that no space is available on the volume.
3-4	Allocation Map	Consists of 12-byte entries, each of which describes a range of pages on the volume and the usage of those pages (PERM, DRCT, SPOL, etc.). The map can describe up to 85 allocation ranges.
5-12	Checkpoint record	CPVOLUME writes 0s in this record. The checkpoint record is used by CP to save and retrieve information for a warm start.
13-15	Reserved	
16-31	Reserved for VM system use.	

Updating the allocation map

Use ALLOCATE to update the allocation map. All pages on a volume are initially allocated as PERM by CPVOLUME. To make a change to the allocation map, specify *type of allocation* followed by a range of pages. For example, CPVOLUME ALLOCATE TYPE(TEMP;100,1999) indicates that the 1900 pages from 100 to 1999 should be allocated as temporary disk space.

Examining pages for errors

Use EXAMINE to verify that pages are CP-formatted and readable without error. You specify a range of pages to be examined, which may be the entire volume. CPVOLUME reads each page to ensure that the data in each block of a page can be read without error. EXAMINE will report the block number of each block that contains a data check.

The EXAMINE function is read-only and will not write over any user data. For any errors reported by EXAMINE, you should take appropriate corrective action. Use INSPECT to check for any blocks reporting data checks.

Displaying volume information

Use LIST to display current volume information. Use this function to display the allocation map, volume label, and device information, such as the number of pages.

Rewriting the volume serial

Use LABEL to rewrite the volume serial of a previously formatted volume. When the serial is rewritten, the remaining bytes of the volume label are unaltered.

Copying data to a different device size

On a CP-formatted volume, the size of the allocation map must match the number of pages on the volume. The map contains at least 1 and at most 85 entries. Each entry contains a starting and ending page number and a code indicating how the pages within the range are allocated.

When pages 0 and 1 (blocks 0-15) are copied from one device type to another, the allocation map that is copied may no longer match the number of pages on the volume.

For example, if you copy a 3370-1 with 69750 pages to a 3370-2 with 89094 pages, the allocation map will indicate that only 69750 pages are allocated (even though the new volume has 89094 pages).

CPVOLUME will report such a mismatch. If you allow CPVOLUME to continue, the allocation map will be expanded from 69750 to 89094 pages. The expanded pages will be allocated as PERM space. The expanded pages will not be formatted with 0s as part of the expansion process. To format the expanded pages issue CPVOLUME FORMAT RANGE(69750,89093).

When data is copied from a large volume to a smaller volume, and pages 0 and 1 are included in the copy, the allocation map will map more pages than are on the volume.

Using the above example, the allocation map will indicate that 89094 pages are allocated, even though the new volume has only 69750 pages. CPVOLUME reports such a mismatch. If you allow CPVOLUME to continue, the allocation map is reduced from 89094 to 69750 pages. CPVOLUME eliminates the allocation information for the last 19344 pages.

Creating a minidisk allocation map

The allocation map that CPVOLUME creates for a minidisk will map the number of pages of the minidisk. For example, for a 100-page minidisk, CPVOLUME will create an allocation map that maps 100 pages. Likewise, CPVOLUME will not allow you to format or allocate pages beyond the bounds of the minidisk.

Examples of the CPVOLUME command

The following examples show different ways to code the CPVOLUME command. The device used in the examples is a 3370-1 with 69750 pages.

Formatting an entire volume

In this example, all 69750 pages on the volume are formatted. As READCHECK is specified, a read-back check is performed to verify that all of the formatted pages can be read without error. The allocation map indicates that all 69750 pages on the volume are allocated as PERM space.

Because NOVERIFY is specified, any existing volume label is ignored, and the volume is labelled 'ESARES'.

```
CPVOLUME FORMAT UNIT(0150) NOVERIFY VALID(ESARES) READCHECK
```

Formatting part of a volume

In this example, the first 100 pages on the volume are formatted. The allocation map indicates that pages 0 and 1 are PERM space, pages 2-99 are TEMP space, and pages 100-69749 are PERM space.

Because NOVERIFY is specified, any existing volume label is ignored, and the volume is labelled 'ESARES'.

```
CPVOLUME FORMAT UNIT(0150) NOVERIFY VALID(ESARES) RANGE(0,99) TYPE(TEMP,2,99)
```

Changing volume allocation

In this example, the allocation map on a volume that has already been formatted is updated. 9750 pages of previously formatted but unused space that had been allocated as PERM are given a new allocation of PAGE, to be used as paging disk space.

Because VERIFY is specified, CPVOLUME checks that the volume on unit address 150 has a volume label of 'FBACP1' before making any changes to the allocation map.

```
CPVOLUME ALLOCATE UNITADDRESS(150) VERIFY(FBACP1)-  
TYPE((PAGE,60000,69749))
```

Chapter 26. INIT command—FBA

VSE CMS SA

You use the INIT command to initialize volumes. For FBA devices, there are two levels of initialization.

1.

VSE

Minimal initialization or **minimal INIT** refers to using the INIT command to write the volume label and FBAVTOC on volumes for use by VSE operating systems.

For FBA devices, minimal INIT is recommended for:

- A new DASD unit
- Replaced or upgraded HDA
- A DASD unit that has been physically relocated

2. **Maximal initialization** or **maximal INIT** refers to using the INIT command to check the block surface, and then perform the minimal INIT. The maximal INIT is valid only for 3370, and 9335 FBA devices.

VM

Do not use the INIT command to perform a minimal INIT on volumes that are to be formatted for use in a VM environment. Use the CPVOLUME command instead.

For a general description of these levels of initialization, see Figure 1 on page 13 and “Formatting devices” on page 289.

For INIT support of minidisks see:

- “CMS version minidisk support” on page 319
- Chapter 5, “Getting started with the CMS version”

Syntax

INIT
Required Parameters SYSNAME(<i>sysxxx</i>) UNITADDRESS(<i>ccuu</i>) VERIFY(<i>serial</i> *NONE*[, <i>owner</i>]) NOVERIFY
Optional Parameters BLOCKRANGE(<i>start, end</i>) CHECK(<i>n</i>) NOCHECK CONTINUE NOCONTINUE FBAVTOC(END <i>rbn</i> [, <i>extent</i> [, <i>cisize</i>]]) LABELS(<i>n</i>) MAP NOMAP OWNERID(<i>owner</i>) PURGE NOPURGE RECLAIM NORECLAIM VOLID(<i>serial</i>)

Required parameters

SYSNAMEIUNITADDRESS parameter: identify the volume

Parameter/ Abbreviations	Description
SYSNAME(<i>sysxxx</i>)	Required to identify a VSE volume when executing ICKDSF in batch mode; the volume must be online. For <i>sysxxx</i> , specify the SYSNAME in the ASSGN system control statement.
UNITADDRESS(<i>ccuu</i>) UNITADDR UNIT	Required for a Stand-Alone or CMS version volume. For VSE, it is required when executing ICKDSF in command mode; the volume must be online. For <i>ccuu</i> , specify the address (3 or 4 hexadecimal digits) of the channel and unit of the volume. For the CMS version, specify the virtual address of the dedicated device or minidisk. The unit address is the device number.
Default:	None.
Restrictions:	None.

VERIFYINOVERIFY parameter: verify volser and ownerid

Parameter/ Abbreviations	Description
VERIFY(<i>serial[,owner]</i>) VFY	Required when you want to verify the volume serial number and owner identification before initializing the volume or minidisk. If the volume serial number or owner identification does not match that found on the volume or minidisk, INIT ends. For <i>serial</i> , substitute 1 to 6 alphanumeric characters for the volume serial number. To verify that a volume serial number does not exist, substitute the string *NONE* for <i>serial</i> . If no volume serial exists, or if the volume serial is actually "**NONE**", the INIT operation continues. If a volume serial exists, the INIT command ends. For <i>owner</i> , substitute 1 to 14 alphanumeric characters for the owner identification.
NOVERIFY NOVFY NVFY	Required when you want to bypass verification of the volume serial number.
Default:	None. You must specify either VERIFY or NOVERIFY.
Restrictions:	You cannot verify the owner identification separately from the volume serial number. Both the volume serial number and the owner identification must be verified when you want to verify the owner identification. When you specify the VERIFY parameter and verification fails, the command stops running.

Optional parameters

BLOCKRANGE parameter: specify part of the volume

Parameter/ Abbreviations	Description
BLOCKRANGE (<i>start,end</i>) BLKRANGE BLOCKR BLKR	Specifies that part of a volume is to be surface checked before medial initialization is performed. For <i>start,end</i> , specify the starting and ending relative block numbers to be verified. The values can be expressed in decimal or hexadecimal and must fall within the device limits. For device limits, see Table 55 on page 308.
Default:	All blocks.

Parameter/ Abbreviations	Description
Restrictions:	RECLAIM is not valid with BLOCKRANGE because RECLAIM must operate on the entire volume. Not valid for the IBM 0671, 9313, 9332, or 9336. Ignored for minidisks.

CHECKINOCHECK parameter: surface checking of the volume

Parameter/ Abbreviations	Description
CHECK(<i>n</i>) CHK	Indicates that maximal initialization is to take place. Each block is checked for recording errors during initialization. Each block is surface checked by writing and reading specially patterned records. This parameter destroys the contents of each block that it processes. If surface checking identifies a defective block, the block is flagged and an alternate is assigned. For <i>n</i> , substitute a decimal number from 1 through 10 for the number of times you want each block to be checked. For information on <i>n</i> values, see Appendix E, "Surface checking."
NOCHECK NOCHK NCHK	Indicates that you do not want the blocks to be surface checked for recording errors during minimal initialization.
Default:	NOCHECK
Restrictions:	The maximum number you can specify with the CHECK parameter is 10. CHECK is not valid for minidisks or for the IBM 0671, 9313, 9332, or 9336.

CONTINUEINOCONTINUE parameter: resume from a checkpoint

Parameter/ Abbreviations	Description
CONTINUE CONT	Resumes processing from the last checkpointed location. Issues a message indicating where processing is resumed.
NOCONTINUE NOCONT	Use when you do not want to start from the last checkpointed location, but want to start processing the specified range or full volume. Note that ICKDSF still goes to the backup location even if you issue NOCONTINUE. This is done to ensure no blocks are left in a nonstandard format.
Default:	CONTINUE
Restrictions:	These parameters are interrogated only if processing was previously interrupted during a maximal initialization. CONTINUE is not valid for the IBM 0671, 9313, 9332, or 9336. CONTINUE is ignored for minidisks.

FBAVTOC parameter: specify an FBAVTOC



INIT command—FBA

Parameter/ Abbreviations	Description
FBAVTOC(ENDI <i>rbn[,extent[,csize]]</i>) FBVTOC	<p>Specifies the starting location, number of label records, and control interval size of the volume table of contents (VTOC). For more information about the FBAVTOC, see Appendix D, “Fixed block architecture VTOC (FBAVTOC).”</p> <p>When you specify FBAVTOC(ENI), ICKDSF automatically determines the size and location of the VTOC. The VTOC is put on the last blocks of the volume or minidisk; it is 99 VTOC entries in length and has a control interval size of 1024.</p> <p>For <i>rbn</i>, substitute decimal (n) or hexadecimal characters (for example, X'2E') for the relative block number of the start of the VTOC.</p> <p>For <i>extent</i>, substitute decimal (n) or hexadecimal characters (for example, X'2E') for the number of label records in the VTOC. The valid range is from 3 to 999; however, the number you specify is rounded up to an integral multiple of the number of labels per control interval.</p> <p>For <i>csize</i>, substitute decimal (n) or hexadecimal characters (for example, X'E') for the size of the control interval in bytes. The value specified must be an integral multiple of the device's physical block size, and must not exceed a value of 8192.</p> <p>For FBAVTOC format and size calculations, see Appendix D, “Fixed block architecture VTOC (FBAVTOC).”</p>
Default:	FBAVTOC(2,56,1024)
Restrictions:	A VTOC cannot be placed at blocks 0 and 1, which are reserved for the IPL block and the volume label blocks (VLB), respectively.

LABELS parameter: reserve space for additional volume labels

Parameter/ Abbreviations	Description
LABELS(<i>n</i>) LABEL LBL	<p>Specifies that space on block 1 is to be reserved for additional volume labels, also known as user volume labels. In addition to the label that must be written on the volume or minidisk, a maximum of five additional volume labels can be specified.</p> <p>To specify n, substitute a decimal number from 1 through 5 for the number of additional user volume labels to be placed on the volume or minidisk during initialization.</p>
Default:	None.
Restrictions:	<p>If LABELS is not specified, user volume labels that existed from a previous initialization are destroyed.</p> <p>If a value greater than 5 is specified with the LABELS parameter, a message is printed, and the command continues.</p>

MAPINOMAP parameter: print an alternate block map

Parameter/ Abbreviations	Description
MAP	Prints an alternate block map during initialization. The alternate block map lists the primary blocks on the volume that have alternates assigned. The format of this map is the same as that printed by the MAPALT command when DETAIL is specified.
NOMAP	Indicates that you do not want to print a block map during initialization.
Default:	MAP
Restrictions:	MAP is not valid for the IBM 0671, 9313, 9332, 9336, or minidisks.

OWNERID parameter: specify the volume-owner identification

Parameter/ Abbreviations	Description
OWNERID(<i>owner</i>) OWNER	Writes the owner identification in the volume label. For <i>owner</i> , substitute 1 to 14 alphanumeric characters for the owner identification to be written in the volume label.
Default:	The default for <i>owner</i> during a first-time initialization is 14 blanks. If you do not specify OWNERID when reinitializing a previously initialized volume, the owner identification remains unchanged.
Restrictions:	None.

PURGEINOPURGE parameter: rewrite data on a volume

Parameter/ Abbreviations	Description
PURGE PRG	Indicates that you want to write over the data in the following types of data sets during initialization: Unexpired VSAM Data secured A volume that appears to contain real data cannot be initialized unless the PURGE parameter is specified.
NOPRG NPRG	Indicates that you do not want to write over existing data. If a volume appears to contain real data, it cannot be initialized unless the PURGE parameter is specified.
Default:	NOPURGE
Restrictions:	The NOPURGE parameter does not apply in the CMS or Stand-Alone versions. If you initialize a volume in the CMS or Stand-Alone version, all existing data on the volume is purged, regardless of the data set security attributes.

**RECLAIMINORECLAIM parameter: reclaim defective blocks**

Parameter/ Abbreviations	Description
RECLAIM RCLM	Indicates that you want to reclaim primary or alternate blocks that were flagged as defective in input but appear usable after surface checking. FBA device blocks that were flagged at the factory are not reclaimed. Should INIT RECLAIM not complete, defective primary blocks might remain that do not have valid alternate pointers. Any subsequent INIT forces the reclaim process to complete.
NORECLAIM NORCLM NRCLM	Indicates that you want to suppress block reclamation during initialization.
Default:	NORECLAIM
Restrictions:	The RECLAIM parameter applies only when the CHECK parameter has been specified. If RECLAIM is specified with NOCHECK, it will be ignored. RECLAIM is not valid with BLOCKRANGE because RECLAIM must operate on the entire volume. RECLAIM is not valid for the IBM 0671, 9313, 9332, 9335, 9336 devices, and minidisks.

VOLID parameter: specify the volume serial number

Parameter/ Abbreviations	Description
VOLID(<i>serial</i>)	Writes the volume serial number in the volume or minidisk label. For <i>serial</i> , substitute 1 to 6 alphanumeric characters for the volume serial number. If fewer than six characters are specified, the serial is left-justified, and the remainder of the field is padded with blanks (X'40').
Default:	When you initialize a volume or minidisk that was previously initialized and do not specify the VOLID parameter, the old volume serial number remains unchanged.
Restrictions:	When you initialize a volume or minidisk for the first time, you must specify the VOLID parameter or the INIT command ends.

Initializing a volume at the minimal level

Minimal initialization refers to using INIT NOCHECK to write the volume label and FBAVTOC on volumes for use by a VSE operating system. Note that minimal initialization does not delete any previous IPLTEXT that is on the volume.

The FBAVTOC parameter is used to specify the space for the VTOC for an FBA device. This parameter allows you to:

- Specify the starting block number
- Specify the number of label records
- Control the interval size of the VTOC

You can default the VTOC location, or you can have ICKDSF determine the size and location by specifying FBAVTOC(END). For more information about the FBAVTOC, see Appendix D, “Fixed block architecture VTOC (FBAVTOC).”

For the IBM 0671, 9313, 9332, 9336, and minidisks, you can perform a minimal initialization only.

Initializing a volume at the maximal level

Maximal initialization refers to using the INIT command to surface check each block for recording errors and assign alternate blocks to those with errors, and perform the minimal initialization. The CHECK parameter is specified at the maximal level. Maximal initialization is valid only for 3370 and 9335 devices. Maximal initialization is not valid for minidisks.

If you specify RECLAIM with CHECK, an attempt is made to reclaim the primary surface of blocks that have had alternates assigned previously by INIT or INSPECT. Any blocks that were previously marked defective but pass the surface checking test in this run are marked available. However, any primary or alternate blocks that were flagged defective by the factory will not be reclaimed by the INIT command. RECLAIM support is not valid for the 9335.

If a maximal initialization does not run to completion, use CONTINUE to recover in a minimum amount of time and ensure the volume is usable. For more information about continuing after a failure, see “Resuming after a job or system failure” on page 319.

Resuming after a job or system failure

If a maximal initialization does not run to completion for any reason, the job does not need to be restarted from the beginning of the volume. ICKDSF checkpoints itself automatically during processing and can determine where it is to resume.

After a job or system failure, you can submit a new job:

- At the minimal or maximal level
- For the entire volume, for a different specified range, or for the same specified range (maximal INIT)
- To resume from the point of failure or to resume from the start of the current specified range (the job which was running when the job or system failed)

Because INIT processing always destroys the volume label, when you issue INIT again, you must include the VOLID parameter.

After a previous failure, if CONTINUE is specified, processing continues from the point of failure in correlation with the current specified range as follows:

- If the new range is entirely before the previous point of failure, no new blocks are processed.
- If the new range is entirely beyond the point of failure, then the entire new range is processed.
- If the new range specification overlaps the point of failure, then processing begins from the point of failure.
- If NOCONTINUE is specified, processing begins from the current specified range.
- If the previous INIT specified RECLAIM:
 - If processing failed during the actual reclaim procedure, processing starts from the beginning of the reclaim procedure and runs for the entire volume.
 - If processing failed after the actual reclaim procedure was complete, processing begins from the continue location, but is forced to the end of the volume, to ensure that RECLAIM has processed to completion.

CMS version minidisk support

CMS

For the CMS version of ICKDSF, only minimal INIT is supported for minidisks.

When you initialize a minidisk at the minimal level, you can specify the minidisk volume label (VOLID), the VTOC, and the owner identification (OWNERID).

The UNITADDRESS, FBAVTOC, LABELS, MAP, OWNERID, VERIFY, and VOLID parameters are supported by the CMS Version.

For more information about running the CMS version, see Chapter 5, “Getting started with the CMS version,” on page 39.

Examples of the INIT command

The following examples show different ways to code the INIT command.

Any values specified here are examples only and should not necessarily be interpreted as the values for your system.

Initializing volumes with the Stand-Alone version

SA

The following examples show you how to initialize volumes with the Stand-Alone version of ICKDSF.

Initializing a volume at the minimal level

In this example, a FBA device is initialized at a minimal level. The volume is labeled 331022. The owner ID of SMITH is written in the volume label. Space is reserved for three additional user volume labels starting at block 1, and a FBAVTOC starting at block 2 for 100 label records with a VTOC control interval size of 512. NOMAP suppresses the list of alternates.

```
INIT UNITADDRESS(02E4) NOVERIFY NOCHECK VOLID(331022) -
  OWNERID(SMITH) LABELS(3) FBAVTOC(2,100,512) NOMAP
```

Initializing a minidisk

In this example, a FBA 3370 minidisk is initialized in the Stand-Alone version. The volume ID and owner ID are checked. Space is reserved for a FBAVTOC starting at block 2 for 100 label records with a VTOC control interval size of 512. The volume is labeled 337019. Space is reserved for 3 user volume labels. The size of the minidisk is obtained from VM.

```
INIT UNITADDRESS(0151) VERIFY(337022,PSMITH) -
  FBAVTOC(X'2',X'64',X'200') VOLID(337019) LABELS(3)
```

Initializing a VSE version FBA volume

VSE

In this example, a FBA device is initialized at the maximal level by specifying CHECK and VERIFY. The volume serial and owner ID are verified before initialization begins. Surfaces are checked and, if any blocks are found to be defective, alternate blocks are assigned. An FBAVTOC is located starting at block 2 for 100 label records with a VTOC control interval size of 1024. MAP specifies that a detailed map is to be printed. Any blocks that were previously flagged defective but now appear to be usable after surface checking are reclaimed.

```
// JOB      jobname
// ASSGN    SYS005,353
// EXEC     ICKDSF,SIZE=AUTO
          INIT SYSNAME(SYS005) VERIFY(337011,JONES) CHECK(3) -
            FBAVTOC(2,100,1024) MAP RECLAIM
/*
/&
```

Initializing a minidisk in the CMS version for a VSE environment

CMS

In this example, a minidisk is initialized at the minimal level. It establishes a VOLID, OWNERID, and the VSE VTOC on a minidisk with a virtual address of 391. The minidisk is labeled 337012 and the owner ID is PAYROLL.

After performing the INIT, the minidisk is ready for future use in an VSE operating system environment.

```
INIT UNITADDRESS(0391) NOVERIFY VOLID(337012) OWNERID(PAYROLL) FBAVTOC(END)
```

INIT command—FBA

Chapter 27. INSPECT command—FBA

VSE

CMS

SA

The INSPECT command inspects a subset of a volume and can:

- Check the surface of a block to determine if there is a defect
- Assign an alternate block
- Print a map of defective blocks on a volume

Before using the INSPECT command, ensure that there are no hardware problems. It is recommended that you issue ANALYZE DRIVETEST NOSCAN before any INSPECT operation.

For more general information about INSPECT, see “Problem determination” on page 290.

Warning

Use caution when running INSPECT against an entire or major portion of a FBA volume. It can be time-consuming.

Understanding which INSPECT parameters to use

You can perform several functions using INSPECT with various options. Table 56 shows you which parameters to use to perform certain tasks. For more details about these parameters, see the explanations that follow. The parameters appear in alphabetical order under “Optional parameters” on page 325.

Table 56. Performing tasks with INSPECT parameters

To...	Use the INSPECT parameter...
Identify the blocks you want to inspect.	BLOCKS BLOCKRANGE
Check each block surface. Permit optional specification of the number of checking cycles of each inspected block.	CHECK Alternate block assignment is done only after an inspection of the surface reveals defects.
Suppress block checking	NOCHECK Unless alternate block assignment is suppressed, an alternate will be unconditionally assigned to the primary block. For the IBM 0671, 9313, 9332, and 9336, you can only unconditionally assign alternate blocks. (INSPECT ASSIGN NOCHECK BLOCKS)

INSPECT command—FBA

Table 56. Performing tasks with INSPECT parameters (continued)

To...	Use the INSPECT parameter...
Save data that would normally be destroyed during block inspection.	<p>PRESERVE KEEPIT HOLDIT</p> <p>The NOPRESERVE parameter allows inspection of blocks when the data cannot be read.</p> <p>For the IBM 0671, 9313, 9332, and 9336 PRESERVE, KEEPIT, and HOLDIT are all processed as HOLDIT. The data is lost if processing ends before the data is rewritten.</p> <p>Data Loss Warning:</p> <p>When you use HOLDIT, data is kept in storage only. If processing abnormally terminates before the data is rewritten, the block for which the data was preserved will not contain a standard record 0; and the data will be lost.</p>
Write a copy of the data at a backup location as well as keep it in storage.	<p>PRESERVE</p> <p>If processing abnormally terminates, the next use of INSPECT detects the data at the backup location and automatically restores the data to the block on which processing previously ended abnormally.</p>
Assign alternates if required.	ASSIGN
Suppress the assignment of alternates	NOASSIGN
Print output of the detailed status of each block being inspected.	MAP
Suppress the printed output of detailed block status.	NOMAP

Syntax

INSPECT
<p>Required Parameters</p> <p>SYSNAME(<i>sysxxx</i>) UNITADDRESS(<i>ccuu</i>) REALADDR(<i>ccuu</i>) VERIFY(<i>serial</i>*NONE*[<i>owner</i>]) NOVERIFY</p>
<p>Optional Parameters</p> <p>ASSIGN NOASSIGN BLOCKRANGE(<i>start,end</i>) BLOCKS(<i>rbn</i>[,...]) CHECK(<i>n</i>) NOCHECK MAP NOMAP PRESERVE KEEPIT HOLDIT NOPRESERVE USERID(<i>user's ID</i>)</p>

Required parameters

SYSNAME|UNITADDRESS|REALADDR parameter: identify the volume

Parameter/Abbreviations	Description
SYSNAME(<i>sysxxx</i>)	Required to identify a VSE volume when executing ICKDSF in batch mode; the volume must be online. For <i>sysxxx</i> , specify the SYSNAME in the ASSGN system control statement.

Parameter/ Abbreviations	Description
UNITADDRESS(<i>ccuu</i>) UNITADDR UNIT	<p>Required for a Stand-Alone or CMS version volume. For VSE, it is required when executing ICKDSF in command mode; the volume must be online.</p> <p>For <i>ccuu</i>, specify the address (3 or 4 hexadecimal digits) of the channel and unit of the volume.</p> <p>For the CMS version, specify the virtual address of the dedicated device or minidisk.</p> <p>The unit address is the device number.</p>
REALADDR(<i>ccuu</i>) RADDR CMS	<p>Used to specify the real address of a volume. This parameter is valid only when you are running the CMS version of ICKDSF and you have DEVMAINT authority. For <i>ccuu</i>, specify the real address (3 or 4 hexadecimal digits) of the channel and unit of the volume.</p> <p>REALADDR is mutually exclusive with UNITADDRESS, SYSNAME, and USERID.</p>
Default:	None.
Restrictions:	The maximum number of blocks that you can INSPECT using REALADDR is 1.

VERIFY/NOVERIFY parameter: verify volser ownerid

Parameter/ Abbreviations	Description
VERIFY(<i>serial[,owner]</i>) VFY	<p>Required when you want to verify the volume serial number and owner identification before inspecting the volume or minidisk. If the volume serial number or owner identification does not match that found on the volume or minidisk, INSPECT ends.</p> <p>For <i>serial</i>, substitute 1 to 6 alphanumeric characters for the volume serial number.</p> <p>To verify that a volume serial number does not exist, substitute the string *NONE* for <i>serial</i>. If no volume serial exists, or if the volume serial is actually “*NONE*”, the REFORMAT operation continues. If a volume serial exists, the REFORMAT command ends.</p> <p>For <i>owner</i>, substitute 1 to 14 alphanumeric characters for the owner identification.</p>
NOVERIFY NOVFY NVFY	Required when you want to bypass verification of the volume serial number.
Default:	None. You must specify either VERIFY or NOVERIFY.
Restrictions:	<p>You cannot verify the owner identification separately from the volume serial number. Both the volume serial number and the owner identification must be verified when you want to verify the owner identification.</p> <p>When you specify VERIFY, the volume label must exist for the volume.</p>

Optional parameters

ASSIGN/NOASSIGN parameter: specify assignment of alternate blocks

Parameter/ Abbreviations	Description
ASSIGN ASGN	Indicates that you want alternates to be assigned when defective primary and assigned alternate blocks are detected.
NOASSIGN NOASGN NASGN	Indicates that you do not want alternate blocks assigned. If PRESERVE is specified and user data cannot be rewritten because of surface defects, an alternate is assigned.
Default:	ASSIGN

INSPECT command—FBA

Parameter/ Abbreviations	Description
Restrictions:	<p>If NOASSIGN is specified with the CHECK parameter, an inspected block is not marked defective and an alternate is not assigned.</p> <p>The combination of ASSIGN NOCHECK cannot be specified with the BLOCKRANGE parameter..</p>

BLOCKRANGE|BLOCKS parameter: specify which blocks to inspect

Parameter/ Abbreviations	Description
BLOCKRANGE (<i>start,end</i>) BLKRRANGE BLOCKR BLKR	<p>Specifies that part of a volume is to be inspected before the volume is processed.</p> <p>For <i>start,end</i>, specify the starting and ending relative block numbers to be verified. The values can be expressed in decimal or hexadecimal and must be within the device limits. For device limits, see Table 55 on page 308.</p>
BLOCKS(<i>rbn[,...]</i>) BLOCK	<p>Specifies each discrete block to be inspected.</p> <p>For <i>rbn</i>, substitute the relative block number of each block to be inspected. Specify the block numbers in decimal or hexadecimal.</p>
Default:	None.
Restrictions:	<p>BLOCKS and BLOCKRANGE are mutually exclusive.</p> <p>BLOCKRANGE is not valid with ASSIGN NOCHECK.</p> <p>BLOCKRANGE is not valid for the IBM 0671, 9313, 9332, or 9336.</p> <p>The number of blocks specified by the <i>rbn</i> of the BLOCKS parameter cannot exceed 20.</p> <p>The maximum range of blocks that can be specified in the BLOCKRANGE parameter is 80,000.</p> <p>Maximum block numbers for FBA devices are shown in Table 55 on page 308.</p> <p>When you are processing minidisks under the CMS version, if you specify the USERID parameter you can INSPECT the whole minidisk. If you specify the REALADDR parameter, the maximum you can INSPECT is 1 block.</p>

CMS

CHECKINOCHECK parameter: surface checking of the volume

Parameter/ Abbreviations	Description
CHECK(<i>n</i>) CHK	<p>Indicates that each block is to be checked for recording errors. Each block is surface checked by writing and reading specially patterned records.</p> <p>If surface checking identifies a defective block, the block is flagged and an alternate is assigned.</p> <p>For <i>n</i>, substitute a decimal number from 1 through 10 for the number of times you want each block to be checked. For information about <i>n</i> values, see Appendix E, "Surface checking."</p>
NOCHECK NOCHK NCHK	<p>Indicates that you do not want the blocks to be surface checked for recording errors during inspection. Alternate blocks are unconditionally assigned as a result of inspection when NOCHECK and ASSIGN are specified.</p>
Default:	CHECK(1)
Restrictions:	<p>The maximum number you can specify with the CHECK parameter is 10.</p> <p>CHECK is not valid for the IBM 0671, 9313, 9332, or 9336.</p>

MAPINOMAP parameter: print an alternate block map

Parameter/ Abbreviations	Description
MAP	Prints an alternate block map during inspection. The alternate block map lists inspected blocks on the volume that have alternates assigned. The format of this map is the same as that printed by the MAPALT command when DETAIL is specified.
NOMAP	Indicates that you do not want to print a block map during initialization.
Default:	MAP
Restrictions:	MAP is not valid for the IBM 0671, 9313, 9332, 9336, or minidisks.

PRESERVEKEEPITHOLDITINOPRESERVE parameter: preserve data

Parameter/ Abbreviations	Description
PRESERVE PRSV	Saves the data on the inspected blocks. Saves a copy of each block at a backup location as well as in storage (the storage copy is used to rewrite the data). If processing abnormally terminates on a block, INSPECT detects the data at the backup location and automatically restores the data to that block. For more detailed information, see “Reading and saving data on inspected blocks.”
KEEPIT KEEP	PRESERVE and KEEPIT are synonymous.
NOPRESERVE NOPRSV NPRS	Indicates that you do not want to save the data on the inspected blocks. NOPRESERVE always destroys the current contents of the block: <ul style="list-style-type: none"> • If you specify CHECK, or • If you specify ASSIGN NOCHECK (the ASSIGN NOCHECK combination of parameters specifies unconditional assignment of alternate blocks). <p>Use NOPRESERVE only when the data is nonexistent or unnecessary, or if data errors on a particular block make it impossible to preserve the data.</p> <div style="background-color: black; color: white; padding: 2px; display: inline-block;">VSE</div> Note that the VTOC can also be destroyed. Be careful when inspecting a volume in a VSE environment.
HOLDIT HOLD	Indicates that you want to save the data on the inspected blocks. HOLDIT reads the data and keeps a copy in storage only. If processing for the block does not run to completion, the data is lost and must be restored from a backup copy.
Default:	PRESERVE
Restrictions:	For the IBM 0671, 9313, 9332, 9336, and minidisks, the PRESERVE, KEEPIT, and HOLDIT parameters are processed as HOLDIT.

Reading and saving data on inspected blocks

PRESERVE and KEEPIT specify whether to read and save the data on the inspected blocks. Data read from the specified blocks is held in storage.

Data on a block is also saved at a backup location as well as held in storage (the storage copy is used to rewrite the data). If processing abnormally terminates, the next use of INSPECT detects the data at the backup location and restores the data to the block where processing ended abnormally.

For the IBM 0671, 9313, 9332, 9336, and minidisks, the PRESERVE, KEEPIT, and HOLDIT parameters are processed as HOLDIT.

Writing data from a backup location with PRESERVE or KEEPIT

The backup location and the storage copy of the block are erased at the completion of a command.

You might notice a performance degradation caused by the writing of the data at the backup location. The time duration of degradation depends on the total number of blocks being processed for the current INSPECT.

INSPECT command—FBA

When the data is written at the backup location, it is read-back-checked to ensure it was written correctly. However, when the backup location is used to restore the data at the next use of the INSPECT command, there is no guarantee that the data can be recovered.

Writing data from a CE cylinder

For devices that use the CE cylinder as the backup cylinder, if data exists at the backup location, the ANALYZE command, which writes on the CE cylinder, does not destroy the data. ANALYZE does indicate the cylinder and head of the block for which data exists. **Note, however, that the CE microdiagnostics may destroy the data at the backup location.**

Therefore, if INSPECT processing does not complete because of a problem on the volume that requires the assistance of an IBM customer engineer, make every attempt to restore the data first, if necessary.

USERID parameter: specify another user's minidisk



Parameter/ Abbreviations	Description
USERID(<i>user's ID</i>) UID	Performs the INSPECT command on another user's minidisk. For <i>user's ID</i> , substitute the 1 to 8 characters of the ID of the user whose minidisk you want to verify. For more information about processing minidisks, see Chapter 5, "Getting started with the CMS version."
Default:	If USERID is not specified, your own minidisk is verified.
Restrictions:	USERID can be specified only if you are using the CMS version of ICKDSF and have DEVMAINT authority. USERID is ignored in all other system environments. When you specify the USERID parameter, you can INSPECT the whole minidisk.

Assigning alternate blocks

A block can be flagged as defective and an alternate assigned either conditionally or unconditionally. The amount of surface checking done before an alternate is assigned is determined by multiple factors, including:

- The use of the CHECK or NOCHECK parameter
- The availability of skip displacement bytes for the device type
- The current condition of the block

Table 57 shows you how to control the assignment of alternate blocks. The parameter explanations appear in alphabetical order under "Optional parameters" on page 325.

Table 57. Assigning alternate blocks with INSPECT parameters

To...	Use the INSPECT parameters...
Detect defective blocks and assign an alternate block if the block is defective.	CHECK and ASSIGN
Unconditionally assign alternate blocks for the blocks specified.	NOCHECK and ASSIGN
Inspect primary and alternate blocks, but prevent assignment of alternates.	CHECK and NOASSIGN

Table 57. Assigning alternate blocks with INSPECT parameters (continued)

To...	Use the INSPECT parameters...
Assign an alternate block when data cannot be rewritten because of defects, regardless of the ASSIGNINOASSIGN value.	PRESERVE

Preserving data during INSPECT

When you specify the PRESERVE or KEEPIT parameter of the INSPECT command, a backup copy of the data is stored on the same volume and in storage. The backup location uses two blocks on the CE cylinder. One block (the backup block) contains the control information, and another block (the preserve block) contains the actual data.

If processing terminates abnormally, the next use of INSPECT will:

1. Detect the data at the backup location, and determine the block to be recovered (the recovery block).
2. Surface check the block to be restored. If a data check is detected, skip displacement surface checking is performed.
3. Restore the data from the preserve block.

The restoration of the block from the preserved data is automatic and is independent of the range specified in the current job. When you run INSPECT without specifying any blocks, only the restore function is performed.

Writing data from a backup or storage location

INSPECT allows you to choose from two levels of data preservation:

HOLDIT—Keeps a copy of the data from the block being processed in storage only. No copy is kept at the backup location.

PRESERVE or KEEPIT—Writes a copy of the data from the block being processed at the backup location as well as in storage. The copy at the backup location is used only during the restore procedure. The backup location and the copy of the data in storage are erased at the completion of the command.

When PRESERVE|KEEPIT is specified, you might notice a performance degradation caused by the writing of the data at the backup location. The time duration of degradation depends on the total number of blocks being processed by the current INSPECT command.

For the IBM 0671, 9313, 9332, and 9336, the PRESERVE, KEEPIT, and HOLDIT parameters are processed as HOLDIT. The data is lost if processing abnormally terminates before the data is rewritten.

Retrieving data from the backup location

When data is written at the backup location, it is read-back-checked to ensure it was written correctly. However, at the time of recovery, **it cannot be guaranteed that the data is always retrievable from the backup location.**

Warning

Although the backup block and the preserve block are located on the CE cylinder, the ANALYZE command, which writes on the CE cylinder, does not destroy the data. ANALYZE does indicate the cylinder and head of the block for which data exists. **Note, however, that the CE microdiagnostics may destroy the data at the backup location.**

Therefore, if INSPECT processing does not complete because of a problem on the volume that requires the assistance of an IBM customer engineer, make every attempt to restore the data first, if necessary.



When you are processing minidisks under the CMS version, data is not saved at the backup location. Therefore, no recovery of data is possible.

Recovering data after a job or system failure

If an INSPECT command ends before completing, and PRESERVE was specified on the failing job, ICKDSF has saved the data, and it will be automatically recovered on the next use of the INSPECT command.

After resolving the reason for the failure, you can submit:

- The same INSPECT job.

This will do a primary surface check of the block being processed at the time of failure, recover the data, and then inspect all the blocks in the specified range, including those blocks that were inspected prior to the previous failure.

- An INSPECT job for a entirely different, or partially different, range.

This will do a primary surface check of the block being processed at the time of failure, recover the data, and then process all blocks in the new range.

- An ANALYZE job (for nonemulated nonremovable media devices only) to determine the block that failed.

ANALYZE will print the cylinder and head of the block that is being processed at the point of failure.

Then you can run a new INSPECT job with a modified range according to the previous point of failure.

This will do a primary surface check of the block being processed at the time of failure, recover the data, and then process all blocks in the new range.

- Enter an INSPECT with neither BLOCKS nor BLOCKRANGE specified.

This will do a primary surface check of the block being processed at the time of failure, and recover the data.

Notes:

- Recovery is only possible if PRESERVE was specified on the job running at the time of failure. It is not possible if HOLDIT or NOPRESERVE were specified.
- It is possible that INSPECT was “between blocks” when the job failed, and there is no block or data to recover.
- The data at the recovery block may be invalid. In this case, in addition to the data being unavailable, the block may be unusable to the operating system and any use of the block can cause I/O errors.

- If you run INIT on this volume before the next INSPECT, INIT will erase the recovery data.
- The restore function is not optional. If data exists at the backup location it is restored.
If the data on the preserve block is different than the data on the block being restored (that is, the block being processed at the point of failure), the operator is prompted either to restore or erase the data.
- If the data cannot be restored, for whatever reason, the operator is prompted for the next action.
To put the restore data in storage, you can run a job that specifies HOLDIT.
- When you are processing minidisks under the CMS version, data is not saved at the backup location. Therefore, no recovery of data is possible.

CMS version minidisk support

CMS

The following parameters are valid only when you are using the CMS version of ICKDSF and have DEVMAINT authority (as defined in the CP directory):

USERID: With DEVMAINT authority you can use the USERID parameter to inspect another user's minidisk. The following parameters are valid:

ASSIGNINOASSIGN, BLOCKRANGEIBLOCKS, CHECKINOCHECK, HOLDIT, MAPINOMAP, PRESERVEINOPRESERVE VERIFYINOVERIFY, and UNITADDRESS.

REALADDR: With DEVMAINT authority you can use the REALADDRESS parameter to INSPECT a volume using the real device address. All of the other parameters listed above are valid. The maximum number of blocks you can INSPECT in this mode is one.

For more information, see Chapter 5, "Getting started with the CMS version."

Examples of the INSPECT command

The following examples show different ways to code the INSPECT command.

Any values specified here are examples only and should not necessarily be interpreted as the values for your system.

Inspecting volumes with the Stand-Alone version

SA

The following examples show you how to inspect volumes with the Stand-Alone version of ICKDSF.

Inspecting for defective blocks

In this example, an FBA device is inspected for defective blocks. It provides surface checking of the blocks specified in the BLOCKS parameter and conditional assignment of alternate blocks for any blocks that are found defective. The data on the inspected blocks is preserved. A detailed map of the inspected blocks is printed.

INSPECT command—FBA

```
INSPECT UNITADDRESS(0150) BLOCKS(50,55,57,58) CHECK(1) -  
ASSIGN PRESERVE MAP NOVERIFY
```

In this example, an FBA device that has already been initialized is inspected for defective blocks. The blocks specified in the BLOCKS parameter are surface checked for errors, but an inspected block is not marked defective and an alternate is not assigned.

```
INSPECT UNITADDRESS(02E4) BLOCKS(2000,2020,2021,2022) -  
CHECK(1) NOASSIGN NOMAP NOVERIFY
```

Unconditional alternate block assignment

In this example, an inspection is performed on an FBA device that has already been initialized. The blocks specified in the BLOCKS parameter are unconditionally assigned the next available alternate blocks.

```
INSPECT UNITADDRESS(0380) BLOCKS(X'FA',X'10E',X'118') -  
NOVERIFY NOCHECK ASSIGN
```

Inspecting volumes with the VSE version

VSE The following examples show you how to inspect volumes with the VSE version of ICKDSF.

Unconditionally assigning alternate blocks

In this example, an FBA volume previously initialized under VSE is inspected. The specified blocks are unconditionally assigned the next available blocks. PRESERVE specifies that data is to be saved at the backup location as well as in storage.

```
// JOB      jobname  
// ASSGN   SYS010,151  
// EXEC    ICKDSF,SIZE=AUTO  
INSPECT SYSNAME(SYS010) NVFY BLOCKS(100,200,300) -  
NOCHECK ASSIGN PRESERVE NOMAP  
/*  
/&
```

Inspecting an FBA volume to check blocks for defects

In this example, an FBA volume previously initialized under VSE is inspected. It provides surface checking of the specified blocks and conditional assignment of alternate blocks that are found defective. PRESERVE specifies that data is to be saved at the backup location as well as in storage. A detailed map of the inspected blocks is included.

```
// JOB      jobname  
// ASSGN   SYS010,151  
// EXEC    ICKDSF,SIZE=AUTO  
INSPECT SYSNAME(SYS010) NVFY BLOCKS(50,60,70) -  
CHECK(1) ASSIGN PRESERVE MAP  
/*  
/&
```

Inspecting volumes with the CMS version

CMS

The following examples show you how to inspect volumes with the CMS version of ICKDSF.

Inspecting another user's minidisk

In this example, a minidisk that is owned by a another user is inspected. You specify the USERID parameter to inspect the minidisk of a user named BROWN at virtual address 391. You must have DEVMAINT authority to specify USERID.

Blocks 50 and 55 of the minidisk are inspected. If the inspected block is defective, an alternate is assigned.

```
INSPECT UNITADDRESS(0391) NOVERIFY USERID(BROWN) BLOCKS(50,55)
```

Inspecting a minidisk specifying a real address

In this example, part of a volume with a real address of 290 is inspected. You must have DEVMAINT authority to specify REALADDR.

Block 1000 is inspected. If the inspected block is defective, an alternate is assigned.

```
INSPECT REALADDR(290) NOVERIFY BLOCKS(1000)
```

INSPECT command—FBA

Chapter 28. IODELAY command—FBA

VSE CMS SA

ICKDSF issues very intensive I/O during processing. Sometimes this can degrade the performance of other users accessing the channel and impact your entire system throughput. The IODELAY command slows down ICKDSF processing by allowing time between I/O rather than issuing consecutive I/O operations.

The IODELAY command allows you to specify:

- The number of consecutive I/Os that ICKDSF can issue
- The allowable time period between those I/Os

When ICKDSF is issued, the time delay is set to zero (same as current processing). Once you set the time delay using the IODELAY command, it remains set until you reset it.

Syntax

IODELAY
Required Parameters SETIRESET
Optional Parameters PERIO(<i>n</i>) SECONDS(<i>n</i>)IMSECONDS(<i>n</i>)IUSECONDS(<i>n</i>)

Required parameters

SETIRESET parameter: set an I/O delay

Parameter/ Abbreviations	Description
SET	Used to set a time delay which will apply to all ICKDSF functions.
RESET	Used to reset the time delay. After issuing RESET, there is no time delay in effect.
Default:	None.
Restrictions:	None.

Optional parameters

PERIO parameter: number of I/Os scheduled

Parameter/ Abbreviations	Description
PERIO(<i>n</i>)	Allows you to specify the number of I/Os to be scheduled between each time delay. The number specified here is the number of I/Os ICKDSF will schedule before it will quiesce and allow other functions to gain control. Specify <i>n</i> as the number of I/Os (1 to 1000) allowed before the time interval is reactivated.
Default:	If PERIO is not specified with SET, PERIO defaults to 1.
Restrictions:	None.

SECONDSIMSECONDSIUSECONDS parameter: set the time period

Parameter/ Abbreviations	Description
SECONDS(<i>n</i>) SEC	Specifies the amount of time in seconds, which is allowed between ICKDSF issuing I/Os. Specify <i>n</i> as the number of seconds (1 to 60) delay.
MSECONDS(<i>n</i>) MSECOND MILLI MSEC	Specifies the amount of time in milliseconds, which is allowed between ICKDSF issuing I/Os. Specify <i>n</i> as the number of milliseconds (1 to 1000) delay.
USECONDS(<i>n</i>) USECOND MICRO USEC	Specifies the amount of time in microseconds, which is allowed between ICKDSF issuing I/Os. Specify <i>n</i> as the number of microseconds (1 to 1000) delay.
Default:	None.
Restrictions:	<div style="display: flex; align-items: center;"> <div style="background-color: black; color: white; padding: 2px 5px; margin-right: 5px;">CMS</div> <div> <p>Under the CMS version, an I/O delay time of less than 1 second might excessively use your processor. Because of this, use the PERIO and SECOND parameters together, instead of the MSECONDS or USECONDS parameters. For example, if you want to delay I/O every tenth of a second, issue:</p> <pre>IODELAY SET PERIO(10) SECONDS(1)</pre> </div> </div>

Examples of the IODELAY command

Any values specified here are examples only and should not necessarily be interpreted as the values for your system.

Delaying 100 ms after every 20 operations

In this example, the IODELAY command is used to set a delay of 100 ms after every 20 ICKDSF I/O operations. This allows functions other than ICKDSF to perform during this delay. The IODELAY command is followed by the ANALYZE command, which has a delay of 100 ms after every 20 ICKDSF I/O operations while it is processing. The second IODELAY command resets the delay. The next ICKDSF command issued would not have any delay set.

```
IODELAY SET PERIO(20) MILLI(100)
ANALYZE UNITADDRESS(ccuu) SCAN
IODELAY RESET
```

Chapter 29. MAPALT command—FBA



The MAPALT command performs the following functions:

- Maps alternate block assignments.
- Produces a printed report, or map, of the primary blocks that have been assigned to alternate blocks on the device.
- Allows you to specify that a limited range of primary blocks or the entire volume be mapped.

You can run MAPALT against either a newly installed device or a device that already contains user data. You do not need to create backup copies of the data on the volume before issuing the command.

The MAPALT command can read the identification fields of the primary blocks only.

You can use the MAPALT command only against the device address that defines the entire device in fixed block mode.

MAPALT does not support:

- Emulated devices on FBA devices
- The IBM 0671, 9313, 9332, and 9336

CMS When you are using the CMS version of ICKDSF, the MAPALT command is valid only with dedicated devices. There is no minidisk support. For more information, see Chapter 5, “Getting started with the CMS version.”

Syntax

MAPALT
Required Parameters SYSNAME(<i>sysxxx</i>) UNITADDRESS(<i>ccuu</i>)
Optional Parameters DETAIL NODETAIL LIMITS(<i>start,end</i>) ALL

Required parameters

SYSNAME|UNITADDRESS parameter: identify the volume

Parameter/ Abbreviations	Description
SYSNAME(<i>sysxxx</i>)	Required to identify a VSE volume when executing ICKDSF in batch mode; the volume must be online. For <i>sysxxx</i> , specify the SYSNAME in the ASSGN system control statement.
UNITADDRESS(<i>ccuu</i>) UNITADDR UNIT	Required for a Stand-Alone version volume. For VSE, it is required when executing ICKDSF in command mode; the volume must be online. For <i>ccuu</i> , specify the address (3 or 4 hexadecimal digits) of the channel and unit of the volume. The unit address is the device number.
Default:	None.

MAPALT command—FBA

Parameter/ Abbreviations	Description
Restrictions:	None.

Optional parameters

DETAILINODETAIL parameter: controlling the program output

Parameter/ Abbreviations	Description
DETAIL DTL	Prints a detailed report that lists each defective block assigned to an alternate, its location on the disk, and the location of the assigned alternate block.
NODETAIL NODTL	Suppresses printing of the detailed report.
Default:	NODETAIL
Restrictions:	This parameter controls printing of the detailed report only and does not affect other output from the program. The summary message will always print when the program ends.

LIMITSIALL parameter: specify the area to be mapped

Parameter/ Abbreviations	Description
LIMITS(<i>start,end</i>) LIMIT LIMS LIM	Specifies the area of the disk where you want alternate block mapping performed. For <i>start,end</i> , specify the relative block number for the start and end of mapping. <i>start</i> must be less than or equal to <i>end</i> . The values can be expressed in decimal or hexadecimal and must be within the device limits. For device limits, see Table 55 on page 308.
ALL	Maps the entire volume.
Default:	ALL
Restrictions:	None.

Reading the MAPALT report output

A two-part report is produced.

1. The first part, which is optional, is shown in Table 58:

Table 58. MAPALT report (first part)

Primary Block Number	Block Address	Alternate Address
nnnnnnnn	C=nnn H=nn	C=nnn H=nn
nnnnnnnn	C=nnn H=nn	C=nnn H=nn
nnnnnnnn	C=nnn H=nn	C=nnn H=nn
nnnnnnnn	C=nnn H=nn	C=nnn H=nn
nnnnnnnn	C=nnn H=nn	C=nnn H=nn

This detailed report shows:

- The relative block number of the defective primary block
- The defective primary block location on the volume (cylinder and head number)
- The location of the alternate block that has been assigned to the primary (also in cylinder and head number)

Depending on the device type, the primary and alternate block addresses can be the same on this report.

- The second part of the report, which is always printed, is a summary message. It shows the number of blocks (within the specified range) found assigned to alternates.

MAPALT diagnostic output

The program reports any I/O errors that interrupt it. The following information appears on the program output when such errors occur:

```
CSW = xxxxxx xxxxxx CCW = xxxxxxxx xxxxxxxx
SENSE = xxxxxxxx xxxxxxxx xxxxxxxx xxxxxxxx
xxxxxxx xxxxxxxx
```

This information should be used, in accordance with installation procedures, as an aid in isolating and correcting the cause of the problem.

If a data check is encountered, an error message is printed giving the relative block number of the block causing the error. Processing then continues with the next sequential block.

Examples of the MAPALT command

The following examples show ways you might code the MAPALT command in various situations.

Mapping volumes with the Stand-Alone version



The following examples show you how to map volumes with the Stand-Alone version of ICKDSF.

Mapping a full volume

In this example, a full volume scan of a 3370 direct access storage volume is performed and a summary report is made of the total number of blocks found that have alternates assigned.

```
MAPALT UNITADDRESS(0141) ALL NODETAIL
```

Using abbreviations and defaults, you could also have specified:

```
MAPALT UNIT(0141)
```

Mapping a range of blocks in a volume

In this example, the range of blocks from 200,000 to 300,000 on a 3370 direct access storage volume is scanned. A detailed report is made of each block within that range that has an alternate assigned, and a summary report is made giving the total number of assigned alternates found.

```
MAPALT UNITADDRESS(0142) LIMITS(200000,300000) DETAIL
```

Using abbreviations, you could have specified:

```
MAPALT UNITADDR(0142) LIM(200000,300000) DTL
```

Mapping a full VSE version volume

VSE

In this example, a full volume scan is performed on the fixed block architecture device assigned to SYS001. A detailed report is made of each block on the volume that has an alternate assigned, and a summary report is made giving the total number of alternates found.

```
// JOB   jobname
// ASSGN SYS001,140
// EXEC  ICKDSF,SIZE=AUTO
//       MAPALT  SYSNAME(SYS001) ALL DETAIL
/*
/ &
```

Chapter 30. REFORMAT command—FBA

VSE CMS SA

The REFORMAT command updates portions of a previously initialized volume. After issuing INIT to initialize a volume, use REFORMAT to change the:

- Volume serial number
- Owner identification

Only volumes that have been previously initialized can be reformatted.



Do not use REFORMAT to update volumes that have been formatted with the CPVOLUME command for use in a VM environment. Use the CPVOLUME command instead.

Syntax

The abbreviation for the REFORMAT command is RFMT.

REFORMAT
Required Parameters SYSNAME(<i>sysxxx</i>)IUNITADDRESS(<i>ccuu</i>) VERIFY(<i>serial</i> *NONE*[, <i>owner</i>])INOVERIFY
Optional Parameters OWNERID(<i>owner</i>) VOLID(<i>serial</i>)

Required parameters

SYSNAMEIUNITADDRESS parameter: identify the volume

Parameter/ Abbreviations	Description
SYSNAME(<i>sysxxx</i>)	Required to identify a VSE volume when executing ICKDSF in batch mode; the volume must be online. For <i>sysxxx</i> , specify the SYSNAME in the ASSGN system control statement.
UNITADDRESS(<i>ccuu</i>) UNITADDR UNIT	Required for a minidisk, Stand-Alone, or CMS version volume. For VSE, it is required when executing ICKDSF in command mode; the volume must be online. For <i>ccuu</i> , specify the address (3 or 4 hexadecimal digits) of the channel and unit of the volume. For the CMS version, specify the virtual address of the minidisk or dedicated device. The unit address is the device number.
Default:	None.
Restrictions:	None.

VERIFY/NOVERIFY parameter: verify volser and ownerid

Parameter/ Abbreviations	Description
VERIFY(<i>serial</i> [, <i>owner</i>]) VFY	Required when you want to verify the volume serial number and owner identification before reformatting the volume or minidisk. If the volume serial number or owner identification does not match that found on the volume or minidisk, REFORMAT ends. For <i>serial</i> , substitute 1 to 6 alphanumeric characters for the volume serial number. For <i>owner</i> , substitute 1 to 14 alphanumeric characters for the owner identification.
NOVERIFY NOVFY NVFY	Required when you want to bypass verification of the volume serial number and owner identification.
Default:	None. You must specify either VERIFY or NOVERIFY.
Restrictions:	You cannot verify the owner identification separately from the volume serial number. Both the volume serial number and the owner identification must be verified when you want to verify the owner identification. When you specify the VERIFY parameter and verification fails, the command stops running.

Optional parameters

OWNERID parameter: specify a new volume-Owner identification

Parameter/ Abbreviations	Description
OWNERID(<i>owner</i>) OWNER	Writes a new volume-owner identification in the volume or minidisk label. For <i>owner</i> , substitute 1 to 14 alphanumeric characters for the owner identification to be written in the volume or minidisk label.
Default:	If you do not specify a new owner identification when reformatting a volume or minidisk, the old owner identification remains unchanged.
Restrictions:	None.

VOLID parameter: specify a new volume serial number

Parameter/ Abbreviations	Description
VOLID(<i>serial</i>)	Writes a new volume serial number in the volume or minidisk label. For <i>serial</i> , substitute 1 to 6 alphanumeric characters for the volume serial number. If fewer than six characters are specified, the serial is left-justified, and the remainder of the field is padded with blanks (X'40').
Default:	When you reformat a volume or minidisk and do not specify the VOLID parameter, the old volume serial number remains unchanged.
Restrictions:	Any catalog that identifies the volume by its volume serial number must be changed to reflect the new volume serial number for any cataloged data sets that reside on the reformatted volume.

Examples of the REFORMAT command

The following examples show different ways to code the REFORMAT command.

Any values specified here are examples only and should not necessarily be interpreted as the values for your system.

Reformatting volumes with the VSE version

VSE

The following examples show you how to reformat volumes with the VSE version of ICKDSF.

Changing the volume serial number

In this example, the volume serial number and owner ID are verified, and a new volume serial number and owner ID are assigned.

```
// JOB      jobname
// ASSGN    SYS010,380
// EXEC     ICKDSF,SIZE=AUTO
//          REFORMAT SYSNAME(SYS010) VERIFY(OLDVOL,SMITH) -
//          VOLID(NEWVOL) OWNERID(JONES)
/*
/ &
```

Changing the volume serial and blanking out the owner-ID

In this example, the volume serial number and owner ID are verified, a new volume serial number is assigned, and the owner ID is blanked.

```
// JOB      jobname
// ASSGN    SYS011,381
// EXEC     ICKDSF,SIZE=AUTO
//          REFORMAT SYSNAME(SYS011) VERIFY(OLDVOL,JONES) -
//          VOLID(NEWVOL) OWNERID('b')
/*
/ &
```

In the example above, 'b' is a space.

Reformatting a minidisk in the CMS version

CMS

In this example, the volume serial number of an MVS minidisk at virtual address 291 is being changed from OLDVOL to NEWVOL and the owner identification from PAYROLL to NEWPAY. The VERIFY parameter is specified to ensure that the correct volume and owner is being accessed before the volume serial/owner ID is changed.

```
REFORMAT UNITADDRESS(0291) VERIFY(OLDVOL,PAYROLL) -
VOLID(NEWVOL) OWNERID(NEWPAY)
```

Appendix A. Device Support Facilities messages (ICK)

This appendix contains all ICKDSF messages with the ICK prefix.

Messages are explained as fully as possible so that you can understand a condition and take necessary action. Information for each message includes, when appropriate:

Explanation

What the message means, why it appears, what caused it, what its variable fields are.

System Action

What is happening as a result of the condition causing the message. For example, the system waiting for responses.

Operator and Programmer Response

If a response is necessary, who performs it, what the pertinent responses are, and their effect on the system or program.

Note: Wherever the CE cylinder is referred to in the message, this can be either the CE, device support, or diagnostic cylinder, depending on the device.

Message routing and descriptor codes

Routing codes provide the ability to route system operator messages to selected functional areas.

ICKDSF messages will be routed to default functional areas as defined by a specific installation or, in the absence of such definition, they will be routed to the master console.

Component Name

ICK

Program Producing Message

Device Support Facilities

Audience/Where Produced

For the operator/the operator's console. For the system programmer/printed output.

Message Format

ICK s nnn t text or ICK nnn t text

s Condition code indicating severity of message received at the output printer. Messages received at the console do not have a condition code indicating severity.

- 0 Information: no effect upon processing
- 1 Warning: function might fail
- 2 Error: function probably failed
- 3 Serious error: function failed
- 4 Terminal error: ICKDSF processor ends

It is possible to determine which of several messages issued during command processing results in a specific condition code value. The highest condition code multiplied by four yields the command's setting of the LASTCC.

Message routing and descriptor codes

nnnn or nnn

Message serial number: 4 digits for printed messages, and 3 digits for messages that appear at the operator's console.

t

Type code:

I Informational
E Eventual action required
D Decision required, processing waiting
A Operator action required

text

Message text

** Indicates a 'second-level' message that further explains a preceding message. The track addresses (X'cccc:hhhh') in message text appear in hexadecimal format.

Associated Publications

None

ICK001D CONFIRM PURGING OF UNEXPIRED DATA SETS ON
ccuu, REPLY U TO PURGE, ELSE T

Explanation: When one or more data sets are on the volume at *ccuu*, the INIT command could possibly destroy the contents of one or more tracks of this data set.

When one or more unexpired data sets are on the volume at *ccuu*, the INSPECT command or TRKFMT command could possibly destroy the contents of one or more tracks of this data set.

There is no verification that the tracks being inspected or processed with the TRKFMT command, are actually within the data set. The data set is affected by the INSPECT command or TRKFMT command only if the specified tracks are within the unexpired data set.

The data set is not purged from the VTOC. Only the specified tracks or blocks are purged, unless recovery is in effect.

System Action: ICKDSF waits for the operator's response.

Operator Response: For the INIT command, reply U to permit unconditional purging of the data set.

Reply T to stop purging and to stop processing the function.

For the INSPECT command, reply U to permit INSPECT to proceed on the tracks specified in the command.

Reply T to stop possible destruction of the specified tracks and to end the function.

For the TRKFMT command, reply U to permit TRKFMT to proceed on the tracks specified in the command.

Reply T to stop possible destruction of the specified tracks and to end the function.

System Programmer Response: None.

ICK002D ERROR IN REPLY, REPLY "U" OR "T"

Explanation: There is a response that is not valid to a message whose only valid response is U or T. Such a character causes a request for reentry to be made.

System Action: ICKDSF waits for the operator's response.

Operator Response: Respond with U for unconditional purging, or T to end.

System Programmer Response: None.

ICK003D REPLY U TO ALTER VOLUME *ccuu* CONTENTS,
ELSE T

Explanation: Processing of the volume *ccuu* offline must be confirmed because the operating system does not check the offline volume. This could cause loss or modification of data on the volume.

Depending on the command and parameter used, the amount of altered data might be as small as the volume serial (such as the REFORMAT command with VOLID parameter), or as large as a track (such as INSPECT with NOPRESERVE), or a whole volume.

System Action: ICKDSF waits for the operator's response.

Operator Response: Respond U to proceed with command processing. Respond T to end the command.

System Programmer Response: None.

ICK004D READY DEVICE *ccuu* AND REPLY U, ELSE T

Explanation: The device *ccuu* is not in the READY state.

System Action: ICKDSF waits for the operator's response.

Operator Response: Ensure that the device is in the READY state. Respond U to continue processing the command or respond T to end the command.

System Programmer Response: None.

ICK005E DEFINE INPUT DEVICE, REPLY "dddd,ccuu" or
"CONSOLE"

Explanation: dddd is the device type.

ccuu is the channel and unit address.

This message appears only in the Stand-Alone version. The device type and location of the command input stream must be specified. To specify the console, enter a null line.

System Action: ICKDSF waits for the operator's response.

Operator Response: Specify the input device type, and its channel and unit address. Specify *ccuu* as 3 or 4 digits.

System Programmer Response: None.

ICK006E DEFINE OUTPUT DEVICE, REPLY "dddd,ccuu" or "CONSOLE"

Explanation: dddd is the device type.

ccuu is the channel and unit address.

This message appears only in the Stand-Alone version. The device type and the location of the printed output must be specified. To specify the console, enter a null line.

System Action: ICKDSF waits for the operator's response.

Operator Response: Specify the output device type and its channel and unit address. *ccuu* can be specified as 3 or 4 digits.

System Programmer Response: None.

ICK007E INVALID INPUT DEVICE SPECIFIED

Explanation: This message appears only in the CMS or Stand-Alone version. The specified device type is not valid to message ICK005E.

System Action: ICKDSF repeats message ICK005E.

Operator Response: Specify a correct input device type. For CMS version see "Using parameters to select the input and output devices" on page 45. For Stand-Alone version see "Defining the input and output device" on page 62.

System Programmer Response: None. Save the job output and contact your IBM service representative.

ICK008E INVALID OUTPUT DEVICE SPECIFIED

Explanation: This message appears only in the CMS or Stand-Alone version. The specified device type is not valid to message ICK006E.

System Action: ICKDSF repeats message ICK006E.

Operator Response: Specify a correct output device type. For CMS version see "Using parameters to select the input and output devices" on page 45. For Stand-Alone version see "Defining the input and output device" on page 62.

System Programmer Response: None. Save the job output and contact your IBM service representative.

ICK009I SVC INTERRUPT OCCURRED

Explanation: This message appears only in the CMS or Stand-Alone version. It indicates a probable program error. The SVC instruction cannot be used in the CMS or Stand-Alone version.

System Action: ICKDSF ends.

Operator Response: Notify the system programmer.

System Programmer Response: Save the job output and contact your IBM service representative.

ICK010I PROGRAM INTERRUPT OCCURRED

Explanation: This message appears only in the CMS or Stand-Alone version. It indicates a probable program error where an instruction processed incorrectly.

System Action: ICKDSF ends.

Operator Response: Notify the system programmer.

System Programmer Response: Save the job output and contact your IBM service representative.

ICK011E I/O ERROR -- error-type, ccuu, command, csw, sense

Explanation: This message appears only in the CMS or Stand-Alone version. An I/O error of the type indicated has occurred on the device at address *ccuu*. The message prints the failing command, the contents of the channel status word (CSW), and the results of a sense operation against the device.

System Action: ICKDSF ends.

Operator Response: None.

System Programmer Response: Correct the cause of the error, and restart ICKDSF. Save the job output and contact your IBM service representative.

ICK012E INTERVENTION REQUIRED, ccuu

Explanation: This message appears only in the CMS or Stand-Alone version. The device shown is not in the READY state.

System Action: ICKDSF waits for correction of the problem.

Operator Response: Ensure that the device is in a READY state.

System Programmer Response: None.

ICK013E CONSOLE READ FAILED, REENTER LAST LINE

Explanation: This message appears only in the CMS or Stand-Alone version. An I/O error occurred while reading a line entered at the console.

System Action: ICKDSF waits for the line to be reentered.

Operator Response: Reenter the line.

System Programmer Response: None. Save the job output and contact your IBM service representative.

ICK014D SET DEVICE ccuu IN WRITE-MODE AND REPLY U, ELSE T

Explanation: The device at address *ccuu* is set in read-only mode.

System Action: ICKDSF waits a response.

Operator Response: Set the device to allow write operations and reply *U*. If write operations cannot be allowed, reply *T*, and the command ends.

System Programmer Response: None.

Message routing and descriptor codes

ICK015E **SUPPLY TODAY'S DATE, REPLY "mm/dd/yy"**

Explanation: This message appears only in the Stand-Alone version.

- To include the date as part of the output title line, respond with the month, day, and year, as shown.
- To omit the date, press the ENTER key.

To bypass this message, set the CPU time and date before IPLing Stand-Alone ICKDSF.

System Action: Either the date appears in the title line of the output listing, or blanks are substituted if a date was not supplied.

Operator Response: To include the date in the title line of the output listing, respond with the month, day, and year. Otherwise, respond by pressing the ENTER key.

System Programmer Response: None.

ICK016E **SUPPLY TIME OF DAY, REPLY "hh:mm:ss"**

Explanation: This message appears only in the Stand-Alone version.

- To include the time of day in the title line of the output listing, respond with the hour, minute, and second as indicated.
- To omit the time of day, press the ENTER key.

To bypass this message, set the CPU time and date before IPLing Stand-Alone ICKDSF.

System Action: Either the time of day appears in the title line of the output listing, or blanks are substituted if a time of day was not specified.

Operator Response: To include the time of day in the title line of the output listing, specify the hour, minute, and second. Otherwise, respond by pressing the ENTER key.

System Programmer Response: None.

ICK017D **filename IS A SECURED FILE**

Explanation: The specified *filename* is a data-secured file and ICKDSF requests permission to purge this file in an associated message, ICK018D.

System Action: This message is informational. Command processing continues.

Operator Response: None.

ICK018D **CONFIRM PURGING OF SPECIFIED FILE NAME,
REPLY U TO PURGE, ELSE T**

Explanation: The filename is displayed in message ICK017D. INIT command processing requests permission to purge the data set.

INSPECT command and TRKFMT command processing requests permission to possibly destroy the contents of one or more tracks of this data set. There is no verification that the tracks being inspected or processed with the TRKFMT command are actually contained in this data set. The data set is not purged from the VTOC.

System Action: Command processing continues after the

correct reply is issued. If the reply is T, the command ends, and ICKDSF continues processing the next command.

If the reply is U, ICKDSF continues to process the current command.

Operator Response: Reply to this message with either U or T.

System Programmer Response: None.

ICK019D **CONFIRM PURGING OF ALL VSAM FILES ON ccuu,
REPLY U TO PURGE, ELSE T**

Explanation: The volume at *ccuu*, is known to contain one or more VSAM data sets.

When the INIT command is specified, permission is being requested to purge all the VSAM data sets on the volume at *ccuu*.

When the INSPECT command or TRKFMT is specified, if one or more VSAM data sets have been found on the volume at *ccuu*, permission is being requested to possibly destroy the contents of one or more tracks of VSAM data sets. There is no verification that the tracks being inspected or processed with the TRKFMT command, are actually within the VSAM data sets.

The VSAM data set is affected by the INSPECT command or TRKFMT command only if the tracks specified are within the VSAM data set. The data set is not purged from the VTOC. Only the contents of the specified tracks are affected. If PRESERVE, HOLDIT, or KEEPIT have been specified, the INSPECT command will attempt to save and restore the contents of the track.

System Action: Command processing continues after a correct reply is received. Reply T ends the command, and ICKDSF continues processing the next command.

Reply U to continue processing the current command.

Operator Response: Reply either U or T to this message.

System Programmer Response: None.

ICK020D **DEVICE ccuu IS SHARED. REPLY U OR T**

Explanation: The volume addressed by the *ccuu* is being shared, and ICKDSF requests permission to operate on the subject volume.

System Action: Command processing continues after the correct reply is given. Reply T ends the command and ICKDSF continues processing the next command. Reply U to continue processing the current command.

Operator Response: Reply to this message with either U or T.

System Programmer Response: None.

ICK024I **UNABLE TO OPEN VOLUME**

Explanation: The specified volume cannot be opened for these possible reasons:

- The DD statement is missing or not valid.
- The channel/unit address is not valid.
- While processing in a shared environment, the device is not in an offline status on the system processing ICKDSF

- There are I/O errors associated with the volume.

System Action: The command ends. ICKDSF processing continues with the next command.

Operator Response: None.

System Programmer Response: Check the status of the volume. Examine previous messages to determine the volume status. Save the job output and contact your IBM Support Center.

ICK030E DEFINE INPUT DEVICE: fn ft fm, OR "CONSOLE," OR "READER"

Explanation: Specify the input device.

System Action: ICKDSF waits for the operator's response.

Operator Response:

- If the ICKDSF input command stream comes from the console, either enter CONSOLE or press the ENTER key.
- If the ICKDSF input command stream is contained in a CMS file, enter fn ft fm.
- If the ICKDSF input command stream is contained in a virtual reader file, enter READER (the file must be the first file in the reader).

Type ? to invoke the online help panels.

System Programmer Response: None.

ICK031E DEFINE OUTPUT DEVICE: fn ft fm, OR "CONSOLE," OR "PRINTER"

Explanation: Specify the output device.

System Action: ICKDSF waits for the operator's response.

Operator Response:

- If the console is to be used as the ICKDSF output device, either enter CONSOLE or press the ENTER key.
- If the output device is to be a CMS file, enter fn ft fm.
- If ICKDSF output device is a printer, enter PRINTER.

Type ? to invoke the online help panels.

System Programmer Response: None.

ICK033E ENTER CYL OR BLOCK SIZE FOR THE SPECIFIED MINIDISK

Explanation: Specify the size of the minidisk either in cylinders for CKD devices, or in blocks for FBA devices. No verification is made of the accuracy of the size of the minidisk. This message follows ICK12316I.

System Action: ICKDSF waits for operator's response.

Operator Response: Specify the minidisk size (1-8 decimal digits) either in cylinders for CKD devices or in blocks for FBA devices.

System Programmer Response: None.

ICK035I CMS PARAMETER LIST LENGTH IS INVALID.

Explanation: ICKDSF was invoked by the CMS invocation parameter list and the number of the items in the list is not valid. The valid numbers are: 2, 4, or 6:

- Valid parameters with a length of two are:
 - CONSOLE CONSOLE
 - CONSOLE PRINTER
 - READER CONSOLE
 - READER PRINTER
- Valid parameters with a length of four are:
 - CONSOLE fn ft fm
 - READER fn ft fm
 - fn ft fm CONSOLE
 - fn ft fm PRINTER
- Valid parameters with a length of six are:
 - fn ft fm fn ft fm

System Action: Command processing ends.

Operator Response: Specify valid INPUT and OUTPUT device parameters.

System Programmer Response: None.

ICK036I CMS PARAMETER LIST IS INVALID.

Explanation: ICKDSF was invoked by the invocation parameter list and the list is not valid. Valid parameters for INPUT DEVICE are: CONSOLE, READER or fn ft fm.. Valid parameters for OUTPUT DEVICE are: CONSOLE,PRINTER or (fn ft fm).

System Action: Command processing ends.

Operator Response: Specify valid INPUT and OUTPUT DEVICE parameters.

System Programmer Response: None.

ICK037I FILE MODE PARAMETER LENGTH INVALID

Explanation: ICKDSF was invoked using the CMS invocation parameter list, and the length of the file mode parameter is not valid. The maximum length for file mode is two characters.

System Action: Command processing ends.

Operator Response: Specify a valid file mode parameter.

System Programmer Response: None.

ICK057I INVALID DEVICE TYPE: VTOC INDEX NOT SUPPORTED ON THIS DEVICE

Explanation: The device type is not valid for initialization with a VTOC index.

System Action: The VTOC index is not created. INIT command processing continues.

Operator Response: None.

System Programmer Response: None.

Message routing and descriptor codes

ICK058I ccuu I/O ERROR DETECTED DURING INDEX
CREATION: ERROR CODE= *

Explanation: An I/O error occurred during VTOC index creation processing. These are possible error codes:

- 1 Error occurred reading volume label
- 2 Error occurred reading VTOC
- 3 Error occurred writing VTOC
- 4 Error occurred writing index records
- 5 Index extent violated; increase index size

System Action: VTOC index creation processing ends. The VSE volume indicator is turned on in the VTOC. INIT command processing continues.

Operator Response: Refer the error response to the system coordinator for problem determination.

System Programmer Response: None.

ICK059I INDEX STARTING LOCATION INVALID AS
SPECIFIED

Explanation: The INDEX parameter on the INIT command statement is not valid. The starting location, as specified, is not valid for one of the following reasons:

- It caused an overlap with the VTOC.
- It defined cylinder 0, track 0 as the starting location of the index data set.
- It was outside the physical limits of the device.
- The relative track specified is not valid for the device.

System Action: Command processing ends.

Operator Response: None.

System Programmer Response: Check the values specified for the INDEX parameter and correct the value in error. Resubmit the job.

ICK061I ccuu VTOC INDEX CREATION SUCCESSFUL:
VOLUME IS IN INDEX FORMAT

Explanation: The VTOC index was successfully created on the volume.

System Action: None.

Operator Response: None.

System Programmer Response: None.

ICK062I ccuu VTOC INDEX CREATION FAILED: RETURN
CODE= 8

Explanation: Index creation was unsuccessful.

System Action: None.

Operator Response: None.

System Programmer Response: Check the job output for additional information about the reason for job failure.

ICK091I ccuu NED=tttttt.mmm.mfg.lc.ssssssssssss

Explanation: The device NED is shown for the device. Either the device is connected on a single path, or if multiple paths to his host exist, the NED information was found to match for all paths. The NED information shown is in the following format:

ttttt = device type
mmm = model
mfg = manufacturer
lc = manufacturing location
sssssssssss = sequence number

Note: The information in the above fields are printed as they are returned from the device. If blanks are returned, then blanks will be printed. Unprintable characters may be printed as '.'. Some examples of this are:

- The device type field, ttttt, is a 6-digit field. The information is printed in the message as it is returned from the device. For example, when the first 2-digits are returned as blanks by the device, they will be printed as blanks in the message. So the device type field will appear to have leading blanks.
- Some devices (for example 2105) returns blanks in the model field, so the model field will be blank in the message.

System Action: Processing continues.

Operator Response: None.

System Programmer Response: If the information is not correct for this device, take the necessary action to determine if a configuration error exists and correct the problem.

ICK126D DATA ALREADY EXISTS FOR TRACK X'cccc hhhh'
REPLY "R" TO RECOVER, "E" TO ERASE THE
RECOVERY DATA, OR "T" TO TERMINATE

Explanation: This message is issued if recovery data exists for a track (see ICK2115I), but there already exists data on that track.

This situation might occur if:

- The original data on the track has not yet been erased at the point of failure.
- An INSPECT did not run to completion, but the volume was available for user use before this invocation of the INSPECT command.

System Action: Screen prompt asks the operator for one of these replies:

- If R is specified, the data will be recovered from the recovery information. (The new data on the track is erased).
- If E is specified, the recovery data is destroyed. The current data on the track remains.
- If T is specified, command processing ends. The recovery data remains intact. The next invocation of the INSPECT command will again attempt to process the recovery data.

Operator Response: Reply R, E or T.

System Programmer Response: None.

ICK130D DATA CANNOT BE RECOVERED FOR TRACK X'cccc
hhhh' REPLY C TO ERASE AND CONTINUE, T TO
TERMINATE, I TO IGNORE

Explanation: The previous INSPECT command did not complete running during PRESERVE backup processing.

Note: The data cannot be recovered from the backup location.

System Action: A prompt asks for a reply to this message. The ignore option is available if the current invocation of the INSPECT command specified HOLDIT.

- If C is specified, the data is erased at the backup location, and processing begins from the start of the specified range. This should be specified if the user has no need to recover data from the backup location.
- If I is specified, the recovery data is ignored, and command processing continues for the current invocation.

Note: This response is allowed only if HOLDIT was specified.

The recovery data remains intact. The next invocation of the INSPECT command will again attempt to process the recovery data.

- If T is specified, command processing ends. The recovery data remains intact. This should be specified if the user wishes to either retry the recovery process, or examine the situation before allowing the data to be erased. The next invocation of the INSPECT command will again attempt to process the recovery data.

Operator Response: Respond C, I or T.

System Programmer Response: None.

ICK158D DATA CANNOT BE RECOVERED FOR BLOCK
xxxxxxx REPLY C TO ERASE AND CONTINUE, T
TO TERMINATE, I TO IGNORE

Explanation: The previous invocation of the INSPECT command did not run to completion during PRESERVE backup processing.

Note: The data cannot be recovered from the backup location.

System Action: A prompt asks for a reply to this message. The ignore option is available if the current invocation of the INSPECT command specified HOLDIT.

- If C is specified, the data is erased from the backup location, and processing begins from the start of the specified range. This should be specified if the user has no need to recover data from the backup location.
- If I is specified, the recovery data is ignored, and command processing continues for the current invocation. Note that this response is allowed only if HOLDIT was specified. The recovery data remains intact. The next invocation of the INSPECT command will again attempt to process the recovery data.
- If T is specified, command processing ends. The recovery data remains intact. This should be specified if the user wishes to retry the recovery process, or examine the situation before allowing the data to be erased. The next invocation of the INSPECT command will again attempt to process the recovery data.

Operator Response: Respond with C, I or T.

ICK159D DATA ALREADY EXISTS FOR BLOCK xxxxx REPLY
"R" TO RECOVER, "E" TO ERASE THE RECOVERY
DATA, OR "T" TO TERMINATE

Explanation: This message is issued if recovery data exists for a block (see ICK12157), but that block already contains data that is neither ICKDSF nor original user data.

This situation can occur if an INSPECT did not run to completion, but the volume was available for user use before this invocation of the INSPECT command.

System Action: A prompt asks the operator to reply to this message.

- If R is specified, the data will be recovered from the recovery information. (The new data on the block is erased).
- If E is specified, the recovery data is destroyed. The current data on the block remains.
- If T is specified, command processing ends. The recovery data remains intact. The next invocation of the INSPECT command will again attempt to process the recovery data.

Operator Response: Respond R, E, or T.

ICK177D REPLY U TO ERASE CONTENTS OF SYSTEM
RESERVED AREA ON ccuu, ELSE T

Explanation: When a CONTROL command with the RECLAIM(SYSAREA) parameter is issued, the operator must confirm the processing before ICKDSF starts the reclaim process to destroy the contents of the System Reserved Area. ccuu is the address of the device that will be modified if the command continues.

System Action: ICKDSF waits for operator's response.

Operator Response:

- Respond U to permit the command to start system reserved area reclaim processing.
- Respond T to end processing and prevent destruction of system reserved area contents.

System Programmer Response: None.

ICK203I PPRCOPY ESTPAIR FUNCTION COMPLETED
SUCCESSFULLY

Explanation: The PPRCOPY ESTPAIR command used to establish remote copy pairs has completed successfully.

System Action: Command processing continues.

Operator Response: None.

System Programmer Response: None.

ICK210I ***** COPY IN PROGRESS *****

Explanation: MSGREQ(YES) parameter has been specified with the PPRCOPY ESTPAIR command. Copy is still in progress. The command has not yet been completed.

System Action: Command processing continues.

Operator Response: None.

System Programmer Response: None.

Message routing and descriptor codes

ICK231I **DEVICE IS NOW A PEER TO PEER REMOTE COPY VOLUME**

Explanation: PPRCOPY ESTPAIR completed successfully. The device is now a Peer-to-peer Remote Copy volume.

System Action: Command processing continues.

Operator Response: None.

System Programmer Response: None.

ICK316I **INSTALL FUNCTION COMPLETED SUCCESSFULLY**

Explanation: The INSTALL command processing completed successfully.

System Action: ICKDSF ended normally. Processing continues with the next command.

System Programmer Response: None.

Operator Response: None.

ICK318I **REVAL FUNCTION COMPLETED SUCCESSFULLY**

Explanation: The REVAL command processing completed successfully.

System Action: ICKDSF ended normally. Processing continues with the next command.

Operator Response: None.

System Programmer Response: None.

ICK401I **ccuu SUSPECTED DRIVE PROBLEM**

Explanation: Drive tests have detected an error.

System Action: Command processing ends.

Operator Response: Depending on your installation's procedures, you might do the following:

- Restore the entire volume to another drive from a backup volume.
- Discontinue using the drive.

Save the output, which contains further information about the hardware problems.

Take the action appropriate to your installation's procedures for handling suspected equipment problems.

System Programmer Response: If you are running under VM (either CMS or Stand-Alone, VSE, or MVS running under VM), this message can indicate that a diagnostic function was attempted against a device that was a minidisk and was LINKed to the userid. Diagnostic functions must be done on dedicated devices.

If this is determined to be the case, and if a scan was the primary purpose of this ANALYZE command invocation, specify NODRIVE. Otherwise, the device must be dedicated.

For more information on VM support, see Chapter 5, "Getting started with the CMS version," on page 39.

System Programmer Response: If the problem recurs, save the job output and contact your IBM service representative.

ICK404I **ccuu VOLUME HAS UNFORMATTED DATA BLOCKS. TESTING TERMINATED**

Explanation: An attempt was made to read a data block which is not initialized (the data field is not written).

System Action: After 504 data checks, the ANALYZE command ends.

Operator Response: Perform appropriate procedures to recover all desired data from the volume and then run the VSE utilities INTDK or INTDSK with the IQ option to initialize all data blocks.

System Programmer Response: None.

ICK407I **ccuu NO DRIVE PROBLEMS FOUND**

Explanation: Drive test completed successfully and detected no problems.

System Action: Command processing continues.

Operator Response: None.

Notes:

1. If a data problem prompted you to run this command, and if the problem persists, run the data verification test.
2. If a drive problem prompted you to run this command, and if the problem persists, further analysis is needed according to your installation's procedures.

System Programmer Response: None.

ICK411I **FUNCTIONAL VERIFICATION DATA WRITE/READ TEST STARTED**

Explanation: HA/R0 validation and functional data verification test for the REVAL command process has started.

System Action: Command processing continues.

System Programmer Response: None.

Operator Response: None.

ICK412I **FUNCTIONAL VERIFICATION DATA WRITE/READ TEST ENDED**

Explanation: HA/R0 validation and functional data verification test for the REVAL command process has ended.

System Action: Command processing continues.

Operator Response: None.

System Programmer Response: None.

ICK416D **CHPID = XX, RESERVED, REPLY R TO RETRY, B TO BYPASS**

Explanation: The system operator receives this message if the processing encounters a path that remains reserved for all of its retries. XX specifies the path (CHPID).

System Action: See explanation.

Operator Response:

- Reply R to reissue the I/O operation to the device.
 - Reply B to bypass further processing on this path.
-

Message routing and descriptor codes

System Programmer Response: None.

ICK417D X, Y, RESERVED, REPLY R TO RETRY, B TO BYPASS

Explanation: The system operator receives this message if the processing encounters a path that remains reserved for all of its retries. X specifies the channel number. Y specifies the channel set (CPU affinity).

System Action: See explanation.

Operator Response:

- Reply R to reissue the I/O operation to the device
- Reply B to bypass further processing on this path

System Programmer Response: None.

ICK418I REVALIDATE FIXSIM(4E4E) PROCESS STARTED

Explanation: Rewrite user data for the specified range has started.

System Action: Command processing continues.

Operator Response: None.

System Programmer Response: None.

ICK419I REVALIDATE FIXSIM(4E4E) PROCESS ENDED

Explanation: Rewrite user data for the specified range has ended.

System Action: Command processing continues.

Operator Response: None.

System Programmer Response: None.

ICK420I REVALIDATE FUNCTION STARTED WITHOUT FFVDP WRITE/READ TEST

Explanation: HA/R0 validation test has started for the specified range for the REVAL command. No factory functional verification data pattern will be written on the volume.

System Action: Command processing continues.

Operator Response: None.

System Programmer Response: None.

ICK430I REVALIDATE REFRESH PROCESS STARTED

Explanation: Rewrite the user data for the specified range has started.

System Action: Command processing continues.

Operator Response: None.

System Programmer Response: None.

ICK431I REVALIDATE REFRESH PROCESS ENDED

Explanation: Rewrite the user data for the specified range has ended.

System Action: Command processing continues.

Operator Response: None.

System Programmer Response: None.

ICK440I VOLSER, VTOC AND DATA IN THE SPECIFIED RANGE WILL BE ERASED

Explanation: The message was printed for REVAL DATA or REVAL NODATA processing. The VOL1 record, the VTOC pointer, and the data in the specified range will be erased. Data on the volume will be inaccessible when the REVAL process has completed.

System Action: Command processing continues.

Operator Response: None.

System Programmer Response: None.

ICK501I INVALID DEVICE TYPE SPECIFIED FOR BUILDIX COMMAND

Explanation: There is a request to change the format of a VTOC on a volume whose device type is not supported by the BUILDIX command (for example, a 2314 DASD).

System Action: Command processing ends.

Operator Response: None.

ICK502I BUILDIX FUNCTION STARTED

Explanation: The BUILDIX command has started running. Processing of the BUILDIX command has begun.

System Action: None.

Operator Response: None.

ICK503I cccu REQUEST RECEIVED TO CONVERT VTOC TO **FORMAT

Explanation: This message verifies the requested format change for a VTOC. ** specifies the format requested: either OS or IX.

System Action: Command processing continues.

Operator Response: None.

System Programmer Response: None.

ICK504I cccu VTOC FORMAT IS CURRENTLY **FORMAT, REQUEST ACCEPTED

Explanation: This message verifies that the specified BUILDIX function is valid for the current format of the VTOC on the volume. ** identifies the format of the VTOC: either OS or IX.

System Action: Command processing continues.

Operator Response: None.

System Programmer Response: None.

ICK505I cccu VTOC FORMAT IS CURRENTLY **FORMAT, REQUEST REJECTED

Explanation: The format requested by the BUILDIX command is the same as the current VTOC format.

** identifies the format of the VTOC: either OS or IX.

Message routing and descriptor codes

System Action: Command processing ends.

Operator Response: None.

System Programmer Response: None.

ICK508A **ccuu SHOULD CONVERSION PROCEED? REPLY U TO CONTINUE, ELSE T**

Explanation: This message permits the operator to verify that the user is authorized to request the BUILDIX function before command processing begins.

System Action: The system waits for the operator's response.

Operator Response: Verify that the user is authorized to issue the command, and reply:

- U to continue
- T to end processing

Any reply other than U or T causes this message to be issued again.

System Programmer Response: None.

ICK509I **ccuu DIRF FLAG SET IN VTOC, BUILDIX CANNOT PROCEED**

Explanation: An error occurred during VTOC processing on a previous job which set the DADSM interrupt flag in the VTOC. The VTOC is not accurate.

System Action: Command processing ends

When the job is completed, resubmit the BUILDIX command.

Operator Response: Prepare a job that will reconstruct the VTOC and run it against the volume. (For example, run an IEFBR14 job to allocate a temporary data set to the volume.)

System Programmer Response: None.

ICK510I **ccuu BUILDIX REQUEST CANCELLED DUE TO OPERATOR ACTION**

Explanation: The operator replied CANCEL to a message requiring a response.

System Action: Command processing ends.

Operator Response: None.

System Programmer Response: None.

ICK511I **ccuu CVAF ERROR: RETURN CODE=** ERROR CONDITION= *****

Explanation: The common VTOC access facility returned to ICKDSF with a return code that indicates either a logical error or a physical error. Return codes have the following meanings:

- 4, 12** Indicate logical errors
- 8** Indicates an index structure that is not valid
- 16** Indicates an I/O error

The error condition will be printed only for a return code of 4 or 8. For more information on these error conditions, see *CVAF Diagnosis Reference* or *MVS/Enterprise System Architecture System-Data Administration*.

System Action: Command processing ends with the following conditions, depending on the return code:

- 4, 8, 12** The volume remains in OSVTOC format
- 16** The volume remains as it was before the command was issued

Operator Response: None.

System Programmer Response: None.

ICK512I **ccuu ERROR: SYS1.VTOCIX IS A VIO DATASET. BUILDIX TERMINATED.**

Explanation: The BUILDIX command does not support the index data set allocated as a VIO data set.

System Action: Command processing ends with a return code of 12. The VTOC remains unchanged.

Operator Response: None.

ICK513I **ccuu BUILDIX PROCESSING COMPLETED: VTOC IS NOW IN **FORMAT.**

Explanation: The BUILDIX command completed successfully. ** shows the new VTOC format: either OS or IX.

System Action: ICKDSF ends normally.

Operator Response: None.

System Programmer Response: None.

ICK514I **INDEXED VTOC FACILITY NOT ON SYSTEM. BUILDIX TERMINATED.**

Explanation: There is a request to change a VTOC to IXVTOC format, but the system does not contain indexed VTOC programming support.

System Action: Command processing ends.

Operator Response: None.

System Programmer Response: None.

ICK515I **ccuu BUILDIX COMMAND FAILED.**

Explanation: An error caused command processing to end.

System Action: Command processing ends.

Operator Response: None.

System Programmer Response: None.

ICK516I **ccuu I/O ERROR DETECTED DURING VTOC CONVERSION: ERROR CODE= ***

Explanation: There was an I/O error during BUILDIX processing. Error codes:

- 1** Error occurred in reading the volume label
- 2** Error occurred in reading the VTOC
- 3** Error occurred in writing the VTOC
- 4** Error occurred in writing index records
- 5** Index extent was violated; increase index size

System Action: BUILDIX command processing ends.

Operator Response: Refer the error indication to the system coordinator for problem determination.

Message routing and descriptor codes

ICK517I ccuu ERROR: VOLUME IS A DOS STACKED PACK

Explanation: The volume being processed has a VTOC on the first track of the volume. VTOC conversion is not possible on this type of volume.

System Action: Command processing ends.

Operator Response: None.

System Programmer Response: None.

ICK518I ccuu ERROR: VOLUME CONTAINS SPLIT CYLINDER EXTENTS

Explanation: The volume contains one or more shared extent data sets which are not supported by the BUILDIX command.

System Action: BUILDIX command processing ends.

Operator Response: None.

System Programmer Response: None.

ICK519I ccuu ERROR: SYS1.VTOCIX. DATASET NOT FOUND ON VOLUME

Explanation: The index data set could not be found on the volume.

System Action: BUILDIX command processing ends.

Operator Response: None.

System Programmer Response: None.

ICK520I ccuu ERROR: DUPLICATE INDEX DATASET NAME FOUND ON VOLUME

Explanation: Two data sets were found on the volume that had names beginning with SYS1.VTOCIX. Only one set per volume is allowed.

System Action: BUILDIX command processing ends.

Operator Response: None.

System Programmer Response: None.

ICK521I ccuu ERROR: INDEX DATASET EXTENT NOT CONTIGUOUS

Explanation: The index data set occupies more than one extent. This data set must occupy one, and only one, extent.

System Action: BUILDIX command processing ends.

Operator Response: None.

System Programmer Response: None.

ICK522I INVALID UNITADDRESS OR DDNAME SPECIFIED

Explanation: The UNITADDRESS or DDNAME is incorrect in the command statement.

System Action: BUILDIX command processing ends.

Operator Response: Correct the job control statement, then resubmit the job.

System Programmer Response: None.

ICK523I VTOC ENQUEUE FAILURE

Explanation: ENQ RET=HAVE; returned higher than a return code 8 (task does not have resources).

System Action: Command ends. Processing continues with the next command.

Operator Response: None.

System Programmer Response: Resubmit the job when ENQ can be obtained.

ICK526I CONVERSION TO OSFORMAT COULD NOT COMPLETE SUCCESSFULLY

Explanation: The VTOC indicates an error condition after the completion of BUILDIX processing to convert to OSFORMAT.

System Action: BUILDIX ends abnormally.

Operator Response: None.

System Programmer Response: This message usually means that the OS VTOC on the volume contains an error. Examine the VTOC to determine the nature of the error.

ICK528I INDEX DATA SET CANNOT START AT CYLINDER 0, TRACK 0

Explanation: You specified cylinder 0, track 0 for the index data set location. This is not a valid location.

System Action: BUILDIX command processing ends. None.

Operator Response: None.

System Programmer Response: Respecify the command using a valid location.

ICK529I ALLOCATE ERROR: RETURN CODE = ****

Explanation: DADSM allocate returned to ICKDSF with an unexpected return code.

System Action: BUILDIX command processing ends.

Operator Response: None.

System Programmer Response: See the *DADSM Diagnosis Reference* for a full explanation of DADSM allocate return codes.

ICK600I MAPALT STARTED

Explanation: MAPALT command processing has started.

System Action: None.

Operator Response: None.

ICK602I INCORRECT DEVICETYPE, MAPALT TERMINATED

Explanation: The MAPALT command does not support the specified device type.

System Action: MAPALT command processing ends.

Operator Response: MAPALT can only run on fixed block devices in fixed block mode.

System Programmer Response: None.

Message routing and descriptor codes

ICK603I UNABLE TO OPEN VOLUME

Explanation: The specified volume cannot be opened. The ASSGN statement is possibly missing or not valid, or the channel and unit address is not valid.

System Action: MAPALT command processing ends.

Operator Response: Correct the error, then resubmit the job.

System Programmer Response: None.

ICK604I ccuu LIMITS PARAMETER INVALID AS SPECIFIED, MAPALT TERMINATED

Explanation: The LIMITS parameter specified relative block numbers that are not valid.

System Action: MAPALT command processing ends.

Operator Response: Correct the values in the LIMITS parameter, then resubmit the job.

System Programmer Response: None.

ICK605I ccuu UNRECOVERABLE I/O ERROR DETECTED, MAPALT TERMINATED

Explanation: There is an unrecoverable I/O error (other than a data check).

System Action: MAPALT command processing ends.

Operator Response: Check the job output which contains diagnostic information to aid error analysis.

Run the ICKDSF ANALYZE command as a problem determination aid.

Follow installation procedures for recovery from this type of error.

System Programmer Response: None.

ICK606I nnnnn BLOCKS ASSIGNED TO ALTERNATES IN LIMITS SPECIFIED

Explanation: This summary message shows the number of blocks that were assigned to alternates within the limits specified on the command statement.

System Action: None.

Operator Response: None.

System Programmer Response: None.

ICK607I ccuu MAPALT ABNORMALLY ENDED, REPORT MAY BE INCOMPLETE

Explanation: There is an error that caused command processing to end. The report may be incomplete.

System Action: None.

Operator Response: Check the job output for previous messages, then follow installation procedures.

System Programmer Response: None.

ICK608I ccuu MAPALT ENDED NORMALLY, RETURN CODE= n

Explanation: Command processing ended without any errors that stopped processing.

A return code of 0 or 4 is indicated in the message:

0 means no errors were encountered

4 means one or more recoverable errors were encountered

System Action: None.

Operator Response: None.

System Programmer Response: None.

ICK609I PERMANENT DATA CHECK FOUND READING ID FOR BLOCK nnnnnn

Explanation: A permanent data check was found while reading the ID field of the primary block shown in the message.

System Action: The output device prints diagnostic information, and command processing continues.

Operator Response: None.

System Programmer Response: Save the job output for the system coordinator, and follow installation procedures for data recovery and assignment of an alternate block.

ICK611I MAIN STORAGE NOT AVAILABLE, MAPALT TERMINATED

Explanation: Dynamic acquisition of storage for control blocks and work areas failed.

System Action: MAPALT command processing ends.

Operator Response: Increase main storage size, then resubmit the job.

System Programmer Response: None.

ICK705I VOLUME SERIAL NUMBER FOR DEVICE ccuu IS xxxxxx

Explanation: This is an informational message containing the volume serial and VTOC of the volume at *ccuu*.

If the volume serial was changed, you also receive one or both of these messages:

CHANGED FROM xxxxxx - The volume serial number of the *ccuu* was changed.

VOLUME SERIAL DUPLICATE FOR DEVICE *ccuu*. VOLUME MADE UNAVAILABLE - The new volume serial on the *ccuu* is a duplicate of a volume already known to the operating system. The device has been unloaded.

If the VTOC location was changed, you also receive the following:

VTOC LOCATION MOVED - The VTOC location of the volume at *ccuu* has moved.

System Action: ICKDSF continues processing.

Operator Response: None.

System Programmer Response: None.

Messages received at the output printer

ICK00001I FUNCTION COMPLETED, HIGHEST CONDITION CODE
WAS nn hh:mm:ss mm/dd/yy

Explanation: A command has been processed.

- The value *nn* is the last condition code (LASTCC) generated during processing.
- *hh:mm:ss* and *mm/dd/yy* are the hours, minutes, seconds and month, day, year respectively of the date and time of the message.

Note: The LASTCC value is the highest condition code found in the messages printed during command processing.

System Action: LASTCC is set to *nn*;

MAXCC is set to *nn* if *nn* is greater than the current value of MAXCC.

Operator Response: None.

System Programmer Response: None.

ICK00002I ICKDSF PROCESSING COMPLETE. MAXIMUM
CONDITION CODE WAS nn

Explanation: This message is issued upon completion of a ICKDSF job step. The highest condition code (MAXCC) set during the job step is printed (see message ICK00001I) and returned to the ICKDSF invoker in register 15.

System Action: None.

Operator Response: None.

System Programmer Response: None.

ICK00091I ccuu NED=ttttt.mmm.mfg.lc.ssssssssss

Explanation: The device NED is shown for the device. Either the device is connected on a single path, or if multiple paths to his host exist, the NED information was found to match for all paths. The NED information shown is in the following format:

ttttt = device type
mmm = model
mfg = manufacturer
lc = manufacturing location
sssssssssss = sequence number

Note: The information in the above fields are printed as they are returned from the device. If blanks are returned, then blanks will be printed. Unprintable characters may be printed as '.'. Some examples of this are:

- The device type field, ttttt, is a 6-digit field. The information is printed in the message as it is returned from the device. For example, when the first 2-digits are returned as blanks by the device, they will be printed as blanks in the message. So the device type field will appear to have leading blanks.
- Some devices (for example 2105) returns blanks in the model field, so the model field will be blank in the message.

System Action: Processing continues.

Operator Response: None.

System Programmer Response: If the information is not correct for this device, take the necessary action to determine if a configuration error exists and correct the problem.

ICK00100I I/O DELAY IS SET TO nnnn AFTER EVERY m I/O
INVOCATION

Explanation: The time delay is reset to *none*.

System Action: No time delay will be provided for succeeding ICKDSF commands.

Operator Response: None.

System Programmer Response: None.

ICK00101I I/O DELAY IS SET TO NONE

Explanation: The time delay is reset to *none*.

System Action: No time delay will be provided for succeeding ICKDSF commands.

Operator Response: None.

System Programmer Response: None.

ICK00204I PRECEDING COMMAND BYPASSED DUE TO
CONDITION CODES

Explanation: The specified IF-THEN-ELSE command sequence caused the command to be bypassed. When specifying an IF-THEN-ELSE command sequence, either the THEN or the ELSE clause is processed. The clause that is not processed is bypassed.

System Action: The bypassed portion of the command sequence is checked for syntax errors but is not processed. ICKDSF processing continues.

Operator Response: None.

System Programmer Response: None.

ICK00206I IMPROPERLY PLACED COMMA HAS BEEN FOUND AND
IGNORED

Explanation: The command contained a redundant comma. It is ignored.

Note: Positional parameters cannot be omitted by the use of commas.

Leading positional parameters cannot be omitted.

System Action: Command processing continues.

Operator Response: None.

System Programmer Response: Correct the syntax error to prevent the message from reoccurring. Save the job output and contact your IBM service representative.

Messages received at the output printer

ICK00215I MINIDISK INFORMATION FOR DEVICE ccuu

RELOCATION FACTOR = nnnnn
SIZE = mmmmm
OWNER = owner-id
FPO LINK ADDRESS = xxxx

Explanation: This message indicates the location of the user minidisk on the real volume. (For example, for CKD devices, cylinder 0 of the mini-disk is located at cylinder nnnn of the real volume.) Relocation factor and minidisk size are in decimal. The user's minidisk is full-pack overlay LINKed to the invoker as virtual address xxxx by ICKDSF.

System Action: Command processing continues.

Operator Response: None.

System Programmer Response: None.

ICK00222I WARNING: COMMAND-END DELIMITER APPEARS WITHIN APOSTROPHES

Explanation: There is a semicolon (the optional command delimiter) inside a quoted string. A closing single quotation mark may have been omitted.

System Action: The usage is accepted, and the semicolon is treated as a valid character instead of as a delimiter.

Operator Response: None.

System Programmer Response: Check the usage of the semicolon, and correct if necessary.

ICK00233I TOO MANY RIGHT PARENTHESES FOUND. EXCESS IGNORED

Explanation: There are too many closing parentheses at the end of the command or following a first-level parameter.

System Action: The excess is ignored, and command processing continues.

Operator Response: None.

System Programmer Response: Remove the excess parentheses.

ICK00546I DATA SET NAME = data.set.name

Explanation: The name of the data set that occupies the VTOC extent you specified in VTOC expansion processing.

System Action: Command processing continues.

Operator Response: None.

System Programmer Response: None.

ICK00700I DEVICE INFORMATION FOR ccuu IS CURRENTLY AS FOLLOWS:

PHYSICAL DEVICE=yyyy
LOGICAL DEVICE=yyyy
STORAGE CONTROLLER=aaaa
STORAGE CONTROL DESCRIPTOR=bb
DEVICE DESCRIPTOR=cc
ADDITIONAL DEVICE INFORMATION =
XXXXXXXX

Explanation: PHYSICAL DEVICE=yyyy identifies the physical device type for the unit being processed. This message is always issued.

LOGICAL DEVICE=yyyy identifies the logical device. This line is displayed only if the logical device is different from the physical device.

STORAGE CONTROLLER=aaaa identifies the storage control type for the unit being processed. This is displayed if the sense-id CCW is supported.

STORAGE CONTROL DESCRIPTOR=bb describes the features associated with the storage controller. It contains the information in sense-id byte 3. (See the device storage control document for more information concerning the specific meaning of this byte.) This message is issued if the sense-id CCW is supported.

DEVICE DESCRIPTOR=cc describes the features associated with the device. It contains the information in sense-id byte 6. (See the device storage control document for more information concerning the specific meaning of this byte.) This message is issued if the sense-id CCW is supported.

ADDITIONAL DEVICE INFORMATION = XXXXXXXX is used by your IBM service representative in helping with problem diagnosis.

System Action: ICKDSF command processing continues.

Operator Response: None.

System Programmer Response: None.

ICK00701I EQUIPMENT CHECK RETRY SUCCESSFUL

Explanation: The system has successfully recovered from an equipment check.

System Action: Command processing continues.

Operator Response: None.

System Programmer Response: None. The channel command word (CCW), channel status word (CSW), and sense information are provided to help determine the cause of the error if the assistance of a service representative is required.

ICK00702I SECONDARY VOLUME DEVICE

DESCRIPTOR = cc

Explanation: This message follows ANALYZE or INSPECT command processing on the secondary volume of a dual copy pair when the primary and secondary volumes are different model devices. For more information, see the explanation of the *DEVICE DESCRIPTOR* for message ICK00700I.

System Action: Command processing continues.

Operator Response: None.

System Programmer Response: None.

ICK00703I DEVICE IS OPERATED AS A MINIDISK

Explanation: ICKDSF has determined that the device being used is a minidisk.

System Action: Command processing continues.

Messages received at the output printer

Operator Response: None.

System Programmer Response: None.

ICK00704I **DEVICE DOES NOT SUPPORT MEDIA MAINTENANCE FUNCTIONS**

Explanation: ICKDSF has determined that the device being used is a minidisk or that the device does not support media maintenance functions.

System Action: Command processing continues.

Operator Response: None.

System Programmer Response: None.

ICK00705I **SUBSYSTEM INFORMATION FOR ccuu IS CURRENTLY AS FOLLOWS:**

SUBSYSTEM SERIAL NUMBER = xxxxx
SUBSYSTEM ID = xxxx
CHANNEL CONNECTION ADDRESS = xx
LSS NUMBER = xx

Explanation: Subsystem information for the device is printed. The information printed is variable depending on the device being processed.

SUBSYSTEM SERIAL NUMBER = xxxxx identifies the last five digits of the Subsystem or Storage Control sequence number. (Or last 7 digits for RVA devices.)

SUBSYSTEM ID = xxxx identifies the user assigned number that identifies a DASD subsystem.

CHANNEL CONNECTION ADDRESS = xx identifies the I/O address that uniquely identifies an I/O device to the channel during an I/O operation. This is not printed for RVA devices.

LSS NUMBER = xx identifies the Logical Subsystem (LSS) number. This is printed when running on a 2105.

System Action: None.

Operator Response: None.

System Programmer Response: None.

ICK00706I **SUBSYSTEM INFORMATION FOR ccuu IS CURRENTLY AS FOLLOWS:**

SUBSYSTEM SERIAL NUMBER = xxxxx
SUBSYSTEM ID = xxxx
CHANNEL CONNECTION ADDRESS = xx
PATHS/CLUSTER ID = xx
SYSTEM ADAPTER ID = xx
HOST LINK ADDRESS = xxxx
LSS NUMBER = xx

Explanation: Subsystem information for the device is printed. The information printed is variable depending on the device being processed.

SUBSYSTEM SERIAL NUMBER = xxxxx identifies the last 5 digits of the Storage Control sequence number.

SUBSYSTEM ID = xxxx identifies the user-assigned number that identifies a DASD subsystem. This number is set by the service representative at installation and is included in the vital product data.

CHANNEL CONNECTION ADDRESS = xx identifies the I/O address that uniquely identifies an I/O device to the channel during an I/O operation.

PATHS/CLUSTER ID = xx identifies which storage path for the cluster is configured in the Storage Director (Bit 0 - Storage path zero, Bit 1 - Storage path one). This will print N/A if it is not applicable to the control unit or the device being processed.

SYSTEM ADAPTER ID = xx identifies the channel interfaces.

HOST LINK ADDRESS = xxxx identifies the ESCON/host Link Address (all 0s for parallel channels). The length of the link address printed will vary depending on the type.

LSS NUMBER = xx identifies the Logical Subsystem number. This is printed when running on a 2105.

System Action: None.

Operator Response: None.

System Programmer Response: None.

ICK00707I **MIRRORING OPERATIONAL**

Explanation: The mirroring status of the device is operational. This message is issued for information purposes only. The mirroring status does not affect ICKDSF processing.

System Action: Command processing continues.

Operator Response: None.

System Programmer Response: None.

ICK00708I **MIRRORING PENDING**

Explanation: The mirroring status of the device is pending. This message is issued for information purposes only. The mirroring status does not affect ICKDSF processing, and therefore will have no effect on the ICKDSF condition code of the command being executed.

System Action: Command processing continues.

Operator Response: None.

System Programmer Response: None.

ICK00709I **MIRRORING FAILED**

Explanation: Mirroring has failed for this device. This is due to a hardware failure. A Service Call will automatically be made to resolve the problem is resolved and the re-synchronization process is begun. Mirroring will become Operational after the re-synchronization is completed. This message is issued for information purposes only. The mirroring status does not affect ICKDSF processing, and therefore will have no effect on the ICKDSF condition code of the command being executed.

System Action: Command processing continues.

Operator Response: Notify your System programmer.

System Programmer Response: None required since this is a temporary condition that will resolve itself. However, since the data on this device is not currently being protected by mirroring, you may decide to move this data and/or new allocations to a device which is currently mirrored.

Messages received at the output printer

ICK01016I ALTERNATE TRACK CCHH=X'cccc hhhh' ASSIGNED TO PRIMARY TRACK CCHH=X'cccc hhhh'

Explanation: An alternate track was assigned to a primary track because:

The primary track was marked defective or was found to be defective by surface checking; or

There was a request for an unconditional alternate track assignment for the primary track.

System Action: Command processing continues.

Operator Response: None.

System Programmer Response: None.

ICK01018I ALTERNATE CCHH=X'cccc hhhh' RE-ASSIGNED FOR PRIMARY CCHH=X'cccc hhhh'

Explanation: The alternate track originally assigned to the indicated primary track was either:

marked defective, or

was found defective through surface checking. Another alternate track was assigned in place of the original alternate track.

(If the PRESERVE option was specified, the data on the original alternate track was copied to the new alternate track.)

System Action: Command processing continues.

Operator Response: None.

System Programmer Response: None.

ICK01020I ALTERNATE TRACK CCHH=X'cccc hhhh' WAS RECLAIMED

Explanation: An alternate track previously marked defective was not defective when surface checking was performed.

The track is added to the set of available alternate tracks.

System Action: Command processing continues.

Operator Response: None.

System Programmer Response: None.

ICK01021I PRIMARY TRACK CCHH=X'cccc hhhh' WAS RECLAIMED

Explanation: A primary track previously marked defective was not defective when surface checking was performed.

The primary track is marked available, and the assigned alternate track is added to the set of available alternate tracks.

(If the PRESERVE parameter was specified, any data written on the alternate track is copied back to the reclaimed primary track.)

System Action: Command processing continues.

Operator Response: None.

System Programmer Response: None.

ICK01022I DEFECTIVE PRIMARY TRACK STATUS WILL BE RESET FOR TRACK X'cccc hhhh'

Explanation: During the INSTALL/REVAL command process, the defective primary track status for the specified track will be disassociated from the alternates.

Surface checking function will be performed to the specified primary track later to determine if the track is defective.

System Action: Command processing continues.

Operator Response: None.

System Programmer Response: None.

ICK01135I PRESERVE INFORMATION EXISTS ON CE CYLINDER FOR TRACK X'cccc hhhh'

Explanation: During ANALYZE DRIVETEST processing, it was determined that the PRESERVE function of the INSPECT command did not run to completion for the specified track.

Surface checking function will be performed to the specified primary track later to determine if the track is defective.

System Action: Command processing continues.

Operator Response: None.

System Programmer Response: None.

ICK01136I CONTINUE INFORMATION EXISTS ON CE CYLINDER FOR TRACK X'cccc hhhh'

Explanation: During ANALYZE DRIVETEST processing, it was found that a previous invocation of the INIT command did not run to completion. X'cccc hhhh' represents the last track for which a checkpoint was taken.

It is likely a track beyond this checkpoint is not usable.

System Action: This information is not erased. ANALYZE command processing continues with the remainder of the drive test.

Operator Response: None.

System Programmer Response: Run the INIT command for this device to make sure the tracks following the previous checkpoint are usable.

ICK01305I ccuu ALL DATA "MACHINE READABLE"

Explanation: This is an informational message indicating that all data on the volume can be read successfully.

System Action: Command processing continues.

Operator Response: None.

System Programmer Response: None.

ICK01306I SKIP DISPLACEMENTS ASSIGNED

Explanation: This is an informational message indicating that there was a skip displacement process and skip displacements have been successfully assigned.

System Action: Command processing continues.

Operator Response: None.

Messages received at the output printer

System Programmer Response: None.

ICK01307I DEFECTIVE TRACK LIST IN HEXADECIMAL FOR
VOLUME vol1id

Explanation: This message is the first line of the volume map. A list in hexadecimal follows, showing any tracks that were found defective during the command processing.

System Action: Command processing continues.

Operator Response: None.

System Programmer Response: None.

ICK01308I THE FOLLOWING PRIMARY TRACKS WERE FOUND
DEFECTIVE:

Explanation: This message is a line in the volume map that identifies (in hexadecimal) any primary tracks that were found defective during command processing.

System Action: Command processing continues.

Operator Response: None.

System Programmer Response: None.

ICK01309I THE FOLLOWING ALTERNATE TRACKS WERE FOUND
DEFECTIVE:

Explanation: This message is a line in the volume map that identifies (in hexadecimal) any alternate tracks that were found defective during the command processing.

System Action: Command processing continues.

Operator Response: None.

System Programmer Response: None.

ICK01310I NO DEFECTIVE TRACKS WERE FOUND

Explanation: This message is a line in the volume map indicating that no defective tracks were found during the command processing.

When the command does not specify that all the tracks were to be checked, unchecked tracks could be defective.

System Action: Command processing continues.

Operator Response: None.

System Programmer Response: None.

ICK01311I NO DEFECTIVE PRIMARY TRACKS WERE FOUND

Explanation: This message is a line in the volume map indicating that no defective primary tracks were found during command processing.

When the command does not specify that all the primary tracks are to be checked, unchecked primary tracks could be defective.

System Action: Command processing continues.

Operator Response: None.

System Programmer Response: None.

ICK01312I NO DEFECTIVE ALTERNATE TRACKS WERE FOUND

Explanation: This message is a line in the volume map indicating that no defective alternate tracks were found during command processing.

When the command does not specify that all of the alternate tracks are to be checked, unchecked alternate tracks could be defective.

System Action: Command processing continues.

Operator Response: None.

System Programmer Response: None.

ICK01313I VOLUME CONTAINS nnnn ALTERNATE TRACKS --
mmmm AVAILABLE

Explanation:

System Action: Command processing continues.

Operator Response: None.

System Programmer Response: None.

ICK01314I VTOC IS LOCATED AT CCHH=X'cccc hhhh' AND
IS xxxx TRACKS

Explanation: This message is a line in the volume map showing the cylinder and track where the volume table of contents begins and the number of tracks it occupies.

System Action: Command processing continues.

Operator Response: None.

System Programmer Response: None.

ICK01315I VOLUME IS IN UN-INITIALIZED STATE

Explanation: Volume label and volume table of contents (VTOC) information were erased during the REVAL/INSTALL command process. The volume has no volume label or VTOC.

System Action: None.

Operator Response: None.

System Programmer Response: If the REVAL/INSTALL command process was successful, use the INIT command to initialize the volume. For VM, use the CPVOLUME command to initialize the volume.

ICK01316I INSTALL FUNCTION COMPLETED SUCCESSFULLY

Explanation: The INSTALL command processing completed successfully.

System Action: ICKDSF ended normally. Processing continues with your next command.

Operator Response: None.

System Programmer Response: None.

Messages received at the output printer

ICK01317I VT0C-INDEX IS LOCATED AT CCHH=X'cccc hhhh'
AND IS xxxx TRACKS.

Explanation: This message shows the cylinder and track where the volume table of contents index begins and the number of tracks it occupies.

System Action: Command processing continues.

Operator Response: None.

System Programmer Response: None.

ICK01318I REVAL FUNCTION COMPLETED SUCCESSFULLY

Explanation: The REVAL command processing completed successfully.

System Action: ICKDSF ended normally. Processing continues with your next command.

Operator Response: None.

System Programmer Response: None.

ICK01319I VOLUME IS TEMPORARILY NOT AVAILABLE FOR
IPL

Explanation: Surface checking is performed on cylinder 0 head 0 during the concurrent media maintenance process. The track is marked defective and the data is preserved on an alternate track. The volume cannot be used to IPL during this process.

System Action: Command processing continues.

Operator Response: None.

System Programmer Response: None.

ICK01320I LOGICAL DEVICE TYPE IS NOW SET TO : xxxx

Explanation: The mode change function of the INSTALL command is complete, and the logical device type is now type xxxx.

System Action: Command processing continues.

Operator Response: None.

System Programmer Response: None.

ICK01323I VOLUME CONTAINS nn ALTERNATE

LOCATIONS, mm ASSIGNED,
jj UNAVAILABLE,
kk AVAILABLE

Explanation: This message maps a volume:

nn is the total number of alternate locations reserved for the device;

mm is the number of alternate locations that have been assigned (to primary tracks);

jj is the number of locations not available for use by the subsystem;

kk is the number of locations still available for alternate assignment.

System Action: None.

Operator Response: None.

System Programmer Response: None.

ICK01328I SURFACE ANALYSIS PROCESSING ON TRACK
X'XXXX XXXX'

Explanation: Skip displacement processing has been performed for the specified track.

System Action: Command processing continues.

Operator Response: None.

System Programmer Response: None.

ICK01331I TRACK X'cccc hhhh' MAY REQUIRE INSPECTION

Explanation: During CHECK NOSKIP processing, a data check was detected on track X'cccc hhhh'. Further processing, however, did not detect a defect.

This message indicates that if an INSPECT TRACKS (X'cccc', X'hhhh') CHECK(n) is done subsequently for this track, a defect might be detected (and skipped).

System Action: INIT or INSPECT command processing continues with the next track.

Operator Response: None.

System Programmer Response: After completion of the INIT or INSPECT command, the programmer may want to run an INSPECT CHECK(n) TRACKS(...) for any track indicated in the message.

ICK01332I SURFACE ANALYSIS CYLINDER COULD NOT BE
UPDATED

Explanation: After assigning a skip displacement to a track, ICKDSF could not update the delta map on the surface analysis cylinder with the current skip displacement data for this track.

The CCW, CSW, and sense information associated with the message is printed.

System Action: Processing the track that contains the defect is completed successfully. If the home address becomes unreadable, subsequent processing of this track may require analysis of the entire track to locate the defect.

This message is for information only, since there is no consequence to the user resulting from this condition.

Operator Response: None.

System Programmer Response: None. Since the usability of the track is not affected, there is no need to examine further information. However, it is possible to examine the failing CCW, CSW, and sense information in detail if necessary.

ICK01334I CURRENTLY PROCESSING TRACK CCHH=X'cccc
hhhh'

Explanation: Information message given when ICKDSF is performing full volume processing. The message is issued to show ICKDSF progress.

System Action: Command processing continues with the next track.

Messages received at the output printer

Operator Response: None.

System Programmer Response: None.

ICK01336I TRACK X'cccc hhhh' EXPERIENCED
NON-RECURRING DATA CHECKS

Explanation: Skip displacement analysis processing for this track detected multiple discrete data checks that were not repeatable.

System Action: Command processing continues with the next track.

Operator Response: None.

System Programmer Response: This condition might arise from too much random noise on a track. If this message is issued for multiple tracks, or many tracks under the same head, this could indicate a potential hardware problem.

Save the job output and contact your IBM hardware service representative.

ICK01380I THE FOLLOWING TRACKS ARE UNRECOVERABLE:

Explanation: This message is a line in the volume map that identifies tracks that were found unrecoverable during command processing. An unrecoverable track is a track where the home address and record 0 cannot be read successfully after making all recovery attempts. This message is followed by this unrecoverable tracks information: CCHH of track =X'cccc hhhh'.

System Action:

- If the track is unrecoverable because of a data error, the command runs to completion with an error return code.
- If the track is unrecoverable because of an error not related to data, command processing ends after error detection.

Operator Response: None.

System Programmer Response: Prior messages should be examined (including the CCW, CSW, and sense that caused the I/O) to determine the cause of the failure.

This message can occur if the read/write mode switch is set to READ mode, or if some other condition prevents ICKDSF from writing on the volume.

Assistance may be required from the IBM hardware service representative. Save the job output and contact your IBM hardware service representative.

ICK01381I RECURRING CORRECTABLE ERRORS ON TRACKS:
X'cccc hhhh'

Explanation: This message is a line in the volume map that identifies tracks where ICKDSF detected recurring correctable data checks. The message is issued only for those count-key-data devices that do not have skip displacement areas. The message is followed by this track information: CCHH of track =X'cccc hhhh'.

System Action: The command completed successfully.

Operator Response: None.

System Programmer Response: If a correctable data check on the indicated track is determined to be detrimental to installation, an alternate track can be unconditionally assigned

to the indicated track using the INSPECT command.

Save the job output and contact your IBM service representative.

ICK01400I ccuu ANALYZE STARTED

Explanation: ANALYZE has begun running its tests on the logical volume identified in the message (that is, on the volume whose unit address is ccuu).

System Action: Command processing continues.

Operator Response: None.

System Programmer Response: None.

ICK01405I ccuu ALL DATA "MACHINE READABLE" WITHOUT
ERRORS

Explanation: The data verification test (SCAN option) successfully read the volume.

System Action: Command processing ends normally.

Operator Response: None.

System Programmer Response: (If you ran ANALYZE because of a data problem, and the problem persists, further analysis is needed according to your installation's procedures.)

ICK01406I ccuu ANALYZE ENDED

Explanation: ANALYZE command has completed processing.

System Action: Command processing ends.

Operator Response: None.

System Programmer Response: None.

ICK01407I ccuu NO DRIVE PROBLEMS FOUND

Explanation: Drive tests successfully completed running and did not detect any problems.

System Action: Command processing continues.

Operator Response: None.

System Programmer Response: None.

ICK01408I ccuu DATA VERIFICATION TEST STARTED

Explanation: ANALYZE has begun running its data verification tests.

System Action: Command processing continues.

Operator Response: None.

System Programmer Response: None.

ICK01409I DRIVE TEST STARTED

Explanation: Drive test processing is beginning.

System Action: Drive test command processing continues.

Operator Response: None.

System Programmer Response: None.

Messages received at the output printer

ICK01410I DRIVE TEST: TESTING SUCCESSFUL ON:

CHPID = XX
CHANNEL NUMBER = X
CHANNEL SET = X
STORAGE DIRECTOR ID = XX
SUBSYSTEM ID = XXXX
CLUSTER = X
STORAGE PATH = X

Explanation:

- The drive test successfully completed processing on the indicated path, where:
- CHPID = XX identifies the CHPID for the path being processed. This line is displayed only if it applies to the operating system environment.
- CHANNEL NUMBER = X identifies the channel number for the path being processed. This line is displayed only if it applies to the operating system environment.
- CHANNEL SET = X identifies the channel set (CPU affinity) for the path being processed. This line is displayed only if it applies to the operating system environment.
- STORAGE DIRECTOR ID = XX identifies the Storage Director Id for the path being processed. It contains the information present in sense byte 21. This line is displayed only if it applies to the storage control being processed.
- SUBSYSTEM ID = XXXX identifies the Subsystem Id for the path being processed. It contains the information present in sense bytes 20 and 21. This line is displayed only if it applies to the storage control being processed.
- CLUSTER = X identifies the Cluster for the path being processed. This line is displayed only if it applies to the storage control being processed.
- STORAGE PATH = X identifies the Storage Path of the Cluster being processed. This line is displayed only if it applies to the storage control being processed.

System Action: ICKDSF processing of the command continues.

Operator Response: None.

System Programmer Response: None.

ICK01411I FUNCTIONAL VERIFICATION DATA WRITE/READ TEST STARTED

Explanation: HA/R0 validation and functional data verification test of the specified range for the REVAL command has started.

System Action: Command processing continues.

System Programmer Response: None.

Operator Response: None.

ICK01412I FUNCTIONAL VERIFICATION DATA WRITE/READ TEST ENDED

Explanation: HA/R0 validation and functional data verification test of the specified range for the REVAL command has ended.

System Action: Command processing continues.

System Programmer Response: None.

Operator Response: None.

ICK01413I IN THIS ENVIRONMENT PATH CONTROL WILL ONLY PROCESS ON CHANNEL: X

Explanation: When using path control in this Stand-Alone environment, only the channel shown is processed on the first channel set located. Refer to the path control parameters for restrictions when operating in this environment.

System Action: Command processing continues.

Operator Response: None.

System Programmer Response: None.

ICK01414I THE FOLLOWING ERRORS WERE ALSO DETECTED

Explanation: When a drivetest failure occurs, this message provides sense data for the service representative. (Please refer to preceding messages ICK21407 and ICK21409.)

System Action: Command processing continues.

Operator Response: None.

System Programmer Response: Contact your IBM hardware service representative.

ICK01415I CORRECTABLE DATA CHECK OCCURRED ON CE CYLINDER, HEAD = X'hhhh', RECORD = X'rr'

Explanation: An I/O error occurred on the customer engineer (CE) cylinder on the head and record indicated. The message is followed by CCW, CSW, and sense bytes describing the record error.

System Action: ICKDSF command processing continues. Processing may eventually halt.

Operator Response: None.

System Programmer Response: If processing halts, the CCW, CSW, and sense information are provided for the service representative.

ICK01416D CHPID = XX, RESERVED, REPLY R TO RETRY, B TO BYPASS

Explanation: This message is issued to the system operator if processing encounters a path that remains reserved for all of its retries.

XX specifies the path (CHPID).

- Reply R to reissue the I/O operation to the device.
- Reply B to bypass further processing on this path.

System Action: See explanation.

Operator Response: Respond R or B.

System Programmer Response: None.

ICK01417D X, Y RESERVED, REPLY R TO RETRY, B TO BYPASS

Explanation: This message is issued to the system operator if processing encounters a path that remains reserved for all of its retries.

Messages received at the output printer

X specifies the channel number and Y specifies the channel set (CPU affinity).

- Reply R to reissue the I/O operation to the device.
- Reply B to bypass further processing on this path.

System Action: See explanation.

Operator Response: Respond R or B.

System Programmer Response: None.

ICK01418I REVALIDATE FIXSIM(4E4E) PROCESS STARTED

Explanation: Rewrite user data for the specified range has started.

System Action: Command processing continues.

Operator Response: None.

System Programmer Response: None.

ICK01419I REVALIDATE FIXSIM(4E4E) PROCESS ENDED

Explanation: Rewrite user data for the specified range has ended.

System Action: Command processing continues.

Operator Response: None.

System Programmer Response: None.

ICK01420I REVALIDATE FUNCTION STARTED WITHOUT FFVDP WRITE/READ TEST

Explanation: HA/R0 validation test of the specified range for the REVAL command has started. No factory functional verification data pattern will be written on the volume.

System Action: Command processing continues.

Operator Response: None.

System Programmer Response: None.

ICK01421I RECOVER PREVIOUS REVALIDATE FIXSIM(4E4E) CHECKPOINT

Explanation: A previous REVAL FIXSIM(4E4E) did not complete, ICKDSF restarts REVAL FIXSIM(4E4E) with the old range first. When the recovery process is completed, ICKDSF will then continue with the new range.

System Action: Command processing continues.

Operator Response: None.

System Programmer Response: None.

ICK01422I RECOVER PREVIOUS REVALIDATE DATA/NODATA CHECKPOINT

Explanation: Previous REVAL DATA or NODATA process did not complete. REVAL will process the previous range with the current specification, then process the new range.

System Action: Command processing continues.

Operator Response: None.

System Programmer Response: None.

ICK01425I PRIMARY TRACK CCHH = X'cccc hhhh' HAD BEEN SURFACE CHECKED

Explanation: An I/O error occurred while ICKDSF was rewriting the user data back to the primary track. ICKDSF has performed surface checking attempting to fix the primary track.

System Action: Command processing continues if the primary track was fixed by surface checking, otherwise the command terminates.

Operator Response: None.

System Programmer Response: If the command terminates, refer to the previous messages issued by the surface checking routine.

ICK01430I REVALIDATE REFRESH PROCESS STARTED

Explanation: Rewrite the user data for the specified range has started.

System Action: Command processing continues.

Operator Response: None.

System Programmer Response: None.

ICK01431I REVALIDATE REFRESH PROCESS ENDED

Explanation: Rewrite the user data for the specified range has ended.

System Action: Command processing continues.

Operator Response: None.

System Programmer Response: None.

ICK01432I RECOVER PREVIOUS REVALIDATE REFRESH CHECKPOINT

Explanation: Since previous REVAL REFRESH process did not complete, ICKDSF will run REVAL REFRESH with the old range first. When recovery process is completed, ICKDSF will then continue with the new range.

System Action: Command processing continues.

Operator Response: None.

System Programmer Response: None.

ICK01440I VOLSER, VTOC AND DATA IN THE SPECIFIED RANGE WILL BE ERASED

Explanation: The message was printed for REVAL DATA or REVAL NODATA processing. The VOL1 record, the VTOC pointer, and the data in the specified range will be erased. Data on the volume will be inaccessible when the REVAL process has completed.

System Action: Command processing continues.

Operator Response: None.

System Programmer Response: None.

Messages received at the output printer

ICK01501I INVALID DEVICE TYPE SPECIFIED FOR BUILDIX
COMMAND

Explanation: There is a format change request for a VTOC on a volume whose device type is not supported by the BUILDIX command (for example, a 2314 DASD).

System Action: Command processing ends.

Operator Response: None.

System Programmer Response: Verify that the volume is on a device type supported by the BUILDIX command, then change the JCL or command statement.

ICK01502I BUILDIX FUNCTION STARTED

Explanation: BUILDIX command processing has begun.

System Action: None.

Operator Response: None.

System Programmer Response: None.

ICK01503I ccuu REQUEST RECEIVED TO CONVERT VTOC TO
**FORMAT

Explanation: This message verifies the request for a change of VTOC format. "****" specifies the format requested—either OS or IX.

System Action: Command processing continues.

Operator Response: None.

System Programmer Response: None.

ICK01504I ccuu VTOC FORMAT IS CURRENTLY **FORMAT,
REQUEST ACCEPTED

Explanation: This message verifies that the BUILDIX function specified on the command statement is valid for the current format of the VTOC on the volume. "****" identifies the format of the VTOC, either OS or IX.

System Action: Command processing continues.

Operator Response: None.

System Programmer Response: None.

ICK01508A ccuu SHOULD CONVERSION PROCEED? REPLY U TO
CONTINUE, ELSE T

Explanation: This message permits the operator to verify that the user is authorized to request the BUILDIX function before command processing begins.

System Action: The system waits for the operator's reply.

Operator Response: Verify that the user is authorized to issue the command, and reply:
U to continue;
T to end processing.

Any reply other than U or T causes this message to be issued again.

System Programmer Response: None.

ICK01513I ccuu BUILDIX PROCESSING COMPLETED: VTOC IS
NOW IN **FORMAT

Explanation: The BUILDIX command completed successfully. ** shows the new VTOC format: either OS or IX.

System Action: ICKDSF ends normally.

Operator Response: None.

System Programmer Response: None.

ICK01520I THE VTOC-INDEX WAS DELETED

Explanation: ICKDSF deleted the index data set from the volume as it was no longer valid after the VTOC was rebuilt. If the device is online to the MVS environment, ICKDSF will then allocate a new index data set and rebuild the index.

System Action: Command processing continues.

Operator Response: None.

System Programmer Response: None.

ICK01600I MAPALT STARTED

Explanation: Processing has started for the MAPALT command.

System Action: None.

Operator Response: None.

ICK01606I nnnnn BLOCKS ASSIGNED TO ALTERNATES IN
LIMITS SPECIFIED

Explanation: This summary message shows the number of blocks assigned alternates, on this or previous runs, within the limits specified in the command statement.

System Action: None.

Operator Response: None.

System Programmer Response: None.

ICK01608I ccuu MAPALT ENDED NORMALLY, RETURN CODE= n

Explanation: Command completed without any errors detected that would have caused processing to end.

A return code of 0 or 4 will be indicated in the message.

- 0 means no errors were encountered;
- 4 means one or more recoverable errors were encountered.

System Action: None.

Operator Response: None.

System Programmer Response: None.

ICK01609I PERMANENT DATA CHECK FOUND READING ID FOR
BLOCK nnnnnn

Explanation: A permanent data check was encountered while attempting to read the ID field of the primary block shown in the message.

System Action: Diagnostic information is printed on the output device, and command processing continues.

Messages received at the output printer

Operator Response: None.

System Programmer Response: Save the job output for the system coordinator, and follow your installation's procedures for data recovery.

If this message is received for up to 3 blocks, the ICKDSF INSPECT command can be used to assign an alternate block for the blocks experiencing the data checks.

If this message is received for more than 3 blocks, contact your IBM hardware or software service representative. Save the job output and contact your IBM hardware service representative.

ICK01701I ONLY 5 USER VOL LABELS ALLOWED

Explanation: Only five user volume labels are allowed for fixed block architecture devices. The LABEL parameter has specified more than five labels.

System Action: Space is reserved for six labels, and command processing continues.

Operator Response: None.

System Programmer Response: None.

ICK01704I ALTERNATE ASSIGNED FOR BLOCK xxxxxxxx

Explanation: Block xxxxxxxx was found defective during surface analysis. The block has been assigned an alternate.

System Action: Command processing continues.

Operator Response: None.

System Programmer Response: None.

ICK01708I RECLAIM SUCCESSFUL FOR BLOCK xxxxxxxx

Explanation: BLOCK xxxxxxxx has been successfully reclaimed.

System Action: Command processing continues.

Operator Response: None.

System Programmer Response: None.

ICK01714I RECLAIM UNSUCCESSFUL FOR BLOCK xxxxxxxx

Explanation: The defective block xxxxxxxx failed surface analysis and could not be reclaimed.

System Action: An alternate is assigned to the block. Command processing continues.

Operator Response: None.

System Programmer Response: None.

ICK01715I TOTAL NUMBER OF ALTERNATES ASSIGNED = n

Explanation: N is the total number of alternate blocks assigned in this run.

System Action: Command processing continues.

Operator Response: None.

System Programmer Response: None.

ICK01725I EXCESSIVE NUMBER OF ALTERNATES ASSIGNED FOR A CYLINDER

Explanation: During initialization of a 3370 volume, more than 24 alternates were assigned on one cylinder. This exceeds the number of alternates on a cylinder.

System Action: Command processing continues.

Operator Response: None.

System Programmer Response: This could cause performance degradation on the volume. You may need to contact your IBM hardware service representative. Save the job output and contact your IBM service representative.

ICK01726I nnnnnn FACTORY FLAGGED BLOCKS.

Explanation: Final message of INIT reclaim processing. nnnnnn is the number of factory-flagged blocks assigned an alternate.

System Action: INIT processing surface analysis phase is started.

Operator Response: None.

System Programmer Response: None.

ICK01727I RECLAIM SPECIFIED WITH NOCHECK. NO RECLAIM DONE

Explanation: RECLAIM function was not performed, because NOCHECK was specified or defaulted. CHECK is required for RECLAIM.

System Action: Command processing continues without RECLAIM.

Operator Response: None.

System Programmer Response: For RECLAIM, specify CHECK and run the job again.

ICK01729I SPECIFIED CISIZE ADJUSTED TO NEXT HIGHER MULTIPLE OF DEVICE BLOCKSIZE

Explanation: When you specify a CISIZE which is not a multiple of 512, ICKDSF rounds the value up to the next higher multiple.

System Action: Command processing continues.

Operator Response: None.

System Programmer Response: None.

ICK01730I RECLAIM AND/OR CHECK NOT SUPPORTED FOR MINI-DISKS

Explanation: The requested CHECK and RECLAIM functions are not supported for fixed block architecture (FBA) minidisks.

System Action: Command processing continues without CHECK or RECLAIM.

Operator Response: None.

System Programmer Response: None. If CHECK or RECLAIM is needed, the full volume must be initialized.

Messages received at the output printer

ICK01731I MAP FUNCTION NOT SUPPORTED FOR MINI-DISKS

Explanation: The MAP parameter was specified or defaulted on the command, but MAP is not supported for FBA minidisks.

System Action: Command processing continues without MAP function.

Operator Response: None.

System Programmer Response: None

ICK01732I MAP FUNCTION NOT SUPPORTED FOR THIS DEVICE TYPE

Explanation: The MAP parameter was specified or defaulted on a device where MAP is not supported.

System Action: Processing bypasses the MAP function and continues.

Operator Response: None.

System Programmer Response: None Save the job output and contact your IBM service representative.

ICK01754I xx OF THE INSPECTED BLOCKS HAVE ALTERNATES ASSIGNED

Explanation: This summary message prints when MAP is specified. xx is the number of blocks inspected that have alternates assigned.

System Action: None.

Operator Response: None.

System Programmer Response: None.

ICK01759I USER DATA ON BLOCK xxxxxxxx RESTORED

Explanation: Command processing failed because of a permanent error, and ICKDSF was able to restore the data on block xxxxxxxx before ending command processing.

System Action: Current command processing is ended because of a previously reported error. Command processing continues with the next command.

Operator Response: None.

System Programmer Response: None.

ICK01760I SURFACE OF BLOCK xxxxxxxx DEFECTIVE

Explanation: The check function found the surface of BLOCK xxxxxxxx defective.

System Action: If ASSIGN is specified, an alternate is assigned.

Operator Response: None.

System Programmer Response: None.

ICK01761I SURFACE OF BLOCK xxxxxxxx NOT DEFECTIVE

Explanation: The check function found the surface of block xxxxxxxx not defective.

System Action: Command processing continues with the next block.

Operator Response: None.

System Programmer Response: None.

ICK01765I NEW ALTERNATE ASSIGNED TO BLOCK xxxxxxxx

Explanation: BLOCK xxxxxxxx has been assigned a new alternate.

System Action: Command processing continues.

Operator Response: None.

System Programmer Response: None.

ICK01781I dataset IS A PASSWORD PROTECTED DATA SET BUT USER EXIT DIRECTS BYPASS CHECK

Explanation: The user security exit module has directed ICKDSF to bypass password verification of the named password-protected data set on the volume.

System Action: Command processing continues.

Operator Response: None.

System Programmer Response: None.

ICK01795I TRACK X'cccc hhhh' IS CONTAINED IN DATA SET dataset

Explanation: The track specified in the command is contained in the named data set. (This message may be followed by others such as ICK31780I.)

System Action: Command processing continues.

Operator Response: None.

System Programmer Response: None.

ICK01832I PATH xxxx,y HAS BEEN WRITE ALLOWED

Explanation: This is an informational message indicating to the operator and the programmer which path ids have been write-allowed by the CONTROL command.

xxxx is the unit address, y is the path ID (CHPID).

System Action: Command processing continues.

Operator Response: All devices on that path have been cleared. However, the operator must vary the required paths back online to make them accessible.

System Programmer Response: None.

ICK01833I DEVICE ccuu FENCE STATUS CLEARED

Explanation: This is an informational message indicating that the fence status for the device ccuu has been cleared by the CONTROL command.

System Action: Command processing continues.

Operator Response: None

System Programmer Response: None

Messages received at the output printer

ICK01841I RESET INDEFINITE CONDITION OF DEVICE ccuu COMPLETE

Explanation: The device *reset indefinite condition* completed successfully.

System Action: Command processing ends.

Operator Response: None.

System Programmer Response: None.

ICK02100I LAST INVOCATION CHECKPOINTED AT X'cccc hhhh', RECOVERY IN PROCESS

Explanation: A previous use of the INIT command did not complete. The track specified in this message is the last checkpointed location.

System Action: The track being processed at the time of failure is returned to its proper condition. (Specific action depends on the device type and the reason for failure of the previously used INIT command.)

After the recovery process is complete, processing begins for this use of the INIT command.

Operator Response: None

System Programmer Response: None

ICK02101I INITIALIZE IS CONTINUING FROM TRACK X'cccc hhhh'.

Explanation: CONTINUE data existed when INIT was invoked.

System Action: Processing begins at track X'cccc hhhh' for the remainder of the CURRENT specified range.

Operator Response: None.

System Programmer Response: None.

ICK02103I INITIALIZE IS CONTINUING FROM BLOCK xxxxxxxx.

Explanation: CONTINUE data existed when INIT was invoked. xxxxxxxx indicates the last checkpointed block.

System Action: Processing begins with BLOCK xxxxxxxxxx for the remainder of the CURRENT specified range.

ICK02104I NO ADDITIONAL TRACKS REMAIN IN THE SPECIFIED RANGE

Explanation: CONTINUE processing was previously activated. (See ICK02101I.) After verification of the tracks necessary to ensure the validity of the volume, there were no additional tracks to process in the specified range.

System Action: Command processing continues with the minimal initialization functions.

Operator Response: None.

System Programmer Response: None.

ICK02105I PROCESSING IS CONTINUING FROM LAST CHECKPOINT

Explanation: The current command has detected that the previous command did not complete processing. Processing will continue from the last checkpoint.

System Action: Command processing continues from the last checkpoint.

Operator Response: None.

System Programmer Response: None.

ICK02128I RECOVERY PROCESS COMPLETE

Explanation: Recovery of data from the previous checkpoint is complete.

System Action: Command processing continues.

Operator Response: None.

System Programmer Response: None.

ICK02129I RECOVERY COMPLETE FOR TRACK X'cccc hhhh'

Explanation: The backup recovery function is complete for the specified track.

System Action: Command processing continues with the current invocation parameters.

Operator Response: None.

System Programmer Response: None.

ICK02150I INITIALIZE IS CONTINUING WITH RECLAIM PROCESSING

Explanation: A previous use of the INIT command did not complete during reclaim processing. The reclaim process is being restarted.

System Action: The reclaim process is restarted.

Operator Response: None.

System Programmer Response: None.

ICK02156I INITIALIZE PREVIOUSLY INTERRUPTED AT BLOCK xxxxxxxx

Explanation: A previous use of the INIT command did not complete. The block specified in the message is the last checkpointed location.

System Action: The CONTINUE data and specified parameters are examined to determine what processing should be done.

Operator Response: None.

System Programmer Response: None.

ICK02163I CONTINUE INFORMATION EXISTS ON CE CYLINDER FOR BLOCK xxxxxxxx

Explanation: During ANALYZE DRIVETEST processing, it was determined that a previous invocation of the INIT command did not run to completion. xxxxxxxx is the last block for which a checkpoint was taken.

Messages received at the output printer

System Action: Continue information is not erased. ANALYZE command processing continues with the remainder of the drive test.

System Programmer Response: This is an informational message.

If required by the circumstances of the previous INIT interruption, restart the INIT command specifying CONTINUE or NONCONTINUE.

ICK02164I PRESERVE INFORMATION EXISTS ON CE CYLINDER FOR BLOCK xxxxxxxx

Explanation: During ANALYZE DRIVETEST processing, it was determined that the PRESERVE function of the INSPECT command did not run to completion for the specified block. Data has been saved for this block.

System Action: This information is not erased. ANALYZE command processing continues with the remainder of the drive test.

Operator Response: None.

System Programmer Response: Run the INSPECT command for this device to make sure the specified block is usable, and to recover the data.

ICK02166I RECOVERY COMPLETE FOR BLOCK xxxxxxxx

Explanation: The backup recovery function is complete for the specified block.

System Action: Command processing continues with the current invocation parameters.

Operator Response: None.

System Programmer Response: None.

ICK02174I VOLUME CONTAINS xxxxx ALTERNATE TRACKS -- AVAILABLE ALTERNATES UNDETERMINED

Explanation: Since the VTOC for this volume cannot be read, or does not exist, the current number of available alternate tracks cannot be determined. Previous messages indicate why the VTOC is inaccessible. xxxxx is the total number of alternate tracks on the volume.

System Action: Command processing continues.

Operator Response: None.

System Programmer Response: See previous messages to determine why the VTOC is inaccessible.

ICK02201I PPRCOPY ESTPATH FUNCTION COMPLETED SUCCESSFULLY

Explanation: The PPRCOPY ESTPATH command used to establish Peer-to-Peer Remote Copy (PPRC) paths between two subsystems has completed successfully.

System Action: Command processing continues.

Operator Response: None.

System Programmer Response: None.

ICK02202I PPRCOPY DELPATH FUNCTION COMPLETED SUCCESSFULLY

Explanation: The PPRCOPY DELPATH command used to delete Peer-to-Peer Remote Copy (PPRC) paths between two subsystems has completed successfully.

System Action: Command processing continues.

Operator Response: None.

System Programmer Response: None.

ICK02203I PPRCOPY ESTPAIR FUNCTION COMPLETED SUCCESSFULLY

Explanation: The PPRCOPY ESTPAIR command used to establish remote copy pairs has completed successfully.

System Action: Command processing continues.

Operator Response: None.

System Programmer Response: None.

ICK02204I PPRCOPY DELPAIR FUNCTION COMPLETED SUCCESSFULLY

Explanation: The PPRCOPY DELPAIR command used to delete remote copy pairs has completed successfully.

System Action: Command processing continues.

Operator Response: None.

System Programmer Response: None.

ICK02205I PPRCOPY SUSPEND FUNCTION COMPLETED SUCCESSFULLY

Explanation: The PPRCOPY SUSPEND command used to suspend remote copy pairs has completed successfully.

System Action: Command processing continues.

Operator Response: None.

System Programmer Response: None.

ICK02206I PPRCOPY QUERY FUNCTION COMPLETED SUCCESSFULLY

Explanation: The PPRCOPY QUERY command used to query device status has completed successfully.

System Action: Command processing continues.

Operator Response: None.

System Programmer Response: None.

ICK02207I PPRCOPY RECOVER FUNCTION COMPLETED SUCCESSFULLY

Explanation: The PPRCOPY RECOVER command used to reestablish access to the secondary volume has completed successfully.

System Action: Command processing continues.

Operator Response: None.

System Programmer Response: None.

Messages received at the output printer

ICK02208I PPRCOPY FREEZE FUNCTION COMPLETED SUCCESSFULLY

Explanation: The PPRCOPY FREEZE command used to suspend all operations for all PPRC volumes on a single storage control has completed successfully.

System Action: Command processing continues.

Operator Response: None.

System Programmer Response: None.

ICK02209I PPRCOPY RUN FUNCTION COMPLETED SUCCESSFULLY

Explanation: The PPRCOPY RUN command used to resume all operations for all previously FREEZEed PPRC volumes on a single storage control has completed successfully.

System Action: Command processing continues.

Operator Response: None.

System Programmer Response: None.

ICK02210I *** COPY IN PROGRESS *******

Explanation: The MSGREQ(YES) parameter has been specified with the PPRCOPY ESTPAIR command. Copy is still in progress. ESTPAIR command has not yet been completed.

System Action: Command processing continues.

Operator Response: None.

System Programmer Response: None.

ICK02211I DEVICE IS IN CRITICAL WRITE STATE

Explanation: The primary device has been placed into a critical write state as specified by the PPRCOPY ESTPAIR command. In this state, the failure to write an update to the secondary results in a unit check and the primary device does not enter the suspended state.

System Action: Command processing continues.

Operator Response: None.

System Programmer Response: None.

ICK02212I COPY SUSPENDED BY HOST COMMAND DIRECTED TO THE PRIMARY

Explanation: The ESUSP parameter may have been specified to suspend after establishment.

System Action: Command processing continues.

Operator Response: None.

System Programmer Response: The detail status can be obtained by using the PPRCOPY QUERY command.

ICK02213I VOLUME IS ELIGIBLE FOR PPRC CASCADING

Explanation: This message is issued during PPRCOPY QUERY processing when the queried device supports the cascading functionality and has been set up as the primary of a Peer-to-Peer Copy pair. This device is eligible to become the

secondary of a Peer-to-Peer Copy pair that will complete the cascading relationship.

System Action: Command processing continues.

Operator Response: None.

System Programmer Response: None.

ICK02214I INFORMATION FOR THIS VOLUME AS A PRIMARY FOLLOWS

Explanation: This message is issued during PPRCOPY QUERY processing when the queried device is in a cascading state and information following this message relate to the device as the primary of the Peer-to-Peer Copy pair.

System Action: Command processing continues.

Operator Response: None.

System Programmer Response: None.

ICK02215I INFORMATION FOR THIS VOLUME AS A SECONDARY FOLLOWS

Explanation: This message is issued during PPRCOPY QUERY processing when the queried device is in a cascading state and information following this message relate to the device as the secondary of the Peer-to-Peer Copy pair.

System Action: Command processing continues.

Operator Response: None.

System Programmer Response: None.

ICK02230I DEVICE IS NOW IN SIMPLEX STATE

Explanation: PPRCOPY DELPAIR or RECOVER command completed successfully. The device is now in simplex state.

System Action: Command processing continues.

Operator Response: None.

System Programmer Response: None.

ICK02231I DEVICE IS NOW A PEER TO PEER REMOTE COPY VOLUME

Explanation: PPRCOPY ESTPAIR completed successfully. The device is now a Peer-to-Peer Remote Copy (PPRC) volume.

System Action: Command processing continues.

Operator Response: None.

System Programmer Response: None.

ICK02232I DEVICE IS NOW A SUSPENDED PPRC VOLUME

Explanation: PPRCOPY SUSPEND command completed successfully. The device is now a suspended PPRC volume.

System Action: Command processing continues.

Operator Response: None.

System Programmer Response: None.

Messages received at the output printer

ICK030001 CPVOL REPORT FOR *ccuu* FOLLOWS:

VOLUME SERIAL = *valid*
 {CYL|PAGE} RANGE TO BE FORMATTED
 IS *xxx - yyy*
 FORMATTING OF CYLINDER *xxx* STARTED
 AT *hh:mm:ss*
 TDSK CYLINDER(S) *xxxx-yyy* NOT
 EXAMINED
 FORMATTING OF CYLINDER *yyy* STARTED
 AT *hh:mm:ss*
 FORMATTING OF CYLINDER *zzz* ENDED
 AT *hh:mm:ss*
 VOLUME SERIAL NUMBER IS NOW = *valid*
 {CYL|PAGE} ALLOCATION IS AS FOLLOWS:
 TYPE START END TOTAL

type	xxxx	yyyy	zzzz
------	------	------	------

Explanation: VOLUME SERIAL=*valid* identifies the volume serial of the unit being processed.

{CYL|PAGE} RANGE TO BE FORMATTED IS *xxx - yyy* identifies the starting and ending values for the range of cylinders or FBA pages to be formatted. If the EXAMINE function was specified, this message will state "{CYL|PAGE} RANGE TO BE EXAMINED IS *xxx - yyy*".

FORMATTING OF {CYL|PAGE} *xxx* STARTED AT *hh:mm:ss* displays the time when formatting or examination was started.

FORMATTING OF {CYL|PAGE} *yyy* STARTED AT *hh:mm:ss* displays the time when formatting or examination started for cylinder/page *yyy*. This is a progress message that is repeated periodically (approximately every 100 cylinders or 10000 pages).

TDSK CYLINDER(S) *xxxx-yyy* NOT EXAMINED displays the starting and ending cylinders that were "skipped" by the EXAMINE process. TDSK cylinders are not always in a format that can be read by EXAMINE and consequently are bypassed.

FORMATTING OF {CYL|PAGE} *zzz* ENDED AT *hh:mm:ss* displays the time when formatting or examination ended.

VOLUME SERIAL NUMBER IS NOW = *valid* identifies the new volume serial of the unit being processed if *VOLID(serial)* was specified in the CPVOLUME command.

{CYL|PAGE} ALLOCATION IS AS FOLLOWS: displays the contents of the allocation map.

System Action: ICKDSF processing of the command continues.

Operator Response: None.

System Programmer Response: None.

ICK030051 AIXVOL REPORT FOR *ccuu* FOLLOWS:

VOLUME SERIAL = *valid*
 CYLINDER RANGE TO BE FORMATTED IS
xxx - yyy
 FORMATTING OF CYLINDER *xxx* STARTED AT
hh:mm:ss
 FORMATTING OF CYLINDER *yyy* STARTED AT
hh:mm:ss
 FORMATTING OF CYLINDER *zzz* ENDED AT

hh:mm:ss
 VOLUME SERIAL NUMBER IS NOW = *valid*

Explanation: VOLUME SERIAL=*valid* identifies the volume serial of the unit being processed.

CYLINDER RANGE TO BE FORMATTED IS *xxx - yyy* identifies the starting and ending values for the range of cylinders to be formatted. If the EXAMINE function was specified, this message will state "CYLINDER RANGE TO BE EXAMINED IS *xxx - yyy*".

FORMATTING|EXAMINATION OF CYLINDER *xxx* STARTED AT *hh:mm:ss* displays the time when formatting or examination was started.

FORMATTING|EXAMINATION OF CYLINDER *yyy* STARTED AT *hh:mm:ss* displays the time when formatting or examination started for cylinder *yyy*. This is a progress message that is repeated periodically (approximately every 100 cylinders).

FORMATTING|EXAMINATION OF CYLINDER *zzz* ENDED AT *hh:mm:ss* displays the time when formatting or examination ended.

VOLUME SERIAL NUMBER IS NOW = *valid* identifies the new volume serial of the unit being processed if *VOLID(serial)* was specified in the AIXVOL command.

System Action: Command processing continues.

Operator Response: None.

System Programmer Response: None.

ICK030101 SPECIFIED RANGE (*xxxx,yyyy*); VOLUME END LIMITED TO *nnnn*

Explanation: A formatting range or allocation type statement specified an ending range value *yyyy* that exceeds the capacity *nnnn* of the volume.

System Action: CPVOLUME and AIXVOL replaces *yyyy* with *nnnn* and command processing continues.

Operator Response: None, if the resulting range is acceptable. Otherwise, run CPVOLUME or AIXVOL again using the correct range value.

System Programmer Response: None.

ICK030111 CYLINDER|PAGE RANGE TO BE FORMATTED IS
xxxx-yyy CYLINDER|PAGE RANGE TO BE
 EXAMINED IS *xxxx-yyy*

Explanation: *xxxx* is the starting cylinder or page to be formatted or examined by the CPVOLUME or AIXVOL command. *yyyy* is the ending cylinder to be formatted or examined by the CPVOLUME or AIXVOL command.

System Action: Command processing continues.

Operator Response: None.

System Programmer Response: None.

ICK030201 CPVOL WILL PROCESS *ccuu* FOR
 [VM/370|XA|ESA] MODE

Explanation: CPVOLUME has determined that its operating mode is either VM/370, VM/XA or VM/ESA. Volumes formatted in the VM/ESA mode can be used on either VM/ESA or z/VM

systems. CPVOLUME will format the device for the specified operating system.

System Action: Command processing continues.

Operator Response: None, if the MODE is acceptable.

System Programmer Response: None.

ICK03021I ccuu IS FORMATTED FOR
[VM/370|VM/XA|VM/ESA|ESA] MODE

Explanation: CPVOLUME has determined that the device has been formatted for use in a VM/370, VM/XA or VM/ESA, or VM/ESA-only environment.

System Action: Command processing continues.

Operator Response: None.

System Programmer Response: None if the mode is acceptable.

ICK03022I FORMATTING THE DEVICE with/without FILLER RECORDS

Explanation: The volume will be formatted with or without filler records, depending on the device status and parameter specification.

System Action: Command processing continues.

Operator Response: None.

System Programmer Response: None.

ICK03024I DEVICE IS CURRENTLY FORMATTED with/without FILLER RECORDS

Explanation: The volume you specified is currently formatted with or without filler records.

System Action: Command processing continues.

Operator Response: None.

System Programmer Response: Not applicable.

ICK03025I AIXVOL WILL PROCESS ccuu FOR AIX/ESA MODE

Explanation: AIXVOL will process the device specified for use in an AIX/ESA environment.

System Action: Command processing continues.

Operator Response: None.

System Programmer Response: None.

ICK03026I TRACK CENTER TEST DATA EXISTS, SELECTED HEADS WILL BE FORMATTED

Explanation: INSTALL command will only format the heads that are indicated by the track center data. If track center data does not exist, INSTALL formats the whole volume.

System Action: Command processing continues.

Operator Response: None.

System Programmer Response: None.

ICK03030I ALLOCATION MAP WILL BE EXPANDED FROM xxxx TO yyyy [CYLS|PAGES] ALLOCATION MAP WILL BE REDUCED FROM xxxx TO yyyy [CYLS|PAGES]

Explanation: The volume specified by the UNIT parameter was previously formatted with an allocation map that no longer matches the actual number of cylinders contained on the device. The value xxxx is the highest cylinder defined in the allocation map. If the unit is a dedicated device, yyyy is the number of cylinders for the native device. If the unit is a mini-disk, yyyy is the number of cylinders for the mini-disk.

This condition can occur:

- When a CP formatted volume is copied or restored to a volume that contains more cylinders. For example, if a 3380D is copied to a 3380E, the message will indicate that the allocation map must be expanded from 885 to 1770 cylinders.
- When a previously formatted mini-disk is redefined with a different number of cylinders.
- When the MIMIC(MINI(xxx)) parameter specifies a value xxx that does not agree with the allocation map.

If the operation is FORMAT or ALLOCATE, the allocation map will be changed if the reply to message ICK003D is U. The map is EXPANDED by adding PERM space to the end of the allocation map. The map is REDUCED by deleting space from the end of the allocation map.

System Action: ICKDSF continues processing.

Operator Response: None, if the change is acceptable. Otherwise reply T to message ICK003D.

System Programmer Response: None.

ICK03040I PERMANENT READ ERROR ON [cchh|block]

Explanation: While performing the EXAMINE function, an uncorrectable data check occurred.

System Action: The EXAMINE function continues processing.

Operator Response: When EXAMINE completes, reformat the indicated cylinder.

System Programmer Response: None.

ICK03050I FORMAT ERROR ON CYL(S) xxxx-yyyy

Explanation: While performing the EXAMINE function a cylinder (or range of cylinders) was found that was not properly formatted.

This might be because there are a mixture of cylinders with filler records and cylinders without filler records on a 3380 DASD. Or the range of cylinders might be formatted as a CMS minidisk instead of a CP system area, formatted by CPVOLUME.

System Action: The EXAMINE function continues processing.

Operator Response: When EXAMINE completes, reformat the indicated cylinders.

System Programmer Response: None.

Messages received at the output printer

ICK03060I INVALID TRACK FORMAT ON cchh

Explanation: While performing the FORMAT function, an INVALID TRACK FORMAT or NO RECORD FOUND error was encountered while searching for R0 on the track.

System Action: The INSPECT function is initiated to surface check the track and rewrite the R0. If the INSPECT is successful, formatting continues, otherwise the operation ends. Message ICK03070I will report the results of the track surface check operation.

Operator Response: None, if the operation continues. If the operation ends, refer to message ICK03070I or ICK33110I.

System Programmer Response: None.

ICK03070I SURFACE CHECK IN PROGRESS ON cchh|b1ock
SURFACE CHECK COMPLETED SUCCESSFULLY ON
cchh|b1ock

Explanation: While formatting, a device error was encountered that requires that the CKD track or FBA block be inspected. CPVOLUME or AIXVOL invokes the INSPECT function to attempt to correct the error. Message ICK03070I is issued when INSPECT is started and is issued again to report the results of the INSPECT.

System Action: Formatting is suspended until the INSPECT operation completes. If the INSPECT operation is successful, formatting continues. If the INSPECT operation fails, formatting ends.

Operator Response: None.

System Programmer Response: None, if the INSPECT operation is successful. If the INSPECT fails, refer to additional messages issued by INSPECT.

ICK03080I CYL0/TRK0 REFORMATTED WITH NEW ALLOCATION
MAP

Explanation: Message ICK03030I was previously issued, indicating a required change in the allocation map. This message now indicates that the records on cylinder 0 track 0 have been rewritten to accommodate the changed size of the allocation map record.

System Action: ICKDSF continues processing.

System Programmer Response: None.

Operator Response: None.

ICK03090I VOLUME SERIAL = vvvvvv

Explanation: vvvvvv is the volume serial obtained from the volume label record. If there is no volume label record then vvvvvv will be displayed as

System Action: Command processing continues.

Operator Response: None.

System Programmer Response: None.

ICK04000I DEVICE IS IN SIMPLEX STATE

Explanation: The device is in simplex state and not part of a dual copy pair.

System Action: Command processing continues.

Operator Response: None.

System Programmer Response: None.

ICK04001I DEVICE IS IN DUPLEX STATE

Explanation: The device is part of a dual copy pair and is in duplex state.

System Action: Command processing continues. Process may later end if the ICKDSF command does not support volumes in duplex state.

Operator Response: None.

System Programmer Response: None.

ICK04002I DEVICE IS IN SUSPENDED DUPLEX STATE

Explanation: The device is part of a dual copy pair and is in suspended duplex state.

System Action: Command processing continues.

Operator Response: None.

System Programmer Response: None.

ICK04003I PROCESSING ON PRIMARY VOLUME OF DUAL COPY
PAIR

Explanation: Command processing is being directed to the primary volume of a dual copy pair.

System Action: Command processing continues.

Operator Response: None.

System Programmer Response: None.

ICK04004I PROCESSING ON SECONDARY VOLUME OF DUAL
COPY PAIR

Explanation: Command processing is being directed to the secondary volume of a dual copy pair.

System Action: Command processing continues.

Operator Response: None.

System Programmer Response: None.

ICK04005I THE FOLLOWING MEDIA SIM IS BEING CLOSED,
SIM ID=X'nn'

Explanation: An open media SIM is being closed after successful track surface checking. See ICK10711I for more information.

System Action: Command processing continues.

Operator Response: None.

System Programmer Response: None

Messages received at the output printer

ICK04006I RECOVERY IN PROGRESS FOR TRACK X'cccc
hhhh'

Explanation: The current process has determined that checkpoint data exists for a previous ICKDSF function and recovery action is in process for the specified track.

System Action: ICKDSF continues with the recovery action.

Operator Response: None.

System Programmer Response: None.

ICK04007I SPEED OR NOSPEED IS IGNORED FOR THE DEVICE
TYPE

Explanation: The SPEED or NOSPEED option can not be performed for the specified device type because Device Support Facilities issues a "perform subsystem function" (PSF) command and the subsystem performs the data SCAN for this device.

System Action: Command processing continues with the parameter ignored.

System Programmer Response: None.

Operator Response: None.

ICK04008I PSF ORDER = xxxxx PSF SUBORDER = yyyyy

Explanation: An error has been detected for a "perform subsystem function" (PSF) of Order xxxx and Suborder yyyyy.

System Action: Processing may continue or end depending on the error type. See the accompanying messages to determine the action that was taken.

Operator Response: None.

System Programmer Response: See the accompanying messages.

ICK04009I TRACK X'cccc hhhh' IS NOT DEFECTIVE, NOT
RECLAIMED

Explanation: After surface checking, the specified primary track has been found not defective. The track remains assigned to an alternate location because NORECLAIM is specified.

System Action: Command processing continues.

Operator Response: None.

System Programmer Response: None

ICK04010I DIAGNOSTIC INFORMATION FROM READ SUBSYSTEM
DATA:

Explanation: This message gives information for a previously issued PSF command. The information is returned by the subsystem when an abnormal condition occurs.

System Action: Depending on the severity of the problem, the function processing may end.

Operator Response: None.

System Programmer Response: Examine the error information and refer to *IBM 9340 Direct Access Storage Reference* or *IBM RAMAC Array Subsystem Reference* for

more information. Contact your IBM service representative if necessary.

ICK04013I PRIMARY TRACK X'cccc hhhh' IS PERMANENTLY
(RE)ASSIGNED TO AN ALTERNATE LOCATION

Explanation: An alternate location has been assigned to the specified primary track because the primary track is defective, or an unconditional alternate assignment was requested for the primary track. If the primary track already has an alternate location assigned, a new alternate is reassigned to the primary track.

System Action: Command processing continues.

Operator Response: None.

System Programmer Response: None

ICK04020I INVALID TRACK DETECTED ON X'cccc hhhh',
ASSUMED NO DATA ON THE TRACK

Explanation: A 0F0B condition was detected. ICKDSF rewrites the HA and R0 with the assumption that no data existed on the track.

System Action: Command processing continues.

Operator Response: None.

System Programmer Response: None

ICK04029I DEVICE IS IN SUSPENDED PPRC STATE

Explanation: The device is part of a PPRC pair and is in a suspended state.

System Action: Command processing continues.

Operator Response: None.

System Programmer Response: The detail status can be obtained by using PPRCOPY QUERY command.

ICK04030I DEVICE IS A PEER TO PEER REMOTE COPY
VOLUME

Explanation: The device is part of a PPRC pair and Peer to Peer Remote Copy is active for the device.

System Action: Command processing continues.

Operator Response: None.

System Programmer Response: The detail status can be obtained by using PPRCOPY QUERY command.

ICK04031I DEVICE IS IN PPRC PENDING STATE

Explanation: The device is part of a PPRC pair and is in a PPRC pending state.

System Action: Command processing continues.

Operator Response: None.

System Programmer Response: The detail status can be obtained by using PPRCOPY QUERY command.

Messages received at the output printer

ICK04032I **DEVICE SPECIFIED IS A PPRC SECONDARY**

Explanation: The specified volume is a PPRC secondary.

System Action: Command processing continues.

Operator Response: None.

System Programmer Response: The detail status can be obtained by using the PPRCOPY QUERY command.

ICK10705I **VOLUME SERIAL NUMBER FOR DEVICE ccuu IS
xxxxxx**

Explanation: Informational message concerning the volume serial and VTOC of the volume at *ccuu*. If the volume serial was changed, you also receive one or both of the following:

- **CHANGED FROM xxxxxx** - The volume serial number of the *ccuu* was changed.
- **VOLUME SERIAL DUPLICATE FOR DEVICE ccuu. VOLUME MADE UNAVAILABLE** - The new volume serial on the *ccuu* is a duplicate of one already known to the operating system. The device has been unloaded.

If the VTOC location was changed, you also receive the following:

- **VTOC LOCATION MOVED** - The VTOC location of the volume at *ccuu* has moved.

System Action: Command processing continues.

Operator Response: If the device is being shared by other systems, this volume may need to be remounted at the sharing systems.

System Programmer Response: None.

ICK10710I **I/O ERROR OCCURRED ON DEVICE ccuu**

Explanation: An I/O error occurred on the device address *ccuu*. The two following message lines show the failing channel command word (CCW), the channel status word (CSW), the filemask, and the sense bytes, which describe the nature of the I/O error. If you are running ICKDSF in a virtual machine under VM, see "Problem solving under VM" on page 67.

System Action: Command processing continues. Command processing may eventually end, but it is generally documented by an ending message.

Operator Response: None.

System Programmer Response: Make sure that the problem is caused by the device. Correct the device problem, and retry the command.

ICK10711I **SIM INFORMATION: CCUU=ccuu,**

**errortype,severity,
MT=xxx-xx,SER=xxx-xxxx,
REFCODE=xxx-xxx-xxxx,
VOLSER=xxxxxx,ID=xx,
CCHH=X'cccc hhhh',
BLOCK=xxx xxxxx,REPEATED
SIM=xxxxxxxxxxxxxxxxxxxx**

Explanation: Information from a service information message (SIM). The CCHH or BLOCK fields are printed only when they

are applicable to the error type. When other fields are not applicable to the error type, N/A is printed in the variable portion of the message. The DASD model number appears in bits 3-5 of the MT field.

System Action: Command processing continues.

Operator Response: None.

System Programmer Response: Depending on the device see either *Maintaining IBM Storage Subsystem Media, Customer Guide for Using 9340 Direct Access Storage Subsystems Service Information Messages, Using the RAMAC Array DASD in an MVS, VM, or VSE Environment*, or *Using the RAMAC Array Subsystem in an MVS, VM, or VSE Environment* for further information regarding SIMs.

ICK10720I **UNABLE TO DETERMINE IF DUPLICATE VOLSER
EXISTS**

**RETURN CODE = xxxxxxxx
REASON CODE = xxxxxxxx**

Explanation: ICKDSF conclusion processing attempted to determine if another UCB exists with a duplicate *volser* of this volume. Because the UCBLook service returned with an unexpected error condition, ICKDSF has been unable to determine if a duplicate exists. The UCB for the device has been marked offline.

The hexadecimal UCBLook return and reason codes are printed if applicable.

System Action: Conclusion processing continues.

Operator Response: None.

System Programmer Response:

- Examine the previous messages to determine if the requested ICKDSF function completed successfully.
- Examine the UCBLook return and reason code to determine the cause the error.

See *MVS/ESA Planning: Dynamic I/O Configuration*, for a description of the UCB services and the corresponding return and reason codes.

If no other online device exists with the same *volser*, then the volume can be varied back online.

ICK10721I **ccuu VOLUME MADE UNAVAILABLE**

Explanation: The device has been unloaded during ICKDSF termination processing, because either an error occurred or a duplicate *volser* was found.

System Action: Termination processing continues.

Operator Response: None.

System Programmer Response: Examine the previous messages to determine the reason the volume is unavailable.

ICK10722I **UCBLook FAILED**

**RETURN CODE = xxxxxxxx
REASON CODE = xxxxxxxx**

Messages received at the output printer

Explanation: The UCB service, UCBLook was unsuccessful.

System Action: Command processing ends. The hexadecimal UCBLook return and reason codes are printed if applicable.

Operator Response: None.

System Programmer Response: Examine the UCBLook return and reason codes to determine the cause of the error.

See *MVS/ESA Planning: Dynamic I/O Configuration* for more information concerning UCB services and the corresponding return and reason codes.

ICK10723I UCBPIN FAILED

RETURN CODE = xxxxxxxx
REASON CODE = xxxxxxxx

Explanation: The UCB service, UCBPIN was unsuccessful. The hexadecimal UCBPIN return and reason codes are printed if applicable.

System Action: Command processing ends.

Operator Response: None.

System Programmer Response: Examine the UCBPIN return and reason codes to determine the cause of the error.

See *MVS/ESA Planning: Dynamic I/O Configuration* for more information concerning UCB services and the corresponding return and reason codes.

ICK10724I UCBPIN FAILED, UNABLE TO UNPIN UCB

RETURN CODE = xxxxxxxx
REASON CODE = xxxxxxxx

Explanation: The UCB for this device could not be unpinned. The hexadecimal UCBPIN return and reason codes are printed if applicable. ICKDSF termination processing was unable to complete successfully. End of Task processing will also attempt to unpin the UCB.

System Action: Command processing ends.

Operator Response: None.

System Programmer Response: Examine the UCBPIN return and reason codes to determine the cause of the error.

See *MVS/ESA Planning: Dynamic I/O Configuration* for more information concerning UCB services and the corresponding return and reason codes.

ICK10725I UCB SERVICE FAILED

RETURN CODE = xxxxxxxx
REASON CODE = xxxxxxxx

Explanation: The UCB service failed while ICKDSF was attempting to determine the path status. The hexadecimal UCB Service return and reason codes are printed if applicable.

System Action: ICKDSF will either end processing, or bypass some functions and continue.

Operator Response: None.

System Programmer Response: Examine the UCB service return and reason codes to determine the cause of the error.

MVS/ESA Planning: Dynamic I/O Configuration for more information concerning UCB services and the corresponding return and reason codes. Examine the subsequent messages to determine if ICKDSF will bypass some functions and continue processing, or whether processing will end.

ICK10726I UNABLE TO DETERMINE PATH STATUS

Explanation: The path status could not be determined.

System Action: Command processing continues, bypassing the functions that require path control.

Operator Response: None.

System Programmer Response: Examine the previous messages to determine the reason the path status could not be determined.

ICK10727I UNABLE TO UNALLOCATE UCB, RC=xxxx, RSN=xxxx

Explanation: An error occurred while trying to unallocate the UCB. The RC and RSN are the return and reason code from the MVS service that was invoked to unallocate the UCB.

System Action: ICKDSF terminates.

Operator Response: Contact the system programmer.

System Programmer Response: Determine the reason for the inability to unallocate the UCB.

ICK11005I VTOC DOES NOT EXIST

Explanation: A volume table of contents was not found on the volume during command processing.

System Action: Command processing continues.

Operator Response: None.

System Programmer Response: The volume must be initialized before being used in an MVS or VSE environment.

Note: A VTOC is not required for CP volumes.

ICK11009I IPL PROGRAM SUPPLIED FOR MSS -- IGNORED

Explanation: A volume being formatted as an MSS staging pack cannot contain IPL records.

System Action: Command processing ignores the IPL program specified, and the continues.

Operator Response: None.

System Programmer Response: Remove the IPLDD parameter from the command.

ICK11010I UNABLE TO CLOSE VOLUME

Explanation: A system error has occurred that prevents the volume from being closed properly.

System Action: The command probably did not complete successfully because the volume did not close. ICKDSF processing continues with the next command.

Messages received at the output printer

Operator Response: None.

System Programmer Response: None. Save the job output and contact your IBM service representative.

ICK11019I NEXT-AVAILABLE-ALTERNATE POINTER OR
COUNTER IN VTOC IS INVALID

Explanation: There is an error in either the value of the pointer to the next available alternate track or in the count of the available alternate tracks.

System Action: Command processing continues. If it is possible, the value in the VTOC is updated when processing completes.

Operator Response: None.

System Programmer Response: None. Save the job output and contact your IBM service representative.

ICK11038I NO VALID TRACKS WERE SPECIFIED

Explanation: If the TRACKS parameter specifies no valid track addresses, this message indicates that the command was not processed.

System Action: Command processing ends. However, PRESERVE data is processed before termination. ICKDSF processing continues with the next command.

Operator Response: None.

System Programmer Response: Reissue the command, and specify one or more valid track addresses. Save the job output and contact your IBM service representative.

ICK11048I INDEX SIZE SPECIFIED IS NOT LARGER THAN
THE ORIGINAL, THE ORIGINAL SIZE IS USED

Explanation: You have specified a new index size smaller than the current size. The current size will be used when rebuilding the index.

System Action: Command processing continues.

Operator Response: None.

System Programmer Response: If you wish to build an index smaller than the current size you must use the BUILDIX command to first delete the current index, and then use the BUILDIX command to build an index the size you wish.

ICK11049I EXTINDEX PARAMETER IGNORED, VOLUME IS NOT
IN INDEX FORMAT

Explanation: You have specified the EXTINDEX parameter for a volume which is not in index format.

System Action: Command processing continues.

Operator Response: None.

System Programmer Response: If you wish to build an index use the BUILDIX command.

ICK11050I VTOC LOCATION SPECIFIED FOR MSS STAGING
PACK -- IGNORED

Explanation: You cannot specify a VTOC location for a Mass Storage System staging pack.

System Action: The VTOC parameter is ignored, and command processing continues.

Operator Response: None.

System Programmer Response: Remove the VTOC parameter from the command.

ICK11051I LABELS PARAMETER SPECIFIED FOR MSS STAGING
PACK -- IGNORED

Explanation: You cannot place user volume labels on a Mass Storage System staging pack.

System Action: The LABELS parameter is ignored, and command processing continues.

Operator Response: None.

System Programmer Response: Remove the LABELS parameter from the command.

ICK11065I DATA PRESERVED FOR TRACK CCHH=X'cccc hhhh'
ON ALTERNATE TRACK CCHH=X'cccc hhhh'

Explanation: This message follows message ICK21047I if the preserved data is successfully written to an alternate track.

System Action: Command processing continues with the next track. The return code is set to 4.

System Programmer Response: Further inspection of the failing track might be required to determine the reason for the failure.

ICK11066I DATA RESTORED FROM ALTERNATE TRACK
CCHH=X'cccc hhhh' TO PRIMARY TRACK
CCHH=X'cccc hhhh'

Explanation: This is an informational message that user data has been restored from the alternate track to the primary track. However, the process ended because of an I/O error preceding or following this message.

System Action: Command processing ends.

Operator Response: None.

System Programmer Response: Examine the failing CCW, CSW and SENSE information to determine the cause of the error.

ICK11095I UNABLE TO READ VOLUME LABEL - PROCESS
CONTINUING

Explanation: An inspect has been requested on a volume that does not contain an OS volume label.

System Action: Command processing continues.

Operator Response: None.

System Programmer Response: None.

Messages received at the output printer

ICK11130I CAN NOT DETACH LINKED DEVICE ccuu RC =
nnnn

Explanation: The DIAGNOSE 08 allows the user program to issue a CP command. The DETACH command detaches the specified address that was full-pack overlay linked by ICKDSF during the media maintenance processing. The operation failed with CP return code *nnnn*.

System Action: Command ends. ICKDSF continues with the next command.

System Programmer Response: For more information about DETACH, see *CP Command Reference for General Users*.

Operator Response: None.

ICK11306I NO STORAGE AVAILABLE FOR PACK MAP

Explanation: During initialization or inspection of a volume, storage is dynamically acquired for data elements that are collected later to format the pack map. This message shows that storage was not available for a data element that was being allocated.

System Action: The command is completed, but without a pack map.

Operator Response: None.

System Programmer Response: Specify a larger region size, and reissue the command. Save the job output and contact your IBM service representative.

ICK11315I UNABLE TO READ VOLUME LABEL

Explanation: An I/O error occurred when attempting to read the volume label. When the number of user volume labels cannot be determined, the IPL program record might be written over existing records.

System Action: Command processing continues, but ICKDSF does not write the IPL program records.

Operator Response: None.

System Programmer Response: Save the job output and contact your IBM service representative.

ICK11328I SKIP DISPLACEMENT(S) CHANGED FOR TRACK
X'cccc hhhh'

Explanation: Skip displacement surface checking has detected at least one area on the track that is potentially defective. The defective areas have been skipped. The surface of the track is defect free if no subsequent messages are issued.

System Action: Command processing continues.

Operator Response: None.

System Programmer Response: None.

ICK11329I SURFACE ANALYSIS CYLINDER COULD NOT BE
READ FOR TRACK X'cccc hhhh'

Explanation: The surface analysis cylinder is accessed for skip displacement devices when there is a need to restore the skip displacement information on a track to the factory level.

This message can occur when there is no factory map information on the surface analysis cylinder, or there is an I/O error that cannot be corrected.

The channel command word (CCW), CSW, and sense information that caused the error is printed.

System Action: Depending upon the input track condition and the device type being processed, the home address may be rewritten without any factory skip displacement information before surface checking of the track occurs. Subsequent messages will appear if the factory skip displacement information might be overridden.

System Programmer Response: Because the usability of this track is not affected, there is no need to examine further information. However, the failing CCW, CSW, and sense information can be examined in detail if necessary.

ICK11390I INVALID DATA ON SA CYLINDER

Explanation: The data on the surface analysis cylinder for this volume (which contains skip displacement information for this volume) is not in the expected format.

System Action: This is an informational message only. ICKDSF will issue other messages for any other actions taken as a result of this situation. Command processing continues.

Operator Response: None.

System Programmer Response: None.

ICK11392I SKIP DISPLACEMENT DATA DEFAULTED FOR TRACK
X'cccc hhhh'

Explanation: The skip displacement data for the specified track could not be read.

System Action: The track is processed as though there were no skip displacements assigned to it, and the track receives a complete surface check.

Assignment of new skip displacements takes place as required.

Note that if there had been factory assigned skip displacements for this track, they have been reset.

Operator Response: None.

System Programmer Response: None. When ICKDSF processing completes for this track, the specified condition of the track (that is, either not defective or defective) is valid.

ICK11400I SUSPECTED PATH PROBLEM

Explanation: A path that was initially operational became not operational during drivetest processing.

System Action: Command processing continues.

Operator Response: None.

System Programmer Response: Correct the cause of the not-operational path status and run the job again.

Messages received at the output printer

ICK11411I ccuu INCORRECT DEVICE TYPE FOR DRIVE TEST,
DRIVE TEST BYPASSED

Explanation: Drive test was either specified or defaulted, but the device type for the volume indicated by device ccuu is not for a fixed media device. Some count key data (CKD) devices, such as the 2105, do not support the drive test.

System Action: ANALYZE command processing continues with the data verification test. The ANALYZE return code is set to 4.

Operator Response: None.

System Programmer Response: Valid device types for ANALYZE drive test include devices listed in Table 13 on page 8, Table 11 on page 7, and any CKD device emulated on a CKD device.

ICK11412I DRIVE TEST NOT SUPPORTED FOR MINIDISK,
DRIVE TEST BYPASSED

Explanation: You specified the ANALYZE DRIVETEST function, which is not supported for minidisks.

System Action: The drive test is bypassed.

Operator Response: None.

System Programmer Response: None.

ICK11414I WRITE INHIBIT SWITCH ON, WRITE TESTS
BYPASSED

Explanation: An error was detected when the ANALYZE drive test attempted to write on the CE cylinder, but the device was in a write inhibited condition.

System Action: All tests that attempt to write on the CE cylinder are bypassed, but command processing continues.

Operator Response: If the device has an R/W or READ switch, make sure the switch is in the READ/WRITE position, and is functioning properly.

This condition can also exist if the storage control has been write inhibited by the operating system. See the explanation of the CONTROL command to determine further action.

ICK11417I HOME ADDRESS READ FROM C.E. CYLINDER IS
INCORRECT: SHOULD BE X'cccc hhhh', IS
X'cccc hhhh'.

Explanation: The cylinder and head information in the home address for the specific track on the CE cylinder is incorrect.

System Action: ANALYZE attempts to rewrite the home address with the correct cylinder and head information:

- If the rewrite is successful, command processing continues with the write tests.
- If the rewrite is unsuccessful, this message is followed by a line showing the failing CCW, CSW, and sense, and indicating that the write tests will be bypassed. Command processing continues, bypassing the write tests.

Operator Response: None.

System Programmer Response: If ANALYZE was being run because of a suspected write problem, and the rewrite of the

home address on the CE cylinder is unsuccessful, investigate the situation further.

ICK11418I HOME ADDRESS MARKED DEFECTIVE ON CE
CYLINDER CCHH = X'cccc hhhh'

Explanation: The home address on track X'cccc hhhh' on the CE cylinder was found with the defect bit set on in the home address. ICKDSF will attempt to rewrite the home address with the defect bit off, unless this is one of the backup tracks containing backup data. If the correction attempt fails, then the message will be followed by another ICK10710I or ICK20100I with the ccw, csw, and sense information.

(The existence of backup data will have been indicated in a prior message.)

System Action: Command processing may eventually end.

Operator Response: None.

System Programmer Response: If message ICK10710I or ICK20100I is issued, examine the ccw, csw, and sense to determine the cause of the error. Assistance from your IBM hardware service representative may be required to correct the cause of the problem.

(If a prior message indicated that backup data exists for a previous uncompleted command, first issue the command again that did not complete.)

ICK11425I OPERATOR SPECIFIED B TO BYPASS RESERVED
PATH

Explanation: The operator replied B in response to message ICK416D or ICK417D.

System Action: Further processing is bypassed on this path.

Operator Response: None.

System Programmer Response: None.

ICK11426I DRIVE TEST: PATH UNAVAILABLE ON:

CHPID = XX
CHANNEL NUMBER = X
CHANNEL SET =X
STORAGE DIRECTOR ID = XX
SUBSYSTEM ID = XXXX
CLUSTER = X
STORAGE PATH = X

Explanation: The drive test attempted to start an I/O operation to a path that was not operational or was inaccessible.

CHPID = XX identifies the CHPID for the path being processed. This line is displayed only if it applies to the operating system environment.

CHANNEL NUMBER = X identifies the channel number for the path being processed.

CHANNEL SET = X identifies the channel set (CPU affinity) for the path being processed. This line is displayed only if it applies to the operating system environment.

STORAGE DIRECTOR ID = XX identifies the Storage Director Id for the path being processed. It contains the information in sense byte 21. This line is displayed only if it applies to the

storage control being processed, or if the error did not occur before the Storage Director Id was determined.

SUBSYSTEM ID = XXXX identifies the Subsystem Id for the path being processed. It contains the information in sense bytes 20 and 21. This line is displayed only if it applies to the storage control being processed, or if the error did not occur before the Subsystem ID was determined.

CLUSTER = X identifies the Cluster for the path to be processed. This line is displayed only if it applies to the storage control being processed, or if the error did not occur before the Cluster was determined.

STORAGE PATH = X identifies the Storage Path of the Cluster to be processed. This line is displayed only if it applies to the storage control being processed, or if the error did not occur before the Storage Path was determined.

System Action: Drive test processing ends on this path.

Operator Response: None.

System Programmer Response: Correct the cause of the not-operational path status.

ICK11427I PATH PARAMETER(S) IGNORED

Explanation: The path control parameters are only valid for drive test functions on 3380 and 3390 devices, and are not supported in the VSE version.

This message may also be issued following message ICK10710I when processing on a 3990 storage control if the 3990 storage control does not support the Guarantee Storage Path operation. The path control parameters may not be valid on all devices that emulate 3380 and 3390. See the ANALYZE command section for further information.

System Action: Command processing continues without path control.

Operator Response: None.

System Programmer Response: If the device is not a 3380 or 3390 or the device is being processed in the VSE version, no further action is necessary.

If this message is issued following ICK10710I when processing on a 3990 storage control, contact your IBM hardware service representative. The path parameters may not be valid on all devices that emulate 3380 and 3390. See the ANALYZE command section for further information.

ICK11428I STORAGE PATH STATUS CANNOT BE DETERMINED

Explanation: An I/O error occurred while attempting to determine the storage path status.

System Action: If the ANALYZE command is running, path control functions will be bypassed.

If the CONTROL CLEARFENCE command has been issued, the fence status cannot be determined.

Operator Response: None

System Programmer Response: Take action appropriate to your installation's procedures for handling suspected equipment problems.

ICK11429I FENCED/DISABLED PATH(S) WILL BE BYPASSED

Explanation: A fenced or disabled condition was detected on one or more paths.

System Action: Processing will be bypassed on the paths with the existing fenced or disabled condition. The Path Status Table will show the paths where the fenced or disabled condition exists.

Operator Response: None

System Programmer Response: Examine the Path Status Table that was previously printed to determine the paths that have a fenced or disabled condition.

If the path is disabled, determine the cause of the disablement. If the fence condition exists, contact your IBM software service representative to resolve the fenced condition.

ICK11430I PATH INFORMATION CANNOT BE DETERMINED

Explanation: Path information cannot be determined because of an error. ICKDSF functions which require path control cannot be processed.

System Action: Subsequent messages indicate whether command processing must end or whether it can continue without using path control.

System Programmer Response: Examine the previous messages to find the reason path information cannot be determined.

Operator Response: None.

ICK11431I PATH MAP ROUTINE FAILED RC = xxxxxxxx

Explanation: The system path map routine returned with an error. *RC=xxxxxxx* is the return code (in hexadecimal) in the message as follows:

Code	Meaning
4	The target subchannel is in permanent error and cannot be accessed.
8	The UCB is not connected to a subchannel.

System Action: Subsequent messages show whether the command ends or whether it continues without path control.

Operator Response: None

System Programmer Response: Return code 8 indicates *not connected subchannels*. This means there is a UCB, but no subchannel.

This condition has 3 possible causes and solutions:

1. You over genned to software. Correct by dynamically adding a new subchannel or re-impl with an IOCDs that matches the software.
2. You used CONFIG CHPID to move the last to another partition. When the last channel path is taken away, all the subchannels are also taken away, and the UCBs become *not connected*. Correct by reconfiguring the CHPID into the partition.
3. Under VM, you detached the device from MVS and the subchannels became *not connected*. Correct by attaching the device to the guest.

Messages received at the output printer

ICK11432I LOGICAL PATH STATUS CANNOT BE DETERMINED

Explanation: An I/O error occurred while attempting to determine the logical path status.

System Action: Command processing continues.

Operator Response: None.

System Programmer Response: Examine the CCW, CSW, and sense information to determine the cause of the error. Take action appropriate to your installation's procedures for handling suspected equipment problems.

ICK11433I INTERFACE INFORMATION CANNOT BE DETERMINED

Explanation: An error occurred attempting to obtain the interface information.

System Action: The command ends. ICKDSF continues with the next command.

Operator Response: None.

System Programmer Response: Examine the previous messages to determine the cause of the error.

ICK11435I CHANNEL CONNECTION ADDRESS SPECIFIED BUT IGNORED

Explanation: Channel Connection Address (CCA) is not required for this command. Specified value will be ignored.

System Action: Command processing continues.

Operator Response: None.

System Programmer Response: Remove specified Channel Connection Address (CCA).

ICK11436I CGROUP PARAMETER IGNORED FOR THIS STORAGE CONTROL

Explanation: The CGROUP parameter was specified with the PPRCOPY ESTPATH command, but the device does not support consistency groups. The parameter is ignored.

System Action: Command processing continues.

Operator Response: None.

System Programmer Response: None.

ICK11437I CCA SPECIFICATION IS MISSING, IT IS REQUIRED FOR THIS REQUEST

Explanation: Specification of the channel connection address (CCA) is required for the command.

System Action: Command processing ends.

Operator Response: None.

System Programmer Response: Specify the CCA and resubmit the request.

ICK11450I DIRECT I/O IS NOT SUPPORTED FOR THIS DEVICE, PARAMETER IGNORED

Explanation: The DIRECTIO parameter was specified, but either the subsystem does not support dual copy or the device is in simplex state.

System Action: Command processing continues without DIRECTIO.

Operator Response: None.

System Programmer Response: None.

ICK11451E ***WARNING*** ALTERNATE TRACK ASSIGNMENT EXISTS ON SECONDARY VOLUME

Explanation: One or more alternate track assignments exist on the secondary volume of a dual copy pair. The use of a volume as a secondary volume when there is an alternate track assigned is not recommended.

System Action: Command processing continues.

Operator Response: None.

System Programmer Response: Reestablish duplexing with another volume with no alternate track assigned. This volume may be used as a simplex volume or as a primary volume of a dual copy pair.

ICK11452I UNABLE TO READ DATA ON SECONDARY VOLUME FOR TRACK CCHH = X'cccc hhhh'

Explanation: When processing on the primary volume of a dual copy pair, INSPECT determines if the corresponding track on the secondary volume is readable. The specified track on the secondary volume was not readable.

The previous ICK10710I message contains the CCW, CSW, and sense information for the error.

System Action: Command processing continues.

Operator Response: None.

System Programmer Response: Examine the CCW, CSW, and sense information to determine the cause of the error on the secondary volume. Take appropriate action for your installation procedures for handling problems on the secondary volume.

ICK11453I UNABLE TO READ DATA ON PRIMARY VOLUME FOR TRACK CCHH = X'cccc hhhh'

Explanation: During processing of the primary volume, data on the primary volume of the dual copy pair could not be read.

The previous ICK10710I message contains the CCW, CSW, and sense information for the error on the primary volume.

If the device is in duplex state, processing will continue to read data from the secondary volume.

System Action: Message ICK21044I will be issued if data cannot be recovered from the secondary volume; command processing continues with the next track.

Operator Response: None.

System Programmer Response: Examine the CCW, CSW, and sense information to determine the cause of the error on

Messages received at the output printer

the primary volume. If the error is a data check, the following action is recommended:

1. Suspend the primary volume. This will cause the primary volume to become the disabled secondary.
2. Inspect the track on the disabled secondary with the DIRECTIO parameter.
3. If the INSPECT runs, reestablish the dual copy pair.
If the device is in duplex state and data is recovered from the secondary volume, the above action is not required.

For all other errors, take the action appropriate to your installation procedures for handling errors on the primary volume of a dual copy pair.

ICK11454I UNABLE TO READ DATA ON PRIMARY VOLUME FOR TRACK CCHH = X'cccc hhhh', PROCESS CONTINUING

Explanation: When you are processing the secondary volume of a dual copy pair, INSPECT determines if the corresponding track on the primary volume is readable. The specified track on the primary volume was unreadable.

The previous ICK10710I message contains the CCW, CSW, and sense information for the error.

System Action: Because TOLERATE(PRIFAIL) was specified, command processing continues for this track on the secondary volume

Operator Response: None.

System Programmer Response: Examine the CCW, CSW, and sense information to determine the cause of the error on the primary volume and take action appropriate to your installation's procedures for handling errors on the primary volume of a dual copy pair.

ICK11455I [PREVIOUS INSTALL|REVAL|INIT|INSPECT] COMMAND DID NOT COMPLETE ON [PRIMARY|SECONDARY VOLUME]

Explanation: The current process found that checkpoint data exists because a previous command prematurely ended on the primary or secondary volume of a dual copy pair.

System Action: The action taken by ICKDSF may differ depending on the current function and the dual copy volume state.

Operator Response: None.

System Programmer Response: See the message following. Determine the reason the previous ICKDSF command did not complete.

ICK11456I CHECKPOINT DATA BEING ERASED

Explanation: See the explanation for previous messages you received. Based on the current ICKDSF function you specified and status of the dual copy volume, ICKDSF determined that either:

- You did not request the checkpoint recovery process, or
- The checkpoint data must be erased in order to perform the current function.

System Action: ICKDSF erases the checkpoint data.

Operator Response: None.

System Programmer Response: It is strongly recommended that you do not establish or fail a dual copy pair (change the volume state) or invoke a different function if a previous ICKDSF function did not complete.

ICK11457I PROCESSING CONTINUES WITHOUT RECOVERY ACTION

Explanation: See the explanation of previous messages. It is unclear if or how ICKDSF should perform the recovery process based on the current volume state, the intent of the current ICKDSF function and the content of the checkpoint data.

Since the volume is a dual copy volume, the current function takes precedence.

System Action: Command processing continues without checkpoint recovery.

Operator Response: None.

System Programmer Response: It is strongly recommended that you complete the previous function to ensure the volume is in a usable condition. Place the dual copy pair in simplex state if necessary. The checkpoint data may or may not be erased (see ICK11456).

ICK11458I UNABLE TO USE ALTERNATE TRACK CCHH=X'cccc hhhh' TO ESTABLISH TRACK ASSOCIATION

Explanation: The alternate track indicated cannot be used to establish a primary/alternate track association on the secondary volume.

System Action: INSPECT command processing continues.

Operator Response: None.

System Programmer Response: Run INSPECT SKIP to surface check the alternate track.

ICK11459I NOPRESERVE PARAMETER IGNORED ON PRIMARY VOLUME OF DUAL COPY PAIR

Explanation: The NOPRESERVE parameter is not valid on the primary volume of a dual copy pair.

System Action: The NOPRESERVE parameter is ignored and command processing continues with PRESERVE in effect.

Operator Response: None.

System Programmer Response: None.

ICK11460I PRESERVE PARAMETER IGNORED ON SECONDARY VOLUME OF DUAL COPY PAIR

Explanation: The PRESERVE parameter is not valid on the secondary volume of a dual copy pair.

System Action: The PRESERVE parameter is ignored and command processing continues.

Operator Response: None.

System Programmer Response: None.

Messages received at the output printer

ICK11461I NON-STANDARD RECORD ZERO EXISTS ON PRIMARY
VOLUME FOR TRACK CCHH = X'cccc hhhh',
PROCESS CONTINUING

Explanation: A non-standard record 0 condition exists on the primary volume of the dual copy pair.

System Action: Since TOLERATE(PRIFAIL) was specified, command processing continues on the secondary volume.

Operator Response: None.

System Programmer Response: The primary volume should be put in simplex state and INSPECT NOPRESERVE run on the track of the primary volume.

ICK11462I NON-STANDARD RECORD ZERO EXISTS ON
SECONDARY VOLUME FOR TRACK CCHH = X'cccc
hhhh', CORRECTION IN PROGRESS

Explanation: A non-standard record 0 condition exists on the secondary volume of the dual copy pair.

System Action: INSPECT attempts to write a standard home address and record 0 on the track of the secondary volume.

Operator Response: None.

System Programmer Response: None.

ICK11741I DATA CHECK ON ID OR DATA FIELD ORIENTATION
ADDR = nnnnn.

Explanation: This message is printed for each block that fails the data verification test phase of ANALYZE. The data check indicates that data synchronization on the block's ID or data field was unsuccessful.

nnnnn is the relative block number in error.

This message is followed by a line showing the failing CCW, CSW and sense information.

System Action: ANALYZE command processing continues.

Operator Response: None.

System Programmer Response: Normally, this error is an indication of a media surface problem that can be resolved by:

- Assigning an alternate to the failing block with the INSPECT command, or
- Using the INIT command with the CHECK parameter to reinitialize the fixed block architecture (FBA) device.

Note: A large number of these messages occurring for a newly installed device may be an indication of an incorrectly formatted device. In this case, assistance from your IBM hardware service representative will probably be necessary.

ICK11743I DATAVER UNCORRECTABLE ERROR ADDR BLOCK
nnnnn

Explanation: This message is printed for each block that fails the data verification test phase of ANALYZE with an ECC uncorrectable data check. This message is followed by a line showing the failing CCW, CSW, and sense information. nnnnn is the relative block number of the failing block.

System Action: ANALYZE command processing continues. The return code is set to a 4.

Operator Response: None.

System Programmer Response: Normally, this error is an indication of a media surface problem that can be resolved by:

- Assigning an alternate to the failing block with the INSPECT command, or
- Using the INIT command with the CHECK parameter to reinitialize the FBA device.

If repeated attempts to resolve the problem using the INSPECT or INIT command fail, seek assistance from your IBM hardware service representative to aid in resolving the problem.

ICK11745I DATAVER CORRECTABLE ERROR ADDR BLOCK =
nnnnn

Explanation: This message is printed for each block that fails the data verification test phase of ANALYZE with an ECC correctable data check. This message is followed by a line showing the failing CCW, CSW, and sense information.

nnnnn is the relative block number of the failing block.

System Action: ANALYZE command processing continues. The return code is set to a 4.

Operator Response: None.

System Programmer Response: Normally, this error is an indication of a minor media surface defect and should not be considered a problem if the device is being used with systems such as VSE and VM, which have error recovery procedures that do ECC correction.

The performance impact of fixing the data in storage is less than the impact of the device reading the data from an alternate block. If it is necessary to eliminate this type of error, the INSPECT command can be used to unconditionally assign an alternate to the failing block.

Note: If an excessive number of these errors occur, assistance from your IBM hardware service representative should be sought to aid in determining if a hardware problem exists.

ICK11752I BLOCK xxxxxxxx OUTSIDE DEVICE LIMITS

Explanation: Block number xxxxxxxx specified by the BLOCKS parameter is not valid.

System Action: The command continues, ignoring the block number that is not valid.

Operator Response: None.

System Programmer Response: Resubmit the job, specifying the correct block number in the BLOCKS parameter. See "BLOCKRANGE|BLOCKS parameter: specify which blocks to inspect" on page 326. Save the job output and contact your IBM service representative.

ICK11782I DATAVER UNCORRECTABLE ERROR ADDR CCHH =
X'cccc hhhh'

Explanation: This message is printed for each track that fails the data verification test with an apparent ECC uncorrectable data check.

If the error could have been corrected by storage control retry, or if the record that experienced the error contained two non adjacent ECC correctable data checks, this error would appear

Messages received at the output printer

as ECC uncorrectable (including correctable errors in the key or data fields subsequent to record 1).

In either of the above cases, subsequent I/O against the same data might perceive the error as correctable. This message is followed by a line showing the failing CCW, CSW, and sense information. *cccc hhhh* is the hexadecimal cylinder and head address of the failing track.

System Action: Command processing continues. The return code is set to a 4.

Operator Response: None.

System Programmer Response: Normally, this error is an indication of a media surface problem that can be resolved by either performing a skip displacement to skip the defect, or if necessary, by assigning an alternate track. You can use the INSPECT command to perform skip displacement or assign an alternate track.

Note: If repeated attempts to resolve the problem using the INSPECT or INIT command fail, contact your IBM hardware service representative.

**ICK11784I DATAVER CORRECTABLE ERROR ADDR CCHH =
 X'cccc hhhh'**

Explanation: This message is printed for each track that fails the data verification test phase with an ECC correctable data check. This message is followed by a printout of the failing CCW, CSW, and sense information. *cccc hhhh* is the hexadecimal cylinder and head address of the failing track.

System Action: Command processing continues. The return code is set to 4.

Operator Response: None.

System Programmer Response: Normally, this error indicates a media surface problem that can be resolved by using the INSPECT command to skip displace over the error, or by using the INIT command with the CHECK parameter to reinitialize the CKD device.

This error is an indication of a minor media surface defect and need not be skip displaced if the device is being used with any IBM operating system, all of which have error recovery procedures that do ECC correction.

After skip displacement of the error is performed, there is no performance impact. The track contains no ECC correctable errors.

Note: If repeated attempts to resolve the problem using the INSPECT or INIT command fail, contact your IBM hardware service representative.

**ICK11826I DATAVER INVALID TRACK FORMAT ON
 CCHH=X'cccc hhhh'**

Explanation: A track format condition that was not valid was detected while scanning data on the specified track. This is usually an indication that data was written to the track beyond the track capacity. It is generally a user error.

System Action: Command processing continues. At the completion of the command, the return code is set to 4.

Operator Response: None.

System Programmer Response: Determine the data set

containing the specified track. To determine how the not valid track format condition occurred, determine how, where, and when the data on the track was written.

**ICK11827I POTENTIAL DRIVE PROBLEM EXPERIENCED ON
 TRACK CCHH = X'xxxx xxxx'**

Explanation: The INSPECT {RESERVEI HOLDIT} process detected the possibility of a potential drive problem.

System Action: The process continues and provides a possible fix for the situation.

Operator Response: None.

System Programmer Response: If this message is issued on multiple tracks, during multiple invocations of ICKDSF, or recurs on the same track, contact your IBM hardware service representative.

**ICK11841I DEVICE IS NOT IN "STATUS CANNOT BE
 DETERMINED" STATE**

Explanation: A Reset Indefinite Condition for Device (RESETICD parameter of the CONTROL command) has been issued for a device which is not currently in the Status Cannot Be Determined State.

System Action: Command processing ends.

Operator Response: None.

System Programmer Response: None.

ICK12105I NO BLOCKS REMAIN IN THE SPECIFIED RANGE

Explanation: CONTINUE processing was previously activated. (See ICK02103I.) There are no blocks to process in the specified range subsequent to the last checkpointed location.

System Action: Command processing continues with the minimal initialization functions.

Operator Response: None.

System Programmer Response: None.

ICK12107I CONTINUE FUNCTION CANCELLED

Explanation: The continue function of the INIT command has been cancelled. (Previous messages have indicated the reason for the cancellation.)

System Action: Command processing continues for the specified range. Checkpointing is no longer taking place.

Operator Response: None.

System Programmer Response: If processing completes normally, this message can be disregarded.

If processing does not run to completion for FBA devices, and RECLAIM was not specified, this message can be disregarded. For FBA devices where RECLAIM is specified, the RECLAIM job should be restarted.

For CKD devices that do not run to completion, a track on the device may contain a format that is not valid.

After the reason for the abnormal ending has been resolved, at least a medial INIT should be run for the entire volume.

Messages received at the output printer

Note: Subsequent invocations of the INIT command may or may not experience the same error, and may or may not attempt to CONTINUE from a previously recorded location. This depends on the reason the function was cancelled and the nature of the failure.

If multiple initializes are necessary, NOCONTINUE can be specified to ensure that processing never resumes from an unwanted location.

As long as processing successfully completes for each invocation, the persistence of this message can be ignored.

ICK12108I CONTINUE TRACK CANNOT BE USED

Explanation: The track normally used to contain checkpoint information is in use by this device. This message is followed by ICK12107I.

System Action: See ICK12107I.

Operator Response: None.

System Programmer Response: See ICK12107I.

ICK12109I CONTINUE DATA COULD NOT BE RESET

Explanation: An error occurred while checkpoint data was being written. This message is followed by ICK12107I.

System Action: See ICK12107I.

Operator Response: None.

System Programmer Response: See ICK12107I.

ICK12110I LAST INSPECT PROCESS FROM ANOTHER CPU CHECKPOINTED AT X'xxxx xxxx'

Explanation: The current INSPECT process detected that there is checkpoint data for the specified track from another processor. This indicates that a prior INSPECT process from another processor ended prematurely, or there is an INSPECT process currently working on the same device and same track from another processor.

System Action: See message ICK12111I or ICK33105.

Operator Response: None.

System Programmer Response: See message ICK12111I or ICK33105.

ICK12111I SURFACE CHECKING BYPASSED FOR X'xxxx xxxx'

Explanation: This message is preceded by ICK12110. This message is only given when the FORCE parameter is specified. The INSPECT process is bypassed for the specified track.

System Action: Command processing continues on next track.

Operator Response: None.

System Programmer Response: You should avoid more than one concurrent INSPECT process working on the same device. If it is determined that a prior INSPECT process ended prematurely, resubmit the INSPECT job for the specified track.

ICK12112I UNABLE TO SET/RESET/READ CHECKPOINT DATA, PROCESSING CONTINUES

Explanation: The current INSPECT process is unable to set/reset/read the checkpoint data because of an I/O error. The recovery process for the error is exhausted.

System Action: Because the FORCE parameter is specified, the current INSPECT process bypasses any future checkpoint data function and continues.

Operator Response: None.

System Programmer Response: None.

ICK12115I DATA BEING RECOVERED FOR TRACK X'cccc hhhh'

Explanation: The previous INSPECT command did not run completely during PRESERVE backup processing.

System Action: Primary surface checking functions are done for the specified track, and data is recovered if data exists.

Operator Response: None.

System Programmer Response: None.

ICK12116I PRESERVE DATA CANNOT BE BACKED UP FOR THIS DEVICE TYPE

Explanation: The PRESERVE recovery function is not supported for this device type.

System Action: Command processing continues as for HOLDIT.

Operator Response: None.

System Programmer Response: None.

ICK12117I PRESERVE BACKUP TRACK CANNOT BE USED. USE "HOLDIT"

Explanation: The track normally used to contain recovery information is in use by this device and PRESERVE was specified.

System Action: Command processing ends.

Operator Response: None.

System Programmer Response: Resubmit the job, specifying HOLDIT instead of PRESERVE or KEEPIT.

ICK12118I ERROR READING BACKUP TRACK

Explanation: An I/O error occurred while the specified command was determining the existence of recovery data for this volume.

System Action: The CCW, CSW and sense information are printed. This message is followed by another message describing the system action.

Operator Response: None.

System Programmer Response: None.

Messages received at the output printer

ICK12119I PRESERVE BACKUP DATA IGNORED

Explanation: This message follows ICK12118I if HOLDIT is specified. Any recovery data that might exist is left intact, and command processing continues.

System Action: Command processing continues.

Operator Response: None.

System Programmer Response: None.

ICK12120I THE PRESERVE DATA EXISTS FOR TRACK X'cccc hhhh'

Explanation: User is trying to preserve data when preserve data already exists for a different minidisk.

System Action: Command processing continues.

Operator Response: None.

System Programmer Response: See ICK32123I.

ICK12121I BACKUP/RECOVERY DATA IGNORED

Explanation: This message may be issued following ICK12118I. Any recovery data that might exist is left intact, and command processing continues.

System Action: Command processing continues.

Operator Response: None.

System Programmer Response: None.

ICK12123I PRESERVE BACKUP DATA CANNOT BE ESTABLISHED OR RESET

Explanation: An I/O error was encountered while performing the PRESERVE backup function.

System Action: If the data was being reset, this message is issued as a warning. Command processing continues.

ICK12124I ERROR TRYING TO ACCESS RECOVER TRACK X'cccc hhhh' --RECOVERY IN PROGRESS

Explanation: An I/O error was encountered while trying to determine the current disposition of the track to recover.

System Action: Standard ICKDSF track recovery operations take place for this track. If recovery is successful, the backup recovery process continues.

Operator Response: None.

System Programmer Response: If track recovery is unsuccessful, subsequent messages are issued.

ICK12125I NO PRESERVE BACKUP DATA EXISTS FOR TRACK X'cccc hhhh'

Explanation: The track backup recovery is attempting to recover is unrecoverable. Standard ICKDSF track recovery operations failed for this track. However, no data exists for that track.

System Action: Command processing continues as if backup recovery is complete.

Operator Response: None.

System Programmer Response: Standard installation procedures should be followed for unrecoverable tracks.

ICK12126D DATA ALREADY EXISTS FOR TRACK X'cccc hhhh' REPLY R TO RECOVER, E TO ERASE THE RECOVERY DATA, OR T TO TERMINATE

Explanation: This message is issued if recovery data exists for a track (message ICK1215I), but there is already data on that track.

This situation can occur if:

- The original data on the track had not yet been erased at the point of failure, or
- An INSPECT did not run to completion, but the volume was available for user use before this invocation of the INSPECT command.

System Action: The operator is prompted for a reply to this message.

Specify:

- R to recover data from the recovery information. (The new data on the track is erased).
- E to destroy recovery data. The current data on the track remains.
- T to end processing. The recovery data remains intact.

The next invocation of the INSPECT command will again attempt to process the recovery data.

Operator Response: Respond R, E, or T.

System Programmer Response: None.

ICK12128I RECOVERY DATA HAS BEEN ERASED

Explanation: This message is issued if you reply:

- C to ICK22158D or ICK22130D, or
- E to ICK12126D or ICK12159D.

System Action: Command processing continues.

Operator Response: None.

System Programmer Response: None.

ICK12130I UNABLE TO RESET RECOVERY DATA

Explanation: An I/O error occurred while the command checkpoint data was being updated to indicate that command processing had completed.

System Action: Command processing continues. All required functions have been completed.

Operator Response: None.

System Programmer Response: The volume is still usable. Because the I/O error occurred on a track that is not a user track, this message can be ignored.

Subsequent invocations of the INIT command will issue a warning message. If desired, take action appropriate to your installation's procedures for handling the I/O error problems. If the problem cannot be resolved, call your IBM software service representative.

Messages received at the output printer

**ICK12151I RECLAIM PROCESSING PREVIOUSLY INTERRUPTED,
RECLAIM FORCED**

Explanation: A previous use of the INIT command failed during reclaim processing and the RECLAIM parameter has not been specified with the CONTINUE parameter.

Reclaim processing is being forced to ensure that factory defects are properly flagged and that all primary and alternate pairs are properly connected.

System Action: The reclaim processing is restarted.

Operator Response: None.

System Programmer Response: None.

ICK12153I BLOCKRANGE IGNORED

Explanation: The BLOCKRANGE specification is being ignored because a previous use of the INIT command with the RECLAIM parameter has failed. Full volume processing is forced to insure the data integrity of the device.

System Action: Surface analysis will continue from the last checkpointed block to the end of the volume.

Operator Response: None.

System Programmer Response: None.

**ICK12154I PARAMETER NOSKIP IS IGNORED FOR DEVICE
TYPE**

Explanation: Skip displacement surface checking is always performed for the device type even if NOSKIP parameter was specified by the user.

System Action: Command processing continues.

Operator Response: None.

System Programmer Response: None.

**ICK12155I PARAMETERS IGNORED FOR DEVICE TYPE -
parameter list**

Explanation: The listed parameters were ignored for the device type.

System Action: Command processing continues.

Operator Response: None.

System Programmer Response: None.

ICK12157I DATA BEING RECOVERED FOR BLOCK xxxxxxxx

Explanation: The previous invocation of the INSPECT command did not run to completion during PRESERVE processing.

System Action: Surface checking functions are completed for the specified block, and data is recovered.

Operator Response: None.

System Programmer Response: None.

**ICK12159D DATA ALREADY EXISTS FOR BLOCK xxxxx REPLY
"R" TO RECOVER, "E" TO ERASE THE RECOVERY
DATA, OR "T" TO TERMINATE**

Explanation: This message is issued if recovery data exists for a block (ICK12157), but there is already data on that block that is not ICKDSF data and is not the original user data.

This situation can occur if an INSPECT did not run to completion, but the volume was available for user use before this invocation of the INSPECT command.

System Action: The operator is prompted for a reply to this message.

Reply:

- R to recover data from the recovery information. (The new data on the block is erased).
- E to destroy recovery data. The current data on the block remains.
- T to end processing. The recovery data remains intact.

The next invocation of the INSPECT command will again attempt to process the recovery data.

Operator Response: Respond R, E or T.

System Programmer Response: None.

**ICK12161I ERROR READING RECOVERY BLOCK - DATA
IGNORED**

Explanation: Backup recovery is currently attempting to recover a block which cannot be read successfully.

System Action: Whatever data currently exists on the block is ignored, and normal surface checking procedures are done for this block.

Operator Response: None.

System Programmer Response: None.

ICK12162I ERROR READING BACKUP BLOCK

Explanation: An I/O error occurred while INSPECT was determining the existence of recovery data for this volume.

System Action: The CCW, CSW and sense information are printed. This message is followed by another message describing the system action.

Operator Response: None.

System Programmer Response: None.

ICK12168I SPEED IGNORED BECAUSE HEADRANGE SPECIFIED

Explanation: Because SPEED operates on a cylinder at a time, it is not valid with HEADRANGE, and is ignored if both HEADRANGE and SPEED are specified..

System Action: Command processing continues with NOSPEED.

System Programmer Response: None.

Operator Response: None.

Messages received at the output printer

ICK12171I PRESERVE DATA BEING ERASED FOR TRACK
X'cccc hhhh'

Explanation: During processing of the INIT command, it has been determined that a previous use of the INSPECT command did not run to completion. Because this is an initialize, it is assumed that the data saved from that track (cccc hhhh) is no longer needed.

System Action: The preserved data is erased, and command processing continues.

Operator Response: None.

System Programmer Response: None.

ICK12172I PRESERVE DATA BEING ERASED FOR BLOCK
xxxxxxx

Explanation: During processing of the INIT command, it has been determined that a previous use of the INSPECT command did not run to completion. Because this is an initialize, it is assumed that the data saved by block xxxxxxxx is no longer needed.

System Action: The preserved data is erased, and command processing continues.

Operator Response: None.

System Programmer Response: None.

ICK12173I *WARNING* PREVIOUS PROCESS DID NOT
COMPLETE

Explanation: Checkpoint data has been detected that indicates an INSTALL or REVAL command did not complete processing. This could be an indication that the volume is in an unusable state.

System Action: This message is followed by ICK12107. The CONTINUE function is cancelled. Command processing continues.

Operator Response: None.

System Programmer Response: The message can be ignored if:

- It is issued during a medial initialization (the condition will be corrected), or
- It can be determined that message ICK12130 was issued during the processing of a previous command.

Otherwise, run a command to ensure the device is returned to a usable condition (for example, medial initialization or REVAL).

ICK12179I UNABLE TO DETERMINE CHECKPOINT
INFORMATION, RECOVERY PROCESS BYPASS

Explanation: I/O error occurred during read of checkpoint data. Checkpoint data is ignored.

System Action: Command processing continues.

Operator Response: None.

System Programmer Response: Refer to previous I/O error information.

ICK12180I CHECKPOINT DATA EXISTS FROM A PREVIOUS
xxxxxxx COMMAND

Explanation: The current process has determined that checkpoint data exists. This indicates a previous ICKDSF command did not complete successfully.

System Action: Depending on the current process and the previous checkpoint data, the function may either continue or end processing. See the messages which follow.

Operator Response: None.

System Programmer Response: None.

ICK12181I CHECKPOINT DATA IS BEING ERASED

Explanation: See the checkpoint data described in ICK12180. Since the current process can recover or override the error of the previous ICKDSF function, the checkpoint data is being erased.

System Action: Command processing continues.

Operator Response: None.

System Programmer Response: None.

ICK12182I A SUBSYSTEM FUNCTION MAY STILL BE
EXECUTING FROM ANOTHER CPU

Explanation: See the checkpoint data described in ICK12180. From the checkpoint information, the current process has determined that a subsystem function may still be running from another host since the maximum allowable run time has not been reached for a PSF command.

System Action: Because it is not acceptable to run multiple ICKDSF functions to the same device simultaneously, function processing is ended.

Operator Response: None.

System Programmer Response: Either wait for the current function to complete or rerun the job from the same host.

ICK12183I PREVIOUS SUBSYSTEM FUNCTION IS BEING
CANCELLED

Explanation: See the checkpoint data described in ICK12180. The current process has determined that the previous PSF command either should have ended or can be cancelled.

A "CANCEL" of the previous PSF command is being issued to the device.

System Action: Command processing continues.

System Programmer Response: None.

Operator Response: None.

ICK12184I FUNCTION CONTINUES WITHOUT CHECKPOINT
PROCESS

Explanation: See the checkpoint data described in ICK12180. The current process can continue without a recovery of the previous ICKDSF function. However, the current process will neither erase the previous checkpoint data nor set its own checkpoint data.

Messages received at the output printer

System Action: Command processing continues.

Operator Response: None.

System Programmer Response: After the current process completes, rerun the command as described in ICK12180.

ICK12185I **WARNING UNABLE TO RESET CHECKPOINT INFORMATION**

Explanation: The current ICKDSF process completed but was unable to reset the checkpoint data because of either an I/O error, a subsystem function failure, or overlaid checkpoint data.

System Action: Command processing ends.

Operator Response: None.

System Programmer Response: Investigate the error information associated with this problem, then call your IBM service representative if necessary. Rerun the command after the problem is corrected.

ICK12200I ENQUEUE FAILED ON TRACK X'cccc hhhh'. PROCESS CONTINUING

Explanation: The enqueue for the data set which contains track X'cccc hhhh' was unsuccessful. Because TOLERATE(ENQFAIL) was specified, command processing continues.

System Action: Command processing continues on this track.

Operator Response: None.

System Programmer Response: None.

ICK12202I INSUFFICIENT STORAGE AVAILABLE FOR DATA SET ENQUEUE -- TOLERATE(ENQFAIL) IS IN EFFECT FOR ALL TRACKS

Explanation: GETMAIN failed while obtaining the storage necessary to process the data set enqueue procedures. Because TOLERATE(ENQFAIL) was specified, command processing continues as if the enqueue failed.

System Action: Command processing continues for all tracks without the enqueue function.

Operator Response: None.

System Programmer Response: None.

ICK12204I UNABLE TO ENQUEUE VSAM DATA SET FOR TRACK X'cccc hhhh', PROCESS CONTINUING

Explanation: The specified track is part of a VSAM data set. ICKDSF does not support data set enqueue for VSAM data sets. Because TOLERATE(ENQFAIL) is specified or assumed, command processing continues for this track.

System Action: Command processing continues for this track.

Operator Response: None.

System Programmer Response: None.

ICK12316I UNABLE TO DETERMINE MINIDISK SIZE

Explanation: Either the system support code for the requested command does not exist in VM, or the minidisk is a T-disk. This message is followed by message ICK033E.

System Action: The system requests a specification of the size of the minidisk.

Operator Response: None.

System Programmer Response: None.

ICK13010I ALLOCATION MAP NOT UPDATED

Explanation: A function was requested that should have updated the allocation map, but an error condition caused CPVOLUME to bypass the update of the allocation map.

System Action: Command processing continues.

Operator Response: Review all messages for the operation and correct the reported error.

System Programmer Response: None.

ICK13015I FILLER|NOFILLER PARAMETER IS IGNORED FOR DEVICE TYPE

Explanation: The device type specified does not support the FILLER|NOFILLER parameter.

System Action: Command processing continues and FILLER or NOFILLER is ignored.

Operator Response: None.

System Programmer Response: None.

ICK13016I MODE PARAMETER IS IGNORED FOR THE LIST|LABEL FUNCTION

Explanation: The MODE parameter is not required for the LIST and LABEL functions and need not be specified.

System Action: The MODE parameter is ignored and command processing continues.

Operator Response: None.

System Programmer Response: None.

ICK13018I PARM ALLOCATION TYPE IS IGNORED IN A VM/XA ENVIRONMENT

Explanation: CPVOLUME has determined that you are operating in a VM/XA environment and that PARM allocation types exist in the allocation map.

System Action: Command processing continues and PARM allocation types are ignored.

Operator Response: None.

System Programmer Response: PARM allocation types are valid in a VM/ESA environment only and will be ignored in a VM/XA environment. If you wish to use that space on the volume, you must reallocate it to an allocation type supported by VM/XA.

Messages received at the output printer

ICK13019I UNDEFINED ALLOCATION TYPES EXIST

Explanation: CPVOLUME has determined that space on the volume has not been allocated. An entire PARM allocation type range was not reallocated. To reallocate a PARM type, you must reallocate the entire PARM range.

System Action: Command processing continues.

Operator Response: None.

System Programmer Response: Reallocate the ranges in the allocation map flagged as ????.

ICK13020I CYLINDER(S) xxxx-yyyy WAS FORMATTED with/without FILLER RECORDS

Explanation: While performing the EXAMINE function of the CPVOLUME command, a cylinder (or range of cylinders) was found that was previously CPVOLUME formatted with a different method (filler or nofiller).

System Action: Command processing continues.

Operator Response: None.

System Programmer Response: None

ICK14000I OUTSTANDING DEVICE SIM STILL EXISTS, SIM ID=X'nn'

Explanation: The specified device has an open SIM (open, pending, or suppress presentation) status. The system prints SIM information. See message ICK10711I.

System Action: Command processing continues.

Operator Response: None.

System Programmer Response: Contact your IBM service representative.

ICK14001I OUTSTANDING MEDIA SIM STILL EXIST, SIM ID=X'xx'

Explanation: The specified device has a not closed Media SIM. The SIM information is printed. See ICK10711I.

System Action: Command processing continues.

Operator Response: None.

System Programmer Response: See ICK10711I.

ICK14002I UNABLE TO OBTAIN ADDITIONAL SIM

Explanation: The previously issued PSF command has either failed or encountered an exception status, and a SIM is being generated by the subsystem. However, the associated SIM cannot be found.

System Action: Command processing ends.

Operator Response: None.

System Programmer Response: Contact your IBM service representative.

ICK14003I MEDIA MAINTENANCE IS RECOMMENDED FOR TRACK X'cccc hhhh'

Explanation: The subsystem recommends media maintenance action for the specified track.

System Action: Command processing continues.

Operator Response: None.

System Programmer Response: After the current process completes, perform media maintenance procedures for the specified track.

ICK14004I INVALID ALTERNATE LOCATION ASSIGNMENT FOR TRACK X'cccc hhhh', INSPECT REQUIRED

Explanation: The subsystem indicates media maintenance action is required on the specified track.

System Action: Command processing continues.

Operator Response: None.

System Programmer Response: After the current process completes, perform media maintenance procedure for the specified track.

ICK14006I SIM CAN NOT BE FOUND FOR THE SPECIFIED SIM ID=X'nn'

Explanation: The current ICKDSF process cannot obtain detailed SIM information for the specified SIM id contained in the summary SIM information for the device.

System Action: Command processing continues without any SIM management for the specified SIM id.

Operator Response: None.

System Programmer Response: Contact your IBM service representative.

ICK14007I INVALID STATE CHANGE FOR SIM ID=X'nn'

Explanation: An exception has been encountered for the specified SIM id because the SIM id is not valid.

System Action: Command processing continues without any SIM management for the specified SIM id.

Operator Response: None.

System Programmer Response: Contact your IBM service representative.

ICK14008I UNABLE TO UPDATE SIM STATUS FOR SIM ID=X'nn'

Explanation: The current ICKDSF process cannot update the SIM status because of either an I/O error or some other subsystem exception status.

System Action: The cause of the error is printed and command processing continues without any SIM management for the specified SIM id.

Operator Response: None.

System Programmer Response: Contact your IBM service representative.

Messages received at the output printer

ICK14009I UNRECOVERABLE ERROR IS DETECTED FOR TRACK
X'cccc hhhh'

Explanation: An unrecoverable error has been detected during the perform subsystem function (PSF) on the specified track.

System Action: Command processing continues.

Operator Response: None.

System Programmer Response: Media maintenance is recommended for the specified track.

ICK14010I RECOVERABLE ERROR IS DETECTED FOR TRACK
X'cccc hhhh'

Explanation: A recoverable error has been detected during the perform subsystem function (PSF) on the specified track.

System Action: Command processing continues.

Operator Response: None.

System Programmer Response: Media maintenance is recommended for the specified track.

ICK14020I VOLUME LABEL IN INPUT DOES NOT MATCH THAT
ON VOLUME

Explanation: A RECOVER operation attempted to verify a volume label and found a mismatch between the label given in the command input and the label on the volume.

System Action: The RECOVER operation is completed, and a return code of 4 is posted.

Operator Response: None.

System Programmer Response: Verify the volume label.

ICK14021I CHANNEL PROGRAM: READ VOLUME LABEL FAILED

Explanation: A RECOVER operation attempt to write a volume label failed.

System Action: The RECOVER operation on the volume is completed, only the volume label step is not completed; a return code of 4 is posted.

Operator Response: None.

System Programmer Response:

ICK14022I CHANNEL PROGRAM: WRITE VOLUME LABEL FAILED

Explanation: A RECOVER operation attempt to write a volume label failed.

System Action: The RECOVER operation on the volume is completed, only the volume label step is not completed; a return code of 4 is posted.

Operator Response: None.

System Programmer Response: Refer to the DASD ERP messages issued to the system console. Take the appropriate action and relabel the volume using ICKDSF or similar program.

ICK20011I FUNCTION CANNOT BE EXECUTED. INSUFFICIENT
MAIN STORAGE

Explanation: There is not enough virtual storage available to run a command.

System Action: The command ends. ICKDSF processing continues with the next command.

Operator Response: None.

System Programmer Response: Increase the amount of virtual storage available to ICKDSF, and reissue the command. Save the job output and contact your IBM service representative.

ICK20100I I/O ERROR OCCURRED DURING DRIVE TEST

Explanation: An I/O error occurred during the basic drive tests. The message is followed by the ccw, csw, and sense information for the error.

System Action: Drive test processing ends if path control is not being used.

If path control is being used, drive test processing ends on the current path and command processing continues with the next available path specified.

Operator Response: None.

System Programmer Response: Take action appropriate to your installation's procedures for handling suspected equipment problems.

ICK20101I I/O ERROR OCCURRED DURING DRIVE TEST ON
CCHH = X'cccc hhhh'

Explanation: An I/O error occurred on the indicated track while running the drive test. The message is followed by the ccw, csw and sense information for the error.

System Action: Drive test processing ends if path control is not being used.

If path control is being used, drive test processing ends on the current path and command processing continues with the next available path specified.

Operator Response: None.

System Programmer Response: Examine the failing ccw, csw and sense to determine the cause of the error.

ICK20200I 0F0B TRACK X'cccc hhhh' IS ALLOCATED TO
DATA SET data.set.name

Explanation: The track listed in the message contains an 0F0B error. If the track was allocated to a data set, then the data set name is indicated in the message.

System Action: Command processing continues.

Operator Response: None.

System Programmer Response: See *Maintaining IBM Storage Subsystem Media*, procedure 4, for the response.

Messages received at the output printer

ICK20201I TRACK X'cccc hhhh' IS ALLOCATED TO DATA SET data.set.name

Explanation: The track listed in the message contains an uncorrectable error. The track was allocated to a data set, which the data set name is indicated in the message.

System Action: Command processing continues.

Operator Response: None.

System Programmer Response: See message ICK11782I for more information on the uncorrectable error.

ICK20800I UNABLE TO SCRATCH dsname

Explanation: An error occurred while attempting to scratch the identified data set. A subsequent second-level message identifies the error.

System Action: The data set is not scratched. ICKDSF processing continues with the next command.

Operator Response: None.

System Programmer Response: See the associated message. Save the job output and contact your IBM service representative.

ICK20801I ** NO VOLUME MOUNTED

Explanation: Volume not mounted.

System Action: The data set is not scratched. ICKDSF processing continues with the next command.

Operator Response: None.

System Programmer Response: Reissue the command, making sure the correct volume is mounted. Save the job output and contact your IBM service representative.

ICK20802I ** PASSWORD VERIFICATION FAILED

Explanation: The data set to be scratched is password protected, and the operator did not supply the correct password.

System Action: The data set is not scratched. ICKDSF processing continues with the next command.

Operator Response: None.

System Programmer Response: Reissue the command, and specify the correct password when prompted. Save the job output and contact your IBM service representative.

ICK20803I ** DATA SET HAS NOT EXPIRED ON VOLUME volser

Explanation: The PURGE parameter was not specified, and the data set retention period has not expired.

System Action: The data set is not scratched. ICKDSF processing continues with the next command.

Operator Response: None.

System Programmer Response: Specify the PURGE parameter if you want to destroy the data set, and reissue the command. Save the job output and contact your IBM service representative.

ICK20804I ** PERMANENT I/O ERROR ON VOLUME

Explanation: The volume table of contents cannot be read because of an I/O error condition.

System Action: The data set is not scratched. ICKDSF processing continues with the next command.

Operator Response: None.

System Programmer Response: Either restore the volume or initialize the volume offline. Save the job output and contact your IBM service representative.

ICK20805I ** UNABLE TO MOUNT VOLUME volser

Explanation: An appropriate device was not available for mounting the volume.

System Action: The data set was not scratched. ICKDSF processing continues with the next command.

Operator Response: Make sure a device is available for mounting, and reissue the command.

System Programmer Response: None. Save the job output and contact your IBM service representative.

ICK20806I ** DATA SET WAS IN USE

Explanation: The data set to be scratched was being used by another program.

System Action: The data set is not scratched, and command processing continues.

Operator Response: Make sure that no other job is using the data set (do not specify DISP=SHR), and reissue the command.

System Programmer Response: None. Save the job output and contact your IBM service representative.

ICK20810I ** INVALID RACF AUTHORIZATION

Explanation: A RACF-protected data set resides on the volume. The volume cannot be purged, because the user does not have the correct authorization to scratch the data set.

System Action: The data set is not scratched, and the command ends. ICKDSF processing continues with the next command.

Operator Response: None.

System Programmer Response: None. Save the job output and contact your IBM service representative.

ICK20950I INVALID FORMAT STRUCTURE

Explanation: An element of one of the static text structures is incorrect. There is probably a program error.

System Action: The request to print a line is ignored. Command processing continues, but no output is printed.

Operator Response: None.

System Programmer Response: Save the job output and contact your IBM service representative.

Messages received at the output printer

ICK20951I OUTPUT COLUMN SPECIFIED OUT OF RANGE

Explanation: An output column specification is outside the allowed print line width (for example, the specification is beyond column 120). There is probably a program error.

System Action: This field and subsequent fields for the same line are ignored. Command processing continues, but no output is printed.

Operator Response: None.

System Programmer Response: Save the job output and contact your IBM service representative.

ICK20952I EXCESSIVE FIELD LENGTH FOR BD OR PU CONV

Explanation: A binary-to-decimal or packed-to-unpacked conversion length was specified greater than 15. There is probably a program error.

System Action: A default value of 15 is used, and command processing continues.

Operator Response: None.

System Programmer Response: Save the job output and contact your IBM service representative.

ICK20953I A REDO SUB-STRUCTURE IS NESTED

Explanation: A redo structure cannot be defined within a set of structures to be redone. There is probably a program error.

System Action: The current redo operation ends. All structures are treated only once.

Operator Response: None.

System Programmer Response: Save the job output and contact your IBM service representative.

ICK20954I STATIC TEXT ENTRY REQUESTED NOT IN MODULE

Explanation: A request for a specific static text entry in a specified static text module could not be resolved. Either the static text index is incorrect, or the programmer has neglected to enter a message into the static text module.

There is probably a program error.

System Action: The request is ignored, and command processing continues.

Operator Response: None.

System Programmer Response: Save the job output and contact your IBM service representative.

ICK20955I INVALID PACKED DECIMAL FIELD

Explanation: A conversion request for packed-to-unpacked decimal encountered a digit that is not in the range of 0 to 9. There is probably a program error.

System Action: Conversion stops for the current request. Command processing continues without the packed-to-unpacked conversion.

Operator Response: None.

System Programmer Response: Save the job output and

contact your IBM service representative.

ICK21000I ALTERNATE TRACK CCHH=X'cccc hhhh' FOUND UNRECOVERABLE

Explanation: Track surface checking encountered error conditions that prevented the alternate track's home address or record 0 from being rewritten to indicate that it is a defective track.

Since the track cannot be marked defective, it cannot be used by the operating system.

System Action: If the inability to recover the track is caused by a data error, the command runs to completion with an error return code. If the cause is anything other than a data error, command processing stops after detection of the error.

Operator Response: None.

System Programmer Response: Prior messages should be examined (including the CCW, CSW, and sense that caused the I/O) to determine the cause of the failure. This message may be issued if either the read/write mode switch is set to READ mode, or some other condition prevents ICKDSF from writing on the volume.

If running under VM either from either Stand-Alone or an operating system version, this message can indicate that a diagnostic or media maintenance function was attempted against a device that was a minidisk and LINKED to the userid. Diagnostic and media maintenance functions must be done on dedicated devices.

For more information on VM support, see Chapter 8, "ICKDSF versions supported as guests under VM," on page 67.

Assistance may be required from the IBM service representative. Save the job output and contact your IBM hardware service representative.

ICK21001I PRIMARY TRACK CCHH=X'cccc hhhh' FOUND UNRECOVERABLE

Explanation: Track surface checking found error conditions which prevented the primary track's home address or record 0 from being rewritten to indicate that it is a defective track.

Since the track cannot be marked defective, it cannot be used by the operating system.

This message may appear if, during command processing, the read/write mode switch is inadvertently set to READ mode.

System Action: ICKDSF continues, unless the unrecoverable track threshold is met (see message ICK31013I).

Operator Response: None.

System Programmer Response: Prior messages should be examined (including the CCW, CSW, and sense that caused the I/O) to determine the cause of the failure. This message may be issued either if the read/write mode switch is set to READ mode, or some other condition prevents ICKDSF from writing on the volume.

If running under VM, from either Stand-Alone or an operating system version, this message can indicate that a diagnostic or media maintenance function was attempted against a device that was a minidisk and LINKED to the userid. Diagnostic and media maintenance functions must be done on dedicated devices.

Messages received at the output printer

For more information on VM support, see Chapter 8, "ICKDSF versions supported as guests under VM," on page 67.

Assistance may be required from the IBM service representative. Save the job output and contact your IBM hardware service representative.

ICK21002I INVALID VTOC ORIGIN SPECIFICATION FOR TRACK CCHH=X'cccc hhhh'

Explanation: The VTOC parameter specifies a track location that is not valid for the volume table of contents. The VTOC cannot begin on cylinder 0, track 0 or encroach on the alternate track area.

System Action: The command ends. ICKDSF continues with the next command.

Operator Response: None.

System Programmer Response: Either accept the default location, or reissue the command specifying a correct location. Save the job output and contact your IBM service representative.

ICK21003I INVALID VTOC EXTENT SPECIFICATION: xxxx

Explanation: The VTOC parameter specifies an extent that is not valid (number of tracks) for the VTOC area. The VTOC cannot have an extent of 0 or encroach on the alternate track area.

System Action: The command ends. ICKDSF continues with the next command.

Operator Response: None.

System Programmer Response: Either accept the default extent, or reissue the command specifying a correct extent. Save the job output and contact your IBM service representative.

ICK21007I R-ZERO INCORRECT -- a CCHH=X'cccc hhhh' (X'cccc hhhh') b CCHH=X'cccc hhhh'

Explanation: This message indicates a primary/alternate track association that is not valid on a volume. See Figure 33 on page 464 for an example of a proper association.

- a CCHH=cccc hhhh indicates the cylinder/head of the primary track in error. If that track is flagged defective, a is set to D; otherwise, a is set to N. The cccc hhhh in parentheses is the cylinder/head of the track pointed to in record 0 of the primary track in error.
- b CCHH=cccc hhhh indicates the cylinder/head for the alternate track in error. If that track is flagged defective, the b is set to D; otherwise, b is set to N. See Figure 33 on page 464 for an example of a proper association.

If a primary track is detected that contains an unknown alternate track pointer (the cylinder/head in record 0 does not indicate a valid track address), the b CCHH=cccc hhhh portion of the message is printed N CCHH=FFFF FFFF.

System Action: If performing an INITIALIZE command, processing stops.

If performing an INSPECT command, ICKDSF continues with the next track.

Operator Response: None.

System Programmer Response: For INITIALIZE processing, this message is only issued for a minimal INIT. Either INITIALIZE the volume at the medial level or INSPECT the primary or alternate track to correct the problem.

For INSPECT processing, this message is issued when an inconsistency exists for a track, and ICKDSF is not permitted to fix the problem. Specify ASSIGN and retry. Sometimes, specifying RECLAIM can also solve the problem. Save the job output and contact your IBM service representative.

ICK21008I UNABLE TO WRITE IPL RECORDS

Explanation: The IPL program records could not be written. Messages issued just prior to this message indicate the type of error that occurred.

System Action: The IPL program records are not written, but command processing continues.

Operator Response: None.

System Programmer Response: Correct the error, and reissue the command. Save the job output and contact your IBM service representative.

ICK21011I CRITICAL TRACK DESCRIPTOR INCORRECT CCHH=X'cccc hhhh'

Explanation: The critical tracks are those tracks that are reserved for the volume table of contents and cylinder 0, track 0. The contents of the record 0 on the identified track are in error.

System Action: None.

Operator Response: None.

System Programmer Response: Either reinitialize the volume at the medial level or INSPECT the track at X'cccc hhhh'. Save the job output and contact your IBM service representative.

ICK21014I SURFACE CHECK FUNCTION FAILS ON TRACK CCHH=X'cccc hhhh'

Explanation: While writing or reading the indicated track, a channel program failure other than DATA CHECK occurred.

System Action: The command ends.

ICKDSF continues with the next command.

Operator Response: None.

System Programmer Response: Examine the CCW, CSW, and sense information associated with the message to determine the kind of I/O error.

If operating under VM from either Stand-Alone or an operating system version, this message can indicate that a diagnostic or media maintenance function was attempted against a device that was a minidisk and LINK to the userid. Diagnostic and media maintenance functions must be done on dedicated devices.

For more information on VM support, see Chapter 8, "ICKDSF versions supported as guests under VM," on page 67. Save the job output and contact your hardware service representative

Messages received at the output printer

ICK21015I ALTERNATE TRACK CCHH = X'cccc hhhh' FOUND DEFECTIVE

Explanation: The concurrent media maintenance process found the specified alternate track defective while preserving the user data.

System Action: The alternate track is flagged as defective and ICKDSF continues, using the next alternate track to preserve user data.

Operator Response: None.

System Programmer Response: None.

ICK21016I UNABLE TO USE ALTERNATE TRACK CCHH = X'cccc hhhh' TO PRESERVE DATA

Explanation: The specified alternate track cannot be used to preserve user data. It either was found defective or had an I/O error.

System Action: If an I/O error occurred, command processing ends. If the alternate track was found defective, ICKDSF continues, using the next alternate track.

Operator Response: None.

System Programmer Response: For an I/O error, examine the failing CCW, CSW and SENSE information to determine the cause of the error.

ICK21017I NO MORE ALTERNATE TRACKS LEFT ON PACK

Explanation: All nondefective alternate tracks have been assigned to primary tracks.

System Action: Assignment of alternate tracks ends. Command processing continues.

Operator Response: None.

System Programmer Response: Use the RECLAIM function of the INSPECT command to attempt reclamation of primary and alternate tracks. (For the IBM 3375, 3380, and 3390, use only the INSPECT command.)

The assistance of an IBM service representative might be necessary to determine the cause of the alternate track assignments. Save the job output and contact your IBM service representative.

ICK21028I NOT ALLOWED TO CHANGE VOLUME LABEL

Explanation: Only an authorized user can change the volume label in a system that has Resource Access Control Facility (RACF) installed.

System Action: The contents of the volume label are not changed, but command processing continues.

Operator Response: None.

System Programmer Response: None. Save the job output and contact your IBM service representative.

ICK21030I NOT ALLOWED TO WRITE IPL RECORDS

Explanation: Only an authorized user can change the IPL records on a volume in a system where Resource Access Control Facility (RACF) is installed.

System Action: The IPL records are not written, but command processing continues.

Operator Response: None.

System Programmer Response: None. Save the job output and contact your IBM service representative.

ICK21031I UNABLE TO RECLAIM ALTERNATE TRACK CCHH=X'cccc hhhh'

Explanation: An I/O error occurred while attempting to rewrite the home address and record 0 on the indicated alternate track.

System Action: The alternate track is not reclaimed. Command processing continues.

Operator Response: None.

System Programmer Response: Save the job output and contact your IBM service representative.

ICK21032I UNABLE TO RECLAIM PRIMARY TRACK CCHH=X'cccc hhhh'

Explanation: An I/O error occurred while attempting to rewrite the home address and record 0 on the indicated primary track.

System Action: The primary track is not reclaimed. Command processing continues.

Operator Response: None.

System Programmer Response: Save the job output and contact your IBM service representative.

ICK21033I TRACK DISSOCIATION FAILED: CCHH=X'cccc hhhh'

Explanation: An error prevented correct rewriting of the record 0 while reclaiming either a primary or alternate track. Track addresses associating the primary and alternating tracks could not be removed.

System Action: The alternate track is marked defective, and command processing continues.

Operator Response: None.

System Programmer Response: None. Save the job output and contact your IBM service representative.

ICK21037I INVALID TRACK ADDRESS SPECIFIED: CCHH=X'cccc hhhh'

Explanation: Only tracks within either the defined primary or alternate track areas of a volume can be inspected. Either a track beyond these areas was specified, or a there was a syntax error in the track address specification.

System Action: The requested action is ignored on the track that is not valid, but command processing continues for any tracks that were correctly specified.

Messages received at the output printer

Operator Response: None.

System Programmer Response: Correct the incorrect specification, and reissue the command. Save the job output and contact your IBM service representative.

ICK21039I PRIMARY TRACK CCHH=X'cccc hhhh' DEFECTIVE,
NO ALTERNATE -- DATA SAVED

Explanation: Surface checking found the indicated primary track defective, but no alternate track is available for assignment to it.

System Action: The contents of the primary track are saved and rewritten on the primary track, if possible. Command processing continues.

Operator Response: None.

System Programmer Response: Reinitialize the volume. Save the job output and contact your IBM service representative.

ICK21040I PRIMARY TRACK CCHH=X'cccc hhhh' DEFECTIVE,
NO ALTERNATE -- DATA LOST

Explanation: Surface checking found the indicated track defective, but no alternate track is available for assignment to it.

System Action: The contents of the primary track are not rewritten on the primary track and are therefore lost. Command processing continues.

Operator Response: None.

System Programmer Response: Reinitialize the volume. Save the job output and contact your IBM service representative.

ICK21041I ALTERNATE TRACK CCHH=X'cccc hhhh'
DEFECTIVE -- DATA SAVED

Explanation: Surface checking found the indicated alternate track defective, but no alternate track is available for assignment to it.

System Action: If possible, the contents of the alternate track are saved and rewritten to the alternate track. Command processing continues.

Operator Response: None.

System Programmer Response: Reinitialize the volume. Save the job output and contact your IBM service representative.

ICK21042I ALTERNATE TRACK CCHH=X'cccc hhhh'
DEFECTIVE -- DATA LOST

Explanation: Surface checking found the indicated alternate track defective, but no alternate track is available for assignment to it.

System Action: The contents of the alternate tracks are not rewritten to the alternate track and are therefore lost. Command processing continues.

Operator Response: None.

System Programmer Response: Reinitialize the volume.

Save the job output and contact your IBM service representative.

ICK21044I UNABLE TO PRESERVE -- UNABLE TO READ TRACK
CCHH=X'cccc hhhh'

Explanation: A record on the indicated cylinder and track could not be read because of I/O errors.

Two conditions:

- Sense information in the subsequent message that is all zeros, and
- CSW indicating only Channel End, Device End, and Incorrect Length (0C40 in the first two bytes of the second word)

are usually an indication that previous ICKDSF processing has caused a nonstandard record zero to remain on the volume.

Run an INSPECT of the track specifying a NOPRESERVE CHECK(1) to correct the situation. (Be aware that there is no user data on the track.)

System Action: The record on the indicated track is not lost, and the track is not marked defective. The specified track is not surface-checked. Command processing continues with the next track.

Operator Response: None.

System Programmer Response: Start error recovery procedures for the data set containing the track in error. Rerun the command for the track in error with NOPRESERVE specified.

If the volume is part of a dual copy pair, put the volume in simplex state to perform an INSPECT with NOPRESERVE. Save the job output and contact your IBM service representative.

ICK21045I UNABLE TO RESTORE -- UNABLE TO READ TRACK
CCHH=X'cccc hhhh'

Explanation: During the concurrent media maintenance process, an I/O error prevented both rereading of the user data on the specified alternate track and data restoration back to the original primary track.

System Action: Command processing ends. The user data remains on the alternate track.

Operator Response: None.

System Programmer Response: Examine the failing CCW, CSW and SENSE information to determine the cause of the error.

ICK21047I PRESERVED DATA CANNOT BE REWRITTEN TO
TRACK CCHH=X'cccc hhhh'

Explanation: An I/O error prevented a successful write operation of preserved records back to either the original track or its assigned alternate track.

System Action: Regardless of the current value of the ASSIGN command, three attempts are made to assign a (new) alternate track and to correctly rewrite the data.

Operator Response: None.

Messages received at the output printer

System Programmer Response: Subsequent messages will indicate the final status of the data.

ICK21048I CYL-0 TRK-0 DEFECTIVE, PACK UNUSABLE FOR IPL

Explanation: Cylinder 0, track 0 has been found defective. The track has been assigned an alternate track, but the volume cannot be used as an IPL volume.

System Action: Command processing continues.

Operator Response: None.

System Programmer Response: Call the IBM hardware service representative if you must use this volume as an initial-program-load volume. Save the job output and contact your IBM service representative.

ICK21050I ERROR OCCURRED WHILE PROCESSING TRACK CCHH = X'cccc hhhh'

Explanation: An error occurred while processing the specified track. The function specified by the parameters may not have completed.

System Action: Command processing continues with the next track.

Operator Response: None.

System Programmer Response: Examine the previous messages to determine the cause of the error.

ICK21055I VTOC IS LOCATED ON CYLINDER 0 HEAD 0

Explanation: The volume table of contents resides on the first track of the volume. This prevents the writing of IPL program records on the first track of the volume. VTOC expansion or VTOC refresh processing is also not allowed.

System Action: If IPLDD specified, command processing continues, but the IPL program record is not written. If VTOC expansion or VTOC refresh processing is specified, command processing ends.

Operator Response: None.

System Programmer Response: If it is necessary to have IPL records, expand the VTOC, or refresh the VTOC, reinitialize the volume with the VTOC on any track except the first track of the volume.

ICK21060I FREE SPACE IS NOT AVAILABLE FOR THE NEW INDEX

Explanation: The free space extents in the volume are too small to fit the new INDEX.

System Action: The index is not rebuilt. Command processing continues.

Operator Response: None.

System Programmer Response: Move or delete data sets so there is a free space extent big enough for the new index size. Then allocate the new index data set and issue the BUILDIX command to rebuild the index.

ICK21065I ERROR OCCURRED WHILE ISSUING MACRO MODVCE, RETURN CODE =

Explanation: In the VSE environment during the closing of the volume, an error occurred notifying the supervisor of volume changes. The value of return code is in decimal.

System Action: Command processing ends.

Operator Response: None.

System Programmer Response: See the *IBM VSE/Enterprise Systems Architecture VSE Central Functions Supervisor Diagnosis Reference Version 6 Release 4*, and the *VSE/ESA Messages and Codes* for the reason for failure.

ICK21070I ERROR OCCURRED WHILE ISSUING MACRO CVTOC, RETURN CODE =

Explanation: In the VSE environment during the closing of the volume, an error occurred trying to unlock the Exclusive Open obtained by the OVTOC macro. The value of return code is in decimal.

System Action: Command processing ends.

Operator Response: None.

System Programmer Response: See the *IBM VSE/Enterprise Systems Architecture VSE Central Functions Supervisor Diagnosis Reference LIOCS Version 6 Release 4*, and the *VSE/ESA Messages and Codes* for the reason for failure.

ICK21080I ALTERNATE TRACKS INSPECTION NOT VALID FOR DEVICE TYPE

Explanation: There is a request to directly inspect an alternate track on a device where this is not supported. The alternate track cannot be inspected directly for these devices. Inspection of the primary track automatically also inspects the alternate track.

System Action: ICKDSF continues with the next track.

Operator Response: None.

System Programmer Response: To inspect the alternate track, first examine the map to determine the address of the primary track associated with the alternate track. Then rerun the job using the primary track address.

ICK21316I UNABLE TO OPEN IPL INPUT DATA SET

Explanation: The data set specified by the IPLDD parameter cannot be opened. An associated message identifies the reason for the failure.

System Action: Command processing continues, but the IPL program record is not written.

Operator Response: None.

System Programmer Response: Correct the error identified in the associated message, and reissue the command. Save the job output and contact your IBM service representative.

Messages received at the output printer

ICK21317I IPL INPUT RECORD-1 FORMAT IMPROPER

Explanation: The four characters IPL1 were not the first four characters of the first user-specified IPL bootstrap record.

System Action: System-defined IPL bootstrap records are written on the volume and command processing continues. The remainder of the user-specified IPL bootstrap records and IPL program records are ignored.

Operator Response: None.

System Programmer Response: Either correct the IPL bootstrap record format and reissue the command, or accept the system-defined IPL bootstrap records. Save the job output and contact your IBM service representative.

ICK21318I IPL INPUT RECORD-2 FORMAT IMPROPER

Explanation: The second user-specified IPL bootstrap record did not contain IPL2 as the first four characters of the record.

System Action: The system-defined IPL bootstrap records are written on the volume and command processing continues. The user-specified IPL bootstrap records and IPL program records are ignored.

Operator Response: None.

System Programmer Response: Correct the IPL bootstrap record format and reissue the command, or accept the system-defined IPL bootstrap records. Save the job output and contact your IBM service representative.

ICK21319I UNABLE TO WRITE BOOTSTRAP RECORD-1 ON VOLUME

Explanation: An I/O error occurred while attempting to write the first IPL bootstrap record on cylinder 0, track 0. The volume is unusable for IPL.

System Action: Command processing continues, but the IPL bootstrap records are not written on the volume.

Operator Response: None.

System Programmer Response: Either issue the INSPECT command to attempt to reclaim the track, or reinitialize the volume. Save the job output and contact your IBM service representative.

ICK21320I UNABLE TO WRITE BOOTSTRAP RECORD-2 ON VOLUME

Explanation: An I/O error occurred while attempting to write the second IPL bootstrap record on cylinder 0, track 0. The volume is unusable for IPL.

System Action: Command processing continues, but the IPL bootstrap records are not written on the volume.

Operator Response: None.

System Programmer Response: Either issue the INSPECT command to attempt to reclaim the track, or reinitialize the volume. Save the job output and contact your IBM service representative.

ICK21321I UNABLE TO WRITE IPL PROGRAM ON VOLUME

Explanation: An I/O error occurred while attempting to write the IPL program record on the volume. The volume is unusable for IPL.

System Action: Command processing continues, but the IPL program record is not written on the volume.

Operator Response: None.

System Programmer Response: Either issue the INSPECT command to attempt to reclaim the track, or reinitialize the volume. Save the job output and contact your IBM service representative.

ICK21322I SPECIFIED IPL PROGRAM LENGTH IS EXCESSIVE

Explanation: The total number of bytes required by the user-specified IPL program exceeds the maximum permitted for the volume being initialized.

System Action: Command processing continues, but the IPL program is not written on the volume.

Operator Response: None.

System Programmer Response: Determine the cause of the excessive size, and either recompile or reassemble the IPL program. Then reissue the command.

Save the job output and contact your IBM service representative.

ICK21323I IPL PROGRAM INPUT CONTAINS NO TXT CARDS

Explanation: The input records specified for the IPL program source were read, but contained no records that were identified as standard text (TXT) records.

System Action: The IPLDD parameter is ignored, and command processing continues.

Operator Response: None.

System Programmer Response: Be sure the correct input is supplied in the input stream or in the specified data set. Save the job output and contact your IBM service representative.

ICK21350I EXCESSIVE COMBINED ERROR RATE ON HEAD X'cccc hhhh'

Explanation: The specified head exceeded the acceptable error rate threshold for the device.

System Action: Command processing continues.

Operator Response: None.

System Programmer Response: See message ICK214011.

ICK21351I EXCESSIVE COMBINED ERROR RATE FOR ALL HEADS

Explanation: The combined error rate of all the heads in the diagnostic (CE) cylinder exceeded the acceptable error rate threshold for the device.

System Action: Command processing continues.

Operator Response: None.

Messages received at the output printer

System Programmer Response: See message ICK214011.

ICK21394I EXCESSIVE DATA CHECKS OCCURRING FOR TRACK
X'cccc hhhh'

Explanation: During skip displacement processing for the specified track, the number of data checks exceeded the device threshold for this device type.

System Action: Processing is completed for this track. ICKDSF continues with the next track.

Operator Response: None.

System Programmer Response: This message is an indication that an abnormal amount of data checks have occurred for this track. Although this message is intended as a warning, it is advisable to seek the aid of the IBM hardware service representative (particularly if the message is issued for multiple tracks).

If alternate track assignment is required, run INSPECT NOCHECK ASSIGN.

ICK21398I RECORD ZERO MAY BE INVALID ON TRACK X'cccc
hhhh'

Explanation: Rewriting of a standard record 0 could not be verified after the completion of surface checking. Surface checking was either successful or unsuccessful.

System Action: If this message is issued during either an INIT or an INSPECT NOPRESERVE, ICKDSF continues with the next track.

Operator Response: None.

System Programmer Response: This message is often accompanied by an indication that surface checking failed on the specified track. The accompanying messages, including the I/O error messages, should be examined to aid in determining the cause of the failure.

Support from your IBM representative might be required.

After the source of the error is corrected, run an INSPECT of the track to correct the bad record zero. Data recovery actions may be required if the accompanying messages indicate a data loss during INSPECT PRESERVE processing.

ICK21401I cccu SUSPECTED DRIVE PROBLEM

Explanation: An error was detected during the drive test.

System Action: Command processing ends.

Operator Response: None.

System Programmer Response: Previous messages should aid identification of the problem.

Save printer output. Take the action appropriate to your installation's procedures for handling suspected equipment problems. If the problem cannot be explained, contact your IBM hardware or software service representative.

You can also take these steps in the interim, depending on your installation's procedures:

- Restore the entire volume to another drive from a backup volume.
- Discontinue using the drive.

ICK21402I cccu ERROR READING DATA

Explanation: This message is issued if any data checks are detected during the data scan portion of the command.

System Action: ICKDSF continues.

Operator Response: None.

System Programmer Response: Examine previous messages to determine the nature and location of the data checks and then take appropriate action.

ICK21403I TEMPORARY EQUIPMENT CHECK LIMIT EXCEEDED,
ERROR INFORMATION FOLLOWS

Explanation: During the write and read test portion of the drive test, excessive temporary equipment checks were detected for this device type.

This message will be followed by the failing channel status word (CSW), channel command word (CCW), and sense bytes for each temporary equipment check that occurred.

System Action: Drive test processing ends if path control is not being used. If path control is being used, drive test processing ends on the current path and ICKDSF continues with the next available path specified.

Operator Response: None.

System Programmer Response: None.

ICK21404I WRT TST: FORMAT WRITE OF CE CYLINDER
FAILED ON HEAD = X'hhhh'

Explanation: An error was detected during the format write to the customer engineer (CE) cylinder.

System Action: Drive test processing ends if path control is not being used. If path control is being used, drive test processing ends on the current path and ICKDSF continues with the next available path specified.

Operator Response: None.

System Programmer Response: Examine previous messages to determine the cause of the error.

ICK21405I WRT TST: UPDATE WRITE OF CE CYLINDER
FAILED ON HEAD = X'hhhh'

Explanation: An error was detected during the update write to the customer engineer (CE) cylinder.

System Action: Drive test processing ends if path control is not being used. If path control is being used, drive test processing ends on the current path and ICKDSF continues with the next available path specified.

Operator Response: None.

System Programmer Response: Examine previous messages to determine the cause of the error.

ICK21406I CLEANUP TEST: CLEANUP OF CE CYLINDER
FAILED ON HEAD = X'hhhh'

Explanation: An error was detected while attempting to cleanup the tracks on the customer engineer (CE) cylinder after the drive test completed.

Messages received at the output printer

System Action: Drive test processing ends if path control is not being used. If path control is being used, drive test processing ends on the current path and ICKDSF continues with the next available path specified.

Operator Response: None.

System Programmer Response: Examine previous messages to determine the cause of the error.

ICK21407I UNCORRECTABLE DATA CHECK OCCURRED ON CE CYLINDER, HEAD = X'cccc hhhh', RECORD = X'rr'

Explanation: An uncorrectable data check was detected during the read test portion of the drive test. The message is followed by the failing CSW, CCW, and sense byte information.

System Action: ICKDSF continues. Processing may eventually end.

Operator Response: None.

System Programmer Response: Contact your IBM hardware service representative to aid in resolving the problem.

ICK21408I CE CYLINDER DATA CHECK THRESHOLD EXCEEDED

Explanation: During read testing from the customer engineer (CE) cylinder, excessive data checks were detected for this device type.

System Action: Drive test processing ends if path control is not being used. If path control is being used, drive test processing ends on the current path and ICKDSF continues with the next available path specified.

Operator Response: None.

System Programmer Response: Examine the error information contained in message ICK01415 and/or ICK21407 to determine the failing heads and records. Contact your IBM hardware service representative to aid in resolving the problem.

ICK21409I CORRECTABLE DATA CHECK LIMIT EXCEEDED ON CE CYLINDER, HEAD = X'hhhh'

Explanation: During the read test portion of the drive test, this head exceeded the error criterion. The message will be preceded by message ICK01415 for each record with a correctable data check.

System Action: Drive test processing ends if path control is not being used. If path control is being used, drive test processing ends on the current path and ICKDSF continues with the next available path specified.

Operator Response: None.

System Programmer Response: Examine the error information contained in message ICK01415 to determine the failing records. Contact your IBM hardware service representative for aid in resolving the problem.

ICK21410I READ TEST: READ TEST ON CE CYLINDER FAILED ON HEAD = X'hhhh'

Explanation: An error other than a data check occurred during the read test portion of the drive test.

System Action: Drive test processing ends if path control is not being used. If path control is being used, drive test processing ends on the current path and ICKDSF continues with the next available path specified.

Operator Response: None.

System Programmer Response: Examine previous messages to determine the cause of the problem.

ICK21420I DRIVE TEST: TESTING UNSUCCESSFUL ON:

CHPID = XX
CHANNEL NUMBER = X
CHANNEL SET = X
STORAGE DIRECTOR ID = XX
SUBSYSTEM ID = XXXX
CLUSTER = X
STORAGE PATH = X

Explanation: The drive test was unable to complete successfully on the indicated path where:

CHPID = XX identifies the CHPID for the path being processed. This line is displayed only if it applies to the operating system environment.

CHANNEL NUMBER = X identifies the channel number for the path being processed. This line is displayed only if it applies to the operating system environment.

CHANNEL SET = X identifies the channel set (CPU affinity) for the path being processed. This line is displayed only if it applies to the operating system environment.

STORAGE DIRECTOR ID = XX identifies the Storage Director Id for the path being processed. It contains the information present in sense byte 21. This line is displayed only if it applies to the storage control being processed.

SUBSYSTEM ID = XXXX identifies the Subsystem Id for the path being processed. It contains the information present in sense bytes 20 and 21. This line is displayed only if it applies to the storage control being processed.

CLUSTER = X identifies the Cluster for the path being processed. This line is displayed only if it applies to the storage control being processed.

STORAGE PATH = X identifies the Storage Path of the Cluster being processed. This line is displayed only if it applies to the storage control being processed.

System Action: Drive test processing ends on this path.

Operator Response: None.

System Programmer Response: Examine previous messages to determine the cause of the error on the specified path.

Messages received at the output printer

ICK21421I DRIVE TEST: I/O ERROR ON:

CHPID = XX
CHANNEL NUMBER = X
CHANNEL SET = X
STORAGE DIRECTOR ID = XX
SUBSYSTEM ID = XXXX
CLUSTER = X
STORAGE PATH = X

Explanation: An I/O error occurred on the indicated path. The csw, ccw, and sense byte information for the error are printed with the message.

CHPID = XX identifies the CHPID for the path being processed. This line is displayed only if it applies to the operating system environment.

CHANNEL NUMBER = X identifies the channel number for the path being processed.

CHANNEL SET = X identifies the channel set (CPU affinity) for the path being processed. This line is displayed only if it applies to the operating system environment.

STORAGE DIRECTOR ID = XX identifies the Storage Director Id for the path being processed. It contains the information present in sense byte 21. This line is displayed only if it applies to the storage control being processed, or if the error occurs after the Storage Director Id has been determined.

SUBSYSTEM ID = XXXX identifies the Subsystem Id for the path being processed. It contains the information present in sense bytes 20 and 21. This line is displayed only if it applies to the storage control being processed, or if the error occurs after the Subsystem ID has been determined.

CLUSTER = X identifies the Cluster for the path to be processed. This line is displayed only if it applies to the storage control being processed, or if the error occurs after the Cluster has been determined.

STORAGE PATH = X identifies the Storage Path of the Cluster to be processed. This line displayed only if it applies to the storage control being processed, or if the error occurs after the Storage Path has been determined.

System Action: No further processing occurs on this path.

Operator Response: None.

System Programmer Response: Examine the CCW, CSW, and sense information to determine the cause of the error.

ICK21422I CHPID/ALLCHPID INVALID FOR THIS ENVIRONMENT

Explanation: The CHPID and ALLCHPID parameters are only valid in the MVS, CMS, and Stand-Alone environments.

System Action: Drive test processing is bypassed.

Operator Response: None.

System Programmer Response: Correct the parameters and rerun the job.

ICK21423I CHANNUM/ALLCHAN/CHANSET INVALID FOR THIS ENVIRONMENT

Explanation: The CHANNUM, ALLCHAN, and CHANSET parameters are not valid in this environment.

System Action: Drive test processing is bypassed.

Operator Response: None.

System Programmer Response: Correct the parameters, then rerun the job.

ICK21424I UNKNOWN PATH SPECIFIED

CHPID = XX
CHANNEL NUMBER = X

Explanation: The CHPID or CHANNEL specified in the parameters does not match any of the valid paths determined by ICKDSF. Either CHPID = XX or CHANNEL NUMBER = X will be displayed, depending on the parameters specified.

System Action: ICKDSF continues with the next valid path specified.

Operator Response: None.

System Programmer Response: Correct the parameters, then rerun the job.

ICK21425I INVALID SPECIFICATION FOR PATH PARAMETERS:
xx

Explanation: The CHPID or channel specified in the parameters is not a valid value. XX is the value that is not valid.

The valid values for CHPID are 00 thru FF.

The valid values for CHANNUM are 0 thru F.

System Action: Drive test processing is bypassed.

Operator Response: None.

System Programmer Response: Correct the parameters, then rerun the job.

ICK21454I UNABLE TO READ DATA ON PRIMARY VOLUME FOR TRACK CCHH = X'cccc hhhh', PROCESS TERMINATING

Explanation: While INSPECT was processing the secondary volume of a dual copy pair, it attempted to determine if the corresponding track on the primary volume was readable. In this case, the track on the primary volume is not readable.

The previous ICK10710I message contains the CCW, CSW, and sense information for the error.

System Action: Because *TOLERATE(PRIFAIL)* is not specified, the track on the secondary volume is not inspected. Command processing ends on this track and continues with the next track.

Operator Response: None.

System Programmer Response: Examine the CCW, CSW, and sense information to determine the cause of the error on the primary volume. Then take action appropriate to your

Messages received at the output printer

installation's procedures for handling errors on the primary volume of a dual copy pair.

ICK21461I NON-STANDARD RECORD ZERO EXISTS ON PRIMARY VOLUME FOR TRACK CCHH = X'cccc hhhh' PROCESS TERMINATING

Explanation: A non-standard record 0 condition exists on the primary volume of a dual copy pair.

System Action: Since TOLERATE(PRIFAIL) is not specified, command processing ends for the track on the secondary volume.

Operator Response: None.

System Programmer Response: Put the primary volume in simplex state and run INSPECT NOPRESERVE on the track on the primary volume.

ICK21601I I/O ERROR ON PATH XX

Explanation: An I/O error occurred on the indicated path while attempting to determine the potential paths to the device. The CSW, CCW, and sense bytes for the error are printed with the message.

System Action: No further processing occurs on this path.

Operator Response: None.

System Programmer Response: Examine the CCW, CSW, and sense information to determine the cause of the error.

ICK21721I FIXED BLOCK WRITE C.E. AREA TEST: BWRCE

Explanation: An error was detected during the write to the customer engineer (CE) cylinder.

System Action: Command processing ends with a return code of 8.

Operator Response: None.

System Programmer Response: Check subsequent messages for status of drive.

ICK21723I FIXED BLOCK CALIBRATION SEEK TEST: BCALSK

Explanation: An error was detected while moving the access arm from block 244 to a specified location, and returning again to read.

System Action: ANALYZE command processing ends with a return code of 8.

Operator Response: None.

System Programmer Response: Check subsequent messages for status of drive.

ICK21725I MULTIPLE BLOCK WRITE TEST: BHDSK

Explanation: An error was detected while attempting to write multiple blocks and to seek the next sequential track.

System Action: ANALYZE command processing ends with a return code of 8.

Operator Response: None.

System Programmer Response: Check subsequent messages for status of drive.

ICK21727I FIXED BLOCK INCREMENTAL SEEK TEST: BINCSK

Explanation: An error was detected while attempting to incrementally move the access arm to read.

System Action: ANALYZE command processing ends with a return code of 8.

Operator Response: None.

System Programmer Response: Check subsequent messages for status of drive.

ICK21729I FIXED BLOCK SERVO SEEK TEST: BSRVOSK

Explanation: An error was detected during an attempt to write and read back block 244 of the CE area.

System Action: ANALYZE command processing ends with a return code of 8.

Operator Response: None.

System Programmer Response: Contact your IBM hardware service representative.

ICK21731I FIXED BLOCK RANDOM SEEK TEST: BRANSK

Explanation: An error was detected during an attempt to switch heads randomly to read.

System Action: ANALYZE command processing ends with a return code of 8.

Operator Response: None.

System Programmer Response: Check subsequent messages for status of drive.

ICK21733I FIXED BLOCK READ PREFORMATTED BLOCK TEST: BWRNFPS

Explanation: An error was detected while attempting to read block 296 of the CE area.

System Action: ANALYZE command processing ends with a return code of 8.

Operator Response: None.

System Programmer Response: Check subsequent messages for status of drive.

ICK21735I FIXED BLOCK WRITE PRESELECTED BLOCKS TEST: BWRNFP

Explanation: An error was detected while attempting to write multiple blocks in the CE area.

System Action: ANALYZE command processing ends with a return code of 8.

Operator Response: None.

System Programmer Response: Check subsequent messages for status of drive.

Messages received at the output printer

ICK21736I FIXED BLOCK WRITE/READ PRESELECTED BLOCKS
TEST: BRRDRV

Explanation: An error was detected during the write/read tests on preselected blocks on a track in the CE cylinder.

System Action: ANALYZE drive test continues processing by testing blocks on the next track of the CE cylinder.

Operator Response: None.

System Programmer Response: Check subsequent messages for status of drive.

ICK21737I FIXED BLOCK ERROR READING ID FIELD,
TESTING TERMINATED

Explanation: An error was detected while reading the ID field on the CE cylinder.

System Action: ANALYZE command processing ends with a return code of 8.

Operator Response: None.

System Programmer Response: Check subsequent messages for status of drive.

ICK21738I FIXED BLOCK DATA COMPARE FAILED: BRRDRV

Explanation: An error was detected when the data in the data record read did not compare equally with the data previously written to the same record.

System Action: ANALYZE drive test continues processing by testing blocks on the next track of the CE cylinder.

Operator Response: None.

System Programmer Response: Check subsequent messages for status of drive.

ICK21739I FIXED BLOCK DATA COMPARE FAILED: BWRCE

Explanation: An error is detected when the record read did not compare equally with the same record previously written.

System Action: ANALYZE command processing ends with a return code of 8.

Operator Response: None.

System Programmer Response: Check subsequent messages for status of drive.

ICK21750I SNS TEST: ERROR IN SENSE CCW

Explanation: An error was detected when ANALYZE failed to obtain sense information. This message is followed by a printout of the failing CCW, CSW, and sense information.

System Action: ANALYZE command processing ends with a return code of 8.

Operator Response: None.

System Programmer Response: Check subsequent messages for status of drive.

ICK21752I RECAL TEST: RECALIBRATE TO CYL 0 HEAD 0

Explanation: An error was detected while ANALYZE attempted to recalibrate the access arm to cylinder 0, head 0. This message is followed by a printout of the failing CCW, CSW, and sense information.

System Action: ANALYZE command processing ends with a return code of 8.

Operator Response: None.

System Programmer Response: Check subsequent messages for status of drive.

ICK21754I RHAMH TEST: READ HOME ADDRESS UNDER
MOVABLE HEADS FAILED.

Explanation: An error was detected when ANALYZE failed to read home addresses under all the movable heads. This message is followed by a printout of the failing CCW, CSW, and sense information.

System Action: ANALYZE command processing ends with a return code of 8.

Operator Response: None.

System Programmer Response: Check subsequent messages for status of drive.

ICK21755I READ FOR PRESERVE OF BLOCK xxxxxxxx
FAILED: NON-CORRECTABLE DATA CHECKS
PROCESSING OF BLOCK TERMINATED

Explanation: The user data on block xxxxxxxx could not be read because of permanent data checks.

System Action: Diagnostic information is printed on the output device. Processing of the block ends to prevent the loss of the user data on the block. ICKDSF continues with the next valid block specified in the BLOCKS parameter.

Operator Response: None.

System Programmer Response: Begin error recovery procedures for the data set containing the block in error, and rerun the command for the block in error with NOPRESERVE specified.

Save the job output and contact your IBM service representative.

ICK21756I RHAFH TEST: READ HOME ADDRESS UNDER FIXED
HEADS FAILED.

Explanation: An error was detected when ANALYZE failed to read home addresses under all the fixed heads. This message is followed by a printout of the failing CCW, CSW, and sense information.

System Action: ANALYZE command processing ends with a return code of 8.

Operator Response: None.

System Programmer Response: Check subsequent messages for status of drive.

Messages received at the output printer

ICK21758I SKINCR TEST: INCREMENTAL MOVEMENT OF ACCESS ARM FAILED.

Explanation: An error was detected when ANALYZE failed to incrementally move the access arm. This message is followed by a printout of the failing CCW, CSW, and sense information.

System Action: ANALYZE command processing ends with a return code of 8.

Operator Response: None.

System Programmer Response: Check subsequent messages for status of drive.

ICK21760I SKRAN TEST: RANDOM CYLINDER ACCESS FAILED.

Explanation: An error was detected when ANALYZE failed to move the access arm randomly from one cylinder address to another. This message is followed by a printout of the failing CCW, CSW, and sense information.

System Action: ANALYZE command processing ends with a return code of 8.

Operator Response: None.

System Programmer Response: Check subsequent messages for status of drive.

ICK21762I SKMAX TEST: SEEK FROM CYLINDER 0 TO MAXIMUM CYLINDER FAILED.

Explanation: An error was detected when ANALYZE failed to move the access arm from cylinder 0 to the maximum cylinder address. This message is followed by a printout of the failing CCW, CSW, and sense information.

System Action: ANALYZE command processing ends with a return code of 8.

Operator Response: None.

System Programmer Response: Check subsequent messages for status of drive.

ICK21764I RHA TEST: READ HOME ADDRESS ON C.E. CYLINDER FAILED. WRITE TEST BYPASSED.

Explanation: An error was detected when ANALYZE failed to read the CE cylinder's home address. This message is followed by a printout of the failing CCW, CSW, and sense information.

System Action: ANALYZE command processing continues, but does not process the write tests on the CE cylinder. The return code is set to 8.

Operator Response: None.

System Programmer Response: Check subsequent messages for status of drive.

ICK21765I UNABLE TO WRITE HOME ADDRESSES ON CCHH = X'cccc hhhh'

Explanation: An error occurred while attempting to write the home address on the CE cylinder. This message is followed by the failing CCW, CSW, and sense.

System Action: If path control is in effect, ICKDSF continues

with the next path to be processed. If path control is not in effect, command processing ends.

Operator Response: None.

System Programmer Response: Contact your IBM hardware service representative to aid in resolving the problem.

ICK21766I WRT TEST: WRITE RECORDS R0 AND R1 ON C.E. CYLINDER FAILED.

Explanation: An error was detected when ANALYZE failed to write records 0 and 1 on the CE cylinder. This message is followed by a printout of the failing CCW, CSW, and sense information.

System Action: ANALYZE command processing ends with a return code of 8.

Operator Response: None.

System Programmer Response: Check subsequent messages for status of drive.

ICK21768I RDMT TEST: MULTI-TRACK READ ON C.E. CYLINDER FAILED

Explanation: An error was detected when ANALYZE failed to read records on the CE cylinder. This message is followed by a printout of the failing CCW, CSW, and sense information.

System Action: ANALYZE command processing ends with a return code of 8.

Operator Response: None.

System Programmer Response: Check subsequent messages for status of drive.

ICK21770I RMDT DATA COMPARE TEST: WRONG RECORD READ

Explanation: An error was detected when a drive error caused the wrong record to be read. This message is followed by a printout of the failing CCW, CSW, and sense information, although the sense information will be zero if no unit check is indicated in the CSW.

System Action: ANALYZE command processing ends with a return code of 8.

Operator Response: None.

System Programmer Response: Check subsequent messages for status of drive.

ICK21772I WRTPAD READ WRONG RECORD--EXP=xxxxxxx, REC=yyyyyyy

Explanation: An error was detected while ANALYZE attempted to write a record using the write count, key, data CCW, and to read it back. The record read back was not as expected.

xxxxxxx is the description of the record that was expected. It is the data that was written.

yyyyyyy is the description of the record that was received.

System Action: ANALYZE command processing ends with a return code of 8.

Operator Response: None.

Messages received at the output printer

System Programmer Response: Check subsequent messages for status of drive.

ICK21774I WRTPAD TEST: WRITE COUNT, KEY, DATA FAILED

Explanation: An error was detected when ANALYZE failed to write a record using the write count, key, data CCW. This message is followed by a printout of the failing CCW, CSW, and sense information.

System Action: ANALYZE command processing ends with a return code of 8.

Operator Response: None.

System Programmer Response: Check subsequent messages for status of drive.

ICK21775I DATAVER: DATA CHECKS EXCEEDED THRESHOLD -
PROCESS CONTINUING

Explanation: The number of data checks exceeded the limit set for the specified device. For CKD devices, this limit is equivalent to 50.

System Action: INSTALL command processing completes the mode change before ending.

Operator Response: None.

System Programmer Response: Run the ANALYZE command with the scan parameter on the volume. Save the console and printer output for the INSTALL and ANALYZE commands and take action appropriate to your installation procedures for determining if an equipment problem is suspected.

If the problem is determined to be equipment-related, contact your IBM hardware or software service representative.

ICK21776I DATAVER TEST: ERROR DURING DATA
VERIFICATION

Explanation: A drive error was detected during the data verification test.

This message is followed by a printout of the failing CCW, CSW, and sense information.

System Action: Command processing ends with a return code of 8.

Operator Response: None.

System Programmer Response: Contact your IBM hardware service representative for the drive error.

ICK21778I CLEANUP TEST: CLEANUP OF C.E. CYLINDER
TRACK 0 FAILED

Explanation: An error was detected when ANALYZE completed its test and an error occurred during the cleanup of track 1 on the CE cylinder.

This message is followed by a printout of the failing CCW, CSW, and sense information.

System Action: ANALYZE command processing ends with a return code of 8.

Operator Response: None.

System Programmer Response: Check subsequent messages for status of drive.

ICK21786I RPS ERROR: READ SECTOR OR SET SECTOR
FAILED

Explanation: An error was detected when ANALYZE failed to read sector or to set sector.

This message is followed by a printout of the failing CCW, CSW and sense information.

System Action: ANALYZE command processing ends with a return code of 8.

Operator Response: None.

System Programmer Response: Contact your IBM hardware service representative.

ICK21798I INVALID TRACK FORMAT ON CYLINDER = xxxx
HEAD x

Explanation: A track was encountered during reclaim processing with a format which is not consistent with the information in the factory defect map for the track.

System Action: Reclaim processing of the indicated track ends. Reclaim processing continues with the next sequential track.

Operator Response: None.

System Programmer Response: Contact your IBM hardware service representative. Save the job output and contact your IBM service representative.

ICK21826I INVALID TRACK FORMAT ON TRACK CCHH =
X'cccc hhhh'

Explanation: A track format condition that is not valid was detected while attempting to preserve data on the specified track. This usually indicates that data has been written to the track beyond the track capacity. It is generally a user error.

System Action: The record on the specified track is not lost, and the track is not marked defective.

The specified track is not surface-checked. ICKDSF continues with the next track. The return code is set to 8.

Operator Response: None.

System Programmer Response: Determine the data set containing the specified track. Determine how, when, and where the data on the specified track was written, in order to find how the track format condition that was not valid occurred.

Begin recovery of the data on the track using your installation's procedures. Then inspect the failing track specifying NOPRESERVE.

ICK21831I NO PATHS HAVE BEEN WRITE ALLOWED

Explanation: During processing of the CONTROL command to allow write access to the paths to a device, the write-allow was unsuccessful for all paths.

System Action: The return code is set to 8.

Operator Response: None.

Messages received at the output printer

System Programmer Response: Rerun the job for a device that is known to go through the storage control that has been write-prevented.

This condition can also arise if the required path has been reserved for too long a duration, and the operator requested that retry end. If this condition exists, action must be taken to ensure that the path is released so that the job can be rerun.

ICK21832I FENCE STATUS INDETERMINATE

Explanation: A CONTROL command (with CLEARFENCE parameter) to reset a fence status is unsuccessful. The device fence status cannot be determined at this time.

System Action: The return code is set to 8 and ICKDSF continues.

Operator Response: None.

System Programmer Response: This condition can arise if the required path has been reserved for too long a duration, and the operator requests that retry ends. If this condition exists, action must be taken to ensure that the path is released so the job can be rerun.

If a fence condition exists for this device, other methods may have to be used to unfence the device. Contact your IBM service representative.

ICK21833I DEVICE cccu FENCE STATUS STILL EXISTS ON -- CLUSTER x STORAGE PATH y

Explanation: The CONTROL command (with CLEARFENCE parameter) has successfully issued the CCW to reset the fence status. However, the allowable time period expired, but the device fence status still exists on the storage path indicated.

System Action: Processing continues.

Operator Response: None

System Programmer Response: Contact your IBM hardware service representative.

ICK21834D PATH xxxx,y RESERVED-REPLY U TO RETRY WRITE ALLOW, T TO IGNORE

Explanation: This message is issued to the system operator if the CONTROL command encounters a path that remains reserved for all of its retries.

xxxx is the unit address

y is the path ID (CHPID).

Reply:

- U to reissue the write-allow to the device.
- T to ignore this path and continue with the next path.

System Action: The system waits for your response.

Operator Response: Respond U or T.

System Programmer Response: None.

ICK21835D DEVICE cccu RESERVED-REPLY U TO RETRY CLEAR FENCE, ELSE T

Explanation: This message is issued if a device or path remains reserved for the duration of CONTROL command (with the CLEARFENCE parameter) processing.

Reply:

- U to reissue the CONTROL command.
- T to ignore this path and continue CONTROL command processing with the next path.

System Action: The system waits for your response.

Operator Response: Respond U or T.

System Programmer Response: None.

ICK21836D IPL TEXT EXISTS ON valid. REPLY U TO OVERLAY, ELSE T.

Explanation: An attempt is made to replace the IPL text on a volume that already contains IPL text.

Reply:

- U to place the new IPL text on the volume.
- T to end command processing.

System Action: The system waits for your response.

Operator Response: Respond U or T.

System Programmer Response: None.

ICK21837I SP FENCE STATUS STILL EXISTS ON CLUSTER x STORAGE PATH y THROUGH CHANNEL-SWITCH z

Explanation: The CONTROL command (with CLEARFENCE parameter) has successfully issued the CCW to reset the fence status. However, the allowable time period has expired, but the SP fence status still exists on the storage path through the specified channel-switch.

System Action: Processing continues.

Operator Response: None.

System Programmer Response: Contact your IBM hardware service representative.

ICK21850I EXTENDED CKD FUNCTIONS CANNOT BE ACTIVATED - MINIMAL INIT FORCED

Explanation: The device has never been online to the operating system and the operating system cache logic has not been activated. ICKDSF surface checking functions cannot be performed.

System Action: Command processing continues as if a minimal initialization has been requested. This enables the volume label and the VTOC to be written to the volume.

Operator Response: The device must be either varied online and varied offline, or varied online and the job run online. (This enables activation of the operating system cache logic.)

System Programmer Response: The device cannot be varied online if the volume label is the same as a volume label that is already online. In this case, run either the INIT or the REFORMAT command to change the volume label.

After the device has been varied online (and offline again if

Messages received at the output printer

necessary), the job can be re-run.

ICK22130D DATA CANNOT BE RECOVERED FOR TRACK X'cccc
hhhh' REPLY C TO ERASE AND CONTINUE, T TO
TERMINATE, I TO IGNORE

Explanation: The previous INSPECT command did not complete processing during PRESERVE backup processing.

Note: The data cannot be recovered from the backup location.

Reply:

- C to erase data at the backup location, and begin processing from the start of the specified range. (Specify C if there is no need to recover data from the backup location.)
- I to ignore recovery data, and continue processing for the current invocation. (Note that this response is allowed only if HOLDIT was specified.) The recovery data remains intact. The next invocation of the INSPECT command will again attempt to process the recovery data.
- T to end processing. The recovery data remains intact. (Specify T to retry the recovery process, or to examine the situation before allowing the data to be erased.) The next invocation of the INSPECT command will again attempt to process the recovery data.

System Action: The system waits for a response. (The ignore response option is provided if HOLDIT is specified on the current invocation of the INSPECT command.)

Operator Response: Respond C, I, or T.

System Programmer Response: None.

ICK22131I ALTERNATE TRACK CANNOT BE ASSIGNED FOR THE
RECOVERY TRACK

Explanation: The track for which backup recovery is processing is defective, but there are no available alternate tracks.

System Action: An attempt is made to write the backup recovery data to the recovery track without an alternate track assigned.

If the procedure fails, subsequent messages will indicate system action.

Operator Response: None.

System Programmer Response: In an attempt to make alternate tracks available for future use, it is recommended that INSPECT RECLAIM be run for tracks that have alternates assigned.

ICK22158D DATA CANNOT BE RECOVERED FOR BLOCK
xxxxxxx REPLY "C" TO ERASE AND CONTINUE,
"I" TO IGNORE, T TO TERMINATE.

Explanation: The previous invocation of the INSPECT command did not run to completion during PRESERVE backup processing.

Note: The data cannot be recovered from the backup location.

Reply:

- C to erase data from the backup location, and begin processing from the start of the specified range. (Specify C if there is no need to recover data from the backup location.)
- I to ignore the recovery data and continue processing for the current invocation. (Note that this response is allowed only if HOLDIT was specified.) The recovery data remains intact. The next invocation of the INSPECT command will again attempt to process the recovery data.
- T to end processing. The recovery data remains intact. (Specify T to retry the recovery process, or to examine the situation before allowing the data to be erased.) The next invocation of the INSPECT command will again attempt to process the recovery data.

System Action: The operator is prompted for a reply to this message. (The ignore option is provided if HOLDIT is specified on the current invocation of the INSPECT command.)

Operator Response: Respond C, T, or I.

System Programmer Response: None.

ICK22176I DATA CHECK THRESHOLD EXCEEDED ON ONE OR
MORE HEADS

Explanation: The ANALYZE SCAN function found that the data error rate on one or more heads exceeded the data check error rate threshold criterion for the device.

System Action: A moveable head error table is printed on the ICKDSF output device with a T in the DATA CHK column indicating which head or heads exceeded the data check error rate threshold.

Operator Response: None.

System Programmer Response: The moveable head error table and previous messages will aid in identifying the problem. Save the printer output from the ANALYZE run and take action appropriate to your installation's procedures for handling suspected equipment problems. If your problem cannot be determined, contact your IBM service representative.

ICK22201I TRACK X'cccc hhhh' WAS NOT INSPECTED DUE TO
ENQUEUE FAILURE ON -- xxxxxx

Explanation: The data set enqueue for track X'cccc hhhh' failed.

xxxxxx is the data set name.

TOLERATE(ENQFAIL) was not specified. The track was not INSPECTed.

System Action: INSPECT continues on the next track.

Operator Response: None.

System Programmer Response: The job should be rerun for this track when the data set is available.

If it is certain that the data set will never be available for exclusive control, but the track must be inspected, rerun the job for this track specifying TOLERATE(ENQFAIL).

Messages received at the output printer

ICK22205I TRACK X'cccc hhhh' WAS NOT INSPECTED --
VSAM DATA SET CAN NOT BE ENQUEUED

Explanation: The specified track is part of a VSAM data set. ICKDSF does not support data set enqueue for VSAM data sets. The track was not inspected because TOLERATE(ENQFAIL) was not specified or assumed.

System Action: ICKDSF continues on the next track.

Operator Response: None.

System Programmer Response: An INSPECT for this track should be done either with the device mounted offline, or by specifying TOLERATE(ENQFAIL).

ICK22206I TRACK X'cccc hhhh' WAS NOT PROCESSED DUE TO
ENQUEUE FAILURE ON - xxxxxx

Explanation: The data set enqueue for track X'cccc hhhh' failed.

xxxxxx is the data set name.

TOLERATE(ENQFAIL) was not specified. The track was not processed.

System Action: Command processing continues on the next track.

Operator Response: None.

System Programmer Response: The job should be rerun for this track when the data set is available.

ICK22207I TRACK X'cccc hhhh' WAS NOT PROCESSED - VSAM
DATA SET CAN BE ENQUEUED

Explanation: The specified track is part of a VSAM data set. ICKDSF does not support data set enqueue for VSAM data sets. The track was not processed because TOLERATE(ENQFAIL) was not specified or assumed.

System Action: Command processing continues on the next track.

Operator Response: None.

System Programmer Response: The job should be rerun for this track either with the device mounted offline or by specifying TOLERATE(ENQFAIL).

ICK24000I UNABLE TO PRESERVE DATA FOR TRACK X'cccc
hhhh'

Explanation: The current ICKDSF process can not assign a temporary alternate location before media maintenance action can be taken on the specified track.

System Action: The cause of the error is printed and command processing continues on the next track.

Operator Response: None.

System Programmer Response: See the Programmer Response for the other error messages which are issued.

ICK24001I SUBSYSTEM FUNCTION HAS BEEN CANCELLED

Explanation: The current ICKDSF process has determined that a previously issued PSF command has been cancelled. The cancellation can be caused either by ICKDSF if the maximum run time is exceeded, or by a process other than ICKDSF.

System Action: Command processing ends.

Operator Response: None.

System Programmer Response: See accompanying error messages to determine the cause of the subsystem function being cancelled. Re-run the command if necessary.

ICK24002I UNABLE TO OBTAIN THE TRACK STATUS FOR
TRACK X'cccc hhhh'

Explanation: The current ICKDSF process is unable to determine the current track status for the specified track because of either an I/O error or a subsystem function failure.

System Action: Command processing continues.

Operator Response: None.

System Programmer Response: None.

ICK24003I UNABLE TO READ PRIMARY TRACK X'cccc hhhh'
AFTER DATA IS RESTORED

Explanation: After the media maintenance function, an attempt was made to restore the data on the primary track from a previously assigned temporary alternate location. The restore function failed because of a primary track read failure.

System Action: The specified primary track is permanently assigned to an alternate location. Command processing continues on the next track.

Operator Response: None.

System Programmer Response: None

ICK24004I PRIMARY TRACK READ FAILURE IS DETECTED

Explanation: During the media maintenance PRESERVE function, the data on the primary track could not be read because of either an I/O error or a subsystem function failure.

System Action: The associated error information is printed and the function continues on the next track.

Operator Response: None.

System Programmer Response: Run the job again with NOPRESERVE option. Call your IBM service representative if necessary.

ICK24005I ALTERNATE LOCATION READ FAILURE IS
DETECTED

Explanation: During the media maintenance PRESERVE function, the data on the alternate location could not be read because of a subsystem function failure.

System Action: The associated error information is printed and the function continues on the next track.

Operator Response: None.

Messages received at the output printer

System Programmer Response: Run the job again with NOPRESERVE option. Call your IBM service representative if necessary.

ICK24050I **DEVICE SPECIFIED IS NOT THE PRIMARY OF A PPRC PAIR**

Explanation: The device is not the primary of a PPRC pair. PPRC QUERY PATHS directs PPRC to display all of the paths associated with application site storage control (primary).

System Action: Command Processing ends.

Operator Response: None.

System Programmer Response: Re-issue the command without PATHS parameter or reissue the command to a primary volume.

ICK24051I **DEVICE SPECIFIED IS A DUAL COPY VOLUME**

Explanation: The device is a dual copy volume. It is not a PPRC or simplex volume. PPRC QUERY command will not display Volume or Paths information for a dual copy volume.

System Action: Command Processing ends.

Operator Response: None.

System Programmer Response: If a user needs to establish a PPRC pair, the dual copy pair will have to be ended before issuing PPRCOPY ESTPAIR command.

ICK24052I **ESTPAIR COMPLETED WITH ERRORS**

Explanation: A PPRCOPY ESTPAIR command with the MSGREQ parameter completed successfully but encountered correctable errors. The copy is complete and the volume pair is in duplex state.

System Action: Command Processing continues.

Operator Response: None.

System Programmer Response: Look for any console messages issued and refer to the IBM 3990 Storage Control Reference for Model 6 for information related to returned sense data. Notify your service representative of any hardware error conditions.

ICK30003I **FUNCTION TERMINATED. CONDITION CODE IS nn hh:mm:ss mm/dd/yy**

Explanation: A command has encountered an abnormal ending error condition during processing. The value is the last condition code (LASTCC) generated during command processing. Messages printed just prior to this message indicate the nature of the error.

Note that the LASTCC value is the highest condition code found in the messages printed during command processing.

hh:mm:ss and mm/dd/yy are the hours, minutes and seconds, and month, day, and year, respectively, of the date and time of the message.

System Action: ICKDSF continues with the next command. LASTCC is set to nn; MAXCC is set to nn if nn is greater than the current value of MAXCC.

Operator Response: None.

System Programmer Response: Correct the cause of the error, and reissue the command. Save the job output and contact your IBM service representative.

ICK30004I **FUNCTION TERMINATED. INSUFFICIENT MAIN STORAGE**

Explanation: The size of allocated virtual storage is too small.

System Action: ICKDSF continues with the next command.

Operator Response: None.

System Programmer Response: Increase the allocated size of virtual storage, and reissue the command. Save the output and contact your IBM service representative.

ICK30008I *function* **NOT SUPPORTED IN THIS ENVIRONMENT**

Explanation: The version of ICKDSF that is being used does not support the function specified.

System Action: Command processing ends.

Operator Response: None.

System Programmer Response: Refer to the command description in the user's guide to see which functions are supported for the version of ICKDSF you are running. Either run the job again with the appropriate parameters, or make sure that you are running with the version of ICKDSF that supports the function requested.

ICK30009I **CPU CLOCK IS NOT SET OR NOT OPERATIONAL**

Explanation: The processor clock has not been set or is not operational.

System Action: Command processing ends with an ICKDSF return code of 12.

Operator Response: Set the clock.

System Programmer Response: Set the clock.

ICK30091I **ccuu NED INFORMATION DOES NOT MATCH FOR ONE OR MORE PATHS:**
NED=ttttt.mmm.mfg.lc.sssssssssss,
CHPID=xx

Explanation: A configuration error was detected. Multiple paths to this host exist, but the device NED information does not match on each path. The NED information is printed for each CHPID. The NED information shown is in the following format:

ttttt = device type
mmm = model
mfg = manufacturer
lc = manufacturing location
ssssssssss = sequence number

Note: The information in the above fields are printed as they are returned from the device. If blanks are returned, then blanks will be printed. Unprintable characters may be printed as '.'. Some examples of this are:

- The device type field, ttttt, is a 6-digit field. The information is printed in the message as it is returned from the device.

Messages received at the output printer

For example, when the first 2-digits are returned as blanks by the device, they will be printed as blanks in the message. So the device type field will appear to have leading blanks.

- Some devices (for example 2105) returns blanks in the model field, so the model field will be blank in the message.

System Action: ICKDSF terminates.

Operator Response: Contact the system programmer.

System Programmer Response: A path or paths may be cabled incorrectly. Examine the information for each path to determine which path or paths do not match, and take the necessary action to correct the problem.

ICK30101I NO PATHS AVAILABLE TO EXECUTE DRIVE TEST

Explanation: ICKDSF was unable to locate any available paths that match the specified path parameters because one or more of the following conditions were detected:

- The user specified path did not match any of the paths found by ICKDSF. Message ICK21424I was previously issued for the path that does not match. The PATH STATUS table indicates the paths found by ICKDSF. Correct the parameters to specify a valid path and run the job again.
- The user specified path is not operational. The PATH STATUS table indicates the path is unavailable. Determine the reason the path is not operational.
- The user specified path encountered an error that prevents further testing on the path. Examine previous error messages to determine the cause of the error. Take action appropriate to your installation's procedures for handling suspected equipment problems.

The message relates only to paths specified in the parameters. Paths that may be available but were not specified are not considered.

System Action: Command processing ends.

Operator Response: None.

System Programmer Response: See explanation.

ICK30111I DEVICE SPECIFIED IS THE SECONDARY OF A DUPLEX OR PPRC PAIR

Explanation: The specified device is the secondary device address of a duplex or pprc pair. You must specify the primary device address.

System Action: Command processing ends.

Operator Response: None.

System Programmer Response: Specify the primary device address and submit the job again.

ICK30112I DEVICE SPECIFIED IS IN DUPLEX PENDING STATE

Explanation: The specified device of a duplex pair is in a temporary state. The subsystem is in the process of synchronizing the two devices.

System Action: Command processing ends.

Operator Response: None.

System Programmer Response: Submit the job again when

the duplexing operation completes.

ICK30113I DEVICE SPECIFIED IS NOT IN SIMPLEX STATE

Explanation: The device specified is a duplex pair and ICKDSF function cannot be performed.

System Action: Command processing ends.

Operator Response: None.

System Programmer Response: To perform the specified function, place the device in simplex state and submit the job again. (Note that limited ICKDSF functions support the device in dual copy mode.)

ICK30114I PINNED DATA EXISTS, MODE SWITCHING IS NOT ALLOWED

Explanation: The mode switch of an IBM 3390 from 3390 mode to 3380 track compatibility mode or vice-versa cannot be performed because of pinned data in the control unit. (See pinned data in *IBM 3990 Storage Control Reference*.)

System Action: Command processing ends.

Operator Response: None.

System Programmer Response: To perform mode switching, discard the pinned data and submit the job again.

ICK30115I DEVICE SPECIFIED IS IN PPRC PENDING STATE

Explanation: The device is in a PPRC pending state. Copy to establish a PPRC pair is in progress.

System Action: Command processing ends.

Operator Response: None.

System Programmer Response: Re-issue the command when the copy has been completed.

ICK30116I DEVICE SPECIFIED IS THE PRIMARY OF A PPRC PAIR

Explanation: The PPRCOPY RECOVER command is only valid on the secondary device of a PPRC pair.

System Action: Command processing ends.

Operator Response: None.

System Programmer Response: Verify the device number is the secondary volume and re-issue the PPRCOPY RECOVER command.

ICK30130I ccuu DEVICE NOT OPERATIONAL

Explanation: The device address you specified is not operational.

System Action: Command processing ends.

Operator Response: None.

System Programmer Response: Verify that a path is available to the device. Save the output and contact your IBM service representative if necessary.

Messages received at the output printer

ICK30200I TOO MANY POSITIONAL PARAMETERS AFTER xxxx

Explanation: A parameter list has too many specified positional parameters following the characters xxxx.

System Action: The command ends. ICKDSF continues with the next command.

Operator Response: None.

System Programmer Response: Remove the excess parameters and issue the command again. Save the output and contact your IBM service representative.

ICK30201I CONSTANT xxxx EXCEEDS LENGTH LIMIT

Explanation: The constant xxxx contains more characters than the maximum permitted by the command syntax.

System Action: The command ends. ICKDSF continues with the next command.

Operator Response: None.

System Programmer Response: Correct the constant, and issue the command again. Save the output and contact your IBM service representative.

ICK30202I ABOVE TEXT BYPASSED UNTIL NEXT COMMAND.
CONDITION CODE IS 12

Explanation: There is a syntax error in the command. The remainder of the command is ignored.

Messages printed just prior to this message indicate the nature of the error.

System Action: The command ends. ICKDSF continues with the next command.

Operator Response: None.

System Programmer Response: Correct the syntax error, and issue the command again. Save the output and contact your IBM service representative.

ICK30203I ITEM xxxx DOES NOT ADHERE TO RESTRICTIONS

Explanation: An indicated parameter does not conform to required naming conventions. For example, *dname* may be misspelled.

System Action: The command ends. ICKDSF continues with the next command.

Operator Response: None.

System Programmer Response: Correct the parameter error, and issue the command again. Save the output and contact your IBM service representative.

ICK30205I DELIMITER xxxx IS NOT PROPERLY PRECEDED BY
A CONSTANT OR KEYWORD

Explanation: A delimiter was found where either a subparameter list or data was expected.

The delimiter is improperly used because either parentheses were improperly positioned, or a positional parameter was missing.

System Action: The command ends. ICKDSF continues with the next command.

Operator Response: None.

System Programmer Response: Correct the syntax error, and issue the command again. Save the output and contact your IBM service representative.

ICK30207I REMAINDER OF COMMAND INPUT STREAM IGNORED

Explanation: An error has occurred that prohibits further scanning of the command stream. Messages issued just prior to this message indicate the nature of the error.

Note: Condition code (MAXCC) is always set to 16 when this situation is encountered.

System Action: ICKDSF processing ends.

Operator Response: None.

System Programmer Response: Correct the error, and issue the command again. Save the output and contact your IBM service representative.

ICK30208I LEFT PARENTHESIS MISSING FOLLOWING KEYWORD
xxxx

Explanation: The keyword xxxx is not followed by the opening parenthesis. This character must begin the required subparameter list or value associated with the command keyword.

System Action: The command ends. ICKDSF continues with the next command.

Operator Response: None.

System Programmer Response: Check the requirements of the keyword, correct the syntax, and issue the command again. Save the output and contact your IBM service representative.

ICK30209I RIGHT PARENTHESIS MISSING AFTER xxxx

Explanation: A closing parenthesis was not found where expected. A subparameter list was possibly not properly delimited.

System Action: The command ends. ICKDSF continues with the next command.

Operator Response: None.

System Programmer Response: Correct the command syntax, and issue the command again. Save the output and contact your IBM service representative.

ICK30210I INVALID PARENTHESES FOR SPECIFYING
REPEATED SUBPARAMETER LIST

Explanation: Parentheses that delimit repeated subparameter lists are either missing or not matched.

System Action: The command ends. ICKDSF continues with the next command.

Operator Response: None.

System Programmer Response: Correct the command syntax, and reissue the command. Save the output and contact

Messages received at the output printer

your IBM service representative.

ICK30211I KEYWORD xxxx IS IMPROPER

Explanation: The command contains a misspelled, improperly specified, or inapplicable keyword.

System Action: The command ends. ICKDSF continues with the next command.

Operator Response: None.

System Programmer Response: Correct the command syntax, and issue the command again. Save the output and contact your IBM service representative.

ICK30212I INVALID LEFT PARENTHESIS AFTER xxxx

Explanation: There is an opening parenthesis which appears to delimit the positional parameter xxxx, but the positional parameter specified is not a constant or a list of constants.

System Action: The command ends. ICKDSF continues with the next command.

Operator Response: None.

System Programmer Response: Correct the command syntax, and issue the command again. Save the output and contact your IBM service representative.

ICK30213I KEYWORD xxxx APPEARS TOO OFTEN

Explanation: The keyword xxxx appears too often in the command. A parameter list may be incorrectly specified.

System Action: The command ends. ICKDSF continues with the next command.

Operator Response: None.

System Programmer Response: Correct the command syntax by removing the keyword, and issue the command again. Save the output and contact your IBM service representative.

ICK30214I HEX OR BINARY CONSTANT SPECIFIED IMPROPERLY

Explanation: A hexadecimal or binary constant is not specified in the correct format: *n* or B"*n*", respectively.

System Action: The command ends. ICKDSF continues with the next command.

Operator Response: None.

System Programmer Response: Correct the command syntax, and issue the command again. Save the output and contact your IBM service representative.

ICK30216I ABOVE TEXT BYPASSED UNTIL NEXT COMMAND

Explanation: Syntax checking of this command found an error. Syntax checking ended. Messages issued just prior to this message indicate the nature of the error.

System Action: The command ends. ICKDSF continues with the next command.

Operator Response: None.

System Programmer Response: Correct the command syntax, and issue the command again. Save the output and contact your IBM service representative.

ICK30217I PASSWORD IMPROPER AFTER xxxx

Explanation: A password, denoted by a slash (/), was encountered where a password is not allowed.

System Action: The command ends. ICKDSF continues with the next command.

Operator Response: None.

System Programmer Response: Remove the password from the parameter, and issue the command again. Save the output and contact your IBM service representative.

ICK30218I TOO MANY REPEATED SUBPARAMETER LISTS APPEAR

Explanation: More repeated subparameter lists are specified than are allowed for this command.

System Action: The command ends. ICKDSF continues with the next command.

Operator Response: None.

System Programmer Response: Check the command syntax, correct the error, then issue the command again. Save the output and contact your IBM service representative.

ICK30219I VERB NAME xxxx UNKNOWN

Explanation: The verb xxxx is not recognized as a command.

System Action: The command ends. ICKDSF continues with the next command.

Operator Response: None.

System Programmer Response: Reissue the command with the correct command name. Save the output and contact your IBM service representative.

ICK30220I IMPROPER NUMERIC DIGIT FOUND IN xxxx

Explanation: The constant xxxx contains a character that is not valid:

- A decimal number can only be specified with the symbols 0 through 9;
- hexadecimal number can only be specified with the symbols 0 through 9 and A through F;
- A binary number can only be specified with the symbols 0 and 1.

System Action: The command ends. ICKDSF continues with the next command.

Operator Response: None.

System Programmer Response: Correct the command syntax error, and issue the command again. Save the output and contact your IBM service representative.

Messages received at the output printer

ICK30221I CONSTANT xxxx NOT WITHIN VALUE RANGE

Explanation: The value of the constant xxxx is outside the range of values allowed for the associated parameter.

System Action: The command ends. ICKDSF continues with the next command.

Operator Response: None.

System Programmer Response: Check the command syntax for allowed values, correct the error, then issue the command again. Save the output and contact your IBM service representative.

ICK30223I TOO MANY CONSTANTS IN LIST BEGINNING AT
xxxx

Explanation: The command contains too many specified constants beginning at the characters xxxx.

System Action: The command ends. ICKDSF continues with the next command.

Operator Response: None.

System Programmer Response: Correct the command syntax, and issue the command again. Save the output and contact your IBM service representative.

ICK30225I REQUIRED (SUB)PARAMETER OF xxxx IS MISSING

Explanation: A required parameter or subparameter, identified by xxxx, is missing.

System Action: The command ends. ICKDSF continues with the next command.

Operator Response: None.

System Programmer Response: Add the missing parameter, and issue the command again. Save the output and contact your IBM service representative.

ICK30226I INCONSISTENT PARAMETERS INVOLVING xxxx

Explanation: Some commands contain parameters that are defined as mutually exclusive. (If one parameter is specified, the other parameter is not allowed.)

System Action: The command ends. ICKDSF continues with the next command.

Operator Response: None.

System Programmer Response: Correct the command syntax, and issue the command again. Save the output and contact your IBM service representative.

ICK30234I TOO FEW RIGHT PARENTHESES FOUND AT END OF
COMMAND

Explanation: The command contains too few specified closing parentheses at the end to properly close the subparameter lists.

System Action: Command processing ends.

Operator Response: None.

System Programmer Response: Correct the command

syntax. Save the output and contact your IBM service representative.

ICK30300I ERROR OPENING {dsname|ddname}

Explanation: An error occurred when attempting to open the indicated data set or volume. See the associated message for the cause of the error.

System Action: See the associated message.

Operator Response: None.

System Programmer Response: See the associated message. Save the job output and contact your IBM service representative.

ICK30301I ERROR CLOSING dsname

Explanation: An error was encountered while attempting to close the data set. See the associated message for the cause of the error.

System Action: See the associated message.

Operator Response: None.

System Programmer Response: See the associated message. Save the job output and contact your IBM service representative.

ICK30302I ACTION ERROR ON dsname

Explanation: This informational message identifies the name of the data set that was processing when the error occurred. See the associated message for an explanation of the error.

System Action: None.

Operator Response: None.

System Programmer Response: None. Save the job output and contact your IBM service representative.

ICK30304I **JCL STATEMENT MISSING

Explanation: The DD statement that was identified in the DDNAME parameter is missing.

System Action: The command ends. ICKDSF continues with the next command.

Operator Response: None.

System Programmer Response: Ensure that the DD statement is in the job stream as specified in the command. Check the DDNAME for correct spelling. Save the job output and contact your IBM service representative.

ICK30309I **RECORD xxxxx NOT WRITTEN. LENGTH
INVALID

Explanation: The record xxxxx was not written for one of the following reasons:

- The record length was greater than LRECL of the output data set.
- The record length was less than the LRECL of the output data set and RECFM was F (fixed).

Messages received at the output printer

Note: xxxxx is the first five bytes of the record in hexadecimal format.

System Action: ICKDSF continues processing until four such errors occur. After four errors, the command continues to run, but no further records are written to the output data set.

Operator Response: None.

System Programmer Response: Redefine the data set with the correct LRECL value. Save the job output and contact your IBM service representative.

ICK30312I **SYSTEM UNABLE TO OPEN

Explanation: The DCBOFLG was not set ON following an OPEN SVC (MVS), or the OPEN system macro failed (VSE). See the associated messages for the cause of the error.

System Action: The command ends. ICKDSF continues with the next command.

Operator Response: None.

System Programmer Response: Save the job output and contact your IBM service representative.

ICK30313I **synad.text

Explanation: An I/O error occurred. The contents of the MVS Data Management Services SYNADAF error message are written.

System Action: The command ends. ICKDSF continues with the next command.

Operator Response: None.

System Programmer Response: Check the explanation of the SYNADAF message. Correct the error, and issue the command again. Save the job output and contact your IBM service representative.

ICK30315I **RECORD SIZE GREATER THAN 32767 NOT SUPPORTED

Explanation: The system cannot process a logical record whose size is greater than 32,767 bytes.

System Action: The command ends.

ICKDSF continues with the next command.

Operator Response: None.

System Programmer Response: Change the DD statement to specify a LRECL length that is less than 32,767 bytes. Save the job output and contact your IBM service representative.

ICK30317I **PERMANENT I/O ERROR

Explanation: An error was detected while performing an I/O operation. The data set name is given in the associated message.

System Action: The command ends. ICKDSF continues with the next command.

Operator Response: None.

System Programmer Response: Check the MVS JCL statements to be sure the data set was correctly defined.

If the data set was correctly defined, there is a hardware error. The data set must be created again on another I/O device. Save the job output and contact your IBM service representative.

ICK30318I **INVALID DATA SET SPECIFICATION

Explanation: In the VSE version, the I/O adapter open/close routine was unable to open a data set because the DLBL statement contained a data set specification that was not valid.

System Action: Processing for the specific data set ends. Command processing will continue if opening the specific data set is not critical to the main function performed by the command.

Operator Response: None.

System Programmer Response: Check the DLBL statement for a probable user error. If there are no errors, save the job output and contact your IBM Service Representative.

ICK30320I **INVALID DEVICE TYPE

Explanation: In the VSE version, the I/O adapter open/close routine was unable to open a data set, because it exists on a device that is not supported for sequential processing.

System Action: Processing for the specific data set ends. Command processing will continue if opening the specific data set is not critical to the main function performed by the command.

Operator Response: None.

System Programmer Response: Probable user error. The data set does not exist on a valid device that is supported for sequential processing (SAM access method). Correct the error and submit the job again.

If the error persists, save the job output and contact your IBM Service Representative.

ICK30321I **OPEN/CLOSE ABEND EXIT TAKEN

Explanation: The OPEN/CLOSE system services SVC detected an error while either opening or closing a data set. The abend message was written to the JOBJCL data set.

System Action: The command ends. ICKDSF continues with the next command.

Operator Response: None.

System Programmer Response: Check the abend message, correct the error, then issue the command again. Save the job output and contact your IBM service representative.

ICK30330I DATA SET xxxxxxxx IS TOO SHORT FOR THE SPECIFIED FUNCTION

Explanation: The specified data set is not large enough to accommodate the data fields specified in the CCW chain.

System Action: Command processing ends.

Operator Response: None.

System Programmer Response: Reallocate the data set and submit the job again.

Messages received at the output printer

ICK30332I UNABLE TO PROCESS DATA SET RC=xx

Explanation: The CP macro FSSTATE was issued with RC=xx.

Code Meaning

20	Character in fileid not valid
24	File mode not valid
28	File not found
36	Disk not accessed
80	I/O error accessing OS data set
81	OS read password protected data set
82	OS data set organization is not BSAM, QSAM, or BPAM
83	OS data set has more than 16 extents

System Action: The command ends with condition code 12

Operator Response: None.

System Programmer Response: Correct the error and run the job again.

ICK30334I {record length|format} OF DATA SET fn ft fm IS INCORRECT

Explanation: The record length must be = 80, the record format must be fixed block.

System Action: Process ends.

Operator Response: None.

System Programmer Response: Correct the data set and run the job again.

ICK30335I DATA SET ON READ ONLY DISK

Explanation: The specified file is on a read only disk.

System Action: Command processing ends.

Operator Response: None.

System Programmer Response: Correct the data set and run the job again.

ICK30336I TIC ADDRESS OUTSIDE CCW AREA OF FILE

Explanation: A TIC ccw with an address outside the ccw area of the file been found.

System Action: Command processing ends.

Operator Response: None.

System Programmer Response: Correct the data set and run the job again.

ICK30337I CCW ENDING INDICATOR NOT FOUND

Explanation: A double word of X'FFFFFFFFFFFFFFFF' was not found in the file.

System Action: Command processing ends.

Operator Response: None.

System Programmer Response: Correct the data set and run the job again.

ICK30500I MAIN STORAGE NOT AVAILABLE, COMMAND TERMINATED

Explanation: Dynamic acquisition of storage for control blocks and work areas failed.

System Action: The command ends.

Operator Response: Increase main storage size, and submit the job again. Save the job output and contact your IBM service representative.

ICK30700I EQUIPMENT CHECK

System Action: Drive test processing ends if path control is not being used. If path control is being used, drive test processing ends on the current path and ICKDSF continues with the next available path specified.

ICK30701I EQUIPMENT CHECK ON ccuu

Explanation: An EQUIPMENT CHECK I/O error occurred.

System Action: If you do not receive message ICK00701I EQUIPMENT CHECK RETRY SUCCESSFUL, command processing ends.

Operator Response: None.

System Programmer Response: Examine the failing CCW, CSW, and sense information to determine the cause of the equipment check.

Assistance of the IBM hardware service representative is required to interpret the sense information and to aid in correcting the cause of the error. Save the job output and contact your IBM hardware service representative.

ICK30702I OPERATOR DID NOT READY DEVICE

Explanation: When prompted by message ICK004D to make a device ready, operator requested that command processing end.

System Action: The command ends. ICKDSF continues with the next command.

Operator Response: None.

System Programmer Response: None. Save the job output and contact your IBM service representative.

ICK30703I DEVICE ALREADY IN USE

Explanation: The device referred to in the ICKDSF command by the UNITADDRESS or DDNAME parameter is already being used by another job.

System Action: The command ends. ICKDSF continues with the next command.

Operator Response: None.

System Programmer Response: Determine what job is using the device, and when the job completes resubmit your job.

Messages received at the output printer

ICK30704I INVALID DEVICE-TYPE FOR FUNCTION

Explanation: The type of device specified is not valid for the command issued.

System Action: The command ends. ICKDSF continues with the next command.

Operator Response: None.

System Programmer Response: Issue the command again specifying an appropriate device. Save the job output and contact your IBM service representative.

ICK30705I OPERATOR DID NOT SET DEVICE TO WRITE-MODE

Explanation: I/O operations found the device set for read-only mode.

Operator elected to end command processing in response to message ICK014D instead of setting the device to write mode.

System Action: Command processing ends.

Operator Response: None.

System Programmer Response: Ensure that the device is in write mode, and submit the command again. Save the job output and contact your IBM service representative.

ICK30706I DEVICETYPE PARAMETER MISSING OR ERRONEOUS

Explanation: This message appears only in the Stand-Alone version.

The DEVICETYPE parameter must specify one of the valid device types. See Table 13 on page 8 for valid device types.

System Action: The command ends. ICKDSF continues with the next command.

Operator Response: None.

System Programmer Response: Correct the error, and issue the command again. Save the job output and contact your IBM service representative.

ICK30707I MIMIC MINI/EMU SPECIFICATION ERRONEOUS

Explanation: The number of cylinders specified, either for an MVS minidisk for the VM environment or for an emulated count-key-data device on a fixed block architecture device, is greater than the total number of primary cylinders that exist on the volume.

System Action: The command ends and ICKDSF continues processing with the next command.

Operator Response: None.

System Programmer Response: Correct the number of cylinders that is not valid in the MINI or EMU specification, and resubmit the job.

ICK30708I DEVICETYPE PARAMETER REQUIRED WITH MIMIC MINI/EMU SPECIFICATION.

Explanation: When you specify the MIMIC MINI parameter, you must also specify the DEVICETYPE parameter.

System Action: The command ends and ICKDSF continues processing with the next command.

Operator Response: None.

System Programmer Response: Correct the command syntax, and resubmit the job.

ICK30709I ACCESS DENIED TO SHARED DEVICE cccu BY OPERATOR

Explanation: If the operator replies T to message ICK020D, this message appears before the command ends.

System Action: The command ends, and ICKDSF continues processing with the next command.

Operator Response: None.

System Programmer Response: When the volume is accessible, submit the job again.

ICK30710I SUBSID SUPPORT NOT AVAILABLE ON SYSTEM

Explanation: The level of the VSE system where ICKDSF is running does not have the support required to run ICKDSF.

System Action: Command processing ends.

Operator Response: None.

System Programmer Response: See explanation.

ICK30711I CHANNEL ERROR: CSW=xxxxxx xxxxxxxx

Explanation: An unrecoverable channel error occurred. xx . . . xx is a hexadecimal display of the last seven bytes of the CSW at the time of the error.

System Action: The command ends. ICKDSF continues processing with the next command.

Operator Response: None.

System Programmer Response: Save the job output and contact your IBM hardware service representative

ICK30712I cccu DEVICE TYPE VERIFICATION FAILED

Explanation: During OPEN, either ICKDSF was unable to determine the device type at address xxx, or the device type is not supported.

If the sense ID CCW X'E4' is supported by the device at address xxx, then the following message is issued:

PHYSICAL DEVICE=UNKNOWN
SENSE ID=xxxxxxxxxxxx

See the appropriate device manual for the sense ID information. Basically, the format is as follows:

byte 0 = X'FF'
bytes 1-3 = storage control id
bytes 4-6 = device id

If the sense ID CCW is not supported by the device, the following message is issued:

PHYSICAL DEVICE=UNKNOWN
LOGICAL DEVICE=UNKNOWN

System Action: Command processing ends.

Messages received at the output printer

Operator Response: None.

System Programmer Response: The Introduction lists the direct access devices supported by ICKDSF.

Ensure that the device specified by the UNITADDRESS, DDNAME, or SYSNAME parameter is supported by ICKDSF. If the device is supported by ICKDSF, save the output and contact your IBM service representative.

ICK30713I UNABLE TO ALLOCATE UCB, RC=xxxx, RSN=xxxx

Explanation: An error occurred while trying to allocate the UCB. The RC and RSN are the return and reason code from the MVS service that was invoked to allocate the UCB.

System Action: ICKDSF terminates.

Operator Response: Contact the system programmer.

System Programmer Response: Determine the reason for the inability to allocate the UCB.

ICK30714I DDNAME NOT FOUND IN JCL

Explanation: The ddname specified on the DDNAME parameter of input command could not be found for this job step.

System Action: The command ends. ICKDSF continues with the next command.

Operator Response: None.

System Programmer Response: To include the ddname specified in the command, add a DD card to the JCL for the job step. Save the output and contact your IBM service representative.

ICK30715I DEVICE IS IN TRANSITION MODE

Explanation: The device is in transition state between 3390 mode and 3380 track compatibility mode. This can occur because a previous INSTALL command did not complete.

System Action: Command processing ends.

Operator Response: None.

System Programmer Response: Run the INSTALL command to complete the mode change before running any other commands.

ICK30716I DEVICE IS IN MEDIA MAINTENANCE RESERVE STATE

Explanation: The device is in media maintenance reserve state because a previous INSPECT PRESERVE did not complete.

System Action: Command processing ends.

Operator Response: None.

System Programmer Response: Run the INSPECT PRESERVE command to a track other than the failing track, so that the media maintenance reserve may be released.

ICK30717I UNRECOGNIZED I/O ERROR TYPE

Explanation: An I/O error has occurred, however the error cannot be recognized for the specified device type.

System Action: ICKDSF has performed a retry, but the error still persists. A system or hardware error is suspected.

System Programmer Response: Examine the failing CCW,CSW and sense information. Assistance of the IBM service representative may be required to interpret the sense information and to aid in correcting the cause of the error.

ICK30718I FUNCTION NOT SUPPORTED FOR NONSYNCHRONOUS DASD

Explanation: The specified function cannot be performed because the device is attached to a nonsynchronous storage subsystem, which does not support 3380 track compatibility mode.

System Action: The command ends.

Operator Response: None.

System Programmer Response: The specified function can only be performed on either a parallel channel interface or a nonsynchronous storage subsystem that supports 3380 track compatibility mode.

ICK30719I DEVICE IS IN THE "STATUS CAN NOT BE DETERMINED" STATE

Explanation: The device is in a *status can not be determined state*. The CONTROL command with the RESETICD parameter must be run to reset this condition before any other commands are issued.

System Action: The current command ends.

System Programmer Response: Contact your IBM service representative and run CONTROL RESETICD.

ICK30721I UNABLE TO DETERMINE PATH STATUS

Explanation: The path status could not be determined.

System Action: Command processing ends.

Operator Response: None.

System Programmer Response: Examine the previous messages to identify the reason the path status could not be determined.

ICK30722I FUNCTION NOT ALLOWED ON XRC VOLUME

Explanation: The device indicates that XRC is active on this volume. The specified function is not allowed when XRC is active.

System Action: The command ends. ICKDSF continues with the next command.

Operator Response: None.

System Programmer Response: The volume must be removed from the XRC session before running this function. See *z/OS DFSMS Advanced Copy Services, Controlling ICKDSF activity to XRC volumes* section for more information.

Messages received at the output printer

ICK30726I STIMERM FUNCTION CANNOT BE PERFORMED
RETURN CODE = xxxxxxxx

Explanation: The system STIMERM function could not be performed.

System Action: Command processing ends. The return code from the STIMERM function is printed in hexadecimal.

Operator Response: None.

System Programmer Response: Contact your IBM service representative to assist in determining the reason the function could not be performed.

ICK30730I UNSUPPORTED DEVICE TYPE

Explanation: The device type as described in message ICK00700I is not a supported device for this release of ICKDSF.

System Action: The function ends.

Operator Response: None.

System Programmer Response: None.

ICK30731I X'xxxxx' CYLINDER SIZE EXCEEDS MAXIMUM
SIZE SUPPORTED

Explanation: The device exceeds the maximum cylinder size that ICKDSF supports. X'xxxxx' contains the cylinder size to which the device is configured.

System Action: Command processing continues.

Operator Response: None.

System Programmer Response: Redefine the device to a supported size, and issue the command again. Assistance from your IBM hardware service representative may be required to redefine the device to a supported size.

ICK30800I DEVICE IS EITHER SPARE VOLUME OR BROKEN
SPARE VOLUME

Explanation: The device is either in spare volume status or in broken spare volume status. The data on the device is not accessible.

System Action: Command processing ends.

Operator Response: None.

System Programmer Response: If you want to keep the volume in spare status, then correct the device address and reissue the command. If you do not want to keep this volume as spare volume, contact your IBM service representative to change the volume status.

ICK31004I VTOC CREATION FAILED

Explanation: An I/O error occurred when attempting to write a volume table of contents on the volume.

System Action: The volume table of contents is not written on the volume, and the command ends. ICKDSF continues with the next command.

Operator Response: None.

System Programmer Response: Save the job output and

contact your IBM service representative.

ICK31005I INDEX IS REQUIRED WHEN STORAGEGROUP IS
SPECIFIED FOR THIS DEVICE TYPE

Explanation: User is probably running ICKDSF on a device which does not support the default index (see Table 13 on page 8). In this case, the INDEX parameter must be explicitly specified when the STORAGEGROUP parameter is specified.

System Action: The command ends with return code 12. ICKDSF continues with the next command.

Operator Response: None.

System Programmer Response: Ensure INDEX parameter is specified when STORAGEGROUP parameter is specified.

ICK31006I VOLUME LABEL CREATION FAILED

Explanation: An I/O error occurred while attempting to write a volume label.

System Action: A volume label was not written, and the command ends. ICKDSF continues with the next command.

Operator Response: None.

System Programmer Response: Examine the CCW, CSW, and sense information to aid in determining the cause of the failure. Also:

- During minimal initialization, writing the volume label is the first write operation that occurs on the volume. This message can be an indication that the volume is in read only mode.
- The error may be caused by a data check. Run INSPECT of cylinder 0, track 0 to correct the error.

Other failure conditions may require the aid of the IBM service representative. If so, save the job output and contact your IBM service representative.

ICK31007I ALLTRACKS NOT SUPPORTED FOR THIS FUNCTION

Explanation: The ALLTRACKS parameter is only valid for NOCHECK NOASSIGN processing.

System Action: The command ends. ICKDSF continues with the next command.

Operator Response: None.

System Programmer Response: Limit the amount of track specified by using the range parameters.

ICK31011I NON-STANDARD VOL1 RECORD DETECTED

Explanation: The VOL1 record which contains the volume label you are attempting to change is not a standard 80-character VOL1 record.

System Action: The command ends. ICKDSF continues with the next command.

Operator Response: None.

System Programmer Response: Use the AIXVOL command to change the volume label.

Messages received at the output printer

ICK31012I **VOLID NOT SPECIFIED AND NO VOLUME LABEL EXISTS**

Explanation: The volume being initialized does not contain a volume label, and no volume label was provided.

System Action: The command ends. ICKDSF continues with the next command.

Operator Response: None.

System Programmer Response: Ensure the correct volume is mounted. Specify the VOLID parameter and reissue the command. Save the job output and contact your IBM service representative.

ICK31013I **UNRECOVERABLE TRACK THRESHOLD MET**

Explanation: Multiple failures have occurred while writing the home address/record 0 on multiple tracks. This message follows many ICK21000 and/or ICK21001 messages.

System Action: The command ends.

Operator Response: None.

System Programmer Response: Examine prior messages (including the CCW, CSW, and sense that caused the I/O) to determine the cause of the failure.

This message may be issued if either the read/write mode switch is set to READ mode, or some other condition prevents ICKDSF from writing on the volume.

ICK21000 messages issued for the first 10 successive alternate tracks on the volume characterizes the inability to write on the volume.

If running under VM (either Stand-Alone or an operating system version running under VM), this message can indicate that a diagnostic or media maintenance function was attempted against a device that was a minidisk or LINK to the userid.

Diagnostic and media maintenance functions must be done on dedicated devices. For more information on VM support, see Chapter 8, "ICKDSF versions supported as guests under VM," on page 67.

Assistance may be required from the IBM service representative.

ICK31015I **UNABLE TO READ VOLUME LABEL**

Explanation: An I/O error occurred while attempting to read the volume label to verify the volume serial number.

System Action: The command ends. ICKDSF continues with the next command.

Operator Response: None.

System Programmer Response: Either issue the command again specifying the NOVERIFY parameter, or reinitialize the volume. Save the job output and contact your IBM service representative.

ICK31016I **LABEL NOT SUPPORTED FOR CMS FORMATTED VOLUMES**

Explanation: The LABEL parameter was specified, but the volume is CMS formatted, not CP formatted.

System Action: The command ends. ICKDSF continues with the next command.

Operator Response: None.

System Programmer Response: Use the appropriate CMS command to change the volume label.

ICK31017I **VOLID PARAMETER INVALID FOR UNINITIALIZED VOLUME**

Explanation: The VOLID parameter is only valid for initialized volumes.

System Action: Command processing ends.

Operator Response: None.

System Programmer Response: Initialize the volume.

ICK31019I **NEXT-AVAILABLE-ALTERNATE POINTER OR COUNTER IN VTOC IS INVALID**

Explanation: There is an error in either the value of the pointer to the next available alternate track or the count of the number of alternate tracks that are available.

System Action: Command processing continues. If possible, the value in the VTOC is updated when processing completes.

Operator Response: None.

System Programmer Response: Reinitialize the volume at either the minimal or the maximal level. Save the job output and contact your IBM service representative.

ICK31022I **UNABLE TO CHANGE VOLUME LABEL**

Explanation: An I/O error occurred while attempting to change the volume serial number, the owner identification, or the address of the volume table of contents in the volume label.

System Action: The command ends. ICKDSF continues with the next command.

Operator Response: None.

System Programmer Response: Reinitialize the volume. Save the job output and contact your IBM service representative.

ICK31023I **INVALID UNITADDRESS, SYSNAME OR DDNAME SPECIFIED**

Explanation: Either the channel and unit addresses specified do not exist in the system I/O configuration, or the DDNAME is incorrect, or the SYSNAME is incorrect. This message may be issued if an alias of a parallel access volume is specified when running offline in an MVS environment.

System Action: The command ends. ICKDSF continues with the next command.

Operator Response: None.

Messages received at the output printer

System Programmer Response: Correct the value substituted for *ccuu*, or for *dname*, or for *sysxxx*, then issue the command again. For Parallel Access Volumes, specify the base volume of the Parallel Access Volume. Save the job output and contact your IBM service representative.

ICK31024I UNABLE TO OPEN VOLUME

Explanation: The volume that was specified cannot be opened for several possible reasons:

- The DD statement is missing or not valid.
- The channel/unit address is not valid.
- When processing in a shared environment, the device is not in an offline status on the system processing ICKDSF.
- There are I/O errors associated with the volume.

System Action: The command ends. ICKDSF continues with the next command.

Operator Response: None.

System Programmer Response: Determine the status of the volume by examining previous messages. Save the job output and contact your IBM service representative.

ICK31025I VOLUME NOT MOUNTED PRIVATE

Explanation: When online initializing, inspecting, or reformatting is requested, the specified volume must be mounted PRIVATE to prevent interference by other jobs.

System Action: The command ends. ICKDSF continues with the next command.

Operator Response: None.

System Programmer Response: Either ensure the volume is mounted PRIVATE, or perform the job offline. Save the job output and contact your IBM service representative.

ICK31026I COMMAND INVALID FOR UNINITIALIZED VOLUME

Explanation: The REFORMAT command can only be specified for a previously initialized volume.

System Action: The command ends. ICKDSF continues with the next command.

Operator Response: None.

System Programmer Response: Initialize the volume. Save the job output and contact your IBM service representative.

ICK31027I UNABLE TO WRITE VOLUME LABEL DURING VTOC CREATION

Explanation: An I/O error occurred while attempting to rewrite the volume label field that locates the volume table of contents.

System Action: The command ends. ICKDSF continues with the next command.

Operator Response: None.

System Programmer Response: Save the job output and contact your IBM service representative.

ICK31028I INVALID VSE DATA SET NAME

Explanation: The DSname is limited to seven characters.

System Action: Command processing ends.

Operator Response: None.

System Programmer Response: Correct the data set and run the job again.

ICK31029I VTOCPTR SPECIFIED AND VOLUME LABEL EXISTS

Explanation: VTOCPTR restores destroyed *volser* information of a previously initialized volume. VTOCPTR cannot be used if the volume label exists.

System Action: Command processing ends.

Operator Response: None.

System Programmer Response: None.

ICK31030I VALID VTOC DOES NOT EXIST AT THE SPECIFIED LOCATION

Explanation: The format-4 DSCB cannot be found at the specified VTOC location.

System Action: Command processing ends.

Operator Response: None.

System Programmer Response: Issue the REFORMAT command again specifying the correct VTOC location.

ICK31034I "ASSIGN NOCHECK" PROHIBITED WITH RANGE PARAMETERS

Explanation: The combination of ASSIGN and NOCHECK indicates the user has determined that an alternate track or block is necessary. The determination is independent of the surface analysis processes performed by ICKDSF.

If used with range parameters, this combination of parameters can easily exhaust the alternate tracks or blocks on a volume, because unconditional alternate assignment takes place.

System Action: Command processing ends.

System Programmer Response: To unconditionally assign alternate tracks or blocks, use ASSIGN and NOCHECK with the TRACKS or BLOCKS parameter.

ICK31035I UNABLE TO READ FORMAT-4 DSCB

Explanation: An I/O error occurred while attempting to read the data set control block (DSCB) for the volume table of contents. This record is read, then rewritten, to indicate the location.

System Action: The command ends. ICKDSF continues with the next command.

Operator Response: None.

System Programmer Response: Reinitialize the volume. Save the job output and contact your IBM service representative.

Messages received at the output printer

ICK31036I UNABLE TO INITIALIZE 2314 MINI DISC

Explanation: Initialization of less than 2 cylinders was requested for the 2314 minidisk specification. This is not acceptable because one cylinder is always used as a cylinder of alternate tracks.

System Action: The command ends. ICKDSF continues with the next command.

Operator Response: None.

System Programmer Response: Correct the MIMIC(MINI(n)) parameter, then reissue the command.

ICK31043I NO STORAGE AVAILABLE TO HOLD RECORD BEING PRESERVED, TRACK CCHH=X'cccc hhhh'

Explanation: During surface checking, the contents of a track are preserved by reading the complete track into a dynamically allocated buffer according to the track capacity of the volume. There is insufficient space for allocating this buffer.

System Action: The track under inspection is not surface checked to avoid loss of data, and the command ends. ICKDSF continues with the next command.

Operator Response: None.

System Programmer Response: Either increase the system storage space, or specify the NOPRESERVE parameter if the data may be destroyed. Then issue the command again. Save the job output and contact your IBM service representative.

ICK31046I UNABLE TO WRITE FORMAT-4 DSCB AT CCHH=X'cccc hhhh'

Explanation: An I/O error occurred while attempting to update the volume table of contents. The address of the first available alternate track and the number of alternate tracks could not be written in the VTOC.

System Action: The command ends. ICKDSF continues with the next command.

Operator Response: None.

System Programmer Response: Either reinitialize the volume specifying a different cylinder and track location for the volume table of contents, or issue the INSPECT command to assign an alternate track. Save the job output and contact your IBM service representative.

ICK31048I VOLSER CHANGE NOT ALLOWED FOR ONLINE VOLUMES

Explanation: Changing the volser is not allowed for *online* volumes. The volser can be changed only on *offline* volumes.

System Action: Command processing ends.

Operator Response: None.

System Programmer Response: Vary the volume *offline* and run the command again with the VOLID parameter.

ICK31049I UNITADDRESS SPECIFIED FOR ONLINE VOLUME

Explanation: The UNITADDRESS parameter is valid for offline processing only, but this device is online.

System Action: Command processing ends.

Operator Response: None.

System Programmer Response: Either vary the volume offline, or specify the DDNAME parameter.

ICK31050I UNABLE TO ENSURE DATA AVAILABILITY -- FUNCTION TERMINATED

Explanation: You specified the AVAILABLE parameter for the INSPECT command. However, the device does not support the *concurrent media maintenance* function and ICKDSF cannot ensure the availability of the user data during the INSPECT process.

System Action: Command processing ends.

Operator Response: None.

System Programmer Response: Remove the AVAILABLE parameter and issue the command again.

ICK31052I MINIMAL INITIALIZATION NOT PERMITTED FOR MSS STAGING PACK

Explanation: Mass Storage System staging packs are not supported.

System Action: The command ends. ICKDSF continues with the next command.

Operator Response: None.

System Programmer Response: None.

ICK31053I DIRECTIO(SECONDARY) IS SPECIFIED TO THE VOLUME IN DUPLEX STATE

Explanation: You specified the INSPECT DIRECTIO(SECONDARY) function to a volume that is in duplex state.

System Action: INSPECT function is not supported on the secondary device if the volume is in duplex state.

Operator Response: None.

System Programmer Response: Place the volume in suspended failed duplex state prior to invoking INSPECT.

ICK31054I DEVICE NOT SUPPORTED FOR THE SPECIFIED FUNCTION

Explanation: The volume specified for the command is not supported for the function defined by the combination of parameters used.

For example, ANALYZE is not valid for a 9332 device. See Table 13 on page 8 for other incompatible functions.

System Action: Command processing ends.

Operator Response: None.

System Programmer Response: Correct the control statement, and issue the command again.

Messages received at the output printer

ICK31055I CONCURRENT MEDIA MAINTENANCE FUNCTION
REQUIRED FOR DUAL COPY VOLUMES

Explanation: In order to process a volume that is part of a dual copy pair, the INSPECT command requires the *concurrent media maintenance* function on this storage control.

System Action: Command processing ends.

Operator Response: None.

System Programmer Response: Contact your IBM hardware service representative. In the interim, reset the dual copy pair to simplex state and run the INSPECT command on the volume in simplex state.

ICK31056I VTOC LOCATION IN VOLUME LABEL INCORRECT

Explanation: The VTOC location specified in the standard volume label is incorrect. Therefore, addressability to the volume table of contents is lost.

System Action: The command ends. Command processing continues with the next command.

Operator Response: None.

System Programmer Response: Reinitialize the volume, and reestablish addressability to the volume table of contents.

ICK31057I INVALID DEVICE TYPE: VTOC INDEX NOT
SUPPORTED ON THIS DEVICE

Explanation: The device type is not valid for initialization with a VTOC index.

System Action: The creation of the VTOC index is not attempted. INIT command ICKDSF continues.

Operator Response: None.

System Programmer Response: None.

ICK31058I cccu I/O ERROR DETECTED DURING INDEX
CREATION: ERROR CODE= *

Explanation: An I/O error occurred during VTOC index creation processing. Error codes:

- 1 Error occurred in reading the volume label
- 2 Error occurred in reading the VTOC
- 3 Error occurred in writing the VTOC
- 4 Error occurred in writing index records
- 5 Index extent was violated; increase index size

System Action: VTOC index creation processing ends. The VSE volume indicator is turned on in the VTOC. INIT command processing continues.

Operator Response: Ask the system coordinator to analyze the cause of the error.

System Programmer Response: None. Save the output and contact your IBM service representative.

ICK31059I INDEX STARTING LOCATION INVALID AS
SPECIFIED

Explanation: The INDEX parameter, or starting location, on the INIT command statement is not valid for one of the following reasons:

- It caused an overlap with the VTOC.
- It defined cylinder 0, track 0 as the starting location of the index data set.
- It was outside the physical limits of the device.
- The relative track specified is not valid for the device.

System Action: Command processing ends.

Operator Response: None.

System Programmer Response: Check the values specified for the INDEX parameter, and correct the value in error. Submit the job again.

ICK31060I INDEX EXTENT EXCEEDED THE MAXIMUM VALUE
ALLOWED

Explanation: The specified INDEX extent has exceeded the maximum extent allowed.

System Action: Command processing ends.

Operator Response: None.

System Programmer Response: Modify the size of the INDEX extent and reissue the command.

ICK31061I cccu VTOC INDEX CREATION SUCCESSFUL:
VOLUME IS IN INDEX FORMAT

Explanation: The VTOC index was successfully created on the volume.

System Action: None.

Operator Response: None.

System Programmer Response: None.

ICK31062I cccu VTOC INDEX CREATION FAILED: RETURN
CODE= 12

Explanation: Index creation was unsuccessful.

System Action: None.

Operator Response: None.

System Programmer Response: Check the job output for additional information on the reason for job failure.

ICK31063I UNABLE TO READ HOME ADDRESS BEFORE DATA
SAVED FROM CCHH=X'cccc hhhh'

Explanation: Before the data on a track is read, the home address must be read from the specified track. This read operation failed.

System Action: ICKDSF continues with the next track. The return code is set to 8.

Operator Response: None.

System Programmer Response: Attempt to recover the data on the track if necessary. (This may not be possible because the home address cannot be read.) Then inspect the failing

Messages received at the output printer

track specifying NOPRESERVE in order to take all possible recovery actions.

If the volume is part of a dual copy pair, put the volume in simplex state to perform an INSPECT with NOPRESERVE.

Note: No further inspection of this track takes place; no information regarding the condition of this track is retained or included in the map when processing completes.

ICK31064I UNABLE TO READ RECORD ZERO BEFORE DATA
SAVED FROM CCHH=X'cccc hhhh'

Explanation: Before the data on a track is read, record 0 must be read from the specified track. This read operation failed.

If the sense information is all zeros, and the CSW indicates only channel end/device end/incorrect length, it could be an indication that ICKDSF processing was previously aborted while running on this track.

System Action: ICKDSF continues with the next track. The return code is set to 8.

Operator Response: None.

System Programmer Response: Attempt to recover the data on the track if necessary. (This may not be possible because record 0 cannot be read.) Then inspect the failing track specifying NO PRESERVE in order to take all possible recovery actions.

If the volume is part of a dual copy pair, put the volume in simplex state to perform an INSPECT with NOPRESERVE.

Note: No further inspection of this track takes place; no information regarding the condition of this track is retained or included in the map when processing completes.

ICK31066I PRESERVE RECOVERY FAILED DATA MAY BE LOST
FOR TRACK CCHH=X'cccc hhhh'

Explanation: This message follows message ICK21047I if the preserved data cannot be successfully written to an alternate track.

System Action: Command processing ends.

Operator Response: None.

System Programmer Response: Analyze the accompanying CCW, CSW, and sense bytes information to determine the cause of the failure.

After the failing situation has been determined and corrected, issue an INSPECT of the failing track to ensure that the track is in a proper format. Data recovery procedures may be required for the previous data on the track.

ICK31067I UNABLE TO ESTABLISH PRIMARY AND ALTERNATE
ASSOCIATION FOR TRACK CCHH =X'cccc hhhh'

Explanation: During the concurrent media maintenance process, the HA/R0 of the specified primary track cannot be written to associate it to an alternate track because of an I/O error.

System Action: Command processing ends.

Operator Response: None.

System Programmer Response: Examine the failing CCW, CSW and SENSE information to determine the cause of the error.

ICK31070I DUPLEX PAIR STATE HAS BEEN CHANGED

Explanation: The state of the duplex pair has been changed (not by ICKDSF) during the direct I/O operation.

System Action: Command processing ends.

Operator Response: None.

System Programmer Response: Save the ICKDSF output and document which primary or secondary physical volume was processing.

Investigate the cause of the state change, then take action appropriate to your installation's procedure. If you suspect equipment problems, contact your IBM service representative.

Resume the ICKDSF job.

Note: If the volume becomes suspended duplex state, the original primary and secondary volume may be swapped.

ICK31082I DEVICE TYPE OF SPECIFIED UNIT ADDRESS IS
INVALID FOR THIS COMMAND

Explanation: The specified device type is not acceptable for this command.

System Action: The command ends.

Operator Response: None.

System Programmer Response: A previous message should indicate the device type of the specified unit. Examine the description of the input command to determine the valid device types for the specified command.

ICK31096I UNABLE TO READ VOLUME LABEL - CANNOT
VERIFY VOLUME

Explanation: An INSPECT specifying verify has been requested either on a volume that does not contain a volume label, or on a volume that is online to an MVS operating system.

System Action: Because verification cannot take place without a volume label (and/or the operating system cannot function with an online volume that contains an unreadable volume label), the command ends.

Operator Response: None.

System Programmer Response: Either use the INIT command to write a volume label, then run the INSPECT command with the NOVERIFY parameter again, and/or vary the device offline.

ICK31300I VERIFICATION FAILED: VOLUME-SERIAL WRONG

Explanation: The VERIFY parameter was specified, but the specified volume serial number does not match the volume serial number found in the volume label.

Messages received at the output printer

System Action: The command ends. ICKDSF continues with the next command.

Operator Response: None.

System Programmer Response: Ensure that the correct volume is mounted. Either correct the volume serial number specified in the command, or specify the NOVERIFY parameter. Save the job output and contact your IBM service representative.

ICK31301I VERIFICATION FAILED: OWNER-ID WRONG

Explanation: The VERIFY parameter was specified, and the specified owner identification does not match the owner identification found in the volume label.

System Action: The command ends. ICKDSF continues with the next command.

Operator Response: None.

System Programmer Response: Ensure that the correct volume is mounted. Either correct the owner identification specified in the command, or specify the NOVERIFY parameter. Save the job output and contact your IBM service representative.

ICK31302I VERIFICATION FAILED: VOLUME-SERIAL EXISTS

Explanation: The VERIFY(*NONE*) parameter was specified, but a volume serial number was found in the volume label.

System Action: The command ends. ICKDSF continues with the next command.

Operator Response: None.

System Programmer Response: Ensure that the correct volume is mounted. Either specify the VERIFY parameter with the volume serial number, or specify the NOVERIFY parameter.

ICK31303I UNABLE TO VERIFY AUTHORIZATION FOR PROTECTED DATA SET

Explanation: An attempt was made to scratch a data set, but the user was not authorized to do so.

System Action: The command ends. ICKDSF continues with the next command.

Operator Response: None.

System Programmer Response: Either obtain the proper authorization, or reissue the command in the offline mode. Save the job output and contact your IBM service representative.

ICK31304I SYSTEM OPERATOR DID NOT CONFIRM DATA SET PURGING

Explanation: The operator replied T to the console message received.

System Action: The command ends. ICKDSF continues with the next command.

Operator Response: None.

System Programmer Response: Determine if the data may be purged and, if so, issue the command again and reply U to the console message. Save the job output and contact your IBM service representative.

ICK31305I UNEXPIRED OR PASSWORD PROTECTED DATA SET FOUND ON VOLUME

Explanation: The attempt to process an online volume using either INIT with NOPURGE or INSPECT with NOPRESERVE, found unexpired or password-protected data sets. These prevent initialization or inspection of the volume.

System Action: The command ends. ICKDSF continues with the next command.

Operator Response: None.

System Programmer Response: If the unexpired or password protected data sets can be purged, either issue the INIT command again with the PURGE parameter (or the INSPECT command with the PRESERVE parameter), or process the volume offline. Save the job output and contact your IBM service representative.

ICK31307I CORRECTABLE DATA CHECK LIMIT EXCEEDED THE THRESHOLD

Explanation: During the REVAL FIXSIM(4E4E) or REFRESH process, excessive data checks were detected.

System Action: Command processing terminates.

Operator Response: None.

System Programmer Response: Save the job output and contact your IBM service representative.

ICK31308I DATA CHECK OCCURS WHILE RESTORING TRACK X'cccc hhhh'

Explanation: While restoring user data, a data check was detected.

System Action: Command processing terminates.

Operator Response: None.

System Programmer Response: Save the job output and contact your IBM service representative.

ICK31309I READ BACK CHECK FAILED ON TRACK X'cccc hhhh', DATA LOST

Explanation: While restoring user data, reread user data failed with data checks. User data was lost.

System Action: Command processing terminates.

Operator Response: None.

System Programmer Response: Save the job output and contact your IBM service representative.

ICK31310I REVALIDATE FIXSIM(4E4E) PROCESS CAN NOT CONTINUE

Explanation: During the REVAL FIXSIM(4E4E) process, a severe error was detected.

System Action: Command processing terminates.

Operator Response: None.

System Programmer Response: Refer to the previous messages for problem determination.

Messages received at the output printer

ICK31311I REVALIDATE REFRESH PROCESS CAN NOT CONTINUE

Explanation: During the REVAL REFRESH process, a severe error was detected.

System Action: Command processing ends.

Operator Response: None.

System Programmer Response: Refer to the previous messages for problem determination.

ICK31322I RACHECK FAILED FOR resname

Explanation: You attempted to execute an ICKDSF command for which you are not authorized. The request failed as the resource was protected by RACF. Resname will contain the resource name.

System Action: Command processing ends.

Operator Response: None.

System Programmer Response: Obtain the proper level of authorization.

ICK31323I RACROUTE FAILED

SAF RETURN CODE = nn
RACF RETURN CODE = nn
RACF REASON CODE = nn

Explanation: RACF was unable to complete the request to check user authority to access a resource. For descriptions of the error codes, see the return code information under RACROUTE REQUEST=AUTH in the External Security Interface (RACROUTE) Macro Reference.

System Action: Command processing ends.

Operator Response: None.

System Programmer Response: Correct the error indicated in the error codes.

ICK31324I VOLUME CONTAINS VSAM DATA SET(S)

Explanation: The volume being processed online contains one or more VSAM data sets.

System Action: The data sets are not destroyed, and the command ends. ICKDSF continues with the next command.

Operator Response: None.

System Programmer Response: Either use Access Method Services to delete the VSAM data sets, or initialize the volume offline. Save the job output and contact your IBM service representative.

ICK31325I OPERATOR REFUSED TO CONTINUE PROCESSING

Explanation: The operator responded T to message ICK003D when a reply to continue processing was requested.

System Action: The command ends. ICKDSF continues with the next command.

Operator Response: None.

System Programmer Response: Determine the reason the request to process was refused, and reissue the command.

ICK31326I IMPROPER RACF ACCESS AUTHORITY

Explanation: A volume that is RACF protected cannot be processed unless the user has the proper level of authorization.

System Action: The command ends. ICKDSF continues with the next command.

Operator Response: None.

System Programmer Response: Either obtain the proper level of authorization, or process the volume in offline mode. Save the job output and contact your IBM service representative.

ICK31327I NO STORAGE AVAILABLE FOR MAXIMUM TRACK CAPACITY RECORD

Explanation: No main storage buffer space was available to store the bit pattern that would eventually be written on the volume during surface check.

System Action: The command ends. ICKDSF continues with the next command.

Operator Response: None.

System Programmer Response: Specify a larger region size for the job step, and submit the job again.

ICK31328I UNABLE TO OBTAIN STORAGE

Explanation: Dynamic acquisition of storage for control blocks and work areas failed.

System Action: Command processing ends.

Operator Response: None.

System Programmer Response: Increase storage size and submit the job again.

ICK31329I ERROR DURING FREEMAIN

Explanation: An error occurred during processing of the FREEMAIN macro.

System Action: Command processing ends.

Operator Response: None.

System Programmer Response: Contact your IBM service representative.

ICK31330I UNIT PARAMETER INVALID

Explanation: The specified UNIT parameter is not valid in this operating system environment.

System Action: Command processing ends.

Operator Response: None.

System Programmer Response: Check the accepted parameters for the specified command to determine what parameters are valid for this operating system.

Messages received at the output printer

ICK31331I REALADDR PARAMETER INVALID

Explanation: The specified REALADDR parameter is not valid in this operating system environment.

System Action: Command processing ends.

System Programmer Response: Check the accepted parameters for the specified command to determine the valid parameters for this operating system.

Operator Response: None.

ICK31335I SPECIFIED RANGE IS INVALID WHEN USED WITH REALADDR PARAMETER

Explanation: Specified addresses for the INSPECT REALADDR command cannot exceed either one cylinder for CKD devices, or one block for FBA devices

System Action: Command processing ends.

System Programmer Response: Check the accepted parameters for the specified command to determine the valid parameters.

Operator Response: None.

ICK31396I TOO MANY DATA CHECKS ON VOLUME

Explanation: During processing for the specified volume, more data checks occurred than are considered reasonable for this device type.

System Action: The command ends.

Operator Response: None.

System Programmer Response: This message indicates that an abnormal amount of data checks have occurred for this volume.

If a large number of data checks are expected for the volume, issue the command again.

Otherwise, seek the aid of the IBM hardware service representative. Obtain helpful information by running ANALYZE SCAN of the volume for its output, in addition to the current ICKDSF output.

ICK31401I UNABLE TO PROCESS FURTHER

Explanation: An error prevents further processing on this device.

This message is issued when path control is used and an error prevents processing on any remaining paths.

It is also issued when a volume in duplex or suspended duplex state changes its state during processing.

System Action: Command processing ends.

Operator Response: None.

System Programmer Response: Examine previous messages to determine the cause of the error.

ICK31403I ccuu DATA SCAN VALUES INVALID, TESTING TERMINATED

Explanation: The relative block numbers, tracks, or cylinders specified by the LIMITS parameter are not valid.

System Action: Data verification is not done.

Operator Response: Specify valid relative block numbers, tracks, or cylinders in the LIMITS parameter, and submit the request again.

ICK31404I ccuu VOLUME HAS UNFORMATTED DATA BLOCKS, TESTING TERMINATED

Explanation: An attempt was made to read a data block which was not initialized (data field not written).

System Action: After 504 data checks, the ANALYZE command ends.

Operator Response: Perform appropriate procedures to recover all desired data from the volume. Then reinitialize the volume, using the ICKDSF INIT command specifying the CHECK parameter.

ICK31405I NO STORAGE AVAILABLE

Explanation: Dynamic acquisition of storage for work areas and control blocks failed.

System Action: Command processing ends.

Operator Response: Increase main storage size.

ICK31406I INVALID DATA RECEIVED FROM DEVICE, varname=varvalue

Explanation: A CCW was issued to the device, and data was returned which is invalid. The *varname* value contains the variable that ICKDSF is referencing, and the *varvalue* value contains the data passed back from device.

System Action: The command ends.

Operator Response: None.

System Programmer Response: None. Save the job output and contact your IBM service representative.

ICK31410I MAIN STORAGE NOT AVAILABLE, TESTING TERMINATED

Explanation: Dynamic acquisition of storage for work areas and control blocks failed.

System Action: Command processing ends.

Operator Response: Increase main storage size.

ICK31412I ccuu DEVICE NOT READY, TESTING TERMINATED

Explanation: A condition has caused "Intervention Required" to be posted in the failing CSW sense byte.

System Action: The ANALYZE command ends.

Operator Response: Ready the drive, and issue the command again.

Messages received at the output printer

ICK31413I DATAVER DATA FORMAT UNACCEPTABLE ON
CYLINDER X'cccc'

Explanation: One of the following conditions may have occurred at hexadecimal cylinder X'cccc' on the device:

- The data on the identified cylinder is written in a format unreadable by the standard IBM CCWs.
Examine and correct this condition using the INIT and/or INSPECT commands.
- A drive error (such as dropping ready) occurred during the test. The condition that caused the drive error is usually intermittent or marginal, and was not detected during the drive tests.
Seek support from your IBM hardware service representative.
- The volume under test is also accessed by another program, and the other program erased a record that ANALYZE might be trying to reread. This condition is not probable, but if it occurs, run the ANALYZE job again.

System Action: ANALYZE command processing ends with a return code of 8.

Operator Response: None.

System Programmer Response: See "Explanation." Check subsequent messages for status of drive.

ICK31414I MAIN STORAGE NOT AVAILABLE FOR DRIVE TEST

Explanation: Storage is not available for CCW and work areas.

System Action: Command processing ends.

Operator Response: Increase storage size and submit the job again.

System Programmer Response: None.

ICK31415I UNABLE TO READ HOME ADDRESS FROM CE TRACK
X'cccc hhhh'

Explanation: Unable to read the home address from the CE track during the Write System Stress Test.

System Action: Command processing terminates.

Operator Response: None.

System Programmer Response: Save the job output and contact your IBM service representative.

ICK31416I UNABLE TO WRITE RECORDS TO CE TRACK
X'cccc hhhh'

Explanation: Unable to write records onto the CE track during the Write System Stress Test.

System Action: Command processing terminates.

Operator Response: None.

System Programmer Response: Save the job output and contact your IBM service representative.

ICK31417I MULTIPLE DATA CHECKS OCCUR ON TRACK
X'cccc hhhh'

Explanation: At least two data checks occurred on the same CE track during the Write System Stress Test.

System Action: Command processing terminates.

Operator Response: None.

System Programmer Response: Save the job output and contact your IBM service representative.

ICK31418I DATA CHECKS EXCEED HEAD THRESHOLD

Explanation: More than two data checks occurred on the same CE track during the Write System Stress Test.

System Action: Command processing terminates.

Operator Response: None.

System Programmer Response: Save the job output and contact your IBM service representative.

ICK31420I DATA COMPARE ERROR STARTING AT BYTE =
X'xxxx'

EXPECTED DATA =
+ 00
+ 10
RECEIVED DATA =
+ 00
+ 10

Explanation: The data transferred during the drive test did not match what was expected. The starting byte printed by the message is the first byte that did not compare (relative to the beginning of the transferred data).

The expected and received data is dumped starting at offset 0 from the point of mismatch. The length of the data dumped is variable.

System Action: Command processing ends on this path. Some tests are bypassed.

Operator Response: None.

System Programmer Response: Contact your IBM hardware service representative for assistance in resolving the problem.

ICK31430I EXCESSIVE 0F0B ERRORS OCCURRED ON THE
VOLUME

Explanation: The 0F0B errors encountered on the volume exceeded the threshold.

System Action: Command processing ends.

Operator Response: None.

System Programmer Response: Save the job output and contact your IBM service representative.

ICK31501I INVALID DEVICE TYPE SPECIFIED FOR BUILDIX
COMMAND

Explanation: A request was made to change the format of a VTOC on a volume whose device type is not supported by the BUILDIX command (for example, a 9332 DASD).

Messages received at the output printer

System Action: Command processing ends.

Operator Response: None.

System Programmer Response: Verify that the volume is on a device type supported by the BUILDIX command, and change the JCL or command statement.

ICK31505I cccu VTOC FORMAT IS CURRENTLY **FORMAT,
REQUEST REJECTED

Explanation: The format of the VTOC is currently the same as the format requested in the BUILDIX command statement.

** identifies the format of the VTOC, either OS or IX.

System Action: Command processing ends.

Operator Response: None.

System Programmer Response: Check the command statement. (The format requested must be opposite the current VTOC format identified in this message.)

Be certain that the JCL DD statement correctly identifies the volume. Change the statements where required, and submit the job again.

ICK31509I cccu DIRF FLAG SET IN VTOC, COMMAND CANNOT
PROCEED

Explanation: An error during VTOC processing on a previous job caused the DADSM interrupt flag to be set in the VTOC. The VTOC is not accurate.

System Action: Command processing ends.

Operator Response: Prepare a job that will cause reconstruction of the VTOC, and run it against the volume. (For example, run an IEFBR14 job to allocate a temporary data set to the volume.)

On conclusion of this job, reissue the command again.

Note: The VTOC DIRF bit and the indexed bit (DS4VTOC=5) should never be set on together. If they are, the IEFBR14 job, mentioned in the previous paragraph, cannot correct the VTOC. To correct this condition, you can use the SUPERZAP program, available with your system, to turn the DIRF bit off.

System Programmer Response: None.

ICK31510I cccu BUILDIX REQUEST CANCELLED DUE TO
OPERATOR ACTION

Explanation: The operator replied CANCEL to a message requiring a response.

System Action: Command processing ends.

Operator Response: None.

System Programmer Response: Confirm the reason for cancellation of the job with the operator.

ICK31511I cccu CVAF ERROR: RETURN CODE=*** ERROR
CONDITION= ***

Explanation: The common VTOC access facility returned to ICKDSF with a return code indicating either a logical error or a physical error. Return codes have the following meanings:

4, 12 Logical errors

8 Index structure not valid

16 I/O error

For more information on these error conditions, see *DFSMSdfp Diagnosis Reference*, GY27-7618.

System Action: Command processing ends

Operator Response: None.

System Programmer Response: Refer to the DADSM program logic manual for a full explanation of CVAF return codes and error condition codes.

ICK31512I cccu ERROR: SYS1.VTOCIX. IS A VIO
DATASET. BUILDIX TERMINATED.

Explanation: The index data set was allocated as a VIO data set and is not supported by the BUILDIX command.

System Action: Command processing ends with a return code of 12. The VTOC is left unchanged.

Operator Response: None.

System Programmer Response: Ensure that allocation of the index data set specifies a permanent data set.

Check the JCL statement that defines the index data set and change the parameter. Resubmit the job.

ICK31514I INDEXED VTOC FACILITY NOT ON SYSTEM

Explanation: There is a request to change a VTOC to IXVTOC format, but the system does not contain indexed VTOC programming support.

System Action: If the command was BUILDIX, then command processing ends. If the command was REFORMAT, then ICKDSF will not rebuild the index after VTOC expansion process is completed.

Operator Response: None.

System Programmer Response: None.

ICK31515I cccu BUILDIX COMMAND FAILED.

Explanation: An error caused command processing to end.

System Action: Command processing ends.

Operator Response: None.

System Programmer Response: Check the job output for messages describing the type of failure.

ICK31516I cccu I/O ERROR DETECTED DURING VTOC
CONVERSION: ERROR CODE= *

Explanation: An I/O error occurred during BUILDIX processing. Error codes:

1 Error occurred in reading the volume label

2 Error occurred in reading the VTOC

3 Error occurred in writing the VTOC

4 Error occurred in writing index records

Messages received at the output printer

5 Index extent was violated; increase index size

System Action: BUILDIX command processing ends.

Operator Response: Consult the system coordinator to identify the problem.

System Programmer Response: None.

ICK31517I ccuu ERROR: VOLUME IS A DOS STACKED PACK

Explanation: The volume being processed has a VTOC on the first track of the volume. VTOC conversion is not possible on such a volume.

System Action: Command processing ends.

Operator Response: None

System Programmer Response: Correct the problem on the volume, possibly by initializing the volume with an INIT command.

Note: This will purge all existing data on the volume.

ICK31518I ccuu ERROR: VOLUME CONTAINS SPLIT CYLINDER EXTENTS

Explanation: The volume contains one or more shared extent data sets. These are not supported by the command.

System Action: Command processing ends.

Operator Response: None.

System Programmer Response: None.

ICK31519I ccuu ERROR: SYS1.VTOCIX. DATASET NOT FOUND ON VOLUME

Explanation: The index data set could not be found on the volume.

System Action: BUILDIX command processing ends.

Operator Response: None.

System Programmer Response: Check the job control statements to see if a DD statement exists that will allocate the index data set.

If the statement exists, make sure the name is specified correctly. Correct the error and submit the job again.

ICK31520I ccuu ERROR: DUPLICATE INDEX DATASET NAME FOUND ON VOLUME

Explanation: Two data sets were found on the volume that had names beginning with SYS1.VTOCIX. Only one is allowed per volume.

System Action: BUILDIX command processing ends.

Operator Response: None.

System Programmer Response: Either submit a job to scratch one of the data sets, or scratch both data sets if new index allocation is desired.

ICK31521I ccuu ERROR: INDEX DATASET EXTENT NOT CONTIGUOUS

Explanation: This data set occupies more than one extent. The index data set must occupy one, and only one, extent.

System Action: BUILDIX command processing ends.

Operator Response: None.

System Programmer Response: Scratch the index data set that is not valid. Submit the job again with a job control statement that will ensure only one extent is allocated to the index.

ICK31522I INVALID UNITADDRESS OR DDNAME SPECIFIED

Explanation: The UNITADDRESS or DDNAME is incorrect in the command statement.

System Action: BUILDIX command processing ends.

Operator Response: Correct the job control statement, and resubmit the job.

System Programmer Response: None.

ICK31523I VTOC ENQUEUE FAILURE

Explanation: ENQ RET=HAVE returned higher than a return code 8 (task does not have resources).

System Action: The command ends. ICKDSF continues with the next command.

Operator Response: None.

System Programmer Response: Submit the job again when ENQ can be obtained.

ICK31526I CONVERSION TO OSFORMAT COULD NOT COMPLETE SUCCESSFULLY

Explanation: The VTOC indicated an error condition at the conclusion of BUILDIX processing to convert to OSFORMAT.

System Action: BUILDIX ends abnormally.

Operator Response: None.

System Programmer Response: This message is usually an indication that the OS VTOC on the volume contains an error. Examine the VTOC to determine the nature of the error.

ICK31528I INDEX DATA SET CANNOT START AT CYLINDER 0, TRACK 0

Explanation: You specified cylinder 0 track 0 for the index data set location. This is not a valid location.

System Action: BUILDIX command processing ends.

Operator Response: None.

System Programmer Response: Issue the command again using a valid location.

Messages received at the output printer

ICK31529I ALLOCATE ERROR: RETURN CODE = ****

Explanation: DADSM allocate returned to ICKDSF with an unexpected return code.

System Action: BUILDIX command processing ends.

Operator Response: None.

System Programmer Response: Refer to the *DADSM Diagnosis Reference* for a full explanation of DADSM allocate return codes.

ICK31530I NO ROOM IN VTOC OR VTOC INDEX ON VOLUME

Explanation: An index could not be built as DADSM allocate indicated to ICKDSF that the VTOC or VTOC index on the volume is full.

System Action: Command processing ends.

Operator Response: None.

System Programmer Response: You may free up space by either moving data sets to another volume or deleting unwanted data sets from the volume. Or you may expand the VTOC and VTOC index using the REFORMAT command.

ICK31539I EXTINDEX PARAMETER INVALID FOR OFFLINE VOLUMES

Explanation: In the MVS environment the volume must be online when EXTINDEX is specified.

System Action: Command processing ends.

Operator Response: None.

System Programmer Response: Vary the device online and reissue the command using the DDNAME parameter.

ICK31540I NEWVTOC PARAMETER INVALID FOR ONLINE VOLUMES

Explanation: In the MVS environment the volume must be offline when NEWVTOC is specified.

System Action: Command processing ends.

Operator Response: None

System Programmer Response: Vary the device offline and reissue the command with the UNIT parameter.

ICK31541I NEW VTOC EXTENT IS NOT LARGER THAN THE ORIGINAL VTOC EXTENT

Explanation: The size of the new VTOC must be greater than the size of the old VTOC.

System Action: Command processing ends.

Operator Response: None

System Programmer Response: Modify the size of the new VTOC and reissue the job.

ICK31542I OVERLAY BETWEEN THE OLD AND NEW VTOC IS NOT ALLOWED

Explanation: The beginning and ending locations of the new VTOC must not be the same as the old VTOC. Overlay between the new and old VTOC is not allowed.

System Action: Processing ends.

Operator Response: None

System Programmer Response: Modify the location of the new VTOC and reissue the job. Or specify NEWVTOC(ANY,n) to let ICKDSF find the first free extent for the new VTOC.

ICK31543I I/O ERROR DETECTED WHILE ACCESSING VTOC :
ERROR CODE = x

Explanation: An I/O error occurred while ICKDSF was accessing the VTOC. These are possible error codes:

- 1 Error occurred in reading the VTOC.
- 2 Error occurred in writing the VTOC.

System Action: ICKDSF processing ends.

Operator Response: None

System Programmer Response: Save the job output and contact your IBM service representative.

ICK31544I SPECIFIED VTOC EXTENT WAS OCCUPIED BY THE FOLLOWING DATA SETS :

Explanation: The specified VTOC extent is allocated to other data sets. Refer to message ICK00546 for the data set names.

System Action: Command processing ends.

Operator Response: None

System Programmer Response: Either modify the new VTOC location, or delete those data sets that are no longer needed, or move those data sets to another location, then run the job again.

ICK31545I FREE SPACE IS NOT AVAILABLE FOR THE NEW VTOC

Explanation: Either the specified VTOC extent is allocated to other data sets, or the free extents on the volume are too small to fit the new VTOC.

System Action: Command processing ends.

Operator Response: None

System Programmer Response: Either modify the new VTOC location, or delete those data sets that are no longer needed, or move those data sets to another location. Or, if NEWVTOC was specified, you may specify NEWVTOC(ANY,n) to let ICKDSF find the first free extent, if one is available for the new VTOC.

ICK31548I NEW VTOC EXTENT MUST BE SPECIFIED

Explanation: The VTOC extent is a required subparameter for NEWVTOC or EXTVTOC.

System Action: Command processing ends.

Operator Response: None

Messages received at the output printer

System Programmer Response: Modify the command and reissue the job.

ICK31549I ERROR WAS FOUND IN VTOC: ERROR CODE = x

Explanation: An error was found in the VTOC in regards to data set information. The possible error codes are:

- 1 F1 or F3 pointer does not point to a F3 DSCB.
- 2 Invalid data set extent information. If F1 DSCB then refer to message ICK00546 for the data set name.
- 3 Invalid record number

System Action: Command processing ends.

Operator Response: None

System Programmer Response: Follow the procedures at your installation for reconstructing VTOCs. After the VTOC is repaired, reissue the command.

ICK31550I INVALID VTOC LOCATION SPECIFIED:

Explanation: The specified VTOC location contained invalid characters.

System Action: Command processing ends.

Operator Response: None

System Programmer Response: Correct the VTOC location and reissue the job.

**ICK31551I TOO MANY SUBPARAMETERS SPECIFIED IN
PARAMETER : parameter**

Explanation: The number of subparameters specified in the listed parameter exceeds the limit.

System Action: Command processing ends.

Operator Response: None

System Programmer Response: Correct the command syntax, and issue the command again.

**ICK31560I ERROR OCCURRED WHILE ISSUING MACRO OVTOC,
RETURN CODE =**

Explanation: In the VSE environment, during the opening of the volume, an error occurred trying to obtain an exclusive open using the OVTOC macro. The value of return code is in decimal.

System Action: Command processing ends.

Operator Response: None

System Programmer Response: See the *IBM VSE/Enterprise Systems Architecture VSE Central Functions Diagnosis Reference LIOCS Version 6 Release 4*, and the *VSE/ESA Messages and Codes* for the reason for failure.

**ICK31565I ERROR OCCURRED WHILE ISSUING MACRO
ASSIGN, RETURN CODE =**

Explanation: In the VSE environment, during the opening of the volume, an error occurred trying to dynamically assign a system logical unit. The value of return code is in decimal.

System Action: Command processing ends.

Operator Response: None

System Programmer Response: See the *IBM VSE/Enterprise Systems Architecture VSE Central Functions Initial Program Load and Job Control Diagnosis Reference Version 6 Release 6*, and the *VSE/ESA Messages and Codes* for the reason for failure.

ICK31602I INCORRECT DEVICETYPE, MAPALT TERMINATED

Explanation: The device type specified is not supported by the MAPALT command.

System Action: MAPALT command processing ends.

Operator Response: Specify the correct device type in the DEVICETYPE keyword of the command statement, and submit the job again. (MAPALT can only be processed on fixed block devices in fixed block mode.)

System Programmer Response: None.

ICK31603I UNABLE TO OPEN VOLUME

Explanation: The volume that was specified cannot be opened. The ASSIGN statement could be either missing or not valid, or the channel and unit address could be not valid.

System Action: MAPALT command processing ends.

Operator Response: Correct the error, and submit the job again.

System Programmer Response: None.

**ICK31604I ccuu LIMITS PARAMETER INVALID AS
SPECIFIED, MAPALT TERMINATED**

Explanation: The relative block numbers specified by the LIMITS parameter are not valid.

System Action: MAPALT command processing ends.

Operator Response: Correct the values in the LIMITS parameter, and submit the job again.

**ICK31605I ccuu UNRECOVERABLE I/O ERROR DETECTED,
MAPALT TERMINATED**

Explanation: An unrecoverable I/O error (other than a data check) was encountered.

System Action: MAPALT command processing ends.

Operator Response: Check the job output for diagnostic information to aid in analyzing the error.

Run the ICKDSF ANALYZE command as a problem determination aid, then follow installation procedures for recovery from this type of error.

System Programmer Response: None

**ICK31607I ccuu MAPALT ABNORMALLY ENDED, REPORT MAY
BE INCOMPLETE**

Explanation: An error caused command processing to end. The report may be incomplete.

System Action: None.

Operator Response: Check previous job output messages,

Messages received at the output printer

and follow installation procedures.

System Programmer Response: None.

ICK31611I **MAIN STORAGE NOT AVAILABLE, MAPALT
TERMINATED**

Explanation: Dynamic acquisition of storage for control blocks and work areas failed.

System Action: MAPALT command ended.

Operator Response: Increase main storage size, and submit the job again.

System Programmer Response: None.

ICK31700I **VTOC EXTENT INVALID**

Explanation: Either the starting or ending block number as calculated from the FBAVTOC parameter is not valid.

System Action: The command ends. ICKDSF continues with the next command.

Operator Response: None.

System Programmer Response: Correct the FBAVTOC parameter so the ending parameter is within the device limits. Run the job again.

ICK31701I **VTOC EXTENT EXCEEDED THE MAXIMUM VALUE
ALLOWED**

Explanation: The specified VTOC extent has exceeded the maximum allowed. See Appendix C, "VTOC index," on page 465 for the maximum VTOC size for different device types.

System Action: Command processing ends.

Operator Response: None

System Programmer Response: Modify the size of the VTOC extent and reissue the job.

ICK31702I **AN UNRECOVERABLE I/O ERROR OCCURRED DURING
RECLAIM PROCESSING**

Explanation: An unrecoverable I/O error occurred during INIT reclaim processing.

System Action: Command processing ends.

Operator Response: None.

System Programmer Response: Prior messages should be examined (including the CCW, CSW, and sense that caused the I/O) to determine the cause of the failure.

Run the INIT command again after the problem has been resolved.

Assistance may be required from the IBM service representative. Save the job output and contact your IBM hardware service representative.

ICK31705I **ALTERNATE BLOCKS EXHAUSTED**

Explanation: A prime block needed an alternate, but all available alternate blocks have already been assigned.

System Action: The command ends. ICKDSF continues with the next command.

Operator Response: None.

System Programmer Response: Reinitialize the volume with RECLAIM specified to free alternate blocks. If this is not successful, save the job output and contact your IBM hardware service representative.

ICK31706I **AN UNRECOVERABLE I/O ERROR OCCURRED DURING
SURFACE ANALYSIS**

Explanation: An unrecoverable I/O error occurred during INIT surface analysis.

System Action: Command processing ends.

Operator Response: None.

System Programmer Response: Prior messages should be examined (including the CCW, CSW, and sense that caused the I/O) to determine the cause of the failure. Resolve the problem and run the INIT command again.

Assistance may be required from the IBM service representative. Save the job output and contact your IBM hardware service representative.

ICK31709I **I/O ERROR FORMATTING BLOCK IDENTIFIER**

Explanation: An uncorrectable error occurred while formatting the block identifier field of a block on a 3370.

System Action: The command ends. ICKDSF continues with the next command.

Operator Response: None.

System Programmer Response: Contact your IBM hardware service representative. Save the job output and contact your IBM hardware service representative.

ICK31710I **I/O ERROR FORMATTING BAD BLOCK xxxxxxxxxx**

Explanation: An uncorrectable error occurred while formatting the defective block xxxxxxxx.

System Action: The command ends. ICKDSF continues with the next command.

Operator Response: None.

System Programmer Response: Contact your IBM hardware service representative. Save the job output and contact your IBM hardware service representative.

ICK31711I **CANNOT READ SA INFORMATION**

Explanation: The surface analysis information (factory-flagged list) cannot be read because of an I/O error.

System Action: The command ends. ICKDSF continues with the next command.

Operator Response: None.

Messages received at the output printer

System Programmer Response: Contact your IBM hardware service representative. Save the job output and contact your IBM hardware service representative.

ICK31712I INVALID SA INFORMATION FORMAT

Explanation: The data format of SA information (factory-flagged list) is in error. (Typically, the end of data is not found.)

System Action: The command ends. ICKDSF continues with the next command.

Operator Response: None.

System Programmer Response: Contact your IBM hardware service representative. Save the job output and contact your IBM hardware service representative.

ICK31713I CANNOT READ PRIME CYLINDER IDS

Explanation: An uncorrectable I/O error occurred while reading the ID fields of prime blocks.

System Action: The command ends. ICKDSF continues with the next command.

Operator Response: None.

System Programmer Response: Contact your IBM hardware service representative. Save the job output and contact your IBM hardware service representative.

ICK31715I SETMODE PARAMETER INVALID FOR THIS DEVICE TYPE

Explanation: The SETMODE parameter of the INSTALL command is only valid for 3390 devices.

System Action: Command processing ends.

System Programmer Response: Correct the parameters and run the job again.

Operator Response: None

ICK31716I INVALID PARAMETER(S) FOR DEVICE TYPE: list of parameters

Explanation: Parameters in the parameter list are not valid for device type being processed. For example, the VTOC parameter is specified for an INIT of an FBA device, or the CHECK parameter is specified for the IBM 3375, 3380, or 3390.

System Action: The command ends. ICKDSF continues with the next command.

Operator Response: None.

System Programmer Response: Correct parameters, and run the job again.

ICK31717I VERIFICATION FAILED: VOL1 LABEL DOES NOT EXIST

Explanation: Verification failed because the volume being initialized does not have a VOL1 label to use for the verify. This may indicate the wrong volume.

System Action: The command ends. ICKDSF continues with the next command.

Operator Response: None.

System Programmer Response: Resolve the problem and run the job again.

ICK31718I INIT FAILED: VOLID NOT SPECIFIED AND I/O ERROR READING VOLUME LABEL

Explanation: The VOLID parameter is not specified. Because of an I/O error reading the volume label, a volume serial is not available.

System Action: The command ends. ICKDSF continues with the next command.

Operator Response: None.

System Programmer Response: Try specifying VOLID.

If this is not successful, identify the cause of the I/O error reading the volume label. Save the job output and contact your IBM hardware service representative.

ICK31719I INVALID PARAMETER(S) FOR OPEN-SYSTEM - list of parameters

Explanation: Parameters shown in the list are not valid with parameters for open-system DASD.

System Action: The command ends. ICKDSF continues with the next command.

Operator Response: None.

System Programmer Response: Correct the parameters and run the job again.

ICK31720I VOLUME SIZE IS TOO SMALL FOR THIS FUNCTION

Explanation: The size of the volume (number of cylinders) is too small for this function.

System Action: The command ends. ICKDSF continues with the next command.

Operator Response: None.

System Programmer Response: Use a larger volume to run this function.

ICK31721I LSS PARAMETER REQUIRED FOR DEVICE TYPE

Explanation: The LSS parameter is required to be specified for this device.

System Action: The command ends. ICKDSF continues with the next command.

Operator Response: None.

System Programmer Response: Correct the parameters and run the job again.

Messages received at the output printer

ICK31722I VERIFICATION FAILED: I/O ERROR READING
VOL1 LABEL

Explanation: An uncorrectable I/O error occurred while reading the VOL1 label. Verification cannot continue.

System Action: Diagnostic information is printed on the output device. The command ends. ICKDSF continues with the next command.

Operator Response: None.

System Programmer Response: Reinitialize the volume, specifying NOVERIFY and a VALID. Start recovery procedures for data on the volume. Save the job output and contact your IBM hardware service representative.

ICK31723I TOO MANY LINK ADDRESSES SPECIFIED FOR
DEVICE TYPE

Explanation: The number of link addresses specified is more than what is allowed for this device type.

System Action: The command ends. ICKDSF continues with the next command.

Operator Response: None.

System Programmer Response: Correct the parameters and run the job again.

ICK31724I SEC LSS SPECIFIED DOES NOT MATCH LSS IN
LINKADDR: X'xxxx xxxx'

Explanation: The logical subsystem number specified as the secondary LSS in the LSS parameter does not match the destination LSS specified in the last byte of the linkaddress. X'xxxx xxxx' is the linkaddress specified that does not match.

System Action: The command ends. ICKDSF continues with the next command.

Operator Response: None.

System Programmer Response: Correct the parameters and run the job again.

ICK31728I FBA MINIDISK NOT SUPPORTED IN THIS
ENVIRONMENT

Explanation: Fixed block architecture minidisks are not supported in VSE or MVS environments.

System Action: The command ends. ICKDSF continues with the next command.

Operator Response: None.

System Programmer Response: Run the command in the Stand-Alone version of ICKDSF.

ICK31748I COMMAND CANNOT BE EXECUTED - DEVICE ACCESS
LIMITED

Explanation: The current command cannot be processed because certain types of access are prohibited for the specified device.

For example, a diagnostic control CCW cannot be issued for a minidisk.

System Action: The command ends. ICKDSF continues with the next command.

Operator Response: None.

System Programmer Response: Make sure the issued command is compatible with the specified device.

ICK31749I DEVICE TYPE NOT SUPPORTED IN THIS
ENVIRONMENT

Explanation: The device type is not supported in your version of ICKDSF.

System Action: Command processing ends. ICKDSF continues with the next command.

Operator Response: None.

System Programmer Response: Refer to the command description in the user's guide to see which versions of ICKDSF support this device type. Make sure that the appropriate version is installed before running the job again.

ICK31750I TRACKS OR ALLTRACKS PARAMETER REQUIRED FOR
CKD DEVICES

Explanation: BLOCKS was specified for a count-key-data device. You must specify either TRACKS or ALLTRACKS for these devices.

System Action: The command ends. ICKDSF continues with the next command.

Operator Response: None.

System Programmer Response: Resubmit the job, specifying either TRACKS or ALLTRACKS. Save the output and contact your IBM service representative.

ICK31751I BLOCKS PARAMETER REQUIRED FOR FBA DEVICE

Explanation: TRACKS OR ALLTRACKS was specified for a fixed block architecture device. You must specify BLOCKS for these devices.

System Action: The command ends. ICKDSF continues with the next command.

Operator Response: None.

System Programmer Response: Submit the job again, specifying BLOCKS. Save the output and contact your IBM service representative.

ICK31753I NO VALID BLOCK NUMBERS SPECIFIED

Explanation: All the block numbers specified by the BLOCKS parameters were not valid. This message is preceded by one or more ICK11752I messages.

System Action: The command ends. ICKDSF continues with the next command.

Operator Response: None.

System Programmer Response: Resubmit the job, specifying the correct block numbers in the BLOCKS parameter. Save the output and contact your IBM service representative.

Messages received at the output printer

ICK31756I READ FOR PRESERVE OF BLOCK xxxxxxxx
FAILED: UNRECOVERABLE I/O ERROR

Explanation: The user data on block xxxxxxxx could not be read because of unrecoverable I/O errors.

System Action: Diagnostic information is printed on the output device and block processing ends to prevent loss of the user data on the block. Command processing continues with the next valid block specified in the BLOCKS parameter.

Operator Response: None.

System Programmer Response: None. Save the job output and contact your IBM hardware service representative.

ICK31757I READ FOR PRESERVE OF BLOCK xxxxxxxx
FAILED: INSPECT ECC CORRECTION LOGIC
FAILED

Explanation: The read for the user data on block xxxxxxxx failed with an error correction code (ECC) correctable error, and the ECC correction information in the sense did not correspond to the expected information for the processed CCW chain.

System Action: Diagnostic information is printed on the output device, and command processing ends. ICKDSF continues with the next command.

Operator Response: None.

System Programmer Response: None. Save the output and contact your IBM service representative.

ICK31758I USER DATA ON BLOCK xxxxxxxx LOST

Explanation: Command processing failed with a permanent error. ICKDSF was unable to restore the user data on block xxxxxxxx.

System Action: The command ends. ICKDSF continues with the next command.

Operator Response: None.

System Programmer Response: Start recovery procedures for the data set containing block xxxxxxxx. Save the output and contact your IBM service representative.

ICK31762I CHECK FUNCTION FOR BLOCK xxxxxxxx FAILED:
UNRECOVERABLE I/O ERROR

Explanation: An unrecoverable I/O error occurred during surface analysis of block xxxxxxxx.

System Action: Diagnostic information is printed on the output device. The command ends, and ICKDSF continues with the next command.

If you specified PRESERVE, you receive either message ICK31758I or message ICK01759I on the output device to indicate the status of the user data on the block.

Operator Response: None.

System Programmer Response: Save the job output and contact your IBM hardware service representative.

ICK31763I ASSIGN FUNCTION FOR BLOCK xxxxxxxx FAILED:
NO ALTERNATE BLOCKS AVAILABLE

Explanation: An attempt was made to assign an alternate to block xxxxxxxx, and there are no more alternates available.

System Action: The command ends. ICKDSF continues with the next command.

If you specified PRESERVE, you receive either message ICK31758I or message ICK01759I on the output device to indicate the status of the user data on the block.

Operator Response: None.

System Programmer Response: Reinitialize the device. Save the output and contact your IBM service representative.

ICK31764I ASSIGN FUNCTION FOR BLOCK xxxxxxxx
FAILED: FORMAT DEFECTIVE BLOCK ERROR

Explanation: An unrecoverable error occurred while using the format defective block CCW chain to assign a new alternate to block xxxxxxxx.

System Action: Diagnostic information is printed on the output device. The command ends, and ICKDSF continues with the next command.

If you specified PRESERVE, you receive either message ICK31758I or message ICK01759I on the output device to indicate the status of the user data on the block.

Operator Response: None.

System Programmer Response: Save the job output and contact your IBM hardware service representative.

ICK31766I ASSIGN FUNCTION FOR BLOCK xxxxxxxx FAILED:
NO NON-DEFECTIVE ALTERNATES FOUND

Explanation: The format defective block CCW chain was retried 10 times for block xxxxxxxx and all ten assigned alternates failed surface analysis.

System Action: The command is ends, and ICKDSF continues with the next command.

If you specified PRESERVE, you receive either message ICK31758I or message ICK01759I on the output device to indicate the status of the user data on the block.

Operator Response: None.

System Programmer Response: Save the job output and contact your IBM hardware service representative.

ICK31767I ASSIGN FUNCTION FOR BLOCK xxxxxxxx FAILED:
UNRECOVERABLE I/O ERROR OCCURRED DURING
SURFACE ANALYSIS

Explanation: An unrecoverable I/O error occurred during surface analysis of the alternate assigned to block xxxxxxxx.

System Action: Diagnostic information is printed on the output device. The command ends and ICKDSF continues with the next command.

If you specified PRESERVE, you receive either message ICK31758I or message ICK01759I on the output device to indicate the status of the user data on the block.

Messages received at the output printer

Operator Response: None.

System Programmer Response: Save the job output and contact your IBM hardware service representative.

**ICK31768I INVALID LOGICAL AND PHYSICAL DEVICE
 COMBINATION FOR REQUESTED FUNCTION**

Explanation: The logical and physical device types were not equal. This was determined from the information returned from the sense ID (Sense I/O Type) CCW. Emulation of fixed block architecture devices is not supported by ICKDSF.

System Action: The command ends, and ICKDSF continues with the next command.

Operator Response: None.

System Programmer Response: Verify the device configuration is supported by ICKDSF. Save the output and contact your IBM service representative.

ICK31769I DEVICE BLOCK SIZE OF nnnn NOT SUPPORTED

Explanation: The block size (nnnn) information returned from the characteristics CCW of a read device does not equal 512.

System Action: The command ends, and ICKDSF continues with the next command.

Operator Response: None.

System Programmer Response: Save the job output and contact your IBM hardware service representative.

**ICK31772I INSUFFICIENT STORAGE AVAILABLE TO READ
 VTOC**

Explanation: Dynamic acquisition of storage for an input buffer failed.

System Action: The command ends and ICKDSF continues with the next command.

Operator Response: None.

System Programmer Response: Increase the amount of storage available for GETMAIN/GETVIS. Save the output and contact your IBM service representative.

ICK31773I VOL1 LABEL NOT FOUND

Explanation: An online volume does not have a VOL1 label.

System Action: The command ends, and ICKDSF continues with the next command.

Operator Response: None.

System Programmer Response: Either initialize the volume, or run the command again in the Stand-Alone version of ICKDSF.

ICK31774I I/O ERROR READING VOL1 LABEL

Explanation: A permanent I/O error occurred while reading the VOL1 label.

System Action: Diagnostic information is printed on the output device. The command ends, and ICKDSF continues with the next command.

Operator Response: None.

System Programmer Response: Reinitialize the volume, and start recovery procedures for the data on the volume.

The INIT command for reinitialization must specify the NOVERIFY and VOLID parameters. Save the job output and contact your IBM hardware service representative.

ICK31775I DATAVER: DATA CHECK EXCEEDED THRESHOLD

Explanation: The number of data checks exceeded the limit set for the specified device.

- For FBA devices, this limit is 504.
- For CKD devices, this limit is equivalent to the number of alternate tracks for this device, or 50, whichever is larger.

System Action: Command processing ends with a return code of 12.

Operator Response: None.

System Programmer Response: Save the console output and the printer output. Take action appropriate to your installation procedures for determining if an equipment problem exists.

If the problem is equipment-related, contact your IBM hardware service representative.

**ICK31776I dataset IS A RACF-PROTECTED DATA SET, BUT
 RACF IS INACTIVE**

Explanation: The named data set is marked as RACF protected, but RACF is not active on the system. This prevents ICKDSF from determining the user's authority to alter the data set.

System Action: Command processing ends after the security function completes.

Operator Response: None.

System Programmer Response: Activate RACF on the system or run in offline mode.

ICK31777I UNRECOVERABLE I/O ERROR READING THE VTOC

Explanation: An unrecoverable I/O error occurred while the ICKDSF security function tried to read the VTOC.

System Action: Command processing ends and the next command, if any, is processed.

Operator Response: None.

System Programmer Response: Investigate the cause of the I/O error. If required, run the command in an offline mode or Stand-Alone version.

Save the job output and contact your IBM hardware service representative.

**ICK31779I dataset IS A RACF-PROTECTED DATA SET, BUT
 NO RACF PROFILE EXISTS**

Explanation: The named data set is marked as RACF protected, but the RACF data set does not contain a profile for the named data set.

Messages received at the output printer

ICK31790I dataset IS A PASSWORD PROTECTED DATA SET,
UNRECOVERABLE I/O ERROR IN PASSWORD DATA
SET

Explanation: An unrecoverable I/O error occurred in the system password data set while verifying the user's authority to modify the named data set.

System Action: Command processing ends and the next command, if any, is processed.

Operator Response: None.

System Programmer Response: Consult the system programmer at your installation.

ICK31791I dataset IS AN UNEXPIRED DATASET, USER NOT
AUTHORIZED

Explanation: The expiration date for the named data set has not yet passed, and either the PURGE parameter was not specified on the INIT command, or the command is INSPECT with NOPRESERVE.

System Action: Command processing halts after the security function is complete.

Operator Response: None.

System Programmer Response: If INIT is used, specify the PURGE parameter and run the job again. If INSPECT is used, run specifying PRESERVE.

ICK31792I dataset IS A VSAM DATASET, USER NOT
AUTHORIZED

Explanation: The named data set is a VSAM data set and either the PURGE parameter was not specified on the INIT command, or NOPRESERVE was specified on the INSPECT command.

System Action: Command processing ends after the security function completes.

Operator Response: None.

System Programmer Response: If INIT is used, specify PURGE and run the job again. If INSPECT is used, run specifying PRESERVE, or take the volume off line and rerun with NOPRESERVE.

ICK31793I dataset IS A PASSWORD/VSAM/UNEXPIRED
DATASET, USER EXIT TERMINATES COMMAND

Explanation: The named data set is either a password protected, VSAM or unexpired data set. The user security exit module has indicated that ICKDSF should end command processing.

System Action: Command processing ends and the next command, if any, is processed.

Operator Response: None.

System Programmer Response: Consult the owner of the user security exit module at your installation.

ICK31794I dataset: UNRECOVERABLE I/O ERROR READING
FORMAT 2/ FORMAT 3 DSCB

Explanation: An unrecoverable I/O error occurred while reading a Format 2/ Format 3 data set label for the named data set.

System Action: Command processing ends and the next command, if any, is processed.

Operator Response: None.

System Programmer Response: Consult the system programmer at your installation. If required, run in either an offline mode or in the Stand-Alone version.

ICK31796I TRACK INSIDE VTOC INDEX DATASET CANNOT BE
INSPECTED WITH "NOPRESERVE"

Explanation: One or more tracks to be inspected are contained in the INDEX VTOC data set and cannot be inspected with NOPRESERVE.

If the TRACKS parameter is specified, the preceding ICK01795I messages identify the specified tracks that are inside the INDEX VTOC data set.

System Action: Command processing ends after the security function is complete.

Operator Response: None.

System Programmer Response: If required, run in either an offline mode or the Stand-Alone version.

ICK31797I TRACKS INSIDE VTOC CANNOT BE INSPECTED
WITH "NOPRESERVE"

Explanation: One or more tracks to be inspected are contained in the VTOC and cannot be inspected with NOPRESERVE.

System Action: Command processing ends after the security function completes.

Operator Response: None.

System Programmer Response: If required, run in either an offline mode or the Stand-Alone version.

ICK31799I OPERATOR REFUSED PERMISSION TO RECLAIM
SYSTEM RESERVE AREA ON *ccuu*

Explanation: The operator replied T to message ICK177D

System Action: The command ends. ICKDSF continues with the next command.

Operator Response: None.

System Programmer Response: Determine why the requested processing was refused and issue the command again.

ICK31816I PREVIOUS COMMAND DID NOT COMPLETE:
commandname

Explanation: A previous command did not complete. The command that did not complete is indicated by *commandname*. Current command processing will be inhibited until the condition is corrected.

Messages received at the output printer

System Action: Command processing ends.

Operator Response: None.

System Programmer Response: Run the command that did not complete first.

ICK31817I TRACK x'00000000' CANNOT BE PROCESSED
ONLINE

Explanation: The ICKDSF command does not allow processing of cylinder 0, head 0 in an MVS online mode.

System Action: Command processing ends after the security function completes.

Operator Response: None.

System Programmer Response: If required, run in either an offline mode or a Stand-Alone version of ICKDSF.

ICK31818I TRACK INSIDE VTOC INDEX DATASET CANNOT BE
PROCESSED ONLINE

Explanation: One or more tracks to be processed are contained in the INDEX VTOC dataset, and the command does not allow processing of these tracks in an MVS online mode.

System Action: Command processing ends after the security function completes.

Operator Response: None.

System Programmer Response: If required, run in either an offline mode or a Stand-Alone version of ICKDSF.

ICK31819I TRACKS INSIDE VTOC CANNOT BE PROCESSED
ONLINE

Explanation: One or more tracks to be processed are contained in the VTOC, and the command does not allow processing of these tracks in an MVS online mode.

System Action: Command processing ends after the security function completes.

Operator Response: None.

System Programmer Response: If required, run in either an offline mode or a Stand-Alone version of ICKDSF.

ICK31820I INVALID TRACK FORMAT DETECTED ON X'cccc
hhhh'

Explanation: The primary track was flagged defective but the associated alternate track did not point back to the primary track. The data on the primary track was lost.

System Action: Command processing terminates.

Operator Response: None.

System Programmer Response: Save the job output and contact your IBM service representative.

ICK31821I FREQUENCY OF SURFACE CHECKING PROCESS
EXCEEDS THE LIMIT

Explanation: During the REVAL FIXSIM(4E4E) or REFRESH process, the number of surface checks performed on the primary track exceeded the limit.

System Action: Command processing terminates.

Operator Response: None.

System Programmer Response: Save the job output and contact your IBM service representative.

ICK31827I UNABLE TO DO CONCURRENT PRESERVE ON TRACK
CCHH = X'xxxx xxxx'

Explanation: The *concurrent media maintenance* process was unable to guarantee that it has read the unmodified data from the track. Either the number of records or the format of data records is consistently changing. This problem has two possible causes:

- Consistent reformatting of the track by the user program while the INSPECT process is preserving the data.
- A hardware error.

System Action: The process ends.

Operator Response: None.

System Programmer Response: This message is preceded with ICK11827. Run the job again and ensure that there is no other application accessing the same volume during the INSPECT process. If either this message or message ICK11827 persists, contact your IBM service representative.

ICK31837I IPL TEXT EXISTS ON VOLUME. OPERATOR
REFUSED PERMISSION TO OVERLAY

Explanation: A volume already contains IPL text, and it cannot be replaced.

The operator refused permission to replace the IPL text.

System Action: The command ends.

Operator Response: None.

System Programmer Response: Either specify a volume that does not contain IPL text, or instruct the system operator to allow permission.

ICK31841I FORMAT FC STATUS CANNOT BE DETERMINED FOR
DEVICE ccuu

Explanation: An I/O error prevented completion of the RESETICD function. This problem has two possible causes:

- A hardware error.
- The device is not in the FC status and therefore does not need to be reset.

System Action: ICKDSF ends.

Operator Response: None.

System Programmer Response: See *Storage Subsystem Library 3990 Manuals*. Examine the CCW, CSW, and sense information to determine the cause of the error. Take action appropriate to your installation's procedures.

ICK31851I EXTENDED CKD FUNCTIONS CANNOT BE ACTIVATED
- COMMAND TERMINATED

Explanation: The device has never been online to the operating system, and the extended CKD functions (for example, cache logic) have not been activated. ICKDSF surface checking functions cannot be performed.

Messages received at the output printer

System Action: Command processing ends.

Operator Response: To activate the extended CKD functions, the device must be either:

- Varied online and varied offline or
- Varied online and the job run online

Also make certain that at least one I/O path to the device is online.

System Programmer Response: When the device cannot be varied online (that is, there is either no volume label or duplicate volume label), this procedure will process completely enough to activate the extended CKD logic. The job can be successfully run offline again.

ICK32106I RANGE SPECIFICATIONS INVALID

Explanation: The combination and/or values of the parameters specifying the current range are not valid.

System Action: Command processing ends.

Operator Response: None.

System Programmer Response: Correct the parameters, and run the job again.

ICK32110I TOO MANY TRACKS IN SPECIFIED RANGE FOR SKIP DISPLACEMENT FUNCTION

Explanation: The total number of tracks to be processed is greater than the maximum allowed for SKIP processing.

System Action: Command processing ends.

System Programmer Response: Run the job again with either a smaller range, or the NOSKIP parameter.

ICK32111I TOO MANY TRACKS IN SPECIFIED RANGE

Explanation: The total number of tracks in the specified range is greater than the maximum allowed for INSPECT processing.

System Action: Command processing ends.

Operator Response: None.

System Programmer Response: Either run the job again with a smaller range, or if necessary, save the data and use the INITIALIZE command.

ICK32112I UNABLE TO SET/RESET/READ CHECKPOINT DATA, PROCESSING TERMINATES

Explanation: The current INSPECT process is unable to set/reset/read the checkpoint data because of an I/O error. The recovery process for the error is depleted.

System Action: The current INSPECT process ends.

Operator Response: None.

System Programmer Response: If it is determined there is no other ICKDSF job processing the same device from a different processor, the INSPECT job can be submitted again using the FORCE parameter.

ICK32113I ONLINE REVALIDATE FIXSIM(4E4E) IS INVALID WHEN FIXSIM(4E4E) CHECKPOINT EXIST

Explanation: The REVALIDATE FIXSIM(4E4E) command has been issued to an online volume, which contains checkpoint data from a previous REVALIDATE FIXSIM(4E4E) command which did not complete.

System Action: Command processing terminates.

Operator Response: None.

System Programmer Response: Vary the device offline and reissue the FIXSIM(4E4E) job with the UNIT parameter.

ICK32114I INVALID SUBPARAMETER SPECIFIED IN PARAMETER : xxxxxx

Explanation: The subparameter the user specified in the listed parameter is not valid.

System Action: Command processing terminates.

Operator Response: None.

System Programmer Response: Correct the subparameter and reissue the job.

ICK32115I ONLINE REVAL REFRESH IS INVALID WHEN REFRESH CHECKPOINT EXIST

Explanation: When previous REVAL REFRESH did not complete, the user cannot specify another REVAL REFRESH while the device was online.

System Action: Command processing ends.

Operator Response: None.

System Programmer Response: Vary the device offline and reissue the REVAL REFRESH job with the UNIT parameter.

ICK32120I PRESERVE BACKUP FUNCTION CANNOT BE ACTIVATED

Explanation: The PRESERVE backup function of the INSPECT command cannot be activated. This message follows message ICK12118I.

System Action: Command processing ends.

Operator Response: None.

System Programmer Response: The job can be run again using HOLDIT.

If the error is temporary, the job can be run again.

ICK32121I CANNOT WRITE DATA ON THE PRESERVE TRACK

Explanation: An I/O error occurred while backing up user data on the preserve track.

System Action: Command processing ends.

Operator Response: None.

System Programmer Response: The job can be run again using HOLDIT.

Note: This system programmer response is valid only for the INSPECT command.

Messages received at the output printer

If the error is temporary, the job can be run again.

ICK32122I PRESERVE BACKUP FUNCTION CANCELLED USE "HOLDIT"

Explanation: An I/O error occurred while performing the PRESERVE backup function. This message is preceded by a message indicating the reason for cancellation.

System Action: Command processing ends.

Operator Response: None.

System Programmer Response: The job can be run again using HOLDIT.

If the error is temporary, the job can be run again.

ICK32123I PRESERVE DATA EXISTS THAT DOES NOT BELONG TO THIS MINIDISK

Explanation: User is trying to preserve data for the specified minidisk. However, there is preserve data that already exists for a different minidisk.

System Action: Command processing ends.

Operator Response: None.

System Programmer Response: See track address in ICK12120I to determine which minidisk is affected. Either recover or erase the previous preserve data before issuing the command again.

ICK32127I DATA CANNOT BE RECOVERED, INSPECT TERMINATED

Explanation: This message is issued after a reply of T to messages ICK22158I, ICK22130I, ICK12126I or ICK12159I.

ICK32160I CANNOT WRITE DATA ON THE PRESERVE BLOCK

Explanation: An I/O error was encountered while backing up user data on the preserve block.

System Action: Command processing ends.

Operator Response: None.

System Programmer Response: The job can be run again using HOLDIT.

If the error is temporary, the job can be run again.

ICK32165I TOO MANY BLOCKS IN SPECIFIED RANGE

Explanation: The total number of blocks in the specified range is greater than the maximum allowed for INSPECT processing.

System Action: Command processing ends.

Operator Response: None.

System Programmer Response: Either run the job again with a smaller range, or if necessary, save the data and use the INITIALIZE command.

ICK32166I ERROR NOT A DATA CHECK-PROCESSING TERMINATED

Explanation: An I/O error occurred that was not a data check. See the previous messages, CCW, CSW, and sense information to determine the cause of the error.

System Action: The command ends. ICKDSF continues with the next command.

Operator Response: None.

System Programmer Response: Examine the previous messages, CCW, CSW, and sense information to determine the cause of the I/O error.

ICK32167I ALTERNATE TRACK CANNOT BE ASSIGNED FOR TRACK CCHH=X'cccc hhhh'

Explanation: The INSPECT command to unconditionally assign alternate tracks found no alternate track available for X'cccc hhhh'

No assignment for this track has taken place.

System Action: Command processing ends.

Operator Response: None.

System Programmer Response: Available alternate tracks are depleted.

To unconditionally assign tracks:

1. Issue INSPECT with RECLAIM for tracks that already have alternates assigned to them.
2. If any tracks can be reclaimed, run the job again to assign an unconditional alternate to this track.

Note: When MAP is specified, a map is produced at the end of INSPECT processing. The map contains the tracks that currently have alternate tracks assigned.

If MAP is not specified, run INSPECT NOCHECK NOASSIGN MAP TRACKS(xxxx,xxxx) for any track to produce a map.

ICK32170I - CONTINUE DATA EXISTS FOR THIS VOLUME - RUN INITIALIZE

Explanation: A previous INIT job did not complete for this INSPECT job.

For CKD devices, there is probably a track on the volume that cannot be used by the operating system. The volume label and the VTOC have not been written on the volume.

System Action: Command processing ends.

Operator Response: None.

System Programmer Response: Run an INIT at the minimal level or higher before running this INSPECT job again.

ICK32171I PREVIOUS INSTALL OR REVAL COMMAND DID NOT COMPLETE

Explanation: An INSTALL/REVAL command did not complete and the volume has been left in an unusable state. Current command processing will be inhibited until the condition is corrected.

Messages received at the output printer

System Action: Command processing ends.

Operator Response: None.

System Programmer Response: Issue a command that ensures the device is returned to a usable condition (for example, INSTALL, medial initialization, or REVAL).

ICK32175I UNABLE TO SET/RESET MODE

Explanation: During INSTALL command processing, an I/O error occurred while switching the device to 3390 mode or 3380 track compatibility mode.

System Action: Command processing ends.

Operator Response: None.

System Programmer Response: Examine the CSW, CCW, and sense information in the previous message to determine the cause of the error.

ICK32176I DATA CHECK THRESHOLD EXCEEDED ON FOLLOWING HEAD(S):

Explanation: The data error rate on one or more heads exceeded the data check error rate threshold criterion for the device.

The message prints heads in error.

System Action: The command ends. ICKDSF continues with the next command.

Operator Response: None.

System Programmer Response: Take action appropriate to your installation's procedures for handling the suspected equipment problems. If the problem cannot be determined, contact your IBM service representative.

ICK32177I DATA SETS EXIST ON DFSMS MANAGED VOLUME

Explanation: An online INIT on a volume to be initialized as a Data Facility Storage Management Subsystem (DFSMS) managed volume has been issued. There are data sets on the volume.

System Action: Command processing ends.

Operator Response: None.

System Programmer Response: Either delete the data sets from the volume or perform the INIT offline.

ICK32178I UNRECOVERABLE TRACK ON CE/SA CYLINDER, CCHH = X'xxxx xxxx'

Explanation: All attempts to write the home address and/or record zero on the indicated track failed.

System Action: Command processing ends.

Operator Response: None.

System Programmer Response: Examine the failing, CCW, CSW, and sense information to determine the cause of the error.

Contact the IBM hardware service representative to aid in resolving the problem.

ICK32180I DIAGNOSTIC INFORMATION FOR CHECKPOINT DATA:

Explanation: The checkpoint process failed. Diagnostic information is printed.

System Action: See the other associated messages.

Operator Response: None.

System Programmer Response: None.

ICK32181I UNABLE TO DETERMINE CHECKPOINT INFORMATION, FUNCTION TERMINATED

Explanation: Either an I/O error or a subsystem failure prevents identification of checkpoint data.

System Action: The associated diagnostic information is printed and the function ends.

Operator Response: None.

System Programmer Response: Contact your IBM service representative.

ICK32182I UNABLE TO UPDATE CHECKPOINT INFORMATION, FUNCTION TERMINATED

Explanation: Checkpoint data cannot be updated because of either an I/O error or subsystem failure.

System Action: The associated diagnostic information is printed and the function ends.

Operator Response: None.

System Programmer Response: Contact your IBM service representative.

ICK32190I CURRENT PROCESS TERMINATED DUE TO CHECKPOINT DATA

Explanation: See the checkpoint data described in ICK12180. The current process cannot continue without completion of the previous ICKDSF function.

System Action: Command processing ends.

Operator Response: None.

System Programmer Response: Run the command again as described in ICK12180I.

ICK32203I INSUFFICIENT STORAGE AVAILABLE FOR DATA SET ENQUEUE -- FUNCTION TERMINATED

Explanation: GETMAIN failed while obtaining the storage necessary to process data set enqueue procedures.

Because TOLERATE(ENQFAIL) was not specified, command processing ends.

System Action: INSPECT command processing ends.

Operator Response: None.

System Programmer Response: Run the job again either providing more storage, or specifying TOLERATE(ENQFAIL), or specifying fewer total tracks.

Messages received at the output printer

ICK32310I FUNCTION NOT SUPPORTED FOR READ ONLY
MINIDISK

Explanation: The ICKDSF command function you requested cannot be performed on a read only minidisk.

System Action: The command ends. ICKDSF continues with the next command.

Operator Response: none.

System Programmer Response: none.

ICK32315I DEVICE ADDRESS COULD NOT BE FOUND TO
ESTABLISH A LINK

Explanation: ICKDSF must obtain an unused virtual address to establish a full-pack overlay link for the minidisk media maintenance function.

Address range 05FF to 0000 in descending order was checked and no address was found available.

System Action: The command ends. ICKDSF continues with the next command.

Operator Response: None.

System Programmer Response: use CP DETACH to detach an unused virtual address, then issue the command again.

ICK32316I SYSTEM SUPPORT IS UNAVAILABLE FOR
SPECIFIED FUNCTION

Explanation: The required system support code from VM for the CMS version of ICKDSF does not exist.

System Action: The command ends.

Operator Response: None.

System Programmer Response: Check with your installation to determine if support is provided for your environment. If support is available, ensure it is installed before running the job.

ICK32317I ccuu DEVICE DOES NOT EXIST

Explanation: The device address you specified does not exist.

System Action: The command ends.

Operator Response: None.

System Programmer Response: Provide the correct address and run the job again.

ICK32318I CCUU UNABLE TO DETERMINE SUB-CHANNEL ID
FOR THE SPECIFIED DEVICE

Explanation: An attempt has been made to get the sub-channel ID for the device specified by *ccuu* by issuing the CMS macro, GETSID. However, no matching sub-channel ID was found.

System Action: Command processing ends. ICKDSF continues with the next command.

Operator Response: None.

System Programmer Response: None.

ICK32345I CYLINDER OR BLOCK INFORMATION IS REQUIRED
FOR THE SPECIFIED FUNCTION

Explanation: When you specify REALADDR, you must also specify the cylinder or block address.

System Action: The command ends.

Operator Response: None.

System Programmer Response: Provide a range, or specific cylinder/track/block for the command you specified.

ICK32347I REPLY "T" TO MESSAGE ICKnnnnnn HAS BEEN
ISSUED, FUNCTION TERMINATED

Explanation: ICKDSF was invoked using the invocation parameter list and CONSOLE is not the INPUT device. An assumed reply T was given to the previous ICKnnnnn message.

System Action: Command processing ends.

Operator Response: Run the job again either without invocation parameter list or specifying CONSOLE as INPUT device.

System Programmer Response: None.

ICK32364I CAN NOT OBTAIN ACCESS TO DEVICE ccuu

RC= nnnn
failing reason

Explanation: The DIAGNOSE E4 FCN 00, 01, 02 or 03 enables ICKDSF to:

- Obtain minidisk information, or
- To establish a full-pack overlay link to the specified user's minidisk or real device defined in the system.

The operation failed with the CP return code RC=nnnn. The *failing reason* line of the message gives some common reasons for the failure.

RC=0005

USER DOES NOT HAVE DIRECTORY OR RACF
AUTHORIZATION

To perform this function, you must have appropriate options (such as DEVMAINT, LNKEExclu) specified on your OPTION directory control statement and if RACF/VM is installed, the appropriate RACF PERMITS executed on your behalf.

Note: LNKEExclu is required.

RC=0101

- VIRTUAL DEVICE ADDRESS INVALID -

The device number does not identify a device in the current I/O configuration of the virtual machine specified by the input userid.

RC=0102

VIRTUAL DEVICE ADDRESS IS NOT ACCEPTED.
IT DOES NOT REPRESENT A MINIDISK

RC=0103

REAL VOLUME WHICH CONTAINS THE MINI DISK
IS NOT MOUNTED

Messages received at the output printer

RC=0200
USERID NOT DEFINED TO THE SYSTEM

RC=0201
DEVICE DOES NOT IDENTIFY A VIRTUAL DEVICE
IN THE DIRECTORY FOR THE INPUT USERID

RC=0202
VIRTUAL DEVICE ADDRESS IS NOT ACCEPTED IT
DOES NOT REPRESENT A MINIDISK

RC=0203
REAL VOLUME WHICH CONTAINS THE MINI DISK
IS NOT MOUNTED

RC=0204
THE DIRECTORY BLOCKS COULD NOT BE
ACCESSED BECAUSE OF SYSTEM ERROR

RC=0300
USERID NOT DEFINED TO THE SYSTEM

RC=0301
DEVICE DOES NOT IDENTIFY A VIRTUAL DEVICE
IN THE DIRECTORY FOR THE INPUT USERID

RC=0302
VIRTUAL DEVICE ADDRESS IS NOT ACCEPTED IT
DOES NOT REPRESENT A MINIDISK

RC=0303
REAL VOLUME WHICH CONTAINS THE MINI DISK
IS NOT MOUNTED

RC=0304
THE DIRECTORY BLOCKS COULD NOT BE
ACCESSED BECAUSE OF SYSTEM ERROR

RC=0305
A FULL PACK OVERLAY ALREADY EXISTS

Only one full pack overlay is allowed on a volume at
any time.

RC=0306
THE FULL PACK OVERLAY REQUEST INCLUDES
CP PAGING, SPOOLING, DIRECTORY, T-DISK OR
DUMP AREAS

RC=0307
THE FULL PACK OVERLAY REQUEST FAILED
BECAUSE THE MINIDISK HAS EXISTING LINKS
TO IT USERID = NNNNNN

The target minidisk has a write link to it. Remove the
LINK and run the job again.

USERID = NNNNNN specifies the user who has the
existing link to the volume.

RC=0402
INPUT REAL DEVICE IS NOT ACCEPTED
BECAUSE IT IDENTIFIES A NON DASD DEVICE

RC=0403
DEVICE OFFLINE OR NOT MOUNTED

This return code can also be received if the device is
a FREE device (not assigned to the system). In this
case, ATTACH the device to the system.

RC=0405
A FULL PACK OVERLAY ALREADY EXISTS

Only one full pack overlay is allowed on a volume at
any time.

RC=0406
THE FULL PACK OVERLAY REQUEST INCLUDES
CP PAGING, SPOOLING, DIRECTORY, T-DISK OR
DUMP AREAS

RC=0407
THE FULL PACK OVERLAY REQUEST FAILED
BECAUSE THE MINIDISK HAS EXISTING LINKS
TO IT USERID = NNNNNN

The target minidisk has a write link to it. Remove the
LINK and run the job again. USERID = NNNNNN
specifies the user who has the existing link to the
volume.

RC=0410
CYLINDER OR BLOCK NUMBER INVALID

CP has determined the cylinder or block number is
not valid. If the cylinder or block is valid for the
device type, check the CP directory to make sure
this device type is correctly defined.

System Action: The command ends. ICKDSF continues with
the next command.

Operator Response: Correct the problem and run the job
again.

System Programmer Response: Refer to *CP Programming
Services*, for more information concerning the Diagnose E4
command and the corresponding return code.

ICK33000I volser {CYL|PAGE} ZERO NOT IN
CP{370|XA|ESA} FORMAT

Explanation: The requested function requires a properly
formatted volume. The volume is in a format that is not
supported for this operating system.

System Action: Command processing ends.

Operator Response: Use CPVOLUME command to reformat
the volume.

System Programmer Response: None.

ICK33001I volser {CYL|PAGE} ZERO NOT IN CP FORMAT

Explanation: The requested function requires a formatted
unit. The unit is not formatted.

System Action: Command processing ends.

Operator Response: Format the unit.

System Programmer Response: None.

ICK33005I volser {CYL|PAGE} ZERO NOT IN AIX/ESA
FORMAT

Explanation: The requested function requires a unit that is
the unit to be formatted for an AIX/ESA environment. The unit
is not formatted for an AIX/ESA environment.

System Action: Command processing ends.

Operator Response: Format the unit.

System Programmer Response: None.

Messages received at the output printer

ICK33010I SPECIFIED RANGE(xxxx,yyyy); START CYLINDER HIGHER THAN END CYLINDER

Explanation: Either a range or allocation statement contained a start value higher than the end value.

System Action:

- If the statement in error is RANGE, command processing ends.
- If the statement in error is an allocation statement, the allocation map will not be updated.

Operator Response: Correct the statement in error.

System Programmer Response: None.

ICK33020I SPECIFIED RANGE(xxxx,yyyy); START CYLINDER HIGHER THAN VOLUME END (nnnn)

Explanation: A range or allocation statement contained an ending value(yyyy) higher than the highest cylinder/page(nnnn) on the unit.

System Action:

- If the statement in error is RANGE, command processing ends.
- If the statement in error is an allocation statement, the allocation map will not be updated.

Operator Response: Correct the statement in error.

System Programmer Response: None.

ICK33030I ALLOCATION MAP IS INVALID

Explanation: The allocation map contains data that is logically inconsistent.

System Action: The allocation map will not be updated and command processing ends.

Operator Response: The allocation map must be recreated by running the CPVOLUME FORMAT function with a starting range of 0.

System Programmer Response: None.

ICK33040I ALLOCATION MAP IS FULL

Explanation: The allocation map has reached the upper limit of 85 allocation ranges.

System Action: The allocation map is not updated and command processing ends.

Operator Response: Review the allocation map for the unit. Reduce fragmentation by combining or eliminating allocation ranges.

System Programmer Response: None.

ICK33050I ALLOCATION TYPE "type" IS NOT SUPPORTED IN {VM370|VMXA|VMESA;} MODE

Explanation: This operating system does not support the specified allocation type. Refer to the CPVOLUME command for valid allocation types.

System Action: The allocation map will not be updated, and command processing ends.

Operator Response: Change the allocation type.

System Programmer Response: None.

ICK33060I ALLOCATION TYPE "type" IS NOT SUPPORTED ON 3880-xx

Explanation: The specified allocation type is not supported for either 3880-11 or 3880-21 paging subsystems. The only supported allocation types are PAGE and PERM.

System Action: The allocation map is not updated.

Operator Response: Either change the allocation type, or use a different device type.

System Programmer Response: None.

ICK33070I ALLOCATION MAP FORMAT DOES NOT ALLOW LIST/EXAMINATION

Explanation: The existing ALLOCATION MAP format of this device is not in the required format for the specified device type.

System Action: Command processing ends.

Operator Response: None.

System Programmer Response: Run either CPVOLUME ALLOCATE without specifying TYPE to convert the existing allocation map to the required format, or run CPVOLUME FORMAT specifying the necessary parameters.

ICK33080I PREVIOUS cmdtype COMMAND DID NOT COMPLETE

Explanation: Either an INITIALIZE, INSTALL, INSPECT or REVAL command was interrupted and did not complete.

System Action: Processing is prohibited.

Operator Response: Complete the interrupted command.

System Programmer Response: None.

ICK33090I DEVICE MUST BE PROCESSED IN VM/370 OR VM/ESA MODE.

Explanation: CPVOLUME command formerly formatted FBA volumes for use on VM/370 and VM/ESA systems. Formatting for VM/370 is no longer supported. A volume formerly formatted in VM/370 mode must be reformatted for use on a VM/ESA or z/VM system. A volume formerly formatted in VM/ESA mode can be used on a VM/ESA or z/VM system.

System Action: The command ends.

Operator Response: None.

System Programmer Response: Run the job again.

ICK33091I DEVICE MUST BE PROCESSED IN VM/370 MODE

Explanation: The CPVOLUME command does not support the specified device type in this operating system.

System Action: Command processing ends.

Operator Response: None.

System Programmer Response: None.

Messages received at the output printer

ICK33095I **DEVICE MUST BE PROCESSED IN VM/ESA MODE**

Explanation: The CPVOLUME command supports the specified device type only in ESA mode.

System Action: Command processing ends.

Operator Response: None.

System Programmer Response: None.

ICK33100I **nnnn CYLINDER MINIDISK IS INVALID**

Explanation: *nnnn* exceeds the maximum number of cylinders that the allocation map allows. The capacity of the allocation map is 4096.

System Action: The command ends. ICKDSF continues with the next command.

Operator Response: None.

System Programmer Response: Correct the value of the cylinders for the device in the MIMIC(MINI) parameter, and run the job again.

ICK33101I **CONCURRENT MEDIA MAINTENANCE FUNCTION CANCELLED**

Explanation: An error caused cancellation of concurrent media maintenance processing. Examine the previous message to determine the error.

System Action: Command processing ends.

Operator Response: None.

System Programmer Response: See previous message issued.

ICK33102I **CONCURRENT MEDIA MAINTENANCE FUNCTION CAN NOT BE ACTIVATED**

Explanation: The concurrent media maintenance function can not be activated because either the required storage control microcode support does not exist or because a failure occurred.

System Action: Command processing ends.

Operator Response: None.

System Programmer Response: Contact your IBM hardware service representative.

ICK33103I **UNABLE TO RESET MEDIA MAINTENANCE RESERVE STATE**

Explanation: The device cannot be reset to a normal state when:

- ICKDSF is re-invoked
- The concurrent media maintenance function cannot be continued because an I/O error occurred while the device was being reset from a media maintenance reserve state
- The media maintenance reserve state cannot be reset after an INSTALL command

System Action: Command processing ends. The device is left in the media reserve state. All future I/O to the device will result an I/O error until the problem is solved.

Operator Response: None.

System Programmer Response: Contact your IBM hardware service representative. Then run the job again after the problem is resolved.

ICK33104I **DEVICE ccuu INACCESSIBLE**

Explanation: The device is placed in the media maintenance reserve state due to an I/O error while: 1) restoring the user data, or 2) resetting the device from a media maintenance function to a normal state. The concurrent media maintenance function cannot continue and the device cannot be accessed by the user program.

System Action: Command processing ends.

Operator Response: None.

System Programmer Response: Contact your IBM hardware service representative.

ICK33105I **UNABLE TO RECOVER CHECKPOINT FAILURE FOR ANOTHER CPU**

Explanation: The current INSPECT process has identified checkpoint data from another processor. Since the FORCE parameter is not specified, the current INSPECT process cannot recover the failure.

System Action: The current INSPECT process ends.

Operator Response: None.

System Programmer Response: If there is no other processor working on the device, specify the FORCE parameter and run the job again.

ICK33106I **VOLSER ALREADY EXISTS, VERIFY/NOVERIFY MUST BE SPECIFIED**

Explanation: An INSTALL command was performed to a volume which has a volume serial. Either use the VERIFY parameter specifying the *volser*, or specify NOVERIFY to perform an INSTALL.

Remember that after an INSTALL the volume is left in an uninitialized state and is unusable in either an MVS, VM, or VSE environment.

System Action: Command processing ends.

Operator Response: None.

System Programmer Response: Specify either the VERIFY or NOVERIFY parameter.

ICK33110I **FORMAT TERMINATED-DEVICE MODE DOES NOT ALLOW INSPECTION**

Explanation: A device error while formatting requires either the CKD track or FBA block to be inspected. CPVOLUME or AIXVOL cannot invoke INSPECT for minidisk errors.

System Action: Formatting ends.

Operator Response: Refer to "CMS version minidisk support" on page 181 (CKD) or "CMS version minidisk support" on page 331 (FBA) for a description of how to INSPECT a minidisk track or block using the USERID and REALADDR parameters. After the CKD track or FBA block has been

Messages received at the output printer

successfully inspected, restart the format operation.

System Programmer Response: None.

ICK33113I NOFILLER IS NOT ALLOWED IN 370 MODE

Explanation: NOFILLER can only be specified if CPVOLUME is operating in XA or ESA mode.

System Action: Command processing ends.

Operator Response: None.

System Programmer Response: Reissue the CPVOLUME FORMAT command without the NOFILLER command, or specify XA or ESA mode.

ICK33114I FORMATTING ON PARTIAL VOLUME IS NOT ALLOWED

Explanation: Formatting a partial volume is not allowed if:

- the current specification is NOFILLER and the volume was previously CPVOLUME formatted with filler records, or
- the current specification is FILLER, and the volume was previously CPVOLUME formatted without filler records.

System Action: The command ends. ICKDSF continues with the next command.

Operator Response: None.

System Programmer Response: Reissue the CPVOLUME FORMAT command without the RANGE parameter.

ICK33120I "type" IS AN INVALID ALLOCATION TYPE

Explanation: The specified allocation type is unknown for the CPVOLUME command.

System Action: The command ends. ICKDSF continues with the next command.

Operator Response: None.

System Programmer Response: Correct the allocation type, and run the job again.

ICK34000I PERFORM SUBSYSTEM FUNCTION FAILED

Explanation: There is a failed completion status from the subsystem for a previously issued PSF command.

System Action: The PSF command order and the SIM information for this error are printed. The function ends.

Operator Response: None.

System Programmer Response: Contact your IBM service representative.

ICK34001I UNDEFINED COMPLETION STATUS CODE IS DETECTED

Explanation: The returned completion status from the subsystem for a previously issued PSF command is undefined.

System Action: The previously issued PSF command and its associated Read Subsystem Data are printed. The function ends.

Operator Response: None.

System Programmer Response: Contact your IBM service representative.

ICK34002I INVALID EXCEPTION STATUS CODE OR INFORMATION IS DETECTED

Explanation: The returned exception status or information from the subsystem for a previously issued PSF command is not valid.

System Action: The system prints previously issued PSF command and its associated Read Subsystem Data. The function is ends.

Operator Response: None.

System Programmer Response: Contact your IBM service representative.

ICK34003I UNABLE TO DETERMINE DEVICE/TRACK STATUS FOR MEDIA MAINTENANCE

Explanation: ICKDSF is unable to determine the device, track status, or the media maintenance characteristics for the device because of a failure of a PSF command.

Inspect either the previous I/O error message, or the subsequent Read Subsystem Data to identify the error.

System Action: Command processing ends.

Operator Response: None.

System Programmer Response: Contact your IBM service representative.

ICK34005I NO MORE ALTERNATE LOCATION AVAILABLE

Explanation: The subsystem could not either assign an alternate location prior to a surface checking function or permanently flag a primary track defective.

The system prints the Read Subsystem Data.

System Action: Command processing ends.

Operator Response: None.

System Programmer Response: Contact your IBM service representative.

ICK34007I UNABLE TO RESTORE PRIMARY TRACK X'cccc hhhh' FROM ALTERNATE LOCATION

Explanation: The subsystem cannot restore the data from an alternate location to the specified primary track. See the error description from the previous messages.

System Action: Command processing ends.

Operator Response: None.

System Programmer Response: Contact your IBM service representative.

ICK34010I UNABLE TO ASSIGN ALTERNATE LOCATION FOR TRACK X'cccc hhhh'

Explanation: The subsystem is unable to assign an alternate location for the specified primary track. Inspect either the

Messages received at the output printer

previous error message, or the subsequent Read Subsystem Data to identify the error.

System Action: Command processing ends.

Operator Response: None.

System Programmer Response: Contact your IBM service representative.

ICK34014I DRIVE TEST FAILED EXCEPTION STATUS DETECTED

Explanation: A *failed exception status* from the drive test occurred during the device test.

System Action: The system prints the diagnostic information from the Read Subsystem Data and the device SIM for this error.

System Action: Command processing ends.

Operator Response: None.

System Programmer Response: Contact your IBM service representative.

ICK34015I ERROR COUNT EXCEEDED THRESHOLD

Explanation: The maximum allowable error count has been reached for the specified ICKDSF function. Identify the error from previous error messages.

System Action: Command processing ends.

Operator Response: None.

System Programmer Response: Contact your IBM service representative.

ICK34016I TRACK X'cccc hhhh' NOT FLAGGED DEFECTIVE

Explanation: An alternate track was assigned when ICKDSF performed a previous surface checking PSF command. Therefore, ICKDSF expected the specified track to be defective.

The track is not defective.

System Action: The ICKDSF process customarily must ensure that the primary track is assigned to an alternate before issuing the surface checking PSF command.

However, if this error occurs, there may be either an ICKDSF logic error or subsystem error.

System Action: Command processing ends.

Operator Response: None.

System Programmer Response: Contact your IBM service representative.

ICK34017I UNRECOVERABLE TRACK HEADER FAILURE DETECTED FOR TRACK X'cccc hhhh'

Explanation: The header for each track includes a home address and record 0. These are managed by the subsystem and are not accessible to the host. The subsystem also performs recovery from a failure.

A track header failure condition is a severe error that requires service to repair/replace the device.

(It is not necessary to either save the user data for this particular PSF command or use the temporary alternate pointer facility.)

System Action: Command processing ends and the system issues a SIM.

Operator Response: None.

System Programmer Response: Contact your IBM service representative.

Process the ICKDSF function again after service.

ICK34018I PRIMARY TRACK HEADER FAILURE DETECTED FOR TRACK X'cccc hhhh'

Explanation: The header for each track includes a home address and record 0. These are managed by the subsystem and are not accessible to the host. The subsystem also performs recovery from a failure.

A track header failure condition is a severe error that requires service to repair/replace the device.

If the track header failure occurs either while or after an alternate location is assigned, the user data is not necessarily lost. The device can be used, and the host can access data with a temporary alternate pointer facility. (This temporary alternate pointer facility is reset after the service action is taken.)

System Action: Command processing ends and the system issues a SIM.

Operator Response: None.

System Programmer Response: Contact your IBM service representative. Process the ICKDSF function again after the service action.

ICK34019I EXISTING TRACK HEADER FAILURE (ANOTHER TRACK) DETECTED

Explanation: A track header failure condition is detected during a PSF command on another track because service is required. The subsystem cannot accept further commands that require different temporary alternate facilities.

System Action: Command processing ends.

Operator Response: None.

System Programmer Response: Contact your IBM service representative.

ICK34020I EXISTING TRACK HEADER FAILURE (THIS TRACK) DETECTED ON X'cccc hhhh'.

Explanation: A track header failure condition has been detected during a PSF command because service for a previous head failure is required.

System Action: Command processing ends.

Operator Response: None.

System Programmer Response: Contact your IBM service representative.

Messages received at the output printer

ICK34021I INVALID ALTERNATE LOCATION ASSIGNMENT
DETECTED FOR TRACK X'cccc hhhh'

Explanation: An alternate assignment exception status is not valid for the specified track.

System Action:

- If the current command is ANALYZE, INIT or INSTALL, the error is reported. ICKDSF performs the necessary recovery actions and the function ends.
- If INSPECT PRESERVE is the current command, issue the command again specifying the NOPRESERVE option.

Operator Response: None.

System Programmer Response: Contact your IBM service representative.

ICK34022I I/O ERROR OCCURRED FOR PERFORM SUBSYSTEM
FUNCTION

Explanation: There was an I/O error while the subsystem function (PSF) command was processing. The system prints CCW, CSW and sense information.

System Action: Command processing ends.

Operator Response: None.

System Programmer Response: Contact your IBM service representative.

ICK34023I INVALID READ SUBSYSTEM DATA MESSAGE IS
DETECTED

Explanation: A PSF command has detected a response from a Read Subsystem Data that is not valid. See message ICK04010I for more diagnostic information.

System Action: Command processing ends.

Operator Response: None.

System Programmer Response: Contact your IBM service representative.

ICK34024I OUTSTANDING DEVICE SIM STILL EXISTS, SIM
ID=X'nn'

Explanation: The specified device has an open SIM (open, pending, or suppress presentation) status. The system prints SIM information. See message ICK10711I.

System Action: Command processing ends.

Operator Response: None.

System Programmer Response: Contact your IBM service representative.

ICK34030I PPRCOPY OPERATION FAILED:
FORMAT/MESSAGE=X'xx', REASON CODE=X'xx'

Explanation: The storage control detected an error in the subsystem involving a duplex volume operation, but not specifically a PPRC function. The message format and number from byte 7 of the sense information is given, xx is the reason code from byte 8 of the sense information. If the sense information in message ICK10710I contains all zeros the FORMAT/MESSAGE and REASON CODE may be ignored.

System Action: Command processing ends.

Operator Response: None.

System Programmer Response: Please refer to 3990 Storage Control Reference for Model 6 for sense Format 0 Message F, reason code n. Correct the error and retry the command.

ICK34032I ESTPAIR FAILED - NVS SPACE NOT AVAILABLE
FOR BIT MAP

Explanation: Insufficient non-volatile storage space was available for the application site storage control to create the changed track bit map for the volume pair.

System Action: Command processing ends.

Operator Response: None.

System Programmer Response: Refer to the IBM 3990 Operations and Recovery Guide for pinned data procedures. Correct the condition and retry the command.

ICK34033I ESTPAIR FAILED - DEVICES NOT IN SUSPEND
MODE

Explanation: The devices were not in the suspend mode as expected by the command. The ESTPAIR RESYNC option is only valid if the devices are in SUSPEND mode.

System Action: Command processing ends.

Operator Response: None.

System Programmer Response: Use the PPRCOPY QUERY command to verify the status of the pair, then use the ESTPAIR command with the COPY or NOCOPY option.

ICK34034I ESTPAIR FAILED - DEVICES NOT IN SIMPLEX
MODE

Explanation: The devices were not in simplex mode as expected by the command.

System Action: Command processing ends.

Operator Response: None.

System Programmer Response: Issue the PPRCOPY QUERY command to verify the status of the devices (pending, duplex, or suspended). If status is suspended, then use ESTPAIR command with the RESYNC option.

ICK34035I COMMAND FAILED - SECONDARY NOT IN CORRECT
STATE

Explanation: The secondary volume is actively being used by this or another attached host.

System Action: Command processing ends.

Operator Response: None.

System Programmer Response: Quiesce activity on the target secondary device (vary it offline to all attached hosts). The target secondary device may not be actively used or be a member of a 3990 duplex pair.

Messages received at the output printer

ICK34036I ESTPAIR FAILED - PINNED DATA ON SUSPENDED VOLUME

Explanation: The storage control detected pinned data for a volume and halted the command. An PPRCOPY ESTPAIR command was issued to a suspended volume that contains pinned data.

System Action: Command processing ends.

Operator Response: None.

System Programmer Response: Refer to the IBM 3990 Operations and Recovery Guide for pinned data procedures. Correct the condition and retry the command.

ICK34038I SUSPEND OPERATION REJECTED - SUSPEND STATE EXISTED

Explanation: An attempt to suspend a PPRC copy was made to a pair that is already suspended.

System Action: Command processing ends.

Operator Response: None.

System Programmer Response: Execute the PPRCOPY QUERY command to verify the PPRC volume or path status.

ICK34039I ATTEMPTED A DUPLEX OPERATION ON A SIMPLEX VOLUME

Explanation: A PPRC operation (DELPAIR, SUSPEND or RECOVER) was directed to a volume that is not a member of a PPRC pair.

System Action: Command processing ends.

Operator Response: None.

System Programmer Response: Issue the PPRCOPY QUERY command to determine the volume status.

ICK34040I SUSPEND PRIMARY FAILED - DUPLEX OR PPRC PENDING

Explanation: A suspend operation was attempted to a volume which had a duplex or PPRC operation pending.

System Action: Command processing ends.

Operator Response: None.

System Programmer Response: Issue the PPRCOPY QUERY command to verify that the volume is in pending status. Reissue the command when the device is no longer in pending status.

ICK34041I ESTPAIR FAILED - CE MODE OR UNDETERMINED

Explanation: The storage control was in CE mode or the 'FC' state (Sense Format F, Message C), while attempting to establish a PPRC pair.

System Action: Command processing ends.

Operator Response: None.

System Programmer Response: Take the storage control out of CE mode or correct the 'FC' condition, then reissue the command.

ICK34042I DELPAIR FAILED - DASD FAST WRITE PENDING

Explanation: The storage control was unable to terminate a pair while DASD Fast Write was pending.

System Action: Command processing ends.

Operator Response: None.

System Programmer Response: Issue the DEVSERV command (MVS) or Q DASDFW (VM) or CACHE UNIT=ccuu,STATUS (VSE) to determine the DASD Fast Write condition. Reissue the command when the DFW pending condition clears. The DFW pending condition will not be cleared if pinned data exists. (To determine if pinned data exists for VM, issue the Q PINNED command.)

ICK34043I PPRCOPY FAILED - SUBSYSTEM INSTALLING MICROCODE

Explanation: The storage control was unable to terminate a pair while DASD Fast Write was pending.

System Action: Command processing ends.

Operator Response: None.

System Programmer Response: Allow the microcode install operation to complete, then reissue the command.

ICK34044I ESTPATH FAILED - WOULD EXCEED UNITS/PATHS LIMITS

Explanation: The command would exceed the maximum number of secondaries, or the number of paths to a specific storage control.

System Action: Command processing ends.

Operator Response: None.

System Programmer Response: Issue the PPRCOPY QUERY command with the PATHS option to determine the established recovery site storage controls and paths for each.

ICK34046I NO MATCH IN CU FOR SSID OR SER# OF PRIMARY OR SECONDARY

Explanation: The storage control could not resolve the parameters in the command input to match a subsystem ID or serial number.

System Action: Command processing ends.

Operator Response: None.

System Programmer Response: Verify that the command input correctly identifies the primary and secondary information by checking with configuration maps and logs. The PPRCOPY QUERY command may also assist in this verification.

ICK34047I CONDITIONS AT SECONDARY CU PROHIBIT PROPER OPERATION

Explanation: A condition at the recovery site storage control was detected which prohibits initiation of the operation. One of the following conditions exists on the recovery site 3990.

- Cache is not active for the subsystem
- Cache is not active for the device
- NVS is not active for subsystem

Messages received at the output printer

- DFW is not active for the device
- Incompatible primary and secondary device geometry.

System Action: Command processing ends.

Operator Response: None.

System Programmer Response: Issue the DEVSERV command (MVS) or Q DASD DETAILS (VM) or CACHE SUBSYS=ccuu,STATUS and CACHE UNIT=ccuu,STATUS (VSE) to determine the status of the above conditions and correct those conditions. When conditions have been corrected, reissue the command.

ICK34048I FAILED TO ESTABLISH ONE OR MORE PATHS TO SECONDARY

Explanation: The storage control did not complete establishment of all the paths specified in the PPRCOPY ESTPATH command. One or more paths failed to be established.

System Action: Command processing ends.

Operator Response: None.

System Programmer Response: Issue a PPRCOPY QUERY command, with the PATHS option, to the primary device to determine the pathing status. Refer to the data returned with the PPRCOPY QUERY command to determine the action required for status other than "established."

ICK34049I ESTPAIR FAILED - A VOLUME HAS PINNED DATA

Explanation: Either the primary or secondary volume has pinned data, preventing the establishment of the pair.

System Action: Command processing ends.

Operator Response: None.

System Programmer Response: See the *IBM 3990 Operations and Recovery Guide* for pinned data recovery procedures. Correct the condition and retry the command.

ICK34050I VOLUME IN SUSPENDED PPRC STATE

Explanation: The addressed device is in a suspended peer-to-peer remote copy state. All write commands with normal authorization indicated are rejected.

System Action: Command processing ends.

Operator Response: None.

System Programmer Response: Issue the PPRCOPY QUERY command to verify the status of the devices (pending, duplex, or suspended). There are several reasons the device could be in a suspended state as a result of having issued the PPRCOPY SUSPEND or PPRC FREEZE commands. If it is deemed appropriate to move the device out of the suspended state then:

If the suspension is the result of a FREEZE then the PPRCOPY RUN command can be issued to the device. Paths and pairs must then be reestablished.

Or

Use the ESTPAIR command with the RESYNC option.

ICK34051I ESTPAIR FAILED - SECONDARY VOLUME IS A FLASHCOPY TARGET VOLUME

Explanation: An establish peer-to-peer remote copy pair command was received and the secondary volume is a Remote FlashCopy[®] target volume.

System Action: Command processing ends.

Operator Response: None.

System Programmer Response: Ensure that the secondary target volume of the ESTPAIR command is correctly specified in the command. If so, then that target device must be taken out of the FlashCopy state, or the ESTPAIR command cannot be processed.

ICK34052I DELPATH FAILED - PPRC VOLUMES ARE STILL ACTIVE

Explanation: The DELPATH was issued while the PPRC volumes were still active.

System Action: Command processing ends.

Operator Response: None.

System Programmer Response: Issue the PPRCOPY DELPAIR command first to end the PPRC pair, then retry the command. This action assumes that you have verified status (with the PPRCOPY QUERY command), and that you are specifying the correct PPRC device.

ICK34053I UNIT DOES NOT SUPPORT PPRC OPERATIONS

Explanation: A PPRC operation was sent to a storage control which does not support the PPRC feature.

System Action: Command processing ends.

Operator Response: None.

System Programmer Response: Issue the command to a device attached to a storage control that has the PPRC licensed microcode installed.

ICK34054I PPRCOPY PRIMARY TIMED OUT ATTEMPTING TO COMMUNICATE WITH SECONDARY

Explanation: The PPRCOPY primary timed out attempting to communicate with the secondary.

System Action: The command ends. ICKDSF continues with the next command.

Operator Response: None.

System Programmer Response: Determine the cause of the error and run the job again. Assistance of a hardware service representative may be needed to determine the cause of the problem.

ICK34055I PPRCOPY FAILED - SECONDARY ADDRESS OUTSIDE OF ADDRESS RANGE

Explanation: The device or CCA specified for the PPRC secondary is outside the range of valid addresses.

System Action: The command ends. ICKDSF continues with the next command.

Messages received at the output printer

Operator Response: None.

System Programmer Response: Specify a valid device for the secondary and run the job again.

ICK34056I ESTPATH FAILED - SAME PATH SPECIFIED AS COMMAND RECEIVED ON

Explanation: The ESTABLISH PATH specified a path for a linkaddress that is the same path the command was received on from the primary host. The path can not be used for both.

System Action: The command ends. ICKDSF continues with the next command.

Operator Response: None.

System Programmer Response: Specify a different path in the linkaddress and run the job again.

ICK34057I SECONDARY DEVICE FOUND TO BE GROUPED

Explanation: The ESTABLISH PAIR was received for a secondary device that was found to be grouped. The device is assumed to be on-line.

System Action: The command ends. ICKDSF continues with the next command.

Operator Response: None.

System Programmer Response: Vary the secondary device offline, or select a device for the secondary that is offline, and run the job again. If the device is a 2105 you may use the ONLINSEC(YES) parameter if you wish to establish a pair to an online secondary device.

ICK34058I OPERATION CAN NOT BE EXECUTED ON AN ALIAS ADDRESS

Explanation: A PPRC operation specified an alias volume. The operation must specify the base volume of the PARALLEL ACCESS VOLUME.

System Action: The command ends. ICKDSF continues with the next command.

Operator Response: None.

System Programmer Response: Correct the parameters and run the job again.

ICK34061I ESTPAIR FAILED - DEVICES NOT IN SAME TRACK FORMAT

Explanation: A PPRC ESTPAIR operation attempt to establish duplex pair for devices that are not in same track format. The number of cylinders on the secondary must be equal to or greater than the number on the primary.

System Action: Command processing ends.

Operator Response: None.

System Programmer Response: Make sure the selected devices are in same track format. Reissue the command.

ICK34062I PPRCOPY COMMAND FAILED - NO ACTIVE PATH AVAILABLE

Explanation: There must be at least one active path established to the secondary control unit to complete the command. If there is no path, the command is terminated.

System Action: Command processing ends.

Operator Response: None.

System Programmer Response: Make sure at least one path is available before reissuing the command.

ICK34063I ADDRESS SPECIFIED AS THE SECONDARY IS INCORRECT

Explanation: The storage control could not resolve the secondary (target) volume's address from the parameter given in the command. The secondary address provided in the command is not valid for this PPRC pair.

System Action: Command processing ends.

Operator Response: None.

System Programmer Response: Issue PPRCOPY QUERY command to obtain the information and reissue the command.

ICK34064I CLEANUP FAILED

Explanation: The PPRCOPY ESTPATH failed. ICKDSF attempted to do cleanup by issuing a DELPATH which also failed.

System Action: Command processing ends.

Operator Response: None.

System Programmer Response: Issue PPRCOPY QUERY command to obtain the information and reissue the command.

ICK34065I PPRCOPY FAILED - SUBSYSTEM IS IN A STATE CHANGE PENDING CONDITION

Explanation: The command failed due to the Subsystem or device being in a 'state change pending' condition.

System Action: Command processing ends.

Operator Response: None.

System Programmer Response: Retry the PPRCOPY command on a periodic basis. The command should be successful as soon as the state change pending condition is cleared.

ICK34066I PPRCOPY FAILED - CACHE STORAGE IS NOT AVAILABLE

Explanation: The command requires Cache Storage and Cache Storage is not available.

System Action: Command processing ends.

Operator Response: None.

System Programmer Response: Ensure Cache storage is available and reissue the command.

Messages received at the output printer

ICK34067I PPRCOPY FAILED - DEVICE IS NOT SUSPENDED
DUPLEX

Explanation: Attempt to establish a Duplex Pair and the addressed device is not Suspended Duplex.

System Action: Command processing ends.

Operator Response: None.

System Programmer Response: Issue PPRCOPY QUERY command to obtain the path information needed for the PPRCOPY ESTPATH command, and reissue the command.

ICK34068I PPRCOPY FAILED - DEVICE IS NOT SIMPLEX OR
SECONDARY OF A DUPLEX PAIR

Explanation: Attempt to establish a Duplex Pair and the device specified is not Simplex or the secondary of the Duplex Pair.

System Action: None.

Operator Response: None.

System Programmer Response: Issue PPRCOPY QUERY command to verify the status of the device and reissue the command.

ICK34069I PPRCOPY FAILED - PRIMARY DEVICE WRITE
FAILURE

Explanation: Peer to Peer Remote Copy Suspended. Primary device write failed.

System Action: Command processing ends.

Operator Response: None.

System Programmer Response: Issue PPRCOPY QUERY command to verify the status of the device and reissue the command.

ICK34070I PPRCOPY FAILED - SECONDARY SUBSYSTEM
FAILURE

Explanation: Peer to Peer Remote Copy Suspended due to a Secondary Subsystem failure.

System Action: Command processing ends.

Operator Response: None.

System Programmer Response: Verify/correct the status of the secondary subsystem and reissue the command.

ICK34071I PPRCOPY FAILED - COMMUNICATIONS WITH THE
SECONDARY DEVICE FAILURE

Explanation: Peer to Peer Remote Copy Suspended. Communications with the secondary device failed.

System Action: Command processing ends.

Operator Response: None.

System Programmer Response: Issue PPRCOPY QUERY command to verify the status of the secondary device and reissue the command.

ICK34072I PPRCOPY FAILED - CRITICAL VOLUME STATE,
ALL WRITES WILL FAIL

Explanation: Peer to Peer Remote Copy Suspended. Critical volume state, all writes will be failed until problem is fixed and the copy is reestablished.

System Action: Command processing ends.

Operator Response: None.

System Programmer Response: Issue PPRCOPY QUERY command to verify the status of the device and reissue the command.

ICK34073I PPRCOPY FAILED - NOT READY DEVICE,
INTERVENTION REQUIRED

Explanation: Peer to Peer Remote Copy Suspended. Device is not ready. Intervention is required for Peer to Peer Remote Copy Secondary.

System Action: Command processing ends.

Operator Response: None.

System Programmer Response: Get the device ready and reissue the command.

ICK34074I UNABLE TO DETERMINE COPY COMPLETION STATUS

Explanation: An I/O error occurred while checking the copy completion status. The PPRCOPY ESTPAIR function may not have completed successfully.

System Action: Command processing ends.

Operator Response: None.

System Programmer Response: Issue a PPRCOPY QUERY command to determine the status of the device. The device may still be in PENDING mode or in SUSPEND(x) state.

ICK34075I ESTPAIR FAILED TO COMPLETE COPY FROM
PRIMARY VOLUME

Explanation: A PPRCOPY ESTPAIR command with the MSGREQ parameter has failed to complete. The storage subsystem detected errors. The copy is not complete and the volume pair is not in duplex state.

System Action: Command processing ends.

Operator Response: None.

System Programmer Response: Look for any console messages issued and refer to the IBM 3990 Storage Control Reference for Model 6 for information related to returned sense data. Notify your service representative of any hardware error conditions.

ICK34076I PPRCOPY FAILED - NON-VOLATILE STORAGE IS
NOT AVAILABLE

Explanation: The command requires Non-volatile Storage and Non-volatile Storage is not available.

System Action: Command processing ends.

Operator Response: None.

Messages received at the output printer

System Programmer Response: Ensure Non-volatile storage is available and reissue the command.

ICK34077I PRIMARY VOLUME INFORMATION NOT CORRECT FOR THIS SECONDARY

Explanation: For PPRC Failover mode, the parameters that identify the primary are not correct for the device associated with this secondary.

System Action: Command processing ends.

Operator Response: None.

System Programmer Response: Correct the parameters and run the job again.

ICK34078I VOLUME IS NOT A PPRC SECONDARY IN THE PROPER STATE

Explanation: For PPRC Failover mode, the volume must be a secondary in full duplex or suspended state.

System Action: Command processing ends.

Operator Response: None.

System Programmer Response: Ensure the command is issued to the correct volume in the proper state.

ICK34079I VOLUME INFORMATION NOT CORRECT FOR ORIGINAL PRIMARY

Explanation: For PPRC Failback mode, the parameters that identify the original primary are not correct for the device associated with this volume.

System Action: Command processing ends.

Operator Response: None.

System Programmer Response: Correct the parameters and run the job again.

ICK34080I VOLUME IS NOT A PPRC PRIMARY IN SUSPENDED STATE

Explanation: For PPRC Failback mode, the volume must be a primary in suspended state.

System Action: Command processing ends.

Operator Response: None.

System Programmer Response: Ensure the command is issued to the correct volume in the proper state.

ICK34081I AN ESTABLISH PPRC CMD ATTEMPTED AN INVALID TRANSITION BETWEEN MODES

Explanation: An attempt is being made to go to PPRC Extended Distance mode, but the pair is in the wrong state to transition to PPRC Extended Distance mode. The only valid transition to PPRC Extended Distance mode is from a state of suspension.

System Action: Command processing ends.

Operator Response: None.

System Programmer Response: Ensure that you are issuing

the command for the correct volume, and that the volume is in the correct state.

ICK34082I A COMMAND WAS RECEIVED THAT IS NOT VALID FOR THIS PPRC STATE

Explanation: A command was received that conflicts with an established Peer-to-Peer Remote Copy state for the device.

System Action: Command processing continues.

Operator Response: None.

System Programmer Response: Ensure that you are issuing the command for the correct volume, and that the volume is in the correct state.

ICK34083I ESTPAIR FAILED - SOURCE AND DESTINATION PORTS FOR PPRC PATH OVER FCP NOT UNIQUE

Explanation: The source and destination ports for a PPRC path over FCP must be unique. Any single port cannot be used as both source and destination.

System Action: Processing stops.

Operator Response: None.

System Programmer Response: Correct the SAID specification in the FCPPATHS keyword and resubmit the request.

ICK34084I ESTPATH FAILED - MIXED ESCON AND FCP INFORMATION SPECIFIED

Explanation: An ESTPATH command must specify all ESCON or all FCP paths. ESCON and FCP paths may not be mixed within the same command.

System Action: Processing stops.

Operator Response: None.

System Programmer Response: Correct the ESTPATH specification and resubmit the request.

ICK34085I INVALID WORLD WIDE NODE NAME SPECIFIED

Explanation: The primary and secondary WWNN must be a valid WWNN for an ESS box.

System Action: Processing stops.

Operator Response: None.

System Programmer Response: Correct the specification of the WWNN referenced in the ESTPATH, DELPATH or ANALYZE request. The WWNN can be determined by issuing the PPRCOPY QUERY (without PATHS) command to the device.

ICK34086I ATTEMPT TO ESTABLISH OR REMOVE FCP OR ESCON PATHS WHEN ESCON OR FCP PATHS ALREADY EXIST

Explanation: An attempt was made to establish ESCON PPRC paths between two control units with FCP paths already existing between the control units, or an attempt was made to establish FCP PPRC paths between two control units with ESCON paths already existing between the control units. The

Messages received at the output printer

| WWNN or Control Unit Serial Number for the secondary control
| unit could not be obtained, so the determination that the
| command was acting on an existing association was made
| based on the secondary SSID which may not be unique.

| **System Action:** Processing stops.

| **Operator Response:** None.

| **System Programmer Response:** Ensure that the correct
| devices are being targeted. If so and conversion of the path
| types is actually desired, the following procedure can be used
| to convert from one path type to another.

- | 1. Issue the FREEZE command to the primary to remove the
| paths and suspend the pairs.
- | 2. Issue the ESTPATH command to establish the paths of the
| type desired.
- | 3. Issue the ESTPAIR command with MODE(RESYNC) to
| re-establish the pairs.

| **ICK34087I** ESTPATH FAILED - ATTEMPT TO ESTABLISH FCP
| PPRC PATHS ON PORT WITH EXISTING FICON
| PATHS

| **Explanation:** An attempt was made to establish or remove
| FCP PPRC paths on a port with existing FICON logical paths.

| **System Action:** Processing stops.

| **Operator Response:** None.

| **System Programmer Response:** Ensure the correct devices
| are being targeted. If so and the request is ESTPATH, the
| command cannot be successfully executed until the FICON
| paths have been removed. If the correct devices are being
| targeted and the request is a DELPATH request, then there are
| no FCP PPRC paths to be deleted.

| **ICK34088I** PPRC SECONDARY VOLUME FOUND IN
| UNCONFIGURED OR UNDEFINED STATE

| **Explanation:** A peer-to-peer remote copy secondary volume
| was found to be in an unconfigured or undefined state.

| **System Action:** Processing stops.

| **Operator Response:** None.

| **System Programmer Response:** Save the output and
| contact your IBM service representative.

| **ICK34089I** ESTPATH FAILED - DEVICE 0 NOT CONFIGURED
| IN SECONDARY LSS

| **Explanation:** An establish peer-to-peer remote copy paths
| command failed because device 0 is not configured in the
| secondary logical subsystem.

| **System Action:** Processing stops.

| **Operator Response:** None.

| **System Programmer Response:** Save the output and
| contact your IBM service representative.

| **ICK34090I** ESTPAIR FAILED - FAILOVER SPECIFIED BUT
| PPRC PAIR ALREADY IN REQUESTED STATE

| **Explanation:** An establish peer-to-peer remote copy pair
| command specifying PPRC FAILOVER mode or PPRC
| FAILBACK mode was received, but the peer-to-peer remote
| copy pair is already in the requested state.

| **System Action:** Processing stops.

| **Operator Response:** None.

| **System Programmer Response:** None.

| **ICK34091I** CASCADING PPRC SECONDARY IN INVALID STATE
| FOR REQUEST. PRIMARY SYNCHRONOUS AND
| SUSPENDED, PENDING DUPLEX, OR FULL DUPLEX

| **Explanation:** For cascading PPRC modes, when this
| command specifies a secondary volume that is determined to
| be in a PPRC relationship, that relationship must have been
| established in a cascading PPRC state.

| **System Action:** Processing stops.

| **Operator Response:** None.

| **System Programmer Response:** Ensure that the secondary
| volume targeted by the current command is the correct one. If
| so, then you can reissue the ESTPAIR command with the
| CASCADE keyword added, to the pair, the primary volume of
| which, is the secondary volume of the current command.

| **ICK34092I** SPECIFIED PRIMARY VOLUME MAY NOT BE IN
| PPRC EXTENDED DISTANCE MODE

| **Explanation:** For cascading PPRC Modes, if the command
| specifies cascading PPRC with synchronous mode, the volume
| receiving this command as specified in the primary volume
| parameters may not be a PPRC secondary volume in PPRC
| Extended Distance Mode.

| **System Action:** Processing stops.

| **Operator Response:** None.

| **System Programmer Response:** Ensure that the secondary
| volume targeted by the current command is the correct one. If
| so, then a cascaded triad where the local pair is in extended
| distance mode and the remote pair is in synchronous mode is
| not supported.

| If the cascaded triad is still desired then the valid
| configurations are:

- | Synchronous to extended distance
- | Extended distance to extended distance, and
- | Synchronous to synchronous

| If the cascaded triad is still desired with the local pair in
| extended distance mode then the remote pair will have to be
| established in extended distance mode.

| **ICK34093I** INVALID VALUE SPECIFIED FOR xxxxxx

| **Explanation:** The value indicated by xxxxxx was specified by
| the user and is invalid. The values that can be substituted for
| xxxxxx follow.

- | PRIMARY CCA
- | SECONDARY CCA

Messages received at the output printer

| PRIMARY LSS
| PRIMARY SEQUENCE NUMBER
| PRIMARY WWNN
| PRIMARY SSID
| SECONDARY LSS
| SECONDARY SEQUENCE NUMBER
| SECONDARY WWNN
| SECONDARY SSID
| FIRST LINK OR FCP PATH
| SECOND LINK OR FCP PATH
| THIRD LINK OR FCP PATH
| FOURTH LINK OR FCP PATH
| FIFTH LINK OR FCP PATH
| SIXTH LINK OR FCP PATH
| SEVENTH LINK OR FCP PATH
| EIGHTH LINK OR FCP PATH
| PACE

| **System Action:** Command processing ends.

| **Operator Response:** None.

| **System Programmer Response:** Respecify the incorrect value and resubmit the request.

| **ICK34094I** INVALID BITS SET IN BYTE X'xxxx.' THOSE
| BITS SET INVALIDLY ARE: y (, z ...)

| **Explanation:** Bits have been set in byte xxxx that are not valid for the CCW. The indication of which bits are set incorrectly count from 0, so, for example, if the first bit is incorrectly set, the indication will be 0, if the fourth bit is incorrectly set, the indication will be 5 and if the last bit is set invalidly the indication will be 7. This also applies to the byte indicator.

| **System Action:** Command processing ends.

| **Operator Response:** None.

| **System Programmer Response:** Save the output and notify your IBM Service representative.

| **ICK34095I** TRACK FORMAT MISMATCH BETWEEN PRIMARY AND
| SECONDARY DEVICE DETECTED DURING UPDATE

| **Explanation:** The format of a track on the secondary volume does not match the format of the corresponding primary track when performing an update operation.

| **System Action:** Command processing ends.

| **Operator Response:** None.

| **System Programmer Response:** Verify and correct the track format discrepancy and issue the command again.

| **ICK34096I** CASCADED SYNC TO SYNC CONFIGURATION WITH
| WRITES FROM LOCAL PAIR PROCEEDING

| **Explanation:** The PPRC pair in a cascading PPRC relationship is connected via Fiber Channel Links. Both PPRC pairs in the cascading PPRC relationship are synchronous and write I/Os are still being transferred from the primary to the secondary of the first PPRC pair. This combination is not allowed.

| **System Action:** Command processing ends.

| **Operator Response:** None.

| **System Programmer Response:** Restore the remote PPRC pair which is now in synchronous mode to Extended Distance mode..

| **ICK40227I** AN "ELSE" COMMAND APPEARS IMPROPERLY

| **Explanation:** The command contains an ELSE clause without a corresponding IF statement.

| **System Action:** The remainder of the command is ignored. ICKDSF continues with the next command.

| **Operator Response:** None.

| **System Programmer Response:** Correct the command syntax, and issue the command again. Save the output and contact your IBM service representative.

| **ICK40228I** AN "END" COMMAND IS INVALID

| **Explanation:** An END statement does not have a matching DO statement.

| **System Action:** The remainder of the command is ignored. ICKDSF continues with the next command.

| **Operator Response:** None.

| **System Programmer Response:** Correct the DO-END sequence, and issue the command again. Save the output and contact your IBM service representative.

| **ICK40229I** 'IF' COMMAND HAS INVALID RELATIONAL
| EXPRESSION

| **Explanation:** The IF-THEN-ELSE statement sequence is incorrect.

Only the system variables LASTCC and MAXCC can be specified. All values must be decimal numbers from 0 through 99999.

| **System Action:** The remainder of the command stream is ignored. ICKDSF continues with the next command.

| **Operator Response:** None.

| **System Programmer Response:** Check the requirements of the IF-THEN-ELSE statement sequence and correct the error. Issue the command again. Save the output and contact your IBM service representative.

| **ICK40230I** "SET" COMMAND HAS INVALID ASSIGNMENT
| EXPRESSION

| **Explanation:** The syntax of a SET statement is not valid. Only the system variables LASTCC and MAXCC can be assigned values. All values must be decimal numbers from 0 through 99999.

| **System Action:** The remainder of the command stream is ignored. ICKDSF continues with the next command.

| **Operator Response:** None.

| **System Programmer Response:** Check the syntax requirements of the SET statement and correct the error. Issue the command again. Save the output and contact your IBM service representative.

Messages received at the output printer

ICK40232I IMPROPER OR MISSING "THEN" KEYWORD

Explanation: The THEN clause of the IF-THEN-ELSE command sequence is either missing or is misspelled.

System Action: The remainder of the command stream is ignored. ICKDSF continues with the next command.

Operator Response: None.

System Programmer Response: Correct the error, and issue the command again. Save the output and contact your IBM service representative.

ICK40236I INPUT STREAM END-OF-FILE FOUND BEFORE END OF COMMAND

Explanation: An end-of-file condition was encountered while scanning the command. This could be caused by either incorrect command-continuation syntax or missing records in the input stream.

System Action: The command ends.

Operator Response: None.

System Programmer Response: Either correct the command syntax, or add the missing records. Issue the command again. Save the output and contact your IBM service representative.

ICK40237I TOO MANY LEVELS OF "IF" COMMAND NESTING

Explanation: More than ten IF statements have been nested.

System Action: The remainder of the command stream is ignored. ICKDSF continues with the next command.

Operator Response: None.

System Programmer Response: Restructure the command stream to avoid the excessive nesting, and issue the command again. Save the output and contact your IBM service representative.

ICK40300I ERROR READING INPUT DATA FROM "fn ft fm" RC= nnnn

Explanation: While CMS macro FSREAD read a record from the specified CMS file, an error condition occurred with RC=nnnn.

System Action: The command ends.

Operator Response: None.

System Programmer Response: For an explanation of the return code, see the FSREAD macro in *CMS Macros and Function Reference*

ICK40305I ERROR READING INPUT DATA FROM VIRTUAL READER RC= nnnn

Explanation: While the CMS macro RDCARD read a record from a virtual reader file, an error condition occurred with RC=nnnn.

System Action: The command ends.

System Programmer Response: For an explanation of the

return code, see the RDCARD macro in *CMS Macros and Function Reference*

Operator Response: None.

ICK40310I ERROR WRITING OUTPUT DATA TO "fn ft fm" RC= nnnn

Explanation: While CMS macro FSWRITE was writing a record to a specified CMS file, an error condition occurred with RC=nnnn.

System Action: The command ends.

System Programmer Response: For an explanation of the return code, see the FSWRITE macro in *CMS Macros and Function Reference*

Operator Response: none.

ICK40315I ERROR WRITING OUTPUT DATA TO VIRTUAL PRINTER RC= nnnn

Explanation: While CMS macro PRINTL was printing a line to a virtual printer, an error condition was detected with RC=nnnn.

System Action: The command ends.

System Programmer Response: For an explanation of the return code, see the PRINTL macro in *CMS Macros and Function Reference*

Operator Response: None.

ICK40317I UNABLE TO DETERMINE MINI DISK SIZE

Explanation: ICKDSF was invoked using the CMS invocation parameter list. The process requires an operator response, but the input device does not allow operator input.

System Action: Command processing ends.

Operator Response: Run the job again, specifying an input device which allows a response.

System Programmer Response: None.

ICK40320I I/O OPERATION INCOMPLETE OR FAILED RC= nnnn

Explanation: While CMS macro HNDINT was handling the I/O interrupt for the DASD I/O operation, an error condition occurred with RN=nnnn.

System Action: The command ends.

Operator Response: None.

System Programmer Response: For an explanation of the return code, see HNDINT macro in *CMS Macros and Function Reference*

ICK40999I UABORT CODE nn

Explanation: An abnormal end error caused the ICKDSF processor to abort. This situation is usually caused by hardware, program, or system errors. The message appears in the output listing from the write-to-programmer SVC.

Code *nn* indicates the nature of the error.

Messages received at the output printer

Code	Meaning	
15	When ICKDSF was invoked from CMS using the CMS parameter list, the file containing the input data set could not be found.	
19	Input device is not valid.	
24	Text processor's print control table is not addressed by the GDT.	
28	No virtual storage is available for: <ul style="list-style-type: none"> • Page header line • Argument lists • Main title line • Footing lines • Print control table (PCT) • Initialization of the I/O adapter historical data and message area • Automatic (dynamic) storage for a module which uses preallocated automatic storage • A GETMAIN/GETVIS request • Space for STAE control block • Open control-block allocation • Device Information Table (DIT) <p>Note: The system could not issue the message that sufficient storage was not available because the SYSPRINT data set was not open.</p>	
29	Output device not valid.	
32	Request made to process unopened data set	
33	Unable to cancel STAE control	
34	Too many USTAE calls	
36	Processor unable to open SYSPRINT (or whichever DD name is used to denote the processor's standard listing output data set). The SYSIN DD card may be misspelled.	
40	List of U-macro arguments that are not valid: UOPEN, UCLOSE, UPUT, UALLOC, UCVAF, UGSPACE, UGPOOL, UFPOOL, USCRATCH, UTIME UVOLCHK, UWTO, UDEQ, USTAE, URESERVE	
41	Invalid storage request for UGSPACE macro	
44	Processor is unable to produce a dump. The SNAP system service was not successful: either the DSFDUMP data set could not be opened, or not enough storage was available.	
50	ICKDSF order not valid	
52	Module not found for ULOAD	
59	HNDINT macro error in the SIO routine. Abnormal end error message for message ICK40320I. See the explanation and response for ICK40320I.	
68	GETVIS failure.	
69	HNDINT macro error in the GET SCHIB routine (at	
		open time). Abnormal end error message for message ICK40320I. See the explanation and response for ICK40320I.
		72 Unsupported device type.
		75 Operating system could not be determined.
		76 370 mode not supported.
		77 VSE EXTRACT failed, unable to determine CPUID.
		80 CCW action flag not valid.
		81 Bad OSVTOC. Cannot call DADSM to correct the problem.
		82 Internal ENQ process problem.
		84 A unrecognized I/O error has occurred for the device type
		88 Operator replied T to message ICK014D
		89 DIRECTed I/O incorrect. Contact your IBM service representative.
		93 ICKDSF abnormal end for message ICK011E.
		96 Equipment check occurred on device that is being processed.
		98 Invalid PSF order or undefined action.
		99 PSF order not defined in action table.
		System Action: ICKDSF ends.
		Operator Response: Notify the system programmer.
		System Programmer Response: Correct the cause of the error, and start ICKDSF again. Save the job output and contact your IBM hardware service representative.

Messages received at the output printer

Appendix B. Volume layout and record formats on CKD Devices

This appendix gives information on volume layout and record formats for CKD devices. It includes:

- An example of a 3380 volume map
- Track contents after initialization
- IPL bootstrap record contents
- How track associations are recorded

The track is the smallest directly addressable space on a device. Tracks typically occupy a full 360-degree rotation of the disk medium; however, a track can correspond to either fractional or multiple device rotations.

Each track has a starting point, called an **index** (see Figure 30). After its index point, each track on a CKD device begins with a **home address** that identifies the track's address and defines its operational status.

Cylinder 03

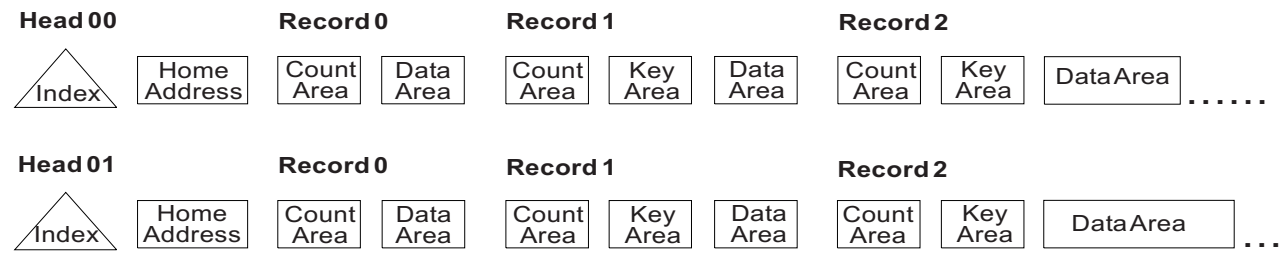

Figure 30. CKD track and record formats

The **track descriptor record** is always the first record on the track following the home address. It is **record zero (R0)**. If a flag in the home address area indicates the track is defective, then the count area of record zero contains the track address of the track that is to be used as an alternate. The count area of record 0 on the alternate track contains the track address of the defective, primary track.

Following the track descriptor record (record 0), one or more user records can be written on the track. These records are typically numbered in sequence. Each of these physical records contains a count area, an optional key area, and a data area, each of which is separated by a gap. Checking information is added to each area when it is written and is used later for detecting and correcting data errors.

Count Area contains the ID of the data area that follows. The record ID is specified by a value expressed as five bytes (CCHHR). In addition to the record ID, the count area specifies the length in bytes of the key and data areas of the record.

Key Area is an optional portion of the record. It can be used by the programmer to identify the information in the data area of the record. Note that there is no key area in the standard record zero.

Data Area contains data that has been organized and arranged by the programmer.

Example of a 3380 volume map

Figure 31 is an example of the volume map after processing a 3380 volume with either the INIT or the INSPECT command.

```

ICKDSF - xxx DEVICE SUPPORT FACILITIES yyy TIME: 00:23:00 mm/dd/yy PAGE 1
INIT UNIT(0127) NVFY VOLID(tstvol) VTOC(1,1,1)

:
ICK31061I 0A93 VTOC INDEX CREATION SUCCESSFUL: VOLUME IS IN INDEX FORMAT
ICK061I 0A93 VTOC INDEX CREATION SUCCESSFUL: VOLUME IS IN INDEX FORMAT
ICK01307I DEFECTIVE-TRACK LIST IN HEXADECIMAL FOR VOLUME TSTVOL
ICK01308I THE FOLLOWING PRIMARY TRACKS WERE FOUND DEFECTIVE:
CCHH OF TRACK --- CCHH OF ALTERNATE --- FLAGGED DEFECTIVE
0003 0003      0375 0001      YES
0004 0004      0375 0002      YES
0004 0005      0375 0003      YES
0005 0005      0375 0004      YES
0006 0006      0375 0005      YES
0006 0007      0375 0006      YES
000C 000A      0375 0000      YES

ICK01312I NO DEFECTIVE ALTERNATE TRACKS WERE FOUND.
ICK01313I VOLUME CONTAINS 15 ALTERNATE TRACKS -- 8 AVAILABLE.
ICK01314I VTOC IS LOCATED AT CCHH=X'0001 0001' AND IS 1 TRACKS.
ICK00001I FUNCTION COMPLETED, HIGHEST CONDITION CODE WAS 0
00:26:00 mm/dd/yy
  
```

Figure 31. Volume map output (CKD devices)

Symbol	Indicates
mm/dd/yy	The Month/Day/Year the ICKDSF command was run.
xxx	Operating System
yyy	Release (for example, Release 17). See Devices supported by ICKDSF for an explanation of how to determine System and Release.
ICK01307I	The volume serial number for which the map is produced.
ICK01308I	Printed as the second line of the volume map when one or more defective primary tracks were found.
	Note: Only medial initialization will generate a volume map that lists all defective tracks. Minimal initialization generates a map that lists only the alternate tracks. The INSPECT command generates a map that lists only the individual tracks that were inspected.
	Some of the listed tracks may not be defective. Lists may include tracks that are marked defective because of unconditional assignment of alternate tracks.
CCHH OF TRACK	The hexadecimal track address of the defective primary track.
CCHH OF ALTERNATE	The hexadecimal track address of the alternate track assigned to the primary track. If a primary track is marked defective but does not have an associated alternate track, this column contains the primary track address.
FLAGGED DEFECTIVE	A YES indicates that the home address flag byte has its defective-track flag on. A NO indicates that the defective-track flag is off.
TRACK CONDITION	This column is printed only if the CHECK parameter was specified with the command or if an unrecoverable track was found. (This column does not appear in the example shown.)
DEFECTIVE	The track could not be read without a DATA CHECK occurring.

Symbol	Indicates
NOT-DEFECTIVE	The track could be read and written without difficulty. The defective-track flag was on and, although the track did not appear to have defects, it was not reclaimed. The NOT-DEFECTIVE condition appears only when you do not issue the RECLAIM parameter.
UNRECOVERABLE	Surface checking could not be performed because I/O errors occurred that prevented either the home address or the record 0 from being written on the track.
ICK01309I	One or more alternate tracks were found defective. The same information is provided for alternate tracks and primary tracks, but the second column identifies the primary track associated with the alternate track. Note: In some cases, the track address for the primary track is the same track address as that of the alternate track. This indicates that the alternate track is not associated with a primary track. When an alternate track is found unrecoverable, the FLAGGED DEFECTIVE column is blank, and the primary track address is set to NONE.
ICK01313I	The number of alternate tracks defined for the volume and the number of alternate tracks that are neither defective nor assigned.
ICK01314I	The track address where the volume table of contents begins and the number of tracks reserved for it.

Track contents after initialization



Figure 32 shows the contents of cylinder 0, track 0 after the volume has been initialized. The first track of the first cylinder is reserved for system-defined records:

- Home address and record 0
- IPL bootstrap records
- Volume label
- Optional user-volume labels
- Optional IPL program

Ha	R0	IPL Bootstrap-1	IPL Bootstrap-2	Volume Label	User-Volume Label-1	...	IPL Program
----	----	-----------------	-----------------	--------------	---------------------	-----	-------------

Figure 32. Cylinder 0, track 0 layout (CKD devices)

IPL bootstrap record contents



Table 59 on page 464 shows the contents of the IPL bootstrap records as the system supplies them. Each bootstrap record has a count area and a four-byte key area.

The key of the first record is IPL1, and the count area indicates that its data area is 24 bytes long. The key of the second record is IPL2, and the count area indicates that its data area is 144 bytes long.

Bootstrap record 1 causes bootstrap record 2 to be read, and bootstrap record 2 causes the IPL program to be read. The IPL program contains user-defined values.

Table 59. IPL bootstrap records

IPL Bootstrap Record 1:	
00000000 00000000	PSW
06003A98 60000060	CCW: Read
08003A98 00000000	CCW: TIC
IPL Bootstrap Record 2:	
07003AB8 40000006	CCW: Seek
31003ABE 40000005	CCW: Search Id Equal
08003AA0 00000000	CCW: TIC
06000000 20000000	CCW: Read
00000000000000	Seek Address—0:0
0000000004	Search Address—R 4
0000000000000000	Padding
0000000000000000	(101 Bytes)

How track associations are recorded

Figure 33 shows how the primary and alternate track associations are recorded on the volume. The track addresses, in this example, are for an IBM 3390 Model 2.

For the IBM 9345, the primary/alternate track reassignment is managed by the subsystem.

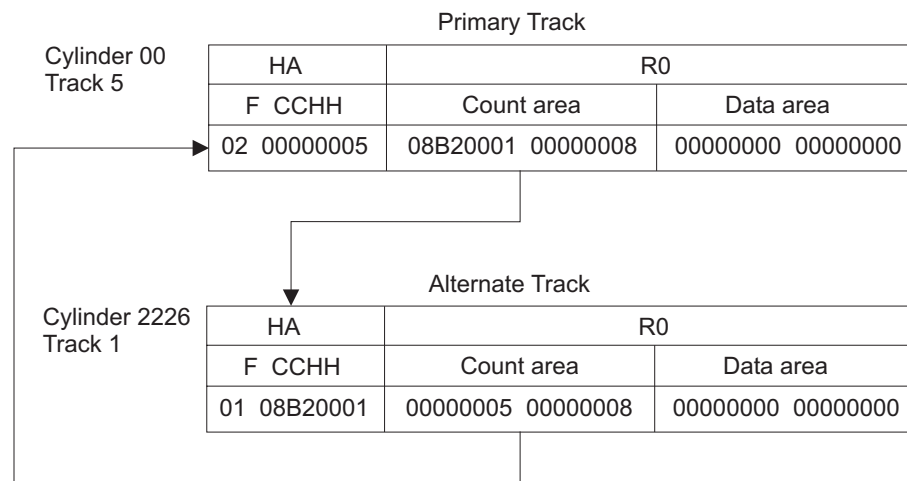

Figure 33. Primary/alternate track association (3390 model 2)

Appendix C. VTOC index

MVS

This appendix gives you information on the VTOC and the VTOC index. It includes information about:

- Calculating the size of the VTOC
- Calculating the size of the VTOC index
- Calculating the number of tracks for the index
- Determining how many VIERS you need

The VTOC index is a separate, sequential data set containing four record types that give information on volume and VTOC status. Systems that contain and use indexed VTOC programming support can achieve performance improvements in the areas of volume space management and I/O operations to the VTOC.

The INIT and BUILDIX commands will build the VTOC index on eligible CKD devices. The INIT command creates space for the index during volume initialization in both operating system and stand-alone versions. The BUILDIX command, which requires that the host operating system contain indexed VTOC programming support, builds VTOC indexes on volumes currently in use on the system. Both commands prepare the VTOC on the target volume to indexed VTOC (IXVTOC) format.

Calculating the size of the VTOC

To calculate VTOC size, you generally determine the maximum number of data sets that will reside on the volume. The number of VTOC tracks to reserve can be easily calculated by dividing this number by the number of data set control blocks (DSCBs) per track, rounding to the next higher track.

The number of DSCBs in the VTOC determines the number of data sets or VSAM data spaces that can reside on a volume and is therefore essential information for the DADSM routines that allocate and release space.

The number of DSCBs that will fit on a single track of each type can be found in Table 60 on page 466.

Calculating the size of the VTOC index

The size of the index data set depends upon:

- The size of the volume (total number of cylinders and tracks)
- The track length (in bytes)
- The number of tracks occupied by the VTOC

For the INIT command, the user may calculate the number of tracks to reserve for the index and place that value as the third, optional subparameter of the INDEX parameter. Or you can omit the third subparameter and let the program calculate the size of the index. For the BUILDIX command, the user must calculate the size of the index.

If your data set name lengths are greater than 12, you should compute the size of your VTOC index using the calculations shown following Table 60 on page 466.

VTOC index

It is recommended that you calculate the number of tracks to reserve for both the VTOC and the index data set. Table 60 shows the recommended maximum values for VTOC and VTOC index size for the devices that can support the VTOC index. The chart places the recommended upper limits for calculating maximum usable space.

The assumptions used to generate the chart may or may not be valid in an actual situation, and are dependent on how much space you have already used.

Table 60. Table of maximum VTOC and VTOC index sizes

DEVICE	CYLS		TRKS PER CYL	DSCBs/ TRK	INDEX RECS/ TRK ¹	MAX. VTOC ² (TRKS)	MAX. INDEX ³ (TRKS)	# OF RECORD TYPES ⁴		
	PRI	ALT						VPSM ⁵	VMDS ⁶	VIER ⁷
3375	959	1	12	51	14	222	20	1	1	272
3380 A04, B04 AA4, AD4, BD4 AJ4, BJ4, CJ2	885	1	15	53	18	246	16	1	1	285
3380 AE4, BE4	1 770	1	15	53	18	492	31	2	2	553
3380 AK4, BK4	2 655	1	15	53	18	738	46	3	3	821
3390-1	1 113	1	15	50	21	328	17	2	2	352
3390-2	2 226	1	15	50	21	655	33	3	3	686
3390-3	3 339	1	15	50	21	983	50	4	4	1 041
3390-9	10 017	3	15	50	21	2 944	150	11	10	3 129
3390-9	32 760	0	15	50	21	9 828	491	34	31	10 238
3390-1 (3380 mode)	1 113	1	15	53	18	310	20	2	2	355
3390-2 (3380 mode)	2 226	1	15	53	18	619	39	3	3	695
3390-3 (3380 mode)	3 339	1	15	53	18	928	58	4	4	1 035
9345-1	1 440	N/A ⁸	15	45	17	470	26	2	2	437
9345-2	2 156	N/A ⁸	15	50	17	655	40	3	2	674

Notes:

- ¹ Index record length of 2048 bytes.
- ² This maximum value assumes that all data sets on the volume are single track data sets.
- ³ This maximum value assumes that the VTOC is the maximum size.
- ⁴ The first VIXM map will manage up to 7840 index records. (One VIXM is more than sufficient for current devices.) The second VIXM will manage an additional 16032 records.
- ⁵ The number of VPSMs required for a device is dependent upon its size. 16032 bits are available for cylinder and track mapping in each VPSM.
- ⁶ The first VMDS will manage up to 16032 DSCBs. The second and third VMDS will manage up to an additional 16032 DSCBs.
- ⁷ Each VIER is assumed to contain 48 entries.
- ⁸ Alternates are managed by the subsystem. They are not available to the host channel program or the user.

Calculating the number of tracks for the index

To calculate the number of tracks to reserve for the index:

1. Determine the average data set name length of the identifier data set control blocks. This value will be referred to as D.
If the length chosen is too small, the data set names may not fit in the index. If the length chosen is too large, some space is unused in the index.
2. Determine the maximum number of data sets that will reside on the volume. This value will be referred to as N.
3. Calculate the number of VTOC index entry records (VIERS) needed to contain N data set names, each of which has an average length of D. Use the calculations from "Determining how many VIERS you need."
For the number of VIXM, VPSM, and VMDS records, refer to the chart for actual numbers.
4. Add together the totals of all four record types and divide by the number of index records per track.
5. To get the number of tracks to reserve for the index, round the average from the above step to the next higher track.

Place the value calculated for the index size either:

- As the third subparameter of the INDEX parameter on the INIT command statement, or
- As the number of tracks to be allocated in the SPACE or ABSTR parameter in the DD statement required to run BUILDIX.

Determining how many VIERS you need

The following shows the calculations to determine the number of VIERS needed to contain N data set names, each of which has an average data set name length of D. The calculations assume that:

- All VIERS except one at each level are half-filled.
- A new level of the index is created. when four lower-level VIERS are created.
- n+1 unused VIERS are required for an n-level index.

Calculate the number of VIERS as follows where:

$\lfloor \quad \rfloor$ = round quotient down to integer value

$\lceil \quad \rceil$ = round quotient up to integer value

N = number of data set names in the index

D = average data set name length

E¹ = number of data set names that fit in a half-filled level 1 VIER

E² = number of data set names that fit in a half-filled level 2 or greater VIER

L(n) = number of VIERS at level n

$\lfloor 244/(D+8) \rfloor * 4 = E^1$ number of data set names that fit in a half-filled level 1 VIER

$\lfloor 244/(D+7) \rfloor * 4 = E^2$ number of data set names that fit in a half-filled level 2 or greater VIER

VTOC index

Calculate $L(n)$ (where n is 1,2,3,...). and $L(n)$ is the number of VIERs at level n

$$\left\lceil \frac{N}{E^1} \right\rceil - 1 = L(1) \quad \text{number of level 1 VIERs.}$$

Use $L(n)=1$ if calculation yield zero.

For $n=2,3,\dots$ $L(n)$ is calculated from $L(n-1)$

If $L(n-1) \geq 4$ then

$$\left\lceil \frac{L(n-1)}{E^2} \right\rceil - 1 = L(n) \quad \text{Use } L(n)=1 \text{ if calculation yields zero.}$$

If $L(n-1) < 4$, then there are no VIERs at level n or higher.

The total number of VIERs is

$$L(1) + L(2) + \dots + L(n)$$

The assumptions used for the above calculations represent the state of the index immediately after building it using the BUILDIX command. The state of the index is such that the largest number of VIERs possible are used to contain the data set names. Since the data set names on a volume will not all have the same length, use the calculations only as an approximation. Choose N (maximum number of data set names) and D conservatively to account for the varying number of data set names that will fit in a VIER.

Note: Fragmentation (because of scratch and reallocation activity) will cause the index to expand up to 50%.

Appendix D. Fixed block architecture VTOC (FBAVTOC)

VSE

This appendix describes the fixed block architecture VTOC (FBAVTOC), shows examples of label record format, and lists the FBAVTOC space requirements.

VTOCs on FBA devices are formatted in a similar manner to VSAM relative record data sets. The 140-byte label records are stored in control intervals. For example, three label records fit into a 512-byte control interval. The control interval size is always an integral multiple of the device's physical block size. The upper limit is 8192 bytes.

The FBAVTOC extent is expressed in number of slots, which is equivalent to the number of file label records. It can range from a minimum of three slots to a maximum of 999 slots, fitting into as many control intervals as required. The program rounds up the extent values to that of the next full control interval.

The FBAVTOC's starting location can be any physical block on the volume, except for blocks 0 and 1, which are reserved for the IPL and volume label blocks (VLB).

A default (non-SYSRES) FBAVTOC has the following default characteristics:

Starting location	Block 2, immediately after the VLB
Extent	56 file label records
Control interval size	1024 bytes (or FBA block size, if larger)

If you specify FBAVTOC(END), ICKDSF creates a VTOC that is 99 entries long with a control interval size of 1024. ICKDSF places the VTOC on the last blocks of the volume.

Label record format

Each record of the FBAVTOC contains 140 bytes, written as binary zeros. The first two records of the FBAVTOC are reserved for specific records:

- The data set control block of the FBAVTOC
- The space management label

Each control interval of the FBAVTOC contains a fixed number of slots. Figure 34 on page 470 shows the FBAVTOC format.

fixed block architecture VTOC (FBAVTOC)

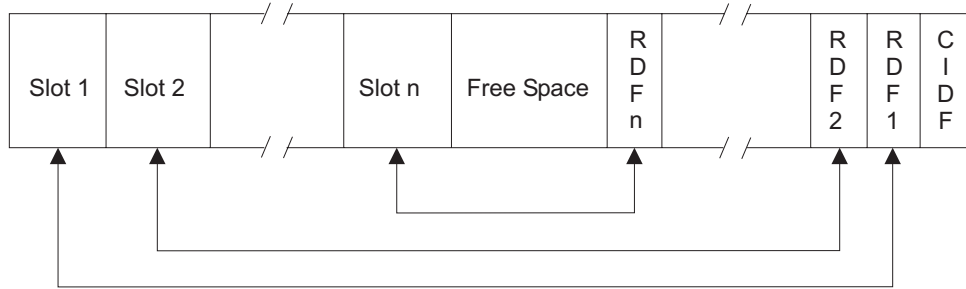

Figure 34. Format of a FBAVTOC control interval

There is one record definition field (RDF) associated with each slot in a control interval. The length field in the RDF (bytes 1 and 2) contains the slot length, which is equal to the label record length. Bit 5 of byte 0 of the RDF indicates whether the associated slot contains a record/label (bit 5=0) or not (bit 5=1). The RDF has one of the following contents:

X'00008C' if the slot contains a label.

X'04008C' if the slot does not contain a label, that is, it is empty.

Labels per control interval (LBPCI) is recorded in the standard volume label (VOL1) in bytes 29 through 32.

The control interval definition field (CIDF) has the following format:

Bytes 0,1	free-space offset = RECSIZE * LBPCI
Bytes 2,3	free-space length = CISIZE-4-LBPCI * (RECSIZE+3)

FBAVTOC space requirements

To calculate the space required for a FBA VTOC:

1. Calculate the number of labels per control interval (LBPCI). Use the formula:

$$\text{LBPCI} = \text{FLOOR of } (\text{CISIZE}-4)/(\text{RECSIZE}+3)$$

where:

FLOOR

Takes the integral part of the argument.

CISIZE

Equals the control interval size.

RECSIZE

Equals the label record size, which is equal to 140.

2. Calculate the number of control intervals required for the FBAVTOC.

$$\text{CEILING of } (\text{number of labels specified}/\text{LBPCI})$$

where:

CEILING

Takes the next highest integer if there is a remainder.

3. Calculate the number of physical blocks reserved for the FBAVTOC.

$$\text{CI} * (\text{CISIZE}/\text{physical block size})$$

where:

CI

Equals the number of control intervals required for the VTOC.

Appendix E. Surface checking

This appendix describes surface checking for a track. It includes:

- Surface checking for defects
- Primary checking
- Skip displacement checking
- Check values

Surface checking for a track is performed when you specify:

- INIT with the CHECK(*n*) parameter for 3370 and 9335 devices.
- INSPECT with the CHECK(*n*) parameter for 3370, 3375, 3380, 3390, and 9335 devices.
- INSPECT with either CHECK or SKIP for the IBM 9345. There is only one level of surface checking for the IBM 9345. It replaces the primary and skip displacement checking, and it is performed by the subsystem. For more information, see *IBM 9340 Direct Access Storage Subsystems Reference*.

Surface checking for possible defects

The purpose of surface checking is to detect defects that might exist on the surface of a track. These defects might be correctable or uncorrectable.

Surface defects exist with different degrees of visibility. Some defects can be detected by any I/O operation to the defective area of the track. Others might be detected only once out of every 100 I/O operations and only with a certain bit pattern. The number of I/O operations that ICKDSF does to any one track is limited by performance considerations, the practicality of finding a defect, and what can be done if a defect is detected for the device type being processed.

The surface checking functions performed by ICKDSF are not equivalent to the surface checking performed on a volume at the factory. Marginal defects that exist on the surface of a track cannot be detected consistently by ICKDSF because of their intermittent nature. Therefore, different results can be obtained for the same track or volume from multiple runs of ICKDSF. Also, ICKDSF output can differ from other surface checking products because of different checking algorithms.

The IBM 3375, 3380, 3390, and 9345 device types contain extra space that can be used if a defective area is detected on a track. By assigning a **skip displacement** to a given track, the hardware knows to skip over the defective area and to use the extra area for this track.

No alternative track assignment is needed. There is no performance degradation, and the track functions as if no defect exists.

ICKDSF performs two types of surface checking:

1. **Primary checking** is supported for the IBM 3370, 3375, 3380, 3390, 9345, and 9335.
2. **Skip displacement checking** can occur on 3375, 3380, and 3390 devices only.

Primary checking

Primary checking is performed when CHECK(*n*) is specified as follows:

Surface checking

- For the IBM 3370, 3375, 3380, 3390, and 9335, when you use the INSPECT command.
- For the IBM 9335 and 3370, when you use the INIT command.
- Primary checking is the only level supported for the IBM 3370 and 9335 devices. It consists of writing and reading back n bit patterns for the specific device. For the values for n by device, see “CHECK(n) values” on page 473.

Primary checking for CKD devices

Primary checking for CKD devices consists of the following:

1. A bit pattern for the specified device is written and read back once.
2. If a data check is detected (correctable or uncorrectable), the following is performed:
 - For devices with skip displacement support, the I/O operation is repeated to determine if the data check persists. If it does, skip displacement checking is performed on the track. For more information, see “Skip displacement checking.”
 - For devices without skip displacement support, the bit pattern is reread up to ten times to determine if the error is repeatable. If the error is not repeatable, processing continues.
If the error is repeatable:
 - For correctable errors, an entry is made in the map output if MAP was specified. Processing continues to the next track. If you want to assign an alternate to that track, use INSPECT NOCHECK ASSIGN TRACKS.
 - For uncorrectable data checks, the track is declared defective.
3. This is repeated n times (from CHECK(n)) unless a data check is encountered. Each pass through uses a different device-dependent bit pattern. If all the patterns for the device are used, the sequence of patterns is repeated starting with the first pattern used. For the values of n that write each bit pattern at least once, see “CHECK(n) values” on page 473.

Primary checking for FBA devices

Primary checking for FBA devices consists of the following:

1. A bit pattern for the specified device is written and read back once.
2. If a correctable data check is detected, the block is reread ten times to determine if the error is repeatable.
3. If an uncorrectable data check or repeatable correctable data check is encountered and ASSIGN is specified, an alternate is assigned and the process is restarted to analyze the surface of the alternate.
4. This is repeated n times (from CHECK(n)) until it is performed without encountering any uncorrectable data checks or any repeatable correctable data checks. Each pass through uses a different device-dependent bit pattern. If all the patterns for the device are used, the sequence of patterns is repeated starting with the first pattern used. For the values of n that write each bit pattern at least once, see “CHECK(n) values” on page 473.

Skip displacement checking

Skip displacement checking of a track can be performed on 3375, 3380, and 3390 devices. Rigorous surface checking is done to locate and skip over defective areas on a track.

The maximum number of defects that can be skipped on any one track is dependent upon the device type. A track is declared defective only if the number of defects exceeds this maximum.

Skip displacement checking is performed using the INIT or INSPECT command as follows:

INSPECT command—For the IBM 3375, 3380, and 3390 when:

- SKIP is specified with CHECK(*n*).
- Primary surface checking detects a data check.
- RECLAIM is specified and the track is currently flagged defective.

Detection and assignment of a skip displacement for a track are complicated and can be time consuming. When skip displacement processing is issued, the emphasis is on defect detection.

For the NOSKIP process, the total running time can vary considerably, depending upon the number of tracks that might invoke skip displacement analysis.

Additionally, for low visibility defects, an error might not be detected during one NOSKIP run (and therefore no skip displacement checking takes place), but might be detected during a subsequent NOSKIP run.

Note that, after a defect is skipped, that defect becomes invisible to all subsequent processing and will not be encountered again.

CHECK(*n*) values

The CHECK(*n*) values shown below give one pass through each bit pattern. Specifying a value of *n* greater than these values causes the same bit pattern to be rewritten. As this is a time-consuming option, you should think about performance considerations.

- For the 3370 and 9335, *n*=3 gives one pass through each bit pattern.
- For the 3375, 3380, and 3390, *n*=2 gives one pass through each bit pattern

If you specify SKIP for supported devices, skip displacement checking is automatically performed and *n* is ignored.

Appendix F. User security exit module

This appendix contains Programming Interface information.

MVS

The data security function in ICKDSF provides for a user exit module that can tailor security processing to installation needs. A default module is shipped with ICKDSF. This appendix describes this module.

The user exit module is invoked by the ICKDSF security/authorization module for online processing under MVS. The only intended purpose of the user exit module is to control the security checking function by setting return codes. Attempts to alter anything other than return codes with the module may have unpredictable results. SETCODE AC(1) as ICKDSF is an authorized program.

For an example of link-editing an exit module, see Figure 36 on page 477. The ICKDSF program directory, which is supplied with the ICKDSF program, contains information about link-editing.

Loading registers

ICKDSF loads the following registers as input to ICKUSER1:

Register	Content
1	Pointer to a 3-word parameter list.
13	Pointer to a standard 18-word save area.
14	Return address.
15	Address of ICKUSER1 entry point.

The 3-word parameter list contains:

Word 1	Pointer to a data set name.
Word 2	Pointer to a 6-character volume serial number.
Word 3	Pointer to a 2-character field containing: A 1-byte data set type code A 1-byte ICKDSF command code

The data set type codes are:

1	VSAM data set
2	Password-protected data set
3	Unexpired data set

The command codes are:

1	Reserved
2	INIT command
3	INSPECT command
4	TRKFMT command

User security exit module

Note: The user exit module must set a return code in register 15 indicating the action required.

Return codes for password-protected data sets

For password-protected data sets, the return codes are:

Hex	Dec	Meaning
00	0	Bypass checking for this volume and do not return to ICKUSER1 for this volume
04	4	Bypass checking for this data set, but return to ICKUSER1 for the next data set
08	8	Check this data set normally and return to ICKUSER1 for the next data set
0C	12	Check this volume normally and do not return to ICKUSER1 for this volume
10	16	Reject access to this data set without checking and return to ICKUSER1 for the next data set
14	20	Terminate this command immediately

Normal checking for a password-protected data set consists of taking the user-supplied password for this data set from the `PASSWORDS` parameter and verifying that this password provides authority to alter the data set.

Return codes for VSAM and unexpired data sets

For VSAM and unexpired data sets, the return codes are:

Hex	Dec	Meaning
00	0	Bypass checking for this volume and do not return to ICKUSER1
0C	12	Check this volume normally and do not return to ICKUSER1
14	20	Terminate this command immediately

Normal checking for VSAM and unexpired data sets consists of checking whether the `PURGE` option has been specified. (For `INSPECT` with `NOPRESERVE`, the `PURGE` option is always absent.) If a code other than the ones shown is returned, `ICKDSF` terminates the function.

Return codes for the IBM module

The IBM-supplied module always returns a code of 12. Codes returned by the IBM module are arranged as shown in Table 61.

Table 61. Offsets of return codes for the IBM-supplied user exit module

Hex Offset	Code	Command	Data Set Type
+4*	12		
+8*	12		
+C*	12		
+10	12	INIT	VSAM
+14	12	INIT	Password-Protected
+18	12	INIT	Unexpired
+1C	12	INSPECT	VSAM
+20	12	INSPECT	Password-Protected
+24	12	INSPECT	Unexpired

Table 61. Offsets of return codes for the IBM-supplied user exit module (continued)

Hex Offset	Code	Command	Data Set Type
+28	12	TRKFMT	VSAM
+2C	12	TRKFMT	Password Protected
+30	12	TRKFMT	Unexpired
* Reserved.			

However, the IBM-supplied return codes can easily be changed with superzap. Figure 35 is an example of overriding ICKUSER1, in which the IBM-supplied return code is changed in this manner. This example shows how ICKUSER1 can be overridden to permit use of the INSPECT command with the NOPRESERVE option on volumes containing VSAM data sets. This JCL changes the IBM-supplied return code of 12 at offset X'1C' as shown in Table 61.

```
//DSFP62D    JOB    CLASS=A,MSGLEVEL=(1,1)
//ZAPOFF    EXEC   PGM=AMASPZAP
//SYSPRINT  DD     SYSOUT=A
//SYSLIB   DD     DSN=SYS1.LINKLIB,DISP=SHR,UNIT=3390,
//          VOL=SER=VS2D57
//SYSIN     DD     *
NAME        ICKDSF  ICKUSER1
VER         001C    0000000C
REP         001C    00000000
/*
```

Figure 35. Overriding ICKUSER1 to change return codes

Replacing the IBM-supplied user exit routine

When an installation wants to replace the IBM-supplied user exit routine:

1. The replacement routine must be named ICKUSER1 with an entry point of ICKUSER1.
2. ICKDSF must be re-link-edited.

Figure 36 shows an example of how to re-link-edit ICKDSF to include a new ICKUSER1. In the figure, ICKUSER1 is a member of MYLIB.

```
//LINKLIB    EXEC   PGM=IEWL,PARM='XREF,LIST,LET,RENT,REFR'
//SYSPRINT  DD     SYSOUT=A
//SYSUT1    DD     UNIT=SYSDA,SPACE=(CYL,(2,2))
//MYLIB1    DD     DISP=SHR,DSN=MYLIB,VOL=SER=xxxxx,UNIT=3390
//SYSLMOD   DD     DISP=SHR,DSN=SYS1.LINKLIB
//SYSLIN    DD     *
            INCLUDE MYLIB1(ICKUSER1)
            INCLUDE SYSLMOD(ICKDSF)
            ENTRY   ICKSA01
            SETCODE AC(1)
            NAME    ICKDSF(R)
/*
```

Figure 36. Link-edit for ICKUSER1

Appendix G. ICKMCLVL macro

MVS

The macro identified in this appendix is provided as a programming interface for customers by Device Support Facilities.

Attention: Do not use as programming interfaces any ICKDSF macros other than the one identified in this appendix.

The ICKMCLVL macro is a general use programming interface.

This appendix contains Programming Interface information.

MVS

This appendix describes the ICKMCLVL macro. ICKMCLVL (in SYS1.SAMPLIB) is an in-line executable assembler-language macro that can be invoked by a caller. This macro lets subsystems that invoke ICKDSF dynamically know if ICKDSF is installed on the system, and if it is, its version, release, and modification level.

This ICKDSF-provided macro attempts to load the ICKDSF module. If the load is successful, it determines the ICKDSF version, release, and modification level and passes the requested information in a register. The macro also causes the load module to be deleted from main storage. The caller can be in problem program state and have a user key. The caller must save registers 0, 1, 14, and 15 before invoking the macro. No other registers are disturbed.

On return, register 1 contains information as follows:

- If the release level of ICKDSF cannot be determined, register 1 contains X'04000000'.
- Otherwise, register 1, byte 0 contains X'00', and the three low-order bytes contain:
 - Byte 1: Version number (in binary)
 - 00 = Version 0
 - 01 = Version 1
 - 02 = Version 2
 - Byte 2: Release number (in binary)
 - 01 = Release 1
 - 02 = Release 2
 - 03 = Release 3
 - ⋮
 - 10 = Release 16
 - 11 = Release 17
 - Byte 3: Modification level (in binary)
 - 00 = Modification level 0
 - 01 = Modification level 1
 - 02 = Modification level 2

ICKMCLVL macro

Table 62 shows the expansion of the macro ICKMCLVL.

Table 62. Expansion of macro ICKMCLVL

```
MACRO
ICKMCLVL
LOAD EP=ICKRELVL, ERRET=ICK1SYSNDX
LR 1,0
L 1,0(1)
B ICK2&SYSNDX
ICK1&SYSNDX LA 1,4(0,0)
SLL 1,24(0)
B ICK3&SYSNDX
ICK2&SYSNDX DELETE EP=ICKRELVL
ICK3&SYSNDX DS OH
MEND
* register 1 contents:
* byte 0: 00 if no errors, 04 otherwise
* byte 1: version number
* byte 2: release number
* byte 3: modification number
```

Appendix H. Calling ICKDSF from an application program

ICKDSF can be invoked as a utility program from an application program by using the LINK (or ATTACH) macro. The general use programming interface for invoking utility programs is described in the appendix of the DFSMS/MVS Utilities manual. Any parameter that can be specified on the EXEC PARM JCL statement for ICKDSF can be passed by way of this interface as described below.

Callers of ICKDSF BUILDIX command with the IXVTOC parameter may indicate that the caller already holds a RESERVE on the VTOC. ICKDSF BUILDIX with OSVTOC parameter and all other ICKDSF commands do not support this option (an indication that the caller holds a RESERVE is ignored).

To request this function from ICKDSF, build a parameter list as described in Figure 37.

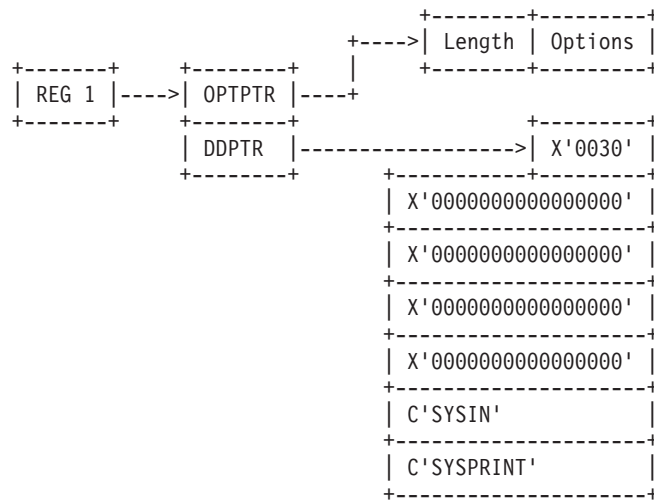

Figure 37. ICKDSF invocation parameter list

OPTPTR is the name of the pointer to the option list and is similar to the OPTIONADDR description used in *MVS/DFP 3.3: Utilities, SC26-4559*. This provides a way to specify processing options. This parameter must be specified even if the list is a null list. This means that if you do not want to specify any parameters to ICKDSF, this pointer must be specified and must point to a halfword of binary zeros. The same values that can be specified in the EXEC PARM field in the JCL for ICKDSF can be specified in the option list. An additional option is available to program callers of ICKDSF BUILDIX with IXVTOC parameter that its caller holds a RESERVE on the VTOC of the volume to be processed. This 6-byte long parameter takes the following form.

```
X'FFtttttttFFX'
```

where:

ttttttt is the address of the TCB that owns the RESERVE on the VTOC. If the specified TCB does, in fact own the RESERVE, ICKDSF BUILDIX IXVTOC will not obtain a RESERVE of its own. If not, the BUILDIX command will be terminated. It is

| the caller's responsibility to ensure that the free space information on the volume is
| correct prior to calling ICKDSF BUILDIX IXVTOC when the TCB address is passed.

| This parameter can be specified anywhere within the list of options.

| **Caution:** Users of this interface are expected to maintain the RESERVE on the
| VTOC of the volume being processed until ICKDSF has completed its task.

| Failure to do so may result in the loss of data.

Appendix I. Accessibility

Accessibility features help a user who has a physical disability, such as restricted mobility or limited vision, to use software products successfully. The major accessibility features in z/OS enable users to:

- Use assistive technologies such as screen-readers and screen magnifier software
- Operate specific or equivalent features using only the keyboard
- Customize display attributes such as color, contrast, and font size

Using assistive technologies

Assistive technology products, such as screen-readers, function with the user interfaces found in z/OS. Consult the assistive technology documentation for specific information when using it to access z/OS interfaces.

Keyboard navigation of the user interface

Users can access z/OS user interfaces using TSO/E or ISPF. Refer to *z/OS TSO/E Primer*, *z/OS TSO/E User's Guide*, and *z/OS ISPF User's Guide Volume I* for information about accessing TSO/E and ISPF interfaces. These guides describe how to use TSO/E and ISPF, including the use of keyboard shortcuts or function keys (PF keys). Each guide includes the default settings for the PF keys and explains how to modify their functions.

Notices

This information was developed for products and services offered in the U.S.A. IBM may not offer the products, services, or features discussed in this document in other countries. Consult your local IBM representative for information on the products and services currently available in your area. Any reference to an IBM product, program, or service is not intended to state or imply that only that IBM product, program, or service may be used. Any functionally equivalent product, program, or service that does not infringe any IBM intellectual property right may be used instead. However, it is the user's responsibility to evaluate and verify the operation of any non-IBM product, program, or service.

IBM may have patents or pending patent applications covering subject matter described in this document. The furnishing of this document does not give you any license to these patents. You can send license inquiries, in writing, to:

IBM Director of Licensing
IBM Corporation
North Castle Drive
Armonk, NY 10504-1785
U.S.A.

For license inquiries regarding double-byte (DBCS) information, contact the IBM Intellectual Property Department in your country or send inquiries, in writing, to:

IBM World Trade Asia Corporation Licensing
2-31 Roppongi 3-chome, Minato-ku
Tokyo 106, Japan

The following paragraph does not apply to the United Kingdom or any other country where such provisions are inconsistent with local law:

INTERNATIONAL BUSINESS MACHINES CORPORATION PROVIDES THIS PUBLICATION "AS IS" WITHOUT WARRANTY OF ANY KIND, EITHER EXPRESS OR IMPLIED, INCLUDING, BUT NOT LIMITED TO, THE IMPLIED WARRANTIES OF NON-INFRINGEMENT, MERCHANTABILITY OR FITNESS FOR A PARTICULAR PURPOSE. Some states do not allow disclaimer of express or implied warranties in certain transactions, therefore, this statement may not apply to you.

This information could include technical inaccuracies or typographical errors. Changes are periodically made to the information herein; these changes will be incorporated in new editions of the publication. IBM may make improvements and/or changes in the product(s) and/or the program(s) described in this publication at any time without notice.

IBM may use or distribute any of the information you supply in any way it believes appropriate without incurring any obligation to you.

Licensees of this program who wish to have information about it for the purpose of enabling: (i) the exchange of information between independently created programs and other programs (including this one) and (ii) the mutual use of the information which has been exchanged, should contact:

IBM Corporation
Mail Station P300
2455 South Road
Poughkeepsie, NY 12601-5400
USA

Such information may be available, subject to appropriate terms and conditions, including in some cases, payment of a fee.

The licensed program described in this information and all licensed material available for it are provided by IBM under terms of the IBM Customer Agreement, IBM International Program License Agreement, or any equivalent agreement between us.

Programming interface information

This document primarily documents intended Programming Interfaces that allow the customer to write programs to obtain services of ICKDSF.

This document also documents information that is NOT intended to be used as Programming Interfaces of ICKDSF. This information is identified where it occurs, either by an introductory statement to a chapter or section or by the following marking:

NOT Programming Interface Information

End of NOT Programming Interface Information

Trademarks

The following terms are trademarks of the International Business Machines Corporation in the United States, other countries, or both:

IBM	OS/390
AIX	PR/SM
AIX/ESA	RACF
BookManager	RAMAC
DFSMS/MVS	Resource Link
Enterprise Storage Server	System/390
ESCON	S/390
ES/9000	TotalStorage
FICON	VM/ESA
FlashCopy	VSE/ESA
IBMLink	z/OS
Multiprise	z/OS.e
MVS	zSeries
MVS/ESA	z/VM

Microsoft, Windows, Windows NT, and the Windows logo are trademarks of Microsoft Corporation in the United States, other countries, or both.

UNIX is a registered trademark of The Open Group in the United States and other countries.

Other company, product, and service names may be trademarks or service marks of others.

Glossary

This glossary defines technical terms and abbreviations used in this document. If you do not find the term you are looking for, see the index of the appropriate document, or view the *Glossary of Computing Terms* located at the *IBM Terminology* Web site:

<http://www.ibm.com/ibm/terminology/>

This glossary includes terms and definitions from:

- The *American National Standard Dictionary for Information Systems*, ANSI X3.172-1990, copyright 1990 by the American National Standards Institute (ANSI). Copies may be purchased from the American National Standards Institute, 11 West 42nd Street, New York, New York 10036. Definitions are identified by the symbol (A) after the definition.
- The *Information Technology Vocabulary* developed by Subcommittee 1, Joint Technical Committee 1, of the International Organization for Standardization and the International Electrotechnical Commission (ISO/IEC JTC1/SC1). Definitions of published part of this vocabulary are identified by the symbol (I) after the definition; definitions taken from draft international standards, committee drafts, and working papers being developed by ISO/IEC JTC1/SC1 are identified by the symbol (T) after the definition, indicating that final agreement has not yet been reached among the participating National Bodies of SC1.
- The *IBM Dictionary of Computing*, New York: McGraw-Hill, 1994.

The following cross-reference may be used in this glossary:

See: This refers the reader to (a) a related term, (b) a term that is the expanded form of an abbreviation or acronym, or (c) a synonym or more preferred term.

See also

Refers to a related term.

Contrast with

Refers to a contrasting term.

A

A-unit. The direct access storage unit that contains the controller functions to attach to the storage control.

An A-unit controls the B-units that are attached to it and is often referred to as a head of string.

AIX. Advanced Interactive Executive.

ALLOC. A space allocation parameter that indicates type, such as cylinders and tracks.

Allocation map. A record of how a volume (space) on a cylinder is to be used (allocated).

alternate track. On a direct access storage device, a track designated to contain data in place of a defective primary track. See also *primary track*.

ANALYZE DRIVETEST. ICKDSF command used to determine if a problem exists in the drive itself rather than in the media located on a volume.

ANALYZE SCAN. ICKDSF command used to determine if problems exist in the media which is located on a volume.

ANSI. American National Standards Institute.

APF. Authorized Program Facility.

attached device. See *dedicated device*.

B

B-unit. A direct access storage unit that attaches to the subsystem through an A-unit. A B-unit has no controller functions.

BDAM. Basic direct access method.

BPAM. Basic partitioned access method.

BSAM. Basic sequential access method.

C

cache. A random access electronic storage in selected storage controls used to retain frequently used data for faster access by the channel. For example, the 3990 Model 3 contains cache.

cache fast write. A form of fast write where the data is written directly to cache without using nonvolatile storage and is available for later destaging. This 3990 Model 3 Storage Control function should be used for data of a temporary nature, or data which is readily recreated, such as the sort work files created by the appropriate release of DFSORT.

CCHH. Cylinder, cylinder, head, head.

CCHHR. Cylinder, cylinder, head, head, record.

CCW. Channel command word.

CE. Customer engineer.

channel interface (CHL-I). The circuitry of a storage control that attaches storage paths to a host channel.

channel path. A connection between a processor and storage control along which signals and data can be sent to perform I/O requests.

channel set. A collection of channels that can be addressed by one of the processors of a processor complex.

CHPID. Channel path identifier.

CI. Control interval.

CKD. Count-key-data.

Class F. See *privileged class*.

CLIST. Command list.

cluster. See *storage cluster*.

CMS. Conversational Monitor System.

command retry. A combined channel and storage director procedure that allows a command in a channel program to be re-executed without causing an I/O interrupt.

concurrent media maintenance. The capability that enables a customer to perform maintenance on a track while allowing user access to that track's data.

control unit. A hardware unit that controls the reading, writing, or displaying of data at one or more input/output devices. See also *storage control*.

control unit address. The high order bits of the unit address, used to identify the control unit to the host system.

Note: The control unit address bits are set to zeros for ESCON[®] attachments.

controller. See *DASD controller* or *storage controller*.

count-key-data (CKD). A DASD data recording format employing self-defining record formats in which each record is represented by a count area that identifies the record and specifies its format, an optional key area that may be used to identify the data area contents, and a data area that contains the user data for the record. CKD is also used to refer to a set of channel commands that are accepted by a device that employs the CKD recording format. See also *extended count-key-data*.

correctable errors. See *errors, correctable* and *errors, uncorrectable*.

CP. Control program.

CP page. See *page*.

CSECT. Control section.

CSW. Channel status word.

CVAF. Common VTOC Access Facility.

CYL. Cylinder.

D

DADSM. Direct access device space management.

DASD. Direct access storage device.

DASD controller. The hardware component that provides DASD path control and data transfer functions.

DASD fast write. A form of fast write to cache where the data is written concurrently to cache and nonvolatile storage and automatically scheduled for destaging to the DASD. Both copies are retained in the storage control until the data is completely written to the DASD, providing data integrity equivalent to writing directly to the DASD. DASD fast write is available with a 3990 Model 3 Storage Control.

DASD subsystem. A DASD storage control and its attached direct access storage devices.

data check. An error detected in the bit pattern read from the disk. Some data checks are caused by hardware, some are caused by media, and others are the result of random events, such as transient electrical interference.

DCB. Data control block.

DD. Data definition.

dedicated device. An I/O device or line not being shared among users. The facility can be permanently assigned to a particular virtual machine by a VM/ESA directory entry, or temporarily attached by the resource operator to the user's virtual machine.

DFSMS. Data Facility Storage Management Subsystem.

DFSMS environment. An environment that helps automate and centralize the management of storage. This is achieved through a combination of hardware, software, and policies. See also *system-managed storage*.

destage. The asynchronous write of new or updated data from cache or nonvolatile storage to DASD. This is used only for the fast write and dual copy functions of 3990 Model 3. See also *fast write* and *write hit*.

device. A uniquely addressable part of a DASD unit that consists of a set of access arms, the associated disk surfaces, and the electronic circuitry required to locate, read, and write data. See also *volume*.

device address. Three or four hexadecimal digits that uniquely define a physical I/O device.

device ID. An 8-bit identifier that uniquely identifies a physical I/O device.

Device Level Selection (DLS). A DASD function available with 3380 Models AD4, BD4, AE4, BE4, AJ4, BJ4, AK4, BK4, and CJ2. With DLS, each of the two controllers in the DASD string has a path to all devices in the string, and any two devices in the 2-path DASD string can read or write data simultaneously. See *DLS mode*.

Device Level Selection Enhanced (DLSE). A DASD function providing four data transfer paths to each device in a 4-path DASD string. With DLSE, any four devices in a 4-path DASD string can read or write data simultaneously. See *DLSE mode*.

device number. Three or four hexadecimal digits that uniquely define a physical I/O device.

device path. The hardware within a 9340 Direct Access Storage Subsystem that transfers data between the DASD and a storage cluster.

DEVMAINT authority. DEVMAINT is a parameter on the OPTION directory control statement that allows an ICKDSF user to perform media maintenance against dedicated devices and minidisks.

MAINTCCW is a similar parameter, but it allows an ICKDSF user to perform media maintenance against dedicated devices only.

For more information on how to obtain DEVMAINT and MAINTCCW authority, see the *CP Planning and Administration* book applicable to your VM operating system.

director. See *storage director*.

DIRF. DADSM Interrupt Recording Facility. If a system fails, or a permanent I/O error occurs while allocating space or running a routine that updates the VTOC, the VTOC might be in error. To ensure that an error is recorded, the DADSM routines turn on a bit in the VTOC upon entry to a DADSM function, and, if no errors occur during processing, turn off that bit upon exiting from that function. This DIRF bit is bit 5 of the DS4VTOCI field of the format-4 DSCB.

DLS. Device Level Selection.

DLSE. Device level selection enhanced.

DLS mode. A mode of operation in a 3990 Storage Control that supports 3380 2-path strings. DLS mode

must be specified by the IBM service representative at installation for the 3990. See *single-path storage director*.

DLSE mode. A mode of operation in a 3990 Model 2 or 3 Storage Control that supports 3380 AJ4 and AK4 4-path strings and 3390 strings. DLSE mode must be specified by the IBM service representative at installation time for the 3990. See *multipath storage director*.

DSCB. Data set control block.

dual copy. A high availability function made possible by nonvolatile storage in a 3990 Model 3. Dual copy maintains two functionally identical copies of designated DASD volumes in the logical 3990 Model 3 subsystem, and automatically updates both copies every time a write operation is issued to the dual copy logical volume.

dual copy logical volume. A logical volume comprised of two physical devices with all data recorded twice, once on each device. A 3990 Model 3 Storage Control automatically ensures that both devices are updated with each write operation to the dual copy volume. Also called a duplex pair.

duplex pair. See *dual copy logical volume*.

duplex state. Two devices in a 3990 Model 3 subsystem are in duplex state when they have been made into a dual copy logical volume.

Dynamic Path Selection (DPS). DASD subsystem functions available with all 3380 heads of string except Model A04. These functions include:

- Two controllers providing data paths from the 3380 strings to the storage directors
- Simultaneous transfer of data over two paths to two devices, providing the two devices are on separate internal paths within the string
- Sharing DASD volumes by using System-Related Reserve and Release
- Providing dynamic path reconnect to the first available path.

E

EBCDIC. Extended binary coded decimal interchange code.

ECC. Error checking and correcting.

EOF. End-of-file.

emulated device. A device that is logically formatted on to a different device type such that the data and programming can be used without modification.

ENQ. A system macro used to serialize the access to a data set.

environmental data. Data the 3990 must report to the host; the data can be service information message (SIM) sense data, logging mode sense data, an error condition that prevents completion of an asynchronous operation, or a statistical counter overflow. The 3990 reports the appropriate condition as unit check status to the host during a channel initiated selection. Sense byte 2, bit 3 (environmental data present) is set to 1.

erase. To remove data from a data medium, leaving the medium available for recording new data.

ERDS. Error recording data set.

EREP. Environmental Record Editing and Printing.

ERP. Error Recovery Procedures.

error correcting code (ECC). A code designed to detect and correct error bursts by the use of check bytes.

errors, correctable. A data check whose error is correctable by use of ECC-correction bytes. The storage director or the system ERPs can correct this error with the aid of the ECC-correction code without rereading the record.

When ECC-correctable, the data is reconstructed to be the same as the data original written on disk storage. The data correction may be done by the subsystem as data is transferred to processor storage, or it may be done by the system (ERP) after the data is in processor storage. Although the data in processor storage is correct for use in processing, the data on the disk is not changed. The next attempt to read the data may again result in a data error. See also *errors, uncorrectable*.

errors, permanent. From the system perspective, an error is permanent if error recovery procedures performed by the operating system or storage subsystem cannot recover from the error condition.

errors, temporary. An error is temporary if the subsystem or system error recovery procedures are successful. A temporary error is only seen by the subsystem or system, and is never returned to the application.

errors, uncorrectable. A data check that the storage director cannot correct using the ECC-correction code bytes. Rereading or rereading with head offset is the only method available. See also *error correcting code*.

EXCP. Execute channel program.

extended count-key-data. A set of channel commands that use the CKD track format. Extended count-key-data uses the Define Extent and Locate Record commands to describe the nature and scope of a data transfer operation to the storage control to optimize the data transfer operation. See also *count-key-data* and *nonsynchronous operation*.

extent. A set of consecutively addressed tracks that a channel program can access. The limits of an extent are defined by specifying the addresses of the first and last tracks in the extent.

F

Factory functional verification data patterns (FFVDP). A predefined data pattern used to certify a volume at the factory.

fast dual copy. A dual copy capability where DASD fast write and dual copy are active concurrently.

fast write. In a 3990 Model 3 Storage Control, a write operation at cache speed that does not require immediate transfer of data to a DASD. The data is written directly to cache and/or nonvolatile storage and is available for later destaging. Fast write reduces the time an application must wait for the I/O operation to complete. See also *DASD fast write*, *cache fast write*, and *destage*.

FBA. Fixed-block architecture.

FBAVTOC. Fixed-block architecture volume table of contents.

fence. To separate one or more paths or elements from the remainder of the logical DASD subsystem. The separation is by logical boundaries rather than power boundaries. This separation allows isolation of failing components so that they do not affect normal operations.

FFVDP. Factory functional verification data patterns.

fixed-block-architecture (FBA). A DASD data recording format that stores data in blocks of fixed size; these blocks are addressed by block number relative to the beginning of the particular file. Contrast with *count-key-data (CKD)*.

formatting a volume. Refers to making a volume usable in a specific operating environment.

full-pack minidisk. A virtual disk that contains all of the addressable cylinders of a real DASD volume.

H

HA. Home address.

HDA. Head-disk assembly.

head-disk assembly (HDA). A field replaceable unit in a direct access storage device containing the disks and actuators.

head of string. The unit in a DASD string that contains controller functions. Also called the A-unit.

home address (HA). The first field on a CKD track that identifies the track and defines its operational status. The home address is written after the index point on each track.

I

ICKDSF. Device Support Facilities.

ID. Identifier.

identifier (ID). A sequence of bits or characters that identifies a program, device, controller, or system.

IML. Initial microcode load.

index point. The reference point on a disk surface that determines the start of a track.

indexed VTOC. The data set on which the location of the format-1 DSCBs of the VTOC are kept in an index for quick access by DADSM.

initial microcode load (IML). The act of loading microcode.

I/O. Input/output.

IOCDs. Input/output control data set.

I/O device. An addressable input/output unit, such as a direct access storage device, magnetic tape device, or printer.

IPL. Initial program load.

IPL bootstrap. A loader used in a computer to load part of an operating system needed to load the remainder of the operating system.

IPL text. IPL program records

ISMF. Interactive Storage Management Facility.

ISPF/PDF. Interactive System Productivity Facility/Program Development Facility.

J

JCL. Job control language.

JCS. Job control statement.

L

LAN. Local area network.

like devices. Devices that have the same track capacity and the same number of tracks per cylinder, that is, like devices can differ only in the number of cylinders per volume.

LSS. logical subsystem.

M

MAINTCCW authority. See *DEVMAINT authority*.

media. The disk surface on which data is stored.

media SIM. A message generated when a storage subsystem detects a problem with device media. You must perform media maintenance using ICKDSF to resolve the problem. See also *service information message (SIM)*.

medial initialization or medial INIT. Refers to using the INIT command to validate the home address and record 0 and then perform a minimal INIT on a volume.

megabyte (MB). 10⁶ bytes.

minidisk. A logical subdivision (or all) of a physical disk pack that has its own virtual device address, consecutive virtual cylinders (starting with virtual cylinder 0), and a VTOC or disk label identifier. Each user virtual disk is preallocated and defined by a VM/ESA directory entry as belonging to a user.

minimal initialization or minimal INIT. Refers to using the INIT command to write the volume label and VTOC on volumes for use by MVS or VSE operating systems.

multipath storage director. A storage director in a 3990 Storage Control operating in DLSE mode. Each multipath storage director in a storage control is associated with two storage paths. All storage paths in a multipath storage director respond to the same range of control unit addresses on a channel.

MVS. Multiple Virtual Storage.

N

nonsynchronous operation. A type of operation in which the channel and storage control activities required to end one command and initiate the next do not necessarily occur within the inter-record gap between two adjacent fields. Contrast with *synchronous operation*.

Note: With nonsynchronous operations, the channel can be slower than the device while reading information and faster than the device while writing information. Therefore, the time difference in processing a channel program depends on the current operating environment rather than on a property of the device or storage control.

NVS. Non-Volatile Storage.

O

orientation. A control state within a storage path that indicates the type of area (home address, count, key, or data field) that has just passed under the read/write head of the device.

OS. Operating system.

P

page. A fixed-length block that has a virtual address and can be transferred between real storage and auxiliary storage.

Peer-to-Peer Remote Copy (PPRC). PPRC is a hardware-based remote copy option that provides synchronous volume copy across storage subsystems for disaster recovery, device migration, and workload migration.

permanent errors. See *errors, permanent*.

pinned data. Data that is held in a 3990 Model 3 Storage Control, because of a permanent error condition, until it can be destaged to DASD or until it is explicitly discarded by a host command. Pinned data exists only when using fast write or dual copy functions.

primary device. One device of a dual copy volume. All channel commands to the dual copy logical volume are directed to the primary device. The data on the primary device is duplicated on the secondary device. See also *secondary device*.

primary surface checking. Consists of writing and reading back bit patterns for the specified device. Skip displacement checking is performed (for those devices that support skip displacement) only if a data check occurs. Performed by ICKDSF when NOSKIP is specified.

primary track. On a direct access storage device, the original track on which data is stored. See also *alternate track*.

privilege class. One or more classes assigned to a virtual machine user in a VM/ESA directory entry; each privilege class specified lets a user access a logical subset of the CP commands.

Class F privilege class corresponds to the service representative's administration functions. For more information, see the *CP Planning and Administration* book appropriate for your VM operating system.

PROP. Programmable Operator facility.

PSW. Program status word.

Q

quiesce. A function that makes one component of a storage subsystem temporarily unavailable to the processor while assuring that the remaining components are available for data transfer. This function is initiated by a service representative. Contrast with *resume*.

R

R0. Record zero.

RACF. Resource Access Control Facility.

release. A facility that allows other host systems to communicate with the reserved device. Contrast with *reserve*.

reserve. A facility for devices attached to multiple channel paths. It allows only one host system to communicate with the specified device. Contrast with *release*.

resume. A function that enables a component that has been quiesced. This function is initiated by a service representative. Contrast with *quiesce*.

REXX. Restructured Extended Executor.

RPS. Rotational position sensing.

S

SAM. Sequential access method.

SAPL. Stand-Alone Program Loader.

SCLP. Service Call Logical Processor facility.

secondary device. One of the devices in a dual copy logical volume that contains a duplicate of the data on the primary device. Unlike the primary device, a limited subset of channel commands may be directed to the secondary device. See also *primary device*.

service information message (SIM). A message, generated by a storage subsystem, that is the result of error event collection and analysis. A SIM indicates that some service action is required. See also *media SIM*.

Service Call Logical Processor Facility (SCLP). Provides a means of communicating between the control program and the service console (or compatible console). The SCLP allows the stand-alone version of ICKDSF to use the service console (or compatible console) as an input/output device.

SIM. Service information message.

SIM Alert message. An operator console message that notifies the operator that a SIM has been generated

and some service action is required. More information about the SIM can be obtained from EREP reports.

simplex state. A volume is in the simplex state if it is not part of a dual copy logical volume. Terminating a dual copy logical volume returns the two devices to the simplex state. In this case, there is no longer any capability for either automatic updates of the secondary device or for logging changes, as would be the case in suspended duplex state.

single-path storage director. A storage director in a 3990 or 3380 Model CJ2 operating in DLS mode. Each single-path storage director in the storage cluster is associated with one storage path. A storage path on a single-path storage director responds to a unique control unit address on the channel. A single-path storage director in a 3990 is like a storage director in a 3880.

SIO. Start I/O.

skip displacement. A method of skipping data cells so that any surface defect causing an error can be positioned in a gap rather than in a data area.

SML. MVS Storage Management Library.

SMS. Storage Management Subsystem.

specified range. Used in this book to describe the tracks that are the result of:

The combination of FROMRANGE and TORANGE,
or

The combination of CYLRANGE and HEADRANGE,
or

The entire volume, if all the range parameters are omitted.

SPID. Set path group ID.

SSL. Storage Subsystem Library.

storage cluster. A power and service region that runs channel commands and controls the storage devices. Each storage cluster contains both channel and device interfaces. Storage clusters in 9340 subsystems also perform the DASD controller functions.

storage control. The component in a storage subsystem that handles interaction between processor channel and storage devices, runs channel commands, and controls storage devices.

storage controller. A component in a storage subsystem that performs both the storage control and DASD controller functions. See also *storage control* and *DASD controller*.

storage director. In a 3990 storage control, a logical entity consisting of one or more physical storage paths in the same storage cluster. In a 3880, a storage

director is equivalent to a storage path. See also *storage path*, *single-path storage director*, and *multipath storage director*.

storage director ID. For 3880 Storage Control configurations, an 8-bit designation that uniquely identifies the storage director regardless of its selection address. It identifies to the service representative, by means of EREP, a failing subsystem component (storage director) without having to translate a selection address (which may have little relation to a physical address) to a physical component. The storage director ID is the number shown on the operator panels of 3880s and the attached DASD units. For 3990s, see *subsystem identifier (SSID)*.

Storage Management Subsystem (SMS). A DFSMS/MVS facility used to automate and centralize the management of storage by providing the storage administrator with control over data class, storage class, management class, storage group, and ACS routine definitions.

storage path. The hardware within the 3990 Storage Control that transfers data between the DASD and a channel. See also *storage director*.

storage subsystem. A storage control and its attached storage devices.

string. A series of connected DASD units sharing the same A-unit (or head of string).

subsystem identifier (SSID). A user-assigned number that identifies a DASD subsystem. This number is set by the service representative at the time of installation and is included in the vital product data.

subsystem. See *DASD subsystem* or *storage subsystem*.

surface analysis cylinder. The surface analysis cylinder is reserved by the system to contain a record of all the home addresses (HA) that have a skip displacement assigned at the time of manufacture or assigned subsequently by ICKDSF (depends on the device).

suspended duplex state. When only one of the devices in a dual copy logical volume is being updated because of either a permanent error condition or an authorized user command. All writes to the remaining functional device are logged. This allows for automatic resynchronization of both volumes when the dual copy logical volume is reset to the active duplex state.

SVC. Supervisor call instruction.

system-managed storage. Storage managed by the Storage Management Subsystem. SMS attempts to deliver required services for availability, performance, space, and security to applications. See also *DFSMS environment*.

synchronous operation. A type of operation in which all channel and storage control activities required to end one command and initiate the next must occur within the inter-record gap between two adjacent fields. Contrast with *nonsynchronous operation*.

T

temporary errors. See *errors, temporary*.

TIC. Transfer in channel.

TOD. Time-of-day.

track compatibility mode. See *3380 track compatibility mode*.

TRK. A subparameter of the SPACE parameter in a DD statement that specifies the allocation of space by tracks.

TSO. Time sharing option.

TTR. Track-Track-Record.

U

UCB. Unit control block.

uncorrectable errors. See *errors, uncorrectable*.

unit address. The last two hexadecimal digits of a device address or a device number.

Note: Often used interchangeably with *control unit address* and *device address*.

unlike device. Devices that have different track capacities or that have a different number of tracks per cylinder.

V

VBA. Variable blocked (with ANSI carriage control characters)

Verification data pattern. A predefined data pattern used to certify a volume at the factory.

VIER. VTOC index entry record containing pointers to each format-1 DSCB in the VTOC.

VIO. Virtual input/output.

VIXM. VTOC index map.

VM. Virtual machine.

VMDS. VTOC map of DSCBs containing a bit map that indicates free and allocated DSCBs in the VTOC.

volume. The DASD space identified by a common label and accessed by any of a set of related addresses. See also *device*.

volume label. The volume label uniquely identifies the volume to the operating system. Additional optional user labels are available containing information, such as user name and serial number.

VPSM. VTOC pack space map.

VSAM. Virtual storage access method.

VSE. Virtual Storage Extended.

VTOC. Volume table of contents.

VTOCIX. The data set on which the location of the format-1 DSCBs of the VTOC are kept in an index for quick access by DADSM.

W

write hit. When data requested by the write operation are in the cache.

Numeric

2-path string. A series of physically connected DASD units in which the head of string unit provides two data transfer paths that can operate simultaneously.

3380 track compatibility mode. A mode of operation in which a 3390 device manages its tracks as if they were 3380 tracks. Contrast with *3390 mode*.

3390 mode. The mode of the actuator when the entire capacity of the 3390 device is initialized. Contrast with *3380 track compatibility mode*.

4-path string. A series of physically connected DASD units in which the head of string provides four data transfer paths that can operate simultaneously. A 3390 4-path string requires one A-unit, while two 3380 Model AJ4/AK4 units are required for a 3380 4-path string.

Index

Special characters

- > or GT
 - comparison operators 20
- >= or GE
 - comparison operators 20
- < or LT
 - comparison operators 20
- = or EQ
 - comparison operators 20
- ≠ or NE
 - comparison operators 20

Numerics

- 0
 - condition code 20
- 0F0B exception conditions 99
 - detected by ANALYZE SCAN 79
 - issue INSPECT NOPRESERVE to fix 79
- 12
 - condition code 20
- 16
 - condition code 20
- 2-path string
 - definition 496
- 2105 7, 9, 112, 203, 359, 380
 - cascading 204
- 2105, CGROUP parameter 215
- 2105, ONLINSEC parameter 224
- 3270
 - console 61
- 3350 DASD 8
- 3370 device
 - emulated CKD 85
- 3375 device, installing 72
- 3375 or older HDA from the factory 72
- 3380 device, installing 71
- 3380 device, relocating 186
- 3380 track compatibility mode
 - definition 496
 - setting, example 189
- 3380 track compatibility mode, setting example 72
- 3380 track format 8
- 3380, 3390, or 9345, example 71
- 3390 device
 - converting to 3380 track compatibility mode 189
 - repairing a 4E4E SIM 273
- 3390 device, installing 71
- 3390 device, relocating 186
- 3390 mode
 - definition 496
- 3390-9, 3380 track compatibility mode restriction 72
- 3390, setting to 3380 track compatibility mode, example 72
- 3422
 - tape drive 58
- 370 mode not supported 459

- 3880 Model 21 Storage Control 8
- 3990 Storage Control 205
- 3995 Models 151 and 153
 - valid commands for 84
- 3995-151 or -153 device
 - emulating a CKD device on 84
- 4
 - condition code 20
- 4-path string
 - definition 496
- 8
 - condition code 20
- 9313 device
 - emulating a CKD device on 85
 - warning, emulating a CKD device on 86
- 9332 device
 - emulating a CKD device on 85
 - warning, emulating a CKD device on 86
- 9335 device
 - emulated CKD device on a 9313, 9332, or 9335 device 85
 - warning, emulating a CKD device on 86
- 9345 device, installing 71
- 9345 device, relocating 186

A

- A-unit
 - definition 489
- abbreviating commands and parameters 18
- about the Stand-Alone version 55
- ABSFORMAT subparameter, REFORMAT (CKD)
 - command 260
- accessibility 483
- adding IPL text 78, 145
 - INIT (CKD) command 145
- additional volume labels, reserving space for
 - INIT (CKD) command 146
 - INIT (FBA) command 316
- AIX
 - definition 489
- AIXVOL (CKD) command 89
 - changing volume label 93
 - errors reported by EXAMINE 92
 - formatting a cylinder 91
 - formatting a minidisk, example 92
 - formatting entire volume, example 93
 - formatting part of a volume, example 93
 - parameter description 89
- AIXVOL command 4, 6, 7, 9
- ALL parameter
 - ANALYZE (CKD) command 96
 - ANALYZE (FBA) command 298
 - MAPALT (FBA) command 338
- ALLCHPID parameter, ANALYZE (CKD) command 96
- ALLOC
 - definition 489

ALLOCATE parameter
 CPVOLUME (CKD) command 130
 CPVOLUME (FBA) command 305
 allocation
 changing for VM volumes 134, 136, 309
 allocation map
 creating for minidisk 135
 Allocation map
 definition 489
 allocation map, creating for minidisk
 CPVOLUME (FBA) command, description 310
 allocation, changing for VM volumes 311
 allocation, specifying type of
 CPVOLUME (CKD) command 132
 CPVOLUME (FBA) command 307
 ALLOWWRITE parameter, CONTROL (CKD)
 command 122
 ALLTRACKS parameter, INSPECT (CKD)
 command 164
 alternate blocks
 conditionally assigning, example 292
 printing a map of 339
 printing a map of (INIT (FBA) command) 316
 printing a map of (INSPECT (FBA) command) 327
 printing a map of, MAPALT (FBA) command,
 example 295, 341
 table of parameters used to assign 328
 unconditionally assigning, example 292, 332
 alternate track
 definition 489
 alternate tracks
 associations recorded on the volume 464
 conditionally assigning, example 81, 182
 printing a map of 87
 printing a map of, INSPECT (CKD) command,
 example 183
 reassigning 272
 table of parameters used to assign 176
 unconditionally assigning, example 82, 86, 182
 alternate tracks, printing a map of
 INIT (CKD) command 146
 ANALYZE (CKD) command 95
 CMS version 104
 diagnosing disk errors 78, 79
 diagnostic messages 107
 drive test 101
 path control restriction 101
 drive test example 105
 dual copy volumes 105
 EXAMPLES 105
 finding where INSPECT failed, example 83
 fixed-head error table 109
 logical path status table 111
 minidisk support 104
 movable head error table 108
 path controls when running analyze drive test 107
 path controls when running analyze drive test,
 table 107
 path status table 109
 RANGE parameters 103
 scan function 102, 103
 ANALYZE (CKD) command (*continued*)
 scan function example 105
 syntax 95
 verifying data records 102
 with RACF protection 95
 ANALYZE (FBA) command 297
 analyzing part of a volume 294
 conditions assumed when running 301
 data verification test 300
 diagnostic messages 303
 drive test 299
 drive test example 290, 301
 finding where INSPECT failed, example 291
 minidisk support 301
 movable-head error table 303
 ANALYZE command 4, 6, 7, 8, 31, 380
 ANALYZE DRIVETEST
 definition 489
 ANALYZE DRIVETEST processing 360, 369, 370
 ANALYZE SCAN
 definition 489
 analyzing volumes with the
 CMS Version 302
 Stand-Alone version 105, 301
 VSE version volume 302
 ANSI
 definition 489
 APAR PQ73189 10
 APF
 definition 489
 APF (Authorized Program Facility) 34
 application program, calling ICKDSF 481
 ASSGN statement (VSE) 51
 ASSIGN parameter
 INSPECT (CKD) command 165
 INSPECT (FBA) command 325
 ASSIGN specified 368
 assigning alternate blocks
 conditionally, example 292
 table of parameters used to assign 328
 unconditionally, example 292, 332
 assigning alternate tracks 176
 conditionally 81
 conditionally, example 81, 182
 reassigning alternate tracks 272
 table of parameters used to assign 176
 unconditionally, example 82, 86, 182
 assumed conditions when running ANALYZE 301
 attached device
 definition 489
 authority, MAINTCCW 67
 Authorized Program Facility (APF) 34
 authorizing access with RACF 32
 automated recovery bit 215
 AVAILABLE parameter, INSPECT (CKD)
 command 165

B

batch mode for VSE 50

BLOCKRANGE parameter
 ANALYZE (FBA) command 298
 INIT (FBA) command 314
 INSPECT (FBA) command 326

blocks
 formatting with CPVOLUME (FBA) command 309
 preventing destruction of data on 327
 reclaiming, example 293

blocks, alternate
 conditionally assigning, example 292
 printing a map of 316, 327
 printing a map of, example 295, 339, 341
 table of parameters used to assign 328
 unconditionally assigning, example 292, 332

BOOTSTRAP parameter
 INIT (CKD) command 139
 REFORMAT (CKD) command 259

bootstrap records, IPL
 contents 463

bootstrap records, IPL (writing)
 REFORMAT (CKD) command 259

bootstrap records, IPL writing
 INIT (CKD) command 139

bridge, FICON 113

BUILDIX (CKD) command 115
 building a VTOC index, example 118
 converting indexed VTOC to OS format 78, 117
 converting OS VTOC to indexed format 78, 116
 description 115
 dual copy volumes 115
 examples 117
 restriction 115
 with RACF protection 115

BUILDIX command 4, 6, 7, 9

C

cached storage control 8

calculating size of VTOC and VTOC index 465

calling ICKDSF, from an application program 481

CARD input device specification 61

CASCADE parameter 222

CASCADE support, PQ72465 225

cascaded pairs 199

cascading, 2105 204

cascading, how PPRC works 196

cascading, using 198

CCW (channel command word) 67

CD-ROM version 58

CD-ROM, loading the Stand-Alone 62

CE cylinder
 drive test error summary 107
 preserving data during INSPECT (CKD)
 command 171

CGROUP parameter 215, 382

CHAN entry in path status table 109

changing the volume serial number and owner
 identification 289

changing volume allocation
 CPVOLUME (CKD) command, example 136
 CPVOLUME (FBA) command, example 311

changing volume allocation (*continued*)
 VM volumes 134
 CPVOLUME (FBA) command, description 309

changing volume serial number and owner
 identification 77, 289
 AIXVOL (CKD) command, example 93
 REFORMAT (CKD) command, example 264, 267
 REFORMAT (FBA) command, example 343

channel command word (CCW) 358, 379, 384

channel command words (CCW) 67

channel connection address (CCA) 382

Channel Connection Address (CCA) 382

CHANNEL entry in path status table 109

channel status word (CSW) 68, 358, 379, 384

channel-attached
 3422 tape drive 58

CHANSET entry in path status table 109

CHECK function 367

CHECK parameter 83
 INIT (FBA) command 315
 INSPECT (CKD) command 166
 INSPECT (FBA) command 326
 specifying CHECK(n) values 473

checking
 primary, for FBA devices 472
 surface 471

checking and correcting (ECC) 14

checking disk surfaces
 example (FBA) 291
 with INSPECT 80

checking primary, for CKD devices 472

checking skip displacement 472

checking, primary 471

checkpoint data (CKD)
 handling of checkpoint data 280
 previous command 280

checkpoint, resuming from after failure 154, 188, 319
 REVAL (CKD) command 274

CHPID entry in path status table 109

CHPID parameter, ANALYZE (CKD) command 96

CHPID path 352

CKD (count-key-data) 349, 358

CKD devices, examples 71

class F user authority 67

CLEARFENCE parameter 87

CLEARFENCE parameter, CONTROL (CKD)
 command 122

clearing a storage control
 CONTROL (CKD) command, description 123
 CONTROL (CKD) command, example 125

clearing fence status
 CONTROL (CKD) command 124
 CONTROL (CKD) command example 125, 126
 CONTROL (CKD) command, example 87

closing single quotation mark 358

CLUSTER entry in path status table 109

CMS tasks, flowchart 39

CMS version
 initializing a volume, example 160
 minidisk support 104, 156, 181

CMS version minidisk support 319

CMS version, flowchart 39
 codes, return, for password-protected data sets 476
 codes, return, for the IBM module 476
 comma, redundant 357
 command
 AIXVOL 4, 6, 7, 9
 AIXVOL (CKD) 89
 ANALYZE 4, 6, 7, 8, 31, 380
 ANALYZE (CKD) 95
 ANALYZE (FBA) 297
 BUILDIX (CKD) 115
 BUILDIX 4, 6, 7, 9
 CONTROL 4, 6, 7, 87
 CONTROL (CKD) 121, 123
 CPVOLUME 4, 6, 7, 9
 CPVOLUME (CKD) 129
 DETACH 379
 DUPLEX 3
 FREEZE 202, 228
 INIT 4, 6, 7, 349, 351
 INIT (FBA) 313
 INIT NOVALIDATE 9
 INSPECT 4, 6, 7, 8, 32, 350, 351
 INSPECT (CKD) 161
 INSPECT (FBA) 323
 INSTALL (CKD) 185
 IODELAY 4, 6
 IODELAY (CKD) 191
 IODELAY (FBA) 335
 MAPALT 4, 6
 MAPALT (FBA) 337
 mode for VSE 51
 mode restrictions 52
 MOUNT 35
 PPRC ESTPAIR 199
 PPRCOPY 4, 6, 7, 9, 195
 PPRCOPY DELPATH 216
 PPRCOPY ESTPATH 208
 REFORMAT 4, 6, 7, 9, 77
 REFORMAT (CKD) 257
 REFORMAT (FBA), CMS version 341
 REVAL 4, 6, 7, 8
 RUN 202
 TRKFMT 4, 6, 7
 TRKFMT (CKD) 275
 command statement syntax 17
 commands and parameters, abbreviating 18
 commands that operate on a minidisk from a guest
 operating system 67
 comments, ICKDSF commands 19
 comparison operators
 > or GT 20
 >= or GE 20
 < or LT 20
 = or EQ 20
 ≠ or NE 20
 completing the installation procedure 71
 concurrent media maintenance 36
 condition code
 0 20
 12 20
 condition code (continued)
 16 20
 4 20
 8 20
 LASTCC 19, 20
 MAXCC 19, 20
 condition code 0F0B
 issue INSPECT NOPRESERVE to fix 79
 conditionally assigning alternate blocks 292
 conditionally assigning alternate tracks 81
 conditionally assigning alternate tracks, example 182
 configuration checking 10
 CONFIGURE(DISPLAY) parameter, CONTROL (CKD)
 command 123
 conflicting keyword parameters 18
 consistency, secondary PPRC volume 229
 console, Service Call Logical Processor Facility
 (SCLP) 59
 continuation lines 18, 21
 CONTINUE data existed 369
 CONTINUE parameter
 INIT (CKD) command 140
 INIT (FBA) command 315
 restriction (0671, 9313, 9332, or 9336) 315
 restriction (CMS) 315
 CONTROL (CKD) command 121
 clearing a storage control 123
 clearing a storage control example 125
 clearing fence status 87, 124
 clearing fence status example 125, 126
 discarding data pinned in cache 125
 discarding data pinned in cache example 126
 examples 125
 with RACF protection 121
 write-allowing WRITE INHIBITed device 123
 write-allowing WRITE INHIBITed device,
 example 125
 CONTROL command 4, 6, 7, 87
 control command execution, condition codes 19
 control processing 19
 controlling the level of surface checking 174
 converting 3390 to 3380 track compatibility mode,
 example 189
 converting from one PPRC volume state to
 another 200
 converting OS VTOC to indexed format 78, 116, 117
 copying data to different device size
 CPVOLUME (CKD) command 135
 CPVOLUME (FBA) command 310
 correctable versus uncorrectable 14
 count key data (CKD) 4, 11, 380
 CP pages
 definition 129
 CP pages formatting 308
 CP TRACE CCW command 67
 CP-owned volumes 129
 CPLIST EXEC, example 43
 CPUID, unable to determine
 VSE EXTRACT failed 459
 CPVOLUME (CKD) command 129, 135
 changing volume allocation 134, 136

CPVOLUME (CKD) command (*continued*)
 creating minidisk volume allocation map,
 example 135
 formatting a cylinder 133
 formatting entire volume, example 76, 136
 formatting part of a volume, example 76, 136
 parameter description 130

CPVOLUME (FBA) command
 changing volume allocation
 description 309
 changing volume allocation example 311
 creating minidisk volume allocation map,
 description 310
 description 305
 formatting blocks 0-15 309
 formatting entire volume, example 289, 310
 formatting part of a volume, example 311
 parameter description 305

CPVOLUME command 4, 6, 7, 9
 creating an ICKDSF Stand-Alone IPL tape
 using CMS 58
 using MVS 58

creating minidisk allocation map
 CPVOLUME (CKD) command, example 135
 CPVOLUME (FBA) command, description 310

CSW (channel status word) 68
 CURRENT specified 369
 CVAF (common VTOC access facility) 354
 CYCLES parameter 279
 CYCLES(n) parameter 277
 cylinder 0, track 0 layout (CKD devices) 463
 cylinder size 419
 cylinder, formatting
 for AIX use 91
 for VM use 133
 cylinders 93
 CYLRANGE parameter 98, 276, 280
 ANALYZE (CKD) command 103
 INIT (CKD) command 140
 INSPECT (CKD) command 166, 175
 REVAL (CKD) command 271

D

DADSM (direct access device space
 management) 354
 DASD physical characteristics 13
 DASD storage media 13
 data area, CKD devices 461
 data check
 on AIX volume 92
 on CP-formatted cylinder 134
 data checks 14
 DATA parameter
 INIT (CKD) command 141
 REVAL (CKD) command 272
 data record 461
 data set
 password-protected, return codes 476
 printed output 28
 data set security and protection 31

data set security and protection (*continued*)
 in VSE 53
 providing passwords for 147, 169, 279
 securing data 475

data set, security 32
 data-secured files 53
 data, preventing destruction during inspection
 INSPECT (CKD) command 170
 data, scanning, on part of a volume 79
 database consistency automation 229
 date, specifying in Stand-Alone version 63
 DDNAME parameter
 ANALYZE (CKD) command 95
 BUILDIX (CKD) command 115
 INSPECT (CKD) command 163
 REFORMAT (CKD) command 258
 REVAL (CKD) command 270
 TRKFMT (CKD) command 276

DEDICATE directory control statement 39
 dedicated device 39
 defective blocks
 inspecting in Stand-Alone version 331
 reclaiming, INIT (FBA) command 317
 defective tracks
 reclaiming (INSPECT) 172
 define input and output devices 62
 degree of repeatability 14
 degree of visibility 14
 delay per I/O, setting
 IODELAY (CKD) command, example 192
 IODELAY (FBA) command, example 336
 deleting pairs 226
 deleting Peer-to-Peer Remote Copy paths 216
 delimiters 18
 DEQ macro 35
 DETACH command 379
 DETAIL parameter, MAPALT (FBA) command 338
 detecting hardware problems with DRIVETEST 299
 detection of 0F0B conditions 99
 determining the VTOC size and location 77
 device
 identifying the type 167
 device exceeds the maximum cylinder size 419
 device formatting 76
 Device Level Selection Enhanced (DLSE) 3
 Device NED (node element descriptor) 10
 device type, link addresses 435
 device, identifying the type 141
 device, installing 71
 DEVICETYPE parameter
 INSPECT (CKD) command 167
 DEVMAINT authority authority
 ICKDSF commands available, table 47
 DEVMAINT authority authority, VM 47
 DFSMS-managed volume 153
 DIAGNOSE 08 379
 diagnostic messages
 ANALYZE (CKD) command 107
 ANALYZE (FBA) command 303
 diagnostic output, MAPALT (FBA) command 339
 different device size, copying data 135

DIRECTIO parameter 3, 181
 ANALYZE (CKD) command 96
 INSPECT (CKD) command 167
 disability 483
 disaster recovery 198
 discarding data pinned in cache 125, 126
 disk surfaces
 checking, example 291
 problem determination 290
 displacement, skip 472
 display panels, ISMF 28
 displaying volume information
 CPVOLUME (CKD) command 135
 CPVOLUME (FBA) command 309
 DO-END statement, example of 22
 DOSVTOC parameter, INIT (CKD) command 141
 DRCT subparameter
 CPVOLUME (CKD) command 132
 CPVOLUME (FBA) command 307
 drive problems, investigating suspected 79
 drive test
 path status table 109
 DRIVETEST parameter
 ANALYZE (CKD) command 97
 ANALYZE (FBA) command 298
 dual copy volumes
 ANALYZE (CKD) command 105
 BUILDIX (CKD) command 115
 CONTROL (CKD) command 121
 initialization restriction 156
 INSPECT (CKD) command 181
 INSTALL (CKD) command, restriction 185
 medial INIT restriction 152
 minimal INIT restriction 151
 restriction, INSPECT (CKD) command 181
 specifying primary or secondary volumes 167
 specifying primary or secondary volumes, ANALYZE (CKD) command 96
 DUPLEX command 3
 duplex state
 ANALYZE (CKD) command 105
 BUILDIX (CKD) command 115
 CONTROL (CKD) command 121

E

ECC (error checking and correcting) 14
 ELSE clause
 IF statement 21
 null 23
 EMU(n) parameter
 INIT (CKD) command 146
 INSPECT (CKD) command 169
 EMUALL parameter
 INIT (CKD) command 146
 INSPECT (CKD) command 169
 emulating a CKD device
 initialization restriction 152
 minimal initialization 160
 on a 3370 85
 on a 3995-151 or -153 84
 emulating a CKD device (*continued*)
 on a 9313, 9332, or 9335 device 85
 on FBA device 146, 169
 emulating a CKD device on an FBA device 295
 emulating devices 84
 END clause, IF statement 23
 ending a command 19
 ending ICKDSF in the Stand-Alone version 63
 ENQUEUE failed, VTOC 430
 environment, setting up for Peer-to-Peer Remote Copy 204
 ERASEDATA parameter 275, 277
 erasing a volume
 INIT (CKD) command, example 87
 INIT (FBA) command, example 295
 ERDS (error recording data set) 15, 79
 ERP (error recovery procedures) 14, 15
 error
 condition code 0F0B 99
 conditions in Stand-Alone version 64
 diagnosis, disk 290
 format, on CP-formatted cylinder 134
 I/O, unexpected 103
 reported by EXAMINE 92
 error handling 215
 error notification 15
 error recording data set (ERDS) 15, 79
 error recovery procedures (ERP) 14, 15
 error table
 fixed-head, ANALYZE (CKD) command 109
 movable head, ANALYZE (CKD) command 108
 movable-head (ANALYZE - FBA) 303
 ESCON 113
 ESCON channels 205
 ESCON/FCP 196
 establishing Peer-to-Peer Remote Copy pairs 219
 establishing Peer-to-Peer Remote Copy paths 208
 EXAMINE parameter
 AIXVOL (CKD) command 89, 92
 CPVOLUME (CKD) command 130
 CPVOLUME (FBA) command 305
 examining
 pages for errors 309
 volumes for errors 134
 example of
 3380 volume map 462
 ANALYZE command 301
 CPVOLUME command 136, 310
 formatting a minidisk (CKD) 92
 INIT command 156, 319
 INSPECT command 182, 331
 INSTALL command 189
 installing a new device 287
 IODELAY command 192, 336
 MAPALT command 339
 mapping a full volume with the Stand-Alone version 339
 REFORMAT command 342
 REFORMAT Command 263
 reformatting a volume for MVS 264
 REVAL Command 274

- exception condition 0F0B 79, 99
- EXEC statement, executing ICKDSF
 - in VSE batch mode 50
 - in VSE command mode 51
 - under CMS 42, 43
- EXEC, CMS, to copy Stand-Alone ICKDSF to tape, example 58
- EXEC, CPLIST, example 43
- executing
 - VSE version of ICKDSF in batch mode, example 51
- existing data, writing over on previously initialized volume
 - INIT (CKD) command 148
- existing logical paths 215
- expanding the VTOC and the index 265
- extended distance mode 196
- EXTINDEX parameter 77
 - REFORMAT (CKD) command 259
- EXTVTOC parameter 77
 - REFORMAT (CKD) command 259

F

- FACILITY class profile, RACF 35
- factory functional verification data patterns (FFVDP) 73
- factory, installing a device from 71
- FAILOVER and FAILBACK 202, 223, 254
- failure, resuming after 188, 319
 - REVAL (CKD) command 274
- FBA (fixed block architecture) 349
- FBA blocks
 - conditionally assigning, example 292
 - inspecting in Stand-Alone version 331
 - unconditionally assigning, example 292, 332
- FBAVTOC parameter 469
 - INIT (FBA) command 315
 - space requirements 470
- FBAVTOC, writing 289
- FCP (Fibre Channel Protocol), establishing paths 211
- FCP (fibre channel protocol), identify PPRC 218
- FCP, type of F 112
- FCPPATHS parameter 211, 218
- fence status, clearing 125, 126
- FFVDP, validating and writing 73
- Fibre Channel Protocol (FCP), establishing paths 211
- fibre channel protocol (FCP), identify PPRC 218
- FICON bridge 113
- FILLER parameter, CPVOLUME (CKD) command 131
- filler records 131
- finding where INSPECT failed
 - ANALYZE (CKD) command, example 83
 - ANALYZE (FBA) command, example 291
- fixed block architecture (FBA) 4, 11, 367, 384
- fixed block architecture VTOC (FBAVTOC) 469
- fixed-head error table (CKD) 109
- FIXSIM(4E4E) parameter, REVAL (CKD) command 272
- Flash Copy information 123
- flowchart showing ICKDSF tasks 49, 56
- FMTMDVOL INPUT A, example 44
- FORCE parameter 215, 218, 386

- FORCE parameter (*continued*)
 - INSPECT (CKD) command 167
 - warning on use of 181
- force removal of existing paths 218
- format error
 - on AIX volume 92
 - on CP-formatted cylinder 134
- FORMAT parameter
 - AIXVOL (CKD) command 89
 - CPVOLUME (CKD) command 130
 - CPVOLUME (FBA) command 305
- format tracks 461
- formatting
 - CP volumes for a specific VM operating system 305
 - minidisk (CKD), example 92
 - minidisk (FBA), example 289
 - part of a volume (FBA), example 311
 - tracks and reassigning alternate tracks 272
- formatting a cylinder
 - for AIX use 91
 - for VM use 133
- formatting a minidisk (CKD) example 76
- formatting devices 76, 289
- formatting entire volume (CKD)
 - CP-owned volumes 129
 - for AIX use, example 93
 - for VM use, example 76, 136
- formatting entire volume (FBA)
 - blocks 0-15, description 309
 - for VM use, example 289, 310
- formatting pages 308
- formatting part of a volume (CKD)
 - for AIX use, example 93
 - for VM use, example 76, 136
- free space information 481
- FREEZE command 202, 228
- Freeze/Run, using 202
- FROMRANGE parameter 97, 277, 280
 - ANALYZE (CKD) command 103
 - INIT (CKD) command 142
 - INSPECT (CKD) command 168, 175
- full duplex, volumes 199
- full-pack minidisk 39
- functional data verification test 352

G

- general users, without special authority, support 46
- Guarantee Storage Path operation 381
- guest operating systems, running ICKDSF on 67

H

- HA/RO validation 352
- handling of checkpoint data 280
- hardware documents xx
- hardware requirements, Peer-to-Peer Remote Copy 203
- head-disk assembly (HDA) 71
- HEADRANGE parameter 98, 277, 280
 - ANALYZE (CKD) command 103

HEADRANGE parameter *(continued)*
 INIT (CKD) command 143
 INSPECT (CKD) command 168, 175
 REVAL (CKD) command 272
 HOLDIT parameter
 INSPECT (CKD) command 170
 INSPECT (FBA) command 327, 329
 restriction (0671, 9313, 9332, or 9336) 327
 home address
 validating (INIT - CKD) 149
 home address (HA) 352
 how PPRC works 195
 how track associations are recorded 464

I

I/O delay, setting
 IODELAY (CKD) command, example 192
 IODELAY (FBA) command, example 336
 I/O errors, unexpected 103
 IBM module, return codes 476
 IBM TotalStorage Enterprise Storage Server (ESS) 9, 205
 IBM-supplied user exit routine, replacing 477
 ICK31054I 211, 218
 ICKDSF commands, table 65
 ICKMCLVL macro 3, 479
 ICKSADSF COREIMAG file (CMS) 58
 ICKSADSF file (MVS) 58
 identifying a volume
 AIXVOL (CKD) command 90
 ANALYZE (CKD) command 95
 ANALYZE (FBA) command 297
 BUILDIX (CKD) command 115
 CONTROL (CKD) command 121
 CPVOLUME (CKD) command 130
 CPVOLUME (FBA) command 306
 INIT (CKD) command 138
 INIT (FBA) command 314
 INSPECT (CKD) command 163
 INSPECT (FBA) command 324
 INSTALL (CKD) command 187
 MAPALT (FBA) command 337
 of a dual copy pair, INSPECT (CKD) command 167
 REFORMAT (CKD) command 258
 REFORMAT (FBA) command 341
 REVAL (CKD) command 270
 TRKFMT (CKD) command 276
 identifying the console in the Stand-Alone version 61
 identifying the input device in the Stand-Alone version 61
 identifying the output device in the Stand-Alone version 62
 identifying type of device
 INIT (CKD) command 141
 INSPECT (CKD) command 167
 identifying volume pairs 205
 IDisk 9
 IF statement 21
 IF-THEN-ELSE command sequence 357
 IF-THEN-ELSE DO-END statement, example of 23
 IF-THEN-ELSE statement 21
 important:
 issue a MOUNT command 35
 indefinite status condition, resetting 125, 126
 INDEX parameter, INIT (CKD) command 143
 index point on track 461
 index, VTOC 465
 index, VTOC building example 118
 indexed VTOC, converting to OS format 78, 117
 INIT (CKD) command
 adding IPL text 145
 CKD devices, example 73
 description 137
 dual copy volumes 156
 erasing a volume, example 87
 examples 156
 initializing a volume for CMS use, example 160
 initializing a volume for MVS, example 156, 159
 initializing a volume for VSE use, example 160
 initializing a volume in the Stand-Alone version, example 159
 installing a new device 72
 medial initialization 151
 minidisk support, CMS version 156
 minimal initialization 151
 processing in a shared DFSMS environment 153
 relevant parameters for rewriting data 82
 required parameters 138
 restoring FFVDP 156
 restoring volume to factory specs, example 87
 resuming after job or system failure 154
 shared-system processing 153
 specifying range 154
 validating and writing FFVDP 73
 with RACF protection 138
 writing VTOC 289
 writing VTOC, example 77
 INIT (FBA) command 313
 erasing a volume, example 295
 installing a new device, example 287
 reclaiming blocks, example 293
 resuming after job or system failure 319
 resuming from a checkpoint, example 288
 under CMS version 319
 INIT command 4, 6, 7, 349
 INIT NOVALIDATE command 9
 INITEM utility 85
 initialization for open-system DASD
 definition 137
 description 152
 initializing
 minidisk 160, 320
 replaced HDA with a minimal INIT 287
 volumes with the Stand-Alone version 320
 initializing (FBA)
 maximal level 318
 maximal restriction (0671, 9313, 9332, and 9336) 318
 minidisk in a Stand-Alone version 320
 minimal level 318

- initializing (FBA) *(continued)*
 - minimal restriction (0671, 9313, 9332, and 9336) 318
 - volume in a Stand-Alone version 320
- initializing a volume 153
- initializing a volume (CKD)
 - resuming after job or system failure 154
- initializing a volume (FBA)
 - resuming after job or system failure 319
 - VSE version, example 320
- input device, Stand-Alone version 61
- input file, executing ICKDSF, CMS version 44
- INSPECT (CKD) command 161
 - assigning alternate tracks, table 176
 - CMS version 181
 - concurrent media maintenance 180
 - conditionally assigning alternate tracks 81
 - conditionally assigning alternate tracks, example 182
 - controlling level of surface checking 174
 - data preservation 180
 - defective track, rewriting the data of 177
 - dual copy volume restriction 181
 - examples of 182
 - finding where INSPECT failed, example 83
 - inspecting volumes with the MVS Version 182
 - minidisk support 181
 - parameter description 161
 - parameters to assign alternate tracks, table 176
 - preserving data 170, 179
 - printing a map of alternate tracks, example 87
 - reclaiming tracks, example 82
 - recovering data after job or system failure, example 83, 178
 - recovering data, warning 178
 - resource serialization 177
 - specifying range 175
 - surface checking, example 80
 - syntax 163
 - unconditionally assigning alternate tracks 82, 86
 - under CMS 181
 - with RACF protection 161
 - writing data from backup location 170, 179
- INSPECT (FBA) command 323
 - CMS version 331
 - conditionally assigning alternate blocks example 292
 - finding where INSPECT failed, example 291
 - parameter description 323
 - preserving data 329
 - preserving data, example 293
 - recovering data after job or system failure, example 330
 - surface checking part of a volume, example 293
 - table of parameters to assign alternate blocks 328
 - unconditionally assigning alternate blocks 332
 - unconditionally assigning alternate blocks example 292
 - unconditionally assigning alternate blocks, Stand-Alone example 332
 - warning 329
- INSPECT (FBA) command *(continued)*
 - writing data from backup location 329
- INSPECT (FBA) command, example 330
- INSPECT command 4, 6, 7, 8, 32, 350, 351
- INSPECT, preserving data 36
- inspecting
 - CKD minidisks, CMS version, example 184
 - minidisk (CKD), example 184
 - range of cylinders for errors 93
 - volumes with the CMS version 333
 - volumes with the Stand-Alone version 331
 - volumes with the VSE version 332
- inspecting a volume (CKD)
 - controlling level of surface checking 174
- inspecting CKD volumes
 - containing VSAM data sets with NOPRESERVE, example 477
 - duplex pair, example, MVS offline 183
- inspecting FBA minidisks
 - CMS version, example 333
- inspecting FBA volumes
 - checking blocks, VSE example 332
 - Stand-Alone version 331
- INSTALL (CKD) command 185
 - converting 3390 to 3380 track compatibility mode, example 189
 - initializing a volume, example 189
 - installing a new 3380, 3390, or 9345 71
 - installing relocated devices 186
 - mode change warning 188
 - parameter description 187
 - resuming after job or system failure 188
 - shared-system processing 188
 - with RACF protection 186
- installing a new 3380, 3390, or 9345, example 71
- Interactive Storage Management Facility (ISMF) 25, 28
- Interface Information table 112
- interfaces, programming 475
- intermediate site 198
- Internal Disk Feature 9
- interpreting error conditions 64
- investigating suspected drive problems 79, 290
- invoking ICKDSF
 - with an input file 44
- invoking ICKDSF with a CMS EXEC 43
- invoking interactively from the console, example 42
- IODELAY (CKD) command 191
 - examples of 192
 - parameter description 191
 - syntax 191
 - with RACF protection 191
- IODELAY (FBA) command 335
 - parameter description 335
- IODELAY command 4, 6
- IPL bootstrap records
 - contents (CKD) 259, 463
- IPL bootstrap records, writing
 - INIT (CKD) command 139
- IPL error PSW codes, table 64
- IPL program
 - IPL text, adding 145

- IPL program (*continued*)
 - maximum size by device type 144
 - writing on a volume 78
- IPL program, maximum size by device type
 - REFORMAT (CKD) command 261
- IPL program, writing
 - with user-supplied records, example 260
- IPL program, writing on a volume
 - CMS version, example 266
 - from another volume, example 264
 - online mode, example 264
- IPL tape, creating, example 58
- IPL, no load parm specified 61
- IPL, stand alone program loader 60
- IPL, with a load parm specified 61
- IPLDD parameter
 - INIT (CKD) command 144
 - REFORMAT (CKD) command 260
- IPLing the Stand-Alone ICKDSF 59
- ISMF panels to run ICKDSF, using 28
- ISMF PRIMARY OPTION MENU - z/OS DFSMS V1 R3
 - panel, example 29
- ISPF PRIMARY OPTION MENU panel, example 28
- IXVTOC parameter, BUILDIX (CKD) command 116

J

- JCL, running ICKDSF with, example 27
- Job Control Commands (JCC) 51
- job failure
 - recovering data 330
- job failure, resuming 154
- JOB statement, executing ICKDSF in MVS 27
- JOBCAT DD statement, executing ICKDSF in MVS 27

K

- KEEPIT parameter
 - INSPECT (CKD) command 170
 - INSPECT (FBA) command 327, 329
 - restriction (0671, 9313, 9332, or 9336) 327
- key area 461
- keyboard 483
- keyword parameters, conflicting 18

L

- LABEL parameter
 - AIXVOL (CKD) command 89
 - CPVOLUME (CKD) command 130
 - CPVOLUME (FBA) command 305
- label record format, FBA devices 469
- LABELS parameter
 - INIT (CKD) command 146
 - INIT (FBA) command 316
- large volume support 362, 419
- LASTCC (last condition code) 357
- LASTCC condition code 19, 20, 21
- licensed internal code 205
- limiting the use of resources with the Authorized
 - Program Facility 34

- LIMITS parameter 98
 - ANALYZE (FBA) command 298
 - MAPALT (FBA) command 338
- line continuations 18, 21
- link addresses 435
- LIST parameter
 - CPVOLUME (CKD) command 130
 - CPVOLUME (FBA) command 305
- load from CD-ROM or SERVER task 59
- load parm on the IPL panel 59
- loading registers 475
- local site 198
- logical path status table
 - ANALYZE (CKD) command 111
- Logical Subsystem (LSS) number 359
- logical subsystem number 215
- logical subsystem number (LSS)
 - determining 253
- long distance data migration 200
- LookAt message retrieval tool xxiii
- LSS parameter 215, 227, 229, 231, 435

M

- macro
 - DEQ 35
 - ICKMCLVL 3
 - RESERVE 35
- macro, ICKMCLVL 479
- MAINTCCW authority 67
 - definition 493
- managed volume, STORAGEGROUP parameter 148
- managing asynchronous PPRC
 - extended distance mode 196
- managing the Peer-to-Peer Remote Copy system 243
- map of DSCBs (VMDS) 465
- MAP parameter
 - INIT (CKD) command 146
 - INIT (FBA) command 316
 - INSPECT (CKD) command 169
 - INSPECT (FBA) command 327
 - restriction (0671, 9313, 9332, or 9336) 316, 327
- MAPALT (FBA) command 337
 - diagnostic output 339
 - example 295
 - report output 338
- MAPALT command 4, 6
- mapping
 - VSE version volume 340
- mapping alternate blocks
 - MAPALT (FBA) command, example 341
- mapping alternate tracks 146
- maps, index space
 - VIXM, VMDS, VPSM 466
- MAXCC (highest condition code) 357
- MAXCC condition code 19, 20, 23
- maximal initialization
 - definition 137
 - FBA devices 318

- maximum size
 - INIT (CKD) command, IPL program by device type 144
 - permitted for the IPL program 145
 - VTOC and VTOC index, table 466
- media
 - definition 493
- media maintenance
 - CKD devices, example 81
 - emulated CKD devices 87
 - FBA devices, example 292
- medial INIT 71
 - definition 493
- medial initialization
 - definition 137, 493
 - description 151
 - dual copy volume restrictions 156
 - restriction on dual copy volumes 152
 - restriction on emulated devices 152
 - Stand-Alone version, example 159
- medial SIM
 - definition 493
- megabyte (MB)
 - definition 493
- menu-driven panels, ISMF 28
- message
 - ICK003D 32
- message retrieval tool, LookAt xxiii
- message text
 - REPLY U TO ALTER VOLUME ccuu CONTENTS, ELSE T 32
- messages
 - ICK 345
 - received at the console 346
 - routing and descriptor codes 345
- migrating data 135
 - CPVOLUME (FBA) command 310
- MIMIC parameter
 - INIT (CKD) command 146
 - INSPECT (CKD) command 169
- MIMIC(MINI) parameter
 - AIXVOL (CKD) command 90
 - CPVOLUME (CKD) command 131
- MINI(n) parameter, INIT (CKD) command 146
- minidisk 39
 - creating volume allocation map 135
 - definition 493
- minidisk (CKD) 45, 47, 65, 76
 - changing the volume serial number, example 266
 - drive test and volume scan support 104
 - formatting, example 92
 - initializing under CMS version 156
 - initializing, example 160
 - INSPECT (CKD) command support 181
 - inspecting in the CMS version, example 184
 - inspecting, example 184
 - reformatting, example 266
 - specifying a volume as 146, 169
 - specifying another user's 100, 174
 - specifying owner identification 147
 - specifying real address 96
- minidisk (CKD) (*continued*)
 - specifying volume as 90, 131
 - users without special authority 46
- minidisk (FBA) 45, 47, 65
 - ANALYZE (FBA) command 299
 - data verification test, example 302
 - formatting, example 289
 - initializing for VSE environment, example 320
 - inspecting in the CMS version, example 333
 - reformatting, example 343
 - specifying a real address 297
 - specifying another user's 299, 328
 - users without special authority 46
- minidisk, creating volume allocation map
 - CPVOLUME (FBA) command, description 310
- minidisks under the CMS version 45
- minimal INIT 71
 - definition 493
- minimal initialization
 - definition 137, 493
 - description 151
 - dual copy volume restriction 156
 - FBA devices 318
 - first time in offline mode (MVS), example 157
 - for VSE use, example 160
 - INSTALL (CKD) command, example 189
 - offline mode, example 158
 - restriction on dual copy volumes 151
- miscable checking 10
- MODE parameter 224
- MODE(COPY) parameter 208
- module, IBM, return codes 476
- monitoring PPRC volume pairs 202
- MOUNT command 35
- movable-head error table
 - CKD 108
 - FBA 303
- MSECONDS parameter
 - IODELAY (CKD) command 192
 - IODELAY (FBA) command 336
- MSGREQ parameter 224
- MSS parameter
 - INIT (CKD) command 146
 - INSPECT (CKD) command 169
- multipath storage director
 - definition 493
- Multiprise 3000 9
- MVS
 - definition 493
 - online tracks, example 282
 - online, example 282
 - MVS offline tracks, example 282
 - MVS RACF authorization table 32
 - MVS version
 - initializing a volume 156, 159
 - MVS version, flowchart
 - tasks using 25
 - MVS, JCL to copy Stand-Alone ICKDSF to tape, example 58

N

nested IF statement 22
new device, installing, example 287
NEWVTOC parameter
 REFORMAT (CKD) command 259
NOASSIGN parameter
 INSPECT (CKD) command 165
 INSPECT (FBA) command 325
NOBOOTSTRAP parameter
 INIT (CKD) command 139
 REFORMAT (CKD) command 259
NOCHECK parameter
 INIT (CKD) command 144
 INIT (FBA) command 315
 INSPECT (CKD) command 166
 INSPECT (FBA) command 326
NOCHECK specified 367
NOCONTINUE parameter
 INIT (CKD) command 140
 INIT (FBA) command 315
NODATA parameter
 INIT (CKD) command 141
 REVAL (CKD) command 272
node element descriptor (NED) 10
NODETAIL parameter, MAPALT (FBA) command 338
NODRIVE NOSCAN parameters 112
NODRIVETEST parameter
 ANALYZE (CKD) command 97
 ANALYZE (FBA) command 298
NOFILLER parameter, CPVOLUME (CKD)
 command 131
NOINDEX parameter, INIT (CKD) command 143
NOMAP parameter
 INIT (CKD) command 146
 INIT (FBA) command 316
 INSPECT (CKD) command 169
 INSPECT (FBA) command 327
non-cascading, how PPRC works 196
non-VSAM password-protected data sets 33
NONE subparameter 278
 AIXVOL (CKD) command 90
 CPVOLUME (FBA) command 306
 INIT (CKD) command 139
 INIT (FBA) command 314
 INSPECT (CKD) command 164
 INSTALL (CKD) command 188
 REFORMAT (FBA) command 325
 REVAL (CKD) command 271
nonsynchronous operation
 definition 493
NOPRESERVE parameter, INSPECT (CKD)
 command 170
NOPURGE parameter
 BUILDIX (CKD) command 116
 INIT (CKD) command 148
 INIT (FBA) command 317
 REFORMAT (CKD) command 262
NOREADCHECK parameter
 AIXVOL (CKD) command 91
 CPVOLUME (CKD) command 132
 CPVOLUME (FBA) command 307

NORECLAIM parameter
 INIT (FBA) command 317
 INSPECT (CKD) command 172
NOSCAN parameter
 ANALYZE (CKD) command 99
 ANALYZE (FBA) command 298
NOSKIP parameter
 INSPECT (CKD) command 172
NOSPEED parameter
 ANALYZE (CKD) command 99
 ANALYZE (FBA) command 299
NOVALIDATE parameter, INIT (CKD) command 149
NOVERIFY parameter 188, 278
 AIXVOL (CKD) command 90
 CPVOLUME (CKD) command 130
 CPVOLUME (FBA) command 306
 INIT (CKD) command 139
 INIT (FBA) command 314
 INSPECT (CKD) command 164
 INSPECT (FBA) command 325
 REFORMAT (CKD) command 258
 REFORMAT (FBA) command 342
 REVAL (CKD) command 271
null THEN and ELSE clause 23
number of CKD records formatted per track by AIXVOL
 command 91
number of records formatted by CPVOLUME
 command 133
NVS
 definition 493

O

OBJFORMAT subparameter, REFORMAT (CKD)
 command 260
offline mode 32
 changing volume serial number and owner
 identification, example 264
 data set security and protection 32
 initializing a volume 157
 initializing a volume at the minimal level,
 example 158
 MVS offline tracks 282
 reclaiming tracks 183
 unconditionally assigning alternate tracks,
 example 182
offline mode, initializing a volume 158
offline mode, initializing two volumes
 example (INIT - CKD) 157
online mode
 conditionally assigning alternate tracks,
 example 182
 data set security and protection 32
 inspecting a duplex pair 183
 MVS online tracks, example 282
online mode, adding IPL text, example 264
online panels, ISMF 28
ONLINSEC parameter 224
operating system, guest 67
operator's intervention consideration 36
Optical Media Attach (OMA) 58

- OPTION parameter 225
- optional command delimiter, semicolon 358
- orientation
 - definition 494
- OS
 - definition 494
- OS VTOC, converting to indexed format 78, 116
- OSVTOC parameter, BUILDIX (CKD) command 116
- output device, specifying in the Stand-Alone version 62
- output, diagnostic, MAPALT (FBA) command 339
- overview of the ICKDSF
 - tasks using the Stand-Alone version 56
 - tasks using the VSE version 49
- owner identification
 - specifying 147
 - verifying
 - INIT (CKD) command 271
- owner identification, cerifying
 - REFORMAT (CKD) command 258
- owner identification, changing 77
 - REFORMAT (CKD) command, example 264, 267
 - REFORMAT (FBA) command, example 289, 343
- owner identification, verifying
 - INIT (CKD) command 139
 - INIT (FBA) command 314
 - INSPECT (CKD) command 164
 - INSPECT (FBA) command 325
 - REFORMAT (FBA) command 342
 - TRKFMT (CKD) command 278
- OWNERID parameter
 - INIT (CKD) command 147
 - INIT (FBA) command 317
 - REFORMAT (CKD) command 262
 - REFORMAT (FBA) command 342

P

- PACE parameter 225
- pack space map (VPSM) 465
- page
 - definition 494
- PAGE subparameter
 - CPVOLUME (CKD) command 132
 - CPVOLUME (FBA) command 307
- Parallel Access Volume (PAV) 9
- parameter
 - ALL 96
 - ALLOWWRITE 122
 - CHECK 83
 - CLEARFENCE 87, 122
 - CONFIGURE(DISPLAY) 123
 - CONTINUE 140
 - CYCLES 279
 - CYCLES(n) 277
 - CYLRANGE 98, 140, 276, 280
 - DATA 141
 - DIRECTIO 3, 96, 181
 - ERASEDATA 275, 277
 - EXTINDEX 77
 - EXTVTOC 77

- parameter (*continued*)
 - FBAVTOC 469
 - FORCE 386
 - FROMRANGE 97, 142, 277, 280
 - HEADRANGE 98, 143, 277, 280
 - INDEX 143
 - LIMITS 98
 - LSS 229, 231, 435
 - MAP 146
 - MODE(COPY) 208
 - NOCHECK 144
 - NODATA 141
 - NOINDEX 143
 - NOMAP 146
 - NOPURGE 116
 - NOVERIFY 188, 278
 - PASSWORDS 31, 32, 279
 - PRESERVE 83, 383
 - PRINTDS 99
 - PURGE 32, 116
 - REMOVEFCPY 123
 - RESETICD 123
 - SETMODE 71
 - SYSNAME 121
 - TOLERATE 279
 - TORANGE 148, 278, 280
 - TRACKS 280
 - UNITADDRESS 121
 - USERID 100
 - VERIFY 31, 188, 278
 - VOLID 149
 - VTOC 149
- parameter conditions when specifying part of the volume, table 175
- parameters to select the input and output devices 45
- parameters, positional 357
- parentheses, right 358
- PARM subparameter
 - CPVOLUME (CKD) command 132
 - CPVOLUME (FBA) command 307
- PARM=NOXRC parameter 10
- password-protected data sets 32
 - return codes 476
- PASSWORDS parameter 31, 32, 279
 - INIT (CKD) command 147
 - INSPECT (CKD) command 169
- path control
 - specifying, ANALYZE (CKD) command 96, 107
 - under ANALYZE (CKD) command, restriction 101
 - when running analyze drive test 107
 - when running analyze drive test, table 107
- Path Status Table 381
- path status table, ANALYZE (CKD) command 109
- paths, existing logical 215
- Peer-to-Peer Remote Copy (PPRC) 370, 371
 - 3990 NVS and cache requirements for PPRC, table 206
 - command functions 202
 - configuring storage subsystem resources 206
 - definition 494
 - deleting pairs 226

Peer-to-Peer Remote Copy (PPRC) (*continued*)

- deleting paths 216
- establishing pairs 219
- establishing paths 208
- establishing the configuration 205
- how PPRC works 195
- identifying volume pairs 205
- managing the PPRC system 243
- PPRCOPY QUERY with the PATHS parameter 240
- PPRCOPY QUERY without the PATHS Parameter 236
- querying status 235
- recovering data on the recovery system 233
- setting up the environment 204
- suspending pairs 231
 - with RACF protection 195

Peer-to-Peer Remote Copy (PPRC) hardware requirements 203

Peer-to-Peer Remote Copy (PPRC) restrictions 204

Peer-to-peer Remote Copy volume 352

performing ICKDSF tasks on minidisks with the Stand-Alone version 65

performing miscellaneous tasks with ICKDSF 295

performing tasks with INSPECT parameters 161

PERIO parameter

- IODELAY (CKD) command 192
- IODELAY (FBA) command 335

PERM subparameter

- CPVOLUME (CKD) command 132
- CPVOLUME (FBA) command 307

permanent data checks 15

permanent errors

- definition 494

pinned data

- definition 494

placing a VTOC at the end of a volume 77

placing an FBAVTOC at the end of a volume 289

positional parameters 357

PPRC device error, 2105 215

PPRC ESTPAIR command 199

PPRC extended distance 197

- setting up your environment 197
- using 197

PPRC licensed internal code (LIC) 203

PPRC volume pairs

- establishing 197

PPRC volume state

- converting from one to another 200

PPRC, establish FCP paths 211

PPRC, FCP paths 218

PPRCOPY command 4, 6, 7, 9, 195

PPRCOPY DELPAIR 226

PPRCOPY DELPATH command 216

PPRCOPY ESTPAIR command 219

PPRCOPY ESTPATH command 206, 208

PPRCOPY ESTPATH syntax 210

PPRCOPY RECOVER command 233

PPRCOPY SUSPEND command 231

PQ72465, CASCADE support 225

PRESERVE backup processing. 351

PRESERVE function 370

PRESERVE parameter 83, 383

- INSPECT (CKD) command 170
- INSPECT (FBA) command 327, 329
 - restriction (0671, 9313, 9332, or 9336) 327

preserving data

- INSPECT (FBA) command 329

preserving data during INSPECT (CKD) command 179

preserving data during INSPECT (FBA) command 328, 329

preventing destruction of data

- on the blocks inspected (INSPECT - FBA) 327

primary checking 471

primary checking for CKD devices 472

primary checking for FBA devices 472

primary device

- definition 494

primary surface checking

- definition 494

primary track

- definition 494

primary/alternate track, CKD devices 464

PRINTDS parameter

- ANALYZE (CKD) command 99

printed output (VSE) 51

printed output data set 28

printing a map of alternate blocks

- INIT (FBA) command 316
- INSPECT (FBA) command 327
- MAPALT (FBA) command, example 295, 339, 341

printing a map of alternate tracks

- INIT (CKD) command 146
- INSPECT (CKD) command, example 87, 183

privilege class

- definition 494

PRNT output device specification 62

problem determination

- FBA disk 290

problem solving under VM 67

processing in a shared DFSMS environment 153

processing in a shared environment 35, 53, 153, 188

processing tracks

- MVS version 282
 - offline mode, MVS version 282
 - online mode, MVS version 282
 - Stand-Alone version 282

processing, control 19

processing, XRC volumes 10

programming interfaces 475

PROP

- definition 494

protected data sets, security

- data sets in an online mode 32

protecting

- MVS volumes and data sets 31

protecting data sets in an offline mode 32

protection, RACF authorization 32

providing passwords for data set security 147

PSW

- definition 494

PSW error condition codes, table 64

PURGE parameter 32

PURGE parameter *(continued)*
BUILDIX (CKD) command 116
INIT (CKD) command 148
INIT (FBA) command 317
REFORMAT (CKD) command 262

Q

querying status, PPRCOPY QUERY 235
quiesce
 definition 494
quoted string 358

R

R0
 definition 494
RACF
 definition 494
RACF FACILITY class profile 35
RACF protected data sets 33
RACF protection
 ANALYZE (CKD) command 95
 BUILDIX (CKD) command 115
 CONTROL (CKD) command 121
 INIT (CKD) command 138
 INSPECT (CKD) command 161
 INSTALL (CKD) command 186
 IODELAY (CKD) command 191
 Peer-to-Peer Remote Copy (PPRC) 195
 REFORMAT (CKD) command 257
 REVAL (CKD) command 270
 TRKFMT (CKD) command 275
RAMAC Array DASD (9391) 8
RAMAC Array Subsystem (9394) 8
RAMAC Electronic Array (9397) 8
RAMAC Scalable Array (9396) 8
RAMAC Virtual Array (9393) 8
RAMAC Virtual Array Subsystem 205
RANGE parameter
 AIXVOL (CKD) command 90
 CPVOLUME (CKD) command 131
 CPVOLUME (FBA) command 306
RANGE parameters 175
range, specifying
 ANALYZE (CKD) command 103
 INIT (CKD) command 154
 INSPECT (CKD) command 175
 TRKFMT (CKD) command 280
read-back check, specifying
 CKD devices 91, 132
 FBA devices 307
read-write heads 13
READCHECK parameter
 AIXVOL (CKD) command 91
 CPVOLUME (CKD) command 132
 CPVOLUME (FBA) command 307
reading the MAPALT report output 338
READY state 346
REALADDR parameter
 ANALYZE (CKD) command 95

REALADDR parameter *(continued)*
 ANALYZE (FBA) command 297
 INSPECT (CKD) command 163
reassigning alternate tracks 272
rebuilding an existing VTOC index, example 118
RECLAIM function 367
RECLAIM parameter
 INIT (FBA) command 317
 INSPECT (CKD) command 172
reclaiming blocks
 example 293
reclaiming tracks
 INSPECT (CKD) command, example 183
reclaiming tracks example 82
Recommendation
 VERIFY parameter 31
record 0, validating (CKD) 149
record format 461
record zero (R0) 352
record, CKD device format 461
recovering data (FBA) 329
recovering data with Peer-to-Peer Remote Copy 233
recovery, disaster 198
redundant comma 357
REFORMAT (CKD) command 257
 adding IPL text 78, 260
 adding IPL text, online mode, example 264
 changing volume serial number and ownerid,
 example 77, 264, 267
 parameter description 258
 reformatting a volume for MVS use, example 264
 with RACF protection 257
REFORMAT (CKD) command, adding IPL text
 CMS version, example 266
 from another volume, example 264
REFORMAT (FBA) command 341
 changing volume serial number and ownerid,
 example 289, 343
 parameter description 341
 reformatting a minidisk, example 343
 reformatting a volume for VSE use, example 343
REFORMAT (FBA) command, example 289
REFORMAT command 4, 6, 7, 9, 77
 expand the VTOC or VTOC index 431
reformatting a minidisk in the CMS version 343
reformatting a volume 77
 for MVS use, example 264
 for VSE use, example 343
refreshing the VTOC and index 265
REFVTOC parameter
 REFORMAT (CKD) command 259
regardless of previous processing 74
registers, loading 475
reinitializing a volume 159
 REVAL (CKD) command, example 274
reinitializing a volume, example 158
release
 definition 494
relocated devices, installing 186
remote copy-capable LIC 203
remote devices 59

- remote site 198
- REMOVEFCPY parameter, CONTROL (CKD)
 - command 123
- repairing 4E4E SIMs on the 3390 273
- replacing the IBM-supplied user exit routine 477
- report output, MAPALT (FBA) command 338
- reserve
 - definition 494
- RESERVE macro 35
- RESERVE macro, use of 35
- reserving space for additional volume labels
 - INIT (CKD) command 146
 - INIT (FBA) command 316
- reset indefinite condition 369
- Reset Indefinite Condition for Device (RESETICD) 385
- RESET parameter
 - IODELAY (CKD) command 191
 - IODELAY (FBA) command 335
- RESETICD parameter, CONTROL (CKD)
 - command 123
- resetting fence status 124, 125, 126
- resetting indefinite status condition
 - CONTROL (CKD) command 125
 - CONTROL (CKD) command, example 126
- Resource Access Control Facility (RACF) 31
- resource serialization, INSPECT (CKD) command 177
- resource serialization, TRKFMT (CKD) command 281
- restoring a volume
 - factory specs, example 87, 295
 - INIT (CKD) command 141
- restoring FFVDP 156
- restoring volume serial number 263
- restriction
 - BUILDIX (CKD) command 115
- resume
 - definition 494
- resuming
 - after a job or system failure 154
 - from a checkpoint, FBA devices, example 288
 - from a checkpoint, initializing a volume 140
 - jobs, FBA devices 315
- resuming after job or system failure
 - INIT (CKD) command 154
 - INIT (FBA) command 319
 - INSTALL (CKD) command 188
 - REVAL (CKD) command 274
- resuming from checkpoint
 - during initialization 73
- resuming initialization from a checkpoint location 73
- retrieving data from the backup location 329
- return codes
 - password-protected data sets 476
 - the IBM module 476
 - VSAM and unexpired data sets 476
- REVAL (CKD) command
 - data destruction warning 269
 - description 269
 - parameter description 270
 - reassigning alternate tracks 272
 - reinitializing a volume, example 274
 - repairing 4E4E SIMs on the 3390 273
 - REVAL (CKD) command (*continued*)
 - VSE version 274
 - with RACF protection 270
 - REVAL command 4, 6, 7, 8
 - REVAL DATA processing 365
 - REVAL FIXSIM(4E4E) 365
 - REVAL NODATA processing 365
 - REVAL REFRESH process 365
 - reverse direction of PPRC 223
 - rewriting
 - volume label 93
 - volume serial 310
 - rewriting volume label 135
 - rewriting volume serial number and owner
 - identification 289
- REXX
 - definition 494
- RPS
 - definition 494
- RUN command 202, 229
- running
 - REVAL with FIXSIM 274
 - VSE version of ICKDSF in batch mode 50
- running ICKDSF with JCL, example 27
- running VSE version of ICKDSF in command mode 51
- RVA (9393) 203

S

- S/390 Multiprise 2000 9
- SA cylinder
 - preserving data during INSPECT (CKD)
 - command 179
- SAM
 - definition 494
- SAPL
 - definition 494
- SAPL (stand alone program loader) 60
- saving data during surface checking 293
- SCAN parameter
 - ANALYZE (CKD) command 99
 - ANALYZE (FBA) command 298
- scanning data on part of a volume 79
- SCLP
 - definition 494
- secondary device
 - definition 494
- secondary PPRC volume consistency 229
- secondary volume, online 224
- SECONDS parameter
 - IODELAY (CKD) command 192
 - IODELAY (FBA) command 336
- securing data 31, 34
- security, RACF authorization 32
- SECWWNN parameter
 - ANALYZE (CKD) command 99
- selecting input and output devices using
 - parameters 45
- self description 10
- semicolon, optional command delimiter 358
- sense information 358, 379, 384

- Sense Subsystem Status Data 10
- separating commands and parameters 18
- Service Call Logical Processor Facility (SCLP) 59, 61, 62
 - definition 494
- service information message (SIM)
 - definition 494
- service information messages (SIM) 15
- SET parameter
 - IODELAY (CKD) command 191
 - IODELAY (FBA) command 335
- SET statement, example of 20, 21
- SETMODE parameter 71
- SETMODE parameter, INSTALL (CKD) command 187
- setting 3390 to 3380 track compatibility mode 72
- shared environment
 - VSE version 53
- shared environment, MVS version 35
- shared-system processing
 - INIT (CKD) command 153
 - INSTALL (CKD) command 188
- sharing across multiple processors 53
 - users and partitions in a single processor 54
- shortcut keys 483
- SIM
 - definition 494
- SIM Alert message
 - definition 494
- simplex state
 - definition 495
- SIMs (service information messages)
 - repairing 4E4E on the 3390 273
- single storage control 202, 228
- single-path storage director
 - definition 495
- SIO
 - definition 495
- size, VTOC index 465
- skip displacement
 - definition 495
- skip displacement checking 472
- skip displacement devices 80
- SKIP parameter
 - INSPECT (CKD) command 172
- slowing down I/O operations
 - IODELAY (CKD) command, example 192
 - IODELAY (FBA) command, example 336
- SML
 - definition 495
- SMS
 - definition 495
- software documents xxii
- solving problems with ANALYZE output 300
- space maps 465
- space requirements, FBAVTOC 470
- special authority, supporting general users without specified range
 - definition 495
- specifying primary or secondary volumes (CKD) 96
- SPEED parameter
 - ANALYZE (CKD) command 99
 - ANALYZE (FBA) command 299
- SPID
 - definition 495
- SSL
 - definition 495
- staging devices, considerations 146
- stand alone program loader, IPLing 60
- Stand-Alone Program Loader (SAPL) 55
- Stand-Alone tasks 56
- Stand-Alone version
 - ending ICKDSF 63
 - error conditions 64
 - initializing a volume, example 159
 - output devices supported 62
 - specifying date and time of day 63
- Stand-Alone version, flowchart 56
- standard track layout (CKD devices) 461
- starting ICKDSF 27
- Status Cannot Be Determined State 385
- status for MSS staging 146
- STEEPCAT DD statement, executing ICKDSF in MVS 27
- storage cluster
 - definition 495
- storage control
 - definition 495
- storage control, clearing
 - CONTROL (CKD) command, description 123
 - CONTROL (CKD) command, example 125
- storage control, single 228
- storage controller
 - definition 495
- storage director
 - definition 495
- STORAGE DIRECTOR entry in path status table 109
- storage director ID
 - definition 495
- Storage Management Subsystem (SMS)
 - definition 495
- storage path
 - definition 495
- STORAGE PATH entry in path status table 109
- storage subsystem
 - definition 495
- STORAGEGROUP parameter, INIT (CKD) command 148
- string
 - definition 495
- string, quoted 358
- subparameter
 - NONE 278
- subsystem
 - definition 495
- SUBSYSTEM ID entry in path status table 109
- subsystem identifier (SSID)
 - definition 495
- supplying variable-length records as IPL data 145
- support under the CMS version
 - dedicated devices under the CMS version 48

- supported by ICKDSF commands (minidisks under CMS), table 45
- surface analysis cylinder
 - definition 495
- surface checking
 - disks, example 291
 - minidisk (CKD), example 184
 - part of a volume 80
 - part of a volume, example (FBA) 293
 - track 471
- surface checking a volume (CKD)
 - controlling the level 174
- suspended duplex state
 - ANALYZE (CKD) command 105
 - BUILDIX (CKD) command 115
 - CONTROL (CKD) command 121
 - definition 495
- suspending Peer-to-Peer Remote Copy pairs 231
- SVC
 - definition 495
- synchronous operation
 - definition 496
- syntax, ICKDSF command 17
- SYS1.LOGREC file (MVS) 79
- SYS1.SAMPLIB library 58, 264, 479
- SYSIN DD statement, executing ICKDSF in MVS 27
- SYSNAME parameter
 - ANALYZE (CKD) command 95
 - ANALYZE (FBA) command 297
 - CONTROL (CKD) command 121
 - INIT (CKD) command 138
 - INIT (FBA) command 314
 - INSPECT (CKD) command 163
 - INSPECT (FBA) command 324
 - INSTALL (CKD) command 187
 - MAPALT (FBA) command 337
 - REFORMAT (CKD) command 258
 - REFORMAT (FBA) command 341
 - REVAL (CKD) command 270
 - TRKFMT (CKD) command 276
- SYSPRINT DD statement, printed output data set 27
- SYSREC file (VSE) 79
- System Adapter ID (SAID) 254
- system failure
 - recovering data 330
 - resuming a job after 319
- system failure, recovering data 330
- system failure, resuming 154
- system view of a permanent data check 15
- system-managed storage
 - definition 495
- system-managed storage (SMS) 31
- system-managed volume 148

T

- tape or card reader 58
- tasks
 - assign alternate tracks 11
 - drive problems 11
 - initializing and formatting the volume 11

- tasks (*continued*)
 - installing a device 11
 - media maintenance 11
 - problem determination 11
 - reading data stored on the volume 11
 - reclaim a track 11
 - rewrite data 11
 - skip displacement checking 11
 - surface checking functions 11
- tasks using the CMS version 39
- tasks using the MVS version, overview of ICKDSF 25
- TDSK subparameter
 - CPVOLUME (CKD) command 132
 - CPVOLUME (FBA) command 307
- temporary data checks 15
- temporary errors
 - definition 496
- temporary versus permanent 15
- terminator, ICKDSF commands 19
- testing the drive and logical volume with
 - ANALYZE 101, 299
- THEN clause
 - IF statement 21
 - null 23
- THEN DO clause, IF statement 23
- thermal stability
 - ANALYZE (CKD) command restriction 102
 - medial INIT restriction 152
- thermal stability restriction 102
- TIC
 - definition 496
- time delay 357
- time of day, specifying when loading ICKDSF program 63
- TOD
 - definition 496
- TOD (time-of-day) clock 63
- TOLERATE parameter 279
- TOLERATE parameter, INSPECT (CKD) command 173
- TORANGE parameter 278, 280
 - ANALYZE (CKD) command 100, 103
 - INIT (CKD) command 148
 - INSPECT (CKD) command 173, 175
- track compatibility mode
 - definition 496
- track contents after initialization (CDK devices) 463
- tracks
 - alternate
 - reassigning 272
 - associations, primary/alternate (CKD) 464
 - MVS
 - online, example 282
- TRACKS parameter 280
 - INSPECT (CKD) command 174
- tracks, address 461
- tracks, alternate
 - conditionally assigning, example 81, 182
 - printing a map of 146
 - printing a map of, example 87, 183
 - table of parameters used to assign 176

- tracks, alternate (*continued*)
 - unconditionally assigning, example 82, 86, 182
- tracks, CMS example 282
- tracks, disk surface 461
- tracks, reclaiming
 - those previously flagged defective 172
- tracks, reclaiming example 82
- tracks, Stand-Alone example 282
- tracks, standard layout (CKD devices) 461
- TRK
 - definition 496
- TRKFMT (CKD) command 275
 - previous command 280
 - specifying range 280
 - with RACF protection 275
- TRKFMT command 4, 6, 7
- troubleshooting, VM 67
- TSO
 - definition 496
- TTR
 - definition 496
- type of F, FCP 112
- TYPE parameter
 - CPVOLUME (CKD) command 132
 - CPVOLUME (FBA) command 307

U

- UCB
 - definition 496
- unable to determine CPUID 459
- unconditionally assigning
 - alternate block, INSPECT command 332
 - alternate blocks 292
 - alternate tracks 82, 182
- uncorrectable errors
 - definition 496
- understanding which INSPECT parameters to use 161, 323
- unexpected I/O errors 103
- unexpired data sets
 - VSAM, return codes 476
- unexpired data sets, security 33
- unexpired files (VSE) 53
- unit address
 - definition 496
- UNITADDRESS 355
- UNITADDRESS parameter
 - AIXVOL (CKD) command 90
 - ANALYZE (CKD) command 95
 - ANALYZE (FBA) command 297
 - CONTROL (CKD) command 121
 - CPVOLUME (CKD) command 130
 - CPVOLUME (FBA) command 306
 - INIT (CKD) command 138
 - INIT (FBA) command 314
 - INSPECT (CKD) command 163
 - INSPECT (FBA) command 324
 - INSTALL (CKD) command 187
 - MAPALT (FBA) command 337
 - REFORMAT (CKD) command 258

- UNITADDRESS parameter (*continued*)
 - REFORMAT (FBA) command 341
 - REVAL (CKD) command 270
 - TRKFMT (CKD) command 276
- unlike device
 - definition 496
- updating portions of a previously initialized volume
 - REFORMAT (FBA) command 341
- updating the allocation map 134, 309
- use of VSE ICKDSF command mode during VSE install process 52
- use the Stand-Alone, preparing 58
- USECONDS parameter
 - IODELAY (CKD) command 192
 - IODELAY (FBA) command 336
- user authority, class F 67
- user exit routine, IBM supplied, replacing 477
- user security exit module 32, 475
- user-supplied IPL program, writing 144
 - REFORMAT (CKD) command 260
- user-volume labels
 - reserving space for (CKD) 146
- USERID parameter
 - ANALYZE (CKD) command 100
 - ANALYZE (FBA) command 299
 - INSPECT (CKD) command 174
 - INSPECT (FBA) command 328
- using DEVMAINT authority 47
- using REFORMAT command with the CMS version 266
- using synchronous and asynchronous PPRC 198
- utility, INITEM 85

V

- VALIDATE parameter, INIT (CKD) command 149
- validating
 - part of a volume 73
- validating and writing
 - FFVDP for one head 75
- validating and writing, FFVDP 73
- validating entire volume (CKD), example 73
- validating from a specific point 74
- validating last heads of a device 75
- validating part of volume (CKD), example 73
- validating the home address and record 0 (INIT - CKD) 149
- validating to a specific point 75
- VARY OFFLINE, TEST command 146
- VBA
 - definition 496
- Verification data pattern
 - definition 496
- VERIFY parameter 31, 188, 278
 - AIXVOL (CKD) command 90
 - CPVOLUME (CKD) command 130
 - CPVOLUME (FBA) command 306
 - INIT (CKD) command 139
 - INIT (FBA) command 314
 - INSPECT (CKD) command 164
 - INSPECT (FBA) command 325

VERIFY parameter *(continued)*
 REFORMAT (CKD) command 258
 REFORMAT (FBA) command 342
 REVAL (CKD) command 271
 verifying
 data records with ANALYZE 300
 identification and preventing data loss 53
 verifying the volume serial number
 AIXVOL (CKD) command 90
 CPVOLUME (CKD) command 130
 CPVOLUME (FBA) command 306
 INSTALL (CKD) command 188
 verifying the volume serial number and owner
 identification
 INIT (CKD) command 139
 INIT (FBA) command 314
 INSPECT (CKD) command 164
 INSPECT (FBA) command 325
 REFORMAT (CKD) command 258
 REFORMAT (FBA) command 342
 REVAL (CKD) command 271
 TRKFMT (CKD) command 278
 version minidisk support 301
 VIER
 definition 496
 VIO
 definition 496
 VIO (virtual input output) 354
 vital product data (VPD) 215
 VIXM
 definition 496
 VIXM (VTOC index map) 466
 VM
 definition 496
 VM operating system, formatting CP volumes 305
 VM troubleshooting 67
 VM version, DEVMAINT authority 47
 VMDS
 definition 496
 VMDS (VTOC map of DSCBs) 466
 VOLID parameter
 AIXVOL (CKD) command 91
 CPVOLUME (CKD) command 132
 CPVOLUME (FBA) command 307
 INIT (CKD) command 149
 INIT (FBA) command 318
 REFORMAT (CKD) command 262
 REFORMAT (FBA) command 342
 volume
 definition 496
 volume allocation map
 creating for minidisk 135
 volume allocation map, creating for minidisk
 CPVOLUME (FBA) command, description 310
 volume allocation, changing
 VM volumes 134
 CPVOLUME (FBA) command, description 309
 volume allocation, changing (VM volumes) 311
 volume and data set security 32
 volume information 135
 volume information, displaying
 CPVOLUME (FBA) command 309
 volume initialization (FBA)
 maximal level 318
 minimal level 318
 volume is full
 VTOC or VTOC index 431
 volume label
 definition 496
 reserving space for (CKD) 146
 reserving space for (FBA) 316
 writing over 262
 volume layout and record formats on CKD devices 461
 VOLUME LIST SELECTION MENU, example 29
 volume map
 output, example (CKD) 462
 volume map, printing
 CKD devices 87, 146
 CKD devices, INSPECT (CKD) command,
 example 183
 FBA devices 327, 339
 FBA devices, INIT (FBA) command 316
 FBA devices, MAPALT (FBA) command 341
 VOLUME SELECTION ENTRY PANEL, example 30
 volume serial number 77
 specifying 91
 volume serial number, changing
 AIXVOL (CKD) command, example 93
 REFORMAT (CKD) command, example 264, 267
 REFORMAT (FBA) command, example 289, 343
 volume serial number, restoring
 REFORMAT (CKD) command 263
 volume serial number, specifying 149
 CPVOLUME (CKD) command 132
 CPVOLUME (FBA) command 307
 INIT (FBA) command 318
 REFORMAT (CKD) command 262
 REFORMAT (FBA) command 342
 volume serial number, verifying 164
 AIXVOL (CKD) command 90
 CPVOLUME (CKD) command 130
 CPVOLUME (FBA) command 306
 INIT (CKD) command 139
 INIT (FBA) command 314
 INSPECT (FBA) command 325
 INSTALL (CKD) command 188
 REFORMAT (FBA) command 342
 REVAL (CKD) command 271
 TRKFMT (CKD) command 278
 volume serial number, verifying
 REFORMAT (CKD) command 258
 volume table of contents (VTOC) 362
 volume usage format
 specifying 146, 169
 volume, writing on
 IPL program 145
 VPSM
 definition 496
 VPSM (VTOC pack space map) 466
 VSAM
 definition 496

- VSAM (virtual storage access method) 348
- VSAM and unexpired data sets 33
- VSAM and unexpired data sets, return codes 476
- VSAM data sets, security 33
- VSAM files, VSE version 53
- VSE
 - definition 496
 - initializing a minidisk for, example 320
- VSE EXTRACT failed 459
- VSE tasks 49
- VSE version
 - initializing a volume (FBA) 320
 - initializing a volume, example 160
 - inspecting a volume (CKD) 184
 - mapping entire volume, example 340
 - processing a volume (CKD) 283
 - reformatting a volume, example 343
 - REVAL (CKD) command 274
 - running a drive test 302
 - surface checking a volume (FBA), example 332
- VSE version of ICKDSF in command mode, example 51
- VSE version, flowchart 49
- VSEVTOC parameter, INIT (CKD) command 141
- VTOC
 - definition 496
- VTOC (volume table of contents) 348, 349, 350, 354, 355, 356, 358
 - determining the size and location 77
 - placing at the end of a volume 77
- VTOC index 431, 465
- VTOC index building, example 118
- VTOC parameter, INIT (CKD) command 149
- VTOC, VTOCIX data sets 34
- VTOCIX
 - definition 496
- VTOCIX data set, security 32, 170
- VTOCPTR parameter, REFORMAT (CKD) command 263

W

- warning
 - CE panel on the control unit and DASD 124
 - changing storage control, volume, or path connectivity for PPRC-managed volumes 244
 - changing volume mode, INSTALL (CKD) command 188
 - correct microcode level for CKD emulation 86
 - data destruction, REVAL (CKD) command 269
 - format the volume for use 189
 - initialize the volume 185
 - path contention, ANALYZE (CKD) command 101
 - potential data integrity exposures 207
 - potential data integrity exposures to offline volumes 208
 - protect your data by ensuring your secondary device is correct 219
 - recovering data, INSPECT (CKD) command 178
 - running ICKDSF under VM 39
 - running INSPECT (FBA) 323

- warning (*continued*)
 - use of FORCE parameter, INSPECT (CKD) command 181
 - using volumes before recovering the data 178
 - volume is not formatted for the MVS environment 274
- with user-supplied records, example
 - INIT (CKD) command 145
- World Wide Node Name (WWNN) 211
- write hit
 - definition 496
- WRITE INHIBITed device 125
- write-allowing WRITE INHIBITed device
 - CONTROL (CKD) command, description 123
 - CONTROL (CKD) command, example 125
- writing
 - a null THEN and ELSE 23
 - writing a DO-END statement 22
 - writing a SET statement 20
 - writing a user-supplied IPL program on the volume 144
 - writing an IF-THEN-ELSE statement 21
 - writing command statements 19
 - writing data from backup location
 - INSPECT (CKD) command 170, 179
 - INSPECT (FBA) command 329
 - writing FBAVTOC, example 290
 - writing FFVDP, INIT (CKD) command, example 73
 - writing IPL bootstrap records on a volume
 - INIT (CKD) command 139
 - REFORMAT (CKD) command 259
 - writing IPL program 78
 - INIT (CKD) command 145
 - writing IPL program, adding IPL text
 - REFORMAT (CKD) command, CMS version, example 266
 - REFORMAT (CKD) command, from another volume, example 264
 - REFORMAT (CKD) command, online mode, example 264
 - with user-supplied records, example 260
 - writing on a volume
 - with user-supplied records, example 144
 - writing on CKD devices, example 77
 - writing over existing data on a previously initialized volume
 - INIT (CKD) command 148
 - writing the FFVDP
 - on part of a volume 74
 - writing VTOC
 - CKD devices, example 77
 - FBA devices, example 289
- WWNN parameter 211

X

- XRC volumes, processing 10

Y

- Year 2000 support 11

Readers' Comments — We'd Like to Hear from You

Device Support Facilities
User's Guide and Reference
Release 17

Publication No. GC35-0033-26

Overall, how satisfied are you with the information in this book?

	Very Satisfied	Satisfied	Neutral	Dissatisfied	Very Dissatisfied
Overall satisfaction	<input type="checkbox"/>	<input type="checkbox"/>	<input type="checkbox"/>	<input type="checkbox"/>	<input type="checkbox"/>

How satisfied are you that the information in this book is:

	Very Satisfied	Satisfied	Neutral	Dissatisfied	Very Dissatisfied
Accurate	<input type="checkbox"/>	<input type="checkbox"/>	<input type="checkbox"/>	<input type="checkbox"/>	<input type="checkbox"/>
Complete	<input type="checkbox"/>	<input type="checkbox"/>	<input type="checkbox"/>	<input type="checkbox"/>	<input type="checkbox"/>
Easy to find	<input type="checkbox"/>	<input type="checkbox"/>	<input type="checkbox"/>	<input type="checkbox"/>	<input type="checkbox"/>
Easy to understand	<input type="checkbox"/>	<input type="checkbox"/>	<input type="checkbox"/>	<input type="checkbox"/>	<input type="checkbox"/>
Well organized	<input type="checkbox"/>	<input type="checkbox"/>	<input type="checkbox"/>	<input type="checkbox"/>	<input type="checkbox"/>
Applicable to your tasks	<input type="checkbox"/>	<input type="checkbox"/>	<input type="checkbox"/>	<input type="checkbox"/>	<input type="checkbox"/>

Please tell us how we can improve this book:

Thank you for your responses. May we contact you? Yes No

When you send comments to IBM, you grant IBM a nonexclusive right to use or distribute your comments in any way it believes appropriate without incurring any obligation to you.

Name

Address

Company or Organization

Phone No.



Fold and Tape

Please do not staple

Fold and Tape



NO POSTAGE
NECESSARY
IF MAILED IN THE
UNITED STATES

BUSINESS REPLY MAIL

FIRST-CLASS MAIL PERMIT NO. 40 ARMONK, NEW YORK

POSTAGE WILL BE PAID BY ADDRESSEE

International Business Machines Corporation
Department 55JA, Mail Station P384
2455 South Road
Poughkeepsie, NY 12601-5400



Fold and Tape

Please do not staple

Fold and Tape



Program Number: 5747-DS1
5747-DS2
5655-257
5684-042

Printed in USA

GC35-0033-26

