

IBM System Cluster 1350



Installation and Service Guide

IBM System Cluster 1350



Installation and Service Guide

Note: Before using this information and the product it supports, read the general information in “Safety” on page v and Appendix C, “Notices,” on page 35.

Twelfth edition, March 2007

© Copyright International Business Machines Corporation 2007. All rights reserved.

US Government Users Restricted Rights – Use, duplication or disclosure restricted by GSA ADP Schedule Contract with IBM Corp.

Contents

Safety	v
Safety Information	v
Handling static-sensitive devices	xiii
Notices and statements used in this document	xiv
Chapter 1. System overview	1
Cluster components	4
Cluster nodes	5
Management node	5
Storage nodes	5
Storage servers	6
Storage expansion units.	6
Fibre Channel adapters, switches, and expansion cards	6
Hard disk drives	6
High-speed adapters.	7
Console	7
KVM switches	7
InfiniBand switches and devices	7
InfiniBand host channel adapters	8
10/100/1000 Ethernet switches	8
10 Gigabit Ethernet switches	8
I/O modules	8
Terminal servers	9
High-speed Myrinet switches and line cards	10
Myrinet BladeCenter connectivity	10
Power distribution unit (PDU)	10
Related documentation	11
Chapter 2. Cabinet placement and intercabinet cabling	13
Minimum service clearances.	13
Types of intercabinet cabling.	15
Cabinet placement guidelines	15
Installing a stability kit	16
Engaging the side stabilizers.	16
Floor loading.	16
Preparing a Rear Door Heat eXchanger	18
Chapter 3. Cabling the Cluster 1350	19
Connecting the cables	20
1 Gigabit Ethernet cabling	20
Myrinet high-speed switch cabling	20
10/100/1000 Ethernet cabling	20
Fibre-channel cabling	21
KVM cabling	21
Remote console manager cabling	21
Local console manager cabling	21
Voltaire InfiniBand switch router cabling	22
Replacing a defective cable in a harness	22
Chapter 4. Checking the Cluster 1350 cabling process	23
Installing cables and checking connections in the expansion cabinets	23
Installing cables and checking connections in the primary cabinet	24
Turning on the power to the expansion cabinets	24
Turning on the power to the primary cabinet	24

Verifying the hardware installation	25
Diagnosing a lights out or brown out event	25
Related topics	26
Chapter 5. Accessing the cluster from a remote location	27
Using the remote power command	27
Remote console	27
Displaying node configuration information	27
Related topics	28
Appendix A. Error and event logs	29
Appendix B. Getting help and technical assistance	31
Before you call	31
Using the documentation	32
Getting help and information from the World Wide Web	32
Software service and support	32
Hardware service and support	32
IBM Taiwan product service	33
Appendix C. Notices	35
Trademarks	35
Important notes	36
Product recycling and disposal	37
Battery return program	37
Electronic emission notices	38
Federal Communications Commission (FCC) statement	38
Industry Canada Class A emission compliance statement	39
Australia and New Zealand Class A statement	39
United Kingdom telecommunications safety requirement	39
European Union EMC Directive conformance statement	39
Taiwanese Class A warning statement	39
Chinese Class A warning statement	40
Japanese Voluntary Control Council for Interference (VCCI) statement	40
Appendix D. Declaration of IBM product noise emission values	41
Appendix E. International License Agreement for Non-Warranted Programs	43
Part 1 - General Terms	43
Part 2 - Country-unique Terms	45
Index	47

Safety

For general information concerning safety, refer to *Electrical Safety for IBM Customer Engineers*, S229-8124. For a copy of the publication, contact your IBM® account representative or the IBM branch office serving your locality.

Enterprise rack safety information: Read the safety notices in the manual provided with the Enterprise rack before beginning work. Keep the Enterprise Rack manual near the rack for fast reference.

Safety Information

Before installing this product, read the Safety Information.

قبل تركيب هذا المنتج، يجب قراءة الملاحظات الأمنية

Antes de instalar este produto, leia as Informações de Segurança.

在安装本产品之前，请仔细阅读 **Safety Information** (安全信息)。

安裝本產品之前，請先閱讀「安全資訊」。

Prije instalacije ovog produkta obavezno pročitajte Sigurnosne Upute.

Před instalací tohoto produktu si přečtěte příručku bezpečnostních instrukcí.

Læs sikkerhedsforskrifterne, før du installerer dette produkt.

Lees voordat u dit product installeert eerst de veiligheidsvoorschriften.

Ennen kuin asennat tämän tuotteen, lue turvaohjeet kohdasta Safety Information.

Avant d'installer ce produit, lisez les consignes de sécurité.

Vor der Installation dieses Produkts die Sicherheitshinweise lesen.

Πριν εγκαταστήσετε το προϊόν αυτό, διαβάστε τις πληροφορίες ασφαλείας (safety information).

לפני שתתקינו מוצר זה, קראו את הוראות הבטיחות.

A termék telepítése előtt olvassa el a Biztonsági előírásokat!

Prima di installare questo prodotto, leggere le Informazioni sulla Sicurezza.

製品の設置の前に、安全情報をお読みください。

본 제품을 설치하기 전에 안전 정보를 읽으십시오.

Пред да се инсталира овој продукт, прочитајте информацијата за безбедност.

Les sikkerhetsinformasjonen (Safety Information) før du installerer dette produktet.

Przed zainstalowaniem tego produktu, należy zapoznać się z książką "Informacje dotyczące bezpieczeństwa" (Safety Information).

Antes de instalar este produto, leia as Informações sobre Segurança.

Перед установкой продукта прочтите инструкции по технике безопасности.

Pred inštaláciou tohto zariadenia si pečítajte Bezpečnostné predpisy.

Pred namestitvijo tega proizvoda preberite Varnostne informacije.

Antes de instalar este producto, lea la información de seguridad.

Läs säkerhetsinformationen innan du installerar den här produkten.

Important

Note:

All caution and danger statements in this documentation begin with a number. This number is used to cross reference an English caution or danger statement with translated versions of the caution or danger statement in the *IBM Safety Information* book that comes with your server.

For example, if a caution statement begins with a number 1, translations for that caution statement appear in the *IBM Safety Information* book under statement 1.

Be sure to read all caution and danger statements in this documentation before performing the instructions. Read any additional safety information that comes with your server or optional device before you install the device.

Statement 1:



DANGER

Electrical current from power, telephone, and communication cables is hazardous.

To avoid a shock hazard:

- Do not connect or disconnect any cables or perform installation, maintenance, or reconfiguration of this product during an electrical storm.
- Connect all power cords to a properly wired and grounded electrical outlet.
- Connect to properly wired outlets any equipment that will be attached to this product.
- When possible, use one hand only to connect or disconnect signal cables.
- Never turn on any equipment when there is evidence of fire, water, or structural damage.
- Disconnect the attached power cords, telecommunications systems, networks, and modems before you open the device covers, unless instructed otherwise in the installation and configuration procedures.
- Connect and disconnect cables as described in the following table when installing, moving, or opening covers on this product or attached devices.

To Connect:

1. Turn everything OFF.
2. First, attach all cables to devices.
3. Attach signal cables to connectors.
4. Attach power cords to outlet.
5. Turn device ON.

To Disconnect:

1. Turn everything OFF.
2. First, remove power cords from outlet.
3. Remove signal cables from connectors.
4. Remove all cables from devices.

Statement 3:



CAUTION:

When laser products (such as CD-ROMs, DVD drives, fiber optic devices, or transmitters) are installed, note the following:

- Do not remove the covers. Removing the covers of the laser product could result in exposure to hazardous laser radiation. There are no serviceable parts inside the device.
- Use of controls or adjustments or performance of procedures other than those specified herein might result in hazardous radiation exposure.



DANGER

Some laser products contain an embedded Class 3A or Class 3B laser diode. Note the following.

Laser radiation when open. Do not stare into the beam, do not view directly with optical instruments, and avoid direct exposure to the beam.



Class 1 Laser Product
Laser Klasse 1
Laser Klass 1
Luokan 1 Laserlaite
Appareil À Laser de Classe 1

Statement 5:



CAUTION:

The power control button on the device and the power switch on the power supply do not turn off the electrical current supplied to the device. The device also might have more than one power cord. To remove all electrical current from the device, ensure that all power cords are disconnected from the power source.

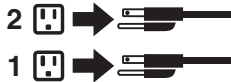

Statement 6:



CAUTION:

If you install a strain-relief bracket option over the end of the power cord that is connected to the device, you must connect the other end of the power cord to an easily accessible power source.

Statement 7:



CAUTION:

If the device has doors, be sure to remove or secure the doors before moving or lifting the device to avoid personal injury. The doors will not support the weight of the device.

Statement 8:



CAUTION:

Never remove the cover on a power supply or any part that has the following label attached.



Hazardous voltage, current, and energy levels are present inside any component that has this label attached. There are no serviceable parts inside these components. If you suspect a problem with one of these parts, contact a service technician.

Statement 9:



CAUTION:

To avoid personal injury, disconnect the hot-swap fan cables before removing the fan from the device.

Statement 13:



DANGER

Overloading a branch circuit is potentially a fire hazard and a shock hazard under certain conditions. To avoid these hazards, ensure that your system electrical requirements do not exceed branch circuit protection requirements. Refer to the information that is provided with your device for electrical specifications.

Statement 14:



CAUTION:

Hazardous voltage, current, and energy levels might be present. Only a qualified service technician is authorized to remove the covers where the following label is attached.



Statement 15:



CAUTION:

Make sure that the rack is secured properly to avoid tipping when the server unit is extended.

Statement 16:



CAUTION:

Some accessory or option board outputs exceed Class 2 or limited power source limits and must be installed with appropriate interconnecting cabling in accordance with the national electric code.

Statement 19:



CAUTION:

The power-control button on the device does not turn off the electrical current supplied to the device. The device also might have more than one connection to dc power. To remove all electrical current from the device, ensure that all connections to dc power are disconnected at the dc power input terminals.

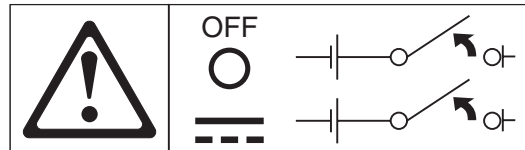

Statement 20:



CAUTION:

To avoid personal injury, before lifting the unit, remove all the blades to reduce the weight.

Statement 21:



CAUTION:

Hazardous energy is present when the blade is connected to the power source. Always replace the blade cover before installing the blade.

Statement 23:



CAUTION:

Do not place any object weighing more than 50 kg (110 lb.) on top of rack-mounted devices.



>50 kg (110 lb.)



CAUTION:

Removing components from the upper positions in the Enterprise Rack cabinet improves rack stability during relocation. Follow these general guidelines whenever you relocate a populated rack cabinet within a room or building:

- Reduce the weight of the rack cabinet by removing equipment starting at the top of the rack cabinet. When possible, restore the rack cabinet to the configuration of the rack cabinet as you received it. If this configuration is not known, you must do the following:
 - Remove all devices in the 32-U position and above.
 - Ensure that the heaviest devices are installed in the bottom of the rack cabinet.
 - Ensure that there are no empty U-levels between devices installed in the rack cabinet below the 32-U level.
- If the rack cabinet you are relocating is part of a suite of rack cabinets, detach the rack cabinet from the suite.
- Inspect the route that you plan to take to eliminate potential hazards.
- Make sure that the route that you choose can support the weight of the loaded rack cabinet. Refer to the documentation that comes with your rack cabinet for the weight of a loaded rack cabinet.
- Make sure that all door openings are at least 760 x 2030 MM. (30 x 80 in.)
- Ensure that all devices, shelves, drawers, doors, and cables are secure.
- Ensure that the four leveling pads are raised to their highest position.
- Ensure that there is no stabilizer bracket installed on the rack cabinet.
- Do not use a ramp inclined at more than ten degrees.
- Once the rack cabinet is in the new location, do the following:
 - Lower the four leveling pads.
 - Install stabilizer brackets on the rack cabinet.
 - If you removed any devices from the rack cabinet, repopulate the rack cabinet from the lowest position to the highest position.

If a long distance relocation is required, restore the rack cabinet to the configuration of the rack cabinet as you received it. Pack the rack cabinet in the original packaging material, or equivalent. Also, lower the leveling pads to raise the casters off of the pallet and bolt the rack cabinet to the pallet.



DANGER

- Do not extend more than one sliding device at a time.
- The maximum allowable weight for devices on slide rails is 80 kg (176 lb). Do not install sliding devices that exceed this weight.
- Always lower the leveling pads on the rack cabinet.
- Always install stabilizer brackets on the rack cabinet.
- Always install servers and optional devices starting from the bottom of the rack cabinet.
- Always install the heaviest devices in the bottom of the rack cabinet.

Handling static-sensitive devices

Attention: Static electricity can damage electronic devices, including your server. To avoid damage, keep static-sensitive devices in their static-protective packages until you are ready to install them.

To reduce the possibility of damage from electrostatic discharge, observe the following precautions:

- When you work on a BladeCenter unit that has an electrostatic discharge (ESD) connector, use a wrist strap when you handle modules, optional devices, or blade servers. To work correctly, the wrist strap must have a good contact at both ends (touching your skin at one end and firmly connected to the ESD connector on the front or back of the BladeCenter unit).
- Limit your movement. Movement can cause static electricity to build up around you.
- Handle the device carefully, holding it by its edges or its frame.
- Do not touch solder joints, pins, or exposed circuitry.
- Do not leave the device where others can handle and damage it.
- While the device is still in its static-protective package, touch it to any *unpainted* metal surface of the BladeCenter chassis or any *unpainted* metal surface on any other grounded component in the rack you are installing the device in for at least 2 seconds. (This drains static electricity from the package and from your body.)
- Remove the device from its package and install it directly into the server without setting down the device. If it is necessary to set down the device, put it back into its static-protective package. Do not place the device on your server cover or on a metal surface.
- Take additional care when handling devices during cold weather. Heating reduces indoor humidity and increases static electricity.

Notices and statements used in this document

The caution and danger statements that appear in this document are also in the multilingual *Safety Information* document on the IBM *BladeCenter Documentation* CD. Each statement is numbered for reference to the corresponding statement in the *Safety Information* document.

The following notices and statements are used in the documentation:

- **Note:** These notices provide important tips, guidance, or advice.
- **Important:** These notices provide information or advice that might help you avoid inconvenient or problem situations.
- **Attention:** These notices indicate possible damage to programs, devices, or data. An attention notice is placed just before the instruction or situation in which damage could occur.
- **Caution:** These statements indicate situations that can be potentially hazardous to you. A caution statement is placed just before the description of a potentially hazardous procedure step or situation.
- **Danger:** These statements indicate situations that can be potentially lethal or extremely hazardous to you. A danger statement is placed just before the description of a potentially lethal or extremely hazardous procedure step or situation.

Chapter 1. System overview

This chapter provides an overview of the IBM® System Cluster 1350 software components, hardware components, and related documentation.

The Cluster 1350 uses two types of cabinets: primary and expansion. A cabinet is called primary if it contains the management node and console monitor. An expansion cabinet can contain storage nodes or mass-storage devices as well as computing nodes, called cluster nodes; it does not contain a management node or a console.

The cluster may consists of:

- One or more racks.
- From four to 1024 cluster nodes. The nodes are configured to run customer applications or provide other services required by the customer, such as file server, network gateway, or storage server.
- One management node (System x3650 or System x3655) for cluster systems management (CSM) and administration.
- A management Ethernet VLAN that is used for secure traffic for hardware control.

The management Ethernet VLAN is used for management traffic only. It is logically isolated for security using the VLAN capability of the Cisco Ethernet switches, and it is only accessible from the management node. The cluster VLAN and management VLANs share the same physical switches.

- A cluster VLAN used for other management traffic and user traffic. Switches integrated with the cluster are used for the management Ethernet VLAN and the cluster Ethernet VLAN.
- Service processor networks. All nodes in the cluster are connected through serial service processors (such as the System x3650). The first node in a serial connection must have a management node, which is connected through the Ethernet to the management-Ethernet VLAN.
- A terminal server network for remote or local console. Optionally, the customer might elect to include an additional network.
- A high-performance Myrinet 2000 cluster interconnect, an additional Gigabit Ethernet, or an InfiniBand switch.
- The customer can elect to configure a subset of cluster nodes with additional external storage. This can be a Fibre Channel solution.
- A supported distribution of the Linux operating system.
- Cluster systems-management software, such as CSM.

The Cluster 1350 supports a maximum of 1024 nodes in addition to the one required System x3650 (or the System x3655 management node for 64-bit processing environments) management node. All nodes must run one of the following Linux versions:

- Red Hat Enterprise Linux (RHEL), version 4 for AMD or EMT (32-bit or 64-bit)
- RHEL, version 4 for AMD or EMT (64-bit)
- SUSE LINUX Enterprise Server (SLES), version 9 for AMD or EMT (64-bit)
- SLES, version 10
- Linux Cluster Installation Tool (LCIT), version 5.0

The Cluster 1350 uses a primary cabinet and an expansion cabinet. The primary cabinet contains the management node and console monitor. An expansion cabinet does not contain a management node or console. An expansion cabinet can contain the following components:

- Cluster or compute nodes
- Storage nodes
- Mass storage devices
- Expansion units
- Networking switches

The following figures illustrate a primary cabinet, an expansion cabinet containing cluster nodes, and an expansion cabinet containing storage controllers and mass storage.

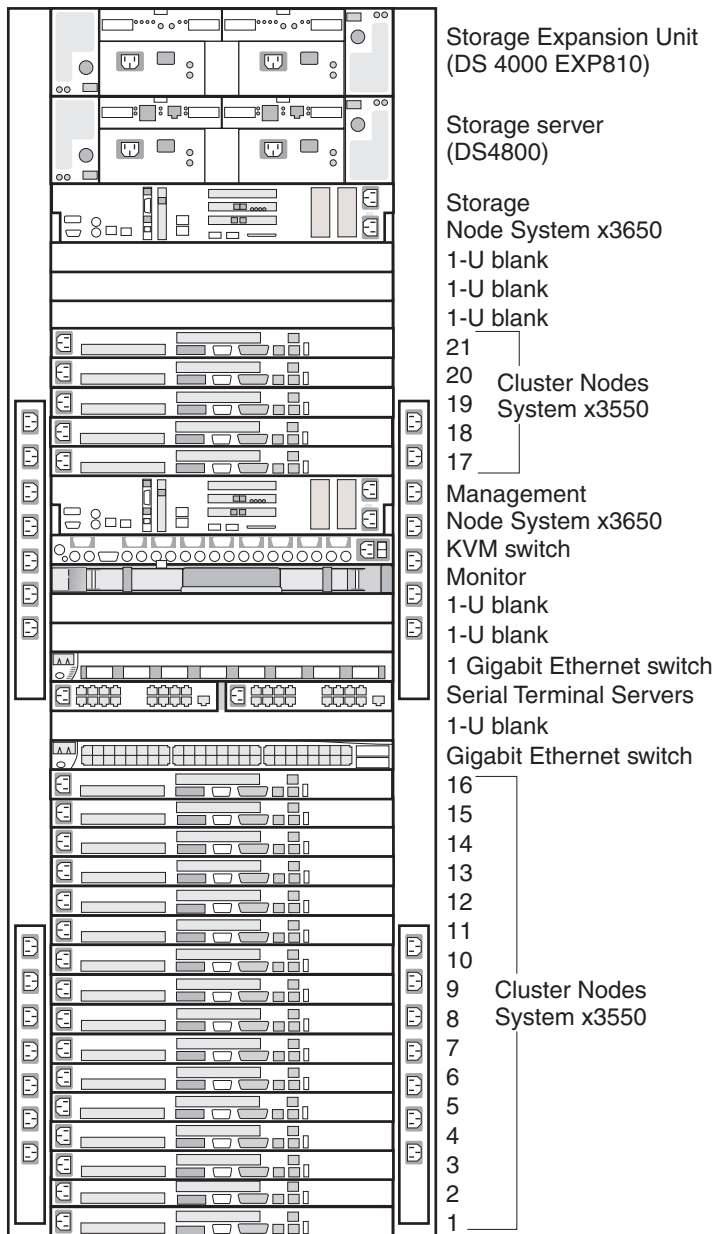

The following figure shows how the node numbering scheme maps to other expansion cabinets.

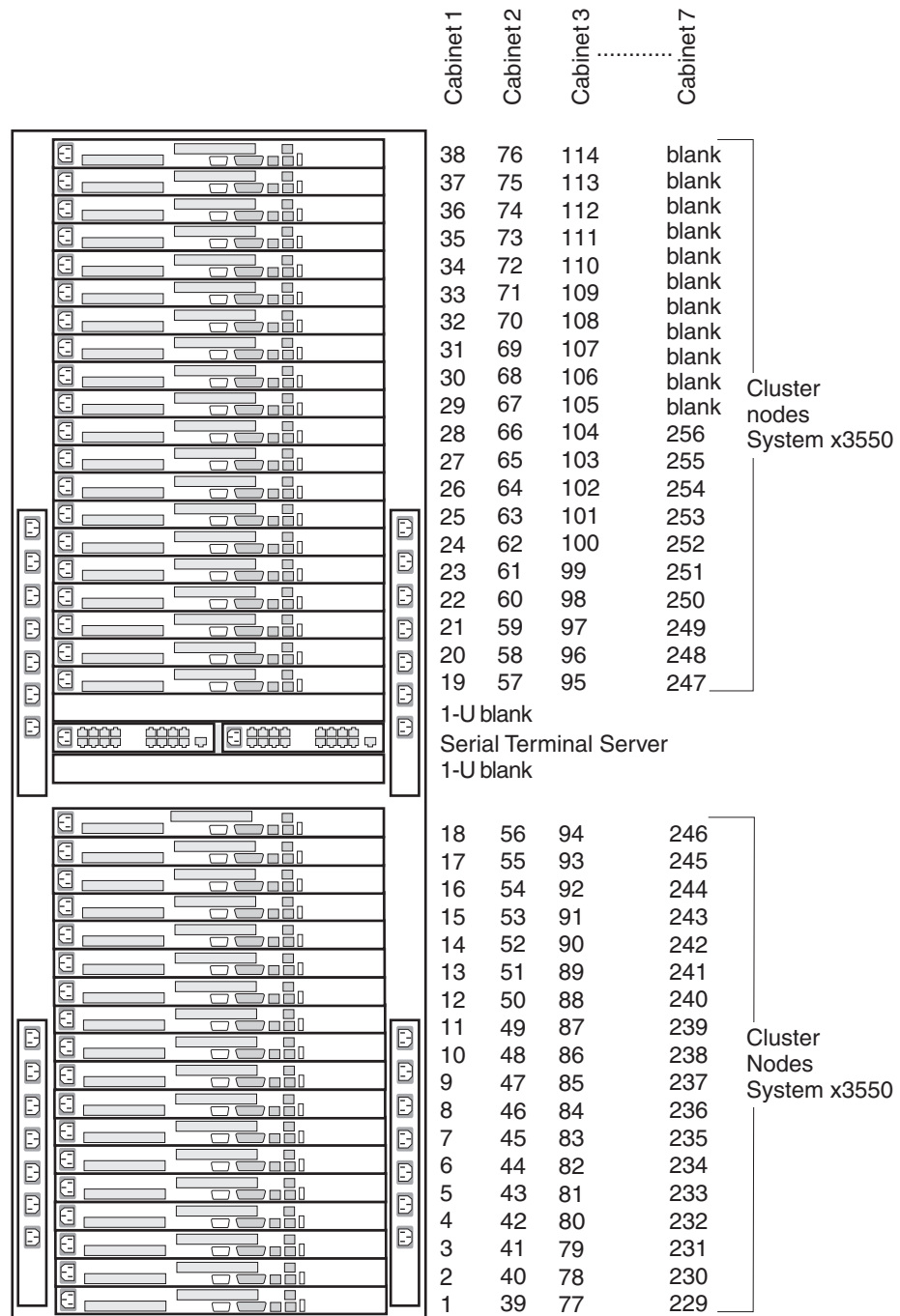

The following figure shows an expansion cabinet containing storage controllers and mass storage.

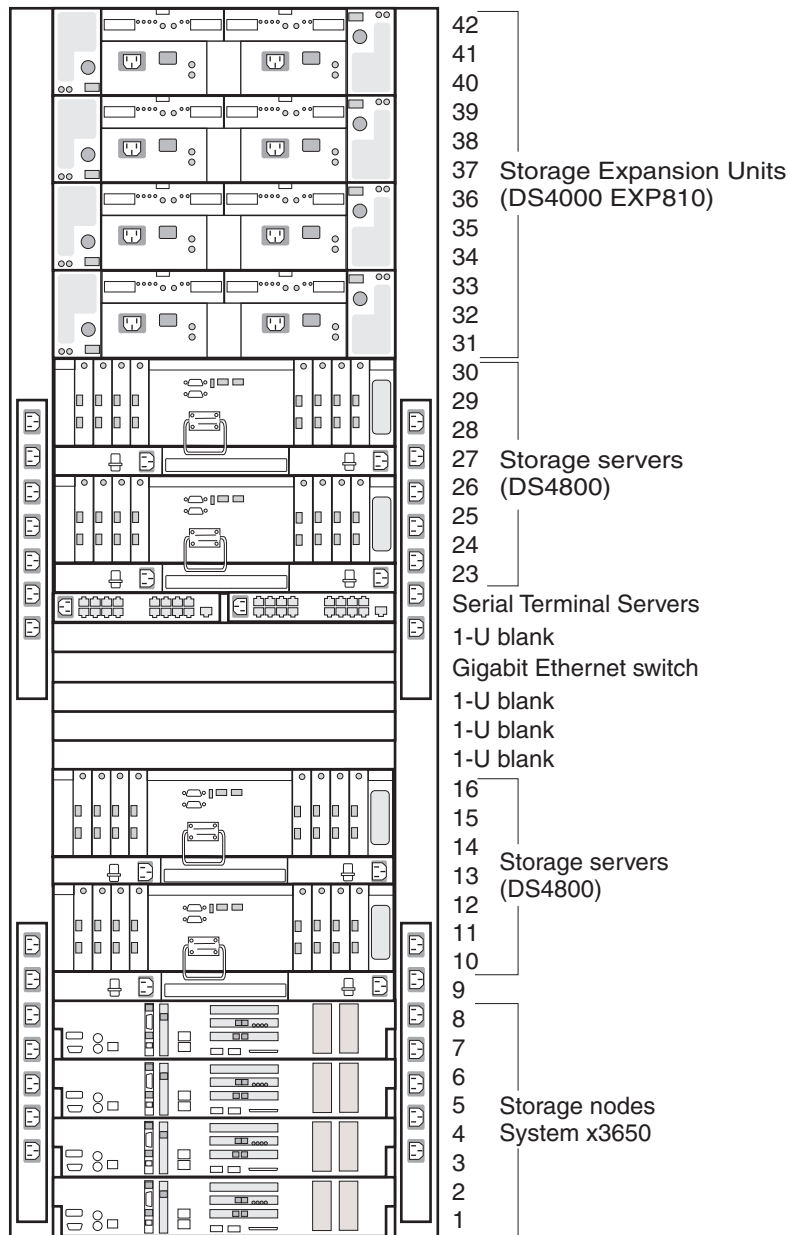

Cluster components

This section describes the components in the Cluster 1350. Cluster components include:

- Cluster nodes
- Management node
- Storage nodes
- Storage servers
- Storage expansion units
- Fibre Channel adapters, switches, and expansion cards
- Hard disk drives

- High-speed adapters
- Console
- KVM switches
- InfiniBand switches and devices
- InfiniBand host channel adapters
- Fibre Channel adapters, switches, and expansion cards
- 10/100/1000 Ethernet switches
- I/O modules
- Terminal servers
- High-speed Myrinet switches and line cards
- Myrinet BladeCenter connectivity
- Power distribution unit (PDU)

Cluster nodes

A cluster must contain at least four cluster nodes. The cluster nodes perform the computational tasks in the cluster. Cluster nodes are also known as compute nodes.

The cluster nodes are a combination of the following components:

- IBM System x3550 server
- IBM System x3650 server
- IBM System x3655 server
- IBM System x3455 server
- IBM System x3755 server
- IBM BladeCenter HS21
- IBM BladeCenter HS21 XM
- IBM BladeCenter JS21
- IBM BladeCenter LS21
- IBM BladeCenter LS41
- IBM BladeCenter QS20 (cell blade)

Management node

Each cluster contains one management node, which provides system management for all modules in the cluster. The Cluster 1350 management node is typically a server running Linux.

- IBM System x3650 server
- IBM System x3655 server

You can also use a 326m server or the IBM BladeCenter Advanced Management Module as the management node in a cluster environment running a 64-bit Linux operating system.

Storage nodes

The optional storage nodes manage the mass storage. The cluster supports up to 64 storage nodes. The total number of storage and compute nodes cannot exceed 1024.

For tasks that do not require large amounts of mass storage, the storage node has onboard disk storage that is typically sufficient. The storage nodes can be a combination of any of the cluster node components.

Storage servers

For the storage server option, the Cluster 1350 system uses the following components:

- IBM System Storage DS3400 Fibre Channel SAS
- IBM System Storage DS4700 Express
- IBM TotalStorage® DS4800 storage server model 82A (4 GB cache)
- IBM TotalStorage DS4800 storage server model 84A (8 GB cache)
- IBM TotalStorage DS4800 storage server model 88A (16 GB cache)

All servers interface with the cluster so that the storage nodes communicate with large RAID-protected arrays of storage.

Storage expansion units

The cluster supports the IBM TotalStorage DS4000 EXP810 disk storage expansion unit.

Fibre Channel adapters, switches, and expansion cards

The cluster supports the following Fibre Channel devices:

- IBM TotalStorage Fibre Channel Host Bus Adapter
- Fibre Channel SCSI/iSCSI single channel adapter
- Fibre Channel SCSI/iSCSI dual channel adapter
- Brocade Fibre Channel switch
- IBM BladeCenter Fibre Channel switch module
- IBM BladeCenter Fibre Channel expansion card
- IBM BladeCenter DS4000 4 Gb PCI-X Dual-port Fibre Channel adapter
- QLogic QLE2460 Single-port PCI-E 4 Gb adapter
- QLogic QLE2460 PCI-E Dual-port 4 Gb Fibre Channel adapter
- QLogic 4 Gb Fiber Channel expansion card
- Fibre Channel switch 2005 model B-16 (16-port)
- IBM BladeCenter DS4000 4 Gb PCI-X Single-port Fibre Channel adapter

Hard disk drives

The cluster supports the following hard disk drives:

- IBM Fibre Channel 73.4 GB disk drive module (10 000 rpm)
- IBM Fibre Channel 146.8 GB disk drive module (10 000 rpm)
- IBM Fibre Channel 300 GB disk drive module (10 000 rpm)
- IBM Fibre Channel 36.4 GB disk drive module (15 000 rpm)
- IBM Fibre Channel 73.4 GB disk drive module (15 000 rpm)
- IBM Fibre Channel 146.8 GB disk drive module (15 000 rpm)
- IBM 4 GB modular FLASH drive
- Small Form Factor (SFF) 36 GB SAS hard disk drive (2.5 inches)
- SFF 73 GB SAS hard disk drive (2.5 inches)
- 300 GB SAS hard disk drive (3.5 inches and 15 000 rpm)

- 500 GB SATA hot-swap hard disk drive (3.5 inches and 7200 rpm)
- 750 GB SATA hot-swap hard disk drive (3.5 inches and 7200 rpm)
- 750 GB SATA simple-swap hard disk drive (3.5 inches and 7200 rpm)
- 750 GB Dual port SATA hot-swap option
-

High-speed adapters

The Cluster 1350 supports the following SCSI/RAID storage controller adapters:

- IBM ServeRAID 8k Ultra 320 SCSI controller adapter
- NetXtreme 1000 T + Ethernet adapter
- NetXtreme 1000 T + dual port Ethernet adapter
- Intel PRO/1000 PCI-Express G Ethernet adapter
- Myricom 8x PCI-Express, 2 MB memory, 10GBase-CX4 adapter
- Myricom 10 Gb Ethernet Network Interface Card for SR Fiber with LC Fiber connector
- Myrinet 333 MHz Dual Fibre/PCI-X "E" card (2 Mb)
- Myrinet 333 MHz Single Fibre/PCI-X "F" card (2 Mb)
- Voltaire 10 Gbps Host Channel PCI-X adapter
- Voltaire 10 Gbps Host Channel PCI Express adapter

Console

The console provides the monitor, keyboard, and mouse for the management node. The monitor is a 1-U flat-panel display that folds down and retracts into the rack.

KVM switches

The KVM switch allows the console to connect to all the nodes in the cluster from one terminal location. Storage and management nodes are connected directly to the KVM switch. For cluster nodes in the same rack, you can configure multiple nodes on one KVM switch port.

The Cluster 1350 can use one of the following devices:

- IBM NetBAY™ 1 x 8 console switch
- IBM NetBAY 2 x 16 console switch
- IBM NetBAY Local 2 x 8 Console Manager (LCM)
- IBM NetBAY Global 2 x 16 Console Manager
- IBM NetBAY Global 4 x 16 Console Manager

InfiniBand switches and devices

The following InfiniBand switches and line cards are supported:

- Cisco Systems SFS 7000P InfiniBand server switch
- Voltaire InfiniBand 9096 switch bundle
- Voltaire InfiniBand 9288 switch bundle
- Voltaire InfiniBand Switch 9024D-M
- Voltaire InfiniBand Switch 9024S-M
- InfiniBand daughter card module for IBM BladeCenter

InfiniBand host channel adapters

The following InfiniBand host channel adapters are supported:

- Voltaire InfiniBand host channel adapter PCI-X
- Voltaire InfiniBand host channel adapter PCI-Express

10/100/1000 Ethernet switches

The 10/100/1000 Ethernet switch provides a 1 Gb Ethernet trunk line between the management node and the cluster and storage nodes. The 1 Gb uplink ports use optical cables.

Note: The Force 10 E1200 Terascale DC chassis bundle and the Force 10 5-Slot AC rectifier chassis is installed by an IBM service representative but the customer is required to have a licensed electrician available to make the initial connection and service connections of these devices. Whenever the device requires on-site IBM service support, the customer is required to provide an on-site licensed electrician.

The Cluster 1350 uses the following switches as 10/100/1000 Mb Ethernet switches:

- IBM BladeCenter Gigabit Ethernet switch module (4-port)
- Force10 1-U stackable switch (48-port - 2 x 10 Gb uplinks)
- Force10 E300 switch chassis bundle
- Force10 E600 switch chassis bundle
- Force10 E1200 Terascale DC chassis bundle
- Force10 5-Slot AC rectifier chassis
- Force10 1-U stackable switch (48-port)
- SMC 8848 M switch chassis bundle
- Cisco Catalyst 6503-E switch
- Cisco Catalyst 6509-E switch
- Cisco Catalyst 3750 Ethernet switch (48-port)
- Cisco Catalyst 4506 switch chassis
- Cisco Catalyst Gigabit Ethernet Switch Module for IBM BladeCenter
- Nortel L2/L3 Copper Gigabit Ethernet Switch Module for IBM BladeCenter

10 Gigabit Ethernet switches

The Cluster 1350 uses the SMC 8708L2 Tiger IV (8-port) 10 Gb Ethernet switch.

I/O modules

I/O modules provide an unconfigured network connection that enables the blade servers to connect to an existing network infrastructure. No configuration is required. The cluster supports the following I/O modules:

- IBM BladeCenter Gigabit Ethernet switch module (4-port)
- Copper Pass-thru Module for IBM BladeCenter
- IBM BladeCenter Optical Pass-thru Module
- Cisco Systems Gigabit Ethernet Switch for IBM BladeCenter
- Brocade Entry SAN Switch Module for IBM BladeCenter
- Brocade 4 Gb SAN Switch Module for IBM BladeCenter (20-port)
- InfiniBand Switch Module for IBM BladeCenter

- IBM BladeCenter Layer 2/Layer 3 Copper Gigabit Ethernet Switch Module
- Qlogic 4 Gb switch module (20-port) for IBM BladeCenter
- IBM TotalStorage SAN switch module (16 B-2)

Terminal servers

The terminal server provides serial connections for cluster modules. The Cluster 1350 uses the following switches as terminal servers:

- Cyclades terminal server with a single power supply (32-port)
- Cyclades terminal server (48-port)

The main purpose of the terminal server is to have out-of-band console access to cluster components.

High-speed Myrinet switches and line cards

This is an optional 2 Gb or 4 Gb switch or line card for interconnecting cluster nodes and storage nodes. The Cluster 1350 supports the following Myrinet models:

- M3-E32 (5-slot)
- M3-E64 (9-slot)
- M3-E128 (17-slot)
- M3F-PC164C-2 (PCI adapter)
- M3F-PCIXF-2 line card
- M3F2-PCIXE-2 (low-profile PCI-X dual-port card)
- M3-SW16-8E (Ethernet line card)
- Myrinet 14-U, 20-slot enclosure (256-ports)
- Myrinet 14-U, 20-slot spine enclosure
- Myricom 14-U, 10 Gb CLOS switch bundle (128-ports)
- Myricom 14-U, 10 Gb Leaf switch bundle
- M3-4SW32-16Q line card (16-ports quad)
- M3-THRU-16Q (spine thru module)
- M3-SW32-16F line card (SW32 with 16 fiber port front connections)
- M3-2SW32 line card
- M3S-PCIXD-2-1 line card (2Mb)
- M3S-PCIXF-4-1 line card (4 Mb)

The high-speed switch can replace the optional secondary Ethernet switch. It requires a Myrinet PCI adapter in each cluster node and storage node.

Myrinet BladeCenter connectivity

Myrinet BladeCenter connectivity support includes a Myrinet PCI card, the Optical Pass thru Module, an I/O expansion card, and special cable options.

Power distribution unit (PDU)

Each rack contains one or more of the following power distribution units:

- IBM NetBAY Rack Power Distribution Unit (PDU)
- IBM NetBAY Front-End PDU
- IBM Distributed Power Interconnect (DPI[®]) Rack PDU
- IBM DPI Front-End PDU
- IBM DPI High Density PDU

Some PDUs are mounted sideways beside the rack space. The cluster supports rack PDUs and front-end PDUs. The cluster can have the PDUs installed in the side pockets and not accessible from the rear. Some of the newer cluster configurations provide access to the PDUs from the rear of the system cabinet.

Rack PDUs provide power to components within a cabinet; front-end PDUs provide the connection to the external power source and distribute the power among the rack PDUs. To eliminate the need for the front-end PDU, a rack PDU is directly connected to the external power source. Up to four front-end PDUs and up to 12 rack PDUs can be placed in each cabinet.

Related documentation

Your cluster might have features that are not described in the documentation that you received with the cluster. The documentation might be updated occasionally to include information about those features, or technical updates might be available to provide additional information that is not included in your cluster documentation. These updates are available from the IBM Web site at <http://www.ibm.com/systems/support/>.

To remove and configure a cluster component, see the documentation that comes with the component.

To check for updated documentation, related documentation, and technical updates, go to <http://www.ibm.com/systems/support/>.

To check for a list of components supported for each software release, go to <http://publib.boulder.ibm.com/cluster/1350downloads.htm>.

Chapter 2. Cabinet placement and intercabinet cabling

This chapter provides information about the final placement and intercabinet cabling of the cluster cabinets, how to install the frame stabilizer foot and outrigger to support each cabinet, and how to prepare to install a Rear Door eXchanger Assembly unit.

Minimum service clearances

Several factors influence final cabinet placement. In addition to adequate cable length and staying within safe floor loading limits for your installation site, observe the minimum clearances required for service of the racks in the Cluster 1350. You might want to plan for extra space around the racks to allow movement of racks for service.

Figure 1 shows the clearances needed for servicing a rack in the Cluster 1350. Note that the service clearances for the sides of the rack are not required for operation, but only for servicing the PDUs.

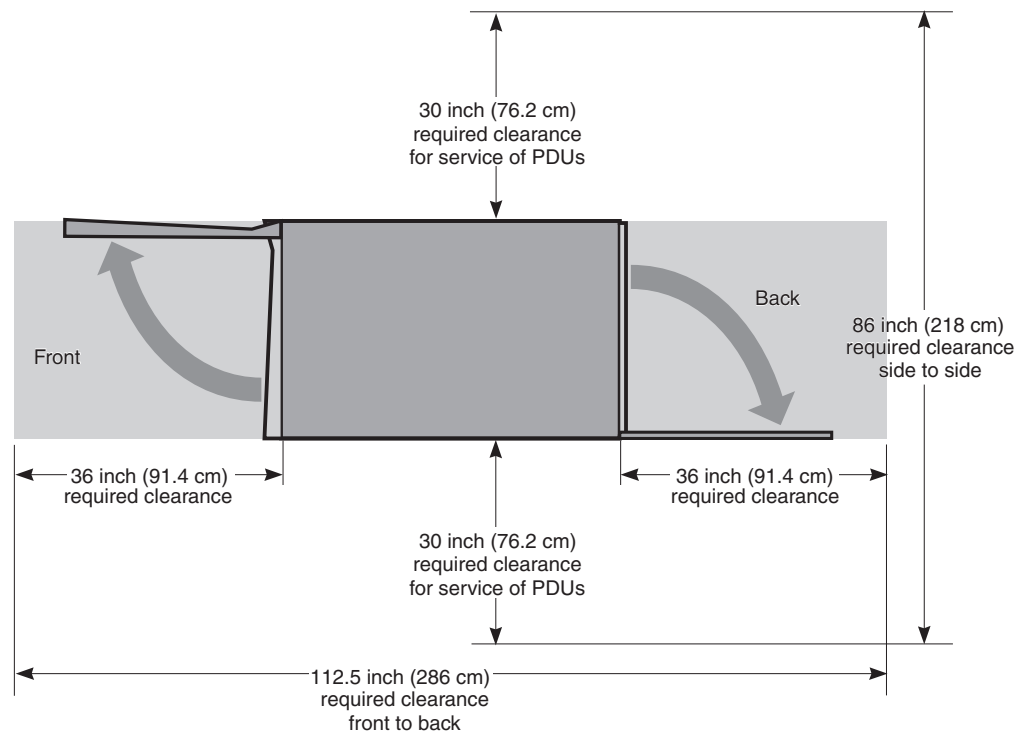

Figure 1. Cabinet clearances required for service

When planning the installation of a large cluster and you want to arrange the racks in several rows, you must maintain a minimum aisle width of 91.4 cm (36 inches) as shown in Figure 2 on page 14. This will allow enough space for the front and back covers of the racks to open. An aisle width of 122 cm (48 inches) might be more appropriate if you want to make sure that you have enough room to move the rack to gain access to the sides for servicing the PDUs.

If you purchase a Myrinet CLOS 256 switch with your Cluster 1350, make sure to rotate the switch rack 180 degrees so that the rear of the rack unit is facing forward. This placement makes sure that there is proper air flow for the Myrinet device. See the *Installation Guide* that came with your Myrinet CLOS 256 component for more information.

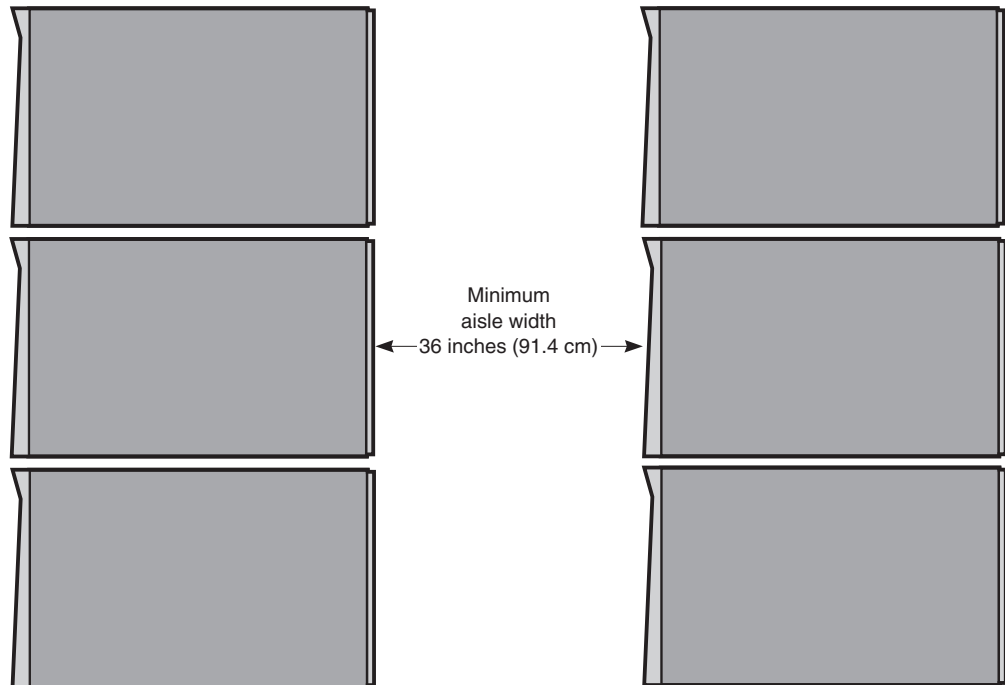

Figure 2. Minimum aisle width for Cluster 1350 installations

Final cabinet placement determines what will qualify as adequate cable lengths. This chapter gives guidelines for intercabinet (rack-to-rack) cabling. Use these guidelines to determine the best cable lengths for your installation.

Remember to install the stability kit and engage the outriggers when the cabinets are placed in their final location. See "Installing a stability kit" on page 16 for information about installing the stability kit that comes with each cabinet. See "Engaging the side stabilizers" on page 16 for information about engaging the side stabilizers.

Types of intercabinet cabling

Cabinet placement is partly determined by the cables that run between cabinets. Both optical and copper cables are involved.

All intercabinet (rack-to-rack) cables and cable harnesses come in varying lengths up to 25 m (82 ft.). There are no layout restrictions.

Color-coded CAT5E intercabinet Ethernet cables are available for intercabinet cabling of the cluster components. The color-coded cables operate exactly as the existing cluster intercabinet Ethernet cables with the added advantage of being able to group like-devices by a specific color. The cable colors and lengths include:

- Blue - 0.6 m (1.97 ft.), 1.5 m (4.92 ft.), 3 m (9.84 ft.), 10 m (32.8 ft.), 25 m (82 ft.)
- Green - 0.6 m (1.97 ft.), 1.5 m (4.92 ft.), 3 m (9.84 ft.), 10 m (32.8 ft.), 25 m (82 ft.)
- Yellow - 0.6 m (1.97 ft.), 1.5 m (4.92 ft.), 3 m (9.84 ft.), 10 m (32.8 ft.), 25 m (82 ft.)

Note: In some clusters, the FRU intercabinet cables can also be white or gray.

Use the following table for the available lengths for the different cables and cable harnesses.

Table 1. Available lengths for fibre-based Ethernet and Fibre Channel cables

Length	Part number	Note
0.208 m (8.19 inches)	19K1250	Fibre channel cable, LC to SC
1 m (3.28 ft.)	39M5696	Fibre channel cable, LC to LC
5 m (16.4 ft.)	39M5697	Fibre channel cable, LC to LC
25 m (82 ft.)	39M5696	Fibre channel cable, LC to LC

Cabinet placement guidelines

Use the following guidelines when placing the cabinets:

- Cabinets can be placed side-by-side in contact with one another. Remember that to service any PDU in a cabinet, you must remove the side covers. At least 0.762 m (30 inches) of working clearance is required to ensure the safe removal of a side cover and provide access to the PDU. If the cabinets are placed side-by-side in contact with each other, leave enough extra space around the cluster so that you can move the cabinets if a PDU needs service. Cabinet placement must not exceed floor-loading limits.
- Cabinet placement must allow for access to both the front and back panels. At least 0.914 m (36 inches) of working clearance is needed to remove or insert a module into the rack.
- Cables and cable harnesses are custom made to fit the order.
- Make sure that the cabinets are arranged correctly and adjust them if necessary. See the packing slip and the cabinet labels to verify that all cabinets are in their correct locations.
- If you have purchased an IBM Rear Door Heat eXchanger, make sure that you have prepared the installation area with the proper fluid access, fluid connections, and fluid drainage. See “Preparing a Rear Door Heat eXchanger” on page 18 for more information.

Attention: Ensure that all rack-mounted units are fastened in the rack frame. Do not extend or exchange any rack-mounted units when the stabilizer is not installed.

To finish the cabinet placement, complete the following steps:

1. Inspect the cabinets, components, and cable connections for shipping damage.
2. Install the frame-stabilizer foot on each cabinet. Figure 3 shows how to install a frame-stabilizer foot.

Installing a stability kit

A stability kit (IBM part number 31L8305), containing one stability kit, is included with the 1410 rack. Install the stability kit when the rack is at the final installation location. Figure 3 shows the attachment of the stability kit.

Figure 3. Cluster 1350 stability kit

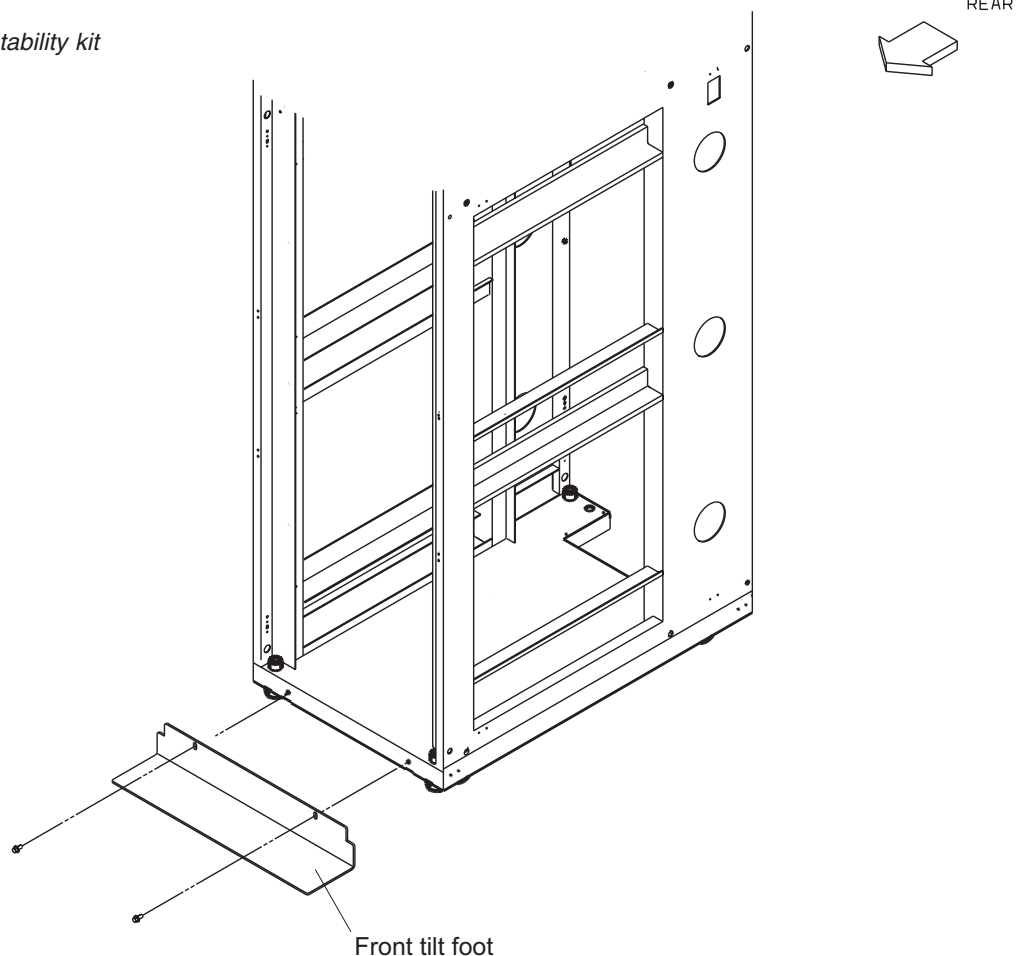

Engaging the side stabilizers

The rack cabinet provides side stabilizers, to give additional support to the rack unit. Engage the side stabilizers when the rack is at the final installation location. For more information about how to engage the stabilizers, see the documentation that came with your rack cabinet.

Floor loading

To determine the clearances required for each rack, you must know the maximum floor load rating in pounds per square foot or kilograms per square meter at your installation site. Table 2 on page 17 shows the necessary clearances or weight-distribution distances for a fully configured rack. The weight-distribution

distances in all four directions indicate the area around the rack (minus covers) necessary to distribute the weight beyond the perimeter of the rack. Weight-distribution areas must not overlap with adjacent computer equipment weight-distribution areas. You must also take into consideration the additional weight of the cables.

For example, if the raised floor at your site could safely support 351.5 kg/m² (72.0 lb./ft.²) then the correct distance between the sides of each cabinet would be 1.016 m (40 inches). You would also maintain front and back clearances of 0.762 m (30 inches), making sure that no other equipment was placed within the area.

The Cluster 1350 cabinet footprint without covers is 0.622 3 m (24.5 inches) by 1.021 m (40.2 inches). The values shown in the Table 2 assume a maximum rack weight of 1003 kilograms (2211 pounds). Floor loading will vary by configuration.

If you need to know the approximate point load that each caster exerts on a raised floor panel, divide the weight of the rack by four.

Table 2. Floor loading

lb./ft.²	kg/m²	Side clearances	Front and back clearances
72.0	351.5	508 mm (20 in.)	762 mm (30 in.)
78.4	382.8	508 mm (20 in.)	610 mm (24 in.)
86.8	423.8	508 mm (20 in.)	457 mm (18 in.)
93.1	454.6	254 mm (10 in.)	762 mm (30 in.)
102.4	500.0	254 mm (10 in.)	610 mm (24 in.)
114.5	559.1	254 mm (10 in.)	457 mm (18 in.)
112.8	550.8	127 mm (5 in.)	762 mm (30 in.)
124.8	609.3	127 mm (5 in.)	610 mm (24 in.)
140.5	686.0	127 mm (5 in.)	457 mm (18 in.)
139.3	680.1	25 mm (1 in.)	762 mm (30 in.)
154.9	756.3	25 mm (1 in.)	610 mm (24 in.)
175.4	856.4	25 mm (1 in.)	457 mm (18 in.)

Preparing a Rear Door Heat eXchanger

If you purchased an IBM Rear Door Heat eXchanger with your Cluster 1350, it is attached to the rack unit by an IBM service representative during the hardware installation.

After a door is installed, the customer is responsible for filling the fluid, draining the fluid, and connecting or disconnecting the plumbing connections when the unit arrives or is replaced by an IBM service representative. You might want to plan for extra space around the racks to allow movement of racks for fluid service. See the *Installation and Maintenance Guide* that comes with the Rear Door Heat eXchanger or go to <http://www.ibm.com/systems/support/> for more information.

Chapter 3. Cabling the Cluster 1350

Most of the cabling in a Cluster 1350 system is installed during manufacturing. However, there are three instances where cables must be installed at a customer site:

- Cables between cabinets
- Replacements for faulty cables
- Cables to replacement components

Any cable that fails at the customer site or is connected to components that must be replaced must be reconnected at the customer site.

The various types of cables in the Cluster 1350 system perform functions such as providing serial and Ethernet connections to cluster components.

Notes:

1. There are additional color-coded intercabinet Ethernet cables available to help you organize your cluster cabling by color. The current cable colors include green, blue, and yellow with lengths varying from 0.6m to 25m. These cables do not replace previous Ethernet cables but can be used in place of previous cables if you prefer a color-coded cabling scheme. Contact your sales representative to order additional color-coded intercabinet Ethernet cables.
2. In some clusters, the FRU interconnect cables can also be grey or white.

Management VLAN

The management virtual local area network (VLAN) provides VLAN to manage the components in the cluster. This VLAN includes the following connections:

- RS-485 connections to all cluster nodes and storage nodes. These enable diagnostics and monitoring for the cluster and storage nodes.
- Serial connections to all cluster components. These provide a path for configuration of components in the cluster.

Primary cluster VLAN

The primary cluster VLAN provides a 10/100/1000 Ethernet connection (depending on the selected VLAN type) for communication with cluster nodes and storage nodes. This VLAN includes the following connections:

- A 10/100/1000 Mb Ethernet connection to all cluster and storage nodes and other components. This provides the primary communications between the management node and the other components in the cluster.
- A Gigabit Ethernet trunk line (shared with the management VLAN) for certain VLAN types only. This serves as a high-speed trunk line for all Ethernet communication within the cluster.

Optional secondary cluster VLAN

The optional secondary cluster VLAN provides a second 10/100/1000 Ethernet or a Myrinet switch (2 Gb or 4 Gb) for communication with cluster and storage nodes. The following options are available for the secondary cluster VLAN:

- 10/100/1000 Ethernet connection
- 2 Gb or 4 Gb Myrinet connection

Keyboard/video/mouse

The keyboard/video/mouse (KVM) connects the ports on all nodes (cluster, storage, and management) to a single console through a central switch.

Fibre-channel cables

Fibre-channel cables provide fibre-channel connections between the storage nodes and the storage servers and between the storage servers and the storage expansion units.

Power distribution units

The power distribution unit provides the power to the cluster components. This includes both the power to the entire cabinet through the PDUs and remote power to the terminal servers through the power management module.

Connecting the cables

Cables and the cable harnesses in each cabinet are labeled with information that tells where to connect each end of the cable. Each label identifies the device or node it connects to, and where applicable, its port number.

Depending on the country of manufacture the label scheme will vary. Before you begin attaching cables, become familiar with the information on the labels.

When installing a Cluster 1350, start with the primary cabinet. After you have connected the intracabinet cables inside the primary cabinet, move on to each expansion cabinet and use the information printed on each cable label to connect the cables in the cabinet.

After you have connected any cables in the primary cabinet and expansion cabinets, connect the cables that run between the cabinets. This is called the intercabinet cabling.

For a complete listing of all available cables and their part numbers, see <http://www.ibm.com/systems/support/>. The information is also available in the IBM Current Object Repository (CORE) system.

Note: Each intercabinet cable has labels at both ends. You can use the information on the label to create a site map to document all cable routing.

1 Gigabit Ethernet cabling

The 1 Gb Ethernet provides a high-speed optical trunk line for VLAN communication with the management node.

Myrinet high-speed switch cabling

The Myrinet high-speed switch provides an optional 2 Gb optical network for communications between cluster nodes and storage nodes.

10/100/1000 Ethernet cabling

The 10/100/1000 Ethernet switch provides an optional 10/100/1000 network for communications between cluster nodes and storage nodes.

Fibre-channel cabling

Fibre channel is used to connect storage nodes to storage servers and to connect storage servers to storage expansion units.

KVM cabling

The KVM switch allows a maximum of eight connections. Use the following guidelines for cabling the KVM switch:

- Use the information on each end of each cable to create a site map.
- When routing a KVM cable from a cabinet containing cluster nodes to another cabinet containing the KVM switch, connect a C2T-to-KVM cable to the cluster nodes and use a KVM extension cable to add sufficient length to reach the KVM switch.
- Multiple KVM switches can be connected in series. Cluster nodes can be connected in series to a single KVM switch port, but the management node and all the storage nodes each require a separate KVM switch port. Certain systems might require a second KVM switch. Install the second switch in the expansion cabinet that contains the additional storage nodes.
- When using two KVM switches, connect Port A (the console port) of switch 2 to port 8 of switch 1. Use a KVM extension cable to make the connection between the two cabinets. If more length is needed, use two KVM extension cables linked together.

Remote console manager cabling

The remote console manager (RCM) switch has 16 ACT connections (KVM over RJ-45/CAT5) and one KVM connection for the console. Use the following guidelines for cabling the RCM switch:

- Use the information on each end of each cable to create a site map.
- When routing a CAT5 KVM cable from a cabinet containing cluster nodes to the cabinet containing the RCM, use a CCO cable and a CAT5 cable sufficiently long enough to reach the RCM switch.
- Multiple KVM switches can be connected in series.
- Up to 40 cluster nodes can be connected in series to each ACT port on the RCM. The management node and all the storage nodes can also be daisy-chained, with up to 16 per ACT port. Multiple RCMs can not be daisy-chained together. The RCM can be connected to an Ethernet network to allow for remote access to the consoles of the servers over the network.

Local console manager cabling

The local console manager (LCM) switch accepts the CAT5 input from the NetBay Conversion Options and allows them to be fed into your management station. Its four CAT5 input ports support four chains of 16 servers per chain. The local console manager (LCM) switch also supports Cable Chaining Technology (C2T).

Use the following guidelines for cabling the LCM switch:

- Use the information on each end of each cable to create a site map.
- When routing a CAT5 KVM cable from a cabinet containing cluster nodes to the cabinet containing the LCM, use a CCO cable and a CAT5 cable sufficiently long enough to reach the LCM switch.
- Multiple KVM switches can be connected in series.
- Up to 16 cluster nodes can be connected in series.

Voltaire InfiniBand switch router cabling

Each Voltaire InfiniBand switch accepts one RS-232 cable for the Ethernet management port.

Replacing a defective cable in a harness

If a cable in a harness is defective, complete the following steps to replace the cable:

1. Make sure that the power for the device with the defective cable is turned off.
2. Disconnect both ends of the defective cable from their ports. Do not remove any other connectors from their ports.
3. If possible, remove the cable from the harness. Otherwise, use a pair of wire cutters to cut off the connectors at both ends of the defective cable. This prevents someone from mistakenly reconnecting the cable, thinking that it has inadvertently been left unconnected.
4. Using a wire nut or electrical tape, secure the exposed cable wires.
5. Install a single cable between the two empty ports. Use wire ties to attach the cable to the harness that contains the defective cable. This identifies the replacement cable as belonging to this harness.
6. Label the replacement cable so it is clearly identified as a replacement.

Chapter 4. Checking the Cluster 1350 cabling process

The IBM System Cluster 1350 comes without an operating system installed unless the option is purchased that includes a preloaded operating system. An IBM customer service representative (CSR) performs the hardware cabling process then the customer performs the operating system and device software installation unless a service contract is purchased that includes the software installation.

Before turning on a Cluster 1350 system, you must first check all the connections in the expansion cabinets and primary cabinet. After you have verified that all connections are secure, turn on the expansion cabinets containing storage nodes, storage servers, and storage expansion units. Turn on the primary cabinet last.

Note: If you have a component that does not display the operational blue LEDs on the control panel, see “Diagnosing a lights out or brown out event” on page 25.

Installing cables and checking connections in the expansion cabinets

To install cables and check the connections in the expansion cabinets, complete the following steps:

1. Make sure that the circuit-breaker switches for the source power are all turned off.
2. Open the side and rear doors of the cabinet.
3. From the side of the cabinet, make sure that all the power cables between the rack power distribution units and the front-end power distribution units (PDUs) are fully seated.
4. From the back of the cabinet, push on all the connectors on the cables running from the rack-mounted devices powered by the power distribution units to make sure that the cables are fully seated.
5. Connect power to the power distribution units:
 - a. Connect the power cable to the power distribution unit.
 - b. Pull the power cable through the opening at the base of the cabinet.
 - c. Connect the power cable to the electrical outlet.
 - d. Turn on the power breaker switch for the source power.
 - e. Make sure that the power distribution unit circuit breakers are in the **On** position.
6. Make sure that all internal power distribution units are turned on by viewing the power LEDs on the power distribution unit connected components.
 - When power is applied, servers display a flashing green LED on the front panel.
 - The following devices have no power switch and turn on automatically when the power distribution units are turned on. Make sure that the following components have power applied:
 - KVM switches
 - Cisco Gigabit switches

All rack-mounted devices are powered by the internal power distribution unit.

Installing cables and checking connections in the primary cabinet

To install cables and check the connections in the primary cabinet, complete the following steps:

1. Make sure that the source power breaker switches are all turned off.
2. Open the side and rear doors of the cabinet.
3. From the side of the cabinet, make sure that all the power cables between the rack power distribution units (PDUs) and the front-end PDUs are fully seated.
4. From the back of the cabinet, push on all the cable connectors running from the rack-mounted devices powered by the power distribution units to make sure that the cables are fully seated.
5. Connect power to the power distribution units. Use a NEMA L6-20, 280 V ac, single-phase power cable.
 - a. Connect the power cable to the power distribution unit.
 - b. Draw the power cable through the opening at the base of the cabinet.
 - c. Connect the power cable to the electrical outlet.
 - d. Turn on the power breaker switch for the source power.
 - e. Make sure that the power distribution unit circuit breakers are in the **On** position.
6. Make sure that all internal power distribution units are turned on by viewing the power-on LEDs on the power distribution unit connected components.
 - When power is applied, servers display a flashing green LED on the front panel.
 - The following devices have no power switch and turn on automatically when the power distribution units are turned on. Make sure that the following components have power applied:
 - KVM switch
 - Cisco 10/100 switch
 - Cisco Gigabit switch

All rack-mounted devices are powered by the internal PDU.

Turning on the power to the expansion cabinets

To turn on the expansion cabinets, complete the following steps:

1. Turn on the cluster nodes using their power switches.
2. Make sure that the management node has power. A green LED on the front panel is lit to indicate that the node has power.
3. After an expansion cabinet is turned on, make sure that all front panel LEDs on the cluster nodes are lit; otherwise, not all the nodes will be shown in the configuration.

Repeat the procedure for every expansion cabinet unit in the cluster before powering on the primary cabinet.

Turning on the power to the primary cabinet

To turn on the primary cabinet, complete the following steps:

1. Storage expansion units - on the back of each storage expansion unit turn on the circuit breakers.
2. Storage controllers - on the back of each storage controller turn on the circuit breakers.
3. Management node - on the front of each , turn on the power switch. Make sure that the node passes POST with no errors. During the startup process make sure that the PXE boot agent utility program attempts to run. If it does not, press F1 to start the Configuration/Setup utility program and add **Network** as

- a third boot option. After the node has started, the **No operating system** icon is displayed correct. If any yellow warning LEDs on the management node are lit, fix the underlying condition before continuing.
- Cluster node 1 - turn the power on and make sure that the node passes POST with no errors. During the startup process make sure that the PXE Boot Agent Utility program attempts to run. If it does not, press F1 to start the Configuration/Setup utility program and add **Network** as a third boot option. After the node has started, the **No operating system** icon is displayed correct. If any yellow warning LEDs on the management node are lit, fix the underlying condition before continuing.
 - Storage node - on the front panel, turn on the power switch. During the startup process make sure that the PXE Boot Agent Utility program attempts to run. If it does not, press F1 to start the Configuration/Setup utility program and add **Network** as a third boot option. After the node has started, the **No operating system** icon is displayed correct. If any yellow warning LEDs on the management node are lit, fix the underlying condition before continuing. You must turn on the peripheral devices and bring them online before you turn on the storage nodes so that the storage nodes can detect them.
 - Make sure that all CAT5 and Fibre Channel connections have a green link LED.
 - Make sure that the management node has power. A green LED on the adapter faceplate is lit to indicate that power is applied to the adapter. Connect your mobile computer to a 10/100 switch and configure it to use IP address 172.22.30.20 with a net mask of 255.255.0.0. Log in to the management node using the Web interface and make sure that each adapter is present. Ping each communication device (switches, terminal server, power management module, and KVM switch).

Verifying the hardware installation

A startable CD is included with the Linux Cluster Installation Tool (LCIT) installation materials. With the 1350 Cluster, you also receive tab files that list the rack hardware configuration. To make sure that you install the cluster components correctly, run LCIT to generate a new set of tab files. Compare the new tab files to the tab files that come with the cluster to make sure that the two sets of tab files are identical. If the tab files are not identical recheck the component installation. You can also use LCIT to help you locate nodes that do not start as expected. For more information about using LCIT, see the *User's Guide* that is located on the CD-ROM that comes with your system and located at <http://www.ibm.com/systems/support/>

Diagnosing a lights out or brown out event

If you experience a problem after the hardware installation, you can do a visual check of the cluster components to see if the cluster components light the various component LED indicators after installation. The following sequence occurs during a lights out or brown-out event scenario.

- A lights-out event or brown-out event occurs. The system turns off and then turns back on through an external source.
- All nodes turn on to the last known state (On/Off). If the last known state is On, then the nodes start and display a login prompt.
- Log files show system restart events on nodes. If a lights-out or brown-out event occurs, check the following log files:
 - `/var/log/messages`
 - `/var/log/csm/installnode.log` (management server)
 - `/var/log/csm/install.log` (on the node)
 - BIOS code event log

Related topics

See Appendix A, “Error and event logs,” on page 29.

Chapter 5. Accessing the cluster from a remote location

This chapter includes information about:

- Accessing the cluster from a remote location
- Accessing each node before the operating system is installed

For more information about monitoring, remote control, set-up, and technical references, see: <http://www.ibm.com/servers/eserver/clusters/library/linux.html>

Using the remote power command

The command **rpower** starts and resets hardware, powers hardware on and off, and queries the node power state. The syntax is:

```
rpower -h  
[-v] {-a | -A |  
[[-n node_list I [-N nodegroups]  
[-d device_list] [-D devicegroups]]}  
{on | off | reboot | [-l] query | resetsp_hcp |  
resetsp_host | -m {full | lpar} cec_on | cec_off | [-l] cec_query}
```

Remote console

The remote console function uses the serial ports of servers and terminal servers. The serial ports provide remote access to nodes before the operating system is installed or when network access to the servers is unavailable or has failed. Terminal servers must be included to enable the remote console function.

Each rack unit in the configuration includes one or two terminal servers to connect each node in the rack through a DB9 to RJ45 serial cable. The terminal servers are LAN connected to the Management VLAN.

The **rconsole** command accesses the remote console. This command opens a remote console session for any cluster node. The syntax is:

```
rconsole [-h] [-x]  
[-a I -A | {[ -n node_list] [-N nodegroups]  
[-d device_list] [-D devicegroups]]]  
[-t] [-o] | -O number of columns]] [-c [-v] | [-r | -f]]
```

Displaying node configuration information

CSM maintains a database of configuration information (tab files) about the nodes that are configured in the Cluster 1350.

To display the node configuration information before installing LCIT software, at the console prompt, type:

```
Isnode -l
```

The output provides information about each node, such as the node type, model number, serial number, and host name. The tab file output also provides information that corresponds each node to its terminal server network and service processor network. For the terminal server network, the output includes the console server host name and the console port number to which the node is

connected. For the service processor network, the output includes the host name of the management device to which the node is connected and the internal service processor name for the node.

To display a list of pre-managed nodes on the management server, at the console prompt, type:

Isnode -a Mode

To display a list of managed nodes on the management server, at the console prompt, type:

Isnode

To display the management server, at any node console prompt, type:

mgmtsvr

Related topics

- Chapter 4, “Checking the Cluster 1350 cabling process,” on page 23
- Appendix A, “Error and event logs,” on page 29

Appendix A. Error and event logs

There are multiple log files available to help monitor and troubleshoot the cluster:

Linux log

The Linux OS log can be viewed in `/var/log/messages`

The system logging daemons are `syslogd` and `klogd`. They are configured via `/etc/syslog.conf`.

Log files are automatically rotated by the `logrotate` command. To rotation is configured with the `/etc/logrotate.conf` file.

Node log

PC Doctor 2.0 is a ROM-based Diagnostic resident on the servers made available by selecting F2 on boot up. PC Doctor error logs are in the diagnostic portion of the boot up. Press F2 to run diagnostics, then F3 to view log file.

POST/BIOS errors can be read by pressing F1 key during boot process and then selecting View Error Logs from menu. This gives a POST code and description of the error. For example:

```
301 Keyboard Input Error 164 Memory size has changed
```

Cluster System Management log

Cluster System Management (CSM) log files can be viewed in the `/var/log/csm/installnode.log` file using the `eventlog -n <nodename> all` command.

Remote Supervisor Adapter log

RSA adapter log files can be viewed by using Telnet into the adapter and selecting the *View Log File* from the menu.

American Power Conversion log

You can view the American Power Conversion (APC) event log via Web, FTP or local console I/F:

1. Telnet to the switch.
2. From main menu, you will see CTL-L for Event Log.
3. Events are logged in descending order by date, time and event.

Linux Cluster Installation Tool event log

You can view the Linux Cluster Installation Tool (LCIT) event log through a local or remote console or terminal window:

1. Open a console window on the management node.
2. From the root directory, type: `tail -f /var/log/messages`.

Appendix B. Getting help and technical assistance

If you need help, service, or technical assistance or just want more information about IBM products, you will find a wide variety of sources available from IBM to assist you. This appendix contains information about where to go for additional information about IBM System Cluster 1350 and what to do if you experience a problem with it.

Before you call

Before you call, make sure that you have taken these steps to try to solve the problem yourself:

- Use the troubleshooting information in your system documentation, and use the diagnostic tools that come with your system. Information about diagnostic tools is in the *Hardware Maintenance Manual and Troubleshooting Guide* or *Problem Determination and Service Guide* on the IBM Documentation CD that comes with your system.

Note: For some IntelliStation models, the *Hardware Maintenance Manual and Troubleshooting Guide* is available only from the IBM support Web site.

- Check all cables to make sure that they are connected.
- Check the power switches to make sure that the system is turned on.
- Check for updated technical information, hints, tips, or new device drivers at the Cluster 1350 InfoCenter Web site. Go to <http://publib.boulder.ibm.com/cluster/>.
- Check common answers to questions about IBM clusters. To subscribe to the CSM mailing list, go to <http://www-124.ibm.com/developerworks/oss/mailman/listinfo/csm>. To subscribe to the XCAT mailing list, go to <http://www.xcat.org>.
- If you suspect a software problem, see the information for the operating system or program.
- If you still experience a problem, contact Hardware Service and Support (see below). Be sure to have the following information available when you call.

Machine type: 1410 (or 1417-11LX) Model: 42L (42X or 25X) Serial number:
--

- The label containing the serial number can be found on the purchase order or in the rack cabinet.
 - The 1410 models 42L and 42X rack model and serial number label is located in the rear, on the left rack panel, near the 26-U slot. You can have cabling obstructing the view of the label. Carefully move the cables apart to read the serial number.
 - The 1410 model 25X rack model and serial number label is located in the front, on the bottom-right of the rack unit, near the 1-U slot.
 - The 1417 model 17X rack model and serial number is generally located in the rear, on the bottom-right.
 - The 1417 model 11X rack model and serial number is generally located in the rear, on the bottom-right.

You can solve many problems without outside assistance by following the troubleshooting procedures that IBM provides in the online help or in the documentation that is provided with your IBM product. The documentation that comes with IBM systems also describes the diagnostic tests that you can perform. Most systems, operating systems, and programs come with documentation that contains troubleshooting procedures and explanations of error messages and error codes. If you suspect a software problem, see the documentation for the operating system or program.

Using the documentation

Information about your IBM system and preinstalled software, if any, is available in the documentation that comes with your system. That documentation includes printed books, online books, readme files, and help files. See the troubleshooting information in your system documentation for instructions for using the diagnostic programs. The troubleshooting information or the diagnostic programs might tell you that you need additional or updated device drivers or other software. IBM maintains pages on the World Wide Web where you can get the latest technical information and download device drivers and updates. To access these pages, go to <http://www.ibm.com/systems/support/> and follow the instructions. Also, you can order publications through the IBM Publications Ordering System at <http://www.ibm.com/shop/publications/order/>.

Getting help and information from the World Wide Web

On the World Wide Web, the IBM Web site has up-to-date information about IBM systems, optional devices, services, and support. The address for IBM System x™ and xSeries® information is <http://www.ibm.com/systems/x/>. The address for IBM BladeCenter information is <http://www.ibm.com/systems/bladecenter/>. The address for IBM IntelliStation® information is <http://www.ibm.com/intellistation/>.

You can find service information for IBM systems and optional devices at <http://www.ibm.com/systems/support/>.

Software service and support

Through IBM Support Line, you can get telephone assistance, for a fee, with usage, configuration, and software problems with System x and xSeries servers, BladeCenter products, IntelliStation workstations, and appliances. For information about which products are supported by Support Line in your country or region, see <http://www.ibm.com/services/sl/products/>.

For more information about Support Line and other IBM services, see <http://www.ibm.com/services/>, or see <http://www.ibm.com/planetwide/> for support telephone numbers. In the U.S. and Canada, call 1-800-IBM-SERV (1-800-426-7378).

Hardware service and support

You can receive hardware service through IBM Services or through your IBM reseller, if your reseller is authorized by IBM to provide warranty service. See <http://www.ibm.com/planetwide/> for support telephone numbers, or in the U.S. and Canada, call 1-800-IBM-SERV (1-800-426-7378).

In the U.S. and Canada, hardware service and support is available 24 hours a day, 7 days a week. In the U.K., these services are available Monday through Friday, from 9 a.m. to 6 p.m.

For the 1350 Cluster call process, complete the following steps:

1. After a hardware failure is identified, call 1-800-IBMSERV (1-800-426-7378).
2. Make sure that you use the Cluster machine type 1410 or 1417 when placing the call. The name 1350 is the name of the solution, not the name of the machine type.
3. Make sure that you have your customer number associated with the Support Line contract which is unique to this contract. After the customer number is verified, customer support works with you to determine and solve the problem.

In the U.S. and Canada, hardware service and support is available 24 hours a day, 7 days a week. In the U.K., these services are available Monday through Friday, from 9 a.m. to 6 p.m.

IBM Taiwan product service

台灣 IBM 產品服務聯絡方式：
台灣國際商業機器股份有限公司
台北市松仁路 7 號 3 樓
電話：0800-016-888

IBM Taiwan product service contact information:
IBM Taiwan Corporation
3F, No 7, Song Ren Rd.
Taipei, Taiwan
Telephone: 0800-016-888

Appendix C. Notices

This information was developed for products and services offered in the U.S.A.

IBM may not offer the products, services, or features discussed in this document in other countries. Consult your local IBM representative for information on the products and services currently available in your area. Any reference to an IBM product, program, or service is not intended to state or imply that only that IBM product, program, or service may be used. Any functionally equivalent product, program, or service that does not infringe any IBM intellectual property right may be used instead. However, it is the user's responsibility to evaluate and verify the operation of any non-IBM product, program, or service.

IBM may have patents or pending patent applications covering subject matter described in this document. The furnishing of this document does not give you any license to these patents. You can send license inquiries, in writing, to:

*IBM Director of Licensing
IBM Corporation
North Castle Drive
Armonk, NY 10504-1785
U.S.A.*

INTERNATIONAL BUSINESS MACHINES CORPORATION PROVIDES THIS PUBLICATION "AS IS" WITHOUT WARRANTY OF ANY KIND, EITHER EXPRESS OR IMPLIED, INCLUDING, BUT NOT LIMITED TO, THE IMPLIED WARRANTIES OF NON-INFRINGEMENT, MERCHANTABILITY OR FITNESS FOR A PARTICULAR PURPOSE. Some states do not allow disclaimer of express or implied warranties in certain transactions, therefore, this statement may not apply to you.

This information could include technical inaccuracies or typographical errors. Changes are periodically made to the information herein; these changes will be incorporated in new editions of the publication. IBM may make improvements and/or changes in the product(s) and/or the program(s) described in this publication at any time without notice.

Any references in this information to non-IBM Web sites are provided for convenience only and do not in any manner serve as an endorsement of those Web sites. The materials at those Web sites are not part of the materials for this IBM product, and use of those Web sites is at your own risk.

IBM may use or distribute any of the information you supply in any way it believes appropriate without incurring any obligation to you.

Trademarks

The following terms are trademarks of International Business Machines Corporation in the United States, other countries, or both:

Active Memory

Predictive Failure
Analysis

Active PCI

PS/2

Active PCI-X	ServeRAID
Alert on LAN	ServerGuide
BladeCenter	ServerProven
C2T Interconnect	TechConnect
Chipkill	ThinkPad
EtherJet	Tivoli
e-business logo	Tivoli Enterprise
@server	Update Connector
FlashCopy	Wake on LAN
IBM	XA-32
IBM (logo)	XA-64
IntelliStation	X-Architecture
NetBAY	Xcel4
Netfinity	XpandOnDemand
NetView	xSeries
OS/2 WARP	

Intel, Intel Xeon, Itanium, and Pentium are trademarks or registered trademarks of Intel Corporation or its subsidiaries in the United States and other countries.

Microsoft, Windows, and Windows NT are trademarks of Microsoft Corporation in the United States, other countries, or both.

UNIX is a registered trademark of The Open Group in the United States and other countries.

Java and all Java-based trademarks and logos are trademarks of Sun Microsystems, Inc. in the United States, other countries, or both.

Adaptec and HostRAID are trademarks of Adaptec, Inc., in the United States, other countries, or both.

Linux is a trademark of Linus Torvalds in the United States, other countries, or both.

Red Hat, the Red Hat "Shadow Man" logo, and all Red Hat-based trademarks and logos are trademarks or registered trademarks of Red Hat, Inc., in the United States and other countries.

Other company, product, or service names may be trademarks or service marks of others.

Important notes

Processor speeds indicate the internal clock speed of the microprocessor; other factors also affect application performance.

CD-ROM drive speeds list the variable read rate. Actual speeds vary and are often less than the maximum possible.

When referring to processor storage, real and virtual storage, or channel volume, KB stands for approximately 1000 bytes, MB stands for approximately 1 000 000 bytes, and GB stands for approximately 1 000 000 000 bytes.

When referring to hard disk drive capacity or communications volume, MB stands for 1 000 000 bytes, and GB stands for 1 000 000 000 bytes. Total user-accessible capacity may vary depending on operating environments.

Maximum internal hard disk drive capacities assume the replacement of any standard hard disk drives and population of all hard disk drive bays with the largest currently supported drives available from IBM.

Maximum memory may require replacement of the standard memory with an optional memory module.

IBM makes no representation or warranties regarding non-IBM products and services that are ServerProven[®], including but not limited to the implied warranties of merchantability and fitness for a particular purpose. These products are offered and warranted solely by third parties.

IBM makes no representations or warranties with respect to non-IBM products. Support (if any) for the non-IBM products is provided by the third party, not IBM.

Some software may differ from its retail version (if available), and may not include user manuals or all program functionality.

Product recycling and disposal

This unit contains materials such as circuit boards, cables, electromagnetic compatibility gaskets, and connectors which may contain lead and copper/beryllium alloys that require special handling and disposal at end of life. Before this unit is disposed of, these materials must be removed and recycled or discarded according to applicable regulations. IBM offers product-return programs in several countries. Information on product recycling offerings can be found on IBM's Internet site at <http://www.ibm.com/ibm/environment/products/prp.shtml>.

Battery return program

This product may contain a sealed lead acid, nickel cadmium, nickel metal hydride, lithium, or lithium ion battery. Consult your user manual or service manual for specific battery information. The battery must be recycled or disposed of properly. Recycling facilities may not be available in your area. For information on disposal of batteries outside the United States, go to <http://www.ibm.com/ibm/environment/products/batteryrecycle.shtml> or contact your local waste disposal facility.

In the United States, IBM has established a return process for reuse, recycling, or proper disposal of used IBM sealed lead acid, nickel cadmium, nickel metal hydride, and battery packs from IBM equipment. For information on proper disposal of these batteries, contact IBM at 1-800-426-4333. Have the IBM part number listed on the battery available prior to your call.

For Taiwan, please recycle batteries.



For the European Union, the following applies:

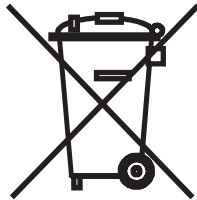

For California:

Perchlorate material – special handling may apply. See <http://www.dtsc.ca.gov/hazardouswaste/perchlorate/>.

The foregoing notice is provided in accordance with California Code of Regulations Title 22, Division 4.5 Chapter 33. Best Management Practices for Perchlorate Materials. This product/part may include a lithium manganese dioxide battery which contains a perchlorate substance.

Electronic emission notices

Federal Communications Commission (FCC) statement

Note: This equipment has been tested and found to comply with the limits for a Class A digital device, pursuant to Part 15 of the FCC Rules. These limits are designed to provide reasonable protection against harmful interference when the equipment is operated in a commercial environment. This equipment generates, uses, and can radiate radio frequency energy and, if not installed and used in accordance with the instruction manual, may cause harmful interference to radio communications. Operation of this equipment in a residential area is likely to cause harmful interference, in which case the user will be required to correct the interference at his own expense.

Properly shielded and grounded cables and connectors must be used in order to meet FCC emission limits. IBM is not responsible for any radio or television interference caused by using other than recommended cables and connectors or by unauthorized changes or modifications to this equipment. Unauthorized changes or modifications could void the user's authority to operate the equipment.

This device complies with Part 15 of the FCC Rules. Operation is subject to the following two conditions: (1) this device may not cause harmful interference, and (2) this device must accept any interference received, including interference that may cause undesired operation.

Industry Canada Class A emission compliance statement

This Class A digital apparatus complies with Canadian ICES-003.

Avis de conformité à la réglementation d'Industrie Canada

Cet appareil numérique de la classe A est conforme à la norme NMB-003 du Canada.

Australia and New Zealand Class A statement

Attention: This is a Class A product. In a domestic environment this product may cause radio interference in which case the user may be required to take adequate measures.

United Kingdom telecommunications safety requirement

Notice to Customers

This apparatus is approved under approval number NS/G/1234/J/100003 for indirect connection to public telecommunication systems in the United Kingdom.

European Union EMC Directive conformance statement

This product is in conformity with the protection requirements of EU Council Directive 89/336/EEC on the approximation of the laws of the Member States relating to electromagnetic compatibility. IBM cannot accept responsibility for any failure to satisfy the protection requirements resulting from a nonrecommended modification of the product, including the fitting of non-IBM option cards.

This product has been tested and found to comply with the limits for Class A Information Technology Equipment according to CISPR 22/European Standard EN 55022. The limits for Class A equipment were derived for commercial and industrial environments to provide reasonable protection against interference with licensed communication equipment.

Attention: This is a Class A product. In a domestic environment this product may cause radio interference in which case the user may be required to take adequate measures.

Taiwanese Class A warning statement

警告使用者：
這是甲類的資訊產品，在
居住的環境中使用時，可
能會造成射頻干擾，在這種
情況下，使用者會被要求
採取某些適當的對策。

Chinese Class A warning statement

声 明

此为 A 级产品。在生活环境中，该产品可能会造成无线电干扰。在这种情况下，可能需要用户对其干扰采取切实可行的措施。

Japanese Voluntary Control Council for Interference (VCCI) statement

この装置は、情報処理装置等電波障害自主規制協議会（VCCI）の基準に基づくクラスA情報技術装置です。この装置を家庭環境で使用すると電波妨害を引き起こすことがあります。この場合には使用者が適切な対策を講ずるよう要求されることがあります。

Appendix D. Declaration of IBM product noise emission values

General noise emission values for the Cluster 1350 are shown in Table 3.

Table 3. General noise emission values for the Cluster 1350

Declaration of IBM product noise emission values				
Product configuration	Declared A-weighted sound power levels L_{WAd} (B)		Declared A-weighted sound pressure level L_{pAm} (db) at 1 meter bystander position	
	Cluster 1350 (fully configured racks)	8.0 (bels) operating	8.0 (bels) idling	62 (db) operating

Note: L_{WAd} is the declared (upper limit) sound power level for a random sample of machines. L_{pAm} is the mean value of the A-weighted sound pressure levels at the bystander (1 - meter) positions for a random sample of machines. All measurements are made in accordance with ISO 7779 and declared in conformance with ISO 9296.

Noise emission values are different for racks that contain BladeCenter units. Each BladeCenter unit has two blowers for cooling. An optional acoustics module is available that dampens the noise generated by the blowers. Table 4 shows the maximum sound levels emitted by BladeCenter units without the acoustics module and with the acoustics module. This represents the minimum and maximum number of BladeCenter units that can be installed in a 42-U rack.

Table 4. Noise emission values for racks containing BladeCenters

	Number of BladeCenter units per rack	Maximum sound power idle	Maximum sound power operating
Without acoustics module	1	7.4 bels	7.4 bels
With acoustics module	1	6.9 bels	6.9 bels
Without acoustics module	4	8 bels	8 bels
With acoustics module	4	7.5 bels	7.5 bels
Without acoustics module	6	8.2 bels	8.2 bels
With acoustics module	6	7.7 bels	7.7 bels

Appendix E. International License Agreement for Non-Warranted Programs

Part 1 - General Terms

PLEASE READ THIS AGREEMENT CAREFULLY BEFORE USING THE PROGRAM. IBM WILL LICENSE THE PROGRAM TO YOU ONLY IF YOU FIRST ACCEPT THE TERMS OF THIS AGREEMENT. BY USING THE PROGRAM YOU AGREE TO THESE TERMS. IF YOU DO NOT AGREE TO THE TERMS OF THIS AGREEMENT, PROMPTLY RETURN THE UNUSED PROGRAM TO THE PARTY (EITHER IBM OR ITS RESELLER) FROM WHOM YOU ACQUIRED IT TO RECEIVE A REFUND OF THE AMOUNT YOU PAID.

The Program is owned by International Business Machines Corporation or one of its subsidiaries (IBM) or an IBM supplier, and is copyrighted and licensed, not sold.

The term "Program" means the original program and all whole or partial copies of it. A Program consists of machine-readable instructions, its components, data, audio-visual content (such as images, text, recordings, or pictures), and related licensed materials.

This Agreement includes **Part 1 - General Terms**, **Part 2 - Country-unique Terms**, and **License Information** and is the complete agreement regarding the use of this Program, and replaces any prior oral or written communications between you and IBM. The terms of **Part 2** and **License Information** may replace or modify those of **Part 1**.

1. License

Use of the Program: IBM grants you a nonexclusive license to use the Program. You may 1) use the Program to the extent of authorizations you have acquired and 2) make and install copies to support the level of use authorized, providing you reproduce the copyright notice and any other legends of ownership on each copy, or partial copy, of the Program. If you acquire this Program as a program upgrade, your authorization to use the Program from which you upgraded is terminated. You will make sure that anyone who uses the Program does so only in compliance with the terms of this Agreement. You may not 1) use, copy, modify, or distribute the Program except as provided in this Agreement; 2) reverse assemble, reverse compile, or otherwise translate the Program except as specifically permitted by law without the possibility of contractual waiver; or 3) sublicense, rent, or lease the Program. **Transfer of Rights and Obligations** You may transfer all your license rights and obligations under a Proof of Entitlement for the Program to another party by transferring the Proof of Entitlement and a copy of this Agreement and all documentation. The transfer of your license rights and obligations terminates your authorization to use the Program under the Proof of Entitlement.

2. Proof of Entitlement

The Proof of Entitlement for this Program is evidence of your authorization to use this Program and of your eligibility for any future upgrade program prices (if announced), and potential special or promotional opportunities.

3. Charges and Taxes

IBM defines use for the Program for charging purposes and specifies it in the Proof of Entitlement. Charges are based on extent of use authorized. If you wish to increase the extent of use, notify IBM or its reseller and pay any applicable charges. IBM does not give refunds or credits for charges already due or paid.

If any authority imposes a duty, tax, levy or fee, excluding those based on IBM's net income, upon the Program supplied by IBM under this Agreement, then you agree to pay that amount as IBM specifies or supply exemption documentation.

4. No Warranty

SUBJECT TO ANY STATUTORY WARRANTIES WHICH CAN NOT BE EXCLUDED, IBM MAKES NO WARRANTIES OR CONDITIONS EITHER EXPRESS OR IMPLIED, INCLUDING WITHOUT LIMITATION, THE WARRANTY OF NON-INFRINGEMENT AND THE IMPLIED WARRANTIES OF MERCHANTABILITY AND FITNESS FOR A PARTICULAR PURPOSE, REGARDING THE PROGRAM OR TECHNICAL SUPPORT, IF ANY. IBM MAKES NO WARRANTY REGARDING THE CAPABILITY OF THE PROGRAM TO CORRECTLY PROCESS, PROVIDE AND/OR RECEIVE DATE DATA WITHIN AND BETWEEN THE 20TH AND 21ST CENTURIES.

The exclusion also applies to any of IBM's subcontractors, suppliers, or program developers (collectively called "Suppliers").

Manufacturers, suppliers, or publishers of non-IBM Programs may provide their own warranties.

5. Limitation of Liability

NEITHER IBM NOR ITS SUPPLIERS WILL BE LIABLE FOR ANY DIRECT OR INDIRECT DAMAGES, INCLUDING WITHOUT LIMITATION, LOST PROFITS, LOST SAVINGS, OR ANY INCIDENTAL, SPECIAL, OR OTHER ECONOMIC CONSEQUENTIAL DAMAGES, EVEN IF IBM IS INFORMED OF THEIR POSSIBILITY. SOME JURISDICTIONS DO NOT ALLOW THE EXCLUSION OR LIMITATION OF INCIDENTAL OR CONSEQUENTIAL DAMAGES, SO THE ABOVE EXCLUSION OR LIMITATION MAY NOT APPLY TO YOU.

6. General

Nothing in this Agreement affects any statutory rights of consumers that cannot be waived or limited by contract.

IBM may terminate your license if you fail to comply with the terms of this Agreement. If IBM does so, your authorization to use the Program is also terminated and you must immediately destroy the Program and all copies you made of it.

You agree to comply with applicable export laws and regulations.

Neither you nor IBM will bring a legal action under this Agreement more than two years after the cause of action arose unless otherwise provided by local law without the possibility of contractual waiver or limitation.

Neither you nor IBM is responsible for failure to fulfill any obligations due to causes beyond its control. The laws of the country in which you acquire the Program govern this Agreement, except 1) in Australia, the laws of the State or Territory in which the transaction is performed govern this Agreement; 2) in Albania, Armenia, Belarus, Bosnia/Herzegovina, Bulgaria, Croatia, Czech Republic, Federal Republic of Yugoslavia, Georgia, Hungary, Kazakhstan, Kirghizia, Former Yugoslav Republic of Macedonia (FYROM), Moldova, Poland, Romania, Russia, Slovak Republic, Slovenia, and Ukraine, the laws of Austria govern this Agreement; 3) in the United Kingdom, all disputes relating to this Agreement will be governed by English Law and will be submitted to the

exclusive jurisdiction of the English courts; 4) in Canada, the laws in the Province of Ontario govern this Agreement; and 5) in the United States and Puerto Rico, and People's Republic of China, the laws of the State of New York govern this Agreement.

Part 2 - Country-unique Terms

AUSTRALIA: No Warranty (Section 4): The following paragraph is added to this Section: Although IBM specifies that there are no warranties, you may have certain rights under the Trade Practices Act 1974 or other legislation and are only limited to the extent permitted by the applicable legislation.

Limitation of Liability (Section 5): The following paragraph is added to this Section: Where IBM is in breach of a condition or warranty implied by the Trade Practices Act 1974, IBM's liability is limited to the repair or replacement of the goods, or the supply of equivalent goods. Where that condition or warranty relates to right to sell, quiet possession or clear title, or the goods are of a kind ordinarily acquired for personal, domestic or household use or consumption, then none of the limitations in this paragraph apply.

GERMANY: No Warranty (Section 4): The following paragraphs are added to this Section: The minimum warranty period for Programs is six months. In case a Program is delivered without Specifications, we will only warrant that the Program information correctly describes the Program and that the Program can be used according to the Program information. You have to check the usability according to the Program information within the "money-back guarantee" period.

Limitation of Liability (Section 5): The following paragraph is added to this Section: The limitations and exclusions specified in the Agreement will not apply to damages caused by IBM with fraud or gross negligence, and for express warranty.

INDIA: General (Section 6): The following replaces the fourth paragraph of this Section: If no suit or other legal action is brought, within two years after the cause of action arose, in respect of any claim that either party may have against the other, the rights of the concerned party in respect of such claim will be forfeited and the other party will stand released from its obligations in respect of such claim.

IRELAND: No Warranty (Section 4): The following paragraph is added to this Section: Except as expressly provided in these terms and conditions, all statutory conditions, including all warranties implied, but without prejudice to the generality of the foregoing, all warranties implied by the Sale of Goods Act 1893 or the Sale of Goods and Supply of Services Act 1980 are hereby excluded.

ITALY: Limitation of Liability (Section 5): This Section is replaced by the following: Unless otherwise provided by mandatory law, IBM is not liable for any damages which might arise.

NEW ZEALAND: No Warranty (Section 4): The following paragraph is added to this Section: Although IBM specifies that there are no warranties, you may have certain rights under the Consumer Guarantees Act 1993 or other legislation which cannot be excluded or limited. The Consumer Guarantees Act 1993 will not apply in respect of any goods or services which IBM provides, if you require the goods or services for the purposes of a business as defined in that Act.

Limitation of Liability (Section 5): The following paragraph is added to this Section: Where Programs are not acquired for the purposes of a business as defined in the Consumer Guarantees Act 1993, the limitations in this Section are subject to the limitations in that Act.

PEOPLE'S REPUBLIC OF CHINA: Charges (Section 3): The following paragraph is added to the Section: All banking charges incurred in the People's Republic of China will be borne by you and those incurred outside the People's Republic of China will be borne by IBM.

UNITED KINGDOM: Limitation of Liability (Section 5): The following paragraph is added to this Section at the end of the first paragraph: The limitation of liability will not apply to any breach of IBM's obligations implied by Section 12 of the Sale of Goods Act 1979 or Section 2 of the Supply of Goods and Services Act 1982.

Index

Numerics

- 1 Gigabit Ethernet cabling 20
- 10 Gigabit Ethernet switch 8
- 10/100/1000 Ethernet switches 8

A

- APC event log, viewing 29

C

- cabinet connections 23
- cabinet placement, service clearances 13
- cables, color-coded Ethernet cables 15
- cabling
 - 10/100/1000 Ethernet switch 20
 - Fibre Channel 21
 - intercabinet 19
 - intracabinet 19
 - KVM switch 21
 - local console manager 21
 - Myrinet high-speed switch 20
 - remote console manager 21
 - replacing defective harness 22
 - Voltaire switch 22
- cabling, types of intercabinet 15
- Class A electronic emission notice 38
- clearances, floor loading 16
- cluster
 - turn the power off 27
 - turn the power on 23
- cluster components
 - 1-U flat-panel console 7
 - 10/100/1000 Ethernet switches 8
 - cluster node 5
 - expansion modules 8
 - Fibre Channel adapters and switches 6
 - high-speed Myrinet switch and line cards 10
 - InfiniBand host channel adapters 8
 - InfiniBand switches and devices 7
 - management node 5
 - Myrinet BladeCenter connectivity 10
 - power distribution unit 10
 - SCSI/RAID storage controller adapter 7
 - storage expansion unit 6
 - storage node 5
 - storage server 6
 - terminal server 9
- cluster management 27
- cluster node
 - cluster components 5
- color-coded Ethernet cables 15
- console, description 7
- CSM event log, viewing 29

D

- description
 - 10 Gigabit Ethernet switch 8

- description (*continued*)
 - cluster nodes 5
 - console 7
 - hard disk drives 6
 - high-speed Myrinet switches and line cards 10
 - KVM switch 7
 - management nodes 5
 - management VLAN 19
 - minimum service clearances 13
 - Myrinet BladeCenter connectivity 10
 - optional secondary cluster VLAN 19
 - primary cluster VLAN 19
 - storage nodes 5
 - storage servers 6
 - terminal server 9
- display the CSM node configuration file 27

E

- electronic emission Class A notice 38
- emission values, product noise 41
- engaging the side stabilizers 16
- error logs 29
- Ethernet cabling, 1 Gigabit 20
- event logs 29
- expansion modules 8
- expansion unit connectors 23

F

- FCC Class A notice 38
- Fibre Channel adapters and switches 6
- Fibre Channel cabling 21
- finding documentation 10
- floor loading clearances 16

G

- grey Ethernet cables 15
- guidelines, placing the cabinets 15

H

- handling static-sensitive devices, directions xiii
- hardware service and support 32
- high-speed 10/100/1000 Ethernet switch, cabling 20
- high-speed Myrinet switch and line cards 10

I

- IBM Rear Door Heat eXchanger 15
- IBM Support Line 32
- InfiniBand host channel adapters 8
- InfiniBand switches and line cards 7
- installation, rack 15
- installer responsibilities, installing the rack 15
- installing
 - primary unit cables 24
 - rack stability kit 16

- installing (*continued*)
 - rear door heat eXchanger 18
 - stabilizer kit 16
- intercabinet cabling 19
- intercabinet cabling types 15, 20
- intracabinet cabling 19

K

- KVM switch cabling 21
- KVM switch, description 7

L

- LCIT event log, viewing 29
- LCIT installation, verifying 25
- lights out or brownout 25
- Linux event log, viewing 29
- local console manager, cabling 21
- locating
 - machine serial number 31
 - model number 31
 - rack serial number 31
 - serial number 31
- logs
 - error 29
 - event 29

M

- machine model number, locating 31
- machine serial number, locating 31
- management node
 - components 5
- management VLAN, description 19
- minimum service clearances 13
- model number, locating 31
- Myrinet BladeCenter connectivity 10
- Myrinet high-speed switch cabling 20

N

- node event log, viewing 29
- notes, important 36
- notices 35
 - electronic emission 38
 - FCC, Class A 38
- notices, used in this book xiv

O

- online documentation, locating 11
- operating system support 1
- optional secondary cluster VLAN, description 19
- overview, system 1

P

- placement of Myrinet CLOS 256 switch 14
- placing the cabinets, guidelines 15
- power distribution unit 10
- primary cabinet connections 24
- primary cabinets, turning the power on 24
- primary cluster VLAN, description 19

- product noise emission values 41

R

- rack serial number, locating 31
- rack stability, engaging the outriggers 16
- rear door heat eXchanger, preparing 18
- related publications, locating 10
- remote access information 27
- remote console manager
 - cabling 21
- replacing a cable harness 22
- RSA event log, viewing 29

S

- SCSI/RAID storage controller adapter 7
- serial number, locating 31
- service clearances, cabinet placement 13
- software service and support 32
- stability kit installation 16
- static-sensitive devices, directions for handling xiii
- storage controller adapter, description 7
- storage expansion unit, cluster components 6
- storage node, cluster components 5
- storage server, cluster components 6
- system overview 1

T

- telephone numbers 32
- terminal server, description 9
- trademarks 35
- turning on the power, expansion cabinets 24
- turning the power on, primary cabinets 24

U

- United States electronic emission Class A notice 38
- United States FCC Class A notice 38

V

- verifying the LCIT installation 25
- viewing
 - APC event log 29
 - CSM event log 29
 - LCIT event log 29
 - Linux event log 29
 - node event log 29
 - RSA event log 29
- Voltaire switch, cabling 22

W

- web site
 - support line, telephone numbers 32



Part Number: 43W7811

Printed in USA

(1P) P/N: 43W7811

