



1394 Open Host Controller Interface Specification

Draft 0.91

Released: Monday, January 27, 1997

Modified: Monday, January 27, 1997

Copyright © 1996,1997 by the Promoters of the 1394 Open HCI.

PREFACE

Intellectual Property

This specification may contain and sometimes even require the use of intellectual property owned by others. Rights to such intellectual property are not conveyed except as provided by the 1394 Open HCI Developers agreement and the 1394 Open HCI Adopters agreement.

Release 0.90 Notice

This specification has reached a level of maturity suitable for device development. The authors of this specification do not believe that it is reasonable to expect that all problems can be discovered before implementations are attempted. Implementors are encouraged to use the 1394 Open HCI reflector (1394ohci-1@austin.ibm.com) to ask questions about portions of the specification that are not perfectly clear; to point out inconsistencies; and to identify and propose fixes to errors.

Workshops will be scheduled as required to review the specification and to correct any deficiencies in function or inadequacies in specification of the 1394 OpenHCI.

Updates to the specification and notices about the specification will be maintained on an ftp site (<ftp://www.austin.ibm.com/pub/chrptech/1394ohci>).

Promoters

The Promoters of record on Wednesday, January 22, 1997 , the date of publication of the 1394 Open Host Controller Interface Specification, Draft 0.91, are:

Apple Computer, Inc.
Compaq Computer Corp.
Intel Corporation
Microsoft Corporation
National Semiconductor Corporation
Sun Microsystems, Inc.
Texas Instruments, Inc.

Contributors

This specification was developed using Apple Computer's *Pele* design as a starting point. The *Pele* contributors were Jim Baldwin, Kevin Christiansen, Nikhil Jayaram, Michael Johas Teener and Rahoul Puri. The original Editor of the 1394 OpenHCI specification up through Draft 0.7, was Michael Johas Teener.

The following is a list of key contributors to the 1394 Open Host Controller Interface specification.

Lee Wilson, *Chair*
Diana Klashman, *Editor*

Eric W. Anderson
Richard Baker
Mike Eneboe
John Fuller
Rahoul Puri
Michael Johas Teener
Peter Teng
Scott Smyers
Erik Staats
David Wooten

The following is a list of other major participants (those who attended at least three meetings and/or conference calls).

Joe Bennett	Carl Humphreys
Larry Blackledge	Robert Macomber
Dmitriy L. Budko	Yehuda Peled
Josh Collier	Gerhard Ringel
Jerry Hauck	Curtis Stevens

PREFACE	iii
Intellectual Property	iii
Release 0.90 Notice	iii
Promoters	iv
Contributors	iv
List of figures	xi
List of tables	xiii
1. Introduction	1
1.1 Related documents	1
1.2 Overview	1
1.2.1 Asynchronous functions	1
1.2.2 Isochronous functions	1
1.2.3 Miscellaneous functions	2
1.3 Hardware description	3
1.3.1 Host bus interface	3
1.3.2 DMA	4
1.3.2.1 Asynchronous transmit DMA	4
1.3.2.2 Asynchronous receive DMA	4
1.3.2.3 Isochronous transmit DMA	5
1.3.2.4 Isochronous receive DMA	5
1.3.2.5 Self-ID receive DMA	5
1.3.3 Global unique ID (GUID) interface	5
1.3.4 FIFOs	5
1.3.4.1 Asynchronous transmit FIFOs	6
1.3.4.2 Isochronous transmit FIFO	6
1.3.4.3 Receive FIFOs	6
1.3.5 Link	6
1.4 IEEE P1394A enhancements required for 1394 Open HCI	7
1.5 Software interface overview	7
1.5.1 Registers	7
1.5.2 DMA operation	7
1.5.3 Interrupts	8
1.6 System Requirements	8
1.7 Alignment	8
1.7.1 Data alignment	8
1.7.2 Memory structure and buffer alignment	8
2. Conventions - Notation and Terms	9
2.1 Notation	9
2.1.1 Numeric Notation	9
2.1.2 Register Notation	9
2.1.2.1 Read/Write registers	9
2.1.2.2 Set and Clear registers	9
2.1.2.3 Register Reset Values	10
2.1.2.4 Reserved fields	10
2.1.2.5 Reserved registers	10
2.1.2.6 Register field notation	10
2.2 Terms	11

3. DMA overview.....	13
3.1 Context Registers.....	13
3.1.1 ContextControl.run	15
3.1.2 ContextControl.wake	16
3.1.3 ContextControl.active	16
3.1.4 ContextControl.dead	17
3.1.4.1 Bad Z Value.....	17
3.1.5 CommandPtr	17
3.2 List Management	18
3.2.1 Software Behavior	18
3.2.1.1 Context Initialization.....	18
3.2.1.2 Appending to Running List	18
3.2.1.3 Stopping a Context.....	18
3.2.2 Hardware Behavior	18
3.3 Asynchronous Receive	20
3.4 DMA Summary	22
4. Register addressing	23
4.1 DMA Context Number Assignments	23
4.2 Register Map	24
5. 1394 Open HCI Registers	27
5.1 Register Conventions	27
5.2 Version Register	27
5.3 GUID ROM register (optional).....	28
5.4 ATRetries Register.....	28
5.5 Autonomous CSR Resources	29
5.5.1 Bus Management CSR Registers	29
5.5.2 Config ROM header	31
5.5.3 Bus identification register	31
5.5.4 Bus options register	32
5.5.5 Global Unique ID	32
5.5.6 Configuration ROM mapping register.....	33
5.6 Vendor ID register	34
5.7 HCControl registers (set and clear)	34
5.8 LinkControl registers (set and clear)	36
5.9 Node identification and status register.....	37
5.10 PHY control register.....	37
5.11 Isochronous Cycle Timer Register.....	38
5.12 Asynchronous Request Filters	39
5.12.1 AsynchronousRequestFilter Registers (set and clear).....	39
5.12.2 PhysicalRequestFilter Registers (set and clear)	41
6. Interrupts.....	43
6.1 Overview	43
6.2 Interrupt Registers	43
6.2.1 IntEvent (set and clear)	43
6.2.1.1 busReset	45
6.2.2 IntMask (set and clear)	45
6.2.3 IsochTx interrupt registers	47

6.2.3.1 isoXmitIntEvent (set and clear)	47
6.2.3.2 isoXmitIntMask (set and clear).....	47
6.2.4 IsochRx interrupt registers	48
6.2.4.1 isoRecvIntEvent (set and clear)	48
6.2.4.2 isoRecvIntMask (set and clear).....	48
7. Asynchronous Transmit DMA.....	49
7.1 Asynchronous transmit DMA context programs	49
7.1.1 OUTPUT_MORE descriptor	50
7.1.2 OUTPUT_MORE_Immediate descriptor	51
7.1.3 OUTPUT_LAST descriptor	52
7.1.4 OUTPUT_LAST_Immediate descriptor.....	53
7.1.5 AT command descriptor usage	54
7.1.5.1 Command.Z	54
7.1.5.2 Command.xferStatus	54
7.1.5.3 Command.timeStamp	55
7.1.5.3.1 timeStamp value for Requests.....	55
7.1.5.3.2 timeStamp value for Responses	55
7.2 AT DMA context registers	57
7.2.1 CommandPtr	57
7.2.2 ContextControl register (set and clear).....	58
7.2.2.1 Bus Reset.....	58
7.2.2.2 Writing status back to context command descriptors.....	59
7.3 AT Retries	59
7.4 AT Interrupts	59
7.5 AT Data Formats	59
7.5.1 Asynchronous Transmit Requests	60
7.5.1.1 No-data transmit	60
7.5.1.2 Quadlet Transmit	61
7.5.1.3 Block transmit	62
7.5.1.4 PHY packet transmit.....	64
7.5.2 Asynchronous Transmit Responses	64
7.5.2.1 No-data transmit	64
7.5.2.2 Quadlet Transmit	65
7.5.2.3 Block transmit	66
8. Asynchronous Receive DMA	69
8.1 AR Context Programs	69
8.1.1 INPUT_MORE descriptor.....	69
8.1.2 Using AR command descriptors.....	70
8.2 bufferFill mode	70
8.3 Asynchronous Receive Context Registers.....	71
8.3.1 AR DMA CommandPtr register	71
8.3.2 AR ContextControl register (set and clear)	72
8.4 AR DMA Controller	72
8.4.1 Asynchronous Filter Registers	72
8.4.2 AR DMA Controller processing.....	73
8.4.2.1 AR DMA Packet Trailer	74
8.4.2.2 Error Handling.....	74
8.4.2.3 Bus Reset Packet	74
8.5 Asynchronous Receive Interrupts	75
8.6 Asynchronous Receive Data Formats.....	75

8.6.1 No-data receive	76
8.6.2 Quadlet Receive	77
8.6.3 Block receive	79
8.6.4 PHY packet receive.....	82
9. Isochronous Transmit DMA.....	83
9.1 IT DMA Context Programs	83
9.1.1 IT DMA command descriptor overview	83
9.1.2 OUTPUT_MORE descriptor	84
9.1.3 OUTPUT_MORE-Immediate descriptor	85
9.1.4 OUTPUT_LAST descriptor	86
9.1.5 OUTPUT_LAST-Immediate descriptor	87
9.1.6 STORE_VALUE descriptor	88
9.1.7 IT DMA descriptor usage	88
9.2 IT Context Registers.....	89
9.2.1 CommandPtr	89
9.2.2 IT ContextControl Register.....	90
9.3 Isochronous transmit DMA controller	91
9.3.1 IT DMA Processing	92
9.3.2 Isochronous transmit cycle loss	93
9.3.3 Determining the number of implemented IT DMA contexts.....	94
9.4 IT Interrupts	95
9.5 IT Data Format	95
10. Isochronous Receive DMA	97
10.1 Context Programs	97
10.2 Receive Modes	98
10.2.1 Buffer Fill Mode	99
10.2.2 Packet-per-Buffer Mode.....	100
10.2.2.1 Command.xferStatus and Command.resCount updates	101
10.3 IR Context Registers.....	101
10.3.1 CommandPtr	101
10.3.2 IRContextControl register (set and clear)	102
10.3.3 Isochronous receive contextMatch register	103
10.4 Isochronous receive DMA controller.....	104
10.4.1 Isochronous receive multi-channel support.....	104
10.4.1.1 IRMultiChanMask registers (set and clear)	104
10.4.2 Isochronous receive single-channel support.....	105
10.4.3 Duplicate channels.....	106
10.4.4 Determining the number of implemented IR DMA contexts	106
10.5 IR Interrupts	106
10.6 IR Data Formats	106
10.6.1 bufferFill mode formats	107
10.6.1.1 IR with header/trailer	107
10.6.1.2 IR without header/trailer	108
10.6.2 packet-per-buffer mode formats	108
10.6.2.1 IR with header/trailer	108
10.6.3 IR without header/trailer.....	109
11. Self ID Receive	111
11.1 Self ID Buffer Pointer Register	111

11.2 Self ID Count Register	111
11.3 Self-ID receive	113
11.4 Enabling the SelfID DMA	113
11.5 Interrupt Considerations for SelfID DMA	113
11.6 SelfIDs Received Outside of Bus Initialization.....	113
 12. Physical Requests	 115
12.1 Filtering Physical Requests	115
12.2 Write Requests: ack_codes and host bus errors.....	115
12.3 PostedWriteAddress registers	116
12.3.1 Queue Rules	118
12.4 Interrupt Considerations for Physical Requests	118
12.5 Physical Responses	119
12.6 Response to Bus Reset	119
 13. Host Bus Errors	 121
13.1 Causes of Host Bus Errors	121
13.2 Host Controller Actions When Host Bus Error Occurs	121
13.2.1 Descriptor Read Error	121
13.2.2 xferStatus Write Error	121
13.2.3 Transmit Data Read Error.....	121
13.2.4 Isochronous Transmit Data Write Error	122
13.2.5 Asynchronous Receive Data Write Error.....	122
13.2.6 Isochronous Receive Data Write Error	122
13.2.7 Physical Read Error.....	122
13.2.8 Write Request Error	122
 Annex A. P1394A enhancements required for 1394 Open HCI	 123
 Annex B. PCI Interface	 125
B.1 PCI Configuration Space	125
B.2 Busmastering Requirements.....	125
B.3 PCI Configuration Space for 1394 OpenHCI With PCI Interface.....	125
B.3.1 COMMAND Register	126
B.3.2 CLASS_CODE Register	127
B.3.3 Revision_ID Register.....	127
B.3.4 Base_Adr_0 Register	127
B.4 PCI_HCI_Control Register.....	128
B.5 PCI Expansion ROM for 1394 OpenHCI	128
B.6 PCI Bus Errors	128

List of figures

Figure 1-1 — 1394 Open HCI conceptual block diagram	3
Figure 3-1 — ContextControl (set and clear) register format	13
Figure 3-2 — CommandPtr register format	15
Figure 3-3 — Flow Chart for processing a descriptor	19
Figure 5-1 — Version register	27
Figure 5-2 — GUID ROM register	28
Figure 5-3 — ATRetries register	28
Figure 5-4 — CSR data register	30
Figure 5-5 — CSR compare register	30
Figure 5-6 — CSR control register	30
Figure 5-7 — Config ROM header register	31
Figure 5-8 — Bus ID register	31
Figure 5-9 — Bus options register	32
Figure 5-10 — GlobalUniqueIDHi register	32
Figure 5-11 — GlobalUniqueIDLo register	33
Figure 5-12 — Configuration ROM mapping register	33
Figure 5-13 — VendorID register	34
Figure 5-14 — HCControl register	35
Figure 5-15 — LinkControl register	36
Figure 5-16 — Node ID register	37
Figure 5-17 — PHY control register	38
Figure 5-18 — Isochronous cycle timer register	39
Figure 5-19 — AsynchronousRequestFilterHi (set and clear) register	40
Figure 5-20 — AsynchronousRequestFilterLo (set and clear) register	40
Figure 5-21 — PhysicalRequestFilterHi (set and clear) register	41
Figure 5-22 — PhysicalRequestFilterLo (set and clear) register	41
Figure 6-1 — IntEvent register	44
Figure 6-2 — IntMask register	46
Figure 6-3 — isoXmitIntEvent (set and clear) register	47
Figure 6-4 — isoRecvIntEvent (set and clear) register	48
Figure 7-1 — OUTPUT_MORE descriptor format	50
Figure 7-2 — OUTPUT_MORE-Immediate descriptor format	51
Figure 7-3 — OUTPUT_LAST descriptor format	52
Figure 7-4 — OUTPUT_LAST-Immediate descriptor format	53
Figure 7-5 — timeStamp format	55
Figure 7-6 — CommandPtr register format	57
Figure 7-7 — ContextControl (set and clear) register format	58
Figure 7-8 — Quadlet read request transmit format	60
Figure 7-9 — Quadlet write request transmit format	61
Figure 7-10 — Block read request transmit format	61
Figure 7-11 — Write request transmit format	62
Figure 7-12 — Lock request transmit format	63
Figure 7-13 — PHY packet transmit format	64
Figure 7-14 — Write response transmit format	64
Figure 7-15 — Quadlet read response transmit format	65
Figure 7-16 — Block read response transmit format	66
Figure 7-17 — Lock response transmit format	67
Figure 8-1 — Asynchronous receive descriptor	69
Figure 8-2 — bufferFill receive mode	71
Figure 8-3 — CommandPtr register format	71
Figure 8-4 — AR ContextControl (set and clear) register format	72
Figure 8-5 — AR DMA packet trailer format	74

Figure 8-6 — AR Request Context Bus Reset packet format 74

Figure 8-7 — Quadlet read request receive format 76

Figure 8-8 — Write response receive format 77

Figure 8-9 — Quadlet write request receive format 77

Figure 8-10 — Quadlet read response receive format 78

Figure 8-11 — Block read request receive format 78

Figure 8-12 — Block write request receive format 79

Figure 8-13 — Lock request receive format 80

Figure 8-14 — Block read response receive format 80

Figure 8-15 — Lock response receive format 81

Figure 8-16 — PHY packet receive format 82

Figure 9-1 — OUTPUT_MORE command descriptor format 84

Figure 9-2 — OUTPUT_MORE-Immediate descriptor format 85

Figure 9-3 — OUTPUT_LAST command descriptor format 86

Figure 9-4 — OUTPUT_LAST-Immediate command descriptor format 87

Figure 9-5 — STORE_VALUE descriptor 88

Figure 9-6 — CommandPtr register format 90

Figure 9-7 — IT DMA ContextControl (set and clear) register format 90

Figure 9-8 — ITDMA summary 92

Figure 9-9 — Isochronous transmit cycle loss example 94

Figure 9-10 — Isochronous transmit format with header/cycleNumber 95

Figure 10-1 — Isochronous receive descriptor 97

Figure 10-2 — IR Buffer Fill Mode 99

Figure 10-3 — packet-per-buffer receive mode 100

Figure 10-4 — CommandPtr register format 101

Figure 10-5 — IR DMA ContextControl (set and clear) register format 102

Figure 10-6 — IR DMA ContextMatch (set and clear) register format 103

Figure 10-7 — IRMultiChanMaskHi (set and clear) register 105

Figure 10-8 — IRMultiChanMaskLo (set and clear) register 105

Figure 10-9 — Receive isochronous format in bufferFill mode with header/trailer 107

Figure 10-10 — Receive isochronous format in bufferFill mode without header/trailer 108

Figure 10-11 — Receive isochronous format in packet-per-buffer mode with header/trailer 108

Figure 10-12 — Receive isochronous format in packet-per-buffer mode without header/trailer 109

Figure 11-1 — Self ID Buffer Pointer register 111

Figure 11-2 — Self ID Count register 111

Figure 11-3 — Self-ID receive format 113

Figure 12-1 — PostedWriteAddressHi register 116

Figure 12-2 — PostedWriteAddressLo register 117

Figure 12-3 — Posted Write Error Queue 118

Figure B-1 — PCI Configuration Space 125

Figure B-2 — Pointers to OHCI Resources in PCI Configuration Space 126

List of tables

Table 1-1 — DMA controllers and contexts	4
Table 1-2 — Link generated acknowledges	7
Table 2-1 — read/write register field access tags	9
Table 2-2 — Set and Clear register field access tags	10
Table 2-3 — Register field reset values	10
Table 3-1 — ContextControl (set and clear) register description	13
Table 3-2 — Packet event codes	14
Table 3-3 — CommandPtr register description	15
Table 3-4 — CommandPtr read values	17
Table 3-5 — DMA Summary	22
Table 4-1 — 1394 Open HCI register space map	23
Table 4-2 — Asynchronous DMA Context number assignments	23
Table 4-3 — Register addresses	24
Table 5-1 — Version register	27
Table 5-2 — GUID ROM register	28
Table 5-3 — ATRetries register	29
Table 5-4 — Serial Bus Registers	29
Table 5-5 — CSR registers	30
Table 5-6 — Config ROM header register fields	31
Table 5-7 — Bus ID register fields	31
Table 5-8 — Bus options register fields	32
Table 5-9 — Configuration ROM mapping register	34
Table 5-10 — VendorID register	34
Table 5-11 — HCControl register	35
Table 5-12 — LinkControl register	36
Table 5-13 — Node ID register	37
Table 5-14 — PHY control register	38
Table 5-15 — Isochronous cycle timer register	39
Table 6-1 — IntEvent register description	44
Table 6-2 — IntMask register description	46
Table 7-1 — OUTPUT_MORE descriptor element summary	50
Table 7-2 — OUTPUT_MORE-Immediate descriptor element summary	51
Table 7-3 — OUTPUT_LAST descriptor element summary	52
Table 7-4 — OUTPUT_LAST-Immediate descriptor element summary	53
Table 7-5 — Z value encoding	54
Table 7-6 — timeStamp description	55
Table 7-7 — Results of timeStamp.cycleSeconds - cycleTimer.cycleSeconds	56
Table 7-8 — timeStamp.cycleCount-cycleTime.cycleCount Example 1	56
Table 7-9 — timeStamp.cycleCount-cycleTime.cycleCount Example 2	56
Table 7-10 — timeStamp.cycleCount-cycleTime.cycleCount Example 3	56
Table 7-11 — ContextControl (set and clear) register description	58
Table 7-12 — Quadlet read request transmit fields	60
Table 7-13 — Quadlet transmit fields	61
Table 7-14 — Block transmit fields	63
Table 7-15 — Write response transmit fields	65
Table 7-16 — Quadlet transmit fields	66
Table 7-17 — Block transmit fields	67
Table 8-1 — Asynchronous receive descriptor element summary	69
Table 8-2 — AR ContextControl (set and clear) register description	72
Table 8-3 — AR DMA trailer fields	74
Table 8-4 — AR Request Context Bus Reset packet description	75
Table 8-5 — Asynch receive fields	75

Table 9-1 — OUTPUT_MORE descriptor element summary	84
Table 9-2 — OUTPUT_MORE-Immediate descriptor element summary	85
Table 9-3 — OUTPUT_LAST descriptor element summary	86
Table 9-4 — OUTPUT_LAST-Immediate descriptor element summary	87
Table 9-5 — STORE_VALUE descriptor element summary	88
Table 9-6 — Z value encoding	88
Table 9-7 — IT DMA ContextControl (set and clear) register description	90
Table 9-8 — Isochronous transmit fields	95
Table 10-1 — Descriptor element summary	97
Table 10-2 — Z value encoding	98
Table 10-3 — IR DMA ContextControl (set and clear) register description	102
Table 10-4 — IR DMA ContextMatch (set and clear) register description	104
Table 10-5 — Isochronous receive fields	106
Table 11-1 — Self ID Buffer Pointer register	111
Table 11-2 — Self ID Count register	112
Table 11-3 — Self-ID receive fields	113
Table B-1 — COMMAND Register	126
Table B-2 — CLASS_CODE Register	127
Table B-3 — Base_Adr_0 Register	127
Table B-4 — PCI_HCI_Control Register	128

1. Introduction

1.1 Related documents

The following documents may be useful in understanding the terms and concepts used in this specification. The documents are for general background purposes only and are not incorporated into and do not form a part of this specification.

- [A] IEEE 1394-1995 High Performance Serial Bus
IEEE, 1995
- [B] ISO/IEC 13213:1994 Control and Status Register Architecture for Microcomputer Busses
International Standards Organization, 1994

All references in this document to 1394 refer to IEEE 1394-1995 ([A] above) unless otherwise specified. Following IEEE conventions, the term “quadlet” is used throughout this document to specify a 32-bit word.

1.2 Overview

The 1394 Open Host Controller Interface (**Open HCI**) is an implementation of the link layer protocol of the 1394 Serial Bus, with additional features to support the transaction and bus management layers. The 1394 Open HCI also includes DMA engines for high-performance data transfer and a host bus interface.

IEEE 1394 (and the 1394 Open HCI) supports two types of data transfer: asynchronous and isochronous. Asynchronous data transfer puts the emphasis on guaranteed delivery of data, with less emphasis on guaranteed timing. Isochronous data transfer is the opposite, with the emphasis on the guaranteed timing of the data, and less emphasis on delivery.

1.2.1 Asynchronous functions

The 1394 Open HCI can transmit and receive all of the defined 1394 packet formats. Packets to be transmitted are read out of host memory and received packets are written into host memory, both using DMA. The 1394 Open HCI can also be programmed to act as a bus bridge between host bus and 1394 by directly executing 1394 read and write requests to the first 4 GB of node offset addresses as reads and writes to host bus memory space.

1.2.2 Isochronous functions

The 1394 Open HCI is capable of performing the cycle master function as defined by 1394. This means it contains a cycle timer and counter, and can queue the transmission of a special packet called a “cycle start” after every rising edge of the 8 kHz cycle clock. The 1394 Open HCI can either generate the cycle clock internally or use an external reference. When not the cycle master, the 1394 Open HCI keeps its internal cycle timer synchronized with the cycle master node by correcting its own cycle timer with the reload value from the cycle start packet.

The 1394 Open HCI supports one DMA controller *each* for isochronous transmit and isochronous receive, for a total of two isochronous DMA controllers. Each DMA controller can be implemented to support up to 32 different contexts.

The isochronous transmit DMA controller can transmit from each context during each cycle. Each context can transmit data for a single isochronous channel.

The isochronous receive DMA controller can receive data for each context during each cycle. Each context can be configured to receive data from a single isochronous channel. Additionally, one context can be configured to receive data from multiple isochronous channels.

1.2.3 Miscellaneous functions

Upon detecting a bus reset, the 1394 Open HCI automatically flushes all packets queued for asynchronous transmission. Asynchronous packet reception continues without interruption, and a token appears in the received request packet stream to indicate the occurrence of the bus reset. When the PHY provides the new local node ID, the 1394 Open HCI loads this value into its Node ID register. Asynchronous packet transmit will not resume until directed to by software. Because target node ID values may have changed during the bus reset, software will not generally be able to re-issue old asynchronous requests until software has determined the new target node IDs.

Isochronous transmit and receive functions are not halted by a bus reset, instead they restart as soon as the bus initialization process is complete.

A number of management functions are also implemented by the 1394 Open HCI:

- a) A global unique ID register of 64 bits which can only be written once. For full compliance with higher level standards, this register must be written before the boot block is read. To make this implementation simpler, the 1394 Open HCI optionally has an interface to an external hardware global unique ID (GUID, also known as the IEEE EUI-64). An example device is the Dallas Semiconductor DS2501-EUI-64.
- b) Four registers that implement the compare-swap operation needed for isochronous resource management.

1.3 Hardware description

Figure 1-1 provides a conceptual block diagram of the 1394 Open HCI, and its connections in the host system. The 1394 Open HCI attaches to the host via the host bus. The host bus is assumed to be at least 32 bits wide with adequate performance to support the data rate of the particular implementation (100Mbit/sec or higher plus overhead for DMA structures) as well as bounded latency so that the FIFOs can have a reasonable size.

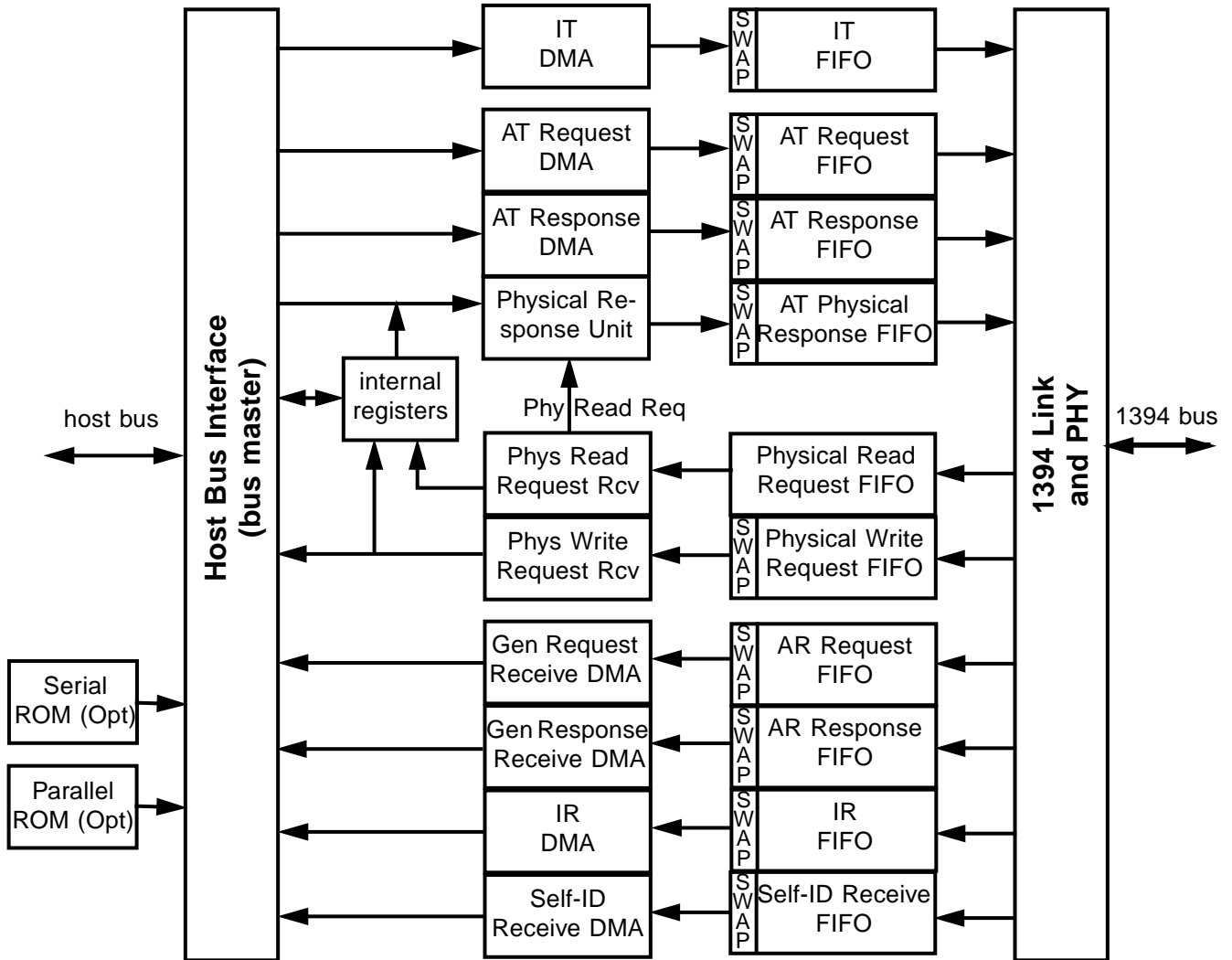

Figure 1-1 — 1394 Open HCI conceptual block diagram

1.3.1 Host bus interface

This block acts both as a master and a slave on the host bus. As a slave, it decodes and responds to register access within the 1394 Open HCI. As a master, it acts on behalf of the 1394 Open HCI DMA units to generate transactions on the host bus. These transactions are used to move streams of data between system memory and the devices, as well as to read and write the DMA command lists.

1.3.2 DMA

The 1394 Open HCI supports six independent programmable *DMA controllers*. Each DMA controller has reserved register space and can support at least one distinct logical data stream referred to as a *DMA context*.

Table 1-1 — DMA controllers and contexts

DMA controller	number of contexts
Asynchronous Transmit Request	1
Asynchronous Transmit Response	1
Asynchronous Receive	2
Isochronous Transmit	4 minimum, 32 maximum
Isochronous Receive	4 minimum, 32 maximum
Self-ID Receive	1
Physical Receive	1
Physical Response	1

Each asynchronous and isochronous context is comprised of a buffer descriptor list called a *DMA context program*, stored in main memory. Buffers are specified within the DMA context program by *DMA descriptors*. Although there are some differences from controller to controller as to how the DMA descriptors are used, all DMA descriptors use the same basic format. The DMA controller sequences through its DMA context program(s) to find the necessary data buffers. This frees the system from stringent interrupt response requirements after buffer completions. The mechanism for sequencing through DMA contexts differs somewhat from one controller to the next and is described in detail for each controller in their respective chapters.

The Self-ID receive controller does not utilize a DMA context program and consists instead of a pair of registers; one to be configured by software, and one to be maintained by hardware.

The 1394 Open HCI also has physical request DMA controller that processes incoming requests that read directly from host memory. This controller does not have a DMA context, it is instead controlled by dedicated registers.

1.3.2.1 Asynchronous transmit DMA

Asynchronous transmit DMA (ATDMA) consists of 3 DMA controllers: AT DMA request, AT DMA response, and the Physical Response Unit. These three functions can share resources.

The AT DMA request controller and AT DMA response controller move transmit packets from buffers in memory to the corresponding FIFO (request transmit FIFO - RQTF, or response transmit FIFO - RSTF). For each packet sent, it waits for the acknowledge to be returned. If the acknowledge is busy, the DMA context will resend the packet up to a software-configurable number of times.

When the receive DMA indicates that a physical read has been received, the Physical Response Unit takes over to send the response packet. The Physical Response Unit can only interrupt the AT DMA response controller or AT DMA request controller between packets.

The asynchronous transmit DMA only supports the single phase retry protocol (retry-X).

1.3.2.2 Asynchronous receive DMA

The asynchronous receive DMA (AR DMA), contains 2 DMA controllers: the Physical Request Unit and the AR DMA controller.

The Physical Request Unit takes control when a request with a physical address is received. There are three types of physical addresses: host memory addresses (corresponding to the 4Gbyte address of a typical 32-bit CPU), compare-swap management addresses, and the bus_info_block. A “complete” acknowledge is sent to all accepted write requests handled by the Physical Request Unit so no response packets are necessary.

The AR DMA controller handles all incoming asynchronous packets not handled by one of the other functions in the AR DMA. It consists of two contexts, one for asynchronous response packets, and one for asynchronous request packets. Each packet is copied into the buffers described by the corresponding DMA program. Note that received lock requests not targeted to one of the four compare-swap management registers are always handled by the AR DMA request context.

1.3.2.3 Isochronous transmit DMA

The isochronous transmit DMA controller supports a minimum of four isochronous transmit DMA contexts and can be implemented to support up to 32 isochronous transmit DMA contexts. Each context is used to transmit data for a single isochronous channel. Data can be transmitted from each IT DMA context during each isochronous cycle.

1.3.2.4 Isochronous receive DMA

The isochronous receive DMA controller supports a minimum of four isochronous receive DMA contexts and can be implemented to support up to 32 isochronous receive DMA contexts. All but one IR DMA context is used to receive packets from a single isochronous stream (channel). One context, as selected by software, can be used to receive packets from multiple isochronous streams (channels).

Isochronous packets in the receive FIFO are processed by the context configured to receive their respective isochronous channel numbers. Each DMA context can be configured to strip packet headers or include the headers and trailers when moving the packets into the buffers. In addition, each DMA context can be configured to concatenate multiple packets into its buffers (bufferFill mode) or to place just a single packet into each buffer (packet-per-buffer mode).

1.3.2.5 Self-ID receive DMA

Self-ID packets (received during the bus initialization self-ID phase) are automatically routed to a single designated host memory buffer by 1394 Open HCI self-ID receive DMA. Each time bus initialization occurs, the new self-ID packets will be written into the self-ID buffer from the beginning of the buffer, thereby overwriting the old self-ID packets.

1.3.3 Global unique ID (GUID) interface

The optional GUID (EUI-64) interface is intended to interface to an external ROM device from which the 1394 64-bit "node_unique_ID" may be loaded. If this interface is provided and an external device is present, the serialROM bit in the Version Register is set and the GUID will be automatically loaded from the external ROM device following a hardware reset. This interface is required for Host Controllers that are intended to be used on add-in cards. The specifics of the interface to the external ROM device are outside the scope of this specification.

1.3.4 FIFOs

Data entering or leaving the FIFOs is conditionally byte-swapped. The 1394 Open HCI is designed to run in both little-endian environments (x86/PCI) and byte-swapped big-endian environments (PowerMac/PCI). Note, however, that the 1394 standard specifies that data is treated as big-endian, with the most significant byte of a doublet, quadlet, or octlet transmitted first. This means that the data coming through the FIFOs should be byte swapped if it is intended for a byte-swapped little-endian PCI like the PowerMac (two byte-swap operations leaves the data in the original big-endian 1394 format). Little-endian x86 systems may or may not want the data byte swapped, so there are two flags that individually enable byte swapping for header and data portions of the 1394 packets.

1.3.4.1 Asynchronous transmit FIFOs

The asynchronous transmit FIFOs are temporary storage for non-isochronous packets that will be sent from the Host Controller to devices on 1394. The asynchronous request FIFO is loaded by the asynchronous request DMA unit, the asynchronous response FIFO is loaded by the asynchronous response DMA unit and the physical response FIFO is loaded by the physical DMA response unit.

It is not required that these FIFOs be implemented as separate physical entities. A single FIFO can be used for all asynchronous transmit packets as long as the implementation prevents pending asynchronous requests from blocking asynchronous responses. For example, if a read request is being sent to a 1394 device that is returning `ack_busy`, this should not prevent responses from either the physical DMA unit or the asynchronous response unit from being sent. Furthermore, a busied response from the asynchronous response unit should not block responses from the physical DMA unit. Other sections of this specification will provide implementation guidelines that will help ensure that the non-blocking requirements can be met with a single asynchronous transmit FIFO.

1.3.4.2 Isochronous transmit FIFO

The isochronous transmit FIFO (ITF), is temporary storage for the isochronous transmit data. The ITF is filled by the ITDMA and is emptied by the transmitter.

1.3.4.3 Receive FIFOs

Conceptually there are several receive FIFOs for handling incoming asynchronous requests, asynchronous responses, isochronous packets and self-ID packets. The FIFOs are used as a staging area for packets which will be routed to the appropriate handler. There is no requirement on the number of hardware FIFOs that must be implemented to provide the required functionality set forth in this document.

1.3.5 Link

The link module sends packets which appear at the transmit FIFO interfaces, and places correctly addressed packets into the receive FIFO. It includes the following features:

- Transmits and receives correctly formatted 1394 serial bus packets
- Generates the appropriate acknowledge for all received asynch packets, including support for both the single and dual phase retry protocol for received packets.
- Performs function of cycle master
- Generates and checks 32-bit CRC
- Detects missing cycle start packets.
- Interfaces to Open-HCI-compliant PHY (see section 1.4)
- Receives isoch packets at all times (does not ignore isoch packets received outside of the expected period between cycle start and a subaction gap). This allows isoch data to be received even if there is a CRC error in a received cycle start.

The acknowledges generated by the link depend on the type of received packet, the address, and the state of the OpenHCI FIFOs:

Table 1-2 — Link generated acknowledges

Acknowledge	Condition
ack_complete	<ul style="list-style-type: none"> a) Any response with good CRC in both the header and data block (if there is one) that can be fully loaded into the receive buffer. b) A write request with the offset address between 48'h0 and 48'hFFFE_FFFF_FFFF that can be fully loaded into the receive buffer.
ack_pending	<ul style="list-style-type: none"> a) Any read request with good CRC in the header that can be fully loaded into the receive buffer. b) Any lock request with good CRC in both the header and data block that can be fully loaded into the receive buffer. c) A write request with the offset address between 48'hFFFF_0000_0000 and 48'hFFFF_FFFF_FFFF (the top 4GB, which includes the register space) that can be fully loaded into the receive buffer.
ack_busy_X, ack_busy_A, ack_busy_B	Any received packet with a good CRC in both the header and data block (if there is one) that cannot be fully loaded into the receive buffer. (The choice of _X, _A, or _B depends on the choice of acknowledge algorithm and the particular "rt" value of the received packet.)
ack_data_error	Any received packet with a good header CRC and a bad data CRC.
ack_type_error	May be returned when the data_length for a block write request is larger than the size indicated in the max_rec field of the Bus_Info_Block of the Host Controller. Always returned if data_length is larger than max_rec <i>and</i> the request is not handled by the physical response unit.

1.4 IEEE P1394A enhancements required for 1394 Open HCI

The 1394 Open HCI requires certain features proposed for the IEEE P1394A update. There are features proposed for the PHY layer, link layer and for the bus manager. See Annex A., "P1394A enhancements required for 1394 Open HCI," for the complete list.

1.5 Software interface overview

There are three basic means by which software communicates with the 1394 Open HCI - registers, DMA, and interrupts.

1.5.1 Registers

The host architecture (PCI, for example) is responsible for mapping the 1394 Open HCI's registers into a portion of the processor's address space.

1.5.2 DMA operation

DMA transfers in the 1394 Open HCI are accomplished through one of two methods:

- a) DMA. Memory resident data structures are used to describe lists of data buffers. The 1394 Open HCI automatically sequences through this buffer descriptor list. This data structure also contains status information regarding the transfers. Upon completion of each data transfer, the DMA controller conditionally updates the corresponding DMA Context Command and conditionally interrupts the processor so it can observe the status of the transaction. A set of registers within the 1394 Open HCI is used to initialize each DMA context, and to perform control actions such as starting the transfer.

- b) Physical response DMA. The 1394 Open HCI can be programmed to accept 1394 read and write transactions to the first 4 GB of node-offset address and treat them as reads and writes to the 32-bit memory space. In this mode, the 1394 Open HCI acts as a bus bridge from 1394 into host memory.

The formats for the data sent and received in all these modes are specified in the applicable chapters.

1.5.3 Interrupts

When any DMA transfer completes (or aborts) an interrupt may be sent to the host system. In addition to the interrupt sources which correspond to each DMA context completion, there is also a set of interrupts which correspond to other 1394 Open HCI functions/units. For example, one of these interrupts could be sent when a selfID packet stream has been received.

The processor interrupt line is controlled by the IntEvent and IntMask registers. The IntEvent register indicates which interrupt events have occurred, and the IntMask register is used to enable selected interrupts. Software writes to the IntEventClear register to clear interrupt conditions in IntEvent.

In addition, there are registers used by the isochronous transmit and isochronous receive controllers to indicate interrupt conditions for each context.

1.6 System Requirements

This Host Controller specification is intended to be largely independent of the type of system to which it is attached. The intent is that Host Controller designs that follow this specification may be built for many different types of systems and still adhere to the same programming model. The required system facilities are:

- a) Host Controller must be able to initiate accesses of host system memory;
- b) Host Controller must be able to modify system memory with byte granularity;
- c) Host Controller must be able to signal an exception/interrupt to the host CPU;
- d) access of 32-bit entities in either system memory or on the Host Controller must be endian neutral and atomic.

1.7 Alignment

1.7.1 Data alignment

The 1394 Open HCI must perform these two alignment functions:

- a) Translate between the byte alignments of the host-based data and the quadlet aligned FIFO. For instance, if a 5 byte 1394 data packet is to be stored at host bus address 6, then the first two bytes of the first data quadlet in the FIFO must be stored at host bus address 6 and 7 using a single word write, then the next two bytes of the first quadlet in the FIFO combined with the first byte of the next quadlet in the FIFO are written to host bus address 8, 9, and 10.
- b) Stuff extra zero bytes into the transmit FIFO when the number of bytes to transmit is not an integral number of quadlets

1.7.2 Memory structure and buffer alignment

Alignment requirements for host memory data structures and host memory buffers can be found in sections of this document where those elements are described.

2. Conventions - Notation and Terms

2.1 Notation

2.1.1 Numeric Notation

Unless otherwise specified, numbers will be represented in Verilog language style. In particular, numbers with a “h” prefix are hexadecimal, “b” are binary, and “d” or those without a prefix are decimal. If a number precedes the “ ’ ”, then it indicates the length of the number in bits. For example, 4’h8 is the binary number ’b1000.

2.1.2 Register Notation

2.1.2.1 Read/Write registers

All register field descriptions are tagged with one or more of the following:

Table 2-1 — read/write register field access tags

access tag (rwu)	name	meaning
r	read	field may be read
w	write	field may be written from the host bus
u	update	field may be autonomously updated by Open HCI hardware

2.1.2.2 Set and Clear registers

Throughout this document there are Host Controller registers that are identified as *Set and Clear* registers. These registers have the property of having two addresses by which they may be referenced by the host. Unless otherwise stated in the description of the register, a host read of either address will return the current contents of the register. Host writes, however, have different effects when addressing the different addresses.

When the host writes to the *Set* address the value written is taken as a bit mask indicating which bits in the underlying register are to be set to one. A one bit in the value written indicates that the corresponding bit in the register is to be set to one, while a zero bit in the value written indicates that the corresponding bit in the register is not to be changed. Similarly, host writes to the *Clear* address specify a value that is a bit mask of bits to clear to zero in the underlying register, a one bit means to clear the corresponding bit while a zero bit means to leave the corresponding bit unchanged. It is intended that writing zero bits to these addresses has no effect on the corresponding bits in the underlying register, including transient effects that could affect the operation of the Host Controller.

There are several reasons to use this type of register:

- The host doesn’t need to do both a read and a write to affect only a single bit.
- The host doesn’t risk the Host Controller modifying a bit while the host does a read-modify-write operation, thus causing unintended effects.
- The host doesn’t have to serialize its access to frequently used registers in order to ensure that conflict with another process doesn’t cause unintended effects.

Table 2-2 — Set and Clear register field access tags

access tag (rscu)	name	meaning
r	read	field may be read
s	set	field may be set from the host bus
c	clear	field may be cleared from the host bus
u	update	field may be autonomously updated by Open HCI hardware

2.1.2.3 Register Reset Values

Register field descriptions may be tagged with one or more of the following reset values. This column indicates the value of the field immediately following a software reset or hardware reset. Except where otherwise noted, the results from a software reset and hardware reset are the same. Note that the reset column is for software and hardware resets only and does not include bus reset values (those are discussed as needed in the applicable text).

Table 2-3 — Register field reset values

reset value	meaning
x'by or x'hy	Indicates the value (in binary or hexadecimal) of the field upon completion of a reset. For description of Verilog notation see section 2.1.1.
undef	Following a reset, the value of this field is undefined and may contain (any combination of) zero(s) or one(s).
N/A	Not applicable. A reset does not have any affect on this field.

Unless otherwise specified, all fields will remain unchanged after a bus reset.

2.1.2.4 Reserved fields

All reserved fields (indicated by a hatched or grayed-out pattern) are read as zeros (but must be ignored) and must be written as zeros.

2.1.2.5 Reserved registers

Addresses within the OpenHCI Register Address space that are marked as reserved must return zeros when read and must ignore writes.

2.1.2.6 Register field notation

In descriptions which refer to specific register fields, the notation *Rrrrr.ffff* will be used where *Rrrrr* refers to the register name and *ffff* refers to the referenced field within that register.

2.2 Terms

The following terms and acronyms are used throughout this document.

AR DMA	Asynchronous Receive DMA.
AR DMA Request	Refers to the asynchronous receive DMA context that handles all incoming request packets not handled by the <i>physical request unit</i> .
AR DMA Response	Refers to the asynchronous receive DMA context that handles all incoming response packets.
AT DMA	Asynchronous Transmit DMA.
AT DMA Request Unit	Refers to the asynchronous transmit DMA subunit which moves transmit packets from buffers in memory to the request transmit FIFO.
AT DMA Response Unit	Refers to the asynchronous transmit DMA subunit which moves transmit packets from buffers in memory to the response transmit FIFO.
big endian	A term used to describe the arithmetic significance of data-byte addresses. With big-endian, the data byte with the largest address is the least significant. ^a
bridge	A hardware adapter that forwards transactions between buses. ^a
channel	Refers to an <i>isochronous channel</i> number
CSR architecture	ISO/IEC 13213: 1994 [ANSI/IEEE Std 1212, 1994 Edition], <i>Information technology - Microprocessor systems - Control and Status Registers (CSR) Architecture for microcomputer buses</i> . The CSR architecture supports the concept of bus bridges, which can transparently forward transactions from one compliant bus to another. ^a
DMA context	A distinct logical stream (not necessarily physical) through the Open HCI which can be described by a <i>DMA context program</i> and a minimum of two registers: ContextControl and CommandPtr.
DMA context program	A list of <i>DMA descriptors</i> which identify buffers used for data transfer.
DMA controller	Refers to the mechanism used in support of a specific DMA function. Each controller utilizes and maintains its own set of registers to perform its specified functionality.
DMA descriptor	A data structure used to describe buffers and buffer-list control.
DMA descriptor block	A group of DMA descriptors that are contiguous in host memory and can therefore be prefetched by the Host Controller. The last DMA descriptor in a block contains the address of the next block as well as a count of the number of descriptors contained in the next block. This count is referred to as the <i>Z</i> value.
EUI-64	Extended Unique Identifier. See <i>Global Unique ID</i> below.
Global Unique ID	A 64-bit node unique identifier, comprised of a 24-bit node company ID and a 40-bit chip ID.
GUID	See <i>Global Unique ID</i> .
hardware reset	Refers to a host power reset.
HC	Host Controller. The device who's interface is defined by this specification.
HCI	Host Controller Interface. The interface defined by this specification.
INPUT_*	Abbreviated notation for INPUT_MORE and INPUT_LAST DMA commands.
IR DMA	Isochronous Receive DMA.
isochronous channel	Within the packet header of an IEEE 1394 isochronous packet there is a 6 bit channel number. Receivers "listen" for packets transmitted with particular channel number(s).
IT DMA	Isochronous Transmit DMA.
ITF	Isochronous Transmit FIFO.

link layer (LINK)	The layer, in a stack of three protocol layers defined for the Serial Bus, that provides the service to the transaction layer of one-way data transfer with confirmation of reception. The link layer also provides addressing, data checking, and data framing. The link layer also provides an isochronous data transfer service directly to the application. ^c
little endian	A term used to describe the arithmetic significance of data-byte addresses. With little-endian, the data byte with the smallest address is the least significant. ^a
Node ID	This is a unique 16-bit number, which distinguishes the node from other nodes in the system. ^c
OHCI	Open Host Controller Interface.
OUTPUT_*	Abbreviated notation for OUTPUT_MORE and OUTPUT_LAST DMA commands.
PCI	Peripheral Component Interconnect. Specification that defines the PCI bus. This bus is intended to define the interconnect and bus transfer protocol between highly-integrated peripheral adapters that reside on a common local bus on the system board (or add-in expansion cards on the PCI bus) ^b .
PHY	Abbreviation for the physical layer. ^c
physical layer	The layer, in a stack of three protocol layers defined for the Serial Bus, that translates the logical symbols used by the link layer into electrical signals on the different Serial Bus media. The physical layer guarantees that only one node at a time is sending data and defines the mechanical interfaces for the Serial Bus. ^c
Physical Request Unit	Physical Request Unit. Refers to the asynchronous receive DMA subunit that handles physical requests.
Physical Response Unit	Refers to the asynchronous transmit DMA subunit that handles physical responses.
posted write	A write request received by the Host Controller for which the Host Controller sends an ack_complete before the data is actually written to system memory.
RQTF	Request Transmit FIFO. Refers to the FIFO used for asynchronous transmit requests.
RSTF	Response Transmit FIFO. Refers to the FIFO used for asynchronous transmit responses. Used for AT DMA responses and physical responses.
quadlet	A 32-bit word.
RDMA	Receive DMA.
ROM	Read Only Memory.
software reset	Refers to a Host Controller reset that is initiated by host software. See section 5.7, "HCControl registers (set and clear)."
Z block	See <i>DMA descriptor block</i> .

a. *Information technology - Microprocessor systems - Control and Status Registers (CSR) Architecture for microcomputer buses*, ISO/IEC 13213 [1994], The Institute of Electrical And Electronics Engineers, Inc., New York, NY.

b. Shanley, T. and Anderson, D. [February 1995], *PCI System Architecture*, Addison-Wesley, Reading, MA.

c. IEEE Standard for a High Performance Serial Bus, Std 1394-1995, The Institute of Electrical And Electronics Engineers, Inc., New York, NY.

3. DMA overview

The 1394 Open HCI provides several types of DMA functionality:

- General-purpose DMA handling asynchronous transmit and receive packets and isochronous transmit and receive packets.
- An inbound bus bridge function that allows 1394 devices to directly access system memory called “physical DMA.”
- A separate write buffer for the received self-ID packets.
- A mapping between a 1K byte block in system memory and the first 1K of 1394 Configuration ROM.

This section will describe the common controller features and attributes.

3.1 Context Registers

A context provides the basic information to the Host Controller to allow it to fetch and process descriptors for one of the several DMA controllers. All contexts (except for SelfID) minimally have a ContextControl Register and a CommandPtr Register. The formats of the ContextControl Registers is DMA controller specific but all ContextControl registers minimally have the bits as shown in figure 3-1 and described in table 3-1. The CommandPtr Registers for all controllers are the same and follow the format shown in figure 3-2 and described in table 3-3.

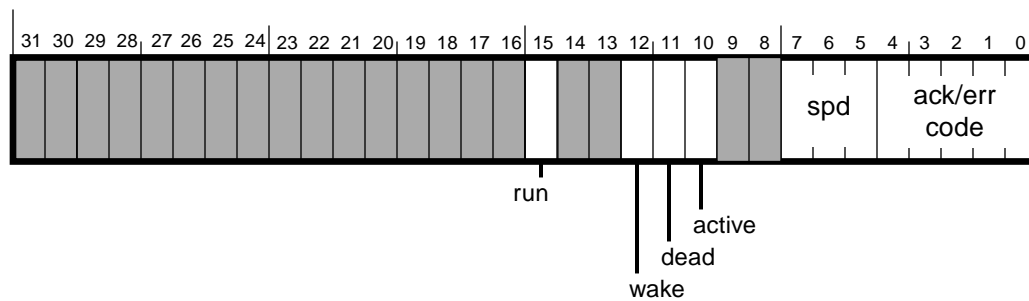

Figure 3-1 — ContextControl (set and clear) register format

Table 3-1 — ContextControl (set and clear) register description

Field	rscu	reset	Description
run	rscu	1'b0	The run bit is set by software to enable descriptor processing for a context and cleared by software to stop descriptor processing. The Host Controller will only change this bit on a hardware or software reset to set it to 0. See section 3.1.1 for details.
wake	rsu	undef	Software sets this bit to 1 to cause the Host Controller to continue or resume descriptor processing. The Host Controller will clear this bit on every descriptor fetch. See section 3.1.2 for details.
dead	ru	1'b0	The Host Controller sets this bit when it encounters a fatal error. The Host controller clears this bit when software clears the run bit. See section 3.1.4 for details.
active	ru	1'b0	The Host Controller sets this bit to 1 when it is processing descriptors. See section 3.1.3 for details.

Table 3-1 — ContextControl (set and clear) register description

Field	rscu	reset	Description
spd	ru	undef	This field indicates the speed at which the packet was received or transmitted. 3'b000 = 100 Mbits/sec, 3'b001 = 200 Mbits/sec and 3'b010 = 400 Mbits/sec. All other values are reserved. Spd only contains meaningful information for receive contexts.
ack/err code	ru	undef	This field holds the acknowledge sent by the Link core for this packet, or an internally generated error code (evt_*) if the packet was not transferred successfully. All possible ack/err codes are shown in Table 3-2, "Packet event codes," below.

Table 3-2 — Packet event codes

Code	Name	DMA	Meaning
5'h00	<i>reserved</i>		
5'h01	ack_complete	AT,AR IT,IR	The destination node has successfully accepted the packet. If the packet was a request subaction, the destination node has successfully completed the transaction and no response subaction shall follow. The ack/err code for transmitted PHY, isochronous and broadcast packets, none of which yields an ack code, will be set by hardware to ack_complete unless an evt_underrun or evt_data_read occurs.
5'h02	ack_pending	AT,AR	The destination node has successfully accepted the packet. If the packet was a request subaction, a response subaction will follow at a later time. This code is not returned for a response subaction.
5'h03	<i>reserved</i>		
5'h04	ack_busy_X	AT	The packet could not be accepted after max ATRetries (see section 5.4) attempts, and the last ack received was ack_busy_X.
5'h05	ack_busy_A	AT	The packet could not be accepted after max ATRetries (see section 5.4) attempts, and the last ack received was ack_busy_A. NOTE: The 1394 Open HCI does not support the dual phase retry protocol for transmitted packets, so this ack should not be received.
5'h06	ack_busy_B	AT	The packet could not be accepted after max AT Retries (see section 5.4) attempts, and the last ack received was ack_busy_B. (See note for "ack_busy_A")
5'h07 - 5'h0C	<i>reserved</i>		
5'h0D	ack_data_error	AT,IR	The destination node could not accept the block packet because the data field failed the CRC check, or because the length of the data block payload did not match the length contained in the data_length field. This code is not returned for any packet that does not have a data block payload.
5'h0E	ack_type_error	AT	A field in the request packet header was set to an unsupported or incorrect value, or an invalid transaction was attempted (e.g., a write to a read-only address).
5'h0F	<i>reserved</i>		
5'h10	evt_tcode_err	AT	A bad tCode is associated with this packet. The packet was flushed.
5'h11	evt_short_packet	IR	For IR <u>packet-per-buffer</u> mode only. The received data length was less than the packet's data_length.
5'h12	evt_long_packet	IR	For IR <u>packet-per-buffer</u> mode only. The received data length was greater than the packet's data_length.
5'h13	evt_missing_ack	AT	A subaction gap was detected before an ack arrived.
5'h14	evt_underrun	AT	Underrun on the corresponding FIFO. The packet was truncated. See Section 13.2.3 for further details.

Table 3-2 — Packet event codes (Continued)

Code	Name	DMA	Meaning
5'h15	evt_overrun	IR	A receive FIFO overflowed during the reception of an isochronous packet.
5'h16	evt_descriptor_read	AT,AR IT,IR	An unrecoverable error occurred while the Host Controller was reading a descriptor block.
5'h17	evt_data_read	AT,IT	An error occurred while the Host Controller was attempting to read from host memory in the data stage of descriptor processing.
5'h18	evt_data_write	AR,IR	An error occurred while the Host Controller was attempting to write to host memory in the data stage of descriptor processing.
5'h19	evt_bus_reset	AR	Identifies a PHY packet in the receive buffer as being the synthesized bus reset packet. (See section 8.4.2.3).
5'h1A	evt_timeout	AT	Indicates that the asynchronous transmit response packet expired and was not transmitted.
5'h1B- 5'h1D	<i>reserved</i>		
5'h1E	evt_unknown	AT,AR IT,IR	An error condition has occurred that cannot be represented by any other event codes defined herein.
5'h1F	evt_flushed	AT	Sent by the link side of the output FIFO when asynchronous packets are being flushed due to a bus reset.

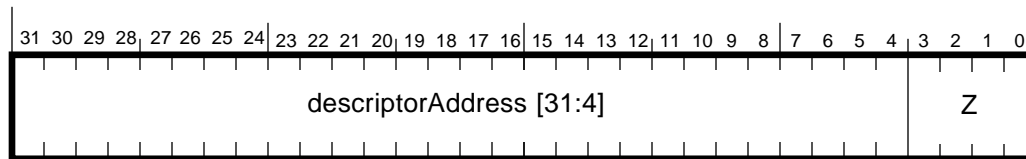
**Figure 3-2 — CommandPtr register format****Table 3-3 — CommandPtr register description**

Field	rwu	reset	Description
descriptorAddress	rwu	undef	Contains the upper 28 bits of the address of a 16-byte aligned descriptor block. See section 3.1.5 for details.
Z	rwu	undef	Indicates the number of contiguous descriptors at the address pointed to by descriptorAddress. If Z is 0, it indicates that the descriptorAddress is not valid. See sections 3.1.4.1 and 3.1.5 for details.

3.1.1 ContextControl.run

The ContextControl.run bit is set by software when the Host Controller is to begin processing descriptors for the context. Before software sets ContextControl.run, ContextControl.active must not be set, and the CommandPtr Register for the context must contain a valid descriptor block address and a Z value that is appropriate for the descriptor block address.

Software may stop the Host Controller from further processing of a context by clearing `ContextControl.run`. When a `ContextControl.run` is cleared, the Host Controller will stop processing of the context in a manner that will not impact the operation of any other context or DMA controller. The Host Controller may require a significant amount of time to safely stop processing for a context but when the Host Controller does stop, it will clear `ContextControl.active`. If software clears a `ContextControl.run` for an isochronous context while the Host Controller is processing a packet for the context, the Host Controller will continue to receive or transmit the packet and update descriptor status. The Host Controller will, however, stop at the conclusion of that packet. If `ContextControl.run` is cleared for a non-isochronous context, the Host Controller may stop processing at any convenient point as long as the context and descriptors end up in a consistent state (e.g., status updated if a packet was sent and acknowledged).

Clearing `ContextControl.run` may have other side effects that are DMA controller dependent. These effects are described in the chapters that cover each of the DMA controllers.

When software clears `ContextControl.run` and the Host Controller has stopped, the Host Controller is not necessarily in a state that can be restarted simply by setting `ContextControl.run`. Software should always ensure that `CommandPtr.descriptorAddress` and `CommandPtr.Z` are set to valid values before setting `ContextControl.run`.

3.1.2 ContextControl.wake

When software adds to a list of descriptors for a context, the Host Controller may have already read the descriptor that was at the end of the list before it was updated. The value that the Host Controller read may contain a Z value of zero indicating the end of the descriptor list. The `ContextControl.wake` bit provides a simple semaphore to the hardware to indicate that the list may be changed since the last time that Host Controller read a descriptor. Therefore, if the Host Controller had fetched a descriptor and the indicated branch address had a Z value of zero, then the Host Controller should reread the pointer value. If, on the reread, the Z value is still zero, then the end of the list has been reached and the Host Controller should clear `ContextControl.active`. If, however, the Z value is now non-zero, the Host Controller will continue processing.

In order to ensure that a wake condition is not missed, the Host Controller should clear `ContextControl.wake` before it reads or rereads a descriptor.

`ContextControl.wake` is ignored when `ContextControl.run` is zero.

3.1.3 ContextControl.active

`ContextControl.active` is set and cleared only by the Host Controller. It is set when the Host Controller receives an indication from software that a valid descriptor is available for processing. This indication can come as a result of software setting the `ContextControl.run` or by software setting `ContextControl.wake` while `ContextControl.run` is set. There are four cases in which the Host Controller will clear `ContextControl.active`: when a branch is indicated by a descriptor but the Z value of the branch address is 0; when software clears `ContextControl.run` and the Host Controller has reached a safe stopping point; while `ContextControl.dead` is set; and after a hardware or software reset of the Host Controller. Additionally, for the asynchronous transmit contexts (request and response), the Host Controller will clear `ContextControl.active` when a bus reset occurs.

When `ContextControl.active` is cleared and `ContextControl.run` is already clear, the Host Controller will set the `IntEvent` bit for the context. This interrupt is the same interrupt that would have been generated by the context if a completed descriptor had indicated that an interrupt should be generated.

3.1.4 ContextControl.dead

ContextControl.*dead* is used to indicate a fatal error in processing a descriptor. When ContextControl.*dead* is set by the Host Controller, ContextControl.*active* is cleared but ContextControl.*run* remains set. In addition, setting ContextControl.*dead* causes an unrecoverableError interrupt event (see Table 6-1) and blocks a normal context event interrupt from being set.

ContextControl.*dead* is cleared when software clears ContextControl.*run* or by either a hardware or software reset of the Host Controller.

Software can determine the cause of a context going dead by checking the ContextControl.*ack/err* code (table 3-2). The defined reasons for the Host Controller to set ContextControl.*dead* are described in section 3.1.4.1 and section 13., “Host Bus Errors.”

3.1.4.1 Bad Z Value

When software sets ContextControl.*run* and CommandPtr.Z contains an invalid value for the controller and context (e.g., not equal to 1 for asynchronous receive or set to 0), the Host Controller will set ContextControl.*dead* and not process any descriptors in that context.

3.1.5 CommandPtr

Software initializes CommandPtr.*descriptorAddress* to contain the address of the first descriptor block that the Host Controller will access when software enables the context by setting ContextControl.*run*. Software also initializes CommandPtr.Z to indicate the number of descriptors in the first descriptor block. Software shall only write to this register when both ContextControl.*run* and ContextControl.*active* are zero. The Host Controller is not required to enforce this rule and its behavior when this rule is violated is undefined.

Since the Host Controller utilizes the CommandPtr register while processing a context, there is a set of guidelines by which software may safely and deterministically read CommandPtr. These guidelines are based on the ContextControl bits as follows (X=‘don’t care’):

Table 3-4 — CommandPtr read values

ContextControl fields				CommandPtr. <i>descriptorAddress</i> Value
run	dead	active	wake	
0	0	X	X	A descriptor block address. Either last written or last executed
1	0	0	0	Refers to the descriptor block that contains the Z=0 that caused the Host Controller to set active to 0.
1	0	0	1	Contents unspecified.
1	0	1	0	Contents unspecified.
1	0	1	1	Contents unspecified.
1	1	X	X	Points to the descriptor block in which a fatal error occurred.

If ContextControl.*run* is set and ContextControl.*dead* is not set, then the contents of CommandPtr are only specified if both ContextControl.*active* and ContextControl.*wake* are clear. In this instance, CommandPtr.*descriptorAddress* will contain the address of a descriptor within the last descriptor block that was executed. If ContextControl.*run* and ContextControl.*dead* are both set, then descriptorAddress points to a descriptor within the descriptor block in which an unrecoverable error occurred.

Except for the case where software initializes `CommandPtr`, the value of `CommandPtr.Z` is undefined and `Z` may contain a value that is implementation dependant.

The value of `CommandPtr` is undefined after a hardware or software reset of the Host Controller.

3.2 List Management

All contexts use an identical method for controlling the processing of descriptors associated with the context. This presents a uniform interface to controlling software and allows reuse of hardware on the Host Controller.

3.2.1 Software Behavior

3.2.1.1 Context Initialization

Software initializes the context by first checking to see that `ContextControl.run`, `ContextControl.active` and `ContextControl.dead` are all 0. Then, `CommandPtr.descriptorAddress` is written to point to a valid descriptor block and `CommandPtr.Z` is set to a value that is consistent with the descriptor block. Then `ContextControl.run` can be set.

3.2.1.2 Appending to Running List

Software may append to a list of descriptors at any time. Software may append either a single descriptor or a linked list of descriptors. When the to-be-appended list is properly formatted, software updates the branch address and `Z` value of the descriptor that was at the end of the list being processed by the Host Controller.

When software completes linking process it must set `ContextControl.wake` for the context. This ensures that the Host Controller will resume operation if it had previously reached the end of the list and gone inactive.

3.2.1.3 Stopping a Context

Software can stop a running context by clearing `ContextControl.run`. The context might not stop immediately. To ensure that the context has stopped, software must wait for `ContextControl.active` to be cleared by the Host Controller. This indicates that the Host Controller has completed all processing associated with the context.

3.2.2 Hardware Behavior

The Host Controller has several DMA controllers each of which has one or more contexts. Each DMA controller is expected to examine each of its contexts on a periodic basis and make operational decisions based on the context state as contained in `ContextControl`. The flow-chart for how a DMA controller uses the `ContextControl` state to govern descriptor processing is shown below. This process is executed once each time a context is 'scheduled'. Scheduling of a context is dependent on the DMA controller. For example, an isochronous transmit context will be scheduled once per cycle while an asynchronous request transmit context will only be scheduled once per fairness interval.

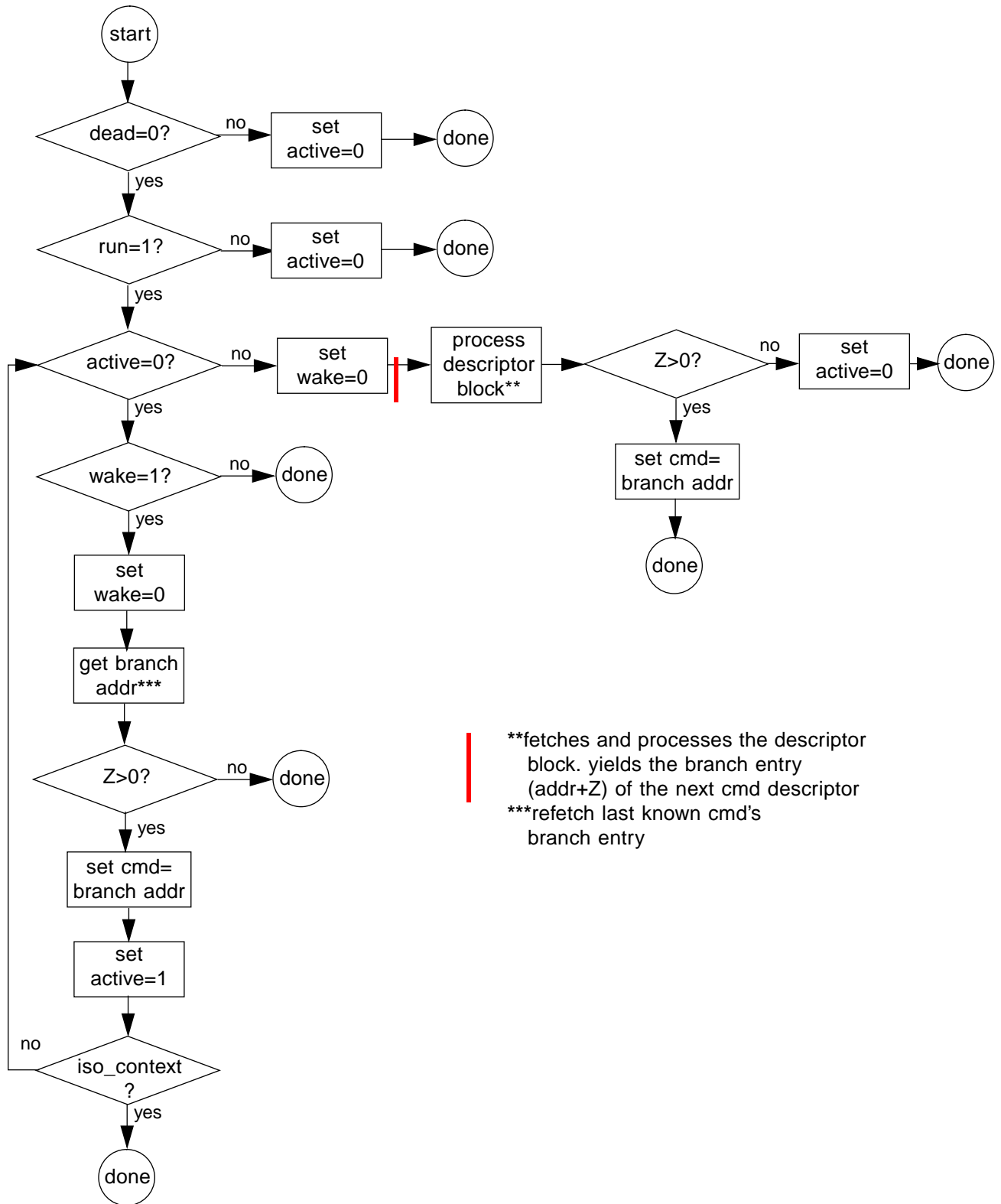

Figure 3-3 — Flow Chart for processing a descriptor

3.3 Asynchronous Receive

The Host Controller accepts 1394 transactions and groups them as follows:

- 1) physical read requests - physical read requests are handled directly by the Host Controller and are not made visible to system software. DMA contexts and controllers that are used in a Host Controller for the physical read request unit are implementation specific. This specification places no limits on the physical response unit other than its effective address range and the requirement that the Host Controller may not block processing of other transaction types while dealing with physical requests.
- 2) self-ID packets - PHY packets with the selfID format can be received at any time. However, only those packets that are received during the selfID phase of bus initialization which immediately follows a bus reset are considered to be selfID packets. Others are considered simply to be PHY packets which are handled like asynchronous requests. The Host Controller can be programmed to accept or ignore selfID packets. When selfID packets are accepted, they are stored in a special memory buffer which has a dedicated controller and context. Because of this special memory buffer, selfID packets can never get 'stuck' in a FIFO.
- 3) asynchronous responses - when the host system initiates a request through the asynchronous transmit request context, the response will be handled by the asynchronous receive response context. The fact that host system software initiates the process and the fact that the Host Controller has a separate context for responses allows system software to budget for all responses which ensures that the Host Controller will always have a place in system memory to store a response when it arrives. In the unlikely event that the Host Controller does not have a place for the response it is allowed to drop the response when it arrives. This will cause a split-transaction timeout which is an error condition with which the software is already able to deal.
- 4) asynchronous requests - a request may arrive at the Host Controller at any time. Additionally, a request can be of any size up to the limits imposed by the max_rec field in the Bus_Info_Block. Because of the unpredictable nature of this transaction type, it is impractical for the system software to ensure that there is always sufficient buffer space defined in the asynchronous request receive buffers.

The limitations and requirements for handling each of the transaction types suggest some ways of simplifying the hardware implementation so that a FIFO is not needed for each of the input transaction types. One simplification would be to place asynchronous requests into a first FIFO and then send all other transaction types (except for physical reads) through a second FIFO. This two FIFO scheme provides the necessary non-blocking behavior because the Host Controller will always be able to remove transactions from the second FIFO whether or not buffer space exists for the transaction. The selfID, isochronous and asynchronous response transactions will either have a buffer defined for the transaction or it is permissible to discard the transaction if no buffer exists to receive it. This leaves requests to be sent to the first FIFO. When that FIFO fills, additional requests will receive ack_busy until system software makes space available to the Host Controller by adding descriptors to the context.

There is an alternative implementation which is to use a single physical FIFO but ensure that it provides the behavior of the multiple FIFOs. This is a bit more complex than the dual FIFO case but may result in a net savings in hardware. The issue with using a single physical FIFO for all incoming transactions is to make sure that no request is placed in the FIFO unless there is a place for it in system memory. There are several way of accomplishing this with one given as an example here.

On the link side of the input FIFO a counter is maintained. This counter is initialized to 0 when, for the AR request context, ContextControl.run is not set. When the system side of the FIFO reads a request descriptor, the reqLength value from the descriptor is passed to the link side of the FIFO. The link side then adds this value to the current count value. When the count value on the link side is greater than zero, the link can accept request data and place it into the FIFO. After each request, other than a physical write request, quadlet is placed in the FIFO the link side decrements the counter. When the counter reaches 1, the link checks to see if the end of packet has been reached. If it has, the link uses the last entry for the footer value (cycleCount, speed and ackSent.) If the end of the packet has not been reached, the link places an error value in the last quadlet to indicate that the packet was not totally received and then the link returns an ack_busy to the requestor. The system side of the fifo can indicate that additional space has been made available by writing a new value to the link side. The link side will add these values to the current count value.

The system side of the FIFO will send count values to the link side on two occasions. The first is when a descriptor is initially fetched and the reqLength in the descriptor is sent to the link side. It is required that the Host Controller have a look ahead of at least one descriptor (current plus next). If the Host Controller does not look ahead, the link side will not be able to accept packets that cross descriptor boundaries.

The second instance when the system side of the input FIFO sends a count value to the link side is when the system side sees a packet that has an error. Packets that contain errors (e.g., CRC) are always 'backed out' of the buffer when the context is in buffer fill mode. The AR request context can only be in buffer fill mode so all bad packets must be 'backed out'. When a packet is backed out, the space that was allocated for that packet is made available for other packets and the link side of the FIFO must be informed of the amount of data that has been backed out. A simple implementation of this is to maintain a counter on the system side of the FIFO that is reset at the beginning of each packet. As each quadlet is removed from the FIFO, the counter is incremented. At the end of the packet, the Host Controller checks the error code. If it indicates that there was an error, and the packet was a request, the count value is sent to the link side of the FIFO to indicate the amount of space that has been 'reclaimed'.

The reqLength field in a descriptor may indicate a size as large as 65,532 bytes (16,383 quadlets.) If quadlet counts are maintained this means that 14 bits are required to indicate the maximum number of quadlets (0x3FFF). To allow for look ahead, the link side counter should be able to hold a value equal to two maximum sized buffers which is 32,766 (0x7FFFE) quadlets or 15 bits. Since the system software is required to allocate buffers that are sized to accept the maximum sized packet (as described in max_rec of the Bus_Info_Block) the Host Controller need only do one level of look ahead on the buffer descriptors to make sure that the maximum sized packet can be accepted.

If an unrecoverable error occurs when the Host Controller is writing to the AR request buffer, a fail indication is sent to the link side of the FIFO. This indicates that the link side should set its count to zero which will busy further read requests and write requests that are destined for the AR request buffer.

If the AR request context has an unrecoverable error, requests may be in the FIFO some of which may be posted writes. The system side of the FIFO will continue to unload the FIFO even though the AR request context is dead. If a read request is found, a response is returned with the response code set to resp_conflict_error which means that the request can be retired. If a write request is found and that write request would have been sent to the AR request queue, the Host Controller saves the error information for the request (source node ID and offset address) and continues to unload the FIFO, discarding all the write data. When the end of the packet is found, the ackSent code is inspected. If ack_pending was sent, then a response packet is sent with the response code set to resp_conflict_error. If ack_complete had been sent and the write was to physical memory space (below offset 48'h0001_0000_0000) then a posted write error is reported. Note that the host controller will hold the error information until a packet is successfully written so that if an error occurs in the middle of writing a packet, the proper recovery can be made (send resp_conflict_error or generate posted write error as appropriate).

3.4 DMA Summary

The table below is a summary of registers and features used by the OpenHCI DMA controllers. Each controller is fully described later in this document.

Table 3-5 — DMA Summary

DMA	Contexts	Per Context Registers	Per Context Interrupts	Receive mode	DMA commands	Z	tcodes (4'hex)
Asynchronous Transmit (section 7.0)	1 Request	ContextControl CommandPtr	reqTxComplete		OUTPUT_MORE OUTPUT_MORE-Immediate	2-8	0, 1, 4, 5, 9, E
	1 Response	ContextControl CommandPtr	respTxComplete		OUTPUT_LAST OUTPUT_LAST-Immediate		2, 6, 7, B
Asynchronous Receive (section 8.0)	1 Request	ContextControl CommandPtr	ARRQ RQPkt	buffer-fill	INPUT_MORE	1	0, 1, 4, 5, 9, E
	1 Response	ContextControl CommandPtr	ARRS RSPkt				2, 6, 7, B
Isochronous Transmit (section 9.0)	4-32	ContextControl CommandPtr	isochTx isoXmitIntEvent <i>n</i> isoXmitIntMask <i>n</i>		OUTPUT_MORE OUTPUT_MORE-Quadlet OUTPUT_LAST OUTPUT_LAST-Quadlet STORE_VALUE	1-8	A
Isochronous Receive (section 10.0)	4-32	ContextControl CommandPtr ContextMatch	isochRx isoRecvIntEvent <i>n</i> isoRecvIntMask <i>n</i>	packet-per-buffer	INPUT_MORE INPUT_LAST	1-8	as recv'd
				buffer-fill	INPUT_MORE	1	
Self-ID (section 11.0)	1	SelfIDBuffer SelfIDCount	SelfIDComplete	buffer-fill		N/A	

4. Register addressing

The 1394 Open HCI's registers occupy a 2048 byte address space. This 2048 byte space is allocated to control registers, common DMA controller registers and individual DMA context registers as indicated below. Writes to reserved addresses of the 1394 Open HCI address space may have unexpected results and are disallowed. Reads of reserved addresses is undefined. Host processors may only access Host Controller registers with quadlet reads or writes on quadlet boundaries.

All addresses within this 2K address space are reserved for OpenHCI and not for vendor defined registers.

Annex B. describes how this memory space is accessed from PCI.

Table 4-1 — 1394 Open HCI register space map

Offset (binary)	Space
00R_RRRR_RR00 (11'h000 to 11'h17C)	control register space R_RRRR_RR selects register
001_1ccR_RR00 (11'h180 to 11'h1FC)	Asynchronous DMA context register space cc = 2'h0-2'h3 selects DMA context R_RR selects DMA context register
01t_tttt_RR00 (11'h200 to 11'h3FC)	Isochronous Transmit DMA context register space t_tttt = 5'h00-5'h1F selects IT DMA context RR selects DMA context register
1vv_vvvR_RR00 (11'h400 to 11'h7FC)	Isochronous Receive DMA context register space vv_vvv = 5'h00-5'h1F selects IR DMA context R_RR selects DMA context register

4.1 DMA Context Number Assignments

The 1394 Open HCI contains up to 68 DMA contexts, 4 for asynchronous and from 8 up to 64 for isochronous. The controller number assignments for asynchronous DMA are illustrated below. Note that these numbers correspond to the "cc" DMA controller select values in the table above.

Table 4-2 — Asynchronous DMA Context number assignments

DMA Context Number	Context Name
2'h0	Asynchronous Transmit Request
2'h1	Asynchronous Transmit Response
2'h2	Asynchronous Request Recieve
2'h3	Asynchronous Response Receive

For the isochronous transmit contexts, **t_tttt** represents IT contexts numbered 0-31.

For the isochronous receive contexts, **vv_vvv** represents IR contexts numbered 0-31.

4.2 Register Map

Table 4-3 — Register addresses (Sheet 1 of 3)

Offset	DMA Context	Read value	Write value	See clause
11'h000		Version	-	5.2
11'h004		GUID_ROM	GUID_ROM	5.3
11'h008		ATRetries	ATRetries	5.4
11'h00C		CSRReadData	CSRWriteData	5.5.1
11'h010		CSRCompareData	CSRCompareData	5.5.1
11'h014		CSRControl	CSRControl	5.5.1
11'h018		ConfigROMhdr	ConfigROMhdr	5.5.2
11'h01C		BusID	-	5.5.3
11'h020		BusOptions	BusOptions	5.5.4
11'h024		GUIDHi	GUIDHi	5.5.5
11'h028		GUIDLo	GUIDLo	5.5.5
11'h02C		<i>Reserved</i>	<i>Reserved</i>	
11'h030		<i>Reserved</i>	<i>Reserved</i>	
11'h034		ConfigROMmap	ConfigROMmap	5.5.6
11'h038		PostedWriteAddressLo	PostedWriteAddressLo	12.3
11'h03C		PostedWriteAddressHi	PostedWriteAddressHi	
11'h040		Vendor ID	-	5.6
11'h044 - 11'h04C		<i>Reserved</i>	<i>Reserved</i>	
11'h050		HCControl	HCControlSet	5.7
11'h054			HCControlClear	5.7
11'h058 - 11'h05C		<i>Reserved</i>	<i>Reserved</i>	
11'h060	Self ID	<i>Reserved</i>	<i>Reserved</i>	
11'h064		SelfIDBuffer	SelfIDBuffer	11.1
11'h068		SelfIDCount		11.2
11'h06C		<i>Reserved</i>	<i>Reserved</i>	
11'h070		IRChannelMaskHi	IRChannelMaskHiSet	10.4.1.1
11'h074			IRChannelMaskHiClear	
11'h078		IRChannelMaskLo	IRChannelMaskLoSet	
11'h07C			IRChannelMaskLoClear	

Table 4-3 — Register addresses (Sheet 2 of 3)

Offset	DMA Context	Read value	Write value	See clause	
11'h080		IntEvent	IntEventSet	6.2.1	
11'h084		(IntEvent & IntMask)	IntEventClear		
11'h088		IntMask	IntMaskSet	6.2.2	
11'h08C		-	IntMaskClear		
11'h090		IsoXmitIntEvent	IsoXmitIntEventSet	6.2.3.1	
11'h094			IsoXmitIntEventClear		
11'h098		IsoXmitIntMask	IsoXmitIntMaskSet	6.2.3.2	
11'h09C			IsoXmitIntMaskClear		
11'h0A0		IsoRecvIntEvent	IsoRecvIntEventSet	6.2.4.1	
11'h0A4			IsoRecvIntEventClear		
11'h0A8		IsoRecvIntMask	IsoRecvIntMaskSet	6.2.4.2	
11'h0AC			IsoRecvIntMaskClear		
11'h0B0-11'h0DC			<i>Reserved</i>	<i>Reserved</i>	
11'h0E0			LinkControl	LinkControlSet	5.8
11'h0E4	LinkControlClear				
11'h0E8		Node ID	Node ID	5.9	
11'h0EC		Phy Control	Phy Control	5.10	
11'h0F0		Isochronous Cycle Timer	Isochronous Cycle Timer	5.11	
11'h0F4-11'h0FC		<i>Reserved</i>	<i>Reserved</i>		
11'h100		AsynchronousRequestFilterHi	AsynchronousRequestFilterHiSet	5.12.1	
11'h104			AsynchronousRequestFilterHiClear		
11'h108		AsynchronousRequestFilterLo	AsynchronousRequestFilterLoSet		
11'h10C			AsynchronousRequestFilterLoClear		
11'h110		PhysicalRequestFilterHi	PhysicalRequestFilterHiSet	5.12.2	
11'h114			PhysicalRequestFilterHiClear		
11'h118		PhysicalRequestFilterLo	PhysicalRequestFilterLoSet		
11'h11C			PhysicalRequestFilterLoClear		
11'h120-11'h17C		<i>Reserved</i>	<i>Reserved</i>		
11'h180	Async request transmit	ContextControl	ContextControlSet	3.1, 7.2.2	
11'h184			ContextControlClear		
11'h188		<i>Reserved</i>	<i>Reserved</i>		
11'h18C		CommandPtr	CommandPtr	3.1.5, 7.2.1	
11'h190-11'h19C		<i>Reserved</i>	<i>Reserved</i>		

Table 4-3 — Register addresses (Sheet 3 of 3)

Offset	DMA Context	Read value	Write value	See clause
11'h1A0	Async response transmit	ContextControl	ContextControlSet	3.1, 7.2.2
11'h1A4			ContextControlClear	
11'h1A8		<i>Reserved</i>	<i>Reserved</i>	
11'h1AC		CommandPtr	CommandPtr	3.1.5, 7.2.1
11'h1B0-11'h1BF		<i>Reserved</i>	<i>Reserved</i>	
11'h1C0	Async request receive	ContextControl	ContextControlSet	3.1, 8.3.2
11'h1C4			ContextControlClear	
11'h1C8		<i>Reserved</i>	<i>Reserved</i>	
11'h1CC		CommandPtr	CommandPtr	3.1.5, 8.3.1
11'h1D0-11'h1DF		<i>Reserved</i>	<i>Reserved</i>	
11'h1E0	Async response receive	ContextControl	ContextControlSet	3.1, 8.3.2
11'h1E4			ContextControlClear	
11'h1E8		<i>Reserved</i>	<i>Reserved</i>	
11'h1EC		CommandPtr	CommandPtr	3.1.5, 8.3.1
11'h1F0-11'h1FF		<i>Reserved</i>	<i>Reserved</i>	
11'h200 + 16*n	Isoch transmit n, where "n" = 0 for context 0, 1 for context 1, etc...	ContextControl	ContextControlSet	3.1, 9.2.2
11'h204 + 16*n			ContextControlClear	
11'h208 + 16*n		<i>Reserved</i>	<i>Reserved</i>	
11'h20C + 16*n		CommandPtr	CommandPtr	3.1.5, 9.2.1
11'h400 + 32*n	Isoch Receive n, where "n" = 0 for context 0, 1 for context 1, etc.	ContextControl	ContextControlSet	3.1, 10.3.2
11'h404 + 32*n			ContextControlClear	
11'h408 + 32*n		<i>Reserved</i>	<i>Reserved</i>	
11'h40C + 32*n		CommandPtr	CommandPtr	3.1.5, 10.3.1
11'h410 + 32*n		ContextMatch	ContextMatch	10.3.3
11'h414 + 32*n		<i>Reserved</i>	<i>Reserved</i>	
11'h418 + 32*n		<i>Reserved</i>	<i>Reserved</i>	
11'h41C + 32*n		<i>Reserved</i>	<i>Reserved</i>	

5. 1394 Open HCI Registers

5.1 Register Conventions

Unless otherwise specified, all register fields will initialize as zeros. For software, reads of reserved locations (indicated by a hatched or grayed-out pattern) yield undefined results.

Similarly, unless otherwise specified, all fields will remain unchanged after a 1394 bus reset.

Refer to Section 2.1.2 for an explanation of register notation.

5.2 Version Register

This register contains a 32 bit value which indicates the version and capabilities of the interface. The register is expected to be used to indicate the level of functionality present in the 1394 Open HCI. This register is read only.

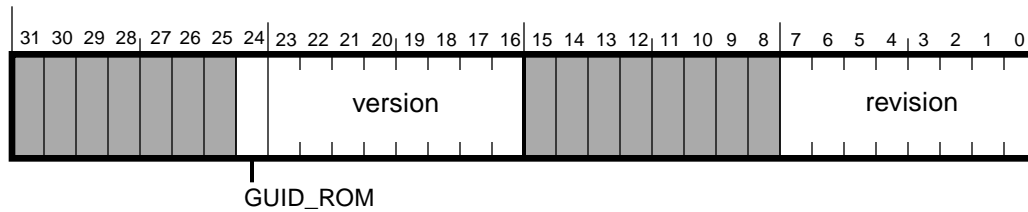

Figure 5-1 — Version register

Table 5-1 — Version register

field name	rwu	reset	description
GUID_ROM	r	N/A	The bus_info_block will be automatically loaded on hardware reset.
version	r	N/A	Major version of the Open HCI. This field contains the bcd encoded value representing the major version of the highest numbered 1394 OpenHCI specification with which this controller is compliant. For example, a Host Controller implemented to this specification (Draft 0.91) will have a version value of 8'h00 and a Host Controller implemented to version 2.25 of this specification will have a vaue of 8'h02.
revision	r	N/A	Minor version of the Open HCI. This field contains the bcd encoded value representing the minor version of the highest numbered 1394 OpenHCI specification with which this controller is compliant. For example, a Host Controller implemented to this specification (Draft 0.91) will have a revision value of 8'h91 and a Host Controller implemented to version 2.25 of this specification will have a vaue of 8'h25.

5.3 GUID ROM register (optional)

The GUID ROM register is used to access the GUID ROM, and is only present if the Version.GUID_ROM bit is set.

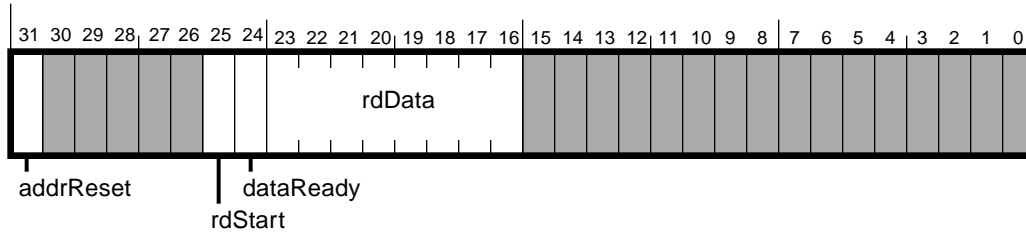

Figure 5-2 — GUID ROM register

Table 5-2 — GUID ROM register

field name	rwu	reset	description
addrReset	rw	undef	This bit is set to one to reset the ROM address to zero. It must be cleared for any reads.
rdStart	rw	1'b0	A read of the currently addressed ROM byte is started on the transition of this bit from a zero to a one.
dataReady	ru	undef	This bit is cleared when the rdStart bit goes from a zero to a one and is set when the currently addressed byte is available in the rdData field. The ROM address is then incremented to the next byte.
rdData	ru	undef	The data read from the ROM.

To initialize the GUID ROM read address, software sets GUIDROM.addrReset to 1 then subsequently sets it to 0. When software reads a ROM byte - by setting GUIDROM.rdStart, then reading this register until GUIDROM.dataReady is 1 - the Host Controller automatically increments the ROM address to set up for the next read.

5.4 ATRetries Register

The AT retries register holds the number of times the 1394 Open HCI will attempt to do a retry for asynchronous DMA request transmit and for asynchronous physical and DMA response transmit.

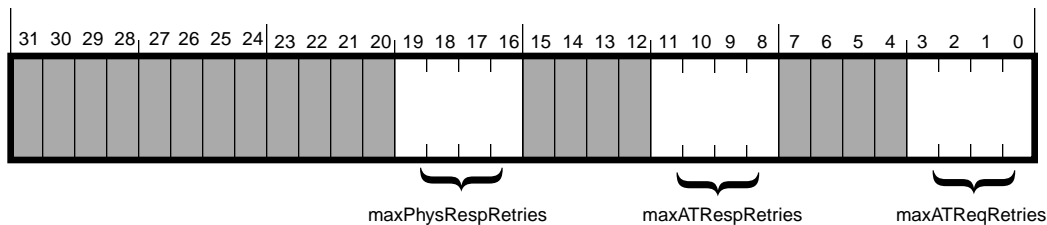

Figure 5-3 — ATRetries register

Table 5-3 — ATRetries register

field name	rwu	reset	description
maxPhysRespRetries	rw	undef	The maxPhysRespRetries field tells the Physical Response Unit how many times to attempt to retry the transmit operation for the response packet when a “busy” acknowledge is received from the target node. Note that this value is used only for responses to physical requests.
maxATRespRetries	rw	undef	The maxATRespRetries field tells the Asynchronous Transmit Response Unit how many times to attempt to retry the transmit operation for the response packet when a “busy” acknowledge is received from the target node. Note that this value is used only for responses sent by software via the Asynchronous Transmit Response DMA context.
maxATReqRetries	rw	undef	The maxATRetries field tells the Asynchronous Transmit DMA Request Unit how many times to attempt to retry the transmit operation for a packet when a “busy” acknowledge is received from the target node. Note that this value is used only for requests sent by software via the Asynchronous Transmit Request DMA context.

The Host Controller is required to wait for a fairness interval before retrying a response packet. Further, when one response is retried all other responses are blocked.

5.5 Autonomous CSR Resources

The 1394 Open HCI implements a number of autonomous CSR resources. In particular the 1394 compare-swap bus management registers are implemented in hardware, as is the config ROM header, the bus_info_block and access to the first 1K bytes of the configuration ROM. The DMA units handle external 1394 bus requests to these resources automatically, and the following registers manage this function for the local host

5.5.1 Bus Management CSR Registers

1394 requires certain 1394 bus management resource registers be accessible only via "quadlet read and quadlet lock" (compare-and-swap) transactions. These special bus management resource registers are implemented internal to the 1394 Open Host Controller to allow atomic compare-and-swap access from either the host system or from the 1394 bus.

Table 5-4 — Serial Bus Registers

CSR address	csrSel	description	reset (hardware reset or bus reset)
48'hFFFF_F000_021C	2'h0	Bus Manager ID	6'3F
48'hFFFF_F000_0220	2'h1	BANDWIDTH_AVAILABLE	13'h1333 (d4915)
48'hFFFF_F000_0224	2'h2	CHANNELS_AVAILABLE_HI	32'hFFFF_FFFF
48'hFFFF_F000_0228	2'h3	CHANNELS_AVAILABLE_LO	32'hFFFF_FFFF

When these bus management resource registers are accessed from the 1394 bus, the atomic compare-and-swap transaction is autonomous, without software intervention.:

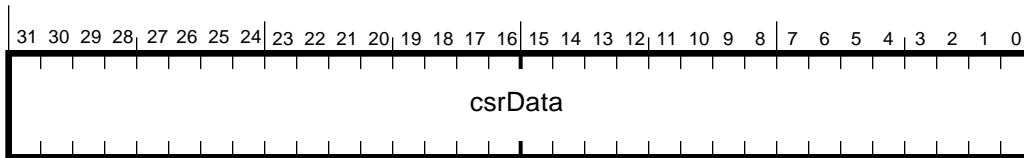

Figure 5-4 — CSR data register

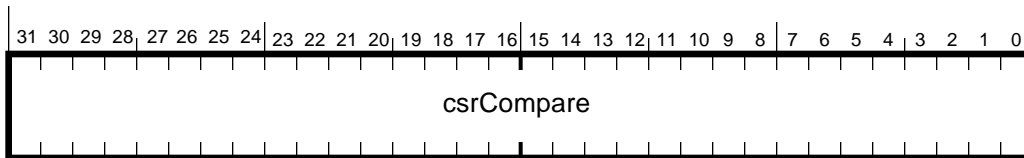

Figure 5-5 — CSR compare register

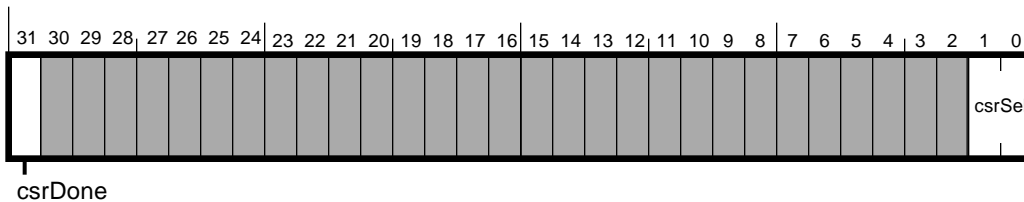

Figure 5-6 — CSR control register

Table 5-5 — CSR registers

field name	rwu	reset	description
csrData	rwu	undef	At start of operation, the data to be stored if the compare is successful.
csrCompare	rw	undef	The data to be compared with the existing value of the CSR resource.
csrDone	ru	1'b1	This bit is set when a compare-swap operation is completed. It is reset whenever this register is written.
csrSel	rw	undef	This field selects the CSR resource: 2'h0 - BUS_MANAGER_ID 2'h1 - BANDWIDTH_AVAILABLE 2'h2 - CHANNELS_AVAILABLE_HI 2'h3 - CHANNELS_AVAILABLE_LO

To access these bus management resource registers from the host bus, first load the CSRData register with the new data value to be loaded into the appropriate resource. Then load the CSRCompare register with the expected value. Finally, write the CSRControl register with the selector value of the resource. A write to the CSRControl register initiates a compare-and-swap operation on the selected resource. When the compare-and-swap operation is complete, the CSRControl register csrDone bit will be set, and the CSRData register will contain the value of the selected resource prior to the host initiated compare-and-swap operation.

Note that an arbitrary update of these resources cannot be done. Only compare-and-swap operations can be used to modify the contents of these internal resource registers.

5.5.2 Config ROM header

The config ROM header register is a 32-bit number that externally maps to the 1st quadlet of the 1394 configuration ROM (offset 48'hFFFF_F000_0400). This register is written locally at the following register (the field names match the IEEE 1394 names):

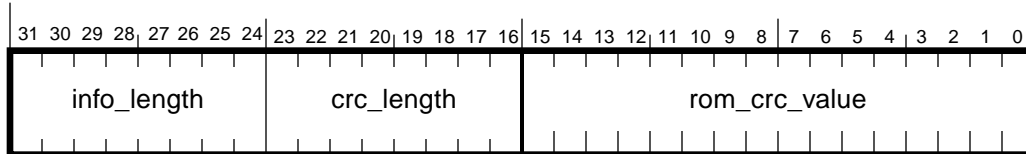

Figure 5-7 — Config ROM header register

Table 5-6 — Config ROM header register fields

field name	rwu	reset	description
info_length	rw	8'h04	IEEE 1394 bus management field. Must be set by firmware before the HCControl.linkEnable bit is set.
crc_length	rw	8'h04	IEEE 1394 bus management field. Must be set by firmware before the HCControl.linkEnable bit is set.
rom_crc_value	rw	GUID Rom Value*	IEEE 1394 bus management field. Must be set by firmware before the HCControl.linkEnable bit is set.

*The reset value for rom_crc_value is undefined if no GUID ROM is present. If a GUID ROM is present, this field is loaded from the GUID ROM.

5.5.3 Bus identification register

The bus identification register is a 32-bit number that externally maps to the first quadlet of the Bus_Info_Block. This register is read locally at the following register:

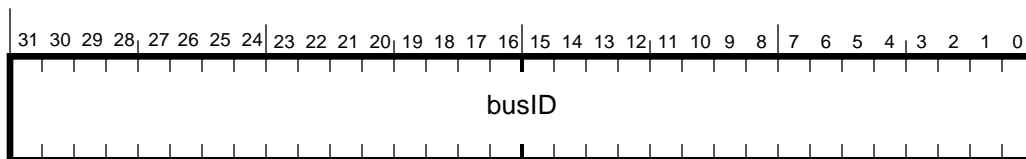

Figure 5-8 — Bus ID register

Table 5-7 — Bus ID register fields

field name	rwu	reset	description
busID	r	N/A	Contains the constant 32'h31333934, which is the ASCII value for “1394”.

5.5.4 Bus options register

The bus options register is a 32-bit number that externally maps to the 2nd quadlet of the Bus_Info_Block. This register is written locally at the following register (the field names match the IEEE 1394 names):

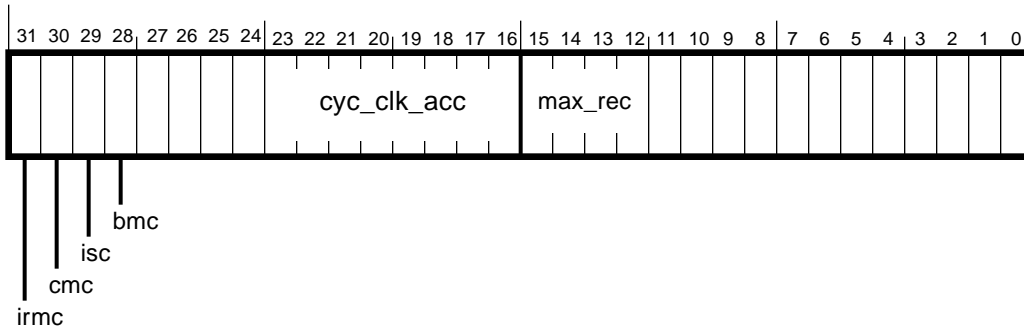

Figure 5-9 — Bus options register

Table 5-8 — Bus options register fields

field name	rwu	reset	description
irmc, cmc, isc, bmc, cyc_clk_acc	rw	undef	IEEE 1394 bus management fields. Must be set by firmware before the HCControl. <i>linkEnable</i> bit is set.
max_rec	rw	undef	IEEE 1394 bus management field. Must be set by firmware before the HCControl. <i>linkEnable</i> bit is set. Note that received block write request packets with a length greater than max_rec may generate an ack_type_error (see table 1-2).
bits 0-11 and 24-27	rw	undef	Currently reserved in 1394-1995.

5.5.5 Global Unique ID

The global unique ID (GUID) is a 64-bit number that externally maps to the third and fourth quadlets of the Bus_Info_Block. These registers are written locally at the following registers (the field names match the IEEE 1394 names):

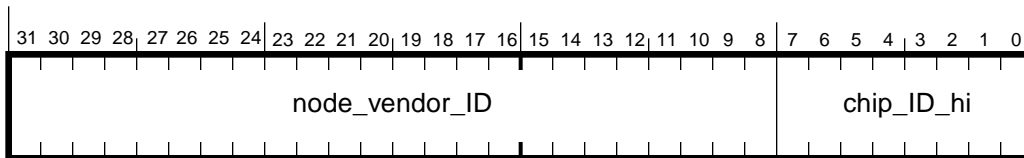

Figure 5-10 — GlobalUniqueIDHi register

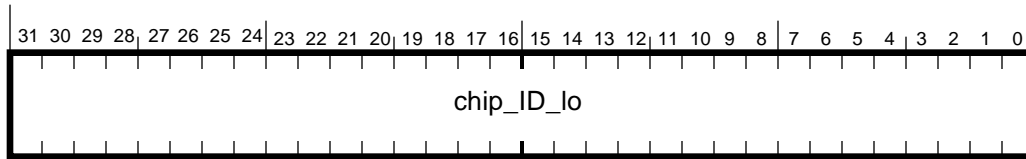

Figure 5-11 — GlobalUniqueIDLo register

field name	rwu	reset	description
node_vendor_ID, chip_ID_hi, chip_ID_lo	rw	**see comments	IEEE 1394 bus management fields. Must be set by firmware before the HCControl. <i>linkEnable</i> bit is set.

**The Global Unique ID (GUID) Registers are reset to 0 after a host power (hardware) reset. A value of 0 is an illegal value. These registers are not affected by a software reset. These GUID registers shall be written only once after host power reset, by either

- 1) an autonomous load operation from a local, **un-modifiable** resource (i.e. local serial ROM or local parallel ROM) performed by the 1394 OHCI hardware, or
- 2) a single host write to each register performed **only by firmware** that is always executed on a hardware reset which affects the Host Controller. This firmware, as well as the GUID value that is loaded, **may not be modifiable by any user action**.

After one of these load mechanisms has executed, the GUID registers are **read-only**.

5.5.6 Configuration ROM mapping register

The configuration ROM mapping register contains the start address within system bus space that will map to the start address of the 1394 configuration ROM for this node. Only quadlet reads to the first 1K bytes of the configuration ROM will map to system bus space, all other transactions to this space will be rejected with a 1394 “ack_type_error”. Since the low order 10 bits of this address are reserved and assumed to be zero, the system address for the config ROM must start on a 1K byte boundary. Note that the first five quadlets of the 1394 config ROM space are mapped to the config ROM header and the bus_info_block, and so are handled directly by the 1394 Open HC as described in sections 5.5.2, 5.5.3, 5.5.4 and 5.5.5. This means that the first five quadlets addressed by the config ROM mapping register are not used.

| This register must be set to a valid address before HCControl.*linkEnable* is set to one.

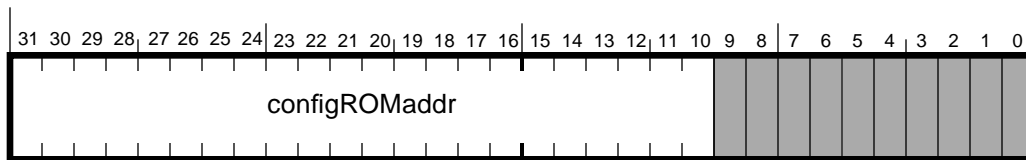

Figure 5-12 — Configuration ROM mapping register

Table 5-9 — Configuration ROM mapping register

field name	rwu	reset	description
configROMAddr	rw	undef	If a quadlet read request to 1394 offset 48'hFFFF_F000_0400 through offset 48'hFFFF_F000_07FF is received, then the low order 10 bits of the offset are added to this register to determine the host memory address of the returned quadlet.

5.6 Vendor ID register

The vendor ID register holds the company ID of an organization that specified any vendor-unique registers.

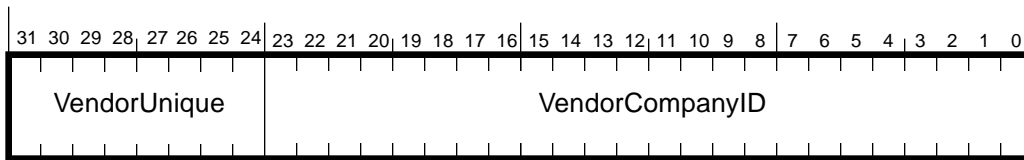

Figure 5-13 — VendorID register

Table 5-10 — VendorID register

field name	rwu	reset	description
vendorCompanyID	r	N/A	The company ID of the organization that specified the particular set of vendor unique registers and behaviors of this particular implementation of the 1394 Open HCI. If no additional features are implemented, this field shall be 24'h0.
vendorUnique	r	N/A	Vendor defined.

To obtain a company ID (also known as an Organizationally Unique Identifier, OUI), contact:

Registration Authority Committee
 The Institute of Electrical and Electronic Engineers, Inc.
 445 Hoes Lane
 Piscataway, NJ 08855-1331
 USA
 (908) 562-3812

Your company need not obtain a company ID if it has been previously assigned an IEEE *48-bit Globally Assigned Address Block* or an IEEE-assigned *Organizationally Unique Identifier (OUI)* for use in network applications. However, be aware that the (left through right) order of the bits within the company ID value is not the same as the (first through last) network-transmission order of the bits within these other identifiers. Consult the IEEE Registration Authority for clarifying documentation.

5.7 HCControl registers (set and clear)

This register provides flags for controlling the Host Controller. There are two addresses for this register: HCControlSet and HCControlClear. On read, both addresses return the contents of the control register. For writes, the two addresses have different behavior: a one bit written to HCControlSet causes the corresponding bit in the Control register to be set,

while a zero bit leaves the corresponding bit in the Control register unaffected. On the other hand, a one bit written to HCControlClear causes the corresponding bit in the Control register to be cleared, while a zero bit leaves the corresponding bit in the HCControl register unaffected.

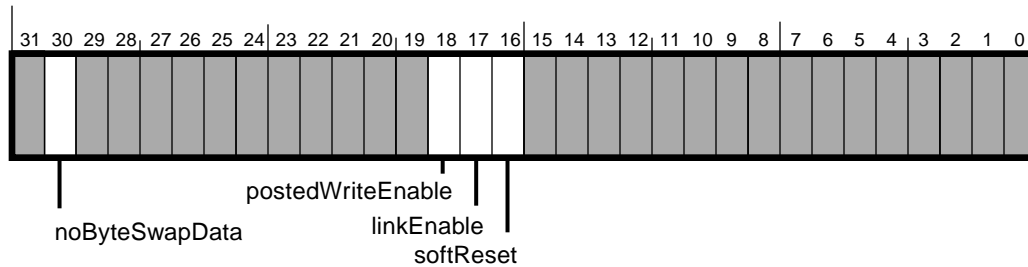

Figure 5-14 — HCControl register

Table 5-11 — HCControl register

field name	rscu	reset	description
noByteSwapData	rsc	undef	When clear, data quadlets are sent/received in little endian order. When set, data quadlets are sent/received in big endian order. See the explanation following this table.
postedWriteEnable	rsc	undef	This bit is used to enable or disable postedWrites. See Section 12., “Physical Requests,” for information about posted writes.
linkEnable	rsc	1'b0	This bit is cleared by a hardware reset or software reset. Software must set this bit when the system is ready to begin operation and then force a bus reset. This bit is necessary to keep other nodes from sending transactions before the local system is ready. When this bit is clear the Host Controller is logically and immediately disconnected from the 1394 bus, no packets will be received or processed nor will packets be transmitted. Software should not set the linkEnable bit until the Configuration ROM mapping register is valid (see section 5.5.6).
softReset	rscu	1'b0	When set, all Host Controller state is reset, all FIFOs are flushed and all Host Controller registers are set to their hardware reset values unless otherwise specified. Registers outside of the OpenHCI realm, i.e. host attachment registers such as those for PCI, are not affected. This bit remains set to one while the softReset is in progress, and reverts back to 0 when the reset has completed.

The 1394 bus is big endian. By convention, when quadlets are sent in big endian order, the leftmost byte (bits 31-24) of a quadlet is sent first. When sent in little endian order, the right most byte (bits 7-0) is sent first with the leftmost bit of each byte sent first.

When the Host Controller sends/receives a packet, the header information is always sent/received in big endian order (leftmost byte first). Since header information is composed of a sequence of quadlets which is invariant over big and little endian system, software need not change the structure of header information.

When the HCControl.noByteSwapData bit is not set, data quadlets are sent/received in little endian order and when HCControl.noByteSwapData is set, data quadlets are sent/received in big endian order. The data quadlets that are subject to swap are:

- 1) any data quadlet covered by data CRC (tcodes 4'h1, 4'h7, 4'h9, 4'hA an 4'hB)
- 2) the data quadlet in a quadlet write request (tcode 4'h0)
- 3) the data quadlet in a quadlet read response (tcode 4'h6)

The cycle_time_data in a cycle start packet is not swapped regardless of the setting of the noByteSwapData bit. The data in a PHY packet (identified internally with tcode 4'hE) is not byte swapped for send or receive.

5.8 LinkControl registers (set and clear)

This register provides the control flags that enable and configure the link core protocol portions of the 1394 Open HCI. It contains controls for the receiver, and cycle timer. There are two addresses for this register: LinkControlSet and LinkControlClear. On read, both addresses return the contents of the control register. For writes, the two addresses have different behavior: a one bit written to LinkControlSet causes the corresponding bit in the LinkControl register to be set, while a zero bit leaves the corresponding bit in the LinkControl register unaffected. On the other hand, a one bit written to LinkControlClear causes the corresponding bit in the LinkControl register to be cleared, while a zero bit leaves the corresponding bit in the LinkControl register unaffected.

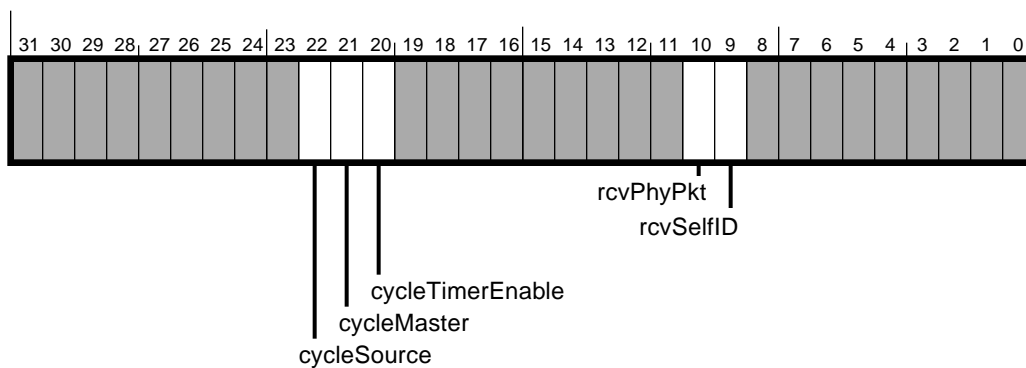

Figure 5-15 — LinkControl register

Table 5-12 — LinkControl register

field name	rscu	reset	description
cycleSource	rsc	undef	When set, the cycle timer will use an external source to determine when to roll over the cycle timer. When cleared, the 1394 Open HCI will roll the cycle timer over when the timer reaches 3072 cycles of the 24.576 MHz clock (i.e. 8 kHz).
cycleMaster	rscu	undef	When set and the PHY has notified the 1394 Open HCI that it is root, the 1394 Open HCI will generate a cycle start packet every time the cycle timer rolls over, based on the setting of the cycleSource bit. When cleared, the 1394 Open HCI will accept received cycle start packets to maintain synchronization with the node which is sending them. This bit is automatically cleared when the IntEvent.cycleTooLong event occurs and cannot be set until the IntEvent.cycleTooLong bit is cleared.
cycleTimerEnable	rsc	undef	When set, the cycle timer offset will count cycles of the 24.576 MHz clock and roll over at the appropriate time based on the settings of the above bits. When cleared, the cycle timer offset will not count.
rcvPhyPkt	rsc	undef	When set, the receiver will accept incoming PHY packets into the AR request context if the AR request context is enabled. This does <i>not</i> control receipt of self-identification packets.
rcvSelfID	rsc	undef	When set, the receiver will accept incoming self-identification packets. Before setting this bit, software must ensure that the self ID buffer pointer register contains a valid address.

5.9 Node identification and status register

This register contains the CSR address for the node on which this chip resides. The 16-bit combination of busNumber and nodeNumber is referred to as the node ID.

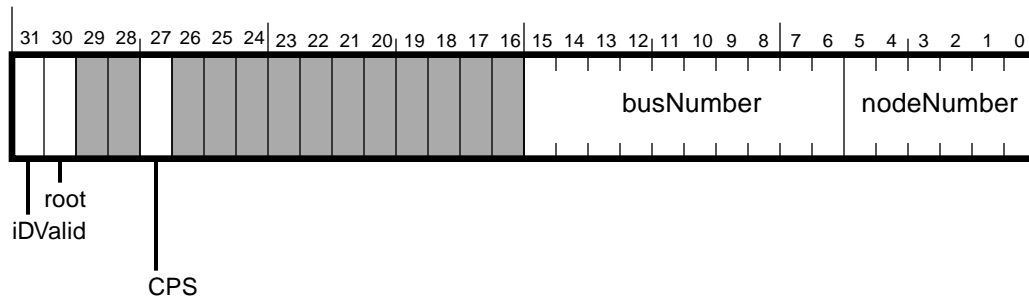

Figure 5-16 — Node ID register

Table 5-13 — Node ID register

field name	rwu	reset	description
iDValid	ru	1'b0	This bit indicates whether or not the 1394 Open HCI has a valid node number. It is cleared when the bus reset state is detected and set again when the 1394 Open HCI receives a new node number from the PHY.
root	ru	1'b0	This bit is set during the bus reset process if the attached PHY is root.
CPS	ru	1'b0	Set if the PHY is reporting that cable power status is OK (VP 8V).
busNumber	rwu	10'h3FF	This number is used to identify the specific 1394 bus this node belongs to when multiple 1394-compatible busses are connected via a bridge.
nodeNumber	ru	undef	This number is the physical node number established by the PHY during self-identification. It is automatically set to the value received from the PHY after the self-identification phase. If the PHY sets the nodeNumber to 63, all link-level transmits are disabled.

5.10 PHY control register

The PHY control register is used to read or write a PHY register. To read a register, the address of the register is written to the regAddr field along with a 1 in the rdReg bit. When the read request has been sent to the PHY (through the PhyReq pin), the read bit is cleared. When the PHY returns the register (through a status transfer), the rdDone bit is set. The address of the register received is placed in the rdAddr field and the contents in the rdData field. Note that the rdAddr field should be compared to the value expected because the PHY can automatically send a register, such as the nodeID register, and thus replace the contents of the read before software can look at it.

To write to a PHY register, the address of the register is written to the regAddr field, the value to write to the wrData field, and a 1 to the wrReg bit. The wrReg bit is cleared when the write request has been transferred to the PHY.

Note that the PHY can autonomously send the contents of register 0 to the link. If there is a pending PHY register request, the register 0 data is automatically written to both the NodeID register and the PHY control register. If there is no pending PHY register request, then this data is automatically routed to the NodeID register and does not affect the PHY control register. If register 0 is explicitly read, the data is written to both the NodeID register and the PHY control register.

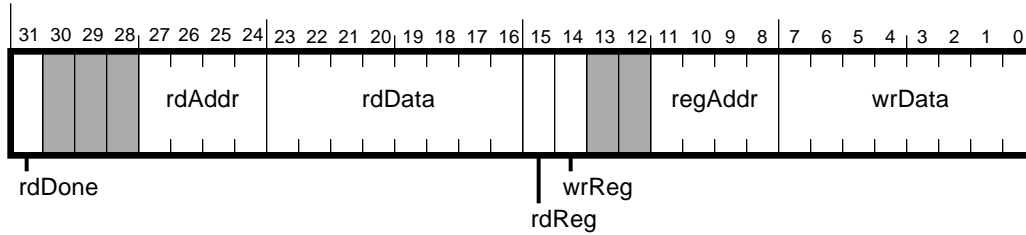

Figure 5-17 — PHY control register

Table 5-14 — PHY control register

field name	rwu	reset	description
rdDone	ru	undef	This bit is cleared when rdReg is set. This bit is set when a register transfer is received from the PHY.
rdAddr	ru	undef	This is the address of the register most recently received from the PHY
rdData	ru	undef	This is the contents of a PHY register which has been read
rdReg	rwu	1'b0	Set this bit to initiate a read request to a PHY register. This bit is cleared when the read request has been sent. The wrReg bit must not be set while the rdReg bit is set.
wrReg	rwu	1'b0	Set this bit to initiate a write request to a PHY register. This bit is cleared when the write request has been sent. The rdReg bit must not be set while the wrReg bit is set.
regAddr	rw	undef	This is the address of the PHY register to be written or read.
wrData	rw	undef	This is the contents to be written to a PHY register. Ignored for a read.

5.11 Isochronous Cycle Timer Register

The isochronous cycle timer register is a read/write register that shows the current cycle number and offset. The cycle timer register is split up into three fields. The lower order 12 bits are the cycle offset, the middle 13 bits are the cycle number, and the upper order 7 bits count time in seconds. When the 1394 Open HCI is cycle master, this register is trans-

mitted with the cycle start message. When the 1394 Open HCI is not cycle master, this register is loaded with the data field in an incoming cycle start. In the event that the cycle start message is not received, the fields continue incrementing on their own (when cycleTimerEnable is set in the LinkControl register) to maintain a local time reference.

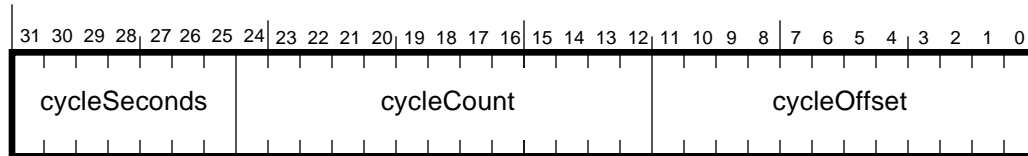

Figure 5-18 — Isochronous cycle timer register

Table 5-15 — Isochronous cycle timer register

field name	rwu	reset	description
cycleSeconds	rwu	N/A	This field counts seconds (cycleCount rollovers) modulo 128
cycleCount	rwu	N/A	This field counts cycles (cycleOffset rollovers) modulo 8000.
cycleOffset	rwu	N/A	This field counts 24.576MHz clocks modulo 3072, i.e. 125 us. If an external 8KHz clock configuration is being used, cycleOffset must be set to 0 at each tick of the external clock.

5.12 Asynchronous Request Filters

The 1394 OpenHCI allows for selective access to host memory and the Asynchronous Receive Request context so that software can maintain host memory integrity. The selective access is provided by two sets of 64-bit registers: PhysRequestFilter and AsynchRequestFilter. These registers allow access to physical memory and the AR Request context on a nodeID basis. The request filters are not applied to quadlet read requests directed at the Config ROM (including the ConfigROM header, BusID, Bus Options, and Global Unique ID registers) nor to accesses directed to the isochronous resource management registers. When the link is enabled, access by any node to the first 1K of CSR config ROM is enabled(see section 5.5.6). The Asynchronous Request Filters *do not have any effect* on Asynchronous Response packets.

5.12.1 AsynchronousRequestFilter Registers (set and clear)

When a request is received by the Host Controller from the 1394 bus and that request does not access the first 1K of CSR config ROM on the Host Controller, then the sourceID is used to index into the AsynchronousRequestFilter. If the corresponding bit in the AsynchronousRequestFilter is set to 0, then requests from that device are not enabled; there will be no *ack_* sent, and the requests will be ignored by the Host Controller. If however, the bit is set to 1, the requests are accepted and will be processed according to the address of the request and the setting of the PhysicalRequestFilter register.

Requests to offsets above 48'h0000_FFFF_FFFF are always sent to the Asynchronous Receive Request DMA context. If the AR Request DMA context is not enabled, then the Host Controller will ignore the request.

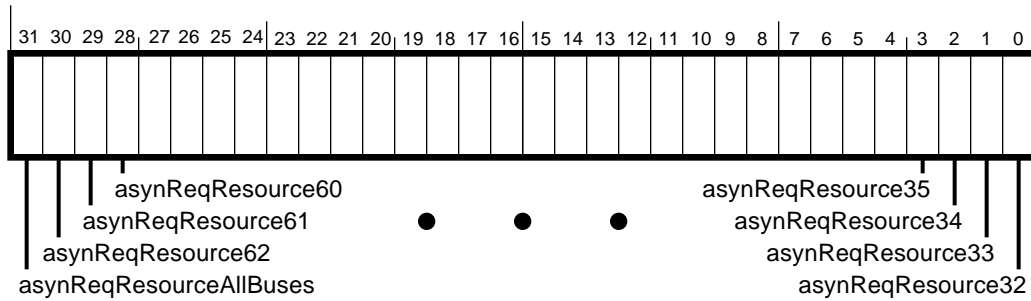

Figure 5-19 — AsynchronousRequestFilterHi (set and clear) register

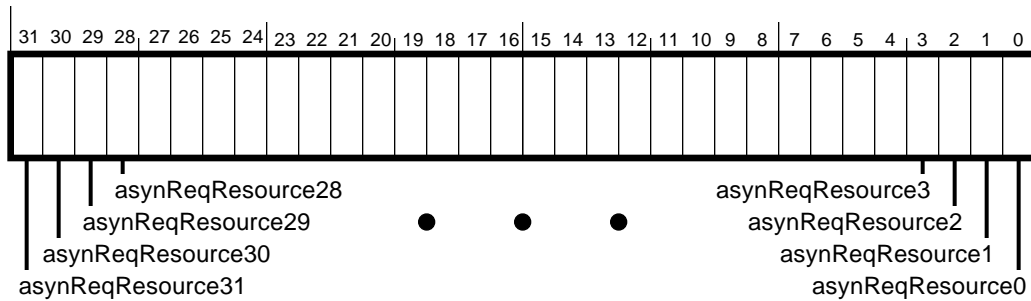

Figure 5-20 — AsynchronousRequestFilterLo (set and clear) register

field name	rwu	reset	description
asynReqResourceN	rw	1'b0	If set to one for local bus node number N, asynchronous requests received by the Host Controller from that node will be accepted.
asynReqResourceAllBuses	rw	1'b0	If set to one, all asynchronous requests received by the Host Controller from non-local bus nodes will be accepted.

The AsynchronousRequestFilter bits are set by writing a one to the corresponding bit in the AsynchronousRequestFilterHiSet or AsynchronousRequestFilterLoSet address. They are cleared by writing a one to the corresponding bit in the AsynchronousRequestFilterHiClear or AsynchronousRequestFilterLoClear address. If bit “asynReqResourceN” is set, then requests with a sourceID of either {10'h3FF, #n} or {busID, #n} will be accepted. If the asynReqResourceAllBuses bit is set in AsynchronousRequestFilterHi, requests from any device on any other bus are accepted (bus number other than 10'h3FF and busID).

Reading the AsynchronousRequestFilter registers returns their current state. All bits in the AsynchronousRequestFilter register are set to 0 on a 1394 bus reset.

5.12.2 PhysicalRequestFilter Registers (set and clear)

If an asynchronous request is allowed from a node, and the offset is below 48'h0001_0000_0000, the sourceID of the request is used as an index into the PhysicalRequestFilter. If the corresponding bit in the PhysicalRequestFilter is set to 0, then the request is forwarded to the Asynchronous Receive Request DMA context. If however, the bit is set to 1, then the request is sent to the physical response unit.:

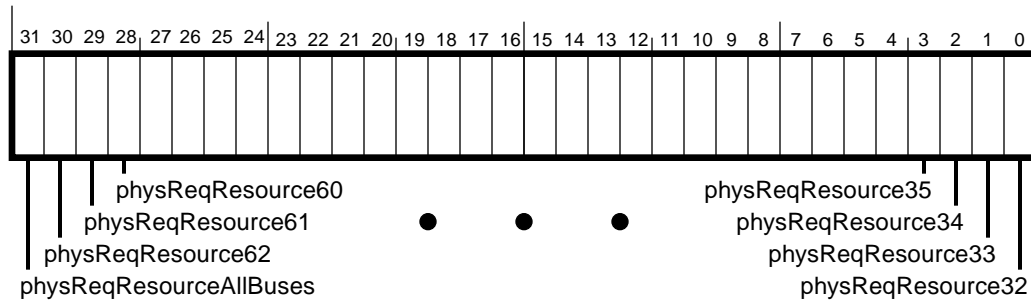

Figure 5-21 — PhysicalRequestFilterHi (set and clear) register

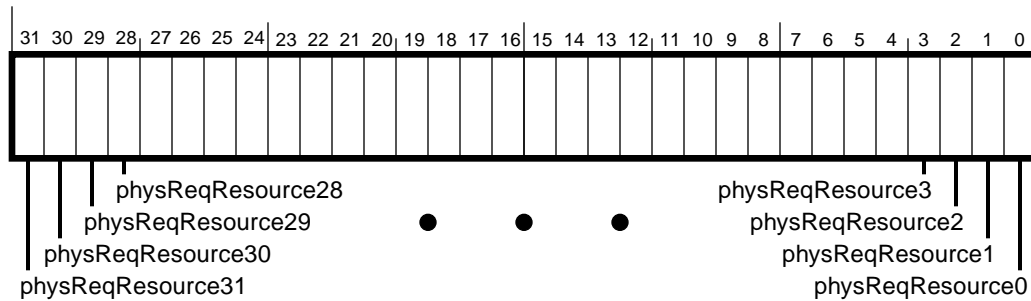

Figure 5-22 — PhysicalRequestFilterLo (set and clear) register

field name	rw	reset	description
physReqResourceN	rw	1'b0	If set to one for local bus node number N, then asynchronous physical requests received by the Host Controller from that node will be accepted.
physReqResourceAllBuses	rw	1'b0	If set to one, all asynchronous physical requests received by the Host Controller from non-local bus nodes will be accepted.

The PhysicalRequestFilter bits are set by writing a one to the corresponding bit in the PhysicalRequestFilterHiSet or PhysicalRequestFilterLoSet address. They are cleared by writing a one to the corresponding bit in the PhysicalRequestFilterHiClear or PhysicalRequestFilterLoClear address. If bit “physReqResourceN” is set, then requests with a sourceID of either {10'h3FF, #n} or {busID, #n} will be accepted. If the physReqResourceAllBuses bit is set in PhysicalRequestFilterHi, physical requests from any device on any other bus are accepted (bus number other than 10'h3FF and busID).

Physical requests that are rejected by the PhysicalRequestFilter are sent to the AR Request DMA context if the AR Request DMA context is enabled. If it is disabled then the Host Controller ignores the requests.

Reading the PhysicalRequestFilter registers returns their current state. All bits in the PhysicalRequestFilter are set to 0 on a 1394 bus reset.

6. Interrupts

6.1 Overview

The 1394 Open HCI reports two classes of interrupts to the host: DMA interrupts and device interrupts. DMA interrupts are generated when DMA transfers complete (or are aborted). Device interrupts come directly from the remaining 1394 Open HCI logic. For example, one of these interrupts could be sent in response to the asserting edge cycleStart, a signal which indicates that a new isochronous cycle has started.

The 1394 Open HCI contains two primary 32-bit registers to report and control interrupts: IntEvent and IntMask. Both registers have two addresses: a “Set” address and a “Clear” address. For a write to either register, a “one” bit written to the “Set” address causes the corresponding bit in the register to be set, while a “one” bit written to the “Clear” address causes the corresponding bit to be cleared. For both addresses, writing a “zero” bit has no effect on the corresponding bit in the register.

The IntEvent register contains the actual interrupt request bits. Each of these bits corresponds to either a DMA completion event, or a transition on a device interrupt line. The IntMask register is ANDed with the IntEvent register to enable selected bits to generate processor interrupts. Software writes to the IntEventClear register to clear interrupt conditions reported in the IntEvent register.

A processor interrupt is generated when one or more unmasked bits are set in the IntEvent register. Low-level software responds to the interrupt by reading the IntEvent register, then writing the value read to the IntEventClear register. At this point the interrupt request is deasserted (assuming no new interrupt bit has been set). Software can proceed to process the reported interrupts in whatever priority order it chooses, and is free to re-enable interrupts as soon as the IntEventClear register is written.

In addition, the 1394 Open HCI contains four secondary 32-bit registers to report and control interrupts for isochronous transmit and receive contexts. Each register has two addresses: a “Set” address and a “Clear” address.

6.2 Interrupt Registers

6.2.1 IntEvent (set and clear)

This register reflects the state of the various interrupt sources from the 1394 Open HCI. The interrupt bits are set by an asserting edge of the corresponding interrupt signal, or by software by writing a one to the corresponding bit in the IntEventSet address. They are cleared by writing a one to the corresponding bit in the IntEventClear address.

Reading the IntEventSet register returns the current state of the IntEvent register. Reading the IntEventClear register returns the *masked* version of the IntEvent register (*IntEvent & IntMask*).

On a hardware reset or soft reset, the values of all bits in this register are undefined.

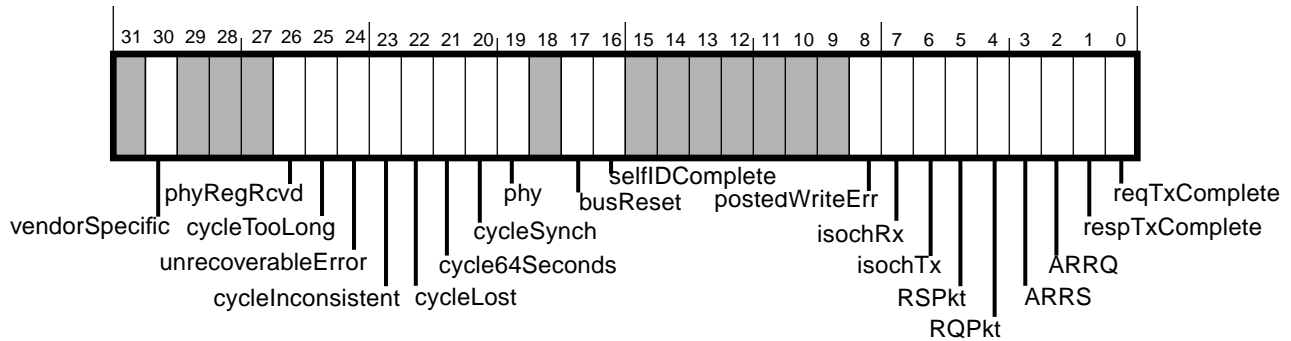

Figure 6-1 — IntEvent register

Table 6-1 — IntEvent register description (Sheet 1 of 2)

Field	Bit #	rscu	Description
reqTxComplete	0	rscu	Asynchronous request transmit DMA interrupt. This bit is conditionally set upon completion of an AT DMA request command.
respTxComplete	1	rscu	Asynchronous response transmit DMA interrupt. This bit is conditionally set upon completion of an AT DMA response command.
ARRQ	2	rscu	Asynchronous Receive Request DMA interrupt. This bit is conditionally set upon completion of an AR DMA Request context command descriptor.
ARRS	3	rscu	Asynchronous Receive Response DMA interrupt. This bit is conditionally set upon completion of an AR DMA Response context command descriptor.
RQPkt	4	rscu	Indicates that a packet was sent to an asynchronous receive request context buffer.
RSPkt	5	rscu	Indicates that a packet was sent to an asynchronous receive response context buffer.
isochTx	6	ru	Isochronous Transmit DMA interrupt. Indicates that one or more isochronous transmit contexts have generated an interrupt. This is not a latched event, it is the OR'ing all bits in (isoXmitIntEvent & isoXmitIntMask). The isoXmitIntEvent register indicates which contexts have interrupted. See section 6.2.3.
isochRx	7	ru	Isochronous Receive DMA interrupt. Indicates that one or more isochronous receive contexts have generated an interrupt. This is not a latched event, it is the OR'ing all bits in (isoRecvIntEvent & isoRecvIntMask). The isoRecvIntEvent register indicates which contexts have interrupted. See section 6.2.4.
postedWriteErr	8	rscu	Indicates that a host bus error occurred while the Host Controller was trying to write a 1394 write request, which had already been given an ack_complete, into system memory. The 1394 destination offset and sourceID are available in the PostedWriteAddress registers described in section 12.3.
reserved	9-15		
selfIDcomplete	16	rscu	A selfID packet stream has been received. Will be generated at the end of the bus initialization process.
busReset	17	rscu	Indicates that the PHY chip has entered bus reset mode. See section 6.2.1.1 below for information on when to clear this interrupt.
reserved	18		
phy	19	rscu	Generated when the PHY requests an interrupt through a status transfer.
cycleSynch	20	rscu	Indicates that a new isochronous cycle has started. Set when the low order bit of the cycle count toggles.

Table 6-1 — IntEvent register description (Sheet 2 of 2)

Field	Bit #	rscu	Description
cycle64Seconds	21	rscu	Indicates that the 7th bit of the cycle second counter has changed.
cycleLost	22	rscu	Indicates that an expected cycle start has not been received. This will be set whenever a cycle start is not received immediately after the first subaction gap after the cycleSynch event, or if an arbitration reset gap is detected after a cycleSynch event without an intervening cycle start.
cycleInconsistent	23	rscu	A cycle start was received that had a cycle count different from the value in the CycleTimer register.
unrecoverableError	24	rscu	This event occurs when the Host Controller encounters any error that forces it to stop operations on any or all of its subunits. For example, when a DMA context sets its contextControl. <i>dead</i> bit. While unrecoverableError is set, all normal interrupts for each causal context will be blocked from being set.
cycleTooLong	25	rscu	If LinkControl. <i>cycleMaster</i> is set, this indicates that over 125 usec elapsed between the start of sending a cycle start packet and the end of a subaction gap. LinkControl. <i>cycleMaster</i> is cleared by this event.
phyRegRcvd	26	rscu	The 1394 Open HCI has received a PHY register data byte which can be read from the PHY control register (see 5.10).
<i>reserved</i>	27-29		
vendorSpecific	30		Vendor defined.
<i>reserved</i>	31		

6.2.1.1 busReset

When a bus reset occurs and the busReset interrupt is raised, software must wait for both asynchronous transmit contexts (request and response) to have contextControl.*active* = 0 before clearing the interrupt condition. This is to ensure that all queued asynchronous packets (with potentially stale node numbers) are flushed. Once they are no longer active, software may clear the busReset interrupt condition, and hardware will discontinue flushing of the asynchronous transmit FIFO(s). See section 7.2.2.1 for further details.

6.2.2 IntMask (set and clear)

The bits in the IntMask register have the same format as the IntEvent register, with the addition of masterIntEnable (bit 31). A one bit in the IntMask register enables the corresponding IntEvent register bit to generate a processor interrupt. A zero bit in IntMask disables the corresponding IntEvent register bit from generating a processor interrupt. A bit is set in the IntMask register by writing a one to the corresponding bit in the IntMaskSet address and cleared by writing a one to the corresponding bit in the IntMaskClear address.

If masterIntEnable is 0, all interrupts are disabled regardless of the values of all other bits in the IntMask register. The value of masterIntEnable has no effect on the value returned by reading the IntEventClear; even if masterIntEnable is 0, reading IntEventClear will return (IntEvent & IntMask) as described earlier in section 6.2.1.

On a reset, the *IntMask.masterIntEnable* bit (31) is set to 0 and the values of all other bits is undefined.

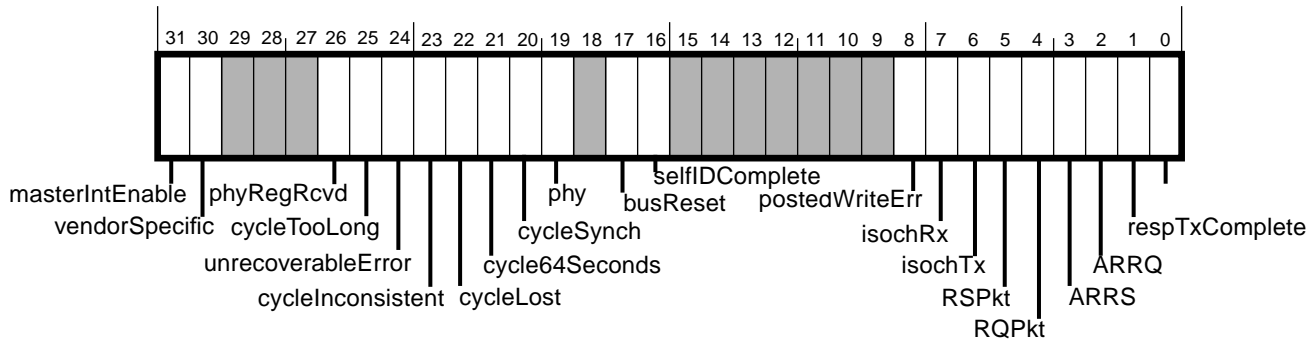

Figure 6-2 — IntMask register

Table 6-2 — IntMask register description

Field	Bit #	rscu	Description	
reqTxComplete	0	rsc	See Table 6-1.	
respTxComplete	1	rsc		
ARRQ	2	rsc		
ARRS	3	rsc		
RQPkt	4	rsc		
RSPkt	5	rsc		
isochTx	6	rsc		
isochRx	7	rsc		
postedWriteErr	8	rsc		
<i>reserved</i>	9-15			
selfIDcomplete	16	rsc		
busReset	17	rsc		
<i>reserved</i>	18			
phy	19	rsc		
cycleSynch	20	rsc		
cycle64Seconds	21	rsc		
cycleLost	22	rsc		
cycleInconsistent	23	rsc		
unrecoverableError	24	rsc		
cycleTooLong	25	rsc		
phyRegRcvd	26	rsc		
<i>reserved</i>	27-29			
vendorSpecific	30			Vendor defined.
masterIntEnable	31	rsc		If set, external interrupts will be generated in accordance with the IntMask register. If clear, no external interrupts will be generated regardless of the IntMask register settings.

6.2.3 IsochTx interrupt registers

There are two 32-bit registers to report isochronous transmit context interrupts: isoXmitIntEvent and isoXmitIntMask. Both registers have two addresses: a “Set” address and a “Clear” address. For a write to either register, a “one” bit written to the “Set” address causes the corresponding bit in the register to be set, while a “one” bit written to the “Clear” address causes the corresponding bit to be cleared. For all four addresses, writing a “zero” bit has no effect on the corresponding bit in the register.

The isoXmitIntEvent register contains the actual interrupt request bits. Each of these bits corresponds to a DMA completion event for the indicated isochronous transmit context. The isoXmitIntMask register is ANDed with the isoXmitIntEvent register to enable selected bits to generate processor interrupts. If (isoXmitIntMask & isoXmitIntEvent) is not zero, then the IntEvent.isoChTx bit will be set to one, and if enabled via the IntMask register it will generate a processor interrupt. A software write to the isoXmitIntEventSet register can therefore cause an interrupt (if not otherwise masked). A software write to the isoXmitIntEventClear register will clear interrupt conditions reported in the isoXmitIntEvent register.

Reading the isoXmitIntEventSet register returns the current state of the isoXmitIntEvent register. Reading the isoXmitIntEventClear register returns the *masked* version of the isoXmitIntEvent register (isoXmitIntEvent & isoXmitIntMask).

6.2.3.1 isoXmitIntEvent (set and clear)

This register reflects the interrupt state of the isochronous transmit contexts. An interrupt is generated on behalf of an isochronous transmit context if an OUTPUT_LAST DMA command completes and its *i* bits are set to 2'b11 (interrupt always). Upon determining that the IntEvent.isoChTx interrupt has occurred, software can check the isoXmitIntEvent register to determine which context(s) caused the interrupt.

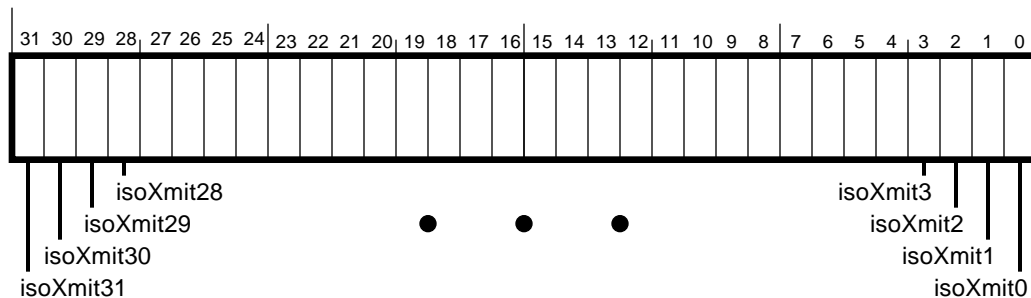

Figure 6-3 — isoXmitIntEvent (set and clear) register

On a hardware reset or soft reset, values of all bits in this register are undefined.

6.2.3.2 isoXmitIntMask (set and clear)

The bits in the isoXmitIntMask register have the same format as the isoXmitIntEvent register. Setting a bit in this register enables the corresponding bit in the isoXmitIntMaskSet address and cleared by writing a one to the corresponding bit in the isoXmitIntMaskClear address.

Bits for all unimplemented contexts must read as 0’s. Software can use this register to determine which contexts are supported by writing to it with all 1’s, then reading it back. Contexts with a 1 are implemented, and those with a 0 are not.

On a hardware reset or soft reset, values for all bits in this register are undefined.

6.2.4 IsochRx interrupt registers

There are two 32-bit registers to report isochronous receive context interrupts: isoRecvIntEvent and isoRecvIntMask. Both registers have two addresses: a “Set” address and a “Clear” address. For a write to either register, a “one” bit written to the “Set” address causes the corresponding bit in the register to be set, while a “one” bit written to the “Clear” address causes the corresponding bit to be cleared. For all four addresses, writing a “zero” bit has no effect on the corresponding bit in the register.

The isoRecvIntEvent register contains the actual interrupt request bits. Each of these bits corresponds to a DMA completion event for the indicated isochronous receive context. The isoRecvIntMask register is ANDed with the isoRecvIntEvent register to enable selected bits to generate processor interrupts. If (isoRecvIntMask & isoRecvIntEvent) is not zero, then the IntEvent.isoChRx bit will be set to one, and if enabled via the IntMask register it will generate a processor interrupt. A software write to the isoRecvIntEventSet register can therefore cause an interrupt (if not otherwise masked). A software write to the isoRecvIntEventClear register will clear interrupt conditions reported in the isoRecvIntEvent register.

Reading the isoRecvIntEventSet register returns the current state of the isoRecvIntEvent register. Reading the isoRecvIntEventClear register returns the *masked* version of the isoRecvIntEvent register (*isoRecvIntEvent & isoRecvIntMask*).

6.2.4.1 isoRecvIntEvent (set and clear)

This register reflects the interrupt state of the isochronous receive contexts. An interrupt is generated on behalf of an isochronous receive context if an INPUT_LAST DMA command completes and its *i* bits are set to 2'b11 (interrupt always). Upon determining that the IntEvent.isoChRx interrupt has occurred, software can check the isoRecvIntEvent register to determine which context(s) caused the interrupt.

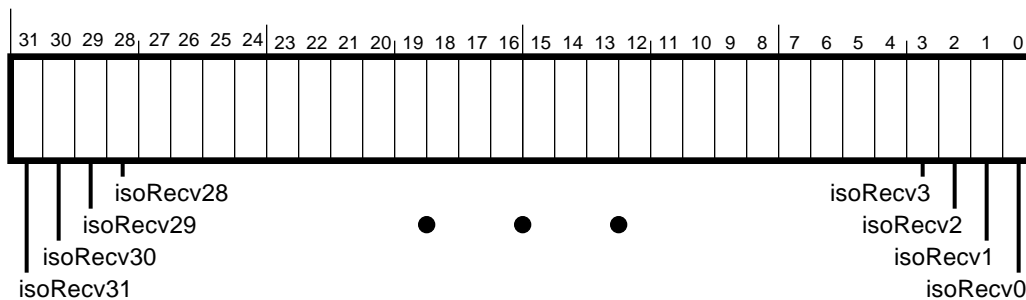

Figure 6-4 — isoRecvIntEvent (set and clear) register

On a hardware reset or soft reset, values of all bits in this register are undefined.

6.2.4.2 isoRecvIntMask (set and clear)

The bits in the isoRecvIntMask register have the same format as the isoRecvIntEvent register. Setting a bit in this register enables the corresponding bit in the isoRecvIntMaskSet address and cleared by writing a one to the corresponding bit in the isoRecvIntMaskClear address.

Bits for all unimplemented contexts must read as 0’s. Software can use this register to determine which contexts are supported by writing to it with all 1’s then reading it back. Contexts with a 1 are implemented, and those with a 0 are not.

On a hardware reset or soft reset, values of all bits in this register are undefined.

7. Asynchronous Transmit DMA

The 1394 OpenHCI divides the transmission of asynchronous packets into three categories: asynchronous requests, asynchronous responses, and physical responses. This chapter describes how to use DMA to transmit asynchronous requests and asynchronous responses. For information regarding physical responses, see section 12., “Physical Requests.”

There is one DMA controller for each transmit context: the Asynchronous Transmit (AT) Request Controller for the AT request context, and the AT Response Controller for the AT response context. Although OpenHCI does not specify how many FIFOs are required to support the AT DMA controllers, it is required that the re-transmission of request packets never blocks the transmission of response packets.

The AT Request context is used by software to transmit read, write and lock request packets and the AT Response context is used to send response packets to read, write, and lock requests that have earlier been received into the asynchronous receive request context buffers (see section 8., “Asynchronous Receive DMA.”).

Each context consists of a context program and two registers. A context program is a list of commands for that context which direct the Host Controller on how to assemble packets for transmission. The DMA controller for that context executes each command, inserting data into the appropriate FIFO and interrupting as requested.

The following sections describe how to set up and manage an AT DMA context program and describe the data formats for the various asynchronous request and response packet types.

7.1 Asynchronous transmit DMA context programs

Each asynchronous transmit packet, whether a request or response packet, shall be described by a contiguous list of command descriptors referred to as a *descriptor block*. A chain of descriptor blocks is referred to as a context program. There are four different command descriptors that can be used within each descriptor block: OUTPUT_MORE, OUTPUT_MORE-Immediate, OUTPUT_LAST and OUTPUT_LAST-Immediate. In the descriptions that follow, OUTPUT_MORE* refers to both the OUTPUT_MORE and OUTPUT_MORE-Immediate commands, OUTPUT_LAST* refers to both the OUTPUT_LAST and OUTPUT_LAST-Immediate commands and *-Immediate refers to both the OUTPUT_MORE-Immediate and OUTPUT_LAST-Immediate commands.

Each packet shall be specified in one descriptor block. A descriptor block may have either one single OUTPUT_LAST-Immediate descriptor, or may have one OUTPUT_MORE-Immediate descriptor followed by zero to five OUTPUT_MORE descriptors, followed by one OUTPUT_LAST descriptor. This allows software to combine up to eight fragments to specify a single packet. In addition, the first command descriptor in a descriptor block must be one of the *-Immediate commands to transmit the full 1394 packet header for the packet’s tcode type, where *packet header* is defined as all quadlets that appear before the 1394 packet header CRC quadlet and that are required by the respective packet format (defined in section 7.5). Further, a descriptor block for a packet shall not exceed 128 bytes. The OUTPUT_MORE and OUTPUT_LAST command descriptors are 16-bytes in length, and the *-Immediate descriptors are 32-bytes in length. All descriptors must be aligned on a 16-byte boundary.

In the sections below, the format for each command descriptor is shown. The shaded fields are reserved and should be set to 0 by software. Fields with a hardcoded value must be set to that value by software. The values of all other fields are described in each command’s descriptor element summary.

7.1.1 OUTPUT_MORE descriptor

The OUTPUT_MORE command descriptor is used to specify a host memory buffer from which the AT DMA controller will insert bytes into the appropriate transmit FIFO. It has the following format.

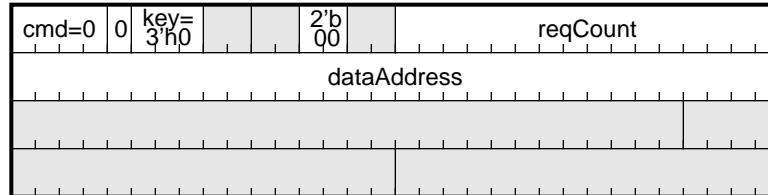

Figure 7-1 — OUTPUT_MORE descriptor format

Table 7-1 — OUTPUT_MORE descriptor element summary

Element	Bits	Description
cmd	4	Set to 4'h0 for OUTPUT_MORE.
s	1	Status control. Must be set to 0.
key	3	Set to 3'h0 for OUTPUT_MORE.
b	2	Branch control. Software must set this field to 2'b00. Values of 2'b11, 2'b10, 2'b01 will result in unspecified behavior.
reqCount	16	Request Count: The number of transmit packet bytes starting at dataAddress.
dataAddress	32	Address of transmit data.

7.1.2 OUTPUT_MORE_Immediate descriptor

The OUTPUT_MORE-Immediate command descriptor is used to four quadlets of packet header information to be inserted into the appropriate transmit FIFO. It has the following format.

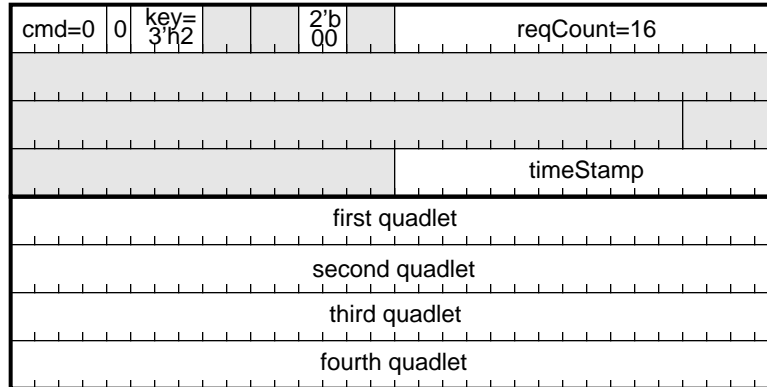

Figure 7-2 — OUTPUT_MORE-Immediate descriptor format

Table 7-2 — OUTPUT_MORE-Immediate descriptor element summary

Element	Bits	Description
cmd	4	Set to 4'h0 for OUTPUT_MORE-Immediate
s	1	Status control. Must be set to 0.
key	3	Set to 3'h2 for OUTPUT_MORE-Immediate.
b	2	Branch control. Software must set this field to 2'b00. Values of 2'b11, 2'b10, 2'b01 will result in unspecified behavior.
reqCount	16	Request Count: The number of transmit packet bytes immediately following the 16th byte of this descriptor. This value must be 16(four quadlets). Specifying any other value will result in unspecified behavior. This descriptor is always 32 bytes long.
timeStamp	16	Valid only in the AT <u>response</u> context. This field contains the three low order bits of cycleSeconds and all 13 bits of cycleCount. See section 5.11, "Isochronous Cycle Timer Register," for information about these fields. For AT <u>response</u> packets, timeStamp indicates a time after which the packet should not be transmitted. For further information on the use of this field, see section 7.1.5.3 below.
first, second, third, and fourth quadlets	128	Data quadlets to be inserted into the applicable FIFO.

The OUTPUT_MORE-Immediate command shall only be used to specify the four quadlet 1394 transmit packet header for a block payload or lock packet. All OUTPUT_MORE-Immediate command descriptors are 32-bytes in length.

7.1.3 OUTPUT_LAST descriptor

The OUTPUT_LAST command descriptor is used to specify a host memory buffer from which the AT DMA controller will insert bytes into the appropriate transmit FIFO. This command indicates the end of a packet to the Host Controller. It has the following format.

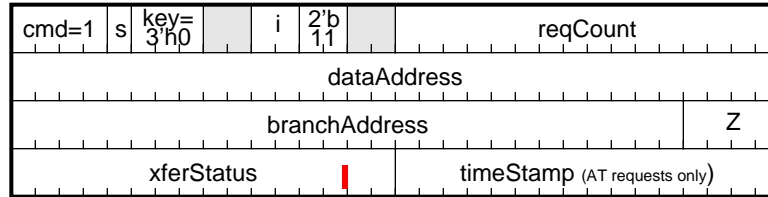

Figure 7-3 — OUTPUT_LAST descriptor format

Table 7-3 — OUTPUT_LAST descriptor element summary

Element	Bits	Description
cmd	4	Set to 4'h1 for OUTPUT_LAST.
s	1	Status control. Controls update of xferStatus and resCount after descriptor is processed (update if s = 1).
key	3	Set to 3'h0 for OUTPUT_LAST.
i	2	Interrupt control. Options: 2'b11 - Always interrupt upon command completion. 2'b01 - Interrupt only if did not receive an ack_complete or ack_pending. See table 3-2 for a list of possible ack and evt values. 2'b00 - Never interrupt. Specifying a value of 2'b10 will result in unspecified behavior.
b	2	Branch control. Software must set this field to 2'b11. Values of 2'b10, 2'b01, and 2'b00 will result in unspecified behavior.
reqCount	16	Request Count: The number of transmit packet bytes described by this descriptor, beginning at dataAddress.
dataAddress	32	Address of transferred data.
branchAddress	28	16-byte aligned address of the next descriptor. A valid host memory address must be provided in this field unless the Z field is 0.
Z	4	This field indicates the number of 16-byte command blocks that comprise the next packet. If this is the last descriptor in the list, the Z value must be 0. Otherwise, valid values are 2 to 8. Note that each *-Immediate command descriptor is counted as two 16-byte blocks and each non-immediate command is counted as one 16-byte block.
xferStatus	16	Written with ContextControl [15:0] after descriptor is processed (if s = 1).
timeStamp	16	This field contains the three low order bits of cycleSeconds and all 13 bits of cycleCount. See section 5.11, "Isochronous Cycle Timer Register," for information about these fields. For AT <u>request</u> packets, timeStamp is a software read-only value written by hardware if status is enabled (s=1) and indicates the transmission time of the packet. For AT <u>response</u> packets, timeStamp is not valid (it is only valid in the first descriptor of a response descriptor block.) For further information on the use of the timeStamp field, see section 7.1.5.3.

7.1.4 OUTPUT_LAST_Immediate descriptor

The OUTPUT_LAST-Immediate command descriptor is used to specify two to four quadlets of packet header information to be inserted into the appropriate transmit FIFO. This command indicates the end of a packet to the Host Controller. It has the following format.

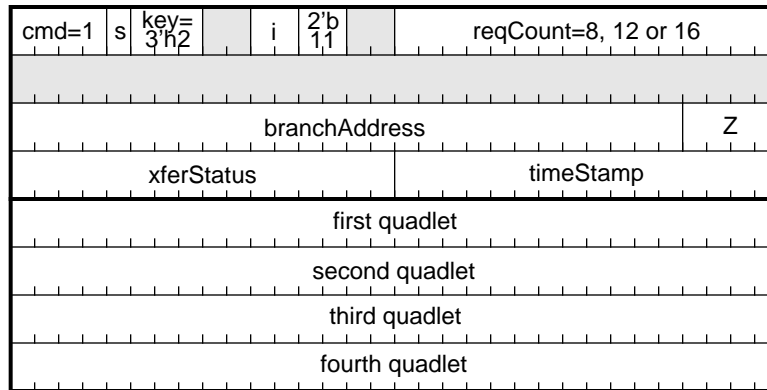

Figure 7-4 — OUTPUT_LAST-Immediate descriptor format

Table 7-4 — OUTPUT_LAST-Immediate descriptor element summary

Element	Bits	Description
cmd	4	Set to 4'h1 for OUTPUT_LAST-Immediate.
s	1	Status control. Controls update of xferStatus and resCount after descriptor is processed (update if s = 1).
key	3	Set to 3'h2 for OUTPUT_LAST-Immediate.
i	2	Interrupt control. Options: 2'b11 - Always interrupt upon command completion. 2'b01 - Interrupt only if did not receive an ack_complete or ack_pending. See table 3-2 for a list of possible ack and evt values. 2'b00 - Never interrupt. Specifying a value of 2'b10 will result in unspecified behavior.
b	2	Branch control. Software must set this field to 2'b11. Values of 2'b10, 2'b01, and 2'b00 will result in unspecified behavior.
reqCount	16	Request Count: The number of transmit packet bytes immediately following the 16th byte of this descriptor. Valid values are 4 (one quadlet), 8(two quadlets) and 12(three quadlets). Specifying any other values will result in unspecified behavior. Regardless of the reqCount value, this descriptor is always 32 bytes long.
branchAddress	28	16-byte aligned address of the next descriptor. A valid host memory address must be provided in this field unless the Z field is 0.
Z	4	This field indicates the number of 16-byte command blocks that comprise the next packet. If this is the last descriptor in the list, the Z value must be 0. Otherwise, valid values are 2 to 8. Note that each *-Immediate command descriptor is counted as two 16-byte blocks and each non-immediate command is counted as one 16-byte block.
xferStatus	16	Written with ContextControl [15:0] after descriptor is processed if s = 1.

Table 7-4 — OUTPUT_LAST-Immediate descriptor element summary

Element	Bits	Description
timeStamp	16	This field contains the three low order bits of cycleSeconds and all 13 bits of cycleCount. See section 5.11, “Isochronous Cycle Timer Register,” for information about these fields. For AT <i>response</i> packets, timeStamp indicates a time after which the packet should not be transmitted. For AT <i>request</i> packets, timeStamp is a software read-only value written by hardware if status is enabled ($s = 1$) and indicates the transmission time of the packet. For further information on the use of the timeStamp field, see section 7.1.5.3 below.
first, second, third, and fourth quadlets	128	Data quadlets to be inserted into the applicable FIFO.

The OUTPUT_LAST-Immediate command will be used to specify information that is protected by the header CRC or for sending a PHY packet. OUTPUT_LAST-Immediate command descriptors are 32-bytes in length regardless of the value of reqCount.

7.1.5 AT command descriptor usage

Fields in the command descriptor are further described below.

7.1.5.1 Command.Z

The Z value is used by the Host Controller to enable several descriptors to be fetched at once, for improved efficiency. Z values must always be encoded correctly. The contiguous descriptors described by a Z value are called a *descriptor block*. The following table summarizes all legal Z values:

Table 7-5 — Z value encoding

Z value	Use
0	Indicates that the current descriptor is the last descriptor in the context program.
1	reserved. (Since all descriptor blocks must start with a *-Immediate command, they are by definition a minimum of two 16-byte blocks in size.)
2-8	Indicates that two to eight 16-byte command descriptors starting at branchAddress are physically contiguous and specify a single packet. Note that the 32-byte *-Immediate command descriptors must be counted as two 16-byte command descriptors when calculating the Z value.
9-15	reserved

A single packet that is to be transmitted must be entirely described by one descriptor block. This requirement permits the Host Controller to prefetch all the descriptors for a packet, in order to avoid fetching additional descriptors during a packet transfer. The branch address+Z allows the Host Controller to learn the Z value of the next block. Only the OUTPUT_LAST* descriptor shall specify a branch address+Z for the next packet. BranchAddress+Z values are ignored in all OUTPUT_MORE* descriptors, and should not be specified.

All DMA context programs must use a Z = 0 command to indicate the end of the program. A program which ends in Z=0 can be appended to while the DMA runs, even if the DMA has already reached the end. The mechanism for doing this is described in section 3.2.1.2.

7.1.5.2 Command.xferStatus

Upon the completion of an OUTPUT_LAST* descriptor, the 16 least significant bits of the current contents of the DMA ContextControl register are written to the completed descriptor’s Command.xferStatus field, if the Command.s bit is one. See section 7.2.2 for the contents of this field.

7.1.5.3 Command.timeStamp

The timeStamp field is encoded as follows:

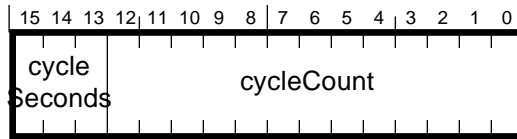

Figure 7-5 — timeStamp format

Table 7-6 — timeStamp description

Field	Bits	Description
cycleSeconds	3	Low order three bits of the seven-bit isochronous cycle timer second count. Possible values are 0 to 7.
cycleCount	13	Full 13 bits of the 13-bit isochronous cycle timer cycle count. Possible values are 0 to 7999.

7.1.5.3.1 timeStamp value for Requests

Asynchronous transmit request packets may initiate a transaction which should complete by a specific time. So that host software will know when the transaction began, the Host Controller will update the timeStamp value in all OUTPUT_LAST* descriptors whose Command.s bit is one at the time when the ack is received. TimeStamp is written in the same bus operation in which xferStatus is written.

Note that a transmit request packet may sit in the transmit FIFO for some time before the PHY wins normal arbitration. This delay is usually brief, but could be over 200 cycles (over 25 milliseconds) in the case of a bus with 80% isochronous traffic and 63 nodes each sending maximum-size async packets as often as possible.

7.1.5.3.2 timeStamp value for Responses

Typically, asynchronous transmit response packets expire at a certain time, and should not be transmitted after that time. A timeStamp value can be placed in the first OUTPUT_* descriptor for such packets.

The timeStamp used for asynchronous transmit contains a 3-bit seconds field and a 13-bit cycle number which counts modulo 8000. Before an asynchronous response is put into the transmit FIFO, whether for the initial transmission attempt or for a retry attempt, this timeStamp value is compared to the current cycleTimer. This comparison is used to determine whether or not the packet will be sent or rejected as being too old.

The comparison is broken into two parts. The first compare is done on the seconds field of the timeStamp and the low order three bits of the seconds field in the cycleTimer. The low three bits of the cycleTime is subtracted from the timeStamp.seconds field using three bit arithmetic. If the most significant bit of the subtraction is 1, then the timeStamp is considered 'late' and the packet is rejected. If the most significant bit is 0 but the other two bits are not 0, then the timeStamp is considered to be for some time in the 'distant' future and the packet can be sent. If the difference is 0, then the timeStamp and cycleTimer are referring to the same second so the cycle number portion of the timeStamp is compared to the cycle number portion of the cycleTimer to determine if the cycle is early, late or matches. This comparison is done

by subtracting the cycleTimer cycle number from the timeStamp cycle number. If the result is negative, then the time for the packet has passed and the packet is rejected. If the difference is positive and the timeout value is positive or zero, then the packet can be sent. This subtraction is signed so a sign bit is assumed to be prepended to both cycle number values.

Table 7-7 — Results of timeStamp.cycleSeconds - cycleTimer.cycleSeconds

timeStamp.seconds	cycleTimer.seconds							
	000	001	010	011	100	101	110	111
000	000	111	110	101	100	011	010	001
001	001	000	111	110	101	100	011	010
010	010	001	000	111	110	101	100	011
011	011	010	001	000	111	110	101	100
100	100	011	010	001	000	111	110	101
101	101	100	011	010	001	000	111	110
110	110	101	100	011	010	001	000	111
111	111	110	101	100	011	010	001	000

NOTE: Shaded entries denote 'late' values.

For those entries in the table above which are 000, the cycleTimer.cycleCount field is subtracted from the timeStamp.cycleCount field. If the result is positive or 0, it indicates that the packet can be sent. If the result is negative the packet cannot be sent and the status error code is set to evt_timeout.

Table 7-8 — timeStamp.cycleCount-cycleTime.cycleCount Example 1

timeStamp.cycleCount	cycleTime.cycleCount	difference	action
14'h0FA0	14'h0F9E	14'h0002	send packet
14'h0FA0	14'h0F9F	14'h0001	send packet
14'h0FA0	14'h0FA0	14'h0000	send packet
14'h0FA0	14'h0FA1	14'h3FFF	reject packet

Table 7-9 — timeStamp.cycleCount-cycleTime.cycleCount Example 2

timeStamp.cycleCount	cycleTime.cycleCount	difference	action
14'h1000	14'h0FFE	14'h0002	send packet
14'h1000	14'h0FFF	14'h0001	send packet
14'h1000	14'h1000	14'h0000	send packet
14'h1000	14'h1001	14'h3FFF	reject packet

Table 7-10 — timeStamp.cycleCount-cycleTime.cycleCount Example 3

timeStamp.cycleCount	cycleTime.cycleCount	difference	action
14'h0000	14'h0000	14'h0000	send packet
14'h0000	14'h0001	14'h3FFF	reject packet
...
14'h0000	14'h1000	14'h3000	reject packet
14'h0000	14'h1001	14'h2FFF	reject packet

Table 7-10 — timeStamp.cycleCount-cycleTime.cycleCount Example 3

timeStamp.cycleCount	cycleTime.cycleCount	difference	action
...
14'h0000	14'h1F3E	14'h20C2	reject packet
14'h0000	14'h1F3F	14'h20C1	reject packet

After a transmit packet has passed the timeStamp check, it may sit in the transmit FIFO for some time before the PHY wins normal arbitration. The Host Controller does not re-examine the timeStamp while the packet waits, even if the descriptor is still active because only part of the packet fits into the FIFO. This delay is usually brief, but could be over 200 cycles (over 25 milliseconds) in the case of a bus with 80% isochronous traffic and 63 nodes each sending maximum-size async packets as often as possible.

Software can compute the worst-case FIFO delay based on knowledge of the current node count and the current (or maximum) isochronous load. Software can use this delay to compute an earlier expiration timeStamp to prevent late transmission due to FIFO delay. Using the maximum (not current) isochronous load is advisable, because additional isochronous reservations could be made while the packet is waiting in the transmit FIFO.

Because the Host Controller examines the timeStamp before the packet is loaded into the transmit FIFO, and because the packet may remain in the FIFO for some period until the PHY attached to the Host Controller wins normal arbitration, it is not possible to guarantee that the packet will not be transmitted after it expires. The maximum time the packet waits in the FIFO can be computed by software based on dynamic bus parameters, and this time can be factored into the packet's expiration timeStamp. (Note, this could be over 200 cycles, in unlikely case where 80% of the bus is isochronous, and 63 nodes are each sending maximum-size async packets.)

7.2 AT DMA context registers

Each AT DMA context (request and response) has two registers: CommandPtr and ContextControl. CommandPtr is used by software to tell the Host Controller where the DMA context program begins. ContextControl is used by software to control the context's behavior, and is used by hardware to indicate current status.

7.2.1 CommandPtr

The CommandPtr register specifies the address of the context program which will be executed when a DMA context is started. All descriptors are 16-byte aligned, so the four least-significant bits of any descriptor address must be zero. The four least-significant bits of the CommandPtr register are used to encode a Z value that indicates how many physically contiguous descriptors are pointed to by descriptorAddress.

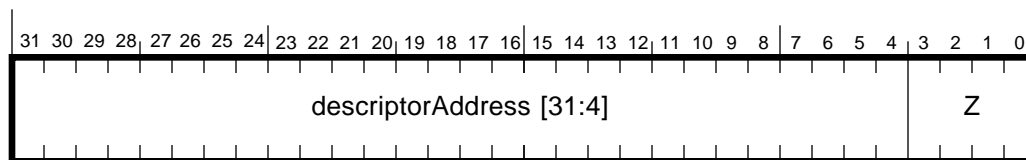
**Figure 7-6 — CommandPtr register format**

Refer to Section 3.1.5 for a complete description of the CommandPtr register.

7.2.2 ContextControl register (set and clear)

The *ContextControlSet* and *ContextControlClear* registers contain bits that control options, operational state, and status for a DMA context. Software can set selected bits by writing ones to the corresponding bits in the *ContextControlSet* register. Software can clear selected bits by writing ones to the corresponding bits in the *ContextControlClear* register. It is not possible for software to set some bits and clear others in an atomic operation. A read from either register will return the same value.

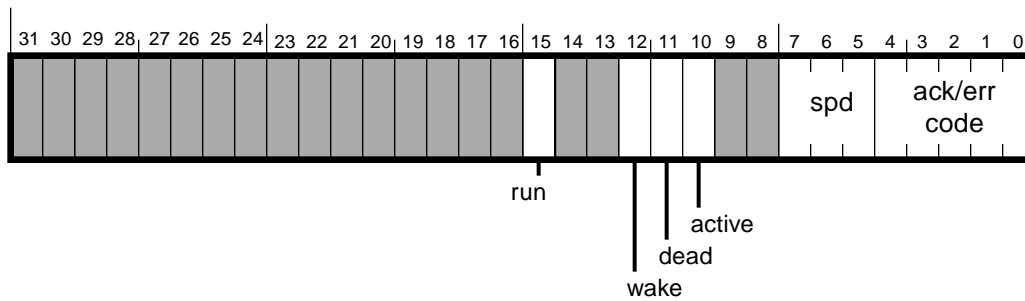

Figure 7-7 — ContextControl (set and clear) register format

Table 7-11 — ContextControl (set and clear) register description

Field	rsci	Description
run	rscu	Refer to section 3.1.1 for an explanation of the contextControl. <i>run</i> bit.
wake	rsu	Refer to section 3.1.2 for an explanation of the contextControl. <i>wake</i> bit.
dead	ru	Refer to section 3.1.4 for an explanation of the contextControl. <i>dead</i> bit.
active	ru	Refer to section 3.1.3 for an explanation of the contextControl. <i>active</i> bit.
spd	ru	This field is not meaningful for asynchronous transmit contexts.
ack/err code	ru	Following an OUTPUT_LAST* command, the received ack_code or an “evt_” error code is indicated in this field. Possible values are: ack_complete, ack_pending, ack_busy_X, ack_busy_A, ack_busy_B, ack_data_error, ack_type_error, evt_tcode_err, evt_missing_ack, evt_underrun, evt_descriptor_read, evt_data_read, evt_timeout, evt_flushed and evt_unknown. See Table 3-2, “Packet event codes,” for descriptions and values for these codes.

7.2.2.1 Bus Reset

When a bus reset occurs, the Host Controller will flush the asynchronous transmit FIFO(s) until the busReset interrupt condition is cleared. While packets are being flushed, the link side of the FIFO returns evt_flushed. Software must make sure however that IntEvent.*busReset* is not cleared until 1) software has cleared the ContextControl.run bits for both Asynchronous Transmit contexts, and 2) both Asynchronous Transmit contexts have quiesced and both contextControl.active fields are zero. This is to ensure that all queued asynchronous packets (with potentially stale node numbers) are flushed. Once the contexts are no longer active, software may clear the busReset interrupt condition, and hardware will stop flushing the asynchronous transmit FIFO(s).

7.2.2.2 Writing status back to context command descriptors

Upon OUTPUT_LAST* completion, if the command's *s* bit is set to one, bits 15-8 of the contextControl register are written to the command's *xferStatus* field. When Command.*xferStatus* is written to memory, the active bit is always one. If software prepared the descriptor's *xferStatus.active* bit to be zero, this change indicates that the descriptor has been executed, and the *xferStatus* and *timeStamp* fields have been updated.

7.3 AT Retries

The Host Controller will retry busied asynchronous transmit request and response packets based on the configuration of the AT Retries register.

For the Asynchronous Transmit Response context, the initial transmission of a response packet is not required to wait for a fairness interval. However, if a response packet needs to be retried the Host Controller must wait for a fairness interval and therefore all other response packets (including physical responses) are blocked. In addition, each time a response packet is retried the descriptor block's timestamp value must be checked to ensure that the packet has not expired.

For a detailed description of the ATRetries register see section 5.4.

7.4 AT Interrupts

Each asynchronous DMA controller/context has one interrupt indication bit in the intEvent register (section 6.2.1). For requests, it is the *reqTx* bit and for responses it is the *respTx* bit. This interrupt indication bit will be set to one if a completed OUTPUT_LAST* command has the *i* field set to 2'b11, or if the *i* field is set to 2'b01 and transmission of the packet did not yield an *ack_complete* or an *ack_pending*.

7.5 AT Data Formats

There are four basic formats for asynchronous data to be transmitted:

- a) no-data packets (used for quadlet read requests and all write responses)
- b) quadlet packets (used for quadlet write requests, quadlet read responses and block read requests)
- c) block packets (used for lock requests and responses, block write requests and block read responses)
- d) PHY packets

All formats are shown below in two sections, one for asynchronous request formats and one for asynchronous response formats.

Note that packets to go out over the 1394 wire are constructed from these Host Controller internal formats, and are not sent in the exact order as shown below. For example, *destinationID* is transmitted in the first quadlet, and *source ID* is automatically provided and transmitted in the second quadlet.

7.5.1 Asynchronous Transmit Requests

7.5.1.1 No-data transmit

The no-data request transmit format is shown below. The first word contains packet control information. The second and third words contain 16-bit destination ID and either the 48-bit, quadlet-aligned destination offset (for requests) or the response code (for responses).

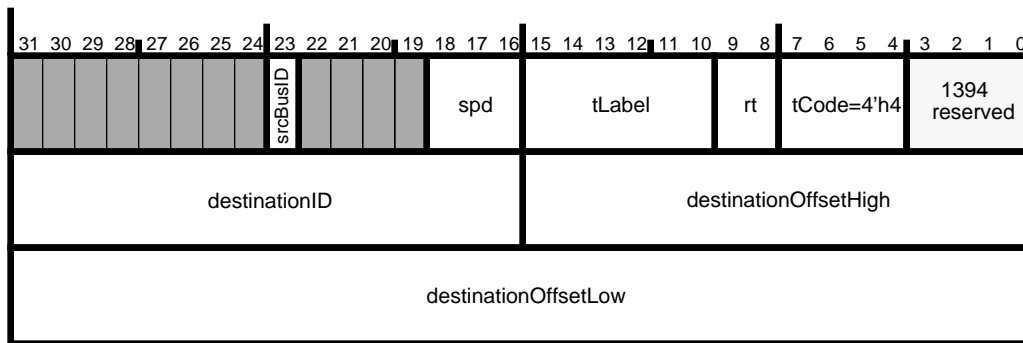

Figure 7-8 — Quadlet read request transmit format

Table 7-12 — Quadlet read request transmit fields

field name	bits	description
srcBusID	1	Source bus ID selector. If clear, the high order 10 bits of the source_ID field of the transmitted packet will be 10'h3FF. If set, the high order 10 bits of the source_ID field of the transmitted packet will be busNumber.Node_ID (see section 5.9).
spd	3	This field indicates the speed at which this packet is to be sent. 000 = 100 Mbits/sec, 001 = 200 Mbits/sec, and 010 = 400 Mbits/sec, other values are reserved.
tLabel	6	This field is the transaction label, which is used to pair up a response packet with its corresponding request packet.
rt	2	The retry code for this packet. Must be 2'h01 == retryX for the 1394 Open HCI.
tCode	4	The transaction code for this packet.
1394 reserved		Required by IEEE 1394-1995 to be all zeros. OpenHCI will pass these bits along as-is and will not verify or modify them.
destinationID	16	This is the concatenation of the 10-bit bus number and the 6-bit node number for the destination of this packet.
destinationOffsetHigh, destinationOffsetLow	16 32	The concatenation of these two fields addresses a quadlet in the destination node's address space. This address must be quadlet-aligned (modulo 4).

7.5.1.2 Quadlet Transmit

The quadlet request transmit formats are shown below. The first word contains packet control information. The second and third words contain 16-bit destination ID and the 48-bit, quadlet-aligned destination offset. The fourth word is the quadlet data for write quadlet requests, and is the data length and reserved for block read requests.

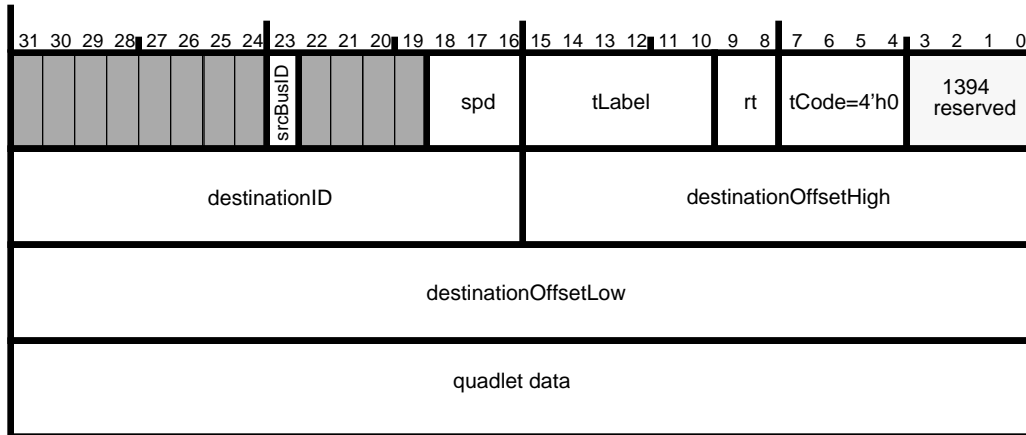

Figure 7-9 — Quadlet write request transmit format



Figure 7-10 — Block read request transmit format

Table 7-13 — Quadlet transmit fields

field name	bits	description
srcBusID, spd, tLabel, rt, tCode, 1394 reserved, destinationID, destinationOffsetHigh, destinationOffsetLow		See Table 7-12.

Table 7-13 — Quadlet transmit fields (Continued)

field name	bits	description
quadlet data	32	For quadlet write requests and quadlet read responses this field holds the data to be transferred.
dataLength	16	The number of bytes requested in a block read request.

7.5.1.3 Block transmit

The block request transmit formats are shown below. The first word contains packet control information. The second and third words contain the 16-bit destination node ID and the 48-bit destination offset. The fourth word contains the length of the data field and the extended transaction code (all zeros except for lock transactions). The block data, if any, follows the extended code.

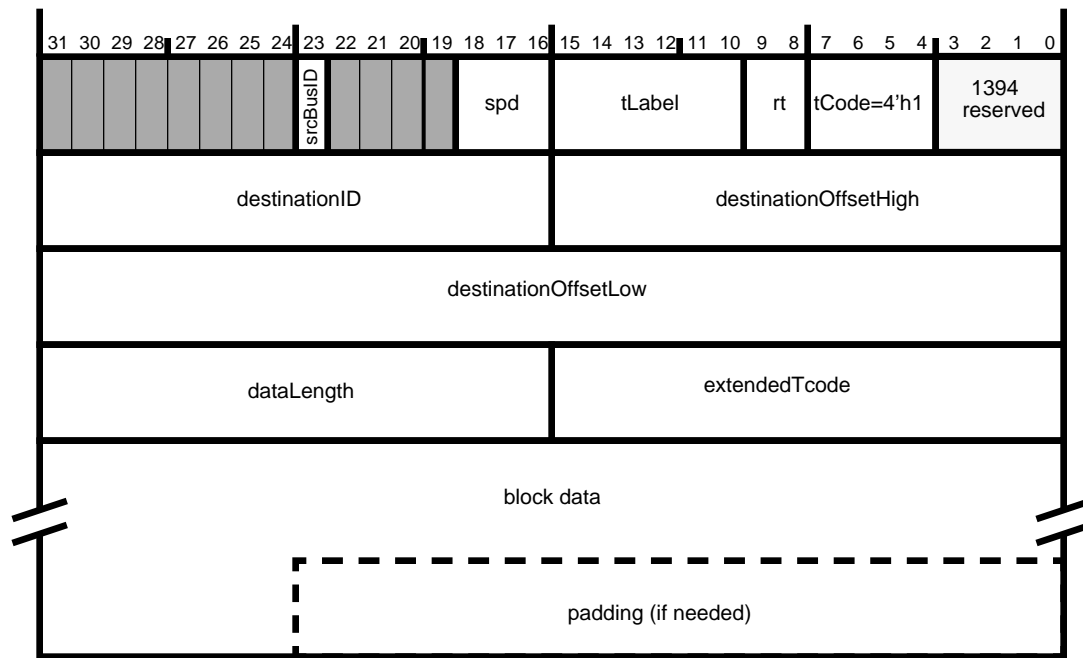
**Figure 7-11 — Write request transmit format**

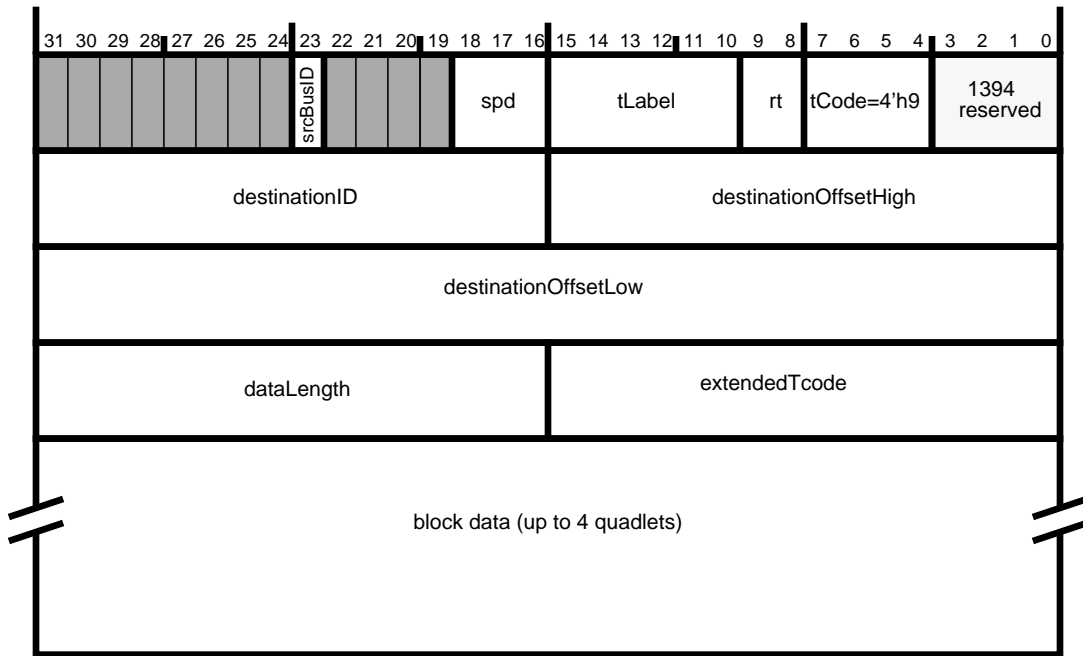

Figure 7-12 — Lock request transmit format

Table 7-14 — Block transmit fields

field name	bits	description
srcBusID, spd, tLabel, rt, tCode, 1394 reserved, destinationID, destinationOffsetHigh, destinationOffsetLow		See Table 7-12.
dataLength	16	The number of bytes of data to be transmitted in this packet.
extendedTcode	16	If the tCode indicates a lock transaction, this specifies the actual lock action to be performed with the data in this packet.
block data		The data to be sent. If dataLength==0, no data should be written into the FIFO for this field. Regardless of the destination or source alignment of the data, the first byte of the block must appear in the high order byte of the first word.
padding		If the dataLength mod 4 is not zero, then zero-value bytes are added onto the end of the packet to guarantee that a whole number of quadlets is sent.

7.5.1.4 PHY packet transmit

The PHY packet transmit format is shown below. The first quadlet contains packet control information. The remaining two quadlets contain data that is transmitted without any formatting on the bus. No CRC is appended to the packet, nor is any data in the first quadlet sent. This packet is used to send PHY configuration and Link-on packets.

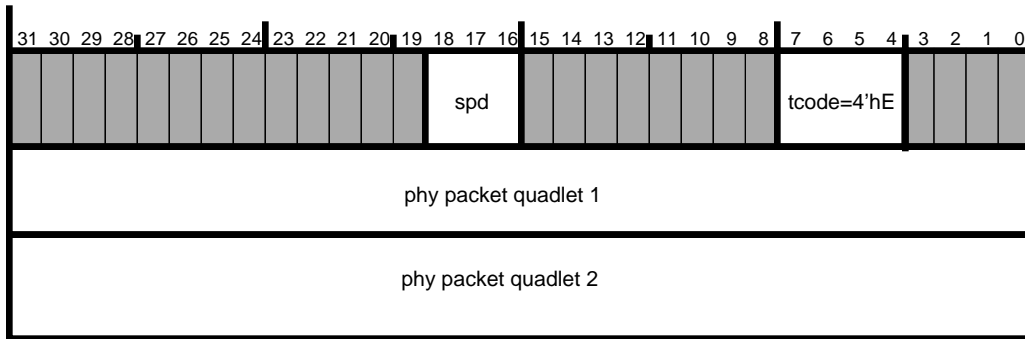

Figure 7-13 — PHY packet transmit format

7.5.2 Asynchronous Transmit Responses

7.5.2.1 No-data transmit

The no-data transmit formats are shown below. The first word contains packet control information. The second and third words contain 16-bit destination ID and either the 48-bit quadlet-aligned destination offset (for requests) or the response code (for responses).

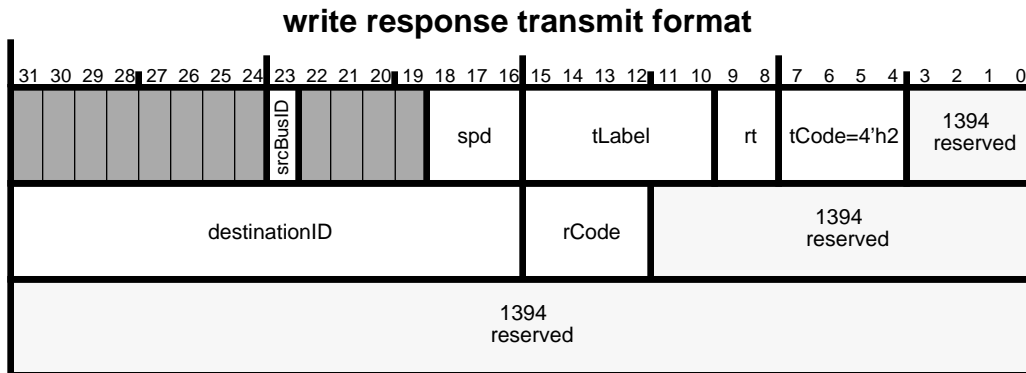

Figure 7-14 — Write response transmit format

Table 7-15 — Write response transmit fields

field name	bits	description
srcBusID	1	Source bus ID selector. If clear, the high order 10 bits of the source_ID field of the transmitted packet will be 10'h3FF. If set, the high order 10 bits of the source_ID field of the transmitted packet will be busNumber.Node_ID (see section 5.9).
spd	3	This field indicates the speed at which this packet is to be sent. 000 = 100 Mbits/sec, 001 = 200 Mbits/sec, and 010 = 400 Mbits/sec, other values are reserved.
tLabel	6	This field is the transaction label, which is used to pair up a response packet with its corresponding request packet.
rt	2	The retry code for this packet. Must be 2'h01 == retryX for the 1394 Open HCI.
tCode	4	The transaction code for this packet.
1394 reserved		Required by IEEE 1394-1995 to be all zeros. OpenHCI will pass these bits along as-is and will not verify them or modify them.
destinationID	16	This is the concatenation of the 10-bit bus number and the 6-bit node number for the destination of this packet.
rCode	4	Response code for write response packet.

7.5.2.2 Quadlet Transmit

The quadlet read response transmit format is shown below. The first word contains packet control information. The second and third words contain 16-bit destination ID and the 4-bit response code. The fourth word is the quadlet data for read responses.

**Figure 7-15 — Quadlet read response transmit format**

Table 7-16 — Quadlet transmit fields

field name	bits	description
srcBusID, spd, tLabel, rt, tCode, 1394 reserved, destinationID, rCode		See Table 7-15.
quadlet data	32	For quadlet write requests and quadlet read responses, this field holds the data to be transferred.

7.5.2.3 Block transmit

The block response transmit formats are shown below. The first word contains packet control information. The second and third words contain the 16-bit destination node ID and the response code and reserved data. The fourth word contains the length of the data field and the extended transaction code (all zeros except for lock transactions). The block data, if any, follows the extended code.

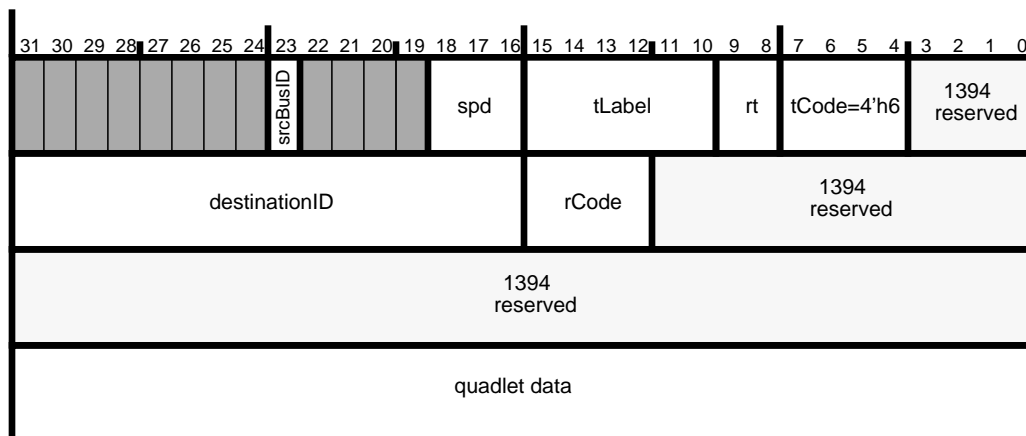
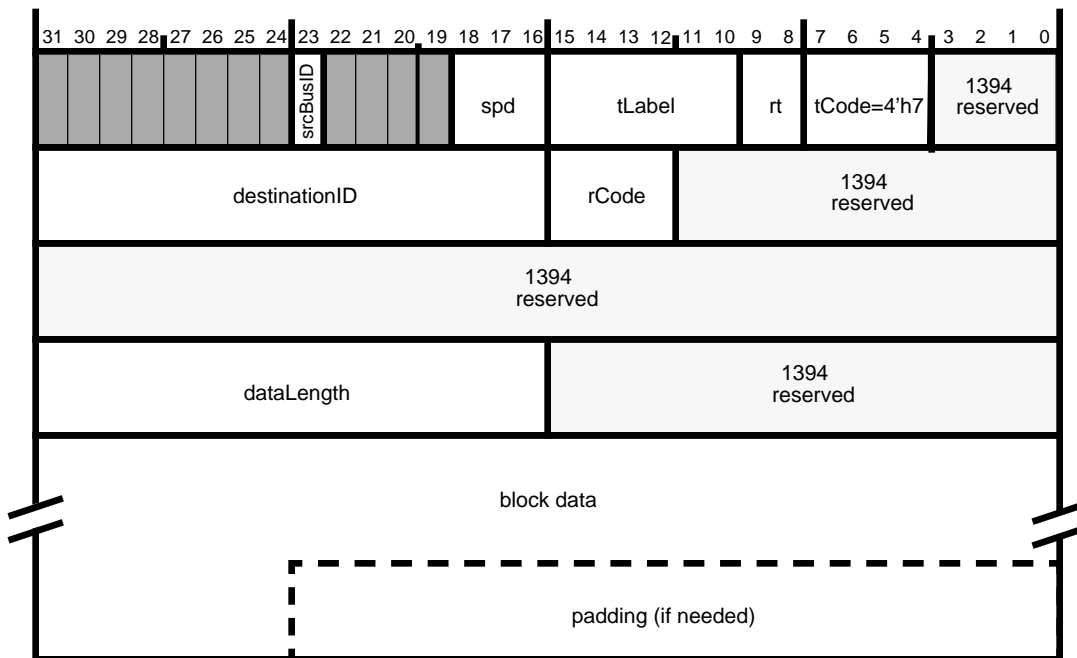
**Figure 7-16 — Block read response transmit format**

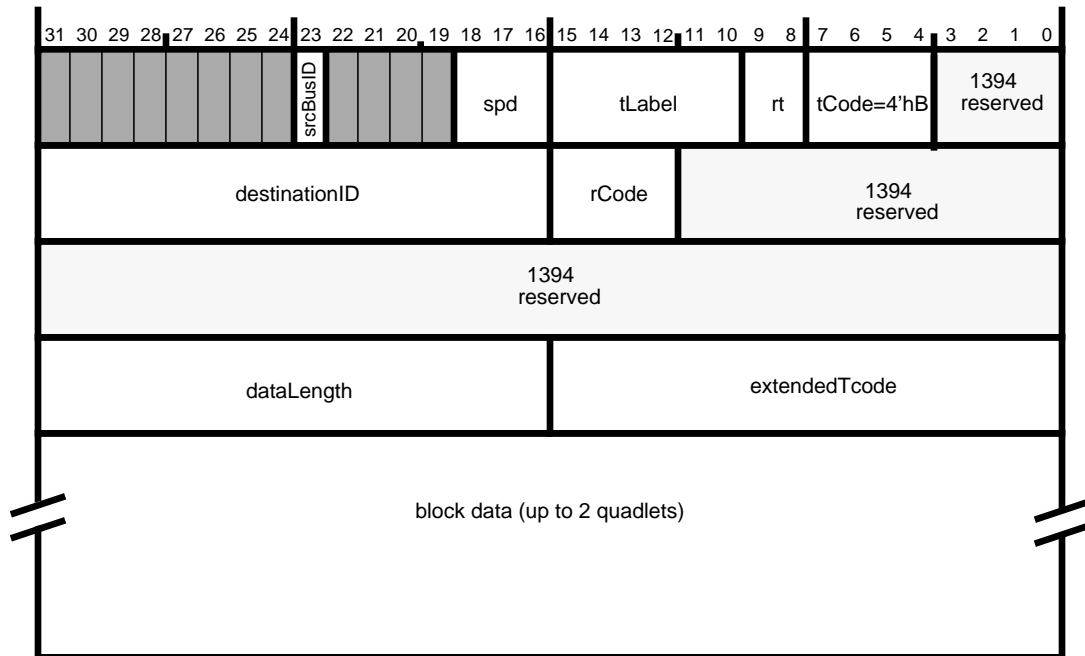

Figure 7-17 — Lock response transmit format

Table 7-17 — Block transmit fields

field name	bits	description
srcBusID, spd, tLabel, rt, tCode, 1394 reserved, destinationID, rCode		See Table 7-15.
dataLength	16	The number of bytes of data to be transmitted in this packet.
extendedTcode	16	If the tCode indicates a lock transaction, this specifies the actual lock action to be performed with the data in this packet.
block data		The data to be sent. If dataLength==0, no data should be written into the fifo for this field. Regardless of the destination or source alignment of the data, the first byte of the block must appear in the high order byte of the first word.
padding		If the dataLength mod 4 is not zero, then zero-value bytes are added onto the end of the packet to guarantee that a whole number of quadlets is sent.

8. Asynchronous Receive DMA

The Asynchronous Receive DMA controller performs the function of accepting packets for which there is no explicit destination. This includes all packets which are accepted by the link module, but are not handled by any other receive DMA function. There are two asynchronous receive (AR) contexts, an AR Request context and an AR Response context. Each context uses a DMA context program to move such packets into memory to be interpreted by the host processor software.

Since the collection of packets that must be handled by the AR contexts may be of widely varying lengths, each context operates in *buffer-fill* mode in which multiple packets may be concatenated into the supplied buffers. Software is responsible for parsing through these buffers and taking the appropriate action required for a packet, and hardware is required to make these buffers parsable.

This chapter describes the AR context program components, how the AR contexts are managed and how the Asynchronous Receive controller operates.

8.1 AR Context Programs

The Asynchronous Receive DMA controller consists of two contexts for handling all asynchronous packets not handled by the physical DMA controller. A context program is a list of DMA descriptors used to identify buffers in host memory into which the Host Controller places received asynchronous packets.

The DMA descriptors are 16-bytes in length and must be aligned on a 16-byte boundary. There is one type of command descriptor used in an AR context program: INPUT_MORE.

8.1.1 INPUT_MORE descriptor

The INPUT_MORE command descriptor is used to specify a host memory buffer into which the AR controller will place the received asynchronous packets from the Host Controller receive FIFO. It has the following format.

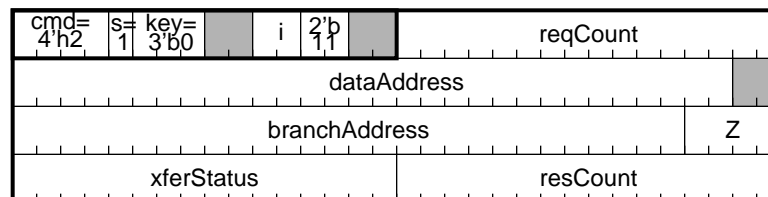

Figure 8-1 — Asynchronous receive descriptor

Table 8-1 — Asynchronous receive descriptor element summary

Element	Bits	Description
cmd	4	Software must set this field in all AR command descriptors to 4'h2 for INPUT_MORE, and hardware may assume that all AR descriptors are INPUT_MORE commands. This indicates to the AR controller that this descriptor contains a buffer address for storing received asynchronous packets.
s	1	Status control. Software must set this field to 1. Hardware always writes status regardless of the setting of this bit.
key	3	This field must be set to 3'b0.

Table 8-1 — Asynchronous receive descriptor element summary

Element	Bits	Description
i	2	Interrupt control. Valid values are 2'b11 to generate an AsynchRx interrupt when the descriptor is completed (see section 6.2.1), or 2'b00 for no interrupt. Behavior is unspecified if set to 2'b01 or 2'b10.
b	2	Branch control. Software must set this field to 2'b11. Values of 2'b10, 2'b01, and 2'b00 will result in unspecified behavior.
reqCount	16	Request count: The size in bytes of the input buffer pointed to by dataAddress. ReqCount must be a multiple of 4 (representing a whole number of quadlets).
dataAddress	32	Host memory address of receive buffer. This address must be aligned on a quadlet boundary.
branchAddress	28	16-byte aligned address of the next descriptor. A valid address must be provided in this field unless the Z field is 0.
Z	4	Z may be set to 0 or 1. If this is the last descriptor in the context program, Z must be set to 0, otherwise it must be set to 1.
xferStatus	16	Written with ContextControl [15:0] whenever resCount is updated.
resCount	16	Residual count: while this descriptor is in-use by the Host Controller, resCount is updated each time a packet is written to the receive buffer to indicate the number of bytes (out of a max of reqCount) which have not been filled with received data. For further information on resCount see section 8.4.2, "AR DMA Controller processing."

Note that the *Command.resCount* and *Command.xferStatus* fields are updated in an indivisible operation.

8.1.2 Using AR command descriptors

An asynchronous receive context program consists of a list of INPUT_MORE command descriptors. Each INPUT_MORE is required to provide a branchAddress along with a Z value of 1 for the next block. Further, it must use Z=0 to indicate the end of the context program. A program which ends in Z=0 can be appended to while the DMA runs, even if the DMA has already reached the final descriptor. The exact mechanism for appending to a running list is the same for all OpenHCI controllers and is described in section 3.2.1.2.

Software may only modify a descriptor that may have been prefetched if a) the descriptor's current Z value is 0, and b) only the branchAddress and Z fields of the descriptor are modified.

8.2 bufferFill mode

Received asynchronous packets can be either solicited responses or unsolicited requests. Since software must be prepared to handle several packets of variable size, the Asynchronous Receive DMA contexts operate in bufferFill mode. In bufferFill mode, all received packets are concatenated into a contiguous stream of data. This data is then metered out into

buffers described by a DMA context program, filling each buffer completely. Packets may straddle multiple buffers in this mode (see packet 2 in the illustration below) In addition to the overall concept of bufferFill mode, there are several nuances for Asynchronous receive which are described in detail below in section 8.4.2.

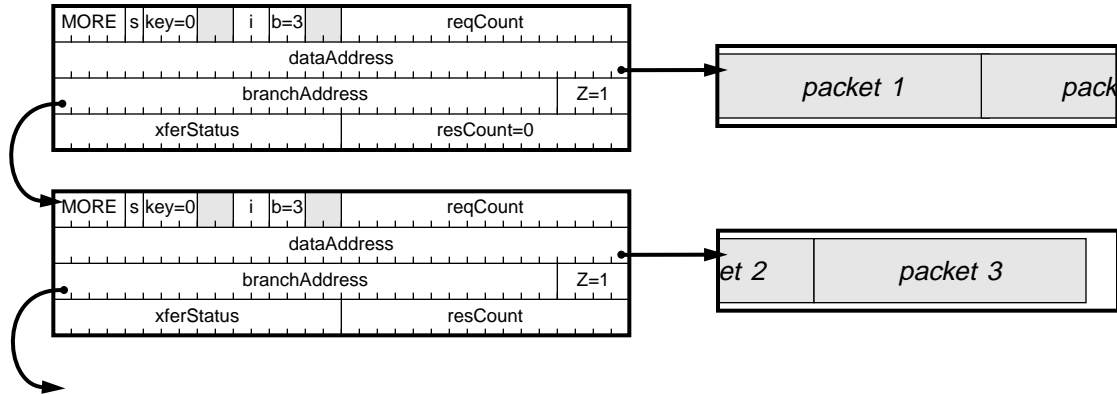

Figure 8-2 — bufferFill receive mode

8.3 Asynchronous Receive Context Registers

The AR request context and AR response context each have a CommandPtr register and a ContextControl register. CommandPtr is used by software to tell the Host Controller where the DMA context program begins. ContextControl is used by software to control the context’s behavior, and is used by hardware to indicate current status.

8.3.1 AR DMA CommandPtr register

The CommandPtr register specifies the address of the context program which will be executed when a DMA context is started. All descriptors are 16-byte aligned, so the four least-significant bits of any descriptor address must be zero. The least-significant bit of the CommandPtr register is used to encode a Z value. For each AR context (Request and Receive) Z may be either 1 to indicate that descriptorAddress points to a valid command descriptor, or 0 to indicate that there are no descriptors in the context program.

Refer to section 3.1.5 for a full description of the CommandPtr register.

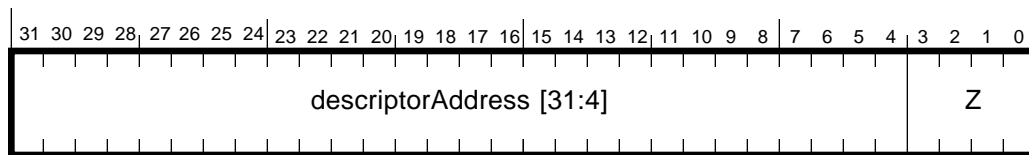

Figure 8-3 — CommandPtr register format

8.3.2 AR ContextControl register (set and clear)

The *ContextControlSet* and *ContextControlClear* registers contain bits that control options, operational state, and status for a DMA context. Software can set selected bits by writing ones to the corresponding bits in the *ContextControlSet* register. Software can clear selected bits by writing ones to the corresponding bits in the *ContextControlClear* register. It is not possible for software to set some bits and clear others in an atomic operation. A read from either register will return the same value and is referred to as the *ContextControlStatus* register.

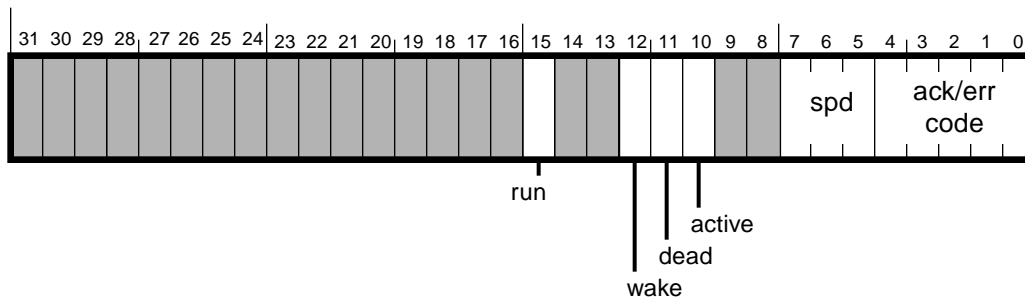

Figure 8-4 — AR ContextControl (set and clear) register format

Table 8-2 — AR ContextControl (set and clear) register description

Field	RSC	Description
run	rsc	Refer to section 3.1.1 for an explanation of the contextControl. <i>run</i> bit.
wake	rs	Refer to section 3.1.2 for an explanation of the contextControl. <i>wake</i> bit.
dead	ru	Refer to section 3.1.4 for an explanation of the contextControl. <i>dead</i> bit.
active	ru	Refer to section 3.1.3 for an explanation of the contextControl. <i>active</i> bit.
spd	ru	This field indicates the speed at which the packet was received. 3'b000 = 100 Mbts/sec, 3'b001 = 200 Mbts/sec and 3'b010 = 400 Mbts/sec. All other values are reserved.
ack/err code	ru	Following an INPUT_MORE command, the received ack_code or an "evt_" error code is indicated in this field. Possible values are: ack_complete, ack_pending, evt_descriptor_read, evt_data_write, evt_bus_reset and evt_unknown. See Table 3-2, "Packet event codes," for descriptions and values for these codes.

8.4 AR DMA Controller

8.4.1 Asynchronous Filter Registers

Software can control from which nodes it will receive *request* packets by utilizing the asynchronous filter registers. There are two registers, one for filtering out all requests from a specified set of nodes (AsynchronousRequestFilter register) and one for filtering out physical requests from a specified set of nodes (PhysicalRequestFilter register). The settings in both registers have a direct impact on how the AR Request context is used, e.g. disabling only physical receives from a node will cause all request packets from that node to be routed to the AR Request context buffer(s). The usage and interrelationship between these registers is fully described in section 5.12, "Asynchronous Request Filters." Asynchronous *response* packets are never filtered.

8.4.2 AR DMA Controller processing

The AR DMA controller writes the entire packet, as described in the Asynchronous Receive Data Formats section, into memory for software to process. This includes the packet header and packet reception status. Data chaining across context commands is supported.

For the AR request context, `command.reqCount` should always be set to at least the maximum possible packet length for an asynchronous packet as specified in the `max_rec` field of the `bus_info_block`, plus five quadlets for the header and trailer ($2^{(\text{max_rec}+1)} + 20$ bytes). This means a single packet can cross at most one buffer boundary. This requirement also makes it easier for the Host Controller implementation to combine asynchronous receive FIFOs (see section 3.3).

When the host software transmits an asynchronous request, it must first ensure that there is enough buffer space allocated in the AR response context's context program to receive the response packet including headers and timestamp. Failure to preallocate this space may result in the hardware discarding responses that arrive when the AR response context is out of descriptors even though `ack_complete` may have been sent to the source node.

Since the AR request context and AR response context buffers must always be parseable by software there are three essential requirements.

- a) The Host Controller must write a packet into a buffer(s) by first writing the asynchronous packet header, followed by the packet data, followed by a packet trailer.
- b) Requests or responses with data-length errors, CRC errors, FIFO overrun errors or buffer overrun errors must not be presented to the software. Although the host memory buffers may have been written in anticipation of a good packet, the `xferStatus` and `resCount` will not be updated. This in effect "backs out" the packet.
- c) After each packet is written into the buffer(s), hardware must update the `resCount` for the `INPUT_MORE` descriptor(s) for the buffer(s), to accurately reflect the number of unused bytes remaining.

Software does not have to initialize `resCount`. Upon the first packet arrival into a buffer, the Host Controller must write the appropriate residual count, based on $(\text{reqCount} - (\text{packetHeaderLen} + \text{dataLength} + \text{statusquadlet}))$. Note that neither the header CRC nor data CRC quadlets are inserted into the buffer.

As depicted in figure 8-2 on page 71, it is possible for a received packet to straddle multiple buffers. For the AR Request context, the buffer size requirements (mentioned above) ensure that a packet can only straddle two buffers. However, the AR Response context does not have a buffer size requirement and therefore AR response packets may straddle more than two buffers. To ensure that the receive buffers for a context remain parsable, hardware must follow the procedure shown below. (First buffer refers to the buffer receiving the first byte of the packet or packet header, and final buffer refers to the buffer receiving the last byte of the packet or packet trailer.)

- 1) After filling to the end of a buffer with a partial packet, advance to the next descriptor block and obtain the next buffer (`dataAddress`), retaining all state for the first buffer as well as for the new buffer.
- 2) Continue writing packet bytes into the new buffer. If the end of the buffer is reached, advance to the next buffer without updating `xferStatus` and without retaining state for it or any other interim buffers. Write the remaining packet bytes into the final buffer (for the packet).
- 3) If there is no error: 1) write the trailer quadlet into the final buffer, 2) update `xferStatus` and `resCount` into the **final** buffer's descriptor, and 3) update `xferStatus` and `resCount` into the first buffer's descriptor. At that point the first buffer's state is no longer needed.
- 4) If there *is* an error, then the packet must be 'backed-out' by reverting back to the previous state of the first buffer (as saved earlier). `XferStatus` and `resCount` are not updated for either descriptor.

By following these steps, the AR context buffers remain intact and can be parsed. Since interim buffers (those containing an inner portion of one packet) for the AR Response context will not have their status updated, software must only use `resCount` values when the corresponding `xferStatus` indicates the run bit is set to one. It follows from this that if the `xferStatus.run` bit is set in a descriptor, then all prior descriptors have been filled.

8.4.2.1 AR DMA Packet Trailer

The trailer quadlet written by the Host Controller at the end of each packet has the following format.

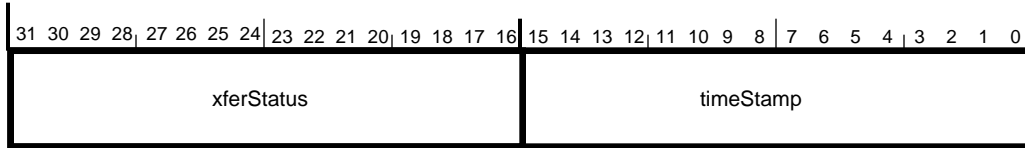

Figure 8-5 — AR DMA packet trailer format

Table 8-3 — AR DMA trailer fields

field name	bits	description
xferStatus	16	Written with ContextControl[15:0].
timeStamp	16	The low order 3 bits of cycleTimer.cycleSeconds and the full 13 bits of cycleTimer.cycleCount at some time during receipt of the packet.

8.4.2.2 Error Handling

Packets resulting in an `ack_data_error` will, in effect, not go into an AR DMA buffer. Since an `ack_data_error` condition is not known until all data (plus data CRC) has arrived, many “corrupted” data bytes may have been moved into an AR DMA buffer by the time the error situation is discovered. In this circumstance, hardware is required to halt its writing of the packet into the AR DMA buffer without updating the `resCount` field. By not advancing the residual count location, it will appear as though the packet never was written into the AR DMA buffer at all.

8.4.2.3 Bus Reset Packet

To assist software in determining which asynchronous request packets arrived before and after a bus reset (necessary since node numbers may have changed), the Host Controller inserts a synthesized PHY packet into the AR DMA Request Context buffer as soon as a bus reset condition is detected. This packet has the following format.

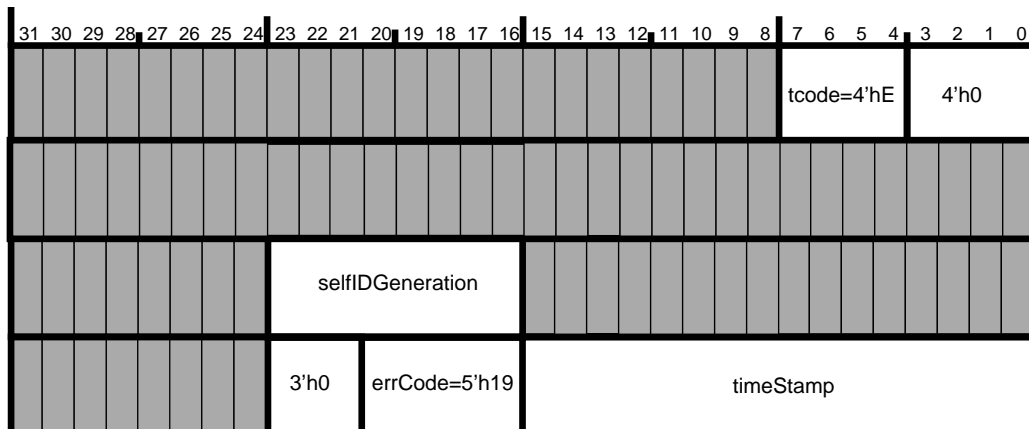

Figure 8-6 — AR Request Context Bus Reset packet format

Table 8-4 — AR Request Context Bus Reset packet description

Field	bits	Description
tcode	4	Set to 4'hE to indicate a PHY packet.
selfIDGeneration	8	The selfIDCount. <i>selfIDGeneration</i> value at the time this packet is created.
errCode	5	A value of 5'h19 (evt_bus_reset) identifies this as a synthesized bus_reset packet.
timeStamp	16	The low order 3 bits of cycleTimer. <i>cycleSeconds</i> and the full 13 bits of cycleTimer. <i>cycleCount</i> when this packet was created.

Software can distinguish the bus-reset packet from authentic PHY packets based on the size (bus-reset packet is four quadlets, PHY is three). Bus-reset packets are further distinguished by the value of errCode which is set to evt_bus_reset. Software can further interpret and coordinate received asynchronous packets across multiple bus resets by using the selfIDGeneration number provided in the bus-reset packet. Since the bus-reset packet is fabricated when a bus reset is initially detected, the selfIDGeneration number is for the previous (not new) generation.

If the input FIFO is full when a bus reset occurs, the link side of the FIFO must later insert the bus-reset packet when space becomes available.

8.5 Asynchronous Receive Interrupts

There are two interrupts for each context (request and response) that software can use to gauge the usage of the receive buffers. If software needs to be informed of the arrival of each packet being sent to the context buffers, it can use the RQPkt or RSPkt interrupts in the IntEvent register (see section 6.2.1). If software needs to be informed of the completion of a buffer, it can set the context command.i field to 2'b11, which will trigger either the ARRQ or ARRS interrupt in the IntEvent register.

8.6 Asynchronous Receive Data Formats

There are four basic formats for asynchronous data to be received:

- a) no-data packets (used for quadlet read requests and all write responses)
- b) quadlet packets (used for quadlet write requests, quadlet read responses, and block read requests)
- c) block packets (used for lock requests and responses, block write requests, and block read responses)
- d) PHY packets

The names and descriptions of the fields in the received data are given in table 8-5.

Table 8-5 — Asynch receive fields

field name	bits	description
destinationID	16	This field is the concatenation of busNumber (or all ones for "local bus") and node-Number (or all ones for broadcast) for this node.
tLabel	6	This field is the transaction label, which is used to pair up a response packet with its corresponding request packet.
rt	2	The retry code for this packet. 00=retry1, 01=retryX, 10=retryA, 11=retryB
tCode	4	The transaction code for this packet.
1394 reserved		Required by IEEE 1394-1995 to be all zeros. OpenHCI will pass these bits along as-is and will not verify or modify them.
sourceID	16	This is the node ID of the sender of this packet.

Table 8-5 — Asynch receive fields (Continued)

field name	bits	description
destinationOffsetHigh, destinationOffsetLow	16 32	The concatenation of these two fields addresses a quadlet in this node's address space. This address must be quadlet-aligned (modulo 4).
rCode	4	Response code for response packets.
quadlet data	32	For quadlet write requests and quadlet read responses, this field holds the data received.
dataLength	16	The number of bytes of data to be received in a block packet.
extendedTcode	16	If the tCode indicates a lock transaction, this specifies the actual lock action to be performed with the data in this packet.
block data		The data received. If dataLength==0, no data will be written into the fifo for this field. Regardless of the destination or source alignment of the data, the first byte of the block will appear in the high order byte of the first word.
padding		If the dataLength mod 4 is not zero, then bytes have been added onto the end of the packet by the transmitting node to guarantee that a whole number of quadlets is received.
xferStatus	16	Written with ContextControl[15:0]. The ContextControl bits [7:0] written into the descriptor's xferStatus pertain to no particular packet in the buffer and are likely not to be of any use to software.
timeStamp	16	The low order 3 bits of <i>cycleSeconds</i> and the full 13 bits of <i>cycleCount</i> from the most recently received (or sent) cycle start packet. If there is no cycle master, a synthesized value will be used from the cycleTimer register.

8.6.1 No-data receive

The no-data receive formats are shown below. The first word contains the destination node ID and the rest of the packet header. The second and third words contain 16-bit source ID and either the 48-bit, quadlet-aligned destination offset (for requests) or the response code (for responses). The last word contains packet reception status.

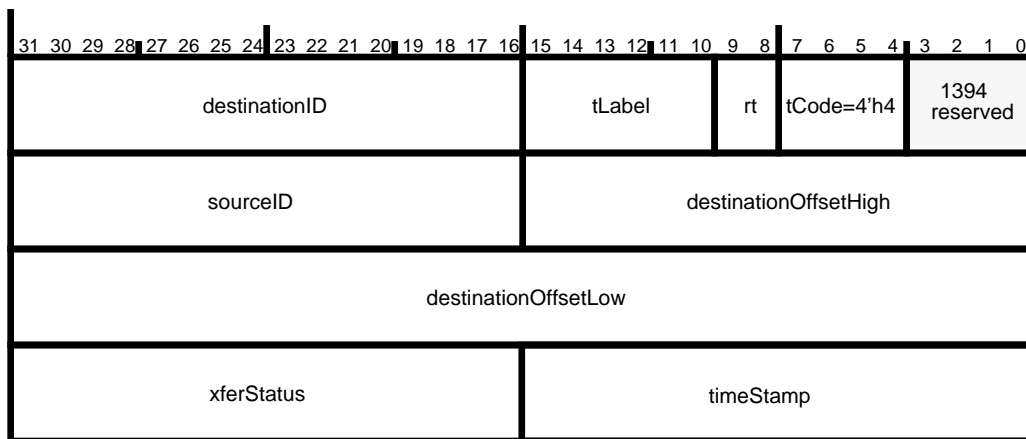
**Figure 8-7 — Quadlet read request receive format**

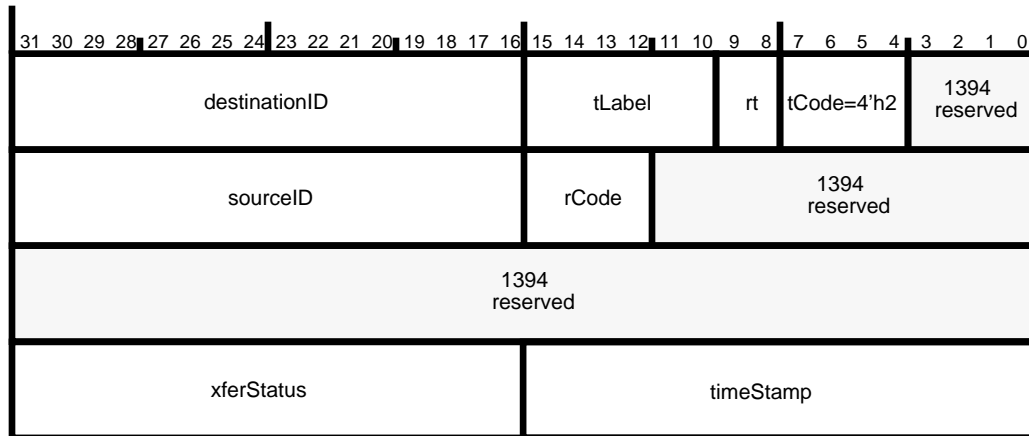

Figure 8-8 — Write response receive format

8.6.2 Quadlet Receive

The quadlet receive formats are shown below. The first word contains the destination node ID and the rest of the packet header. The second and third words contain 16-bit source ID and either the 48-bit, quadlet-aligned destination offset (for requests) or the response code (for responses). The fourth word is the quadlet data for read responses and write quadlet requests, and is the data length and reserved for block read requests. The last word contains packet reception status.

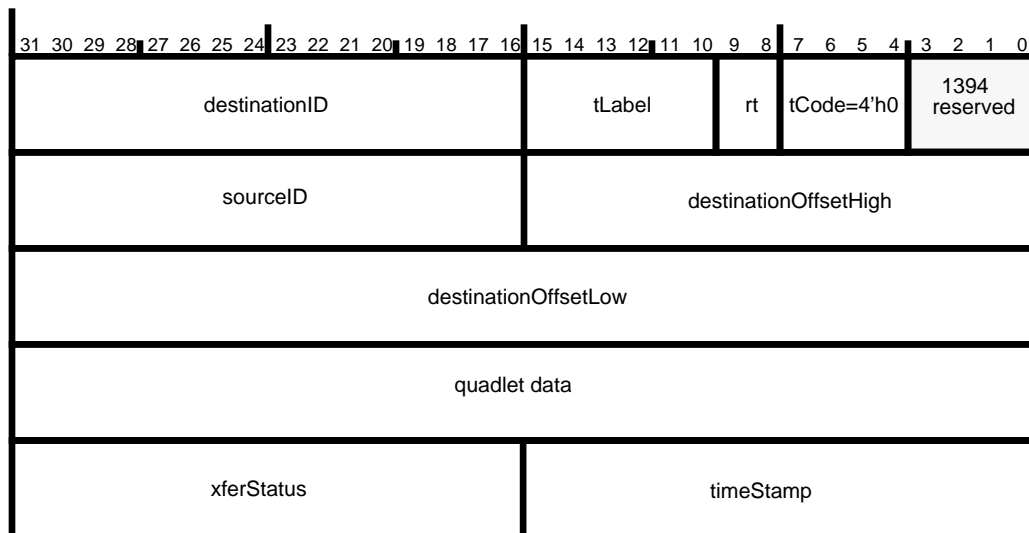

Figure 8-9 — Quadlet write request receive format

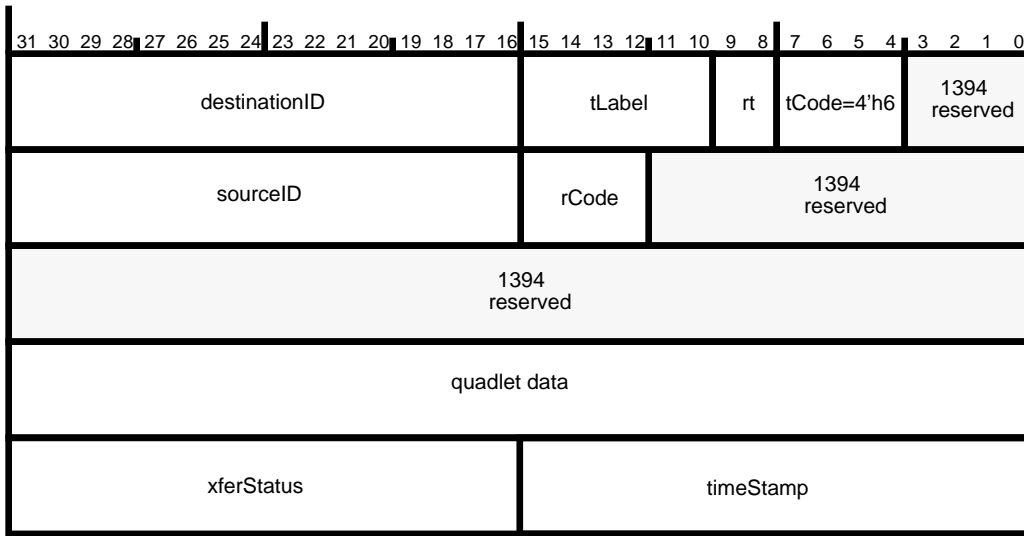

Figure 8-10 — Quadlet read response receive format

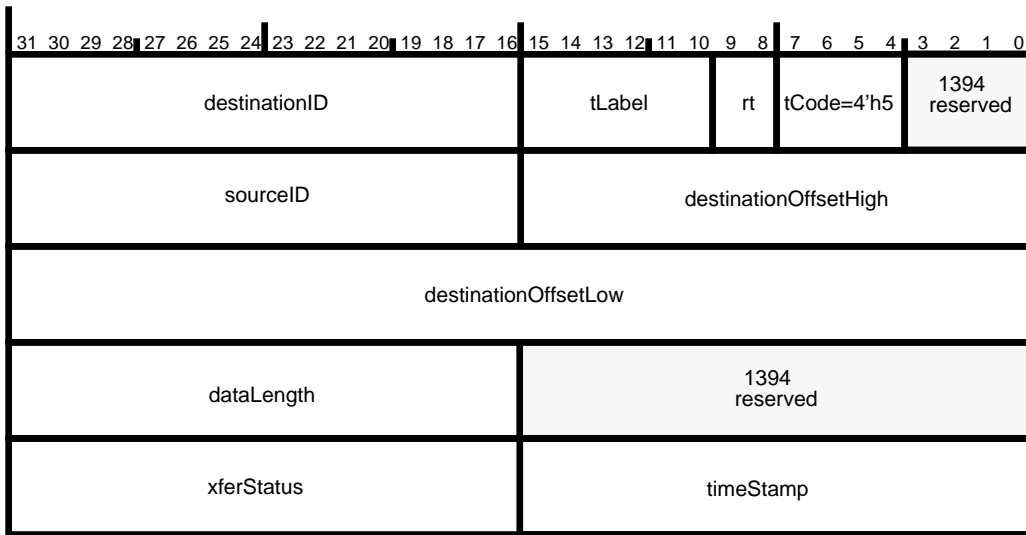

Figure 8-11 — Block read request receive format

8.6.3 Block receive

The block receive format is shown below. The first word contains the destination node ID and the rest of the packet header. The second and third words contain 16-bit source ID and either the 48-bit destination offset (for requests) or the response code and reserved data (for responses). The fourth word contains the length of the data field and the extended transaction code (all zeros except for lock transactions). The block data, if any, follows the extended code. The last word contains packet reception status.

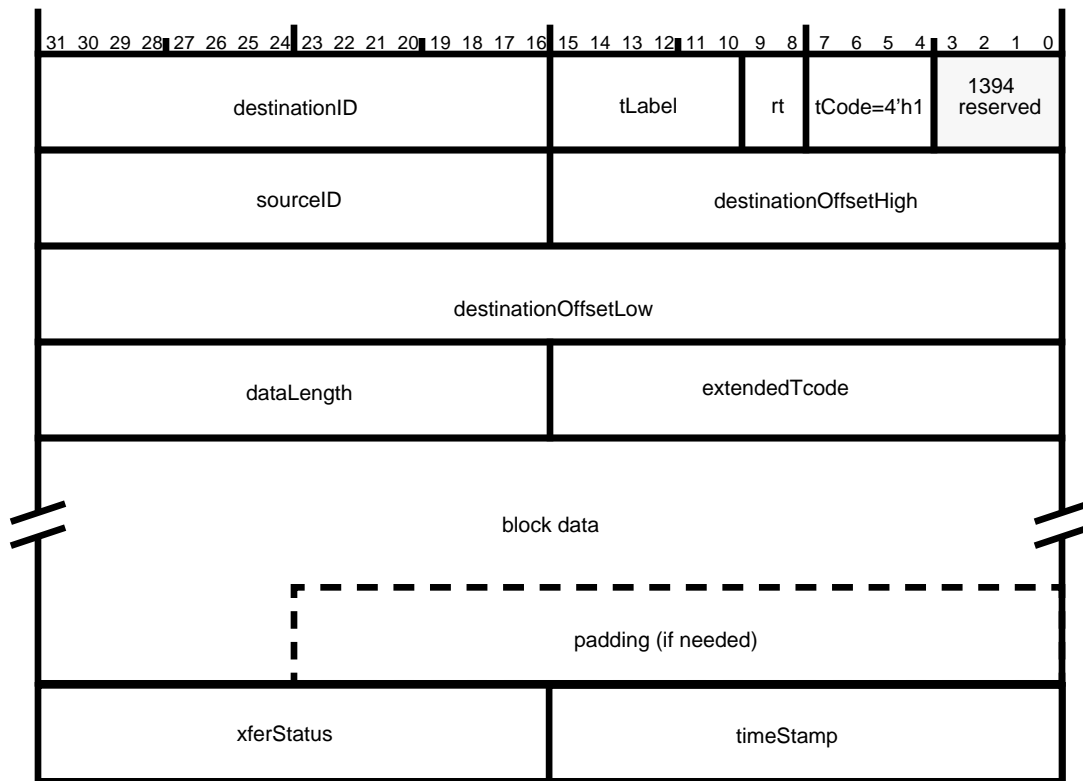

Figure 8-12 — Block write request receive format

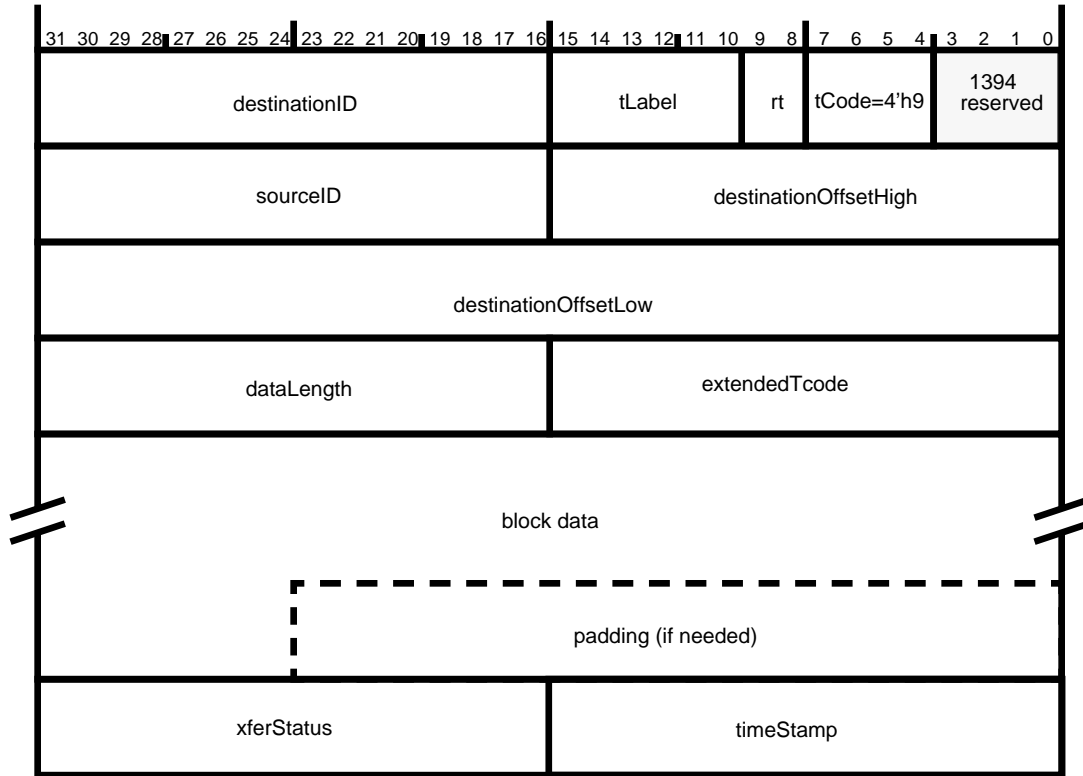

Figure 8-13 — Lock request receive format

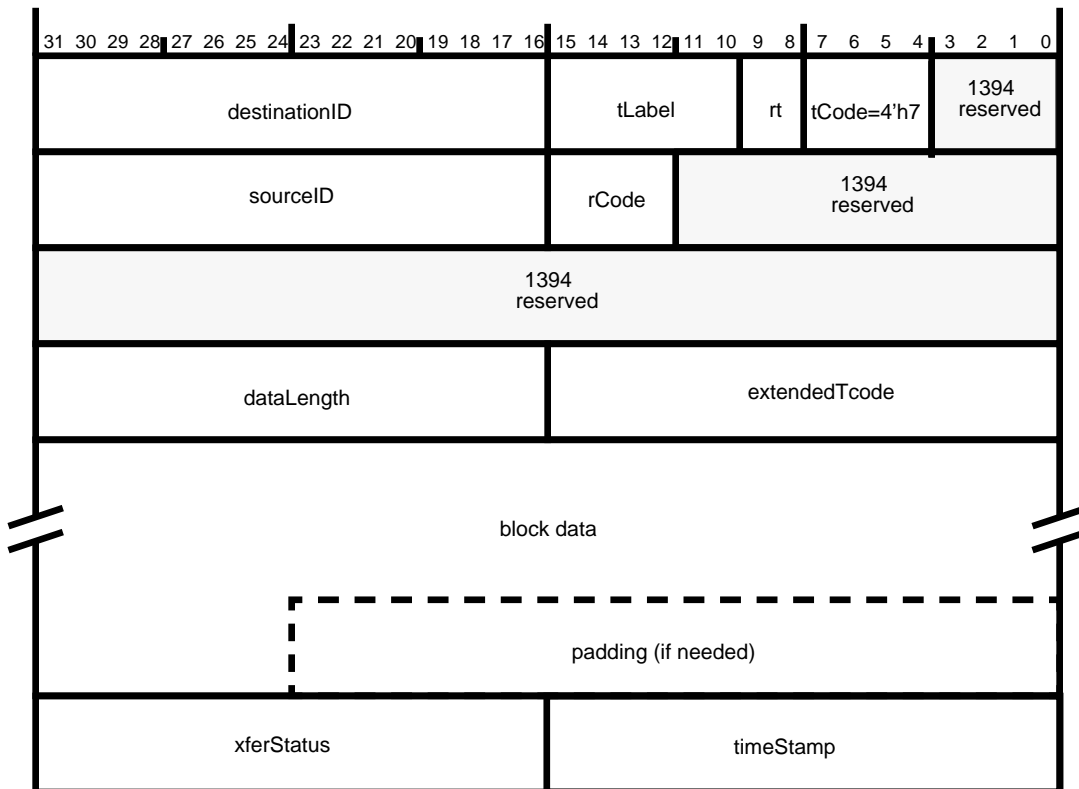

Figure 8-14 — Block read response receive format

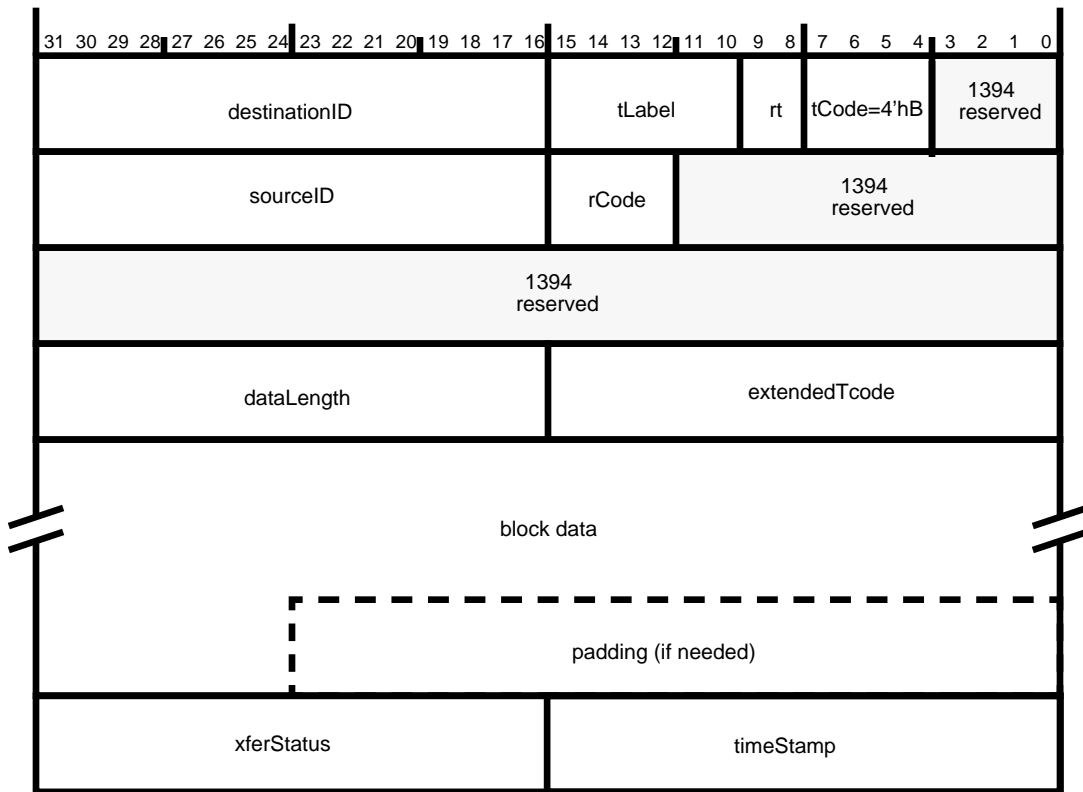

Figure 8-15 — Lock response receive format

8.6.4 PHY packet receive

The PHY packet receive format is shown below. The first word contains a synthesized packet header with a tCode of 4'hE. The second quadlet contains the PHY quadlet and the third quadlet contains the inverse of the first quadlet. Software is required to verify the integrity of the second quadlet by checking it against the third quadlet. The final (fourth) quadlet contains the packet trailer. Self-ID packets not arriving during the bus initialization self-ID phase are received as PHY packets.

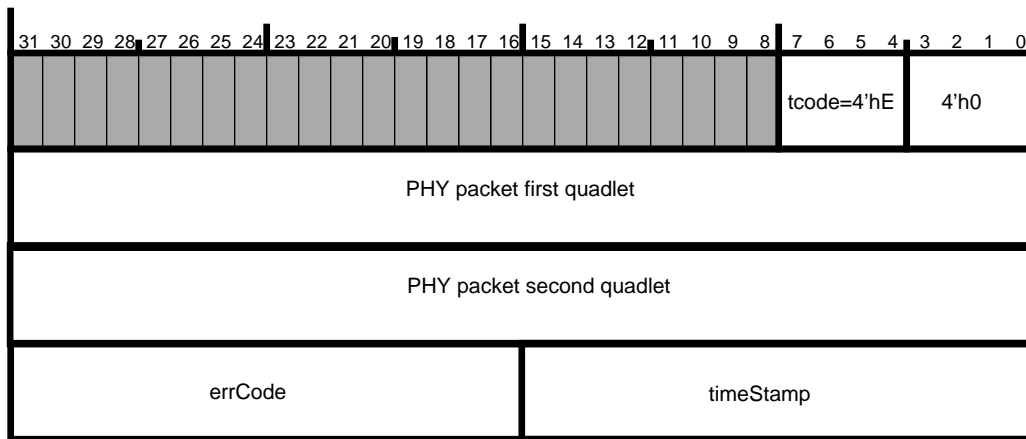

Figure 8-16 — PHY packet receive format

9. Isochronous Transmit DMA

The Isochronous Transmit DMA (IT DMA) controller has a required minimum of four and an implementation maximum of 32 isochronous transmit contexts. Each context is controlled by a DMA context program. Each IT DMA context will transmit data for a single isochronous channel.

9.1 IT DMA Context Programs

For isochronous transmit DMA, a context program is a list of DMA command descriptors used to identify buffers in host memory from which the Host Controller transmits packets onto the 1394 bus. The descriptors are 16 bytes in length and must be aligned on a 16-byte boundary. There are five kinds of DMA command descriptors that can be used: `OUTPUT_MORE`, `OUTPUT_MORE-Immediate`, `OUTPUT_LAST`, `OUTPUT_LAST-Immediate` and `STORE_VALUE`.

9.1.1 IT DMA command descriptor overview

There are two components to a 1394 isochronous packet, the packet header and the packet data, and there are many ways in which software may need to organize this information in host memory. To accommodate the variety of packet organization, there are four IT DMA descriptor commands used to instruct the Host Controller on how to assemble the packets, and one descriptor command for writing a quadlet into host memory for software tracking purposes.

If a packet has two or more data fragments an `OUTPUT_MORE-Immediate` and possibly some `OUTPUT_MORE` commands are used. The `OUTPUT_MORE-Immediate` command is used to specify the packet header, and each `OUTPUT_MORE` command allows for the specification of one packet fragment.

To indicate the end of a packet, either the `OUTPUT_LAST` or `OUTPUT_LAST-Immediate` command must be used. The `OUTPUT_LAST` command allows for the specification of one data fragment, and the `OUTPUT_LAST-Immediate` is used to specify a packet solely consisting of an isochronous packet header. Unlike the `OUTPUT_MORE` commands, the `OUTPUT_LAST` commands indicate to the Host Controller that there is no more data to send for a packet.

The `STORE_VALUE` command descriptor provides a mechanism for software to monitor progress on a context without using interrupts. This command will write a quadlet to a specified host memory location.

9.1.2 OUTPUT_MORE descriptor



Figure 9-1 — OUTPUT_MORE command descriptor format

Table 9-1 — OUTPUT_MORE descriptor element summary

Element	Bits	Description
cmd	4	Set to 4'h0 for OUTPUT_MORE. Identifies one data (or header) fragment used to build the packet.
key	3	This field must be set to 3'b000.
b	2	Branch control. Must be set to 2'b00. Behavior is unspecified if set to 2'b01, 2'b10 or 2'b11.
reqCount	16	Request count. The size of the specified buffer in bytes pointed to by dataAddress.
dataAddress	32	Address of transmit buffer.

The OUTPUT_MORE descriptor is used to specify one data fragment for the packet. DataAddress has no alignment restrictions.

9.1.3 OUTPUT_MORE-Immediate descriptor

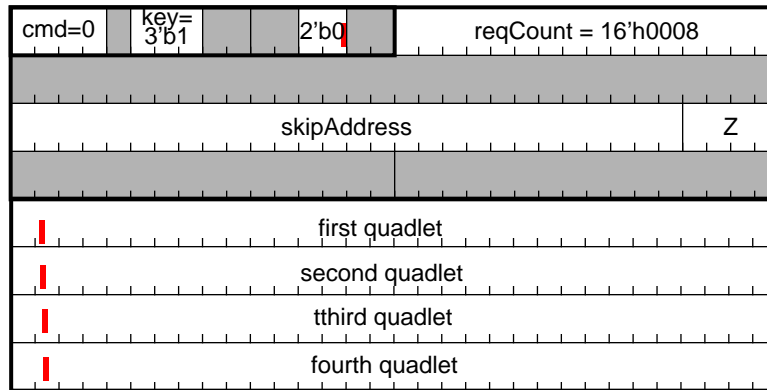

Figure 9-2 — OUTPUT_MORE-Immediate descriptor format

Table 9-2 — OUTPUT_MORE-Immediate descriptor element summary

Element	Bits	Description
cmd	4	Set to 4'h0 for OUTPUT_MORE-Immediate.
key	3	This field must be set to 3'b001.
b	2	Branch control. Must be set to 2'b00. Behavior is unspecified if set to 2'b01, 2'b10 or 2'b11.
reqCount	16	Must be set to 8 to accomodate the IT packet header. Using any other value yields unspecified results.
immediate data	32	Quadlet to be inserted into the isochronous transmit FIFO. Typically an isochronous packet header.
skipAddress	28	16-byte aligned address of the next descriptor to be used if a missed cycle is detected. Used only within the first command descriptor in a descriptor block. The first command must either have a valid skipAddress, or must set the Z field to 0.
Z	4	Used to indicate the number of descriptors needed for the skip descriptor block. Z may be a value from 0 to 8. A zero indicates there is no skipAddress, and the DMA for this context stops. A value of 1 to 8 indicates that there are 1 to 8 descriptors used in the skip packet.
quadlets	32*4	The first and second quadlets are used to specify the 2 quadlets required for the isochronous packet header. (See section 9.5).

The OUTPUT_MORE-Immediate descriptor must be used, and must only be used, to specify the isochronous header for a non-zero data length packet. This is an efficient way for software to provide the packet header information since the data is built into the descriptor and does not need to be fetched from a separate memory buffer.

OUTPUT_MORE-Immediate command descriptors are 32 bytes in length regardless of the value of reqCount.

9.1.4 OUTPUT_LAST descriptor

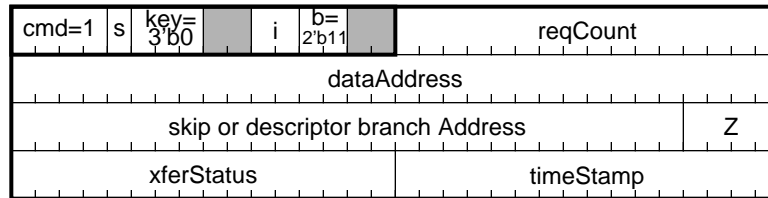

Figure 9-3 — OUTPUT_LAST command descriptor format

Table 9-3 — OUTPUT_LAST descriptor element summary

Element	Bits	Description
cmd	4	Set to 4'h1 for OUTPUT_LAST. Each command identifies one data (or header) fragment used to build the packet. OUTPUT_LAST is used to signify the end of the isochronous packet to be transmitted.
s	1	Status control. If set to one, xferStatus and timeStamp will be updated upon descriptor completion. If set to zero, neither field is updated.
key	3	This field must be set to 3'b000.
i	2	Interrupt control. Valid values are 2'b11 to generate an IsochTx interrupt when the descriptor is completed (see section 6.2.1), or 2'b00 for no interrupt. Behavior is unspecified if set to 2'b01 or 2'b10.
b	2	Branch control. This field must be set to 2'b11 to branch to the location specified in the branchAddress field. Behavior is unspecified for all other values.
reqCount	16	Request count: The size of the buffer in bytes pointed to by dataAddress.
dataAddress	32	Address of transmit buffer.
branchAddress	28	16-byte aligned address of the next descriptor. Used only within OUTPUT_LAST commands.
skipAddress		16-byte aligned address of the next descriptor to be used if a missed cycle is detected. Used only within the first command descriptor in a descriptor block.
Z	4	Used in OUTPUT_LAST only to indicate the number of descriptors needed in the <i>next</i> descriptor block. Z may be a value from 0 to 8. A zero indicates this is the last descriptor in the list for this IT DMA context. A value of 1 to 8 indicates that there are 1 to 8 descriptors used in the next descriptor block.
xferStatus	16	Written with ContextControl [15:0] after the descriptor is processed if s = 1.
timeStamp	16	Contains the three low order bits of cycleSeconds and all 13 bits of cycleCount, and is written when xferStatus is written. TimeStamp indicates the cycle for which the IT DMA controller queued the transmission of this packet. See section section 5.11, "Isochronous Cycle Timer Register," for information about cycle* fields.

9.1.5 OUTPUT_LAST-Immediate descriptor

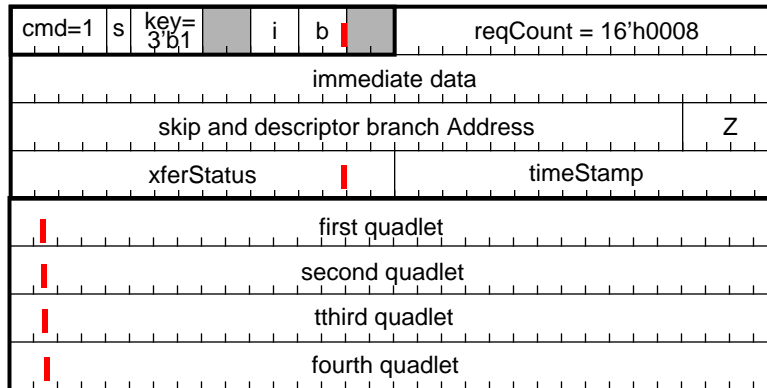

Figure 9-4 — OUTPUT_LAST-Immediate command descriptor format

Table 9-4 — OUTPUT_LAST-Immediate descriptor element summary

Element	Bits	Description
cmd, s		Same as in Table 9-3.
key	3	This field must be set to 3'b001.
i, b		Same as in Table 9-3.
reqCount	16	Must be set to 16'h0008 to accomodate the IT packet header. Using any other value yields unspecified results.
branchAddress, skipAddress, Z, xferStatus, timeStamp		Same as in Table 9-3.
quadlets	32*4	The first and second quadlets are used to specify the 2 quadlets required for the isochronous packet header. (See section 9.5).

The OUTPUT_LAST-Immediate descriptor must be used, and must only be used, to specify the isochronous header for a packet with zero data bytes. OUTPUT_LAST-Immediate command descriptors are 32-bytes in length regardless of the value of reqCount.

9.1.6 STORE_VALUE descriptor

The STORE_VALUE command descriptor instructs the Host Controller to write a specified 32-bit value to a specified host memory location. If used, STORE_VALUE must be the first command descriptor in a descriptor block, and only one is permitted per descriptor block. It has the following format.



Figure 9-5 — STORE_VALUE descriptor

Table 9-5 — STORE_VALUE descriptor element summary

Element	Bits	Description
cmd	4	Set to 4'h8 for STORE_VALUE.
key	3	This field must be set to 3'b6.
storeDoublet	16	16-bit value to be stored into the quadlet aligned dataAddress upon execution of this command. StoreDoublet is written as a 32 bit value, where bits 31:16 are 0's and bits 15:0 contain the storeDoublet value provided in the descriptor.
dataAddress	32	Quadlet aligned host memory address into which storeDoublet (padded to 32) bits is written.
skipAddress, Z	28	Same as in Table 9-1.

9.1.7 IT DMA descriptor usage

The Z value is used by the Host Controller to enable several descriptors to be fetched at once, for improved efficiency. Z values must always be encoded correctly. The contiguous descriptors described by a Z value are called a *descriptor block*. The following table summarizes all legal Z values:

Table 9-6 — Z value encoding

Z value	Use
0	Indicates that the current descriptor is the last descriptor in the context program.
1-8	Indicates that 1 to 8 descriptors starting at descriptorAddress are physically contiguous.
9-15	reserved

Each isochronous transmit descriptor block for a packet shall be specified with the command descriptors according to the following rules:

- A maximum of 8 command descriptors may be used.
- Only one STORE_VALUE may be used, and it must be the first descriptor in a descriptor block.
- If the packet dataLength is not zero, one OUTPUT_MORE-Immediate must be used, followed by zero to five OUTPUT_MORE's, followed by one OUTPUT_LAST.
- If the packet dataLength is zero, one OUTPUT_LAST-Immediate must be used.

The isochronous packet header must be specified using a *-Immediate command. The OUTPUT_LAST* command must have a branch control value of 2'b11. All other commands must have a branch control value of 2'b00. Within a descriptor block the sum of all descriptors' reqCount values must be four or more. This is the minimum number of bytes needed to describe an isochronous packet header. Depending on the aggregate number of bytes being transmitted for one descriptor block, hardware may assist with padding. If the sum of all reqCounts modulo 4 is 0, then padding is not necessary. If the sum of all reqCounts modulo 4 is not 0, then hardware will insert padding up to a quadlet boundary.

To indicate the end of the context program, all IT DMA context programs must use an OUTPUT_LAST or OUTPUT_LAST-Immediate command with a branch (b) value of 2'b11 (branch always) and a Z value of 0 to indicate the end of the program. A program which ends can be appended to while the DMA runs, even if the DMA has already reached the last descriptor.

The first command in an isochronous packet descriptor block must have a skipAddress which points to the descriptor to branch to if this packet cannot be transmitted (typically due to a lost cycle). The value of the Command.b field in that descriptor does not affect a skip branch.

The use of many OUTPUT_MORE* commands to describe a single packet will generally cause extra fetch latencies, as the Host Controller fetches payload buffers from different parts of memory. These latencies may differ for each Host Controller implementation, bus, and host memory architecture. Software is expected to construct IT DMA context programs with a sufficiently low number of OUTPUT_MORE* commands so that the Host Controller can satisfy application-specific latency requirements.

ITDMA context programs must contain exactly one descriptor block to be transmitted per cycle. Each descriptor block must be identified with an accurate Z value, both when the program is started, and on each branch within the program. Each descriptor block must end with an unconditional branch to the next descriptor block, even if the next block follows immediately in consecutive memory. (The branch enables the ITDMA to learn the Z value for the next descriptor block). Each descriptor block must begin with a command that contains a branch to the skipAddress (also with a Z code).

Some applications of isochronous transfer do not transfer a packet on every isochronous cycle. Therefore the ITDMA will sometimes not transmit a packet for one or more channels. Within a context program, a non-transmit cycle is indicated by a descriptor block whose only transfer command is an OUTPUT_LAST with a length of zero. (This is not a zero-length packet, which would be sent with an OUTPUT_LAST-Immediate.)

9.2 IT Context Registers

Each isochronous transmit context consists of two registers: CommandPtr and IT ContextControl. CommandPtr is used by software to tell the IT DMA controller where the DMA context program begins. IT ContextControl is used by software to control the context's behavior, and is used by hardware to indicate current status.

9.2.1 CommandPtr

The CommandPtr register specifies the address of the context program which will be executed when a DMA context is started. All descriptors are 16-byte aligned, so the four least-significant bits of any descriptor address must be zero. The four least-significant bits of the CommandPtr register are used to encode a Z value that indicates how many physically contiguous descriptors are pointed to by descriptorAddress.

Refer to section 3.1.5 for a full description of the CommandPtr register.

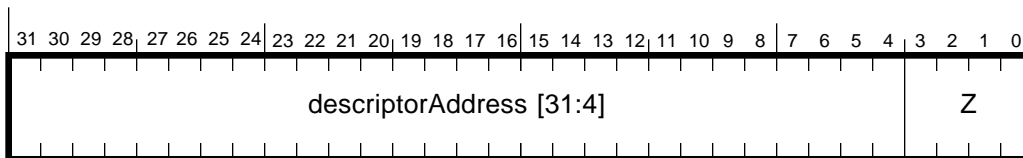

Figure 9-6 — CommandPtr register format

9.2.2 IT ContextControl Register

The IT *ContextControl* set and clear registers contains bits that control options, operational state, and status for the isochronous transmit DMA contexts. Software can set selected bits by writing ones to the corresponding bits in the *ContextControlSet* register. Software can clear selected bits by writing ones to the corresponding bits in the *ContextControlClear* register. It is not possible for software to set some bits and clear others in an atomic operation. A read from either register will return the same value.

The context control register used for isochronous transmit DMA contexts is shown below. It includes several fields which permit software to filter packets based on various combinations of fields within the isochronous packet header.

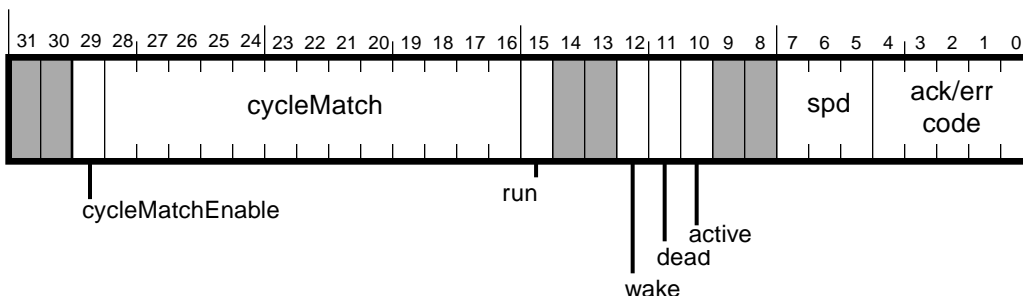

Figure 9-7 — IT DMA ContextControl (set and clear) register format

Table 9-7 — IT DMA ContextControl (set and clear) register description

field	rscu	description
cycleMatchEnable	rscu	In general, when set to one, the context will begin running only when the 13-bit cycleMatch field matches the 13-bit cycleCount in the cycleStart packet. The effects of this bit however are impacted by the values of other bits in this register and are explained below. Once the context has become active, hardware clears the cycleMatchEnable bit.
cycleMatch	rsc	Contains a 13-bit value, corresponding to the 13-bit cycleCount field. If contextControl.cycleMatchEnable is set, then this IT DMA context will become enabled for transmits when the bus cycletime.cycleCount value equals the cycleMatch value.
run	rsc	Refer to section 3.1.1 and the description following this table for an explanation of the contextControl.run bit.
wake	rsu	Refer to section 3.1.2 for an explanation of the contextControl.wake bit.
dead	ru	Refer to section 3.1.4 for an explanation of the contextControl.dead bit.
active	ru	Refer to section 3.1.3 for an explanation of the contextControl.active bit.

Table 9-7 — IT DMA ContextControl (set and clear) register description

field	rscu	description
spd	ru	This field is not meaningful for isochronous transmit contexts.
ack/err code	ru	Following an OUTPUT_LAST* command, the error code is indicated in this field. Possible values are: ack_complete, evt_descriptor_read , evt_data_read and evt_unknown. See Table 3-2, "Packet event codes," for descriptions and values for these codes.

The cycleMatch field is used to start an IT DMA context program on a specified cycle. Software enables matching by setting the cycleMatchEnable bit. When the cycleStart.cycleCount value matches the cycleMatch value, hardware sets the cycleMatchEnable bit to 0, sets the contextControl.active bit to 1, and begins executing descriptor blocks for the context. The transition of an IT DMA context to the active state, from the not-active state is dependent upon the values of the run and cycleMatchEnable bits.

- If run transitions to 1 when cycleMatchEnable is 0, then the context will become active (active = 1).
- If both run and cycleMatchEnable are set to 1, then the context will become active when the 13-bit cycleCount field in the cycleStart packet matches the 13-bit cycleMatch value.
- If both run and cycleMatchEnable are set to 1, and cycleMatchEnable is subsequently cleared, the context becomes active.
- If both run and active are 1 (the context is active), and then cycleMatchEnable is set to 1, this will result in unspecified behavior.

9.3 Isochronous transmit DMA controller

The following sections describe how software manages the multiple isochronous transmit DMA contexts. Each context has a commandPtr pointing to the current DMA descriptor. For every cycle start packet that the Host Controller receives or sends, the IT DMA controller can transmit one descriptor block from each DMA context that is in the ContextControl.run state.

9.3.1 IT DMA Processing

Each of the DMA command pointers in this *isochronous transmit command array* corresponds to a list of packets to be sent on successive cycles. Generally, each list represents a single isochronous channel. Isochronous channel numbers are not tied to the entry index in the isochronous transmit command array. The DMA context program pointed to by each array entry will specify the entire isochronous packet header, including the isochronous channel number, for each packet that is transmitted. The entire ITDMA is summarized in the following figure:

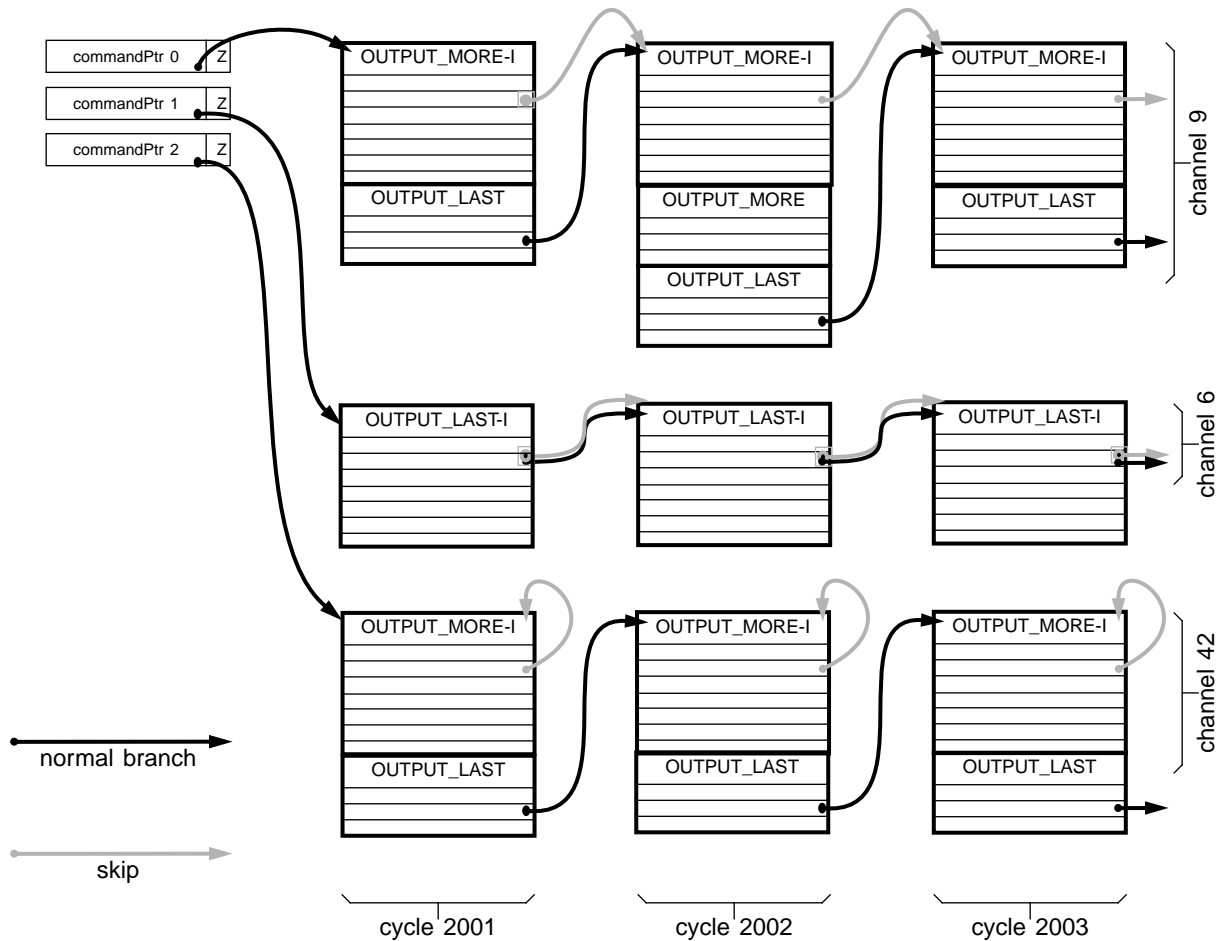

Figure 9-8 — ITDMA summary

In the example, three channels are being transmitted. Three cycles of transmit are shown. Context 0 is sending on isochronous channel 9, using an OUTPUT_MORE-Immediate to send each packet header and an OUTPUT_LAST for each payload. In cycle 2002 the payload spans a page boundary, so channel 9 uses an extra OUTPUT_MORE. Channel 9 will skip to the next packet if any cycle is lost. Context 1 is sending on isochronous channel 6, with zero length packets and only headers. Because channel 6 uses a single descriptor per packet, the skip branch is equal to the normal next packet branch. Context 2 is sending on isochronous channel 42, with each skip branch pointing to itself. If a cycle is lost, channels 6 and 9 will advance to the next packet, while channel 42 will fall behind by one packet, without skipping any packets.

For each cycle, the IT DMA controller will complete one descriptor block for each active IT DMA context. If there is a disruption while the IT DMA controller is processing a context, such as a bus reset or the loss of the isochronous phase, the IT DMA controller is required to continue through its list of active contexts taking the skip branch address for each of the remaining contexts.

9.3.2 Isochronous transmit cycle loss

The IT DMA controller can send multiple packets (multiple isochronous channels) in each isochronous cycle. Because isochronous cycles can be lost, the ITDMA is organized so that one cycle's worth of packets can be skipped, if necessary, to catch up. The loss of an isochronous cycle is usually uncommon, and typically results from a bus reset.

If isochronous cycles were lost, and no corrective action was taken, the transmitter would gradually fall behind, sending each packet some number of cycles after the transmission time intended by software.

In order to permit the transmitter to avoid falling behind, each packet in an IT DMA context program contains a skip branch address. Any time the IT DMA wants to correct for a cycle loss, it will follow this branch instead of transmitting the packet. Software can use this branch in at least three ways. 1) Branching to the next packet will cause the IT DMA to skip packets to recover from cycle loss. 2) Branching to the same packet will cause the IT DMA to fall behind (on that channel only) without skipping any packets due to cycle loss. 3) Branching to an alternate context program can allow the generation of an interrupt, and the possible early completion of transmission. 4) Stopping the IT DMA context program due to cycle loss. Software can use the third and fourth methods to cease transmission on cycle loss in the application-specific case that the receiver cannot tolerate either late or lost packets.

Because the Host Controller will generally load isochronous transmit packets into a FIFO in advance of transmission, some packets may be considered complete when cycle loss is detected, even though they have not yet left the transmit FIFO. In this situation, the Host Controller will hold those packets in the FIFO until they can be transmitted, and will then complete the transmission of all other packets that had been intended to go out in the same cycle. The Host Controller will then apply the skip branching on the packets for the next cycle (the first cycle for which no transmission has been performed). If a context in the ITDMA is arranged to skip packets on cycle loss, the packet skipped will be the one scheduled for the cycle following the cycle that was lost. If the Host Controller preloads more than one cycle's worth of packets, the skip may be delayed by a similar number of cycles, so that the transmit FIFO can empty normally, without being flushed.

The illustration below shows how each of these cases works. In this example, the ITDMA attempts to keep two cycles ahead of the bus. In other words, it tries to have two complete cycles in the transmit FIFO (if they will fit) whenever possible. Context A illustrates case 1 (above), where the skip branch is chosen so that packets are skipped. Note that because of the FIFO preload, the two packets skipped on Context A (A_4 and A_5) follow a delayed packet (A_3) that was already in the FIFO. While it might have been possible to skip only one packet if the FIFO was flushed, it would be much harder for the Host Controller to have packet A_5 ready in time to send it on cycle 6. Context B illustrates case 2, where packets are not skipped. While context A loses two packets, context B instead falls two cycles behind. Context C illustrates case 3, where transmission ends in response to a detected cycle loss. Packets C_2 and C_3 were already in the FIFO, so they are transmitted, followed by the end-of-program packet C_x . The descriptor block for packet C_x loops to itself in case additional cycles are lost before C_x is sent. This loop guarantees that C_x will be sent before the program ends. Context D illustrates case 4, where transmission ends in response to a detected cycle loss without an end-of-program packet. The skip address indicates the end of list ($Z=0$) and no more packets are loaded into the FIFO upon detection of cycle loss.

In these examples, the packets that are “in the FIFO” assume an infinitely large transmit FIFO. The Host Controller will transmit packets as shown, even if they are too big to actually fit into the FIFO. The behavior of the Host Controller in response to a lost cycle does not depend on the implementation-specific transmit FIFO size.

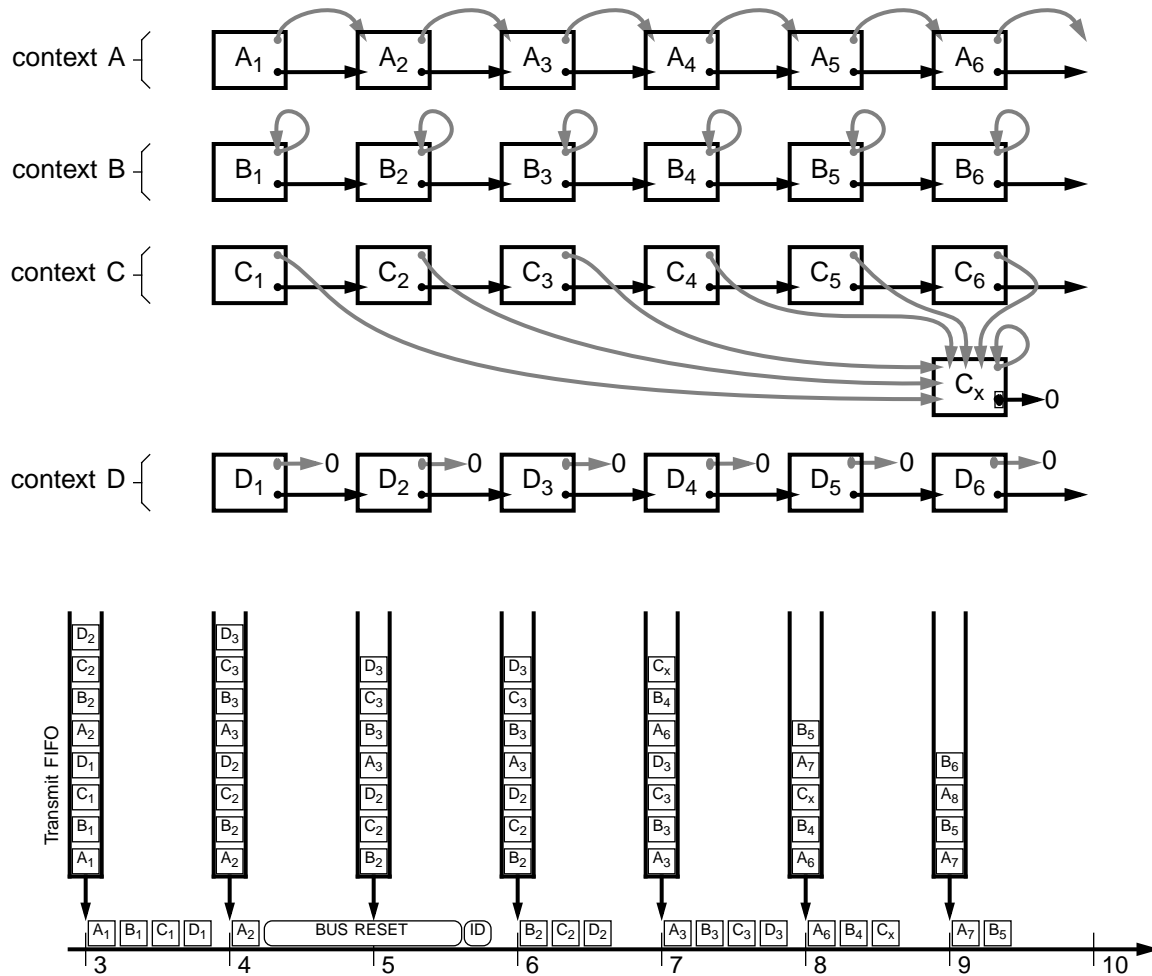

Figure 9-9 — Isochronous transmit cycle loss example

If a cycle loss is detected while the IT DMA is mid packet, that context’s descriptor block will not branch to the skipAddress, but will advance to the next descriptor block.

9.3.3 Determining the number of implemented IT DMA contexts

The number of supported isochronous transmit DMA contexts will vary for 1394 OpenHCI implementations from a minimum of four to a maximum of 32. Software can determine the number of supported IT DMA contexts by writing 32’hFFFF_FFFF to isoXmitIntMask register (see section 6.2.3.1), and then reading it back. Bits returned as 1’s indicate supported contexts, and bits returned as 0’s indicate unsupported/unimplemented contexts.

9.4 IT Interrupts

Each of the possible 32 isochronous transmit contexts can generate an interrupt, so each IT context has a bit in the isoXmitIntEvent register. Software can enable interrupts on a per-context basis by setting the corresponding isoXmitMask bit to one.

To efficiently handle interrupts which could conceivably be generated from 32 different contexts in close proximity to one another, there is a single bit for all IT DMA contexts in the Host Controller IntEvent register. This bit signifies that at least one but potentially several IT DMA contexts attempted to generate an interrupt. Software can read the isoXmitIntEvent register to find out which context(s) are involved. For more information on the isoXmitIntEvent register, see section 6.2.3.1.

9.5 IT Data Format

An isochronous transmit packet consists of two header quadlets (as specified in either the OUTPUT_MORE-Immediate or OUTPUT_LAST-Immediate descriptor) and a data payload. The data payload in host memory is not required be aligned on a quadlet boundary. Padding is added by the Host Controller if needed. The format is as follows.

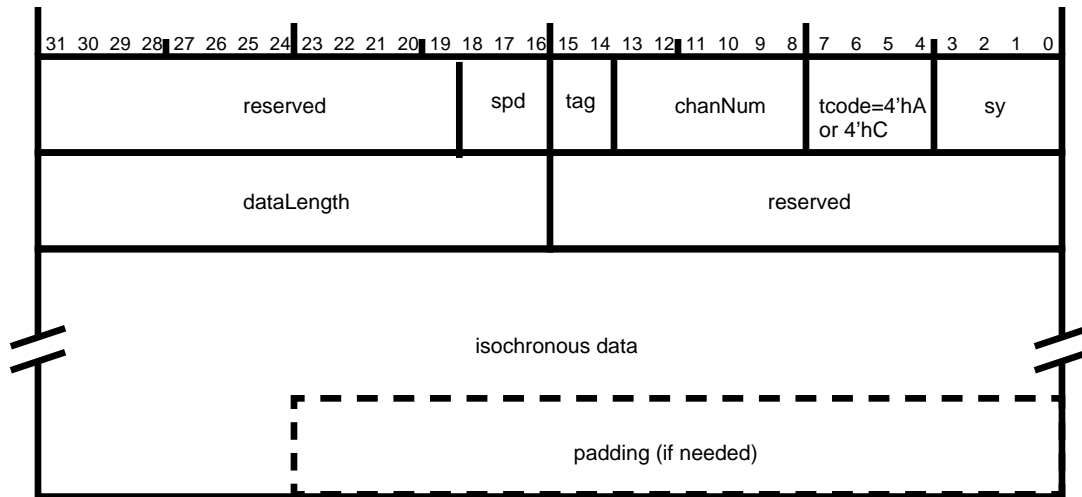

Figure 9-10 — Isochronous transmit format with header/cycleNumber

Table 9-8 — Isochronous transmit fields

field name	bits	description
spd	3	The speed at which the packet will be transmitted.
tag	2	The data format of the isochronous data (see IEEE 1394 specification)
chanNum	6	The channel number this data is associated with.
tcode	4	The transaction code for this packet.
sy	4	Transaction layer specific synchronization bits.
dataLength	16	Indicates the number of bytes in this packet.

Table 9-8 — Isochronous transmit fields (Continued)

field name	bits	description
isochronous data		The data to be sent with this packet. The first byte of data must appear in byte 0 of the first quadlet of this field. The last quadlet should be padded with zeroes, if necessary.
padding		If the dataLength mod 4 is not zero, then zero-value bytes are added onto the end of the packet to guarantee that a whole number of quadlets is sent.

10. Isochronous Receive DMA

The Isochronous Receive DMA (IR DMA) controller has a required minimum of four and an implementation maximum of 32 isochronous receive DMA contexts. Each context is controlled by a DMA context program. One single IR DMA context can receive packets from multiple isochronous channels, and the remaining DMA contexts can each receive packets from a single isochronous channel. IR DMA contexts can either receive exactly one packet per buffer, or they can concatenate packets into a stream that completely fills each of a series of buffers. Packets may be received with or without isochronous packet headers and timeStamps.

10.1 Context Programs

For isochronous receive DMA, a context program is a list of DMA descriptors used to identify buffers in host memory into which the Host Controller places received isochronous packets. The descriptors are 16 bytes in length and must be aligned on a 16 byte boundary. There are two kinds of descriptor commands available: INPUT_MORE and INPUT_LAST.

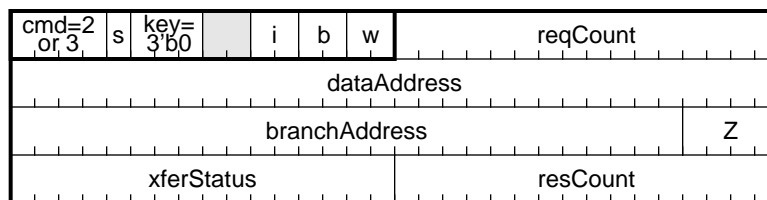

Figure 10-1 — Isochronous receive descriptor

Table 10-1 — Descriptor element summary

Element	Bits	Description
cmd	4	Set to 4'h2 for INPUT_MORE, or set to 4'h3 for INPUT_LAST. INPUT_MORE is required for receiving packets in buffer-fill mode (see section 10.2.1), and may also be used in packet-per-buffer mode. INPUT_LAST is required for receiving packets in packet-per-buffer mode (see section 10.2.2), and must be the final descriptor in a descriptor block. It is not permitted in buffer-fill mode.
s	1	Used with <u>packet-per-buffer</u> mode only (see section 10.2.2). If set to one, xferStatus and resCount will be updated upon descriptor completion. If set to zero, neither field is updated. Assumed to be one for buffer-fill mode.
key	3	This field must be set to 3'b0.
i	2	Interrupt control. Valid values are 2'b11 to generate an IsochRx interrupt when the descriptor is completed (see section 6.2.1), or 2'b00 for no interrupt. Behavior is unspecified for 2'b01 and 2'b10.
b	2	Branch control. Valid values are 2'b11 to branch to branchAddress, and 2'b00 not to branch. Behavior is unspecified for 2'b01 and 2'b10. For <u>buffer-fill</u> mode (see section 10.2.1), this field must always be set to 2'b11. For <u>packet-per-buffer</u> mode (see section 10.2.2), this field must be 2'b00 for INPUT_MORE commands and 2'b11 for INPUT_LAST commands.
w	2	Wait control. Valid values are 2'b11 to wait for a packet with a sync field which matches the sync specified in the context's IRContextMatch register (see section 10.3), or 2'b00 not to wait. For <u>packet-per-buffer</u> mode, 2'b11 can only be used in the first descriptor of a descriptor block. Behavior is unspecified for 2'b01 and 2'b10.
reqCount	16	Request count: The size of the input buffer in bytes.

Table 10-1 — Descriptor element summary

Element	Bits	Description
dataAddress	32	Address of receive buffer. If in <u>packet-per-buffer</u> mode and receiving headers, dataAddress must be quadlet aligned.
branchAddress	28	16-byte aligned address of the next descriptor. This field is not used for INPUT_MORE commands in packet-per-buffer mode.
Z	4	For <u>buffer-fill</u> mode (see section 10.2.1), Z must be either 1 to indicate the branchAddress is a valid address for the next INPUT_MORE, or 0 to indicate this descriptor is the end of the context program. For <u>packet-per-buffer</u> mode (see section 10.2.2), if the command is INPUT_LAST, Z may be a value from 1 to 8 to indicate the number of descriptors in the next descriptor block, or 0 to indicate the end of the context program. If the command is INPUT_MORE, then Z is not used.
xferStatus	16	Composed of 16-bits from ContextControl[15:0]. For <u>buffer-fill</u> mode, xferStatus is written when resCount is updated. For <u>packet-per-buffer</u> mode, xferStatus is written after the descriptor is processed if s = 1.
resCount	16	Residual count: The number of bytes remaining in the dataAddress buffer (out of a maximum of reqCount). Written if in packet-per-buffer mode and s = 1, or each time a packet is received in buffer-fill mode. For further details on when resCount is updated in buffer-fill mode, see section 10.2.1.

The Z value is used by the Host Controller to fetch multiple command descriptors at once, for improved efficiency. Z values must always be encoded correctly. The contiguous descriptors described by a Z value are called a *descriptor block*. The following table summarizes all legal Z values:

Table 10-2 — Z value encoding

Z value	Use
0	Indicates that the current descriptor is the last descriptor in the context program.
1-8	Indicates that 1 to 8 descriptors starting at descriptorAddress are physically contiguous.
9-15	reserved

To indicate the end of the context program, all IR DMA context programs must indicate the end of the program by using a command descriptor with a *b* value of 2'b11 (branch always) and a Z value of 0. A context program can be appended to while the DMA runs, even if the DMA has already reached the last descriptor. section 3.2.1.2 describes how to append to a context program.

When an IR DMA context is running and/or active, software shall not modify any command descriptors within the context program with the exception of the last command descriptor (the one descriptor in a program with *b*=2'b11 and *Z*=4'h0). The last command descriptor may only be modified according to the steps described in section 3.2.1.2.

10.2 Receive Modes

The Host Controller can write isochronous receive packets into host memory buffers in one of two ways. It can place them using either buffer-fill mode or packet-per-buffer mode.

10.2.1 Buffer Fill Mode

In bufferFill mode, all received packets are concatenated into a contiguous stream of data. This data is then metered out into buffers described by a DMA context program, filling each buffer completely. Packets may straddle multiple buffers in this mode (see packet 2 in the illustration below).

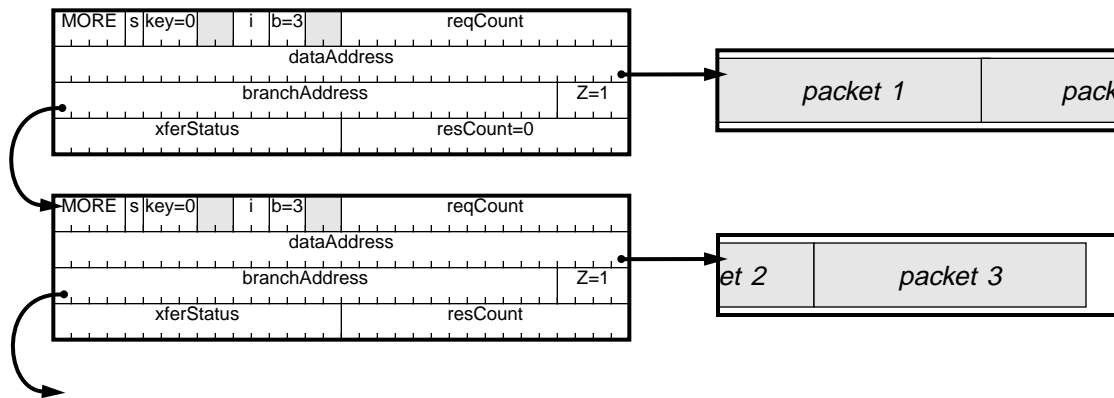

Figure 10-2 — IR Buffer Fill Mode

A context program for an isochronous receive context in buffer-fill mode consists of a list of independent INPUT_MORE descriptors, each branching to the next descriptor in the list. Since each descriptor must always branch to the subsequent one, the *b* field must always be set to 2'b11 to indicate a branch. If a buffer-fill mode INPUT_MORE descriptor is not the last descriptor in the list, its *Z* value must be set to 1 to instruct the Host Controller to fetch the next single descriptor. If it is the last one in the list, *Z* must be set to 0.

As depicted above, it is possible for a received packet to straddle multiple buffers. To ensure that the receive buffers for a context remain parsable, hardware must follow the following procedure.

- 1) After filling to the end of a buffer with a partial packet, advance to the next descriptor block and obtain the next buffer (*dataAddress*), retaining all state for the first buffer as well as for the new buffer.
- 2) Continue writing packet bytes into the subsequent buffer(s). If the end of a buffer is reached, advance to the next buffer without updating status and without retaining state for any of the interim buffers. Write the remaining packet bytes into the final packet buffer.
- 3) If there is no data error: a) conditionally write the trailer quadlet into the last buffer, b) update *xferStatus* and *resCount* into the **final** buffer's descriptor, and c) update *xferStatus* and *resCount* into the **first** buffer's descriptor. At that point the previous state of the first buffer is no longer needed.
- 4) If there is a data-length or CRC error, then the packet must be 'backed-out' by reverting back to the previous state (as saved earlier). *XferStatus* and *resCount* are not updated for either descriptor.

By following these steps, the IR context buffers remain intact and can be parsed. Since interim buffers (those containing an inner portion of one packet) will not have their status updated, software must only use *resCount* values when the corresponding *xferStatus* indicates the run bit is set to one. It follows from this that if the *xferStatus.run* bit is set in a descriptor, then all prior descriptors have been filled.

10.2.2 Packet-per-Buffer Mode

In packet-per-buffer mode, each received packet is placed in the buffer(s) described by one descriptor block. Any leftover bytes are discarded, and packets never straddle multiple descriptor blocks. Both INPUT_MORE and INPUT_LAST are allowed in packet-per-buffer mode. Each INPUT_LAST marks the end of a packet, though the final byte may have been used up in a previous INPUT_MORE (see packet 2 in the illustration below). Each packet starts in an INPUT_* command that follows an INPUT_LAST.

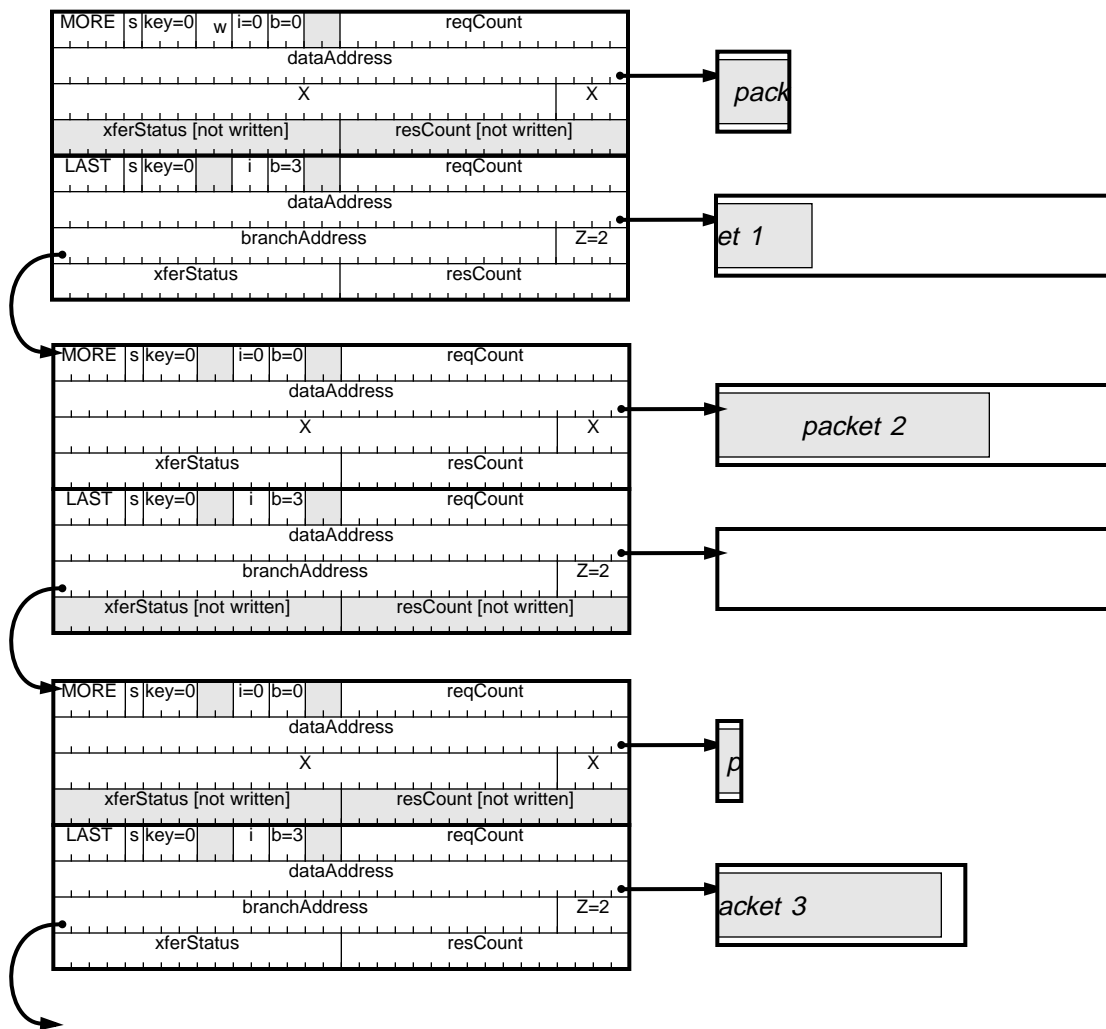

Figure 10-3 — packet-per-buffer receive mode

A context program for an isochronous receive context in packet-per-buffer mode consists of a series of descriptor blocks. Each descriptor block will receive one packet and must contain a contiguous set of 0 to 7 INPUT_MORE descriptors, followed by one INPUT_LAST descriptor. This requirement permits the Host Controller to prefetch all the descriptors for a packet, in order to avoid fetching additional descriptors during a packet transfer. INPUT_MORE descriptors must have the *b* field set to 2'b00 (never branch). INPUT_LAST descriptors must have the *b* field set to 2'b11 (always branch), and must either have a valid address in branchAddress with a Z value of 1 to 8, or must have a Z value of 0 to indicate it's the last descriptor in the context program.

IR context programs may use the w (wait) fields to wait for a packet with a matching sync value (see section 10.3.3, “Isochronous receive contextMatch register;”). Wait is only valid for the first descriptor in a descriptor block, and is set to 2'b11 to wait and 2'b00 to not wait. If w is 2'b11, the context will wait for the configured syn (and tag) match before running/using the descriptor. The w field for all other descriptors in the descriptor block must be 2'b00.

10.2.2.1 Command.xferStatus and Command.resCount updates

In packet-per-buffer mode, the xferStatus and resCount fields are updated only in the descriptor for the buffer which receives the last byte of the packet. ResCount is only valid in a descriptor, if the xferStatus field has the contextControl.run bit set. To obtain accurate values for xferStatus, it is recommended that software initialize xferStatus to zero.

In figure 10-3 above, there are 3 shaded xferStatus quadlets. The shaded quadlets are status fields that were never updated, and the unshaded status quadlets reflect status fields that were updated. In the top descriptor block, the xferStatus quadlet in the first descriptor was not written because packet 1 did not complete in the first descriptor’s buffer. In the middle descriptor block, the first descriptor was big enough to hold packet 2 completely. Since the first descriptor’s buffer received the last byte of packet 2, the first descriptor’s status was written, and the second descriptor’s status is ignored.

If a descriptor block describes buffer space that cannot fit an entire packet (including header if isochHeader mode is enabled), then the overflow bytes are discarded. When this occurs, xferStatus.ack will be set to evt_long_packet.

10.3 IR Context Registers

Each isochronous receive context consists of three registers: CommandPtr, IRContextControl, and IRContextMatch. CommandPtr is used by software to tell the IR DMA controller where the DMA context program begins. IRContextControl is used by software to control the context’s behavior, and is used by hardware to indicate current status. IRContextMatch is used to start on a specified cycle number and to filter received packets based on their tag bits and possibly sync bits. This section describes each register in detail.

10.3.1 CommandPtr

The CommandPtr register specifies the address of the context program which will be executed when a DMA context is started. All descriptors are 16-byte aligned, so the four least-significant bits of any descriptor address must be zero. The four least-significant bits of the CommandPtr register are used to encode a Z value that indicates how many physically contiguous descriptors are pointed to by descriptorAddress. In buffer-fill mode, Z will be either one or zero. In packet-per-buffer mode, Z will be from zero to eight.

Refer to section 3.1.5 for a full description of the CommandPtr register.

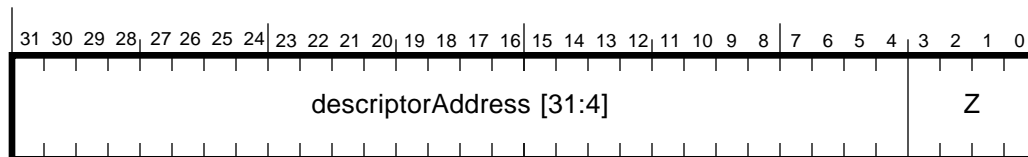

Figure 10-4 — CommandPtr register format

10.3.2 IRContextControl register (set and clear)

The *IRContextControl* register contains bits that control options, operational state, and status for the isochronous receive DMA contexts. Software can set selected bits by writing ones to the corresponding bits in the *ContextControlSet* register. Software can clear selected bits by writing ones to the corresponding bits in the *ContextControlClear* register. It is not possible for software to set some bits and clear others in an atomic operation. A read from either register will return the same value.

The context control register used for isochronous receive DMA contexts is shown below. It includes several fields which permit software to filter packets based on various combinations of fields within the isochronous packet header.

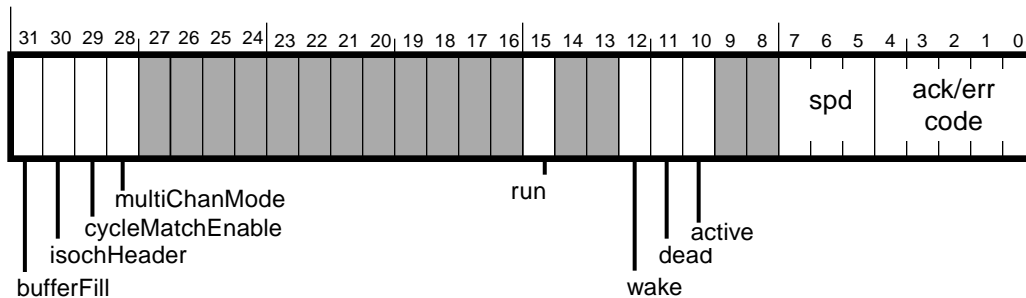

Figure 10-5 — IR DMA ContextControl (set and clear) register format

Table 10-3 — IR DMA ContextControl (set and clear) register description

field	rscu	description
bufferFill	rsc	When set to one, received packets are placed back-to-back to completely fill each receive buffer (specified by an INPUT_MORE command). When clear, each received packet is placed in a single buffer (described by zero to seven INPUT_MORE commands followed by an INPUT_LAST command). If the multiChanMode bit is set to one, this bit must also be set to one. The value of the bufferFill bit must not be changed while contextControl.active is set to one.
isochHeader	rsc	When set to one, received isochronous packets will include the complete 4-byte isochronous packet header seen by the link layer. The end of the packet will be marked with a xferStatus (bits 15:0 of this register) in the first doublet, and a 16-bit timeStamp indicating the time of the most recently received (or sent) cycleStart packet. When clear, the packet header is stripped off of received isochronous packets. The packet header, if received, immediately precedes the packet payload. Details are shown in section 10.6.
cycleMatchEnable	rscu	In general, when set to one, the context will begin running only when the 13-bit cycleMatch field in the contextMatch register matches the 13-bit cycleCount in the cycleStart packet. The effects of this bit however are impacted by the values of other bits in this register and are explained below. Once the context has become active, hardware clears the cycleMatchEnable bit.
multiChanMode	rsc	When set to one, the corresponding isochronous receive DMA context will receive packets for all isochronous channels enabled in the IRChannelMaskHi and IRChannelMaskLo registers (see section 10.4.1.1). The isochronous channel number specified in the IRDMA context match register is ignored. When set to zero, the IRDMA context will receive packets for that single channel. Only one IRDMA context may use the IRChannelMask registers. If more than one IRDMA context control register has the multiChanMode bit set, results are undefined. See section 10.4.3 for more information.
run	rscu	Refer to section 3.1.1 for an explanation of the contextControl.run bit.

Table 10-3 — IR DMA ContextControl (set and clear) register description

field	rscu	description
wake	rsu	Refer to section 3.1.2 for an explanation of the contextControl.wake bit.
dead	ru	Refer to section 3.1.4 for an explanation of the contextControl.dead bit.
active	ru	Refer to section 3.1.3 for an explanation of the contextControl.active bit.
spd	ru	This field indicates the speed at which the packet was received. 3'b000 = 100 Mbits/sec, 3'b001 = 200 Mbits/sec and 3'b010 = 400 Mbits/sec. All other values are reserved.
ack/err code	ru	Following an INPUT* command, the error code is indicated in this field. For <u>bufferFill</u> mode, possible values are: ack_complete, ack_data_error, evt_overrun, evt_descriptor_read, evt_data_write and evt_unknown. Packets with data errors (either dataLength mismatches or dataCRC errors) are 'backed-out' as described in section 10.2.1. For <u>packet-per-buffer</u> mode, possible values are: ack_complete, ack_data_error, evt_short_packet, evt_long_packet, evt_overrun, evt_descriptor_read, evt_data_write and evt_unknown. See Table 3-2, "Packet event codes," for descriptions and values for these codes.

The cycleMatchEnable bit is used to start an IR DMA context program on a specified cycle. When the cycleStart.cycleCount value matches the cycleMatch value (in the IR contextMatch register), hardware sets the cycleMatchEnable bit to 0, sets the contextControl.active bit to 1, and begins executing descriptor blocks for the context. The transition of an IR DMA context to the active state, from the not-active state is dependent upon the values of the run and cycleMatchEnable bits.

- If run transitions to 1 when cycleMatchEnable is 0, then the context will become active (active = 1).
- If both run and cycleMatchEnable are set to 1, then the context will become active when the 13-bit cycleCount field in the cycleStart packet match the 13-bit cycleMatch value indicated in the IR contextMatch register.
- If both run and cycleMatchEnable are set to 1, and cycleMatchEnable is subsequently cleared, the context becomes active.
- If both run and active are 1 (the context is active), and then cycleMatchEnable is set to 1, this will result in unspecified behavior.

10.3.3 Isochronous receive contextMatch register

The IR ContextMatch register is used to start a context running on a specified cycle number, and is also used to filter incoming isochronous packets based on specified sync and tag values. All packets are checked for a matching tag value, and a compare on sync is only performed when the descriptor's w field is set to 2'b11. See section 10.1 for restrictions in setting the w field. This register should only be written when contextControl.active is 0, otherwise unspecified behavior will result.

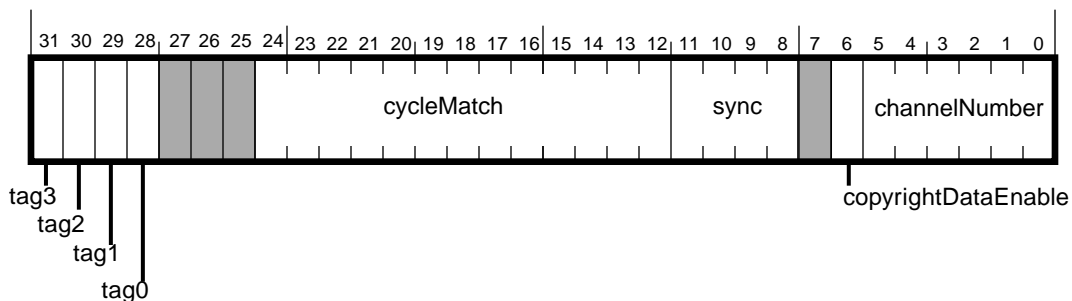

Figure 10-6 — IR DMA ContextMatch (set and clear) register format

Table 10-4 — IR DMA ContextMatch (set and clear) register description

field	rwu	description
tag3	rw	If set, this context will match on isochronous receive packets with a tag field of 2'b11.
tag2	rw	If set, this context will match on isochronous receive packets with a tag field of 2'b10.
tag1	rw	If set, this context will match on isochronous receive packets with a tag field of 2'b01.
tag0	rw	If set, this context will match on isochronous receive packets with a tag field of 2'b00.
cycleMatch	rw	Contains a 13-bit value, corresponding to the 13-bit cycleCount field in the cycleTimer register. If contextControl.cycleMatchEnable is set, then this IR DMA context will become enabled for receives when the bus cycletime.cycleCount value equals the cycleMatch value.
sync	rw	This field contains the 4 bit field which is compared to the sync field of each isochronous packet for this channel when the command descriptor's w field is set to 2'b11.
copyrightDataEnable	rw	If set, this bit enables the reception of copyright information.
channelNumber	rw	This six bit field indicates the isochronous channel number for which this IR DMA context will accept packets.

At least one tag bit must be set to 1, otherwise no received packets will match and the context will, in effect, wait forever.

10.4 Isochronous receive DMA controller

The following sections describe how software manages the multiple isochronous receive DMA contexts. Each context has a commandPtr pointing to the initial DMA descriptor, a contextControl register, and a contextMatch register to start the context based on a cycle number and to filter packets. The IR DMA controller has one set of IRMultiChanMask registers used to specify a set of isochronous channels for the single isochronous context in multiChanMode.

10.4.1 Isochronous receive multi-channel support

Any IR DMA context can receive packets from multiple isochronous channels per cycle by enabling contextControl.multiChanMode and using the IRMultiChanMask registers. There is a single set of IRMultiChanMask registers available in the IR DMA controller, and only **one** IR DMA context may be using them at any given time as determined by the setting of contextControl.multiChanMode bit (see section section 10.3.2).

A context to be enabled for multiChanMode, must also be enabled for bufferFill and isochHeader modes. If multiChanMode is enabled without bufferFill and isochHeader, the resulting behavior is undefined.

If an IR DMA context is in multi-channel mode, therefore using the IRMultiChanMask registers, the isochronous channel field in the IR DMA context Match register (section 10.3.3) is ignored.

10.4.1.1 IRMultiChanMask registers (set and clear)

An isochronous channel mask is used to enable packet receives from up to 64 specified isochronous data channels. Software enables receives for any number of isoch channels by writing ones to the corresponding bits in the IRMultiChanMaskHiSet and IRMultiChanMaskLoSet addresses. To disable receives for any isoch channels, software writes ones to the corresponding bits in the IRMultiChanMaskHiClear and IRMultiChanMaskLoClear addresses.

A read of each IRChanMask register shows which channels are enabled; a one for enabled, a zero for disabled. The IRMultiChanMask registers are not changed by a bus reset. The state of these registers is undefined following a hard reset or soft reset.

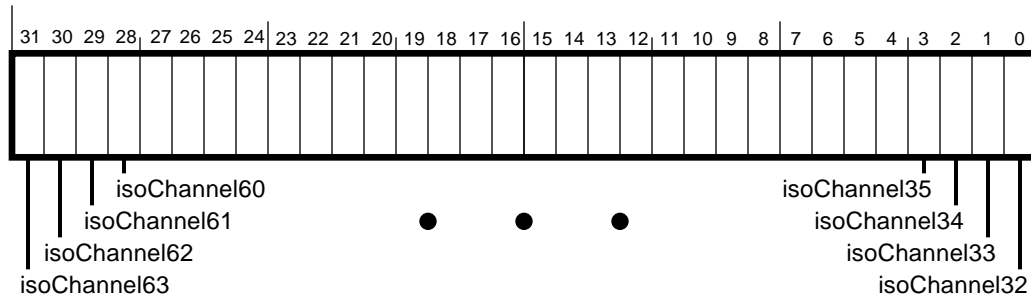

Figure 10-7 — IRMultiChanMaskHi (set and clear) register

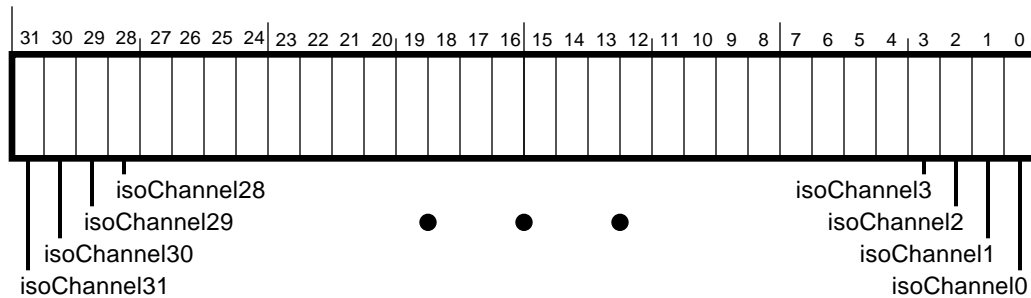

Figure 10-8 — IRMultiChanMaskLo (set and clear) register

10.4.2 Isochronous receive single-channel support

Each isochronous receive DMA context can receive one packet per cycle from one isochronous data channel. Data chaining across DMA context commands is supported when the contextControl.bufferFill bit is set.

To configure a context to receive packets from an isochronous channel, write the channel number into the contextMatch register’s channelNumber field.

To start a context on a particular cycle, write the starting cycle time into the contextMatch register, and enable the contextControl.cycleMatchEnable and contextControl.run bits. When the bus cycleTime.cycleCount value equals the contextMatch.cycleMatch value, the IR DMA controller will clear the contextControl.cycleMatchEnable bit and the context will begin receiving packets. (see sections 10.3.2 and 10.3.3).

To wait for a packet with specified sync value in the isochronous packet header, set the desired configuration in the sync field of the contextMatch register and set the DMA command descriptor’s w (wait) field to 2’b11. When the IR DMA controller detects a w field of 2’b11, it waits until a packet arrives matching the specified sync and directs it to the buffer identified in the waiting descriptor’s dataAddress field. Packets with the specified channel number and tag bits but which do not match the specified sync are discarded.

When an IR DMA context is stopped either because it reached the end of the context program or because the run bit is cleared, some packets following the intended stop point may have already entered the receive FIFO. These packets will be discarded when they reach the bottom of the FIFO, unless another IR DMA context is able to receive them.

The IRDMA can be stopped at any time by clearing the “run” bit in the ContextControl register. However, this might mean that the last packet’s data was incompletely stored in memory.

10.4.3 Duplicate channels

If more than one IR DMA context specifies receives for packets from the same isochronous channel, the context destination for that channel’s packets is undefined.

If more than one IR DMA context has the contextControl.*multiChanMode* bit set, then the context destination for IRmultiChanMask packets is undefined.

If an isochronous channel is specified both in a single channel context and in the multiChannel context, then the packet will be routed to the multiChannel context.

10.4.4 Determining the number of implemented IR DMA contexts

The number of supported isochronous receive DMA contexts will vary for 1394 OpenHCI implementations from a minimum of four to a maximum of 32. Software can determine the number of supported IR DMA contexts by writing 32’hFFFF_FFFF to the isoRecvIntMask register (see section 6.2.4.1), and then reading it back. Bits returned as 1’s indicate supported contexts, and bits returned as 0’s indicate unsupported/unimplemented contexts.

10.5 IR Interrupts

Each of the possible 32 isochronous receive contexts can generate an interrupt, so each IR DMA context has a bit in the isoRecvIntEvent register. Software can enable interrupts on a per-context basis by setting the corresponding isoRecvMask bit to one.

To efficiently handle interrupts which could conceivably be generated from 32 different contexts in close proximity to one another, there is a single bit for all IR DMA contexts in the Host Controller IntEvent register. This bit signifies that at least one but potentially several IR DMA contexts attempted to generate an interrupt. Software can read the isoRecvIntEvent register to find out which context(s) are involved. For more information on the isoRecvIntEvent register, see section 6.2.4.

10.6 IR Data Formats

There are four formats for isochronous receive packets depending upon the setting of the ContextControl.*isochHeader* and ContextControl.*bufferFill* bits (see section 10.3). If the ContextControl.*isochHeader* bit is zero, then only the isochronous data without any padding, header quadlet or timestamp quadlet is put in the buffer.

Table 10-5 — Isochronous receive fields

field name	bits	description
dataLength	16	Indicates the number of bytes in this packet.
tag	2	The data format of the isochronous data (see IEEE 1394 specification)
chanNum	6	The channel number this data is associated with.
tcode	4	The transaction code as received for this packet.
sy	4	Transaction layer specific synchronization bits.
isochronous data		The data received with this packet. The first byte of data must appear in byte 0 of the first quadlet of this field. The last quadlet should be padded with zeroes, if necessary.

Table 10-5 — Isochronous receive fields

field name	bits	description
padding		If the <code>dataLength</code> mod 4 is not zero, then zero-value bytes have been added onto the end of the packet to guarantee that a whole number of quadlets was sent. In three formats, the pad bytes are stripped off the packet.
xferStatus	16	Contains bits [15:0] from the <code>contextControl</code> register.
timeStamp	16	The three low order bits <i>cycleSeconds</i> , and the full 13-bits of <i>cycleCount</i> at the time of the most recently received (or sent) cycle start packet.

10.6.1 bufferFill mode formats

10.6.1.1 IR with header/trailer

The format of an isochronous receive packet when `ContextControl.bufferFill=1` and `ContextControl.isochHeader=1` is shown below.

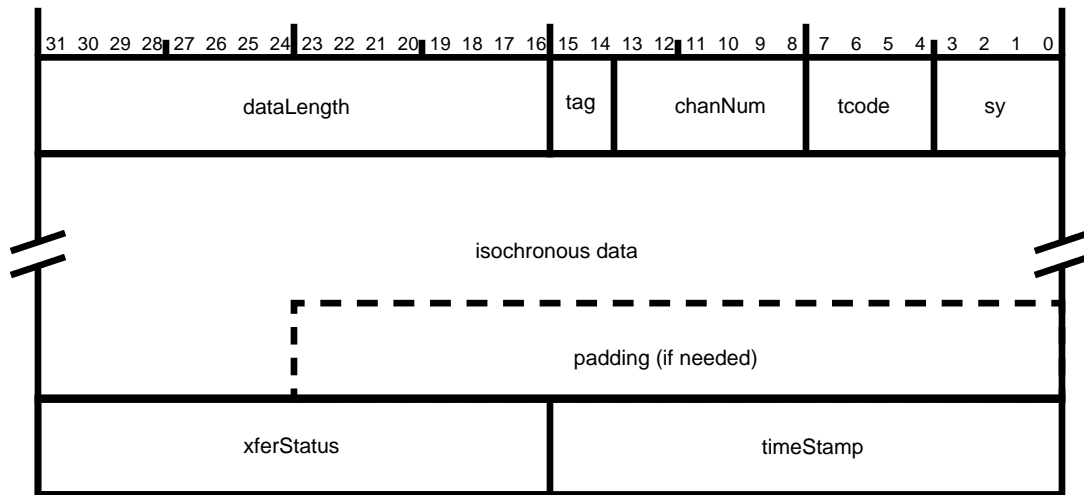

Figure 10-9 — Receive isochronous format in bufferFill mode with header/trailer

10.6.1.2 IR without header/trailer

The format of the isochronous receive packet when `ContextControl.bufferFill=1` and `ContextControl.isochHeader=0` is shown below..

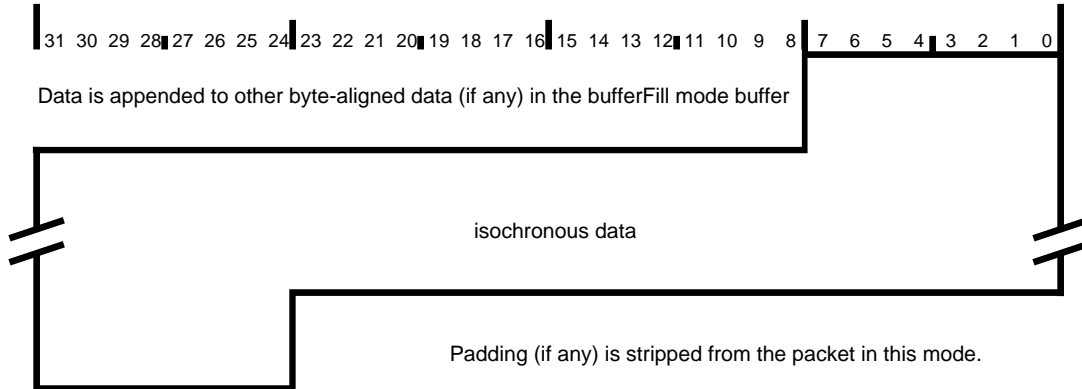

Figure 10-10 — Receive isochronous format in bufferFill mode without header/trailer

10.6.2 packet-per-buffer mode formats

10.6.2.1 IR with header/trailer

The format of an isochronous receive packet when `ContextControl.bufferFill=0` and `ContextControl.isochHeader=1` is shown below. Note that although `xferStatus` is written as a side-effect of writing `timeStamp`, `xferStatus` does not contain valid or otherwise useful values.

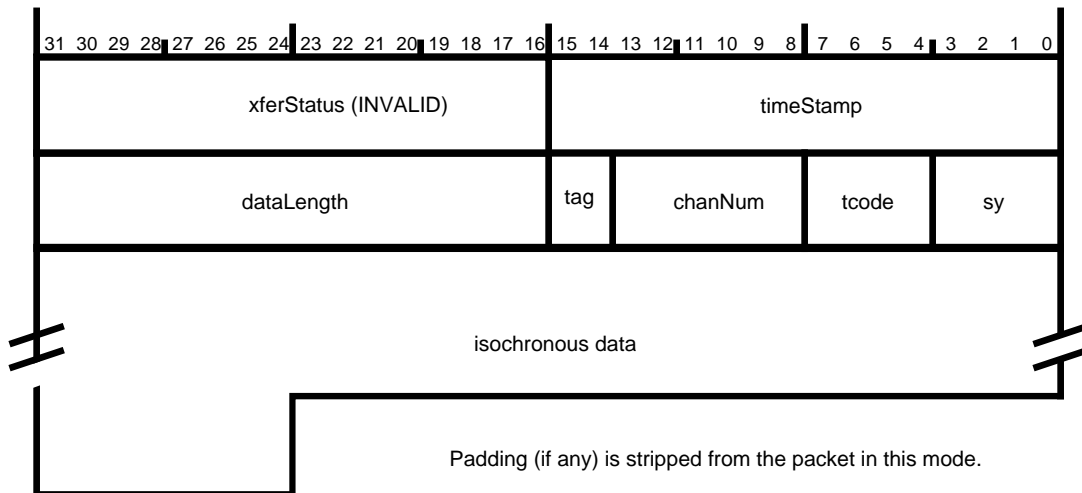

Figure 10-11 — Receive isochronous format in packet-per-buffer mode with header/trailer

10.6.3 IR without header/trailer

The format of the isochronous receive packet when `ContextControl.bufferFill=0` and `ContextControl.isochHeader=0` is shown below..

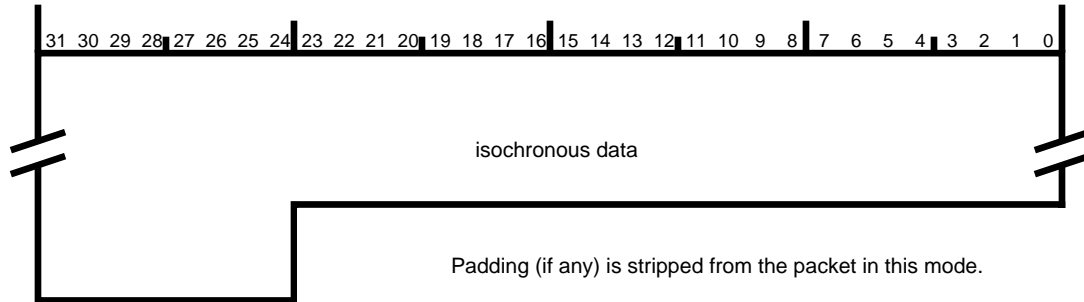

Figure 10-12 — Receive isochronous format in packet-per-buffer mode without header/trailer

11. Self ID Receive

The purpose of the SelfID DMA controller is to receive self ID packets during the bus initialization process. The self ID packets are received using a special pair of DMA registers, the Self ID Buffer Pointer register and the Self ID Count register.

11.1 Self ID Buffer Pointer Register

The Self ID Buffer Pointer register points to the buffer the SelfID packets will be DMA'ed into during bus initialization.

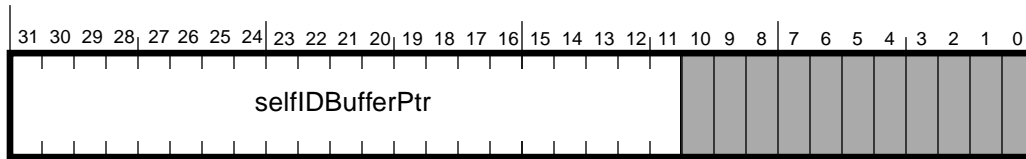

Figure 11-1 — Self ID Buffer Pointer register

Table 11-1 — Self ID Buffer Pointer register

field name	rw	description
selfIDBufferPtr	rw	Contains the 2K-byte aligned base address of the buffer in host memory where received self-ID packets are stored. The contents of this field are undefined after a chip reset.

11.2 Self ID Count Register

This register keeps a count of the number of times the bus self ID process has occurred, flags self ID packet errors and keeps a count of the amount of self ID data in the Self ID buffer.

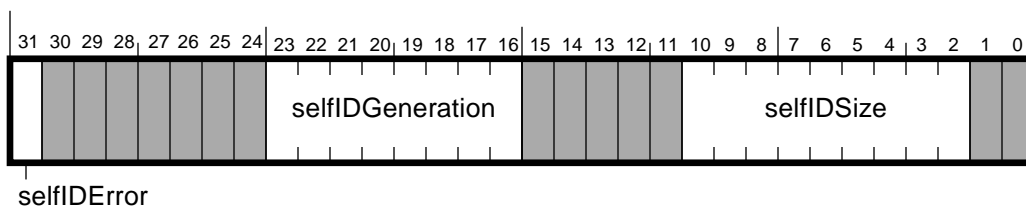

Figure 11-2 — Self ID Count register

Table 11-2 — Self ID Count register

field name	rwu	description
selfIDError	ru	When this bit is one, an error was detected during the most recent self ID packet reception. The contents of the self ID buffer are undefined. This bit is cleared after a self ID reception in which no errors are detected. Note that an error can be a hardware error or a host bus write error.
selfIDGeneration	ru	The value in this field increments each time the self ID reception process begins. This field rolls over to 0 after reaching 255. The contents of this field are undefined after a chip reset.
selfIDSize	ru	This field indicates the length (in quadlets) of self ID data that has been received. This field is cleared to zero as soon as any bus reset begins. The contents of this field are undefined after a chip reset.

The self ID stream can be $(63 \text{ devices}) * (4 \text{ packets/device}) * (8 \text{ bytes/packet}) = 2016 \text{ bytes}$. If a bus reset is received part way through a self ID sequence, the old data will be overwritten. To keep things straight, the generation counter is written into memory as the first quadlet of the stream. For a consistent stream, software reads the generation counter in memory, then the stream, then the SelfIDCount register. If the generation counter in the register matches the one in memory, then the self ID stream is consistent.

If the selfIDError flag is set, then there was either a hardware error in receiving the last self ID sequence or a host bus error while writing to the host buffer, so the self ID data is not trustworthy. Any self ID data received after the error is flushed. If all 2048 bytes are received, the selfIDSize field is set to 9'h7FF and the selfIDError flag is set. (This is only possible if >64 nodes are on the bus... a gross error condition.)

Whenever a bus reset occurs, the Host Controller clears the selfIDSize field to zero, at the same time the bus reset interrupt is triggered. This allows software responding to a bus reset to know that self IDs have not yet been received.

The Host Controller does not verify the integrity of the self-ID packets and software is responsible for performing this function (i.e. using the logical inverse quadlet).

11.3 Self-ID receive

The self-ID receive format is shown below. The first word contains the time stamp and the self ID generation number (see section 11.2 “Self ID Count Register”). The remaining quadlets contain data that is received from the time a bus reset ends to the first subaction gap. This is the concatenation of all the self-ID packets received. Note that the bit-inverted check words are included in the FIFO and must be checked by the application..

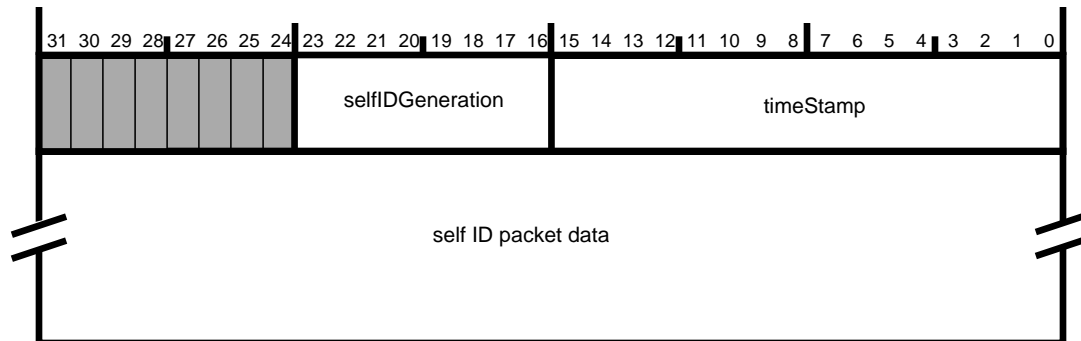

Figure 11-3 — Self-ID receive format

Table 11-3 — Self-ID receive fields

field name	description
selfIDGeneration	See table 11-2.
timeStamp	The three low order bits from <i>cycleTimer.cycleSeconds</i> , and the full 13-bits of <i>cycleTimer.cycleCount</i> at the time this status quadlet was generated.
self ID packet data	The data received during the selfID process of the bus initialization phase. Note that each selfID packet includes the data quadlet and inverted quadlet.

11.4 Enabling the SelfID DMA

The RcvSelfID bit in the LinkControl register (see section 5.8, “LinkControl registers (set and clear),”) allows the receiver to accept incoming self-identification packets. Before setting this bit, software must ensure that the self ID buffer pointer register contains a valid address.

11.5 Interrupt Considerations for SelfID DMA

The SelfIDcomplete bit in the IntEvent register (see section 6.2.1) is set and an interrupt is generated when the selfID phase of bus initialization completes. This will be generated at the end of the bus initialization process.

11.6 SelfIDs Received Outside of Bus Initialization

SelfID packets received outside of the bus initialization self-ID phase are routed to the AR DMA Request context and use the PHY packet receive format.

12. Physical Requests

When a read or write request is received, the 1394 Open HCI chip handles the operation automatically without involving software if the offset address in the request packet header meets a specific set of criteria listed below. Requests that do not meet these criteria are directed to the AR DMA Request context.

The 1394 Open HCI checks to see if the offset address in the request packet header is one of the following.

- a) If the high order 16-bits of the offset address is 16'h0000, then the lower 32 bits of the offset address are used as the memory address for the transaction. Lock transactions are not supported in this address space... they are diverted to the AR DMA Request context. For read requests, the information needed to formulate the response packet is passed to the Physical Response Unit. Requests are only accepted if the source node ID of the request has a corresponding bit in the Asynchronous Request Filter registers and Physical Request Filter registers(section 5.12).
- b) If the offset address selects one of the following addresses, the physical request unit will directly handle compare-swaps and reads (other requests will be sent an `ack_type_error`) (section 5.5.1):
 - 1) `BUS_MANAGER_ID` (48'hFFFFFF000021C). Local register is `BusManagerID`.
 - 2) `BANDWIDTH_AVAILABLE` (48'hFFFFFF0000220). Local register is `BandwidthAvailable`.
 - 3) `CHANNELS_AVAILABLE_HI` (48'hFFFFFF0000224). Local register is `ChannelsAvailableHi`.
 - 4) `CHANNELS_AVAILABLE_LO` (48'hFFFFFF0000228). Local register is `ChannelsAvailableLo`.
- c) If the offset address is one of the following addresses, the Physical Request controller will directly handle quadlet reads:
 - 1) Config ROM header (1st quadlet of the Config ROM) (48'hFFFFFF0000400). Local register is `ConfigROMheader` (section 5.5.2).
 - 2) Bus ID (1st quadlet of the `Bus_Info_Block`) (48'hFFFFFF0000404). Local register is `BusID` (section 5.5.3).
 - 3) Bus options (2nd quadlet of the `Bus_Info_Block`) (48'hFFFFFF0000408). Local register is `BusOptions` (section 5.5.4).
 - 4) Global unique ID (3rd and 4th quadlets of the `Bus_Info_Block`) (48'hFFFFFF000040C and 48'hFFFFFF0000410). Local registers are `GlobalIDHi` and `GlobalIDLo` (section 5.5.5).
 - 5) Configuration ROM (48'hFFFFFF0000414 to 48'hFFFFFF00007FF). Mapped by the `ConfigROMmapping` register to a 1K byte block of system memory (section 5.5.6)

12.1 Filtering Physical Requests

Software can control from which nodes it will receive packets by utilizing the asynchronous filter registers. There are two registers, one for filtering out all requests from a specified set of nodes (`AsynchronousRequestFilter` register) and one for filtering out physical requests from a specified set of nodes (`PhysicalRequestFilter` register). The settings in both registers have a direct impact on how the AR DMA Request context is used, e.g. disabling only physical receives from a node will cause all request packets from that node to be routed to the AR DMA Request context. The usage and interrelationship between these registers is fully described in section 5.12, "Asynchronous Request Filters."

12.2 Write Requests: `ack_codes` and host bus errors

For write requests which are handled by the Physical Request controller, the Host Controller may send an `ack_complete` before the data is actually written to system memory. These writes are referred to as *posted writes*. The `ack_code` sent for write requests to offsets in the range of 48'h0001_0000_0000 to 48'hFFFE_FFFF_FFFF when not busied is always `ack_complete`. The `ack_code` sent for offsets in the range 48'hFFFF_0000_0000 to 48'hFFFF_FFFF_FFFF is always `ack_pending`.

Write requests to the physical memory range of the host may be posted if the host controller supports the PostedWriteAddressLo/Hi error registers (see section 12.3) and software has enabled posted writes (see section 5.7). If posting is not enabled/supported, the Host Controller must not return a complete indication (`ack_complete` or `resp_complete`) until the data has been successfully written to system memory to either the addressed location in physical memory or to the AR request buffer.

If posting of physical writes is supported and enabled, then the Host Controller is allowed to return `ack_complete` to a physical write request with certain restrictions.

When the Host Controller posts a write, that write is pending for error reporting purposes until the write is actually complete. While the write is pending the Host Controller must retain the `nodeID` of the request's source and the 48-bit offset address. After the write is completed to either the offset address or to the AR request buffer, that write is no longer pending. If an error occurs in writing the posted data packet, then the Host Controller sets the `IntEvent.PostedWriteErr` bit to indicate that an error has occurred and the write remains pending. Software can then read the source node ID and offset address from `PostedWriteAddressLo` and `PostedWriteAddressHi` and then clear `IntEvent.PostedWriteErr`. When software clears `IntEvent.PostedWriteErr`, that write is no longer pending.

A Host Controller implementation is allowed to support any number of posted writes. However, for each posted write, there must be an error reporting register to hold the source node ID and offset address should that posted write fail.

If the Host Controller has as many pending physical writes as it has reporting registers additional physical writes may not be posted. Instead the Host Controller will need to return `ack_pending` and only return a complete indication when the write is actually done.

Although the Host Controller may allow several pending writes, error reporting is through a single pair of software visible registers. If multiple posted write failures have occurred, software will access them one at a time through the PostedWriteAddress registers. When software clears `IntEvent.PostedWriteErr`, this is a signal to the Host Controller that software has completed reading of the current contents of `PostedWriteAddressLo/Hi` and that the Host Controller can report another error by again setting `IntEvent.PostedWriteErr` and presenting a new set of values when software reads `PostedWriteAddressLo/Hi`.

12.3 PostedWriteAddress registers

When the Host Controller cannot complete the posted write operation due to a host bus error, since the sending node has been notified that the action is complete the system must be notified by the Host Controller so that software can recover. The mechanism for recovering is through the PostedWriteAddress register the `postedWriteErr` bits in the `IntEvent` and `IntMask` registers, and the `postedWriteEnable` bit in the `HCControl` register.

If `IntEvent.postedWriteErr` is set, then these registers contain the 48 bits of the 1394 destination offset of the write request that resulted in a host bus error.

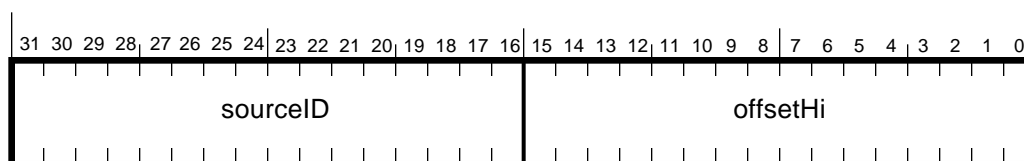

Figure 12-1 — PostedWriteAddressHi register

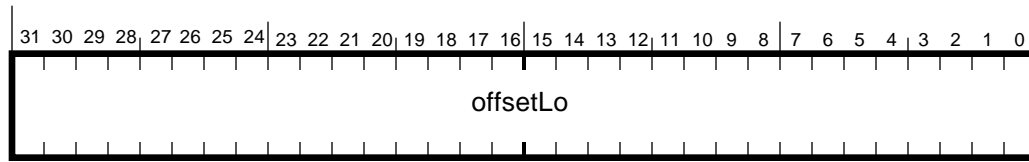

Figure 12-2 — PostedWriteAddressLo register

field name	rwu	reset	description
sourceID	ru	undef	The busNumber and nodeNumber of the node that issued the write request that failed.
offsetHi	ru	undef	The upper 16-bits of the 1394 destination offset of the write request that failed.
offsetLo	ru	undef	The low 32-bits of the 1394 destination offset of the write request that failed.

The PostedWriteAddress register is a 64-bit register which indicates the bus and node numbers (source ID) of the node that issued the write that failed, and the address that node attempted to access. The `IntEvent.PostedWriteErr` bit allows hardware to generate an interrupt when a write fails.

The PostedWriteAddress registers point to a queue in the Host Controller. This queue is accessed by software through the PostedWriteAddress registers. When a posted write fails, its address and node's source ID are placed in this queue, and the interrupt is generated. In addition, that packet is removed from the FIFO. By removing the packet from the FIF, the Host Controller is not blocked from performing future transactions on the 1394 and host busses.

When software reads from these registers, that entry is removed from the queue, the next address and source ID are placed at the head of the queue, and another interrupt is generated. When the queue is empty, the Host Controller stops generating interrupts.

In order to guarantee the accuracy of the Posted Write error registers, software must perform the following algorithm when the posted write error interrupt is encountered:

- 1) Clear the `IntEvent.PostedWriteError` bit.
- 2) Read the `PostedWriteAddressHi` register
- 3) Read the `PostedWriteAddressLo` register

This will guarantee that software receives all information it requires about the first posted write, allowing another interrupt to be generated for future posted writes, and simplifies the Host Controller hardware. The Host Controller does not have to monitor that all three events occur before it moves to the next item in the queue. It may consider the information read once it sees the `PostedWriteAddressLo` register read.

12.3.1 Queue Rules

The Host Controller is only allowed to post as many writes as its posted write error queue is deep. For example, if the Host Controller has a queue depth of two, it shall only return “ack_complete” on two physical writes. All other physical writes must return either “ack_pending” or “ack_busy” event codes. Only when a previous posted write is successfully transferred into host memory, or when a posted write that resulted in an error is removed from the queue through the method described above by software, is the Host Controller allowed to accept more posted writes.

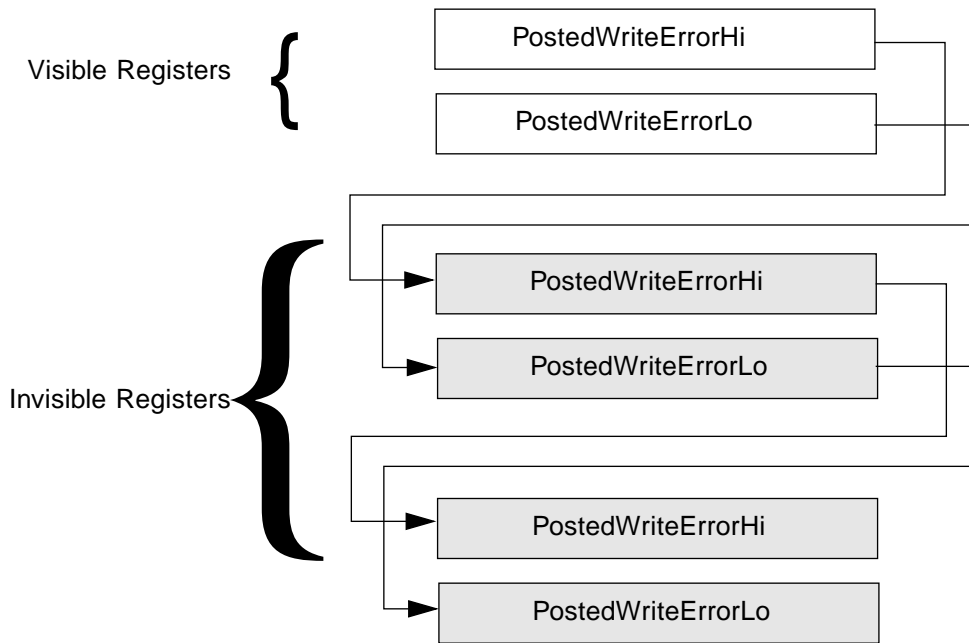

Figure 12-3 — Posted Write Error Queue

An example queue is shown in Figure 12-3. In this case, the queue is three entries deep, so this particular Host Controller can accept three posted writes.

Note that the Host Controller is not required to implement the posted write functionality at all. Software may enable posted writes, but the Host Controller will never accept posted writes. It will therefore never report a posted write error, and does not need to implement this queue.

However, posted writes represent a performance gain to the overall 1394 system. By accepting posted writes, the Host Controller and 1394 nodes are able to transfer data without excessive overhead on the 1394 bus. The 1394 Open HCI does not mandate that a certain level of posting be required, allowing individual hardware implementations to determine the posting depth based upon system needs.

12.4 Interrupt Considerations for Physical Requests

Physical read request handling does not cause an interrupt to be generated under any circumstances. Physical write requests will generate an interrupt when posted write processing yields an error.

Rewrite. no int on phys read reqs. int on phys writes if posting error.

12.5 Physical Responses

There is a separate nibble-wide MaxPhysRespRetries field in the ATRetries Register (see section 5.4) that tells the Physical Response Unit how many times to attempt to retry the transmit operation for the response packet when a “busy” acknowledge is received from the target node (see ATRetries Register on page 28).

12.6 Response to Bus Reset

On a bus reset, all pending physical requests will be discarded.

13. Host Bus Errors

OpenHCI has three primary goals when dealing with host bus error conditions:

- 1) continue transmission and/or reception on all contexts not involved in the error;
- 2) provide information to software which is sufficient to allow recovery from the error when possible;
- 3) provide a means of error recovery on a context other than a general chip reset.

13.1 Causes of Host Bus Errors

Host bus errors can generally be classified as one of the following:

- 1) addressing error (e.g., non-existent memory location)
- 2) operation error (e.g., attempt to write to read-only memory)
- 3) data transfer error (e.g., parity or unrecoverable ECC) and
- 4) time out (e.g., reply on split transaction bus was not received in time).

Each of these errors can occur at three identifiable stages in the processing of a descriptor:

- 1) descriptor fetch,
- 2) data transfer (read or write), and
- 3) an optional descriptor status update.

In general, the nature of the bus error is not as significant as the stage of descriptor processing in which it occurs. For example, the difference between an addressing error and a data parity error is not significant to the error processing.

13.2 Host Controller Actions When Host Bus Error Occurs

When a host bus error occurs, the Host Controller performs a defined set of actions for all context types. Additionally, there are a set of actions that are performed that are dependent on the context type. The following sections outline these actions.

13.2.1 Descriptor Read Error

When an error occurs during the reading of a descriptor or descriptor block, the behavior of the Host Controller is the same regardless of the context type. The Host Controller will set `ContextControl.dead` and `ContextControl.ack` will be set to `evt_descriptor_read` to indicate that the descriptor fetch failed. Additionally, `CommandPtr` will be set to point to a descriptor within the descriptor block in which the error occurred. `Descriptor xferStatus` and `resCount` are not updated.

13.2.2 xferStatus Write Error

For any type of context, when the Host Controller encounters an error writing the status to a descriptor, it sets `ContextControl.dead`. The values that would have been written to `xferStatus` of a descriptor are retained in `ContextControl` for inspection by system software. The unrecoverable error `IntEvent` is generated and the context's `IntEvent` is not set regardless of the setting of the interrupt (I) field in the descriptor.

13.2.3 Transmit Data Read Error

For asynchronous request transmit, asynchronous response transmit and isochronous transmit the Host Controller handles system data read errors in a similar manner. The Host Controller will not stop processing for the context. Instead, the ack code in the status of the `OUTPUT_LAST_*` descriptor is optionally set to indicate that there was an error and the nature

of the error. The indicated errors are `evt_data_read` or `evt_underrun`. If the error occurs before a packet's header is placed in the output FIFO, the Host Controller can immediately abort the packet transfer, optionally set the descriptor status to `evt_data_read` or `evt_underrun` and move on to the next descriptor block. If, however, the error occurs after the header has been placed in the output FIFO, the Host Controller will stop placing data in the output FIFO. This will cause the Host Controller to send a packet with a length that does not agree with the `data_length` field of the header. If the Host Controller receives an `ack_data_error` from the addressed node, then the Host Controller will substitute `evt_data_read` or `evt_underrun` as appropriate. If the device returns anything other than `ack_data_error`, then the Host Controller will store that value in the status for the packet. It should be noted that this means that if the addressed node returns an `ack_pending` on a block write, the error indication will be lost.

If the packet was a broadcast write or an isochronous packet, no ack code is received from any node. In this case, the Host Controller assumes that `ack_data_error` was received and proceeds as outlined above.

13.2.4 Isochronous Transmit Data Write Error

A data write error can occur when the Host Controller attempts to write to the address indicated in a `STORE_VALUE` descriptor. This error is handled like a data read error with the exception that the ack code is set to `evt_data_write`. The Host Controller may not begin placing the packet associated with a `STORE_VALUE` into the output FIFO until the `STORE_VALUE` operation is complete. This is to prevent the possibility of having multiple errors that cannot be properly reported to system software.

13.2.5 Asynchronous Receive Data Write Error

When host bus error occurs while the Host Controller is attempting to write to either the request or response buffer, the Host Controller will set the corresponding `ContextControl.dead` and set `ContextControl.ack` to `evt_data_write`. `CommandPtr.descriptorAddress` will point to the descriptor that contained the buffer descriptor for the memory address at which the error occurred. Any data in the input FIFO for the context is discarded.

13.2.6 Isochronous Receive Data Write Error

If a data write error occurs for a context that is in packet per buffer mode, the Host Controller will set `ContextControl.ack` to `evt_data_write` or `evt_overnrun` and conditionally update `xferStatus` of the descriptor in which the error occurred. Any remaining data in the input FIFO for the packet is discarded. The `resCount` value in a descriptor that has an error will not necessarily reflect the correct number of data bytes successfully written to memory. If a FIFO overrun occurs for a context that is in buffer-fill mode, the packet is treated as if a data length error had occurred and is 'backed out' of the receive buffer (`xferStatus` and `resCount` not updated) and the remainder of the packet is discarded from the input FIFO. If a host bus error occurs for a context in buffer-fill mode the Host Controller will set `ContextControl.dead` and set `ContextControl.ack` to `evt_data_write`. `CommandPtr.descriptorAddress` will point to the descriptor that contained the buffer descriptor for the memory address at which the error occurred. Any data in the input FIFO for the context is discarded.

13.2.7 Physical Read Error

When an external node does a physical access and the Host Controller's read of system memory fails on the first read, the Host Controller will return an error response to the requester with a response code of `resp_data_error`. If an error occurs after a portion of packet has been returned, the Host Controller will simply stop transmitting the packet. This should create a `data_length` mismatch at the requester. If the device replies with `ack_busy` or `ack_data_error` the host should retry the packet. If the error was caused by a FIFO underrun, the Host Controller will retry with the same response. If, however, the error was a host bus error, the response packet will be changed to `resp_data_error`.

13.2.8 Write Request Error

The behavior for handling host bus errors for a write request is fully described in section 12.2, "Write Requests: ack_codes and host bus errors."

Annex A. P1394A enhancements required for 1394 Open HCI

For the PHY:

- a) Add a “disable” bit to the port status registers. If this bit is set, the port will not source bias current on TP² and will not pay attention to the status of either TPA or TPB. This function is needed to allow Open HCI systems to run only on internal nodes.
- b) During the self-ID process, the maximum Phy_ID will reach 63 and will remain at that number for all additional PHYs.
- c) A PHY with the phy_ID of 63 will ignore link-on or phy configuration requests.
- d) Connection hysteresis.
- e) Arbitrated short reset.

For the link:

- a) A link with the phy_ID of 63 will not transmit any packets.
- b) If the LK_EVENT.ind(CYCLE_TOO_LONG) signal is raised, the sending of cycle starts must be disabled.

For the bus manager:

- c) Bus manager algorithms must support 3-bit speed codes.

Figure B-2 — Pointers to OHCI Resources in PCI Configuration Space

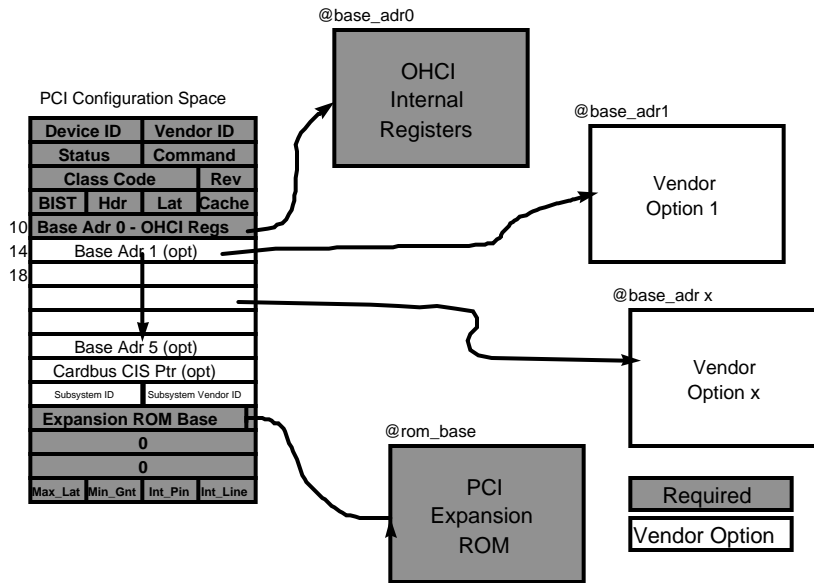

B.3.1 COMMAND Register

This register provides coarse control over the device’s ability to generate and respond to PCI cycles. For the 1394 OpenHCI it is required that the Host Controller support both PCI bus-mastering and memory-mapping of all operational registers into the memory address space of the PC host. Consequently, the fields **MA** and **BM** should always be set to 1’b1 during device configuration.

Once the Host Controller starts processing DMA descriptor lists, the action of resetting either field **MA** or **BM** to 1’b0 will halt all PCI operations from the 1394 OHC. (Do this carefully). If the field **MA** is reset to 1’b0, the Host Controller can no longer respond to any software command addressed to it and interrupt generation is halted.

Table B-1 — COMMAND Register

Field	Bits	Read/Write	Description
	0	rw	Refer to PCI Local Bus Specification, Revision 2.1, for definition
Memory Space	1	rw	MEMORY SPACE Set to 1’b1 so that the OpenHCI controller can respond to PCI memory cycles
BusMaster	2	rw	BUS MASTER Set to 1’b1 so that the OpenHCI controller can act as a bus-master
	3-5	rw	Refer to PCI Specification, Revision 2.1, for definition
Parity Error Response	6	rw	Parity Error Response Set to 1’b1 if error detection on the PCI bus is desired.
	7	rw	Refer to PCI Specification, Revision 2.1, for definition

B.3.2 CLASS_CODE Register

This register identifies the basic function of the device, and a specific programming interface code for an 1394 OpenHCI-compliant Host Controller.

Table B-2 — CLASS_CODE Register

Field	Bits	Read/Write	Description
PI	7-0	r	PROGRAMMING INTERFACE A constant value of 8'h10 Identifies the device being a 1394 OpenHCI Host Controller.
SC	15-8	r	SUB CLASS A constant value of 8'h00 Identifies the device being of IEEE 1394.
BC	23-16	r	BASE CLASS A constant value of 8'h0C Identifies the device being a serial bus controller.

B.3.3 Revision_ID Register

The Revision ID must contain the vendor's revision level of their OpenHCI silicon. It is required that each new revision of silicon receive a new revision ID.

B.3.4 Base_Adr_0 Register

The Base_Adr_0 register specifies the base address of a contiguous memory space in the PCI memory space of the host. This memory space is assigned to the operational registers defined in this specification. All of the operational registers described in this document are directly mapped into this 2 kilobyte memory space. Vendor unique registers are not allowed within this 2 KB memory space.

Those hardware registers that are used to implement vendor specific features are not covered by this 1394 OpenHCI Specification. Additional vendor unique address spaces may be allocated by adding additional base address registers beginning at offset h14 in PCI configuration space.

Table B-3 — Base_Adr_0 Register

Field	Bits	Read/Write	Description
IND	0	r	MEMORY SPACE INDICATOR A constant value of 1'b0 Indicates that the operational registers of the device are mapped into memory space of the main memory of the PC host system
TP	2-1	r	This bit must be programmed consistent with the <i>PCI Local Bus Specification, Revision 2.1</i>
PM	3	r	PREFETCH MEMORY A constant value of 1'b0 Indicates that there is no support for "prefetchable memory"
	11-4	rw	Default value of 8'h00 and is read only Represents a maximum of 4-KB addressing space for the OpenHCI's operational registers
OHCI_REG_PTR	31-12	rw	OHCI Register Pointer Specifies the upper 20 bits of the 32-bit starting base address. This represents a maximum of 2-KB addressing space for the OpenHCI's operational registers.

B.4 PCI_HCI_Control Register

This register has 1394 OpenHCI specific control bits. Vendor options are not allowed in this register. It is reserved for OpenHCI use only.

Table B-4 — PCI_HCI_Control Register

Field	Bits	Read/Write	Description
PCI_Global_Swap	0	rw	<p>PCI Global Swap Bit</p> <p>When this bit is b1, all quadlets read from and written to the PCI interface are byte swapped. PCI addresses, such as expansion ROM and PCI config registers, are unaffected by this bit (they are not byte swapped under any circumstances). The hardware reset value of this bit is b0.</p> <p>This bit is not required for motherboard implementations.</p>
	31-1	rw	These are reserved bits. They must be written as zeros and read as zeros.

B.5 PCI Expansion ROM for 1394 OpenHCI

1394 OHCs on add-in adapters will clearly require PCI expansion ROMs that provide BIOS, Open Firmware, etc. to boot and configure the card. If this ROM is non-writeable and soldered to the card (not socketed), it is also permitted that the serial ROM image that the OHC autoloads at boot up can be included in this expansion ROM (saving the cost of a serial ROM). If this is done, the serial ROM image must be loaded into the 1394 OHC by hardware state machine without software intervention or control. It cannot be modifiable by software or 1394 devices under any circumstances.

B.6 PCI Bus Errors

When the “Parity Error Response” bit in the Command Register in PCI Configuration Space is enabled (see section B.3.1), the PCI interface logic in the OpenHCI must assert PERR# when data with bad parity is received by the 1394 OpenHCI controller.

Any PCI bus error encountered must be reported to the OpenHCI operational logic for error handling. The nature of the error response is context dependent and discussed in the body of the document. No distinction is made between the various PCI bus errors. Basically, only one all encompassing error signal is provided to the operational logic by the PCI specific interface logic. It is the responsibility of the implementer to insure that PCI bus errors are reported in a timely fashion, consistent with their overall OpenHCI implementation, that insures that the errors are associated with the engine, context, etc. that the error should be posted to.

When the “Parity Error Response” bit in the Command Register in PCI Configuration Space is enabled (see section B.3.1), the PCI interface logic in the OpenHCI must assert PERR# in accordance with the *PCI Local Bus Specification, Revision 2.1* when data with bad parity is received by the 1394 OpenHCI controller.